

THE  
ENCYCLOPÆDIA BRITANNICA

ELEVENTH EDITION

FIRST	edition, published in three	volumes,	1768—1771.
SECOND	” ” ten	”	1777—1784.
THIRD	” ” eighteen	”	1788—1797.
FOURTH	” ” twenty	”	1801—1810.
FIFTH	” ” twenty	”	1815—1817.
SIXTH	” ” twenty	”	1823—1824.
SEVENTH	” ” twenty-one	”	1830—1842.
EIGHTH	” ” twenty-two	”	1853—1860.
NINTH	” ” twenty-five	”	1875—1889.
TENTH	” ninth edition and eleven supplementary volumes,		1902—1903.
ELEVENTH	” published in twenty-nine volumes,		1910—1911.

**COPYRIGHT**  
in all countries subscribing to the  
**Bern Convention**  
by  
**THE CHANCELLOR, MASTERS AND SCHOLARS**  
of the  
**UNIVERSITY OF CAMBRIDGE**

*All rights reserved*

THE  
ENCYCLOPÆDIA BRITANNICA

A  
DICTIONARY  
OF  
ARTS, SCIENCES, LITERATURE AND GENERAL  
INFORMATION

ELEVENTH EDITION

VOLUME XIV  
HUSBAND to ITALIC

New York  
Encyclopædia Britannica, Inc.  
342 Madison Avenue

**Copyright, in the United States of America, 1911,**  
**by**  
**The Encyclopædia Britannica Company.**

INITIALS USED IN VOLUME XIV. TO IDENTIFY INDIVIDUAL CONTRIBUTORS,<sup>1</sup> WITH THE HEADINGS OF THE ARTICLES IN THIS VOLUME SO SIGNED.

<b>A. Ba.</b>	ADOLFO BARTOLI (1833-1804). Formerly Professor of Literature at the Istituto di studi superiori at Florence. Author of <i>Storia della letteratura Italiana</i> ; &c.	{ Italian Literature ( <i>in part</i> ).
<b>A. Bo.*</b>	AUGUSTE BOUDINON, D.D., D.C.L. Professor of Canon Law at the Catholic University of Paris. Honorary Canon of Paris. Editor of the <i>Canoniste contemporain</i> .	{ Index Librorum Prohibitorum; Infallibility.
<b>A. Cy.</b>	ARTHUR ERNEST COWLEY, M.A., Litt.D. Sub-Librarian of the Bodleian Library, Oxford. Fellow of Magdalen College.	{ Ibn Gabirol; Inscriptions: Semitic.
<b>A. C. G.</b>	ALBERT CHARLES LEWIS GOTTHILF GÜNTHER, M.A., M.D., Ph.D., F.R.S. Keeper of Zoological Department, British Museum, 1875-1895. Gold Medallist, Royal Society, 1878. Author of <i>Catalogues of Colubrine Snakes, Batrachia Salsientia, and Fishes in the British Museum; Reptiles of British India; Fishes of Zanzibar; Reports on the "Challenger" Fishes</i> ; &c.	{ Ichthyology ( <i>in part</i> ).
<b>A. E. G.*</b>	REV. ALFRED ERNEST GARVIE, M.A., D.D. Principal of New College, Hampstead. Member of the Board of Theology and the Board of Philosophy, London University. Author of <i>Studies in the inner Life of Jesus</i> ; &c.	{ Immortality; Inspiration.
<b>A. E. H. L.</b>	AUGUSTUS EDWARD HOUGH LOVE, M.A., D.Sc., F.R.S. Sedleian Professor of Natural Philosophy in the University of Oxford. Hon. Fellow of Queen's College, Oxford; formerly Fellow of St John's College, Cambridge. Secretary to the London Mathematical Society.	{ Infinitesimal Calculus.
<b>A. F. C.</b>	ALEXANDER FRANCIS CHAMBERLAIN, A.M., Ph.D. Assistant Professor of Anthropology, Clark University, Worcester, Massachusetts. Member of American Antiquarian Society; Hon. Member of American Folk-lore Society. Author of <i>The Child and Childhood in Folk Thought</i> .	{ Indians, North American.
<b>A. G.</b>	MAJOR ARTHUR GEORGE FREDERICK GRIFFITHS (d. 1908). H.M. Inspector of Prisons, 1878-1896. Author of <i>The Chronicles of Newgate; Secrets of the Prison House</i> ; &c.	{ Identification.
<b>A. Ge.</b>	SIR ARCHIBALD GEIKIE, LL.D. See the biographical article, GEIKIE, SIR A.	{ Hutton, James.
<b>A. Go.*</b>	REV. ALEXANDER GORDON, M.A. Lecturer on Church History in the University of Manchester.	{ Illuminati.
<b>A. G. G.</b>	SIR ALFRED GEORGE GREENHILL, M.A., F.R.S. Formerly Professor of Mathematics in the Ordnance College, Woolwich. Author of <i>Differential and Integral Calculus with Applications; Hydrostatics; Notes on Dynamics</i> ; &c.	{ Hydromechanics.
<b>A. H.-S.</b>	SIR A. HOUTUM-SCHINDLER, C.I.E. General in the Persian Army. Author of <i>Eastern Persian Irak</i> .	{ Isfahān ( <i>in part</i> ).
<b>A. M. C.</b>	AGNES MARY CLERKE. See the biographical article, CLERKE, A. M.	{ Huygens, Christiaan.
<b>A. N.</b>	ALFRED NEWTON, F.R.S. See the biographical article, NEWTON, ALFRED.	{ Ibis; Icterus.
<b>A. So.</b>	ALBRECHT SOCIN, Ph.D. (1844-1890). Formerly Professor of Semitic Philology in the Universities of Leipzig and Tübingen. Author of <i>Arabische Grammatik</i> ; &c.	{ Irak-Arabi ( <i>in part</i> ).
<b>A. S. Wo.</b>	ARTHUR SMITH WOODWARD, LL.D., F.R.S. Keeper of Geology, Natural History Museum, South Kensington. Secretary of the Geological Society, London.	{ Ichthyosaurus; Iguanodon.
<b>A. W. H.*</b>	ARTHUR WILLIAM HOLLAND. Formerly Scholar of St John's College, Oxford. Bacon Scholar of Gray's Inn, 1900.	{ Imperial Cities; Instrument of Government
<b>A. W. Po.</b>	ALFRED WILLIAM POLLARD, M.A. Assistant Keeper of Printed Books, British Museum. Fellow of King's College, London. Hon. Secretary Bibliographical Society. Editor of <i>Books about Books and Bibliographica</i> . Joint-editor of <i>The Library</i> . Chief Editor of the "Globe" <i>Chaucer</i> .	{ Incunabula.
<b>A. W. R.</b>	ALEXANDER WOOD RENTON, M.A., LL.B. Puisne Judge of the Supreme Court of Ceylon. Editor of <i>Encyclopaedia of the Laws of England</i> .	{ Inebriety, Law of; Insanity: Law.

<sup>1</sup> A complete list, showing all individual contributors, appears in the final volume.

## INITIALS AND HEADINGS OF ARTICLES

- |                    |   |  |
|--------------------|---|--|
| <b>C. F. A.</b>    | <b>CHARLES FRANCIS ATKINSON.</b><br>Formerly Scholar of Queen's College, Oxford. Captain, 1st City of London (Royal Fusiliers). Author of <i>The Wilderness and Cold Harbour</i> .  | {<br>Infantry;<br>Italian Wars.                |
| <b>C. G.</b>       | <b>COLONEL CHARLES GRANT.</b><br>Formerly Inspector of Military Education in India.   | {<br>India: Costume.                           |
| <b>C. H. Ha.</b>   | <b>CARLTON HUNTLEY HAYES, A.M., PH.D.</b><br>Assistant Professor of History at Columbia University, New York City. Member of the American Historical Association.   | {<br>Innocent V., VIII.                        |
| <b>C. LI. M.</b>   | <b>CONWAY LLOYD MORGAN, LL.D., F.R.S.</b><br>Professor of Psychology at the University of Bristol. Principal of University College, Bristol, 1887-1909. Author of <i>Animal Life and Intelligence; Habit and Instinct</i> .   | {<br>Instinct;<br>Intelligence in Animals.     |
| <b>C. R. B.</b>    | <b>CHARLES RAYMOND BEAZLEY, M.A., D.LITT., F.R.G.S., F.R.HIST.S.</b><br>Professor of Modern History in the University of Birmingham. Formerly Fellow of Merton College, Oxford; and University Lecturer in the History of Geography, Lothian Prizeman, Oxford, 1889. Lowell Lecturer, Boston, 1908. Author of <i>Henry the Navigator; The Dawn of Modern Geography; &amp;c.</i> | {<br>Ibn Batuta ( <i>in part</i> );<br>Idrisi. |
| <b>C. S.*</b>      | <b>CARLO SALVIONI.</b><br>Professor of Classical and Romance Languages, University of Milan.  | {<br>Italian Language ( <i>in part</i> ).      |
| <b>C. T. L.</b>    | <b>CHARLTON THOMAS LEWIS, PH.D. (1834-1904).</b><br>Formerly Lecturer on Life Insurance, Harvard and Columbia Universities, and on Principles of Insurance, Cornell University. Author of <i>History of Germany; Essays; Addresses; &amp;c.</i>   | {<br>Insurance ( <i>in part</i> ).             |
| <b>C. We.</b>      | <b>CECIL WEATHERLY.</b><br>Formerly Scholar of Queen's College, Oxford. Barrister-at-Law, Inner Temple.   | {<br>Infant Schools.                           |
| <b>D. B. Ma.</b>   | <b>DUNCAN BLACK MACDONALD, M.A., D.D.</b><br>Professor of Semitic Languages, Hartford Theological Seminary, U.S.A. Author of <i>Development of Muslim Theology, Jurisprudence and Constitutional Theory; Selection from Ibn Khaldun; Religious Attitude and Life in Islam; &amp;c.</i>  | {<br>Imām.                                     |
| <b>D. G. H.</b>    | <b>DAVID GEORGE HOGARTH, M.A.</b><br>Keeper of the Ashmolean Museum, Oxford. Fellow of Magdalen College, Oxford. Fellow of the British Academy. Excavated at Paphos, 1888; Naucratis, 1899 and 1903; Ephesus, 1904-1905; Assiut, 1906-1907; Director, British School at Athens, 1897-1909; Director, Cretan Exploration Fund, 1899.   | {<br>Ionia ( <i>in part</i> );<br>Isauria.     |
| <b>D. H.</b>       | <b>DAVID HANNAY.</b><br>Formerly British Vice-Consul at Barcelona. Author of <i>Short History of Royal Navy, 1217-1688; Life of Emilio Castelar; &amp;c.</i>  | {<br>Impressment.                              |
| <b>D. F. T.</b>    | <b>DONALD FRANCIS TOVEY.</b><br>Author of <i>Essays in Musical Analysis; comprising The Classical Concerto, The Goldberg Variations, and analyses of many other classical works.</i>  | {<br>Instrumentation.                          |
| <b>D. S. M.</b>    | <b>DUGALD SUTHERLAND MACCOLL, M.A., LL.D.</b><br>Keeper of the National Gallery of British Art (Tate Gallery). Lecturer on the History of Art, University College, London; Fellow of University College, London. Author of <i>Nineteenth Century Art; &amp;c.</i>   | {<br>Impressionism.                            |
| <b>E. A. M.</b>    | <b>EDWARD ALFRED MINCHIN, M.A., F.Z.S.</b><br>Professor of Protozoology in the University of London. Formerly Fellow of Merton College, Oxford; and Lecturer on Comparative Anatomy in the University of Oxford. Author of "Sponges and Sporozoa" in Lankester's <i>Treatise on Zoology; &amp;c.</i>  | {<br>Hydromedusae;<br>Hydrozoa.                |
| <b>E. Br.</b>      | <b>ERNEST BARKEE, M.A.</b><br>Fellow and Lecturer in Modern History, St John's College, Oxford. Formerly Fellow and Tutor of Merton College. Craven Scholar, 1895.  | {<br>Imperial Chamber.                         |
| <b>E. Bra.</b>     | <b>EDWIN BRAMWELL, M.B., F.R.C.P., F.R.S. (Edin.).</b><br>Assistant Physician, Royal Infirmary, Edinburgh.  | {<br>Hysteria ( <i>in part</i> ).              |
| <b>E. C. B.</b>    | <b>RIGHT REV. EDWARD CUTHBERT BUTLER, O.S.B., D.LITT.</b><br>Abbot of Downside Abbey, Bath. Author of "The Lausiac History of Palladius" in <i>Cambridge Texts and Studies.</i>   | {<br>Imitation of Christ.                      |
| <b>E. C. Q.</b>    | <b>EDMUND CROSBY QUIGGIN, M.A.</b><br>Fellow, Lecturer in Modern History, and Monro Lecturer in Celtic, Gonville and Caius College, Cambridge.  | {<br>Ireland: Early History.                   |
| <b>E. F. S.</b>    | <b>EDWARD FAIRBROTHER STRANGE.</b><br>Assistant Keeper, Victoria and Albert Museum, South Kensington. Member of Council, Japan Society. Author of numerous works on art subjects. Joint-editor of Bell's "Cathedral" Series.  | {<br>Illustration: Technical<br>Developments.  |
| <b>E. F. S. D.</b> | <b>LADY DILKE.</b><br>See the biographical article: DILKE, SIR C. W., BART.   | {<br>Ingres.                                   |
| <b>E. G.</b>       | <b>EDMUND GOSSE, LL.D.</b><br>See the biographical article, GOSSE, EDMUND.  | {<br>Huygens, Sir Constantijn;<br>Idyl.        |
| <b>E. Hū.</b>      | <b>EMIL HÜBNER.</b><br>See the biographical article, HÜBNER, EMIL.  | {<br>Inscriptions: Latin ( <i>in part</i> ).   |
| <b>E. H. B.</b>    | <b>SIR EDWARD HERBERT BUNBURY, BART., M.A., F.R.G.S. (d. 1895).</b><br>M.P. for Bury St Edmunds, 1847-1852. Author of a <i>History of Ancient Geography; &amp;c.</i>  | {<br>Ionia ( <i>in part</i> ).                 |
| <b>E. H. M.</b>    | <b>ELLIS HOWELL MINNS, M.A.</b><br>Lecturer and Assistant Librarian, and formerly Fellow, Pembroke College, Cambridge University Lecturer in Palaeography.  | {<br>Iazyges; Issedones.                       |
| <b>E. H. P.</b>    | <b>EDWARD HENRY PALMER, M.A.</b><br>See the biographical article, PALMER, E. H.   | {<br>Ibn Khaldun ( <i>in part</i> ).           |

- E. K.** EDMUND KNECHT, PH.D., M.Sc. TECH. (Manchester), F.I.C.  
Professor of Technological Chemistry, Manchester University. Head of Chemical Department, Municipal School of Technology, Manchester. Examiner in Dyeing, City and Guilds of London Institute. Author of *A Manual of Dyeing*; &c. Editor of *Journal of the Society of Dyers and Colourists*. **Indigo.**
- E. L. H.** THE RIGHT REV. THE BISHOP OF LINCOLN (EDWARD LEE HICKS).  
Honorary Fellow of Corpus Christi College, Oxford. Formerly Canon Residentiary of Manchester. Fellow and Tutor of Corpus Christi College. Author of *Manual of Greek Historical Inscriptions*; &c. **Inscriptions: Greek (in part).**
- Ed. M.** EDUARD MEYER, PH.D., D.LITT. (Oxon.), LL.D.  
Professor of Ancient History in the University of Berlin. Author of *Geschichte des Alterthums; Geschichte des alten Aegyptens; Die Israeliten und ihre Nachbarstämme*. **Hystaspes; Iran.**
- E. M. T.** SIR EDWARD MAUNDE THOMPSON, G.C.B., I.S.O., D.C.L., LITT.D., LL.D.  
Director and Principal Librarian, British Museum, 1898-1909. Sandars Reader in Bibliography, Cambridge, 1895-1896. Hon. Fellow of University College, Oxford. Correspondent of the Institute of France and of the Royal Prussian Academy of Sciences. Author of *Handbook of Greek and Latin Palaeography*. Editor of *Chronicon Angliae*. Joint-editor of publications of the Palaeographical Society, the New Palaeographical Society, and of the Facsimile of the Laurentian Sophocles. **Illuminated MSS.**
- E. O.\*** EDMUND OWEN, M.B., F.R.C.S., LL.D., D.Sc.  
Consulting Surgeon to St Mary's Hospital, London, and to the Children's Hospital, Great Ormond Street; late Examiner in Surgery at the Universities of Cambridge, Durham and London. Author of *A Manual of Anatomy for Senior Students*. **Hydrocephalus.**
- F. A. F.** FRANK ALBERT FETTER, PH.D.  
Professor of Political Economy and Finance, Cornell University. Member of the State Board of Charities. Author of *The Principles of Economics*; &c. **Interstate Commerce.**
- F. C. C.** FREDERICK CORNWALLIS CONYBEARE, M.A., D.Th. (Giessen).  
Fellow of the British Academy. Formerly Fellow of University College, Oxford. Author of *The Ancient Armenian Texts of Aristotle; Myth, Magic and Morals*; &c. **Iconoclasts; Image Worship.**
- F. G. M. B.** FREDERICK GEORGE MEESON BECK, M.A.  
Fellow and Lecturer in Classics, Clare College, Cambridge. **Twice.**
- F. J. H.** FRANCIS JOHN HAVERFIELD, M.A., LL.D., F.S.A.  
Chadren Professor of Ancient History in the University of Oxford. Fellow of Brasenose College. Fellow of the British Academy. Formerly Censor, Student, Tutor and Librarian of Christ Church, Oxford. Ford's Lecturer, 1906-1907. Author of Monographs on Roman History, especially Roman Britain; &c. **Icknield Street.**
- F. Ll. G.** FRANCIS LLEWELLYN GRIFFITH, M.A., PH.D., F.S.A.  
Reader in Egyptology, Oxford University. Editor of the Archaeological Survey and Archaeological Reports of the Egypt Exploration Fund. Fellow of Imperial German Archaeological Institute. **Hyksos; Isis.**
- F. P.\*** FREDERICK PETERSON, M.D., PH.D.  
Professor of Psychiatry, Columbia University. President of New York State Commission in Lunacy, 1902-1906. Author of *Mental Diseases*; &c. **Insanity: Hospital Treatment.**
- F. S. P.** FRANCIS SAMUEL PHILBRICK, A.M., Ph.D.  
Formerly Fellow of Nebraska State University, and Scholar and Resident Fellow of Harvard University. Member of American Historical Association. **Independence, Declaration of.**
- F. Wa.** FRANCIS WATT, M.A.  
Barrister-at-Law, Middle Temple. Author of *Law's Lumber Room*. **Inn and Innkeeper.**
- F. W. R.\*** FREDERICK WILLIAM RUDLER, I.S.O., F.G.S.  
Curator and Librarian of the Museum of Practical Geology, London, 1879-1902. President of the Geologists' Association, 1887-1889. **Hyacinth; Iolite.**
- F. Y. P.** FREDERICK YORK POWELL, D.C.L., LL.D.  
See the biographical article, POWELL, FREDERICK YORK. **Iceiland: History, and Ancient Literature.**
- G. A. B.** GEORGE A. BOULENGER, F.R.S., D.Sc., Ph.D.  
In charge of the collections of Reptiles and Fishes, Department of Zoology, British Museum. Vice-President of the Zoological Society of London. **Ichthyology (in part).**
- G. A. Gr.** GEORGE ABRAHAM GRIERSON, C.I.E., Ph.D., D.LITT. (Dublin).  
Member of the Indian Civil Service, 1873-1903. In charge of Linguistic Survey of India, 1898-1902. Gold Medalist, Royal Asiatic Society, 1909. Vice-President of the Royal Asiatic Society. Formerly Fellow of Calcutta University. Author of *The Languages of India*; &c. **Indo-Aryan Languages.**
- G. A. J. C.** GRENVILLE ARTHUR JAMES COLE.  
Director of the Geological Survey of Ireland. Professor of Geology, Royal College of Science for Ireland, Dublin. Author of *Aids in Practical Geology*; &c. **Ireland: Geology.**
- G. B.** SIR GEORGE CHRISTOPHER MOLESWORTH BIRDWOOD, K.C.I.E.  
See the biographical article, BIRDWOOD, SIR G. C. M. **Incense.**
- G. F. H.\*** GEORGE FRANCIS HILL, M.A.  
Assistant in Department of Coins and Medals, British Museum. Author of *Sources for Greek History 478-431 B.C.*; *Handbook of Greek and Roman Coins*; &c. **Inscriptions: Greek (in part).**
- G. G. Co.** GEORGE GORDON COULTON, M.A.  
Birkbeck Lecturer in Ecclesiastical History, Trinity College, Cambridge. Author of *Medieval Studies; Chaucer and his England*; &c. **Indulgence.**
- G. H. C.** GEORGE HERBERT CARPENTER, B.Sc. (Lond.).  
Professor of Zoology in the Royal College of Science, Dublin. Author of *Insects: their Structure and Life*. **Hymenoptera; Ichneumon-Fly; Insect.**

- G. I. A.** GRAZIANO I. ASCOLI. Senator of the Kingdom of Italy. Professor of Comparative Grammar at the University of Milan. Author of *Codice Islandese*; &c. } Italian Language (*in part*).
- G. J.** GEORGE JAMIESON, C.M.G., M.A. Formerly Consul-General at Shanghai, and Consul and Judge of the Supreme Court, Shanghai. } Hwang Ho.
- G. K.** GUSTAV KRÜGER, PH.D. Professor of Church History in the University of Giessen. Author of *Das Papstthum*; &c. } Irenaeus.
- G. P. M.** GEORGE PERCIAV MUDGE, A.R.C.S., F.Z.S. Lecturer on Biology, London Hospital Medical College, and London School of Medicine for Women, University of London. Author of *A Text Book of Zoology*; &c. } Incubation and Incubators.
- G. W. K.** VERY REV. GEORGE WILLIAM KITCHIN, M.A., D.D., F.S.A. Dean of Durham, and Warden of the University of Durham. Hon. Student of Christ Church, Oxford. Fellow of King's College, London. Dean of Winchester, 1883-1894. Author of *A History of France*; &c. } Hutten, Ulrich von.
- G. W. T.** REV. GRIFFITHS WHEELER THATCHER, M.A., B.D. Warden of Camden College, Sydney, N.S.W. Formerly Tutor in Hebrew and Old Testament History at Mansfield College, Oxford. Author of a *Commentary on Judges*; *An Arabic Grammar*; &c. } Ibn 'Abd Rabbih;  
Ibn 'Arabi; Ibn Athir;  
Ibn Duraid; Ibn Faradī;  
Ibn Fārid; Ibn Hazm;  
Ibn Hisham; Ibn Ishāq;  
Ibn Jubair; Ibn Khaldūn  
(*in part*);  
Ibn Khallikān;  
Ibn Qutalba; Ibn Ṣa'd;  
Ibn Ṭufail; Ibn Usaib'ia;  
Ibrahīm Al-Mausūfī.
- H. Ch.** HUGH CHISHOLM, M.A. Formerly Scholar of Corpus Christi College, Oxford. Editor the 11th edition of the *Encyclopaedia Britannica*; Co-editor of the 10th edition. } Iron Mask; Ismail.
- H. C. R.** SIR HENRY CRESWICKE RAWLINSON, BART., K.C.B. See the biographical article, RAWLINSON, SIR HENRY CRESWICKE. } Isfahan: *History*.
- H. L. H.** HARRIET L. HENNESSY, M.D., (Brux.) L.R.C.P.I., L.R.C.S.I. } Infancy;  
Intestinal Obstruction.
- H. M. H.** HENRY MARION HOWE, A.M., LL.D. Professor of Metallurgy, Columbia University. Author of *Metallurgy of Steel*; &c. } Iron and Steel.
- H. N. D.** HENRY NEWTON DICKSON, M.A., D.Sc., F.R.G.S. Professor of Geography, University College, Reading. Author of *Elementary Meteorology*; *Papers on Oceanography*; &c. } Indian Ocean.
- H. O.** HERMANN OELSNER, M.A., PH.D. Taylorian Professor of the Romance Languages in University of Oxford. Member of Council of the Philological Society. Author of *A History of Provençal Literature*; &c. } Italian Literature (*in part*).
- H. St.** HENRY STURT, M.A. Author of *Idola Theatri*; *The Idea of a Free Church*; and *Personal Idealism*. } Induction.
- H. T. A.** REV. HERBERT THOMAS ANDREWS. Professor of New Testament Exegesis, New College, London. Author of the "Commentary on Acts" in the *Westminster New Testament*; *Handbook on the Apocryphal Books* in the "Century Bible." } Ignatius.
- H. Y.** SIR HENRY YULE, K.C.S.I., C.B. See the biographical article, YULE, SIR HENRY. } Ibn Batuta (*in part*).
- I. A.** ISRAEL ABRAHAM, M.A. Reader in Talmudic and Rabbinic Literature in the University of Cambridge. Formerly President, Jewish Historical Society in England. Author of *A Short History of Jewish Literature*; *Jewish Life in the Middle Ages*; &c. } Ibn Tibbon;  
Immanuel Ben Solomon.
- J. A. F.** JOHN AMBROSE FLEMING, M.A., F.R.S., D.Sc. Pender Professor of Electrical Engineering in the University of London. Fellow of University College, London. Formerly Fellow of St John's College, Cambridge, and Lecturer on Applied Mechanics in the University. Author of *Magnets and Electric Currents*. } Induction Coil.
- J. Bs.** JAMES BURGESS, C.I.E., LL.D., F.R.S.(Edin.), F.R.G.S., HON.A.R.I.B.A. Formerly Director General of Archaeological Survey of India. Author of *Archaeological Survey of Western India*. Editor of Fergusson's *History of Indian Architecture*. } Indian Architecture.
- J. B. T.** SIR JOHN BATTY TUKE, KT., M.D., F.R.S.(Edin.), D.Sc., LL.D. President of the Neurological Society of the United Kingdom. Medical Director of New Saughton Hall Asylum, Edinburgh. M.P. for the Universities of Edinburgh and St Andrews, 1900-1910. } Hysteria (*in part*);  
Insanity: *Medical*.
- ✠ **J. C. H.** RIGHT REV. JOHN CUTHBERT HEDLEY, O.S.B., D.D. K.C. Bishop of Newport. Author of *The Holy Eucharist*; &c. } Immaculate Conception.
- J. C. Van D.** JOHN CHARLES VAN DYKE. Professor of the History of Art, Rutgers College, New Brunswick, N.J. Formerly Editor of *The Studio and Art Review*. Author of *Art for Art's Sake*; *History of Painting*; *Old English Masters*; &c. } Inness, George.



<b>J. C. W.</b>	<b>JAMES CLAUDE WEBSTER.</b> Barrister-at-Law, Middle Temple.	Inns of Court.
<b>J. D. B.</b>	<b>JAMES DAVID BOURCHIER, M.A., F.R.G.S.</b> King's College, Cambridge. Correspondent of <i>The Times</i> in South-Eastern Europe. Commander of the Orders of Prince Danilo of Montenegro and of the Saviour of Greece, and Officer of the Order of St Alexander of Bulgaria.	Ionian Islands.
<b>J. F. F.</b>	<b>JOHN FAITHFULL FLEET, C.I.E. PH.D.</b> Commissioner of Central and Southern Divisions of Bombay, 1891-1897. Author of <i>Inscriptions of the Early Gupta Kings</i> ; &c.	Inscriptions: Indian.
<b>J. F.-K.</b>	<b>JAMES FITZMAURICE-KELLY, LITT.D., F.R.HIST.S.</b> Gilmour Professor of Spanish Language and Literature, Liverpool University. Norman McColl Lecturer, Cambridge University. Fellow of the British Academy. Member of the Royal Spanish Academy. Knight Commander of the Order of Alphonso XII. Author of <i>A History of Spanish Literature</i> ; &c.	Isla, J. F. de.
<b>J. G. K.</b>	<b>JOHN GRAHAM KEER, M.A., F.R.S.</b> Regius Professor of Zoology in the University of Glasgow. Formerly Demonstrator in Animal Morphology in the University of Cambridge. Fellow of Christ's College, Cambridge. 1898-1904. Walsingham Medallist, 1898. Neill Prizeman, Royal Society of Edinburgh, 1904.	Ichthyology (in part).
<b>J. G. Sc.</b>	<b>SIR JAMES GEORGE SCOTT, K.C.I.E.</b> Superintendent and Political Officer, Southern Shan States. Author of <i>Burma, a Handbook</i> ; <i>The Upper Burma Gazetteer</i> ; &c.	Irrawaddy.
<b>J. H. A. H.</b>	<b>JOHN HENRY ARTHUR HART, M.A.</b> Fellow, Theological Lecturer and Librarian, St John's College, Cambridge.	Hyrceanus.
<b>J. H. Mu.</b>	<b>JOHN HENRY MUIRHEAD, M.A., LL.D.</b> Professor of Philosophy in the University of Birmingham. Author of <i>Elements of Ethics</i> ; <i>Philosophy and Life</i> ; &c. Editor of <i>Library of Philosophy</i> .	Idealism.
<b>J. H. Be.</b>	<b>VERY REV. JOHN HENRY BERNARD, M.A., D.D., D.C.L.</b> Dean of St Patrick's Cathedral, Dublin. Archbishop King's Professor of Divinity and formerly Fellow of Trinity College, Dublin. Joint-editor of the <i>Irish Liber Hymnorum</i> ; &c.	Ireland, Church of.
<b>J. H. van't H.</b>	<b>JACOBUS HENRICUS VAN'T HOFF, LL.D., D.Sc., D.M.</b> See the biographical article VAN'T HOFF, JACOBUS HENRICUS.	Isomerism.
<b>J. L. M.</b>	<b>JOHN LYNTON MYRES, M.A., F.S.A., F.R.G.S.</b> Wykeham Professor of Ancient History in the University of Oxford. Formerly Gladstone Professor of Greek and Lecturer in Ancient Geography, University of Liverpool. Lecturer in Classical Archaeology in University of Oxford.	Iberians; Ionians.
<b>J. Mn.</b>	<b>JOHN MACPHERSON, M.D.</b> Formerly Inspector-General of Hospitals, Bengal.	Insanity: Medical (in part).
<b>J. M. A. de L.</b>	<b>JEAN MARIE ANTOINE DE LANESSAN.</b> See the biographical article, LANESSAN, J. M. A. de.	Indo-China, French (in part).
<b>J. M. M.</b>	<b>JOHN MALCOLM MITCHELL.</b> Sometime Scholar of Queen's College, Oxford. Lecturer in Classics, East London College (University of London). Joint-editor of Grote's <i>History of Greece</i> .	Hyacinthus.
<b>J. P. E.</b>	<b>JEAN PAUL HIPPOLYTE EMMANUEL ADHÉMAR ESMÉIN.</b> Professor of Law in the University of Paris. Officer of the Legion of Honour. Member of the Institute of France. Author of <i>Cours élémentaire d'histoire du droit français</i> ; &c.	Intendant.
<b>J. P. Pe.</b>	<b>REV. JOHN PUNNETT PETERS, PH.D., D.D.</b> Canon Residentiary, Cathedral of New York. Formerly Professor of Hebrew in the University of Pennsylvania. Director of the University Expedition to Babylonia, 1888-1895. Author of <i>Nippur, or Explorations and Adventures on the Euphrates</i> .	Irak-Arabi (in part).
<b>J. S. Bl.</b>	<b>JOHN SUTHERLAND BLACK, M.A., LL.D.</b> Assistant Editor of the 9th edition of the <i>Encyclopaedia Britannica</i> . Joint-editor of the <i>Encyclopaedia Biblica</i> .	Huss, John.
<b>J. S. Co.</b>	<b>JAMES SUTHERLAND COTTON, M.A.</b> Editor of the <i>Imperial Gazetteer of India</i> . Hon. Secretary of the Egyptian Exploration Fund. Formerly Fellow and Lecturer of Queen's College, Oxford. Author of <i>India</i> ; &c.	India: Geography and Statistics (in part); History (in part); Indore.
<b>J. S. F.</b>	<b>JOHN SMITH FLETT, D.Sc., F.G.S.</b> Petrographer to the Geological Survey. Formerly Lecturer on Petrology in Edinburgh University. Neill Medallist of the Royal Society of Edinburgh. Bigsby Medallist of the Geological Society of London.	Itacolumite.
<b>J. T. Be.</b>	<b>JOHN THOMAS BEALBY.</b> Joint-author of Stanford's <i>Europe</i> . Formerly Editor of the <i>Scottish Geographical Magazine</i> . Translator of Sven Hedin's <i>Through Asia, Central Asia and Tibet</i> ; &c.	Irkutsk (in part).
<b>J. V.*</b>	<b>JULES VIARD.</b> Archivist at the National Archives, Paris. Officer of Public Instruction. Author of <i>La France sous Philippe VI. de Valois</i> ; &c.	Isabella of Bavaria.
<b>Jno. W.</b>	<b>JOHN WESTLAKE, K.C., LL.D.</b> Professor of International Law, Cambridge, 1888-1908. One of the Members for the United Kingdom of International Court of Arbitration under the Hague Convention, 1900-1906. Bencher of Lincoln's Inn. Author of <i>A Treatise on Private International Law, or the Conflict of Laws: Character on the Principles of International Law</i> , pt. i. "Peace," nt. ii. "War."	International Law: Private.

- L. COUNT LÜTZOW, LITT.D. (Oxon.), PH.D. (Prague), F.R.G.S.  
Chamberlain of H.M. the Emperor of Austria, King of Bohemia. Hon. Member of the Royal Society of Literature. Member of the Bohemian Academy; &c. Author of *Bohemia, a Historical Sketch*; *The Historians of Bohemia* (Ilchester Lecture, Oxford, 1904); *The Life and Times of John Hus*; &c. } **Hussites.**
- L. C. B. LEWIS CAMPBELL BRUCE, M.D., F.R.C.P.  
Author of *Studies in Clinical Psychiatry*. } **Insanity: Medical (in part).**
- L. Ho. LAURENCE HOUSMAN.  
See the biographical article, HOUSMAN, L. } **Illustration (in part).**
- L. J. S. LEONARD JAMES SPENCER, M.A.  
Assistant in Department of Mineralogy, British Museum. Formerly Scholar of Sidney Sussex College, Cambridge, and Harkness Scholar. Editor of the *Mineralogical Magazine*. } **Hypersthene; Ilmenite.**
- L. T. D. SIR LEWIS TONNA DIBDIN, M.A., D.C.L., F.S.A.  
Dean of the Arches; Master of the Faculties; and First Church Estates Commissioner. Bencher of Lincoln's Inn. Author of *Monasticism in England*; &c. } **Incense: Ritual Use.**
- M. Ha. MARCUS HARTOG, M.A., D.Sc., F.L.S.  
Professor of Zoology, University College, Cork. Author of "Protozoa" in *Cambridge Natural History*; and papers for various scientific journals. } **Infusoria.**
- M. Ja. MORRIS JASTROW, JUN., PH.D.  
Professor of Semitic Languages, University of Pennsylvania, U.S.A. Author of *Religion of the Babylonians and Assyrians*; &c. } **Ishtar.**
- M. O. B. C. MAXIMILIAN OTTO BISMARCK CASPARI, M.A.  
Reader in Ancient History at London University. Lecturer in Greek at Birmingham University, 1905-1908. } **Irene (752-803).**
- N. M. NORMAN McLEAN, M.A.  
Fellow, Lecturer and Librarian of Christ's College, Cambridge. University Lecturer in Aramaic. Examiner for the Oriental Languages Tripos and the Theological Tripos at Cambridge. } **Isaac of Antioch.**
- O. J. R. H. OSBERT JOHN RADCLIFFE HOWARTH, M.A.  
Christ Church, Oxford. Geographical Scholar, 1901. Assistant Secretary of the British Association. } **Ireland: Geography.**
- P. A. PAUL DANIEL ALPHANDÉRY.  
Professor of the History of Dogma, École pratique des hautes études, Sorbonne, Paris. Author of *Les Idées morales chez les hétérodoxes latins au début du XIII<sup>e</sup> siècle*. } **Inquisition.**
- P. A. K. PRINCE PETER ALEXEIVITCH KROPOTKIN.  
See the biographical article, KROPOTKIN, PRINCE P. A. } **Irkutsk (in part).**
- P. C. M. PETER CHALMERS MITCHELL, M.A., F.R.S., F.Z.S., D.Sc., LL.D.  
Secretary to the Zoological Society of London. University Demonstrator in Comparative Anatomy and Assistant to Linacre Professor at Oxford, 1888-1891. Examiner in Zoology to the University of London, 1903. Author of *Outlines of Biology*; &c. } **Hybridism.**
- P. Gi. PETER GILES, M.A., LL.D., LITT.D.  
Fellow and Classical Lecturer of Emmanuel College, Cambridge, and University Reader in Comparative Philology. Formerly Secretary of the Cambridge Philological Society. Author of *Manual of Comparative Philology*; &c. } **I; Indo-European Languages.**
- P. Sm. PRESERVED SMITH, PH.D.  
Rufus B. Kellogg Fellow, Amherst College, Amherst, Mass. } **Innocent I, II.**
- R. THE RIGHT HON. LORD RAYLEIGH.  
See the biographical article, RAYLEIGH, 3rd BARON. } **Interference of Light.**
- R. A. S. M. ROBERT ALEXANDER STEWART MACALISTER, M.A., F.S.A.  
St John's College, Cambridge. Director of Excavations for the Palestine Exploration Fund. } **Idumaea.**
- R. Ba. RICHARD BAGWELL, M.A., LL.D.  
Commissioner of National Education for Ireland. Author of *Ireland under the Tudors*; *Ireland under the Stuarts*. } **Ireland: Modern History.**
- R. C. J. SIR RICHARD CLAVERHOUSE JEBB, D.C.L., LL.D.  
See the biographical article, JEBB, SIR RICHARD CLAVERHOUSE. } **Isaeus; Isocrates.**
- R. G. RICHARD GARNETT, LL.D.  
See the biographical article, GARNETT, RICHARD. } **Irving, Washington.**
- R. H. C. REV. ROBERT HENRY CHARLES, M.A., D.D., D.LITT.  
Grinfield Lecturer, and Lecturer in Biblical Studies, Oxford. Fellow of the British Academy. Formerly Professor of Biblical Greek, Trinity College, Dublin. Author of *Critical History of the Doctrine of a Future Life*; *Book of Jubilees*; &c. } **Isaiah, Ascension of.**
- R. L.\* RICHARD LVDEKKE, F.R.S., F.Z.S., F.G.S.  
Member of the Staff of the Geological Survey of India 1874-1882. Author of *Catalogues of Fossil Mammals, Reptiles and Birds in the British Museum*; *The Deer of all Lands*; &c. } **Hyracoidae; Ibex (in part); Indri; Insectivora.**
- R. P. S. R. PHENÉ SPIERS, F.S.A., F.R.I.B.A.  
Formerly Master of the Architectural School, Royal Academy, London. Past President of Architectural Association. Associate and Fellow of King's College, London. Corresponding Member of the Institute of France. Editor of *Fergusson's History of Architecture*. Author of *Architecture, East and West*; &c. } **Hypaethros.**

## INITIALS AND HEADINGS OF ARTICLES

xi

- R. S. C.** ROBERT SEYMOUR GONWAY, M.A., D.LITT. (Cantab).  
Professor of Latin and Indo-European Philology in the University of Manchester. Formerly Professor of Latin in University College, Cardiff; and Fellow of Gonville and Caius College, Cambridge. Author of *The Italic Dialects*. { **Iguvium; Iovidaa.**
- S.** THE RIGHT HON. THE EARL OF SELBORNE.  
See the biographical article, SELBORNE, 1st EARL OF. { **Hymns.**
- R. Tr.** ROLAND TRUSLOVE, M.A.  
Formerly Scholar of Christ Church, Oxford. Dean, Fellow and Lecturer in Classics at Worcester College, Oxford. { **Indo-China, French (in part).**
- S. A. C.** STANLEY ARTHUR COOK, M.A.  
Lecturer in Hebrew and Syriac, and formerly Fellow, Gonville and Caius College, Cambridge. Editor for Palestine Exploration Fund. Author of *Glossary of Aramaic Inscriptions; The Laws of Moses and the Code of Hammurabi; Critical Notes on Old Testament History; Religion of Ancient Palestine*; &c. { **Ishmael.**
- S. Bl.** SIGFUS BLÖNDAL.  
Librarian of the University of Copenhagen. { **Iceland: Recent Literature.**
- T. As.** THOMAS ASHBY, M.A., D.LITT. (Oxon.).  
Director of British School of Archaeology at Rome. Formerly Scholar of Christ Church, Oxford. Craven Fellow, 1897. Conington Prizeman, 1906. Member of the Imperial German Archaeological Institute. { **Interamna Lirenas; Ischia**
- T. A. I.** THOMAS ALLAN INGRAM, M.A., LL.D.  
Trinity College, Dublin. { **Illegitimacy; Insurance (in part)**
- T. Ba.** SIR THOMAS BARCLAY, M.P.  
Member of the Institute of International Law. Member of the Supreme Council of the Congo Free State. Officer of the Legion of Honour. Author of *Problems of International Practice and Diplomacy*; &c. M.P. for Blackburn, 1910. { **Immunity. International Law.**
- T. F.** REV. THOMAS FOWLER, M.A., D.D., LL.D. (1832-1904).  
President of Corpus Christi College, Oxford, 1881-1904. Honorary Fellow of Lincoln College. Professor of Logic, 1873-1888. Vice-Chancellor of the University of Oxford, 1899-1901. Author of *Elements of Deductive Logic; Elements of Inductive Logic; Locke* ("English Men of Letters"); *Shaftesbury and Hutcheson* ("English Philosophers"); &c. { **Hutcheson, Francis (in part).**
- T. F. C.** THEODORE FREYLINGHUYSEN COLLIER, PH.D.  
Assistant Professor of History, Williams College, Williamstown, Mass., U.S.A. { **Innocent IX.-XIII.**
- T. H. H.\*** COLONEL SIR THOMAS HUNGERFORD HOLDICH, K.C.M.G., K.C.I.E., Hon.D.Sc.  
Superintendent, Frontier Surveys, India, 1892-1898. Gold Medallist, R.G.S., London, 1887. Author of *The Indian Borderland; The Countries of the King's Award; India; Tibet*; &c. { **Indus.**
- T. K. C.** REV. THOMAS KELLY CHEYNE, D.D.  
See the biographical article, CHEYNE, T. K. { **Isaiah.**
- Th. T.** THORVALDUR THORODDSEN.  
Icelandic Expert and Explorer. Honorary Professor in the University of Copenhagen. Author of *History of Icelandic Geography; Geological Map of Iceland*; &c. { **Iceland: Geography and Statistics.**
- W. A. B. C.** REV. WILLIAM AUGUSTUS BREVOORT COOLIDGE, M.A., F.R.G.S., Ph.D.(Bern).  
Fellow of Magdalen College, Oxford. Professor of English History, St David's College, Lampeter, 1880-1881. Author of *Guide du Haut Dauphiné; The Range of the Todi; Guide to Grindelwald; Guide to Switzerland; The Alps in Nature and in History*; &c. Editor of *The Alpine Journal*, 1880-1881; &c. { **Hyères; Innsbruck; Interlaken; Iseo, Lake of; Isère (River); Isère (Department).**
- W. A. P.** WALTER ALISON PHILLIPS, M.A.  
Formerly Exhibitioner of Merton College and Senior Scholar of St John's College, Oxford. Author of *Modern Europe*; &c. { **Innocent III., IV.**
- W. C. U.** WILLIAM CAWTHORNE UNWIN, LL.D., F.R.S., M.INST.C.E., M.INST.M.E., A.R.I.B.A.  
Emeritus Professor, Central Technical College, City and Guilds of London Institute. Author of *Wrought Iron Bridges and Roofs; Treatise on Hydraulics*; &c. { **Hydraulics.**
- W. F. C.** WILLIAM FEILDEN CRAIES, M.A.  
Barrister-at-Law, Inner Temple. Lecturer on Criminal Law, King's College, London. Editor of Archbold's *Criminal Pleading* (23rd edition). { **Indictment.**
- W. F. Sh.** WILLIAM FLEETWOOD SHEPPARD, M.A.  
Senior Examiner in the Board of Education, London. Formerly Fellow of Trinity College, Cambridge. Senior Wrangler, 1884. { **Interpolation.**
- W. G.** WILLIAM GARNETT, M.A., D.C.L.  
Educational Adviser to the London County Council. Formerly Fellow and Lecturer of St John's College, Cambridge. Principal and Professor of Mathematics, Durham College of Science, Newcastle-on-Tyne. Author of *Elementary Dynamics*; &c. { **Hydrometer.**
- W. Go.** WILLIAM GOW, M.A., Ph.D.  
Secretary of the British and Foreign Marine Insurance Co. Ltd., Liverpool. Lecturer on Marine Insurance at University College, Liverpool. Author of *Marine Insurance*; &c. { **Insurance: Marine.**
- W. H. F.** SIR WILLIAM HENRY FLOWER, F.R.S.  
See the biographical article, FLOWER, SIR W. H. { **Ibex (in part).**
- W. H. Po.** W. HALDANE PORTER.  
Barrister-at-Law, Middle Temple. { **Ireland: Statistics and Administration.**

<b>W. Ma.</b>	SIR WILLIAM MARKBY, K.C.I.E. See the biographical article, MARKBY, SIR WILLIAM.	} Indian Law.
<b>W. McD.</b>	WILLIAM MCDUGALL, M.A. Wilde Reader in Mental Philosophy in the University of Oxford. Formerly Fellow of St John's College, Cambridge.	
<b>W. M. L.</b>	WALLACE MARTIN LINDSAY, M.A., LITT.D., LL.D. Professor of Humanity, University of St Andrews. Fellow of the British Academy. Formerly Fellow of Jesus College, Oxford. Author of <i>Handbook of Latin Inscriptions</i> ; <i>The Latin Language</i> ; &c.	} Inscriptions; <i>Latin (in part)</i> .
<b>W. M. Ra.</b>	SIR WILLIAM MITCHELL RAMSAY, Litt.D., D.C.L. See the biographical article, RAMSAY, SIR W. MITCHELL.	
<b>W. R. So.</b>	WILLIAM RITCHIE SORLEY, M.A., LITT.D., LL.D. Professor of Moral Philosophy in the University of Cambridge. Fellow of King's College, Cambridge. Fellow of the British Academy. Formerly Fellow of Trinity College. Author of <i>The Ethics of Naturalism</i> ; <i>The Interpretation of Evolution</i> ; &c.	} Iamblichus.
<b>W. T. T.-D.</b>	SIR WILLIAM TURNER THISELTON-DYER, F.R.S., K.C.M.G., C.I.E., D.Sc., LL.D., PH.D., F.L.S. Hon. Student of Christ Church, Oxford. Director, Royal Botanic Gardens, Kew, 1885-1905. Botanical Adviser to Secretary of State for Colonies, 1902-1906. Joint-author of <i>Flora of Middlesex</i> . Editor of <i>Flora Capensis</i> and <i>Flora of Tropical Africa</i> .	
<b>W. Wn.</b>	WILLIAM WATSON, D.Sc., F.R.S., A.R.C.S. Assistant Professor of Physics, Royal College of Science, London. Vice-President of the Physical Society. Author of <i>A Text Book of Practical Physics</i> ; &c.	} Inclinator.
<b>W. W. H.</b>	SIR WILLIAM WILSON HUNTER. See the biographical article, HUNTER, SIR WILLIAM WILSON.	

## PRINCIPAL UNSIGNED ARTICLES

Husband and Wife.  
Hyacinth.  
Hyderabad.  
Hydrogen.  
Hydrophobia.  
Hydrophobia.  
Ice.  
Ice-Yachting.  
Idaho.  
Iguana.

Illinois.  
Illumination.  
Illyria.  
Image.  
Impeachment.  
Income Tax.  
Indiana.  
Indian Mutiny.  
Indicator.

Infant.  
Infanticide.  
Infinite.  
Influenza.  
Inheritance.  
Injunction.  
Ink.  
Inkerman.  
International, The.

Intestacy.  
Inverness-shire.  
Investiture.  
Iodine.  
Iowa.  
Ipecacuanha.  
Iris.  
Iron.  
Irrigation.

# ENCYCLOPÆDIA BRITANNICA

## ELEVENTH EDITION

### VOLUME XIV

**HUSBAND**, properly the "head of a household," but now chiefly used in the sense of a man legally joined by marriage to a woman, his "wife"; the legal relations between them are treated below under **HUSBAND AND WIFE**. The word appears in O. Eng. as *húsbonda*, answering to the Old Norwegian *húsbóndi*, and means the owner or freeholder of a *hus*, or house. The last part of the word still survives in "bondage" and "bondman," and is derived from *bua*, to dwell, which, like Lat. *colere*, means also to till or cultivate, and to have a household. "Wife," in O. Eng. *wif*, appears in all Teutonic languages except Gothic; cf. Ger. *Weib*, Dutch *wijf*, &c., and meant originally simply a female, "woman" itself being derived from *wisman*, the pronunciation of the plural *wimmen* still preserving the original *i*. Many derivations of "wife" have been given; thus it has been connected with the root of "weave," with the Gothic *waibjan*, to fold or wrap up, referring to the entangling clothes worn by a woman, and also with the root of *vibrare*, to tremble. These are all merely guesses, and the ultimate history of the word is lost. It does not appear outside Teutonic languages. Parallel to "husband" is "housewife," the woman managing a household. The earlier *húswif* was pronounced *hussif*, and this pronunciation survives in the application of the word to a small case containing scissors, needles and pins, cottons, &c. From this form also derives "hussy," now only used in a depreciatory sense of a light, impertinent girl. Beyond the meaning of a husband as a married man, the word appears in connexion with agriculture, in "husbandry" and "husbandman." According to some authorities "husbandman" meant originally in the north of England a holder of a "husbandland," a manorial tenant who held two ox-gangs or virgates, and ranked next below the yeoman (see J. C. Atkinson in *Notes and Queries*, 6th series, vol. xii., and E. Bateson, *History of Northumberland*, ii., 1893). From the idea of the manager of a household, "husband" was in use transferred to the manager of an estate, and the title was held by certain officials, especially in the great trading companies. Thus the "husband" of the East India Company looked after the interests of the company at the custom-house. The word in this sense is practically obsolete, but it still appears in "ship's husband," an agent of the owners of a ship who looks to the proper equipping of the vessel, and her repairs, procures and adjusts freights, keeps the accounts, makes

charter-parties and acts generally as manager of the ship's employment. Where such an agent is himself one of the owners of the vessel, the name of "managing owner" is used. The "ship's husband" or "managing owner" must register his name and address at the port of registry (Merchant Shipping Act 1894, § 59). From the use of "husband" for a good and thrifty manager of a household, the verb "to husband" means to economize, to lay up a store, to save.

**HUSBAND AND WIFE**, LAW RELATING TO. For the modes in which the relation of husband and wife may be constituted and dissolved, see **MARRIAGE** and **DIVORCE**. The present article will deal only with the effect of marriage on the legal position of the spouses. The person chiefly affected is the wife, who probably in all political systems becomes subject, in consequence of marriage, to some kind of disability. The most favourable system scarcely leaves her as free as an unmarried woman; and the most unfavourable subjects her absolutely to the authority of her husband. In modern times the effect of marriage on property is perhaps the most important of its consequences, and on this point the laws of different states show wide diversity of principles.

The history of Roman law exhibits a transition from an extreme theory to its opposite. The position of the wife in the earliest Roman household was regulated by the law of *Manus*. She fell under the "hand" of her husband,—became one of his family, along with his sons and daughters, natural or adopted, and his slaves. The dominion which, so far as the children was concerned, was known as the *patria potestas*, was, with reference to the wife, called the *manus*. The subject members of the family, whether wife or children, had, broadly speaking, no rights of their own. If this institution implied the complete subjection of the wife to the husband, it also implied a much closer bond of union between them than we find in the later Roman law. The wife on her husband's death succeeded, like the children, to freedom and a share of the inheritance. *Manus*, however, was not essential to a legal marriage; its restraints were irksome and unpopular, and in course of time it ceased to exist, leaving no equivalent protection of the stability of family life. The later Roman marriage left the spouses comparatively independent of each other. The distance between the two modes of marriage may be estimated by the fact that,

while under the former the wife was one of the husband's immediate heirs, under the latter she was called to the inheritance only after his kith and kin had been exhausted, and only in preference to the treasury. It seems doubtful how far she had, during the continuance of marriage, a legal right to enforce alimony from her husband, although if he neglected her she had the unsatisfactory remedy of an easy divorce. The law, in fact, preferred to leave the parties to arrange their mutual rights and obligations by private contracts. Hence the importance of the law of settlements (*Dotes*). The *Dos* and the *Donatio ante nuptias* were settlements by or on behalf of the husband or wife, during the continuance of the marriage, and the law seems to have looked with some jealousy on gifts made by one to the other in any less formal way, as possibly tainted with undue influence. During the marriage the husband had the administration of the property.

The *manus* of the Roman law appears to be only one instance of an institution common to all primitive societies. On the continent of Europe after many centuries, during which local usages were brought under the influence of principles derived from the Roman law, a theory of marriage became established, the leading feature of which is the *community of goods* between husband and wife. Describing the principle as it prevails in France, Story (*Conflict of Laws*, § 130) says: "This community or nuptial partnership (in the absence of any special contract) generally extends to all the movable property of the husband and wife, and to the fruits, income and revenue thereof. . . . It extends also to all immovable property of the husband and wife acquired during the marriage, but not to such immovable property as either possessed at the time of the marriage, or which came to them afterwards by title of succession or by gift. The property thus acquired by this nuptial partnership is liable to the debts of the parties existing at the time of the marriage; to the debts contracted by the husband during the community, or by the wife during the community with the consent of the husband; and to debts contracted for the maintenance of the family. . . . The husband alone is entitled to administer the property of the community, and he may alien, sell or mortgage it without the concurrence of the wife." But he cannot dispose by will of more than his share of the common property, nor can he part with it gratuitously *inter vivos*. The community is dissolved by death (natural or civil), divorce, separation of body or separation of property. On separation of body or of property the wife is entitled to the full control of her movable property, but cannot alien her immovable property, without her husband's consent or legal authority. On the death of either party the property is divided in equal moieties between the survivor and the heirs of the deceased.

*Law of England*.—The English common law as usual followed its own course in dealing with this subject, and in no department were its rules more entirely insular and independent. The text writers all assumed two fundamental principles, which between them established a system of rights totally unlike that just described. Husband and wife were said to be one person in the eye of the law—*unica persona, quia caro una et sanguis unus*. Hence a man could not grant or give anything to his wife, because she was himself, and if there were any compacts between them before marriage they were dissolved by the union of persons. Hence, too, the old rule of law, now greatly modified, that husband and wife could not be allowed to give evidence against each other, in any trial, civil or criminal. The unity, however, was one-sided only; it was the wife who was merged in the husband, not the husband in the wife. And when the theory did not apply, the disabilities of "coverture" suspended the active exercise of the wife's legal faculties. The old technical phraseology described husband and wife as *baron and feme*; the rights of the husband were baronial rights. From one point of view the wife was merged in the husband, from another she was as one of his vassals. A curious example is the immunity of the wife in certain cases from punishment for crime committed in the presence and on the presumed coercion of the husband. "So great a favourite," says Blackstone, "is the female sex of the laws of England."

The application of these principles with reference to the property of the wife, and her capacity to contract, may now be briefly traced.

The *freehold property* of the wife became vested in the husband and herself during the coverture, and he had the management and the profits. If the wife had been in actual possession at any time during the marriage of an estate of inheritance, and if there had been a child of the marriage capable of inheriting, then the husband became entitled on his wife's death to hold the estate for his own life as tenant by the *curtesy of England* (*curtilitas*).<sup>1</sup> Beyond this, however, the husband's rights did not extend, and the wife's heir at last succeeded to the inheritance. The wife could not part with her real estate without the concurrence of the husband; and even so she must be examined apart from her husband, to ascertain whether she freely and voluntarily consented to the deed.

With regard to personal property, it passed absolutely at common law to the husband. Specific things in the possession of the wife (*choses in possession*) became the property of the husband at once; things not in possession, but due and recoverable from others (*choses in action*), might be recovered by the husband. A *chase* in action not reduced into actual possession, when the marriage was dissolved by death, reverted to the wife if she was the survivor; if the husband survived he could obtain possession by taking out letters of administration. A *chase* in action was to be distinguished from a specific thing which, although the property of the wife, was for the time being in the hands of another. In the latter case the property was in the wife, and passed at once to the husband; in the former the wife had a mere *jus in personam*, which the husband might enforce if he chose, but which was still capable of reverting to the wife if the husband died without enforcing it.

The *chattel's real* of the wife (*i.e.*, personal property, dependent on, and partaking of, the nature of realty, such as leaseholds) passed to the husband, subject to the wife's right of survivorship, unless barred by the husband by some act done during his life. A disposition by will did not bar the wife's interest; but any disposition *inter vivos* by the husband was valid and effective.

The courts of equity, however, greatly modified the rules of the common law by the introduction of the wife's *separate estate*, *i.e.* property settled to the wife for her separate use, independently of her husband. The principle seems to have been originally admitted in a case of actual separation, when a fund was given for the maintenance of the wife while living apart from her husband. And the conditions under which separate estate might be enjoyed had taken the Court of Chancery many generations to develop. No particular form of words was necessary to create a separate estate, and the intervention of trustees, though common, was not necessary. A clear intention to deprive the husband of his common law rights was sufficient to do so. In such a case a married woman was entitled to deal with her property as if she was unmarried, although the earlier decisions were in favour of requiring her binding engagements to be in writing or under seal. But it was afterwards held that any engagements, clearly made with reference to the separate estate, would bind that estate, exactly as if the woman had been a *feme sole*. Connected with the doctrine of separate use was the equitable contrivance of *restraint on anticipation* with which later legislation has not interfered, whereby property might be so settled to the separate use of a married woman that she could not, during coverture, alienate it or anticipate the income. No such restraint is recognized in the case of a man or of a *feme sole*, and it depends entirely on the separate estate; and the separate estate has its existence only during coverture, so that a woman to whom such an estate is given may dispose of it so long as she is unmarried, but becomes bound by the restraint as soon as she is married. In yet another way the court of Chancery interfered to protect the interests of married women. When a

<sup>1</sup> Curtesy or courtesy has been explained by legal writers as "arising by favour of the law of England." The word has nothing to do with courtesy in the sense of complaisance.

husband sought the aid of that court to get possession of his wife's *choses* in action, he was required to make a provision for her and her children out of the fund sought to be recovered. This is called the wife's *equity to a settlement*, and is said to be based on the original maxim of Chancery jurisprudence, that "he who seeks equity must do equity." Two other property interests of minor importance are recognised. The wife's *pin-money* is a provision for the purchase of clothes and ornaments suitable to her husband's station, but it is not an absolute gift to the separate use of the wife; and a wife surviving her husband cannot claim for more than one year's arrears of pin-money. *Paraphernalia* are jewels and other ornaments given to the wife by her husband for the purpose of being worn by her, but not as her separate property. The husband may dispose of them by act *inter vivos* but not by will, unless the will confers other benefits on the wife, in which case she must elect between the will and the paraphernalia. She may also on the death of the husband claim paraphernalia, provided all creditors have been satisfied, her right being superior to that of any legatee.

The corresponding interest of the wife in the property of the husband is much more meagre and illusory. Besides a general right to maintenance at her husband's expense, she has at common law a right to *dower* (*g.v.*) in her husband's lands, and to a *pars rationabilis* (third) of his personal estate, if he dies intestate. The former, which originally was a solid provision for widows, has by the ingenuity of conveyancers, as well as by positive enactment, been reduced to very slender dimensions. It may be destroyed by a mere declaration to that effect on the part of the husband, as well as by his conveyance of the land or by his will.

The common practice of regulating the rights of husband, wife and children by marriage settlements obviates the hardships of the common law—at least for the women of the wealthier classes. The legislature by the Married Women's Property Acts of 1870, 1874, 1882 (which repealed and consolidated the acts of 1870 and 1874), 1893 and 1907 introduced very considerable changes. The chief provisions of the Married Women's Property Act 1882, which enormously improved the position of women unprotected by marriage settlement, are, shortly, that a married woman is capable of acquiring, holding and disposing of by will or otherwise, any real and personal property, in the same manner as if she were a *feme sole*, without the intervention of any trustee. The property of a woman married after the beginning of the act, whether belonging to her at the time of marriage or acquired after marriage, is held by her as a *feme sole*. The same is the case with property acquired after the beginning of the act by a woman married before the act. After marriage a woman remains liable for antenuptial debts and liabilities, and as between her and her husband, in the absence of contract to the contrary, her separate property is deemed primarily liable. The husband is only liable to the extent of property acquired from or through his wife. The act also contained provisions as to stock, investment, insurance, evidence and other matters. The effect of the act was to render obsolete the law as to what created a separate use or a reduction into possession of *choses* in action, as to equity to a settlement, as to fraud on the husband's marital rights, and as to the inability of one of two married persons to give a gift to the other. Also, in the case of a gift to a husband and wife in terms which would make them joint tenants if unmarried, they no longer take as one person but as two. The act contained a special saving of existing and future settlements; a settlement being still necessary where it is desired to secure only the enjoyment of the income to the wife and to provide for children. The act by itself would enable the wife, without regard to family claims, instantly to part with the whole of any property which might come to her. Restraint on anticipation was preserved by the act, subject to the liability of such property for antenuptial debts, and to the power given by the Conveyancing Act 1881 to bind a married woman's interest notwithstanding a clause of restraint. The Married Women's Property Act of 1893 repealed two clauses in the act of 1882, the exact bearing of

which had been a matter of controversy. It provided specifically that every contract thereafter entered into by a married woman, otherwise than as an agent, should be deemed to be a contract entered into by her with respect to and be binding upon her separate property, whether she was or was not in fact possessed of or entitled to any separate property at the time when she entered into such contract, that it should bind all separate property which she might at any time or thereafter be possessed of or entitled to, and that it should be enforceable by process of law against all property which she might thereafter, while discoverable, be possessed of or entitled to. The act of 1907 enabled a married woman, without her husband, to dispose of or join in disposing of, real or personal property held by her solely or jointly as trustee or personal representative, in like manner as if she were a *feme sole*. It also provided that a settlement or agreement for settlement whether before or after marriage, respecting the property of the woman, should not be valid unless executed by her if she was of full age or confirmed by her after she attained full age. The Married Women's Property Act 1908 removed a curious anomaly by enacting that a married woman having separate property should be equally liable with single women and widows for the maintenance of parents who are in receipt of poor relief.

The British colonies generally have adopted the principles of the English acts of 1882 and 1893.

*Law of Scotland.*—The law of Scotland differs less from English law than the use of a very different terminology would lead us to suppose. The phrase *communio bonorum* has been employed to express the interest which the spouses have in the *notable* property of both, but its use has been severely censured as essentially inaccurate and misleading. It has been contended that there was no real community of goods, and no partnership or societas between the spouses. The wife's movable property, with certain exceptions, and subject to special agreements, became as absolutely the property of the husband as it did in English law. The notion of a *communio* was, however, favoured by peculiar rights of the wife and children on the dissolution of the marriage. Previous to the Intestate Movable Succession (Scotland) Act 1855 the law stood as follows. The fund formed by the movable property of both spouses may be dealt with by the husband as he pleases during life; it is increased by his acquisitions and diminished by his debts. The respective shares contributed by husband and wife return on the dissolution of the marriage to them or their representatives if the marriage be dissolved within a year and a day, and without a living child. Otherwise the division is into two or three shares, according as children are existing or not at the dissolution of the marriage. On the death of the husband, his children take one-third (called *legitim*), the widow takes one-third (*jus relictæ*), and the remaining one-third (the *dead part*) goes according to his will or to his next of kin. If there be no children, the *jus relictæ* and the *dead part* are each one-half. If the wife die before the husband, her representatives, whether children or not, are creditors for the value of her share. The statute above-mentioned, however, enacts that "where a wife shall predecease her husband, the next of kin, executors or other representatives of such wife, whether testate or intestate, shall have no right to any share of the goods in communion; nor shall any legacy or bequest or testamentary disposition thereof by such wife, affect or attach to the said goods or any portion thereof." It also abolishes the rule by which the shares revert if the marriage does not subsist for a year and a day. Several later acts apply to Scotland some of the principles of the English Married Women's Property Acts. These are the Married Women's Property (Scotland) Act 1877, which protects the earnings, &c., of wives, and limits the husband's liability for antenuptial debts of the wife, the Married Women's Policies of Assurance (Scotland) Act 1880, which enables a woman to contract for a policy of assurance for her separate use, and the Married Women's Property (Scotland) Act 1881, which abolished the *jus maritis*.

A wife's *heritable* property does not pass to the husband on marriage, but he acquires a right to the administration and profits. His courtesy, as in English law, is also recognised. On the other hand, a widow has a *terce* or life-rent of a third part of the husband's heritable estate, unless she has accepted a conventional provision. *Continental Europe.*—Since 1882 English legislation in the matter of married women's property has progressed from perhaps the most backward to the foremost place in Europe. By a curious contrast, the only two European countries where, in the absence of a settlement to the contrary, independence of the wife's property was recognised, were Russia and Italy. But there is now a marked tendency towards contractual emancipation. Sweden adopted a law on this subject in 1874, Denmark in 1880, Norway in 1888. Germany followed, the Civil Code which came into operation in 1900 (Art. 1367) providing that the wife's wages or earnings shall form part of her *Vorbehaltsgut* or separate property, which a previous article

(1365) placed beyond the husband's control. As regards property accruing to the wife in Germany by succession, will or gift *inter vivos*, it is only separate property where the donor has deliberately stipulated exclusion of the husband's right.

In France it seemed as if the system of community of property was ingrained in the institutions of the country. But a law of 1907 has brought France into line with other countries. This law gives a married woman sole control over earnings from her personal work and savings therefrom. She can with such money acquire personality or realty, over the former of which she has absolute control. But if she abuses her rights by squandering her money or administering her property badly or imprudently the husband may apply to the court to have her freedom restricted.

**American Law.**—In the United States, the revolt against the common law theory of husband and wife was carried farther than in England, and legislation early tended in the direction of absolute equality between the sexes. Each state has, however, taken its own way and selected its own time for introducing modifications of the existing law, so that the legislation on this subject is now exceedingly complicated and difficult. James Schouler (*Law of Domestic Relations*) gives an account of the general result in the different states to which reference may be made. The peculiar system of Homestead Laws in many of the states (see **HOMESTEAD and EXEMPTION LAWS**) constitutes an inalienable provision for the wife and family of the householder.

**HUSHI** (Rumanian *Huşti*), the capital of the department of Falcui, Rumania, on a branch of the Jassy-Galat railway, 9 m. W. of the river Pruth and the Russian frontier. Pop. (1900) 15,404, about one-fourth being Jews. Hushi is an episcopal see. The cathedral was built in 1401 by Stephen the Great of Moldavia. There are no important manufactures, but a large fair is held annually in September for the sale of live-stock, and wine is produced in considerable quantities. Hushi is said to have been founded in the 15th century by a colony of Hussites, from whom its name is derived. The treaty of the Pruth between Russia and Turkey was signed here in 1711.

**HUSKISSON, WILLIAM** (1770-1830), English statesman and financier, was descended from an old Staffordshire family of moderate fortune, and was born at Birch Moreton, Worcestershire, on the 11th of March 1770. Having been placed in his fourteenth year under the charge of his maternal great-uncle Dr Gem, physician to the English embassy at Paris, in 1783 he passed his early years amidst a political fermentation which led him to take a deep interest in politics. Though he approved of the French Revolution, his sympathies were with the more moderate party, and he became a member of the "club of 1789," instituted to support the new form of constitutional monarchy in opposition to the anarchical attempts of the Jacobins. He early displayed his mastery of the principles of finance by a *Discours* delivered in August 1790 before this society, in regard to the issue of assignats by the government. The *Discours* gained him considerable reputation, but as it failed in its purpose he withdrew from the society. In January 1793 he was appointed by Dundas to an office created to direct the execution of the Aliens Act; and in the discharge of his delicate duties he manifested such ability that in 1795 he was appointed under-secretary at war. In the following year he entered parliament as member for Morpeth, but for a considerable period he took scarcely any part in the debates. In 1800 he inherited a fortune from Dr Gem. On the retirement of Pitt in 1801 he resigned office, and after contesting Dover unsuccessfully he withdrew for a time into private life. Having in 1804 been chosen to represent Liskeard, he was on the restoration of the Pitt ministry appointed secretary of the treasury, holding office till the dissolution of the ministry after the death of Pitt in January 1806. After being elected for Harwich in 1807, he accepted the same office under the duke of Portland, but he withdrew from the ministry along with Canning in 1809. In the following year he published a pamphlet on the currency system, which confirmed his reputation as the ablest financier of his time; but his free-trade principles did not accord with those of his party. In 1812 he was returned for Chichester. When in 1814 he re-entered the public service, it was only as chief commissioner of woods and forests, but his influence was from this time very great in the commercial and financial legislation of the country. He took a prominent part in the corn-law debates of 1814 and 1815; and in 1819 he presented a memorandum to Lord Liverpool advocating a large

reduction in the unfunded debt, and explaining a method for the resumption of cash payments, which was embodied in the act passed the same year. In 1821 he was a member of the committee appointed to inquire into the causes of the agricultural distress then prevailing, and the proposed relaxation of the corn laws embodied in the report was understood to have been chiefly due to his strenuous advocacy. In 1823 he was appointed president of the board of trade and treasurer of the navy, and shortly afterwards he received a seat in the cabinet. In the same year he was returned for Liverpool as successor to Canning, and as the only man who could reconcile the Tory merchants to a free trade policy. Among the more important legislative changes with which he was principally connected were a reform of the Navigation Acts, admitting other nations to a full equality and reciprocity of shipping duties; the repeal of the labour laws; the introduction of a new sinking fund; the reduction of the duties on manufactures and on the importation of foreign goods, and the repeal of the quarantine duties. In accordance with his suggestion Canning in 1827 introduced a measure on the corn laws proposing the adoption of a sliding scale to regulate the amount of duty. A misapprehension between Huskisson and the duke of Wellington led to the duke proposing an amendment, the success of which caused the abandonment of the measure by the government. After the death of Canning in the same year Huskisson accepted the secretaryship of the colonies under Lord Goderich, an office which he continued to hold in the new cabinet formed by the duke of Wellington in the following year. After succeeding with great difficulty in inducing the cabinet to agree to a compromise on the corn laws, Huskisson finally resigned office in May 1829 on account of a difference with his colleagues in regard to the disfranchisement of East Retford. On the 15th of September of the following year he was accidentally killed by a locomotive engine while present at the opening of the Liverpool and Manchester railway.

See the *Life of Huskisson*, by J. Wright (London, 1831).

**HUSS** (or **HUS**), **JOHN** (c. 1373-1415), Bohemian reformer and martyr, was born at Hussinecz,<sup>1</sup> a market village at the foot of the Böhmerwald, and not far from the Bavarian frontier, between 1373 and 1375, the exact date being uncertain. His parents appear to have been well-to-do Czechs of the peasant class. Of his early life nothing is recorded except that, notwithstanding the early loss of his father, he obtained a good elementary education, first at Hussinecz, and afterwards at the neighbouring town of Prachatitz. At, or only a very little beyond, the usual age he entered the recently (1348) founded university of Prague, where he became bachelor of arts in 1393, bachelor of theology in 1394, and master of arts in 1396. In 1398 he was chosen by the Bohemian "nation" of the university to an examinership for the bachelor's degree; in the same year he began to lecture also, and there is reason to believe that the philosophical writings of Wycliffe, with which he had been for some years acquainted, were his text-books. In October 1401 he was made dean of the philosophical faculty, and for the half-yearly period from October 1402 to April 1403 he held the office of rector of the university. In 1402 also he was made rector or curate (*capellarius*) of the Bethlehem chapel, which had in 1391 been erected and endowed by some zealous citizens of Prague for the purpose of providing good popular preaching in the Bohemian tongue. This appointment had a deep influence on the already vigorous religious life of Huss himself; and one of the effects of the earnest and independent study of Scripture into which it led him was a profound conviction of the great value not only of the philosophical but also of the theological writings of Wycliffe.

This newly-formed sympathy with the English reformer did not, in the first instance at least, involve Huss in any conscious opposition to the established doctrines of Catholicism, or in any direct conflict with the authorities of the church; and for

<sup>1</sup> From which the name Huss, or more properly Hus, an abbreviation adopted by himself about 1396, is derived. Prior to that date he was invariably known as Johann Hussynecz, Hussinecz, Hussenicz or de Hussynecz.



several years he continued to act in full accord with his archbishop (Sbynjek, or Sbynko, of Hasenburg). Thus in 1405 he, with other two masters, was commissioned to examine into certain reputed miracles at Wilsnack, near Wittenberg, which had caused that church to be made a resort of pilgrims from all parts of Europe. The result of their report was that all pilgrimage thither from the province of Bohemia was prohibited by the archbishop on pain of excommunication, while Huss, with the full sanction of his superior, gave to the world his first published writing, entitled *De Osmi Sanguine Christi Glorificato*, in which he declaimed in no measured terms against forged miracles and ecclesiastical greed, urging Christians at the same time to desist from looking for sensible signs of Christ's presence, but rather to seek Him in His enduring word. More than once also Huss, together with his friend Stanislaus of Znaim, was appointed to be synod preacher, and in this capacity he delivered at the provincial councils of Bohemia many faithful admonitions. As early as the 28th of May 1403, it is true, there had been held a university disputation about the new doctrines of Wycliffe, which had resulted in the condemnation of certain propositions presumed to be his; five years later (May 20, 1408) this decision had been refined into a declaration that these, forty-five in number, were not to be taught in any heretical, erroneous or offensive sense. But it was only slowly that the growing sympathy of Huss with Wycliffe unfavourably affected his relations with his colleagues in the priesthood. In 1408, however, the clergy of the city and archiepiscopal diocese of Prague laid before the archbishop a formal complaint against Huss, arising out of strong expressions with regard to clerical abuses of which he had made use in his public discourses; and the result was that, having been first deprived of his appointment as synodal preacher, he was, after a vain attempt to defend himself in writing, publicly forbidden the exercise of any priestly function throughout the diocese. Simultaneously with these proceedings in Bohemia, negotiations had been going on for the removal of the long-continued papal schism, and it had become apparent that a satisfactory solution could only be secured if, as seemed not impossible, the supporters of the rival popes, Benedict XIII. and Gregory XII., could be induced, in view of the approaching council of Pisa, to pledge themselves to a strict neutrality. With this end King Wenceslaus of Bohemia had requested the co-operation of the archbishop and his clergy, and also the support of the university, in both instances unsuccessfully, although in the case of the latter the Bohemian "nation," with Huss at its head, had only been overborne by the votes of the Bavarians, Saxons and Poles. There followed an expression of nationalist and particularistic as opposed to ultramontane and also to German feeling, which undoubtedly was of supreme importance for the whole of the subsequent career of Huss. In compliance with this feeling a royal edict (January 18, 1409) was issued, by which, in alleged conformity with Paris usage, and with the original charter of the university, the Bohemian "nation" received three votes, while only one was allotted to the other three "nations" combined; whereupon all the foreigners, to the number of several thousands, almost immediately withdrew from Prague, an occurrence which led to the formation shortly afterwards of the university of Leipzig.

It was a dangerous triumph for Huss; for his popularity at court and in the general community had been secured only at the price of clerical antipathy everywhere and of much German ill-will. Among the first results of the changed order of things were on the one hand the election of Huss (October 1409) to be again rector of the university, but on the other hand the appointment by the archbishop of an inquisitor to inquire into charges of heretical teaching and inflammatory preaching brought against him. He had spoken disrespectfully of the church, it was said, had even hinted that Antichrist might be found to be in Rome, had fomented in his preaching the quarrel between Bohemians and Germans, and had, notwithstanding all that had passed, continued to speak of Wycliffe as both a pious man and an orthodox teacher. The direct result of this investigation is not known, but it is impossible to disconnect from it the

promulgation by Pope Alexander V., on the 20th of December 1409, of a bull which ordered the abjuration of all Wycliffite heresies and the surrender of all his books, while at the same time—a measure specially levelled at the pulpit of Bethlehem chapel—all preaching was prohibited except in localities which had been by long usage set apart for that use. This decree, as soon as it was published in Prague (March 9, 1410), led to much popular agitation, and provoked an appeal by Huss to the pope's better informed judgment; the archbishop, however, resolutely insisted on carrying out his instructions, and in the following July caused to be publicly burned, in the courtyard of his own palace, upwards of 200 volumes of the writings of Wycliffe, while he pronounced solemn sentence of excommunication against Huss and certain of his friends, who had in the meantime again protested and appealed to the new pope (John XXIII.). Again the populace rose on behalf of their hero, who, in his turn, strong in the conscientious conviction that "in the things which pertain to salvation God is to be obeyed rather than man," continued uninterruptedly to preach in the Bethlehem chapel, and in the university began publicly to defend the so-called heretical treatises of Wycliffe, while from king and queen, nobles and burghers, a petition was sent to Rome praying that the condemnation and prohibition in the bull of Alexander V. might be quashed. Negotiations were carried on for some months, but in vain; in March 1411 the ban was anew pronounced upon Huss as a disobedient son of the church, while the magistrates and councillors of Prague who had favoured him were threatened with a similar penalty in case of their giving him a contumacious support. Ultimately the whole city, which continued to harbour him, was laid under interdict; yet he went on preaching, and masses were celebrated as usual, so that at the date of Archbishop Sbynko's death in September 1411, it seemed as if the efforts of ecclesiastical authority had resulted in absolute failure.

The struggle, however, entered on a new phase with the appearance at Prague in May 1412 of the papal emissary charged with the proclamation of the papal bulls by which a religious war was decreed against the excommunicated King Ladislaus of Naples, and indulgence was promised to all who should take part in it, on terms similar to those which had been enjoyed by the earlier crusaders to the Holy Land. By his bold and thorough-going opposition to this mode of procedure against Ladislaus, and still more by his doctrine that indulgence could never be sold without simony, and could not be lawfully granted by the church except on condition of genuine contrition and repentance, Huss at last isolated himself, not only from the archiepiscopal party under Albik of Unitschow, but also from the theological faculty of the university, and especially from such men as Stanislaus of Znaim and Stephen Paletz, who until then had been his chief supporters. A popular demonstration, in which the papal bulls had been paraded through the streets with circumstances of peculiar ignominy and finally burnt, led to intervention by Wenceslaus on behalf of public order; three young men, for having openly asserted the unlawfulness of the papal indulgence after silence had been enjoined, were sentenced to death (June 1412); the excommunication against Huss was renewed, and the interdict again laid on all places which should give him shelter—a measure which now began to be more strictly regarded by the clergy, so that in the following December Huss had no alternative but to yield to the express wish of the king by temporarily withdrawing from Prague. A provincial synod, held at the instance of Wenceslaus in February 1413, broke up without having reached any practical result; and a commission appointed shortly afterwards also failed to bring about a reconciliation between Huss and his adversaries. The so-called heretic meanwhile spent his time partly at Kozihradek, some 45 m. south of Prague, and partly at Krakowitz in the immediate neighbourhood of the capital, occasionally giving a course of open-air preaching, but finding his chief employment in maintaining that copious correspondence of which some precious fragments still are extant, and in the composition of the treatise, *De Ecclesia*, which subsequently furnished most of the material for the capital charges brought

against him, and was formerly considered the most important of his works, though it is mainly a transcript of Wycliffe's work of the same name.

During the year 1413 the arrangements for the meeting of a general council at Constance were agreed upon between Sigismund and Pope John XXIII. The objects originally contemplated had been the restoration of the unity of the church and its reform in head and members; but so great had become the prominence of Bohemian affairs that to these also a first place in the programme of the approaching oecumenical assembly required to be assigned, and for their satisfactory settlement the presence of Huss was necessary. His attendance was accordingly requested, and the invitation was willingly accepted as giving him a long-wished-for opportunity both of publicly vindicating himself from charges which he felt to be grievous, and of loyally making confession for Christ. He set out from Bohemia on the 14th of October 1414, not, however, until he had carefully ordered all his private affairs, with a presentiment, which he did not conceal, that in all probability he was going to his death. The journey, which appears to have been undertaken with the usual passport, and under the protection of several powerful Bohemian friends (John of Chlum, Wenceslaus of Duba, Henry of Chlum) who accompanied him, was a very prosperous one; and at almost all the halting-places he was received with a consideration and enthusiastic sympathy which he had hardly expected to meet with anywhere in Germany. On the 3rd of November he arrived at Constance; shortly afterwards there was put into his hands the famous imperial "safe conduct," the promise of which had been one of his inducements to quit the comparative security he had enjoyed in Bohemia. This safe conduct, which had been frequently printed, stated that Huss should, whatever judgment might be passed on him, be allowed to return freely to Bohemia. This by no means provided for his immunity from punishment. If faith to him had not been broken he would have been sent back to Bohemia to be punished by his sovereign, the king of Bohemia. The treachery of King Sigismund is undeniable, and was indeed admitted by the king himself. The safe conduct was probably indeed given by him to entice Huss to Constance. On the 4th of December the pope appointed a commission of three bishops to investigate the case against the heretic, and to procure witnesses; to the demand of Huss that he might be permitted to employ an agent in his defence a favourable answer was at first given, but afterwards even this concession to the forms of justice was denied. While the commission was engaged in the prosecution of its enquiries, the flight of Pope John XXIII. took place on the 20th of March, an event which furnished a pretext for the removal of Huss from the Dominican convent to a more secure and more severe place of confinement under the charge of the bishop of Constance at Gottlieben on the Rhine. On the 4th of May the temper of the council on the doctrinal questions in dispute was fully revealed in its unanimous condemnation of Wycliffe, especially of the so-called "forty-five articles" as erroneous, heretical, revolutionary. It was not, however, until the 5th of June that the case of Huss came up for hearing; the meeting, which was an exceptionally full one, took place in the refectory of the Franciscan cloister. Autograph copies of his work *De Ecclesia* and of the controversial tracts which he had written against Paletz and Stanislaus of Znaim having been acknowledged by him, the extracted propositions on which the prosecution based their charge of heresy were read; but as soon as the accused began to enter upon his defence, he was assailed by violent outcries, amidst which it was impossible for him to be heard, so that he was compelled to bring his speech to an abrupt close, which he did with the calm remark: "In such a council as this I had expected to find more propriety, esteem and order." It was found necessary to adjourn the sitting until the 7th of June, on which occasion the outward decencies were better observed, partly no doubt from the circumstance that Sigismund was present in person. The propositions which had been extracted from the *De Ecclesia* were again brought up, and the relations between Wycliffe and Huss were discussed,

the object of the prosecution being to fasten upon the latter the charge of having entirely adopted the doctrinal system of the former, including especially a denial of the doctrine of transubstantiation. The accused repudiated the charge of having abandoned the Catholic doctrine, while expressing hearty admiration and respect for the memory of Wycliffe. Being next asked to make an unqualified submission to the council, he expressed himself as unable to do so, while stating his willingness to amend his teaching wherever it had been shown to be false. With this the proceedings of the day were brought to a close. On the 8th of June the propositions extracted from the *De Ecclesia* were again taken up with some fulness of detail; some of these were repudiated as incorrectly given, others he defended; but when asked to make a general recantation he steadfastly declined, on the ground that to do so would be a dishonest admission of previous guilt. Among the propositions he could heartily abjure was that relating to transubstantiation; among those he felt constrained unflinchingly to maintain was one which had given great offence, to the effect that Christ, not Peter, is the head of the church to whom ultimate appeal must be made. The council, however, showed itself inaccessible to all his arguments and explanations, and its final resolution, as announced by Pierre d'Ailly, was threefold: first, that Huss should humbly declare that he had erred in all the articles cited against him; secondly, that he should promise on oath neither to hold nor teach them in the future; thirdly, that he should publicly recant them. On his declining to make this submission he was removed from the bar. Sigismund himself gave it as his opinion that it had been clearly proved by many witnesses that the accused had taught many pernicious heresies, and that even should he recant he ought never to be allowed to preach or teach again or to return to Bohemia, but that should he refuse recantation there was no remedy but the stake. During the next four weeks no effort was spared to shake the determination of Huss; but he steadfastly refused to swerve from the path which conscience had once made clear. "I write this," says he, in a letter to his friends at Prague, "in prison and in chains, expecting to-morrow to receive sentence of death, full of hope in God that I shall not swerve from the truth, nor abjure errors imputed to me by false witnesses." The sentence he expected was pronounced on the 6th of July in the presence of Sigismund and a full sitting of the council; once and again he attempted to remonstrate, but in vain, and finally he betook himself to silent prayer. After he had undergone the ceremony of degradation with all the childish formalities usual on such occasions, his soul was formally consigned by all those present to the devil, while he himself with clasped hands and uplifted eyes reverently committed it to Christ. He was then handed over to the secular arm, and immediately led to the place of execution, the council meanwhile proceeding unconcernedly with the rest of its business for the day. Many incidents recorded in the histories make manifest the meekness, fortitude and even cheerfulness with which he went to his death. After he had been tied to the stake and the faggots had been piled, he was for the last time urged to recant, but his only reply was: "God is my witness that I have never taught or preached that which false witnesses have testified against me. He knows that the great object of all my preaching and writing was to convert men from sin. In the truth of that gospel which hitherto I have written, taught and preached, I now joyfully die." The fire was then kindled, and his voice as it audibly prayed in the words of the "Kyrie Eleison" was soon stifled in the smoke. When the flames had done their office, the ashes that were left and even the soil on which they lay were carefully removed and thrown into the Rhine.

Not many words are needed to convey a tolerably adequate estimate of the character and work of the "pale thin man in mean attire," who in sickness and poverty thus completed the forty-sixth year of a busy life at the stake. The value of Huss as a scholar was formerly underrated. The publication of his *Super Iv. Sententiarum* has proved that he was a man of profound learning. Yet his principal glory will always be founded on his

spiritual teaching. It might not be easy to formulate precisely the doctrines for which he died, and certainly some of them, as, for example, that regarding the church, were such as many Protestants even would regard as unguarded and difficult to harmonize with the maintenance of external church order; but his is undoubtedly the honour of having been the chief intermediary in handing on from Wycliffe to Luther the torch which kindled the Reformation, and of having been one of the bravest of the martyrs who have died in the cause of honesty and freedom, of progress and of growth towards the light. (J. S. BL.)

The works of Huss are usually classed under four heads: the dogmatical and polemical, the homiletical, the exegetical and the epistolary. In the earlier editions of his works sufficient care was not taken to distinguish between his own writings and those of Wycliffe and others who were associated with him. In connexion with his sermons it is worthy of note that by means of them and by his public teaching generally Huss exercised a considerable influence not only on the religious life of his time, but on the literary development of his native tongue. The earliest collected edition of his works, *Historia et monumenta Joannis Hus et Hieronymi Pragensis*, was published at Nuremberg in 1558 and was repeated with a considerable quantity of new matter at Frankfurt in 1715. A Bohemian edition of the works has been edited by K. J. Erben (Prague, 1865-1868), and the *Documenta J. Hus vitium, doctrinam, causam in Constantiensi concilio* (1866), edited by F. Palacky, is very valuable. More recently *Joannis Hus. Opera omnia* have been edited by W. Flöjshaus (Prague, 1904 fol.). The *De Ecclesia* was published by Ulrich von Hutten in 1520; other controversial writings by Otto Brumfels in 1524; and Luther wrote an interesting preface to *Epistolae Quaedam*, which were published in 1537. These *Epistolae* have been translated into French by E. de Bonnehoise (1846), and the letters written during his imprisonment have been edited by C. von Kigelgen (Leipzig, 1902).

The best and most easily accessible information for the English reader on Huss is found in J. A. W. Neander's *Allgemeine Geschichte der christlichen Religion und Kirche*, translated by J. Torrey (1850-1858); in G. von Lechler's *Wiclif und die Vorgeschichte der Reformation*, translated by P. Lorimer (1878); in H. H. Milman's *History of Latin Christianity*, vol. viii. (1867); and in M. Creighton's *History of the Papacy* (1897). Among the earlier authorities is the *Historia Bohemica* of Cosmas Sylvius (1475). The *Acta* of the council of Constance (published by P. Labbe, in his *Concilia*, vol. xvi., 1731); by H. von der Haardt in his *Magnum Constantiense concilium*, vol. vi., 1700; and by H. Finke in his *Acta concilii Constantiensis*, 1806); and J. Lenfant's *Histoire de la guerre des Hussites* (1731) and the same writer's *Histoire du concile de Constance* (1714) should be consulted. F. Palacky's *Geschichte Böhmens* (1864-1867) is also very useful. Monographs on Huss are very numerous. Among them may be mentioned J. A. von Helfert, *Studien über Hus und Hieronymus* (1853); this work is ultramontan in its sympathies; C. von Höller, *Hus und der Abzug der deutschen Professoren und Studenten aus Prag* (1864); W. Berger, *Johannes Hus und König Sigmund* (1871); E. Denis, *Hus et la guerre des Hussites* (1878); P. Uhlmann, *König Sigmunds Geleit für Hus* (1804); J. Loserth, *Hus und Wiclif* (1884), translated into English by M. J. Evans (1884); A. Jeep, *Gerson, Wiclifus, Hussus, inter se comparati* (1857); and G. von Lechler, *Johannes Hus* (1889). See also Count Lütow, *The Life and Times of John Hus* (London, 1909).

**HUSSAR**, originally the name of a soldier belonging to a corps of light horse raised by Matthias Corvinus, king of Hungary, in 1458, to fight against the Turks. The Magyar *hussar*, from which the word is derived, was formerly connected with the Magyar *husz*, twenty, and was explained by a supposed raising of the troops by the taking of each twentieth man. According to the *New English Dictionary* the word is an adaptation of the Italian *corsaro*, corsair, a robber, and is found in 15th-century documents coupled with *praedones*. The hussar was the typical Hungarian cavalry soldier, and, in the absence of good light cavalry in the regular armies of central and western Europe, the name and character of the hussars gradually spread into Prussia, France, &c. Frederick the Great sent Major II. J. von Zieten to study the work of this type of cavalry in the Austrian service, and Zieten so far improved on the Austrian model that he defeated his old teacher, General Baranyai, in an encounter between the Prussian and Austrian hussars at Rotzschloss in 1741. The typical uniform of the Hungarian hussar was followed with modifications in other European armies. It consisted of a bushy or a high cylindrical cloth cap, jacket with heavy braiding, and a dolman or pelisse, a loose coat worn hanging from the left shoulder. The hussar regiments of the British army were converted from light dragoons at the following dates:

7th (1805), 10th and 15th (1806), 18th (1807, and again on revival after disbandment, 1858), 8th (1812), 11th (1840), 20th (late 2nd Bengal European Cavalry) (1860), 13th, 14th, and 19th (late 1st Bengal European Cavalry) (1861). The 21st Lancers were hussars from 1862 to 1897.

**HUSSITES**, the name given to the followers of John Huss (1369-1415), the Bohemian reformer. They were at first often called Wyclifites, as the theological theories of Huss were largely founded on the teachings of Wycliffe. Huss indeed laid more stress on church reform than on theological controversy. On such matters he always writes as a disciple of Wycliffe. The Hussite movement may be said to have sprung from three sources, which are however closely connected. Bohemia, which had first received Christianity from the East, was from geographical and other causes long but very loosely connected with the Church of Rome. The connexion became closer at the time when the schism with its violent controversies between the rival pontiffs, waged with the coarse invective customary to medieval theologians, had brought great discredit on the papacy. The terrible rapacity of its representatives in Bohemia, which increased in proportion as it became more difficult to obtain money from western countries such as England and France, caused general indignation; and this was still further intensified by the gross immorality of the Roman priests. The Hussite movement was also a democratic one, an uprising of the peasantry against the landowners at a period when a third of the soil belonged to the clergy. Finally national enthusiasm for the Slavic race contributed largely to its importance. The towns, in most cases creations of the rulers of Bohemia who had called in German immigrants, were, with the exception of the "new town" of Prague, mainly German; and in consequence of the regulations of the university, Germans also held almost all the more important ecclesiastical offices—a condition of things greatly resented by the natives of Bohemia, which at this period had reached a high degree of intellectual development.

The Hussite movement assumed a revolutionary character as soon as the news of the death of Huss reached Prague. The knights and nobles of Bohemia and Moravia, who were in favour of church reform, sent to the council at Constance (September 2nd, 1415) a protest, known as the "*protestatio Bohemorum*" which condemned the execution of Huss in the strongest language. The attitude of Sigmund, king of the Romans, who sent threatening letters to Bohemia declaring that he would shortly "drown all Wyclifites and Hussites," greatly incensed the people. Troubles broke out in various parts of Bohemia, and many Romanist priests were driven from their parishes. Almost from the first the Hussites were divided into two sections, though many minor divisions also arose among them. Shortly before his death Huss had accepted a doctrine preached during his absence by his adherents at Prague, namely that of "utraquism," *i.e.* the obligation of the faithful to receive communion in both kinds (*sub utraque specie*). This doctrine became the watchword of the moderate Hussites who were known as the Utraquists or Calixites (*calix*, the chalice), in Bohemian, *podobojí*; while the more advanced Hussites were soon known as the Taborites, from the city of Tabor that became their centre.

Under the influence of his brother Sigmund, king of the Romans, King Wenceslaus endeavoured to stem the Hussite movement. A certain number of Hussites lead by Nicolas of Hus—no relation of John Huss—left Prague. They held meetings in various parts of Bohemia, particularly at Usti, near the spot where the town of Tabor was founded soon afterwards. At these meetings Sigmund was violently denounced, and the people everywhere prepared for war. In spite of the departure of many prominent Hussites the troubles at Prague continued. On the 30th of July 1410, when a Hussite procession headed by the priest John of Želivo (in Ger. Selau) marched through the streets of Prague, stones were thrown at the Hussites from the windows of the town-hall of the "new town." The people, headed by John Žižka (1376-1424), threw the burgomaster and several town-councillors, who were the instigators of this outrage, from the windows and they were immediately killed by the

crowd. On hearing this news King Wenceslaus was seized with an apoplectic fit, and died a few days afterwards. The death of the king resulted in renewed troubles in Prague and in almost all parts of Bohemia. Many Romanists, mostly Germans—for they had almost all remained faithful to the papal cause—were expelled from the Bohemian cities. In Prague, in November 1419, severe fighting took place between the Hussites and the mercenaries whom Queen Sophia (widow of Wenceslaus and regent after the death of her husband) had hurriedly collected. After a considerable part of the city had been destroyed a truce was concluded on the 13th of November. The nobles, who though favourable to the Hussite cause yet supported the regent, promised to act as mediators with Sigismund; while the citizens of Prague consented to restore to the royal forces the castle of Vyšehrad, which had fallen into their hands. Žižka, who disapproved of this compromise, left Prague and retired to Plzeň (Pilsen). Unable to maintain himself there he marched to southern Bohemia, and after defeating the Romanists at Sudoměř—the first pitched battle of the Hussite wars—he arrived at Ústí, one of the earliest meeting-places of the Hussites. Not considering its situation sufficiently strong, he moved to the neighbouring new settlement of the Hussites, to which the biblical name of Tabor was given. Tabor soon became the centre of the advanced Hussites, who differed from the Utraquist by recognizing only two sacraments—Baptism and Communion—and by rejecting most of the ceremonial of the Roman Church. The ecclesiastical organization of Tabor had a somewhat puritanic character, and the government was established on a thoroughly democratic basis. Four captains of the people (*hejtmane*) were elected, one of whom was Žižka; and a very strictly military discipline was instituted.

Sigismund, king of the Romans, had, by the death of his brother Wenceslaus without issue, acquired a claim on the Bohemian crown; though it was then, and remained till much later, doubtful whether Bohemia was an hereditary or an elective monarchy. A firm adherent of the Church of Rome, Sigismund was successful in obtaining aid from the pope. Martin V. issued a bull on the 17th of March 1420 which proclaimed a crusade "for the destruction of the Wyclifites, Hussites and all other heretics in Bohemia." The vast army of crusaders, with which were Sigismund and many German princes, and which consisted of adventurers attracted by the hope of pillage from all parts of Europe, arrived before Prague on the 30th of June and immediately began the siege of the city, which had, however, soon to be abandoned (see ŽIŽKA, JOHN). Negotiations took place for a settlement of the religious differences. The united Hussites formulated their demands in a statement known as the "articles of Prague." This document, the most important of the Hussite period, runs thus in the wording of the contemporary chronicler, Laurence of Brezova:—

I. The word of God shall be preached and made known in the kingdom of Bohemia freely and in an orderly manner by the priests of the Lord. . . .

II. The sacrament of the most Holy Eucharist shall be freely administered in the two kinds, that is bread and wine, to all the faithful in Christ who are not precluded by mortal sin—according to the word and disposition of Our Saviour.

III. The secular power over riches and worldly goods which the clergy possesses in contradiction to Christ's precept, to the prejudice of its office and to the detriment of the secular arm, shall be taken and withdrawn from it, and the clergy itself shall be brought back to the evangelical rule and an apostolic life such as that which Christ and his apostles led. . . .

IV. All mortal sins, and in particular all public and other disorders, which are contrary to God's law shall in every rank of life be duly and judiciously prohibited and destroyed by those whose office it is.

These articles, which contain the essence of the Hussite doctrine, were rejected by Sigismund, mainly through the influence of the papal legates, who considered them prejudicial to the authority of the Roman see. Hostilities therefore continued. Though Sigismund had retired from Prague, the castles of Vyšehrad and Hradčany remained in possession of his troops. The citizens of Prague laid siege to the Vyšehrad, and towards

the end of October (1420) the garrison was on the point of capitulating through famine. Sigismund attempted to relieve the fortress, but was decisively defeated by the Hussites on the 1st of November near the village of Pankrác. The castles of Vyšehrad and Hradčany now capitulated, and shortly afterwards almost all Bohemia fell into the hands of the Hussites. Internal troubles prevented them from availing themselves completely of their victory. At Prague a demagogue, the priest John of Želivo, for a time obtained almost unlimited authority over the lower classes of the townsman; and at Tabor a communistic movement (that of the so-called Adamites) was sternly suppressed by Žižka. Shortly afterwards a new crusade against the Hussites was undertaken. A large German army entered Bohemia, and in August 1421 laid siege to the town of Zatec (Saaz). The crusaders hoped to be joined in Bohemia by King Sigismund, but that prince was detained in Hungary. After an unsuccessful attempt to storm Zatec the crusaders retreated somewhat ingloriously, on hearing that the Hussite troops were approaching. Sigismund only arrived in Bohemia at the end of the year 1421. He took possession of the town of Kutna Hora (Kuttenberg), but was decisively defeated by Žižka at Německý Brod (Deutschbrod) on the 6th of January 1422. Bohemia was now again for a time free from foreign intervention, but internal discord again broke out caused partly by theological strife, partly by the ambition of agitators. John of Želivo was on the 9th of March 1422 arrested by the town council of Prague and decapitated. There were troubles at Tabor also, where a more advanced party opposed Žižka's authority. Bohemia obtained a temporary respite when, in 1422, Prince Sigismund Korybutovič of Poland became for a short time ruler of the country. His authority was recognized by the Utraquist nobles, the citizens of Prague, and the more moderate Taborites, including Žižka. Korybutovič, however, remained but a short time in Bohemia; after his departure civil war broke out, the Taborites opposing in arms the more moderate Utraquists, who at this period are also called by the chroniclers the "Praguers," as Prague was their principal stronghold. On the 27th of April 1423, Žižka now again leading, the Taborites defeated at Horic the Utraquist army under Čenek of Wartemberg; shortly afterwards an armistice was concluded at Konopišt.

Papal influence had meanwhile succeeded in calling forth a new crusade against Bohemia, but it resulted in complete failure. In spite of the endeavours of their rulers, the Slavs of Poland and Lithuania did not wish to attack the kindred Bohemians; the Germans were prevented by internal discord from taking joint action against the Hussites; and the king of Denmark, who had landed in Germany with a large force intending to take part in the crusade, soon returned to his own country. Free for a time from foreign aggression, the Hussites invaded Moravia, where a large part of the population favoured their creed; but, again paralysed by dissensions, soon returned to Bohemia. The city of Königgrätz (Králové Hradec), which had been under Utraquist rule, espoused the doctrine of Tabor, and called Žižka to its aid. After several military successes gained by Žižka (*q.v.*) in 1423 and the following year, a treaty of peace between the Hussites was concluded on the 13th of September 1424 at Liben, a village near Prague, now part of that city.

In 1426 the Hussites were again attacked by foreign enemies. In June of that year their forces, led by Prokop the Great—who took the command of the Taborites shortly after Žižka's death in October 1424—and Sigismund Korybutovič, who had returned to Bohemia, signally defeated the Germans at Aussig (Ústí nad Labem). After this great victory, and another at Tabor in 1427, the Hussites repeatedly invaded Germany, though they made no attempt to occupy permanently any part of the country.

The almost uninterrupted series of victories of the Hussites now rendered vain all hope of subduing them by force of arms. Moreover, the conspicuously democratic character of the Hussite movement caused the German princes, who were afraid that

such views might extend to their own countries, to desire peace. Many Hussites, particularly the Utraquist clergy, were also in favour of peace. Negotiations for this purpose were to take place at the oecumenical council which had been summoned to meet at Basel on the 3rd of March 1431. The Roman see reluctantly consented to the presence of heretics at this council, but indignantly rejected the suggestion of the Hussites that members of the Greek Church, and representatives of all Christian creeds, should also be present. Before definitely giving its consent to peace negotiations, the Roman Church determined on making a last effort to reduce the Hussites to subjection. On the 1st of August 1431 a large army of crusaders, under Frederick, margrave of Brandenburg, whom Cardinal Cesarini accompanied as papal legate, crossed the Bohemian frontier; on the 14th of August it reached the town of Domažlice (Tausis); but on the arrival of the Hussite army under Prokop the crusaders immediately took to flight, almost without offering resistance.

On the 15th of October the members of the council, who had already assembled at Basel, issued a formal invitation to the Hussites to take part in its deliberations. Prolonged negotiations ensued; but finally a Hussite embassy, led by Prokop and including John of Rokycan, the Taborite bishop Nicolas of Pelhřimov, the "English Hussite," Peter Payne and many others, arrived at Basel on the 4th of January 1433. It was found impossible to arrive at an agreement. Negotiations were not, however, broken off; and a change in the political situation of Bohemia finally resulted in a settlement. In 1434 war again broke out between the Utraquists and the Taborites. On the 30th of May of that year the Taborite army, led by Prokop the Great and Prokop the Less, who both fell in the battle, was totally defeated and almost annihilated at Lipan. The moderate party thus obtained the upper hand; and it formulated its demands in a document which was finally accepted by the Church of Rome in a slightly modified form, and which is known as "the compacts." The compacts, mainly founded on the articles of Prague, declare that:—

1. The Holy Sacrament is to be given freely in both kinds to all Christians in Bohemia and Moravia, and to those elsewhere who adhere to the faith of these two countries.
2. All mortal sins shall be punished and extirpated by those whose office it is so to do.
3. The word of God is to be freely and truthfully preached by the priests of the Lord, and by worthy deacons.
4. The priests in the time of the law of grace shall claim no ownership of worldly possessions.

On the 5th of July 1436 the compacts were formally accepted and signed at Iglau, in Moravia, by King Sigismund, by the Hussite delegates, and by the representatives of the Roman Church. The last-named, however, refused to recognize as archbishop of Prague, John of Rokycan, who had been elected to that dignity by the estates of Bohemia. The Utraquist creed, frequently varying in its details, continued to be that of the established church of Bohemia till all non-Roman religious services were prohibited shortly after the battle of the White Mountain in 1620. The Taborite party never recovered from its defeat at Lipan, and after the town of Tabor had been captured by George of Poděbrad in 1452 Utraquist religious worship was established there. The Bohemian brethren, whose intellectual originator was Peter Chelčický, but whose actual founders were Brother Gregory, a nephew of Archbishop Rokycan, and Michael, curate of Zamberk, to a certain extent continued the Taborite traditions, and in the 15th and 16th centuries included most of the strongest opponents of Rome in Bohemia. J. A. Komenský (Comenius), a member of the brotherhood, claimed for the members of his church that they were the genuine inheritors of the doctrines of Hus. After the beginning of the German Reformation many Utraquists adopted to a large extent the doctrines of Luther and Calvin; and in 1567 obtained the repeal of the compacts, which no longer seemed sufficiently far-reaching. From the end of the 16th century the inheritors of the Hussite tradition in Bohemia were included in the more general name of "Protestants" borne by the adherents of the Reformation.

All histories of Bohemia devote a large amount of space to the Hussite movement. See Count Lützw, *Bohemia; an Historical Sketch* (London, 1896); Palacky, *Geschichte von Böhmen*; Bachmann, *Geschichte Böhmens*; L. Krummel, *Geschichte der böhmischen Reformation* (Gotha, 1866); and *Utraquisten und Taboriten* (Gotha, 1871); Ernest Denis, *Huss et la guerre des Hussites* (Paris, 1878); H. Toman, *Husitské Valčnicko* (Prague, 1898). (L.)

**HUSTING** (O. Eng. *hústing*, from Old Norwegian *hústing*), the "thing" or "ting," i.e. assembly, of the household of personal followers or retainers of a king, earl or chief, contrasted with the "folkmoet," the assembly of the whole people. "Thing" meant an inanimate object, the ordinary meaning at the present day, also a cause or suit, and an assembly; a similar development of meaning is found in the Latin *res*. The word still appears in the names of the legislative assemblies of Norway, the *Storting* and of Iceland, the *Althing*. "Husting," or more usually in the plural "hustings," was the name of a court of the city of London. This court was formerly the county court for the city and was held before the lord mayor, the sheriffs and aldermen, for pleas of land, common pleas and appeals from the sheriffs. It had probate jurisdiction and wills were registered. All this jurisdiction has long been obsolete, but the court still sits occasionally for registering gifts made to the city. The charter of Canute (1032) contains a reference to "hustings" weights, which points to the early establishment of the court. It is doubtful whether courts of this name were held in other towns, but John Cowell (1554-1611) in his *Interpreter* (1601) s.v., "Hustings," says that according to Fleta there were such courts at Winchester, York, Lincoln, Sheppey and elsewhere, but the passage from Fleta, as the *New English Dictionary* points out, does not necessarily imply this (loc. iv. *Habel etiam Rex curiam in civitatibus . . . et in iocis . . . sicut in Hustingis London, Winton, &c.*). The ordinary use of "hustings" at the present day for the platform from which a candidate speaks at a parliamentary or other election, or more widely for a political candidate's election campaign, is derived from the application of the word, first to the platform in the Guildhall on which the London court was held, and next to that from which the public nomination of candidates for a parliamentary election was formerly made, and from which the candidate addressed the electors. The Ballot Act of 1872 did away with this public declaration of the nomination.

**HUSUM**, a town in the Prussian province of Schleswig-Holstein, in a fertile district 2½ m. inland from the North Sea, on the canalized Husumer Au, which forms its harbour and roadstead, 99 m. N.W. from Hamburg on a branch line from Tönning. Pop. (1900) 8268. It has steam communication with the North Frisian Islands (Nordstrand, Föhr and Sylt), and is a port for the cattle trade with England. Besides a ducal palace and park, it possesses an Evangelical church and a gymnasium. Cattle markets are held weekly, and in them, as also in cereals, a lively export trade is done. There are also extensive oyster fisheries, the property of the state, the yield during the season being very considerable. Husum is the birthplace of Johann Georg Forchhammer (1794-1865), the mineralogist, Peter Wilhelm Forchhammer (1801-1894), the archaeologist, and Theodore Storm (1817-1888), the poet, to the last of whom a monument has been erected here.

Husum is first mentioned in 1252, and its first church was built in 1431. Wisby rights were granted it in 1582, and in 1603 it received municipal privileges from the duke of Holstein. It suffered greatly from inundations in 1634 and 1717.

See Christiansen, *Die Geschichte Husums* (Husum, 1903); and Henningsen, *Das Stiftungsbuch der Stadt Husum* (Husum, 1904).

**HUTCHESON, FRANCIS** (1694-1746), English philosopher, was born on the 8th of August 1694. His birthplace was probably the townland of Drumalig, in the parish of Saintfield and county of Down, Ireland.<sup>1</sup> Though the family had sprung from Ayrshire, in Scotland, both his father and grandfather were ministers of dissenting congregations in the north of Ireland. Hutcheson was educated partly by his grandfather, partly at an academy, where according to his biographer, Dr Leechman, he was taught

<sup>1</sup> See *Belfast Magazine* for August 1813.

"the ordinary scholastic philosophy which was in vogue in those days." In 1710 he entered the university of Glasgow, where he spent six years, at first in the study of philosophy, classics and general literature, and afterwards in the study of theology. On quitting the university, he returned to the north of Ireland, and received a licence to preach. When, however, he was about to enter upon the pastorate of a small dissenting congregation he changed his plans on the advice of a friend and opened a private academy in Dublin. In Dublin his literary attainments gained him the friendship of many prominent inhabitants. Among these was Archbishop King (author of the *De origine mali*), who resisted all attempts to prosecute Hutcheson in the archbishop's court for keeping a school without the episcopal licence. Hutcheson's relations with the clergy of the Established Church, especially with the archbishops of Armagh and Dublin, Hugh Boulter (1672-1742) and William King (1650-1720), seem to have been most cordial, and his biographer, in speaking of "the inclination of his friends to serve him, the schemes proposed to him for obtaining promotion," &c., probably refers to some offers of preferment, on condition of his accepting episcopal ordination. These offers, however, were unavailing.

While residing in Dublin, Hutcheson published anonymously the four essays by which he is best known, namely, the *Inquiry concerning Beauty, Order, Harmony and Design*, the *Inquiry concerning Moral Good and Evil*, in 1725, the *Essay on the Nature and Conduct of the Passions and Affections and Illustrations upon the Moral Sense*, in 1728. The alterations and additions made in the second edition of these *Essays* were published in a separate form in 1726. To the period of his Dublin residence are also to be referred the *Thoughts on Laughter* (a criticism of Hobbes) and the *Observations on the Fable of the Bees*, being in all six letters contributed to *Hibernicus' Letters*, a periodical which appeared in Dublin (1725-1727, 2nd ed. 1734). At the end of the same period occurred the controversy in the *London Journal* with Gilbert Burnet (probably the second son of Dr Gilbert Burnet, bishop of Salisbury); on the "True Foundation of Virtue or Moral Goodness." All these letters were collected in one volume (Glasgow, 1772).

In 1729 Hutcheson succeeded his old master, Gershom Carmichael, in the chair of moral philosophy in the university of Glasgow. It is curious that up to this time all his essays and letters had been published anonymously, though their authorship appears to have been well known. In 1730 he entered on the duties of his office, delivering an inaugural lecture (afterwards published), *De naturalis hominum socialitate*. It was a great relief to him after the drudgery of school work to secure leisure for his favourite studies; "non levi iugiter lætitia commovebar cum aliam matrem Academiam me, sum olim alumnus, in libertatem assereis audiveram." Yet the works on which Hutcheson's reputation rests had already been published.

The remainder of his life he devoted to his professional duties. His reputation as a teacher attracted many young men, belonging to dissenting families, from England and Ireland, and he enjoyed a well-deserved popularity among both his pupils and his colleagues. Though somewhat quick-tempered, he was remarkable for his warm feelings and generous impulses. He was accused in 1738 before the Glasgow presbytery for "following two false and dangerous doctrines: first, that the standard of moral goodness was the promotion of the happiness of others; and second, that we could have a knowledge of good and evil without and prior to a knowledge of God" (Rae, *Life of Adam Smith*, 1895). The accusation seems to have had no result.

In addition to the works named, the following were published during Hutcheson's lifetime: a pamphlet entitled *Considerations on Patronage* (1735); *Philosophiæ moralis institutio compendiarum, ethices et jurisprudentiæ naturalis elementa continens, lib. iii.* (Glasgow, 1742); *Metaphysiæ synopsis ontologiam et pneumatologiam complectens* (Glasgow, 1742). The last work was published anonymously. After his death, his son

Francis Hutcheson (c. 1722-1773), author of a number of popular songs (e.g. "As Colin one evening," "Jolly Bacchus," "Where Weeping Yews"), published much the longest, though by no means the most interesting, of his works, *A System of Moral Philosophy, in Three Books* (2 vols., London, 1755). To this is prefixed a life of the author, by Dr William Leechman (1706-1785), professor of divinity in the university of Glasgow. The only remaining work assigned to Hutcheson is a small treatise on *Logic* (Glasgow, 1764). This compendium, together with the *Compendium of Metaphysics*, was republished at Strassburg in 1722.

Thus Hutcheson dealt with metaphysics, logic and ethics. His importance is, however, due almost entirely to his ethical writings, and among these primarily to the four essays and the letters published during his residence in Dublin. His standpoint has a negative and a positive aspect; he is in strong opposition to Thomas Hobbes and Bernard de Mandeville, and in fundamental agreement with Shaftesbury (Anthony Ashley Cooper, 3rd earl of Shaftesbury), whose name he very properly coupled with his own on the title-page of the first two essays. There are no two names, perhaps, in the history of English moral philosophy, which stand in a closer connexion. The analogy drawn between beauty and virtue, the functions assigned to the moral sense, the position that the benevolent feelings form an original and irreducible part of our nature, and the unhesitating adoption of the principle that the test of virtuous action is its tendency to promote the general welfare are obvious and fundamental points of agreement between the two authors.

I. *Ethics*.—According to Hutcheson, man has a variety of senses, internal as well as external, reflex as well as direct, the general definition of a sense being "any determination of our minds to receive ideas independently on our will, and to have perceptions of pleasure and pain" (*Essay on the Nature and Conduct of the Passions*, sect. 1). He does not attempt to give an exhaustive enumeration of these "senses," but, in various parts of his works, he specifies, besides the five external senses commonly recognized (which he rightly hints, might be added to),—(1) consciousness, by which each man has a perception of himself and of all that is going on in his own mind (*Metaph. Syn. pars i. cap. 2*); (2) the sense of beauty (sometimes called specifically "an internal sense"); (3) a public sense, or sensus communis, "a determination to be pleased with the happiness of others and to be uneasy at their misery"; (4) the moral sense, or "moral sense of beauty in actions and affections, by which we perceive virtue or vice, in ourselves or others"; (5) a sense of honour, or praise and blame, "which makes the approbation or censure of others the necessary occasion of pleasure, and their dislike, condemnation or resentment of injuries done by us the occasion of that uneasy sensation called shame"; (6) a sense of the ridiculous. It is plain, as the author confesses, that there may be "other perceptions, distinct from all these classes," and, in fact, there seems to be no limit to the number of "senses" in which a psychological division of this kind might result.

Of these "senses" that which plays the most important part in Hutcheson's ethical system is the "moral sense." It is this which pronounces immediately on the character of actions and affections, approving those which are virtuous, and disapproving those which are vicious. "His principal design," he says in the preface to the two first treatises, "is to show that human nature was not left quite indifferent in the affair of virtue, to form to itself observations concerning the advantage or disadvantage of actions, and accordingly to regulate its conduct. The weakness of our reason, and the avocations arising from the infirmity and necessities of our nature, are so great that very few men could ever have formed those long deductions of reasons which show some actions to be in the whole advantageous to the agent, and their contraries pernicious. The Author of nature has much better furnished us for a virtuous conduct than our moralists seem to imagine, by almost as quick and powerful instructions as we have for the preservation of our bodies. He has made virtue a lovely form, to excite our pursuit of it, and has given us strong affections to be the springs of each virtuous action." Passing over the appeal to final causes involved in this and similar passages, as well as the assumption that the "moral sense" has had no growth or history, but was "implanted" in man exactly in the condition in which it is now to be found among the more civilized races, an assumption common to the systems of both Hutcheson and Butler, it may be remarked that this use of the term "sense" has a tendency to obscure the real nature of the process which goes on in an act of moral judgment. For, as is so clearly established by Hume, this act really consists of two parts: one an act of deliberation, more or less prolonged, resulting in an intellectual judgment; the other a reflex feeling, probably instantaneous, of satisfaction at actions which we denote good, and of dissatisfaction at those which we denote bad. By the intellectual part of this process we refer the action or habit to a certain class; but no sooner is the intellectual process completed

than there is excited in us a feeling similar to that which myriads of actions and habits of the same class, or deemed to be of the same class, have excited in us on former occasions. Now, supposing the latter part of this process to be instantaneous, uniform and exempt from error, the former certainly is not. All mankind may, apart from their selfish interests, approve that which is virtuous or makes for the general good, but surely they entertain the most widely divergent opinions, and, therefore, arrive at directly opposite conclusions as to particular actions and habits. This obvious distinction is undoubtedly recognized by Hutcheson in his analysis of the mental process preceding moral action, nor does he invariably ignore it, even when treating of the moral approbation or disapprobation which is subsequent on action. None the less, it remains true that Hutcheson, both by his phraseology, and by the language in which he describes the process of moral approbation, has done much to favour that loose, popular view of morality which, ignoring the necessity of deliberation and reflection, encourages hasty resolves and unpremeditated judgments. The term "moral sense" (which, it may be noted, had already been employed by Shaftesbury, not only, as Dr Whewell appears to intimate, in the margin, but also in the text of his *Inquiry*), if invariably coupled with the term "moral judgment," would be open to little objection; but, taken alone, as designating the complex process of moral approbation, it is liable to lead not only to serious misapprehension but to grave practical errors. For, if each man's decisions are solely the result of an immediate intuition of the moral sense, why be at any pains to test, correct or review them? Or what is the use of those decisions are inflexible? And how do we account for differences in the moral decisions of different societies, and the observable changes in a man's own views? The expression has, in fact, the fault of most metaphorical terms: it leads to an exaggeration of the truth which it is intended to suggest.

But though Hutcheson usually describes the moral faculty as acting instinctively and immediately, he does not, like Butler, confound the moral faculty with the moral standard. The test or criterion of right action is with Hutcheson, as with Shaftesbury, its tendency to promote the general welfare of mankind. He thus anticipates the utilitarianism of Bentham—and not only in principle, but even in the use of the phrase "the greatest happiness for the greatest number" (*Inquiry concerning Moral Good and Evil*, sect. 3).

It is curious that Hutcheson did not realize the inconsistency of this external criterion with his fundamental ethical principle. Intuition has no possible connexion with an empirical calculation of results, and Hutcheson in adopting such a criterion practically denies his fundamental assumption.

As connected with Hutcheson's virtual adoption of the utilitarian standard may be noticed a kind of moral algebra, proposed for the purpose of "computing the morality of actions." This calculus occurs in the *Inquiry concerning Moral Good and Evil*, sect. 3.

The most distinctive of Hutcheson's ethical doctrines still remaining to be noticed is what has been called the "benevolent theory" of morals. Hobbes had maintained that all our actions, however disguised under apparent sympathy, have their roots in self-love. Hutcheson not only maintains that benevolence is the sole and direct source of many of our actions, but, by a not unnatural recoil, that it is the only source of those actions of which, on reflection, we approve. Consistently with this position, actions which flow from self-love only are pronounced to be morally indifferent. But surely, by the common consent of civilized men, prudence, temperance, cleanliness, industry, self-respect and, in general, the "personal virtues," are regarded, and rightly regarded, as fitting objects of moral approbation. This consideration could hardly escape any author, however wedded to his own system, and Hutcheson attempts to evade himself from the difficulty by laying down the position that a man may justly regard himself as a part of the rational system, and may thus "be, in part, an object of his own benevolence." (*Ibid.*)—a curious abuse of terms, which really concedes the question at issue. Moreover, he acknowledges that, though self-love does not merit approbation, neither, except in its extreme forms, does it merit condemnation, indeed the satisfaction of the dictates of self-love is one of the very conditions of the preservation of society. To press home the inconsistencies involved in these various statements would be a superfluous task.

The vexed question of liberty and necessity appears to be carefully avoided in Hutcheson's professedly ethical works. But, in the *Synopsis metaphysicæ*, he touches on it in three places, briefly stating both sides of the question, but evidently inclining to that which he designates as the opinion of the Stoics in opposition to that which he designates as the opinion of the Peripatetics. This is substantially the same as the doctrine propounded by Hobbes and Locke (to the latter of whom Hutcheson refers in a note), namely, that our will is determined by motives in conjunction with our general character and habit of mind, and that the only true liberty is the liberty of acting as we will, not that the will as we will. Though, however, his leaning is clear, he carefully avoids dogmatizing, and deprecates the angry controversies to which the speculations on this subject had given rise.

It is easy to trace the influence of Hutcheson's ethical theories on the systems of Hume and Adam Smith. The prominence given by these writers to the analysis of moral action and moral approbation,

with the attempt to discriminate the respective provinces of the reason and the emotions in these processes, is undoubtedly due to the influence of Hutcheson. To a study of the writings of Shaftesbury and Hutcheson we might, probably, in large measure, attribute the unequivocal adoption of the utilitarian standard by Hume, and, if this be the case, the name of Hutcheson connects itself, through Hume, with the names of Priestley, Feys and Bentham. Butler's *Sermons* appeared in 1726, the year after the publication of Hutcheson's two first essays, and the parallelism between the "conscience" of the one writer and the "moral sense" of the other is, at least, worthy of remark.

11. *Mental Philosophy*.—In the sphere of mental philosophy and logic Hutcheson's contributions are by no means so important or original as in that of moral philosophy. They are interesting mainly as a link between Locke and the Scottish school. In the former subject the influence of Locke is apparent throughout. All the main outlines of Locke's philosophy seem, at first sight, to be accepted as a matter of course. Thus, in stating his theory of the moral sense, Hutcheson is peculiarly careful to repudiate the doctrine of innate ideas (see, for instance, *Inquiry concerning Moral Good and Evil*, sect. 1 *ad fin.*, and sect. 4; and compare *Synopsis Metaphysicæ*, pars i. cap. 2). At the same time he shows more discrimination than does Locke in distinguishing between the two uses of this expression, and between the legitimate and illegitimate form of the doctrine (*Syn. Metaph.* pars i. cap. 2). All our ideas are, as by Locke, referred to external or internal sense, or, in other words, to sensation and reflection (see, for instance, *Syn. Metaph.* pars i. cap. 1; *Logicæ Compend.* pars i. cap. 1; *System of Moral Philosophy*, bk. i. ch. 1). It is, however, a most important modification of Locke's doctrine, and one which connects Hutcheson's mental philosophy with that of Reid, when he states that the ideas of extension, figure, motion and rest "are more properly ideas accompanying the sensations of sight and touch than the sensations of either of these senses"; that the idea of self accompanies every thought, and that the ideas of number, duration and existence accompany every other idea whatsoever (see *Essay on the Nature and Conduct of the Passions*, sect. i. art. 1; *Syn. Metaph.* pars i. cap. 1; *Syn. Metaph.* pars i. cap. 1; Hamilton on Reid, p. 124, note). Other important points in which Hutcheson follows the lead of Locke are his depreciation of the importance of the so-called laws of thought, his distinction between the primary and secondary qualities of bodies, the position that we cannot know the inmost essences of things ("intimæ rerum naturæ sive essentiæ"; though they excite various ideas in us, and the assumption that external things are known only through the medium of ideas (*Syn. Metaph.* pars i. cap. 1), though, at the same time, we are assured that we know the external world corresponding to these ideas. Hutcheson attempts to account for our assurance of the reality of an external world by referring it to a natural instinct (*Syn. Metaph.* pars i. cap. 1). Of the correspondence or similitude between our ideas of the primary qualities of things and the things themselves God alone can be assigned as the cause. This similitude has been effected by Him through a law of nature. "Hæc prima qualitatium primarium perceptio, sive mentis actio quadam sive passio dicitur, non alia similitudinibus aut convenientiæ inter eorummodi ideas et res ipsas esse assignat, aut notiones, quæ rebus presentibus excitantur, sint ipsas similes, aut saltem eorum habitudines, si non veras quantitates, depingant" (pars ii. cap. 1). Locke does speak of God "annexing" certain ideas to certain motions of bodies; but nowhere does he propound a theory so definite as that here propounded by Hutcheson, which reminds us at least as much of the speculations of Malebranche as of those of Locke.

Amongst the more important points in which Hutcheson diverges from Locke is his account of the idea of personal identity, which he appears to regard as a distinct sense, rather than as a mere consciousness. The distinction between body and mind, *corpus* or *materia* and *res cogitans*, is more emphatically accentuated by Hutcheson than by Locke. Generally, he speaks as if we had a direct consciousness of mind as distinct from body (see, for instance, *Syn. Metaph.* pars ii. cap. 3), though, in the posthumous work on *Moral Philosophy*, he expressly states that we know mind as we know body "by qualities immediately perceived though the substance of both be unknown" (bk. i. ch. 1). The distinction between perception proper and sensation proper, which occurs by implication though it is not explicitly worked out (see Hamilton's *Lectures on Metaphysics*, Lect. 24; Hamilton's edition of *Dugald Stewart's Works*, v. 420), the imperfection of the ordinary division of the external senses into five classes, the limitation of consciousness to a special mental faculty (severely criticized in Sir W. Hamilton's *Lectures on Metaphysics*, Lect. xii.) and the disposition to refer on disputed questions of philosophy so much to formal arguments as to the testimony of consciousness and our natural instincts are also amongst the points in which Hutcheson supplemented or departed from the philosophy of Locke. The last point, however, hardly fails to suggest the "common-sense philosophy" of Reid.

Thus, in estimating Hutcheson's position, we find that in particular questions he stands nearer to Locke, but in the general spirit of his philosophy he seems to approach more closely to his Scottish successors.

The short *Compendium of Logic*, which is more original than such

works usually are, is remarkable chiefly for the large proportion of psychological matter which it contains. In these parts of the book Hutcheson mainly follows Locke. The technicalities of the subject are passed lightly over, and the book is readable. It may be specially noticed that he distinguishes between the mental result and its verbal expression [idea—term; judgment—proposition], that he constantly employs the word "idea" and that he defines logical truth as "convenientia signorum cum rebus significatis" or "propositionis convenientia cum rebus ipsi," *Syn. Metaph.* pars i. cap 3), thus implicitly repudiating a merely formal view of logic.

III. *Aesthetics*.—Hutcheson may further be regarded as one of the earliest modern writers on aesthetics. His speculations on this subject are contained in the *Inquiry concerning Beauty, Order, Harmony and Design*, the first of the two treatises published in 1755. He maintains that we are endowed with a special sense which we perceive beauty, harmony and proportion. This is a *reflex* sense, because it presupposes the action of the external senses of sight and hearing. It may be called an internal sense, both in order to distinguish its perceptions from the mere perceptions of sight and hearing, and because "in some other affairs, where our external senses are not much concerned, we discern a sort of beauty, very like in many respects to that observed in sensible objects, and accompanied with like pleasure" (*Inquiry*, etc., sect. 1). The latter reason leads him to call attention to the beauty perceived in universal truths, in the operations of general laws, in moral principles and actions. Thus the analogy between beauty and virtue, which was a favorite topic with Shaftesbury, is prominent in the writings of Hutcheson also. Scattered up and down the treatise there are many important and interesting observations which our limits prevent us from noticing. But to the student of mental philosophy it may be specially interesting to remark that Hutcheson both applies the principle of association to explain our ideas of beauty and also sets limits to its application, insisting on there being "a natural power of perception or sense of beauty in objects, antecedent to all custom, education or example" (see *Inquiry*, etc., sects. 6, 7; Hamilton's *Lectures on Metaphysics*, Lect. 44 ad fin.).

Hutcheson's writings naturally gave rise to much controversy. To say nothing of minor opponents such as "Philarctus" (Gilbert Burnet, already alluded to), Dr John Balguy (1686-1748), prebendary of Salisbury, the author of two tracts on "The Foundation of Moral Goodness," and Dr John Taylor (1694-1761) of Norwich, a minister of considerable reputation in his time (author of *An Examination of the Scheme of Morality advanced by Dr Hutcheson*), the essays appear to have suggested, by antipathy, at least two works which hold a permanent place in the literature of English ethics—Butler's *Dissertation on the Nature of Virtue*, and Richard Price's *Treatise of Moral Good and Evil* (1757). In this latter work the author maintains, in opposition to Hutcheson, that actions are in themselves right or wrong, that right and wrong are simple ideas incapable of analysis, and that these ideas are perceived immediately by the understanding. We thus see that, not only directly but also through the replies which it called forth, the system of Hutcheson, or at least the system of Hutcheson combined with that of Shaftesbury, contributed, in large measure, to the formation and development of some of the most important of the modern schools of ethics (see especially art. ETHICS).

AUTHORITIES.—Notices of Hutcheson occur in most histories, both of general philosophy and of moral philosophy, as, for instance, in pt. vii. of Adam Smith's *Theory of Moral Sentiments*; Mackintosh's *Progress of Ethical Philosophy*; Cousin, *Cours d'histoire de la philosophie morale du XVIII<sup>e</sup> siècle*; Whewell's *Lectures on the History of Moral Philosophy in England*; A. Bain's *Mental and Moral Science*; Neal's *Porter's Appendix to the English translation of Ueberweg's History of Philosophy*; Sir Leslie Stephen's *History of English Thought in the Eighteenth Century*, &c. See also Martineau, *Types of Ethical Theory* (London, 1902); W. R. Scott, *Francis Hutcheson* (Cambridge, 1900); Albee, *History of English Utilitarianism* (London, 1902); T. Fowler, *Shaftesbury and Hutcheson* (London, 1882); J. McCosh, *Scottish Philosophy* (New York, 1874). Of Dr Leechman's *Biography of Hutcheson* we have already spoken. J. Veitch gives an interesting account of his professional work in *Glasgow, Mind*, ii. 209-212. (T. F., X.)

**HUTCHINSON, ANNE** (c. 1600-1643), American religious enthusiast, leader of the "Antinomians" in New England, was born in Lincolnshire, England, about 1600. She was the daughter of a clergyman named Francis Marbury, and, according to tradition, was a cousin of John Dryden. She married William Hutchinson, and in 1634 emigrated to Boston, Massachusetts, as a follower and admirer of the Rev. John Cotton. Her orthodoxy was suspected and for a time she was not admitted to the church, but soon she organized meetings among the Boston women, among whom her exceptional ability and her services as a nurse had given her great influence; and at these meetings she discussed and commented upon recent sermons and gave expression to her own theological views. The meetings became increasingly popular, and were soon attended not only by the women but

even by some of the ministers and magistrates, including Governor Henry Vane. At these meetings she asserted that she, Cotton and her brother-in-law, the Rev. John Wheelwright—whom she was trying to make second "teacher" in the Boston church—were under a "covenant of grace," that they had a special inspiration, a "peculiar indwelling of the Holy Ghost," whereas the Rev. John Wilson, the pastor of the Boston church, and the other ministers of the colony were under a "covenant of works." Anne Hutchinson was, in fact, voicing a protest against the legalism of the Massachusetts Puritans, and was also striking at the authority of the clergy in an intensely theocratic community. In such a community a theological controversy inevitably was carried into secular politics, and the entire colony was divided into factions. Mrs Hutchinson was supported by Governor Vane, Cotton, Wheelwright and the great majority of the Boston church; opposed to her were Deputy-Governor John Winthrop, Wilson and all of the country magistrates and churches. At a general fast, held late in January 1637, Wheelwright preached a sermon which was taken as a criticism of Wilson and his friends. The strength of the parties was tested at the General Court of Election of May 1637, when Winthrop defeated Vane for the governorship. Cotton recanted, Vane returned to England in disgust, Wheelwright was tried and banished and the rank and file either followed Cotton in making submission or suffered various minor punishments. Mrs Hutchinson was tried (November 1637) by the General Court chiefly for "trading the ministers," and was sentenced to banishment; later, in March 1638, she was tried before the Boston church and was formally excommunicated. With William Coddington (d. 1678), John Clarke and others, she established a settlement on the island of Aquidneck (now Rhode Island) in 1638. Four years later, after the death of her husband, she settled on Long Island Sound near what is now New Rochelle, Westchester county, New York, and was killed in an Indian rising in August 1643, an event regarded in Massachusetts as a manifestation of Divine Providence. Anne Hutchinson and her followers were called "Antinomians," probably more as a term of reproach than with any special reference to her doctrinal theories; and the controversy in which she was involved is known as the "Antinomian Controversy."

See C. F. Adams, *Antinomianism in the Colony of Massachusetts Bay*, vol. xiv. of the Prince Society Publications (Boston, 1894); and *Three Episodes of Massachusetts History* (Boston and New York, 1896).

**HUTCHINSON, JOHN** (1615-1664), Puritan soldier, son of Sir Thomas Hutchinson of Othorpe, Nottinghamshire, and of Margaret, daughter of Sir John Byron of Newstead, was baptized on the 18th of September 1615. He was educated at Nottingham and Lincoln schools and at Peterhouse, Cambridge, and in 1637 he entered Lincoln's Inn. On the outbreak of the great Rebellion he took the side of the Parliament, and was made in 1643 governor of Nottingham Castle, which he defended against external attacks and internal divisions, till the triumph of the parliamentary cause. He was chosen member for Nottinghamshire in March 1646, took the side of the Independents, opposed the offers of the king at Newport, and signed the death-warrant. Though a member at first of the council of state, he disapproved of the subsequent political conduct of Cromwell and took no further part in politics during the lifetime of the protector. He resumed his seat in the recalled Long Parliament in May 1659, and followed Monk in opposing Lambert, believing that the former intended to maintain the commonwealth. He was returned to the Convention Parliament for Nottingham but expelled on the 9th of June 1660, and while not excepted from the Act of Indemnity was declared incapable of holding public office. In October 1663, however, he was arrested upon suspicion of being concerned in the Yorkshire plot, and after a rigorous confinement in the Tower of London, of which he published an account (reprinted in the Harleian *Miscellany*, vol. iii.), and in Sandown Castle, Kent, he died on the 11th of September 1664. His career draws its chief interest from the *Life* by his wife, Lucy, daughter of Sir Allen Apsley, written



after the death of her husband but not published till 1806 (since often reprinted), a work not only valuable for the picture which it gives of the man and of the time in which he lived, but for the simple beauty of its style, and the naïveté with which the writer records her sentiments and opinions, and details the incidents of her private life.

See the edition of Lucy Hutchinson's *Memoirs of the Life of Colonel Hutchinson* by C. H. Firth (1885); *Brit. Mus. Add. MSS.* 25,901 (a fragment of the *Life*), also *Add. MSS.* 19, 333, 36,247 f. 51; *Notes and Queries*, 7, ser. iii, 25, viii, 422; *Monk's Contemporaries*, by Guizot.

**HUTCHINSON, JOHN** (1674-1737), English theological writer, was born at Spennithorne, Yorkshire, in 1674. He served as steward in several families of position, latterly in that of the duke of Somerset, who ultimately obtained for him the post of riding purveyor to the master of the horse, a secure worth about £200 a year. In 1700 he became acquainted with Dr John Woodward (1665-1728) physician to the duke and author of a work entitled *The Natural History of the Earth*, to whom he entrusted a large number of fossils of his own collecting, along with a mass of manuscript notes, for arrangement and publication. A misunderstanding as to the manner in which these should be dealt with was the immediate occasion of the publication by Hutchinson in 1724 of *Moses's Principia*, part i., in which Woodward's *Natural History* was bitterly ridiculed, his conduct with regard to the mineralogical specimens not obscurely characterized, and a refutation of the Newtonian doctrine of gravitation seriously attempted. It was followed by part ii. in 1727, and by various other works, including *Moses's Sine Principio*, 1730; *The Confusion of Tongues and Trinity of the Gentiles*, 1731; *Power Essential and Mechanical, or what power belongs to God and what to his creatures, in which the design of Sir I. Newton and Dr Samuel Clarke is laid open*, 1732; *Glory or Gravity*, 1733; *The Religion of Satan, or Antichrist Delineated*, 1736. He taught that the Bible contained the elements not only of true religion but also of all rational philosophy. He held that the Hebrew must be read without points, and his interpretation rested largely on fanciful symbolism. Bishop George Horne of Norwich was during some of his earlier years an avowed Hutchinsonian; and William Jones of Nayland continued to be so to the end of his life.

A complete edition of his publications, edited by Robert Spearman and Julius Bate, appeared in 1748 (12 vols.); an *Abstract* of these followed in 1753; and a *Supplement*, with *Life* by Spearman prefixed, in 1765.

**HUTCHINSON, SIR JONATHAN** (1828- ), English surgeon and pathologist, was born on the 23rd of July 1828 at Selby, Yorkshire, his parents belonging to the Society of Friends. He entered St Bartholomew's Hospital, became a member of the Royal College of Surgeons in 1850 (F.R.C.S. 1862), and rapidly gained reputation as a skillful operator and a scientific inquirer. He was president of the Hunterian Society in 1869 and 1870, professor of surgery and pathology at the College of Surgeons from 1877 to 1882, president of the Pathological Society, 1879-1880, of the Ophthalmological Society, 1883, of the Neurological Society, 1887, of the Medical Society, 1890, and of the Royal Medical and Chirurgical in 1894-1896. In 1889 he was president of the Royal College of Surgeons. He was a member of two Royal Commissions, that of 1881 to inquire into the provision for smallpox and fever cases in the London hospitals, and that of 1889-1896 on vaccination and leprosy. He also acted as honorary secretary to the Sydenham Society. His activity in the cause of scientific surgery and in advancing the study of the natural sciences was unwearying. His lectures on neuropathogenesis, gout, leprosy, diseases of the tongue, &c., were full of original observation; but his principal work was connected with the study of syphilis, on which he became the first living authority. He was the founder of the London Polytechnic or Postgraduate School of Medicine; and both in his native town of Selby and at Haslemere, Surrey, he started (about 1890) educational museums for popular instruction in natural history. He published several volumes on his own subjects, was editor of the quarterly *Archives of Surgery*, and was given the Hon. LL.D.

degree by both Glasgow and Cambridge. After his retirement from active consultative work he continued to take great interest in the question of leprosy, asserting the existence of a definite connexion between this disease and the eating of salted fish. He received a knighthood in 1908.

**HUTCHINSON, THOMAS** (1711-1780), the last royal governor of the province of Massachusetts, son of a wealthy merchant of Boston, Mass., was born there on the 9th of September 1711. He graduated at Harvard in 1727, then became an apprentice in his father's counting-room, and for several years devoted himself to business. In 1737 he began his public career as a member of the Boston Board of Selectmen, and a few weeks later he was elected to the General Court of Massachusetts Bay, of which he was a member until 1740 and again from 1742 to 1749, serving as speaker in 1747, 1748 and 1749. He consistently contended for a sound financial system, and vigorously opposed the operations of the "Land Bank" and the issue of pernicious bills of credit. In 1748 he carried through the General Court a bill providing for the cancellation and redemption of the outstanding paper currency. Hutchinson went to England in 1740 as the representative of Massachusetts in a boundary dispute with New Hampshire. He was a member of the Massachusetts Council from 1740 to 1756, was appointed judge of probate in 1752 and was chief justice of the superior court of the province from 1761 to 1769, was lieutenant-governor from 1758 to 1771, acting as governor in the latter two years, and from 1771 to 1774 was governor. In 1754 he was a delegate from Massachusetts to the Albany Convention, and, with Franklin, was a member of the committee appointed to draw up a plan of union. Though he recognized the legality of the Stamp Act of 1765, he considered the measure inexpedient and impolitic and urged its repeal, but his attitude was misunderstood; he was considered by many to have instigated the passage of the Act, and in August 1765 a mob sacked his Boston residence and destroyed many valuable manuscripts and documents. He was acting governor at the time of the "Boston Massacre" in 1770, and was virtually forced by the citizens of Boston, under the leadership of Samuel Adams, to order the removal of the British troops from the town. Throughout the pre-Revolutionary disturbances in Massachusetts he was the representative of the British ministry, and though he disapproved of some of the ministerial measures he felt impelled to enforce them and necessarily incurred the hostility of the Whig or Patriot element. In 1774, upon the appointment of General Thomas Gage as military governor he went to England, and acted as an adviser to George III. and the British ministry on American affairs, uniformly counselling moderation. He died at Brompton, now part of London, on the 3rd of June 1780.

He wrote *A Brief Statement of the Claim of the Colonies* (1764); a *Collection of Original Papers relative to the History of Massachusetts Bay* (1769), reprinted as *The Hutchinson Papers* by the Prince Society in 1865; and a judicious, accurate and very valuable *History of the Province of Massachusetts Bay* (vol. i., 1764, vol. ii., 1767, and vol. iii., 1828). His *Diary and Letters, with an Account of his Administration*, was published at Boston in 1884-1886.

See James K. Hosmer's *Life of Thomas Hutchinson* (Boston, 1896), and a biographical chapter in John Fiske's *Essays Historical and Literary* (New York, 1902). For an estimate of Hutchinson as an historian, see M. C. Tyler's *Literary History of the American Revolution* (New York, 1897).

**HUTCHINSON**, a city and the county-seat of Reno county, Kansas, U.S.A., in the broad bottom-land on the N. side of the Arkansas river. Pop. (1900) 9379, of whom 414 were foreign-born and 442 negroes; (1910 census) 16,364. It is served by the Atchison, Topeka & Santa Fé, the Missouri Pacific and the Chicago, Rock Island & Pacific railways. The principal public buildings are the Federal building and the county court house. The city has a public library, and an industrial reformatory is maintained here by the state. Hutchinson is situated in a stock-raising, fruit-growing and farming region (the principal products of which are wheat, Indian corn and fodder), with which it has a considerable wholesale trade. An enormous deposit of rock salt underlies the city and its vicinity,

and Hutchinson's principal industry is the manufacture (by the open-pan and grainer processes) and the shipping of salt; the city has one of the largest salt plants in the world. Among the other manufactures are flour, creamery products, sodash, straw-board, planing-mill products and packed meats. Natural gas is largely used as a factory fuel. The city's factory product was valued at \$2,031,048 in 1905, an increase of 31.8% since 1900. Hutchinson was chartered as a city in 1871.

**HUTTEN, PHILIPP VON** (c. 1511-1546), German knight, was a relative of Ulrich von Hutten and passed some of his early years at the court of the emperor Charles V. Later he joined the band of adventurers which under George Hohermuth, or George of Spires, sailed to Venezuela, or Venosala as Hutten calls it, with the object of conquering and exploiting this land in the interests of the Augsburg family of Welsler. The party landed at Coro in February 1535 and Hutten accompanied Hohermuth on his long and toilsome expedition into the interior in search of treasure. After the death of Hohermuth in December 1540 he became captain-general of Venezuela. Soon after this event he vanished into the interior, returning after five years of wandering to find that a Spaniard, Juan de Caravazil, or Caravajil, had been appointed governor in his absence. With his travelling companion, Bartholomew Welsler the younger, he was seized by Caravazil in April 1546 and the two were afterwards put to death.

Hutten left some letters, and also a narrative of the earlier part of his adventures, this *Zeitung aus India Junkher Philipps von Hutten* being published in 1785.

**HUTTEN, ULRICH VON** (1488-1523), was born on the 21st of April 1488, at the castle of Steckelberg, near Fulda, in Hesse. Like Erasmus or Pirckheimer, he was one of those men who form the bridge between Humanists and Reformers. He lived with both, sympathized with both, though he died before the Reformation had time fully to develop. His life may be divided into four parts:—his youth and cloister-life (1488-1504); his wanderings in pursuit of knowledge (1504-1515); his strife with Ulrich of Württemberg (1515-1519); and his connexion with the Reformation (1519-1523). Each of these periods had its own special antagonism, which coloured Hutten's career: in the first, his horror of dull monastic routine; in the second, the ill-treatment he met with at Greifswald; in the third, the crime of Duke Ulrich; in the fourth, his disgust with Rome and with Erasmus. He was the eldest son of a poor and not undistinguished knightly family. As he was mean of stature and sickly his father destined him for the cloister, and he was sent to the Benedictine house at Fulda; the thirst for learning there seized on him, and in 1505 he fled from the monastic life, and won his freedom with the sacrifice of his worldly prospects, and at the cost of incurring his father's undying anger. From the Fulda cloister he went first to Cologne, next to Erfurt, and then to Frankfurt-on-Oder on the opening in 1506 of the new university of that town. For a time he was in Leipzig, and in 1508 we find him a shipwrecked beggar on the Pomeranian coast. In 1509 the university of Greifswald welcomed him, but here too those who at first received him kindly became his foes; the sensitive ill-regulated youth, who took the liberties of genius, wearied his burgher patrons; they could not brook the poet's airs and vanity, and ill-timed assertions of his higher rank. Wherefore he left Greifswald, and as he went was robbed of clothes and books, his only baggage, by the servants of his late friends; in the dead of winter, half starved, frozen, penniless, he reached Rostock. Here again the Humanists received him gladly, and under their protection he wrote against his Greifswald patrons, thus beginning the long list of his satires and fierce attacks on personal or public foes. Rostock could not hold him long; he wandered on to Wittenberg and Leipzig, and thence to Vienna, where he hoped to win the emperor Maximilian's favour by an elaborate national poem on the war with Venice. But neither Maximilian nor the university of Vienna would lift a hand for him, and he passed into Italy, where, at Pavia, he sojourned throughout 1511 and part of 1512. In the latter year his studies were interrupted by war; in the siege of Pavia

by papal troops and Swiss, he was plundered by both sides, and escaped, sick and penniless, to Bologna; on his recovery he even took service as a private soldier in the emperor's army.

This dark period lasted no long time; in 1514 he was again in Germany, where, thanks to his poetic gifts and the friendship of Eitelwolf von Stein (d. 1515), he won the favour of the elector of Mainz, Archbishop Albert of Brandenburg. Here high dreams of a learned career rose on him; Mainz should be made the metropolis of a grand Humanist movement, the centre of good style and literary form. But the murder in 1515 of his relative Hans von Hutten by Ulrich, duke of Württemberg, changed the whole course of his life; satire, chief refuge of the weak, became Hutten's weapon; with one hand he took his part in the famous *Epistolae obscurorum virorum*, and with the other launched scathing letters, eloquent Ciceronian orations, or biting satires against the duke. Though the emperor was too lazy and indifferent to smite a great prince, he took Hutten under his protection and bestowed on him the honour of a laureate crown in 1517. Hutten, who had meanwhile revisited Italy, again attached himself to the electoral court at Mainz; and he was there when in 1518 his friend Pirckheimer wrote, urging him to abandon the court and dedicate himself to letters. We have the poet's long reply, in an epistle on his "way of life," an amusing mixture of earnestness and vanity, self-satisfaction and satire; he tells his friend that his career is just begun, that he has had twelve years of wandering, and will now enjoy himself a while in patriotic literary work; that he has by no means deserted the humaner studies, but carries with him a little library of standard books. Pirckheimer in his burgher life may have ease and even luxury; he, a knight of the empire, how can he condescend to obscurity? He must abide where he can shine.

In 1519 he issued in one volume his attacks on Duke Ulrich, and then, drawing sword, took part in the private war which overthrew that prince; in this affair he became intimate with Franz von Sickingen, the champion of the knightly order (Ritterstand). Hutten now warmly and openly espoused the Lutheran cause, but he was at the same time mixed up in the attempt of the "Ritterstand" to assert itself as the militia of the empire against the independence of the German princes. Soon after this time he discovered at Fulda a copy of the manifesto of the emperor Henry IV. against Hildebrand, and published it with comments as an attack on the papal claims over Germany. He hoped thereby to interest the new emperor Charles V., and the higher orders in the empire, in behalf of German liberties; but the appeal failed. What Luther had achieved by speaking to cities and common folk in homely phrase, because he touched heart and conscience, that the far finer weapons of Hutten failed to effect, because he tried to touch the more cultivated sympathies and dormant patriotism of princes and bishops, nobles and knights. And so he at once gained an undying name in the republic of letters and ruined his own career. He showed that the artificial verse-making of the Humanists could be connected with the new outburst of genuine German poetry. The Minnesinger was gone; the new national singer, a Luther or a Hans Sachs, was heralded by the stirring lines of Hutten's pen. These have in them a splendid natural swing and ring, strong and patriotic, though unfortunately addressed to knight and landsknecht rather than to the German people.

The poet's high dream of a knightly national regeneration had a rude awakening. The attack on the papacy, and Luther's vast and sudden popularity, frightened Elector Albert, who dismissed Hutten from his court. Hoping for imperial favour, he betook himself to Charles V.; but that young prince would have none of him. So he returned to his friends, and they rejoiced greatly to see him still alive; for Pope Leo X. had ordered him to be arrested and sent to Rome, and assassins dogged his steps. He now attached himself more closely to Franz von Sickingen and the knightly movement. This also came to a disastrous end in the capture of the Ebernberg, and Sickingen's death; the higher nobles had triumphed; the archbishops avenged themselves on Lutheranism as interpreted

by the knightly order. With Sickinger Hutten also finally fell. He fled to Basel, where Erasmus refused to see him, both for fear of his loathsome diseases, and also because the beggared knight was sure to borrow money from him. A paper was consequently broke out between the two Humanists, which embittered Hutten's last days, and stained the memory of Erasmus. From Basel Ulrich dragged himself to Mülhausen; and when the vengeance of Erasmus drove him thence, he went to Zurich. There the large heart of Zwingli welcomed him; he helped him with money, and found him a quiet refuge with the pastor of the little isle of Utnau on the Zurich lake. There the frail and worn-out poet, writing swift satire to the end, died at the end of August or beginning of September 1523 at the age of thirty-five. He left behind him some debts due to compassionate friends; he did not even own a single book, and all his goods amounted to the clothes on his back, a bundle of letters, and that valiant pen which had fought so many a sharp battle, and had won for the poor knight-errant a sure place in the annals of literature.

Ulrich von Hutten is one of those men of genius at whom propriety is shocked, and whom the mean-spirited avoid. Yet through his short and buffeted life he was befriended, with wonderful charity and patience, by the chief leaders of the Humanist movement. For, in spite of his irritable vanity, his immoral life and habits, his odious diseases, his painful restlessness, Hutten had much in him that strong men could love. He passionately loved the truth, and was ever open to all good influences. He was a patriot, whose soul soared to ideal schemes and a grand utopian restoration of his country. In spite of all, his was a frank and noble nature; his faults chiefly the faults of genius ill-controlled, and of a life cast in the eventful changes of an age of novelty. A swarm of writings issued from his pen; at first the smooth elegance of his Latin prose and verse seemed strangely to miss his real character; he was the Cicero and Ovid of Germany before he became its Lucian.

His chief works were his *Ars versificandi* (1511); the *Nemo* (1518); a work on the *Morbis Gallicis* (1519); the volume of Steckelberg complaints against Duke Ulrich (including his four *Ciceronian Orations*, his *Letters* and the *Phalarismus*) also in 1519; the *Vadismus* (1520); and the controversy with Erasmus at the end of his life. Besides these were many admirable poems in Latin and German. It is not known with certainty how far Hutten was the parent of the celebrated *Epistolae obscurorum virorum*, that famous satire on monastic ignorance as represented by the theologians of Cologne with which the friends of Reuchlin defended him. At first the cloister-world, not discerning its irony, welcomed the work as a defence of their position; though their eyes were soon opened by the favour with which the learned world received it. The *Epistolae* were eagerly bought up; the first part (41 letters) appeared at the end of 1515; early in 1516 there was a second edition; later in 1516 a third, with an appendix of seven letters; in 1517 appeared the second part (62 letters), to which a fresh appendix of eight letters was subjoined soon after. In 1909 the Latin text of the *Epistolae* with an English translation was published by F. G. Stokes. Hutten, in a letter addressed to Robert Crocus, denied that he was the author of the book, but there is no doubt as to his connexion with it. Erasmus was of opinion that there were three authors, of whom Crocus Rubianus was the originator of the idea, and Hutten a chief contributor. D. F. Strauss, who dedicates to the subject a chapter of his admirable work on Hutten, concludes that he had no share in the first part, but that his hand is clearly visible in the second part, which he attributes in the main to him. To him is due the more serious and severe tone of that bitter portion of the satire. See W. Brecht, *Die Verfasser der Epistolae obscurorum virorum* (1904).

For a complete catalogue of the writings of Hutten, see E. Böcking's *Index Bibliographicus Huttenianus* (1858). Böcking is also the editor of the complete edition of his works (7 vols., 1829-1862). A selection of Hutten's German writings, edited by G. Balke, appeared in 1891. Cp. S. Szantowski, *Hutten's deutsche Schriften* (1891). The best biography (though it is also somewhat of a political pamphlet) is that of D. F. Strauss (*Ulrich von Hutten*, 1857; 4th ed., 1878; English translation by G. Sturge, 1874), with which may be compared the older monographs by A. Wagenseil (1823), A. Birck (1846) and J. Zeller (Paris, 1849). See also J. Deckert, *Ulrich von Hutten's Leben und Wirken. Eine historische Skizze* (1901).

**HUTTER, LEONHARD** (1563-1616), German Lutheran theologian, was born at Nellingen near Ulm in January 1563. From 1581 he studied at the universities of Strassburg, Leipzig,

Heidelberg and Jena. In 1594 he began to give theological lectures at Jena, and in 1596 accepted a call as professor of theology at Wittenberg, where he died on the 23rd of October 1616. Hutten was a stern champion of Lutheran orthodoxy, as set down in the confessions and embodied in his own *Compendium locorum theologicorum* (1610; reprinted 1863), being so faithful to his master as to win the title of "Luther redonatus."

In reply to Rudolf Hospinian's *Concordia discors* (1607), he wrote a work, rich in historical material but one-sided in its apologetics, *Concordia concors* (1614), defending the formula of Concord, which he regarded as inspired. His *Irenicum vae christianum* is directed against David Pareus (1548-1622), professor primarius at Heidelberg, who in *Irenicum sive de unione et synodo Evangelicorum* (1614) had pleaded for a reconciliation of Lutheranism and Calvinism; his *Calvinista antipoliticus* (1610) was written against the "damnable Calvinism" which was becoming prevalent in Holstein and Brandenburg. Another work, based on the formula of Concord, was entitled *Loci communes theologici*.

**HUTTON, CHARLES** (1737-1823), English mathematician, was born at Newcastle-on-Tyne on the 14th of August 1737. He was educated in a school at Jesmond, kept by Mr Ivison, a clergyman of the church of England. There is reason to believe, on the evidence of two pay-bills, that for a short time in 1755 and 1756 Hutton worked in Old Long Benton colliery; at any rate, on Ivison's promotion to a living, Hutton succeeded to the Jesmond school, whence, in consequence of increasing pupils, he removed to Stote's Hall. While he taught during the day at Stote's Hall, he studied mathematics in the evening at a school in Newcastle. In 1766 he married, and began tuition on a larger scale in Newcastle, where he had among his pupils John Scott, afterwards Lord Eldon, chancellor of England. In 1764 he published his first work, *The Schoolmaster's Guide, or a Complete System of Practical Arithmetic*, which in 1770 was followed by his *Treatise on Mensuration both in Theory and Practice*. In 1772 appeared a tract on *The Principles of Bridges*, suggested by the destruction of Newcastle bridge by a high flood on the 17th of November 1771. In 1773 he was appointed professor of mathematics at the Royal Military Academy, Woolwich, and in the following year he was elected F.R.S. and reported on Nevil Maskelyne's determination of the mean density and mass of the earth from measurements taken in 1774-1776 at Mount Schiehallion in Perthshire. This account appeared in the *Philosophical Transactions* for 1778, was afterwards reprinted in the second volume of his *Tracts on Mathematical and Philosophical Subjects*, and procured for Hutton the degree of LL.D. from the university of Edinburgh. He was elected foreign secretary to the Royal Society in 1779, but his resignation in 1783 was brought about by the president Sir Joseph Banks, whose behaviour to the mathematical section of the society was somewhat high-handed (see Kippis's *Observations on the late Contents in the Royal Society*, London, 1784). After his *Tables of the Products and Powers of Numbers*, 1781, and his *Mathematical Tables*, 1785, he issued, for the use of the Royal Military Academy, in 1787 *Elements of Conic Sections*, and in 1798 his *Course of Mathematics*. His *Mathematical and Philosophical Dictionary*, a valuable contribution to scientific biography, was published in 1795 (2nd ed., 1815), and the four volumes of *Recreations in Mathematics and Natural Philosophy*, mostly a translation from the French, in 1803. One of the most laborious of his works was the abridgment, in conjunction with G. Shaw and R. Pearson, of the *Philosophical Transactions*. This undertaking, the mathematical and scientific parts of which fell to Hutton's share, was completed in 1809, and filled eighteen volumes quarto. His name first appears in the *Ladies' Diary* (a poetical and mathematical almanac which was begun in 1704, and lasted till 1871) in 1764; ten years later he was appointed editor of the almanac, a post which he retained till 1817. Previously he had begun a small periodical, *Miscellanea Mathematica*, which extended only to thirteen numbers; subsequently he published in five volumes *The Diarian Miscellany*, which contained large extracts from the *Diary*. He resigned his professorship in 1807, and died on the 27th of January 1823.

See John Bruce, *Charles Hutton* (Newcastle, 1823).

**HUTTON, JAMES** (1726-1797), Scottish geologist, was born in Edinburgh on the 3rd of June 1726. Educated at the high school and university of his native city, he acquired while a student a passionate love of scientific inquiry. He was apprenticed to a lawyer, but his employer advised that a more congenial profession should be chosen for him. The young apprentice chose medicine as being nearest akin to his favourite pursuit of chemistry. He studied for three years at Edinburgh, and completed his medical education in Paris, returning by the Low Countries, and taking his degree of doctor of medicine at Leiden in 1749. Finding, however, that there seemed hardly any opening for him, he abandoned the medical profession, and, having inherited a small property in Berwickshire from his father, resolved to devote himself to agriculture. He then went to Norfolk to learn the practical work of farming, and subsequently travelled in Holland, Belgium and the north of France. During these years he began to study the surface of the earth, gradually shaping in his mind the problem to which he afterwards devoted his energies. In the summer of 1754 he established himself on his own farm in Berwickshire, where he resided for fourteen years, and where he introduced the most improved forms of husbandry. As the farm was brought into excellent order, and as its management, becoming more easy, grew less interesting, he was induced to let it, and establish himself for the rest of his life in Edinburgh. This took place about the year 1768. He was unmarried, and from this period until his death in 1797 he lived with his three sisters. Surrounded by congenial literary and scientific friends he devoted himself to research.

At that time geology in any proper sense of the term did not exist. Mineralogy, however, had made considerable progress. But Hutton had conceived larger ideas than were entertained by the mineralogists of his day. He desired to trace back the origin of the various minerals and rocks, and thus to arrive at some clear understanding of the history of the earth. For many years he continued to study the subject. At last, in the spring of the year 1785, he communicated his views to the recently established Royal Society of Edinburgh in a paper entitled *Theory of the Earth, or an Investigation of the Laws Observable in the Composition, Dissolution and Restoration of Land upon the Globe*. In this remarkable work the doctrine is expounded that geology is not cosmogony, but must confine itself to the study of the materials of the earth; that everywhere evidence may be seen that the present rocks of the earth's surface have been in great part formed out of the waste of older rocks; that these materials having been laid down under the sea were there consolidated under great pressure, and were subsequently disrupted and upheaved by the expansive power of subterranean heat; that during these convulsions veins and masses of molten rock were injected into the rents of the dislocated strata; that every portion of the upraised land, as soon as exposed to the atmosphere, is subject to decay; and that this decay must tend to advance until the whole of the land has been worn away and laid down on the sea-floor, whence future upheavals will once more raise the consolidated sediments into new land. In some of these broad and bold generalizations Hutton was anticipated by the Italian geologists; but to him belongs the credit of having first perceived their mutual relations, and combined them in a luminous coherent theory based upon observation.

It was not merely the earth to which Hutton directed his attention. He had long studied the changes of the atmosphere. The same volume in which his *Theory of the Earth* appeared contained also a *Theory of Rain*, which was read to the Royal Society of Edinburgh in 1784. He contended that the amount of moisture which the air can retain in solution increases with augmentation of temperature, and, therefore, that on the mixture of two masses of air of different temperatures a portion of the moisture must be condensed and appear in visible form. He investigated the available data regarding rainfall and climate in different regions of the globe, and came to the conclusion that the rainfall is everywhere regulated by the humidity of the

air on the one hand, and the causes which promote mixtures of different aerial currents in the higher atmosphere on the other.

The vigour and versatility of his genius may be understood from the variety of works which, during his thirty years' residence in Edinburgh, he gave to the world. In 1792 he published a quarto volume entitled *Dissertations on different Subjects in Natural Philosophy*, in which he discussed the nature of matter, fluidity, cohesion, light, heat and electricity. Some of these subjects were further illustrated by him in papers read before the Royal Society of Edinburgh. He did not restrain himself within the domain of physics, but boldly marched into that of metaphysics, publishing three quarto volumes with the title *An Investigation of the Principles of Knowledge, and of the Progress of Reason—from Sense to Science and Philosophy*. In this work he developed the idea that the external world, as conceived by us, is the creation of our own minds influenced by impressions from without, that there is no resemblance between our picture of the outer world and the reality, yet that the impressions produced upon our minds, being constant and consistent, become as much realities to us as if they precisely resembled things actually existing, and, therefore, that our moral conduct must remain the same as if our ideas perfectly corresponded to the causes producing them. His closing years were devoted to the extension and republication of his *Theory of the Earth*, of which two volumes appeared in 1795. A third volume, necessary to complete the work, was left by him in manuscript, and is referred to by his biographer John Playfair. A portion of the MS. of this volume, which had been given to the Geological Society of London by Leonard Horner, was published by the Society in 1899, under the editorship of Sir A. Geikie. The rest of the manuscript appears to be lost. Soon afterwards Hutton set to work to collect and systematize his numerous writings on husbandry, which he proposed to publish under the title of *Elements of Agriculture*. He had nearly completed this labour when an incurable disease brought his active career to a close on the 26th of March 1797.

It is by his *Theory of the Earth* that Hutton will be remembered with reverence while geology continues to be cultivated. The author's style, however, being somewhat heavy and obscure, the book did not attract during his lifetime so much attention as it deserved. Happily for science Hutton numbered among his friends John Playfair (q.v.), professor of mathematics in the university of Edinburgh, whose enthusiasm for the spread of Hutton's doctrine was combined with a rare gift of graceful and luminous exposition. Five years after Hutton's death he published a volume, *Illustrations of the Huttonian Theory of the Earth*, in which he gave an admirable summary of that theory, with numerous additional illustrations and arguments. This work is justly regarded as one of the classical contributions to geological literature. To its influence much of the sound progress of British geology must be ascribed. In the year 1805 a biographical account of Hutton, written by Playfair, was published in vol. v. of the *Transactions of the Royal Society of Edinburgh*. (A. Ge.)

**HUTTON, RICHARD HOLT** (1826-1897), English writer and theologian, son of Joseph Hutton, Unitarian minister at Leeds, was born at Leeds on the 2nd of June 1826. His family removed to London in 1835, and he was educated at University College School and University College, where he began a lifelong friendship with Walter Bagehot, of whose works he afterwards was the editor; he took the degree in 1845, being awarded the gold medal for philosophy. Meanwhile he had also studied for short periods at Heidelberg and Berlin, and in 1847 he entered Manchester New College with the idea of becoming a minister like his father, and studied there under James Martineau. He did not, however, succeed in obtaining a call to any church, and for some little time his future was unsettled. He married in 1851 his cousin, Anne Roscoe, and became joint-editor with J. L. Sanford of the *Inquirer*, the principal Unitarian organ. But his innovations and his unconventional views about stereotyped Unitarian doctrines caused alarm, and in 1853 he resigned. His health had broken down, and he visited the West Indies, where his wife died of yellow fever. In 1855 Hutton and Bagehot became joint-editors of the *National Review*, a new monthly, and conducted it for ten years. During this time Hutton's theological views, influenced largely by Coleridge, and more

directly by F. W. Robertson and F. D. Maurice, gradually approached more and more to those of the Church of England, which he ultimately joined. His interest in theology was profound, and he brought to it a spirituality of outlook and an aptitude for metaphysical inquiry and exposition which added a singular attraction to his writings. In 1861 he joined Meredith Townsend as joint-editor and part proprietor of the *Spectator*, then a well-known liberal weekly, which, however, was not remunerative from the business point of view. Hutton took charge of the literary side of the paper, and by degrees his own articles became and remained up to the last one of the best-known features of serious and thoughtful English journalism. The *Spectator*, which gradually became a prosperous property, was his pulpit, in which unwearingly he gave expression to his views, particularly on literary, religious and philosophical subjects, in opposition to the agnostic and rationalistic opinions then current in intellectual circles, as popularized by Huxley. A man of fearless honesty, quick and catholic sympathies, broad culture, and many friends in intellectual and religious circles, he became one of the most influential journalists of the day, his fine character and conscience earning universal respect and confidence. He was an original member of the Metaphysical Society (1869). He was an anti-vivisectionist, and a member of the royal commission (1875) on that subject. In 1858 he had married Eliza Roscoe, a cousin of his first wife; she died early in 1897, and Hutton's own death followed on the 9th of September of the same year.

Among his other publications may be mentioned *Essays, Theological and Literary* (1871; revised 1888), and *Criticisms on Contemporary Thought and Thinkers* (1894); and his opinions may be studied compendiously in the selections from his *Spectator* articles published in 1899 under the title of *Aspects of Religious and Scientific Thought*.

**HUXLEY, THOMAS HENRY** (1825-1895), English biologist, was born on the 4th of May 1825 at Ealing, where his father, George Huxley, was senior assistant-master in the school of Dr Nicholas. This was an establishment of repute, and is at any rate remarkable for having produced two men with so little in common in after life as Huxley and Cardinal Newman. The cardinal's brother, Francis William, had been "captain" of the school in 1821. Huxley was a seventh child (as his father had also been), and the youngest who survived infancy. Of Huxley's ancestry no more is ascertainable than in the case of most middle-class families. He himself thought it sprang from the Cheshire Huxleys of Huxley Hall. Different branches migrated south, one, now extinct, reaching London, where its members were apparently engaged in commerce. They established themselves for four generations at Wyre Hall, near Edmonton, and one was knighted by Charles II. Huxley describes his paternal race as "mainly Iberian mongrels, with a good dash of Norman and a little Saxon."<sup>1</sup> From his father he thought he derived little except a quick temper and the artistic faculty which proved of great service to him and reappeared in an even more striking degree in his daughter, the Hon. Mrs Collier. "Mentally and physically," he wrote, "I am a piece of my mother." Her maiden name was Rachel Withers. "She came of Wiltshire people," he adds, and describes her as "a typical example of the Iberian variety." He tells us that "her most distinguishing characteristic was rapidity of thought. . . That peculiarity has been passed on to me in full strength" (*Essays*, i, 4). One of the not least striking facts in Huxley's life is that of education in the formal sense he received none. "I had two years of a pandemonium of a school (between eight and ten), and after that neither help nor sympathy in any intellectual direction till I reached manhood" (*Life*, ii, 145). After the death of Dr Nicholas the Ealing school broke up, and Huxley's father returned about 1835 to his native town, Coventry, where he had obtained a small appointment. Huxley was left to his own devices; few histories of boyhood could offer any parallel. At twelve he was sitting up in bed to read Hutton's *Geology*. His great desire was to be a mechanical engineer; it ended in his devotion to "the mechanical engineering of living

machines." His curiosity in this direction was nearly fatal; a *post-mortem* he was taken to between thirteen and fourteen was followed by an illness which seems to have been the starting-point of the ill-health which pursued him all through life. At fifteen he devoured Sir William Hamilton's *Logic*, and thus acquired the taste for metaphysics, which he cultivated to the end. At seventeen he came under the influence of Thomas Carlyle's writings. Fifty years later he wrote: "To make things clear and get rid of cant and shows of all sorts. This was the lesson I learnt from Carlyle's books when I was a boy, and it has stuck by me all my life" (*Life*, ii, 268). Incidentally they led him to begin to learn German; he had already acquired French. At seventeen Huxley, with his elder brother James, commenced regular medical studies at Charing Cross Hospital, where they had both obtained scholarships. He studied under Wharton Jones, a physiologist who never seems to have attained the reputation he deserved. Huxley said of him: "I do not know that I ever felt so much respect for a teacher before or since" (*Life*, i, 20). At twenty he passed his first M.B. examination at the University of London, winning the gold medal for anatomy and physiology; W. H. Ransom, the well-known Nottingham physician, obtaining the exhibition. In 1845 he published, at the suggestion of Wharton Jones, his first scientific paper, demonstrating the existence of a hitherto unrecognized layer in the inner sheath of hairs, a layer that has been known since as "Huxley's layer."

Something had to be done for a livelihood, and at the suggestion of a fellow-student, Mr (afterwards Sir Joseph) Fayer, he applied for an appointment in the navy. He passed the necessary examination, and at the same time obtained the qualification of the Royal College of Surgeons. He was "entered on the books of Nelson's old ship, the 'Victory,' for duty at Haslar Hospital." Its chief, Sir John Richardson, who was a well-known Arctic explorer and naturalist, recognized Huxley's ability, and procured for him the post of surgeon to H.M.S. "Rattlesnake," about to start for surveying work in Torres Strait. The commander, Captain Owen Stanley, was a son of the bishop of Norwich and brother of Dean Stanley, and wished for an officer with some scientific knowledge. Besides Huxley the "Rattlesnake" also carried a naturalist by profession, John Macgillivray, who, however, beyond a dull narrative of the expedition, accomplished nothing. The "Rattlesnake" left England on the 9th of December 1846, and was ordered home after the lamented death of Captain Stanley at Sydney, to be paid off at Chatham on the 9th of November 1850. The tropical seas seem with delicate surface-life, and to the study of this Huxley devoted himself with unremitting devotion. At that time no known methods existed by which it could be preserved for study in museums at home. He gathered a magnificent harvest in the almost unexplored field, and the conclusions he drew from it were the beginning of the revolution in zoological science which he lived to see accomplished.

Baron Cuvier (1769-1832), whose classification still held its ground, had divided the animal kingdom into four great *embranchements*. Each of these corresponded to an independent archetype, of which the "idea" had existed in the mind of the Creator. There was no other connexion between these classes, and the "ideas" which animated them were, as far as one can see, arbitrary. Cuvier's groups, without their theoretical basis, were accepted by K. E. von Baer (1792-1876). The "idea" of the group, or archetype, admitted of endless variation within it; but this was subordinate to essential conformity with the archetype, and hence Cuvier deduced the important principle of the "correlation of parts," of which he made such conspicuous use in palaeontological reconstruction. Meanwhile the "Naturphilosophen" with J. W. Goethe (1749-1832) and L. Oken (1779-1851), had in effect grasped the underlying principle of correlation, and so far anticipated evolution by asserting the possibility of deriving specialized from simpler structures. Though they were still hampered by idealistic conceptions, they established morphology. Cuvier's four great groups were Vertebrata, Mollusca, Articulata and Radiata.

<sup>1</sup> *Nature*, lxxiii, 127.

It was amongst the members of the last class that Huxley found most material ready to his hand in the seas of the tropics. It included organisms of the most varied kind, with nothing more in common than that their parts were more or less distributed round a centre. Huxley sent home "communication after communication to the Linnean Society," then a somewhat somnolent body, "with the same result as that obtained by Noah when he sent the raven out of the ark" (*Essays*, i. 13). His important paper, *On the Anatomy and the Affinities of the Family of Medusae*, met with a better fate. It was communicated by the bishop of Norwich to the Royal Society, and printed by it in the *Philosophical Transactions* in 1849. Huxley united, with the Medusae, the Hydroid and Sertularian polyps, to form a class to which he subsequently gave the name of Hydrozoa. This alone was no inconsiderable feat for a young surgeon who had only had the training of the medical school. But the ground on which it was done has led to far-reaching theoretical developments. Huxley realized that something more than superficial characters were necessary in determining the affinities of animal organisms. He found that all the members of the class consisted of two membranes enclosing a central cavity or stomach. This is characteristic of what are now called the Coelenterata. All animals higher than these have been termed Coelomata; they possess a distinct body-cavity in addition to the stomach. Huxley went further than this, and the most profound suggestion in his paper is the comparison of the two layers with those which appear in the germ of the higher animals. The consequences which have flowed from this prophetic generalization of the *ectoderm* and *endoderm* are familiar to every student of evolution. The conclusion was the more remarkable as at the time he was not merely free from any evolutionary belief, but actually rejected it. The value of Huxley's work was immediately recognized. On returning to England in 1850 he was elected a Fellow of the Royal Society. In the following year, at the age of twenty-six, he not merely received the Royal medal, but was elected on the council. With absolutely no aid from any one he had placed himself in the front rank of English scientific men. He secured the friendship of Sir J. D. Hooker and John Tyndall, who remained his lifelong friends. The Admiralty retained him as a nominal assistant-surgeon, in order that he might work up the observations he had made during the voyage of the "Rattlesnake." He was thus enabled to produce various important memoirs, especially those on certain Ascidians, in which he solved the problem of *Appendicularia*—an organism whose place in the animal kingdom Johannes Müller had found himself wholly unable to assign—and on the morphology of the Cephalous Mollusca.

Richard Owen, then the leading comparative anatomist in Great Britain, was a disciple of Cuvier, and adopted largely from him the deductive explanation of anatomical fact from idealistic conceptions. He superadded the evolutionary theories of Oken, which were equally idealistic, but were altogether repugnant to Cuvier. Huxley would have none of either. Imbued with the methods of von Baer and Johannes Müller, his methods were purely inductive. He would not hazard any statement beyond what the facts revealed. He retained, however, as has been done by his successors, the use of archetypes, though they no longer represented fundamental "ideas" but generalizations of the essential points of structure common to the individuals of each class. He had not wholly freed himself, however, from archetypal trammels. "The doctrine," he says, "that every natural group is organized after a definite archetype . . . seems to me as important for zoology as the doctrine of definite proportions for chemistry." This was in 1853. He further stated: "There is no progression from a lower to a higher type, but merely a more or less complete evolution of one type" (*Phil. Trans.*, 1853, p. 63). As Chalmers Mitchell points out, this statement is of great historical interest. Huxley definitely uses the word "evolution," and admits its existence *within* the great groups. He had not, however, rid himself of the notion that the archetype was a property inherent in the group. Herbert Spencer, whose acquaintance he made in 1852, was unable to convert him to

evolution in its widest sense (*Life*, i. 168). He could not bring himself to acceptance of the theory—owing, no doubt, to his rooted aversion from *a priori* reasoning—without a mechanical conception of its mode of operation. In his first interview with Darwin, which seems to have been about the same time, he expressed his belief "in the sharpness of the lines of demarcation between natural groups," and was received with a humorous smile (*Life*, i. 169).

The naval medical service exists for practical purposes. It is not surprising, therefore, that after his three years' nominal employment Huxley was ordered on active service. Though without private means of any kind, he resigned. The navy, however, retains the credit of having started his scientific career as well as that of Hooker and Darwin. Huxley was now thrown on his own resources, the immediate prospects of which were slender enough. As a matter of fact, he had not to wait many months. His friend, Edward Forbes, was appointed to the chair of natural history in Edinburgh, and in July 1854 he succeeded him as lecturer at the School of Mines and as naturalist to the Geological Survey in the following year. The latter post he hesitated at first to accept, as he "did not care for fossils" (*Essays*, i. 15). In 1855 he married Miss H. A. Heathorn, whose acquaintance he had made in Sydney. They were engaged when Huxley could offer nothing but the future promise of his ability. The confidence of his devoted helpmate was not misplaced, and her affection sustained him to the end, after she had seen him the recipient of every honour which English science could bestow. His most important research belonging to this period was the Croonian Lecture delivered before the Royal Society in 1858 on "The Theory of the Vertebrate Skull." In this he completely and finally demolished, by applying as before the inductive method, the idealistic, if in some degree evolutionary, views of its origin which Owen had derived from Goethe and Oken. This finally disposed of the "archetype," and may be said once for all to have liberated the English anatomical school from the deductive method.

In 1859 *The Origin of Species* was published. This was a momentous event in the history of science, and not least for Huxley. Hitherto he had turned a deaf ear to evolution. "I took my stand," he says, "upon two grounds: firstly, that . . . the evidence in favour of transmutation was wholly insufficient; and secondly, that no suggestion respecting the causes of the transmutation assumed, which had been made, was in any way adequate to explain the phenomena" (*Life*, i. 168). Huxley had studied Lamarck "attentively," but to no purpose. Sir Charles Lyell "was the chief agent in smoothing the road for Darwin. For consistent uniformitarianism postulates evolution as much in the organic as in the inorganic world" (*l.c.*); and Huxley found in Darwin what he had failed to find in Lamarck, an intelligible hypothesis good enough as a working basis. Yet with the transparent candour which was characteristic of him, he never to the end of his life concealed the fact that he thought it wanting in rigorous proof. Darwin, however, was a naturalist; Huxley was not. He says: "I am afraid there is very little of the genuine naturalist in me. I never collected anything, and species-work was always a burden to me; what I cared for was the architectural and engineering part of the business" (*Essays*, i. 7). But the solution of the problem of organic evolution must work upwards from the initial stages, and it is precisely for the study of these that "species-work" is necessary. Darwin, by observing the peculiarities in the distribution of the plants which he had collected in the Galapagos, was started on the path that led to his theory. Anatomical research had only so far led to transcendental hypothesis, though in Huxley's hands it had cleared the decks of that lumber. He quotes with approval Darwin's remark that "no one has a right to examine the question of species who has not minutely described many" (*Essays*, ii. 283). The rigorous proof which Huxley demanded was the production of species sterile to one another by selective breeding (*Life*, i. 193). But this was a misconception of the question. Sterility is a physiological character, and the specific differences which the theory undertook to account for are

morphological; there is no necessary nexus between the two. Huxley, however, felt that he had at last a secure grip of evolution. He warned Darwin: "I will stop at no point as long as clear reasoning will carry me further" (*Life*, i. 172). Owen, who had some evolutionary tendencies, was at first favourably disposed to Darwin's theory, and even claimed that he had to some extent anticipated it in his own writings. But Darwin, though he did not thrust it into the foreground, never flinched from recognizing that man could not be excluded from his theory. "Light will be thrown on the origin of man and his history" (*Origin*, ed. i. 488). Owen could not face the wrath of fashionable orthodoxy. In his Rede Lecture he endeavoured to save the position by asserting that man was clearly marked off from all other animals by the anatomical structure of his brain. This was actually inconsistent with known facts, and was effectually refuted by Huxley in various papers and lectures, summed up in 1863 in *Man's Place in Nature*. This "monkey damnification" of mankind was too much even for the "veracity" of Carlyle, who is said to have never forgiven it. Huxley had not the smallest respect for authority as a basis for belief, scientific or otherwise. He held that scientific men were morally bound "to try all things and hold fast to that which is good" (*Life*, ii. 161). Called upon in 1862, in the absence of the president, to deliver the presidential address to the Geological Society, he disposed once for all of one of the principles accepted by geologists, that similar fossils in distinct regions indicated that the strata containing them were contemporary. All that could be concluded, he pointed out, was that the general order of succession was the same. In 1854 Huxley had refused the post of palaeontologist to the Geological Survey; but the fossils for which he then said that he "did not care" soon acquired importance in his eyes, as supplying evidence for the support of the evolutionary theory. The thirty-one years during which he occupied the chair of natural history at the School of Mines were largely occupied with palaeontological research. Numerous memoirs on fossil fishes established many far-reaching morphological facts. The study of fossil reptiles led to his demonstrating, in the course of lectures on birds, delivered at the College of Surgeons in 1867, the fundamental affinity of the two groups which he united under the title of Saurapsida. An incidental result of the same course was his proposed rearrangement of the zoological regions into which P. L. Sclater had divided the world in 1857. Huxley anticipated, to a large extent, the results at which botanists have since arrived: he proposed as primary divisions, Arctogaea—to include the land areas of the northern hemisphere—and Notogaea for the remainder. Successive waves of life originated in and spread from the northern area, the survivors of the more ancient types finding successively a refuge in the south. Though Huxley had accepted the Darwinian theory as a working hypothesis, he never succeeded in firmly grasping it in detail. He thought "evolution might conceivably have taken place without the development of groups possessing the characters of species" (*Essays*, v. 41). His palaeontological researches ultimately led him to dispense with Darwin. In 1892 he wrote: "The doctrine of evolution is no speculation, but a generalization of certain facts . . . classed by biologists under the heads of Embryology and of Palaeontology" (*Essays*, v. 42). Earlier in 1881 he had asserted even more emphatically that if the hypothesis of evolution "had not existed, the palaeontologist would have had to invent it" (*Essays*, iv. 44).

From 1870 onwards he was more and more drawn away from scientific research by the claims of public duty. Some men yield the more readily to such demands, as their fulfilment is not unaccompanied by public esteem. But he felt, as he himself said of Joseph Priestley, "that he was a man and a citizen before he was a philosopher, and that the duties of the two former positions are at least as imperative as those of the latter" (*Essays*, iii. 13). From 1862 to 1884 he served on no less than ten Royal Commissions, dealing in every case with subjects of great importance, and in many with matters of the gravest moment to the community. He held and filled with invariable dignity and distinction more public positions than

have perhaps ever fallen to the lot of a scientific man in England. From 1871 to 1880 he was a secretary of the Royal Society. From 1881 to 1885 he was president. For honours he cared little, though they were within his reach; it is said that he might have received a peerage. He accepted, however, in 1892, a Privy Councillorship, at once the most democratic and the most aristocratic honour accessible to an English citizen. In 1870 he was president of the British Association at Liverpool, and in the same year was elected a member of the newly constituted London School Board. He resigned the latter position in 1872, but in the brief period during which he acted, probably more than any man, he left his mark on the foundations of national elementary education. He made war on the scholastic methods which wearied the mind in merely taxing the memory; the children were to be prepared to take their place worthily in the community. Physical training was the basis; domestic economy, at any rate for girls, was insisted upon, and for all some development of the aesthetic sense by means of drawing and singing. Reading, writing and arithmetic were the indispensable tools for acquiring knowledge, and intellectual discipline was to be gained through the rudiments of physical science. He insisted on the teaching of the Bible partly as a great literary heritage, partly because he was "seriously perplexed to know by what practical measures the religious feeling, which is the essential basis of conduct, was to be kept up, in the present utterly chaotic state of opinion in these matters, without its use" (*Essays*, iii. 397). In 1872 the School of Mines was moved to South Kensington, and Huxley had, for the first time after eighteen years, those appliances for teaching beyond the lecture room, which to the lasting injury of the interests of biological science in Great Britain had been withheld from him by the short-sightedness of government. Huxley had only been able to bring his influence to bear upon his pupils by oral teaching, and had had no opportunity by personal intercourse in the laboratory of forming a school. He was now able to organize a system of instruction for classes of elementary teachers in the general principles of biology, which indirectly affected the teaching of the subject throughout the country.

The first symptoms of physical failure to meet the strain of the scientific and public duties demanded of him made some rest imperative, and he took a long holiday in Egypt. He still continued for some years to occupy himself mainly with vertebrate morphology. But he seemed to find more interest and the necessary mental stimulus to exertion in lectures, public addresses and more or less controversial writings. His health, which had for a time been fairly restored, completely broke down again in 1885. In 1890 he removed from London to Eastbourne, where after a painful illness he died on the 20th of June 1895.

The latter years of Huxley's life were mainly occupied with contributions to periodical literature on subjects connected with philosophy and theology. The effect produced by these on popular opinion was profound. This was partly due to his position as a man of science, partly to his obvious earnestness and sincerity, but in the main to his strenuous and attractive method of exposition. Such studies were not wholly new to him, as they had more or less engaged his thoughts from his earliest days. That his views exhibit some process of development and are not wholly consistent was, therefore, to be expected, and for this reason it is not easy to summarize them as a connected body of teaching. They may be found perhaps in their most systematic form in the volume on *Hume* published in 1879.

Huxley's general attitude to the problems of theology and philosophy was technically that of scepticism. "I am," he wrote, "too much of a sceptic to deny the possibility of anything" (*Life*, ii. 127). "Doubt is a beneficent demon" (*Essays*, ix. 56). He was anxious, nevertheless, to avoid the accusation of Pyrrhonism (*Life*, ii. 280), but the Agnosticism which he defined to express his position in 1869 suggests the Pyrrhonist *Alphabeta*. The only approach to certainty which he admitted lay in the order of nature. "The conception of the constancy of the order of nature has become the dominant idea of modern thought. . . . Whatever may be man's speculative doctrines, it is quite certain that every intelligent person guides his life and risks his fortune upon the belief that the order of nature is constant, and that the chain of natural causation is never broken." He adds, however, that "it by no means necessarily follows that we are justified in expanding this generalization into the infinite past" (*Essays*, iv. 47, 48). This was little more than a pious

reservation, as evolution implies the principle of continuity (*l.c.* p. 55). Later he stated his belief even more absolutely: "If there is anything in the world which I do firmly believe in, it is the universal validity of the law of causation, but that universality cannot be proved by any amount of experience" (*Essays*, ix. 121). The assertion that "There is only one method by which intellectual truth can be reached to wit, the subjective method of investigation, leading to the world of physics, or the world of consciousness" (*Essays*, ix. 126) laid him open to the charge of materialism, which he vigorously repelled. His defence, when he rested it on the imperfection of the physical analysis of matter and force (*l.c.* p. 131), was irrelevant; he was on sounder ground when he contended with Berkeley "that our certain knowledge does not extend beyond our states of consciousness" (*l.c.* p. 130). "Legitimate materialism, that is, the extension of the conceptions and of the methods of physical science to the highest as well as to the lowest phenomena of vitality, is neither more nor less than a sort of spiritual idealism" (*Essays*, i. 104). While "the substance of matter is a metaphysical unknown quality of the existence of which there is no proof... the non-existence of a substance of mind is equally arguable;... the result... is the reduction of the All to co-existences and sequences of phenomena beneath and beyond which there is nothing cognoscible" (*Essays*, ix. 66). Hume had defined a miracle as a "violation of the laws of nature." Huxley refused to accept this. While, on the one hand, he insists that "the whole fabric of practical life is built upon our faith in its continuity" (*Hume*, p. 129), on the other he boldly can presume to speak the truth, and to say that "this is the bottom out of all a priori objections either to ordinary 'miracles' or to the efficacy of prayer" (*Essays*, v. 133). "If by the term miracles we mean only extremely wonderful events, there can be no just ground for denying the possibility of their occurrence" (*Hume*, p. 134). Assuming the chemical elements to be aggregates of uniform primitive matter, he saw no more theoretical difficulty in water being turned into alcohol in the miracle at Cana, than in sugar undergoing a similar conversion (*Essays*, v. 81). The credibility of miracles with Huxley is a question of evidence. It may be remarked that the scientific explanation of the destructive of the supernatural character of a miracle, and that the demand for evidence may be so framed as to preclude the credibility of any historical event. Throughout his life theology had a strong attraction, not without elements of repulsion, for Huxley. The circumstances of his early training, when Paley was the "most interesting Sunday reading allowed him when a boy" (*Life*, ii. 57), probably had something to do with both. In 1860 his beliefs were apparently theistic: "Science seems to me to teach in the highest and strongest manner the great truth which is embodied in the Christian religion, to wit, the superiority to the will of God" (*Life*, i. 219). In 1885 he formulates "the perfect ideal of religion" in a passage which has become almost famous: "In the 8th century B.C. in the heart of a world of idolatrous polytheists, the Hebrew prophets put forth a conception of religion which appears to be as wonderful an inspiration of genius as the art of Pheidias or the science of Aristotle. And what doth the Lord require of thee, but to do justly, and to love mercy, and to walk humbly with thy God" (*Essays*, iv. 161). Two years later he was writing: "That there is no evidence of the existence of such a being as the God of the theologians is true enough" (*Life*, ii. 162). He insisted, however, that "atheism is on purely philosophical grounds untenable" (*l.c.*). His theism never really advanced beyond the recognition of "the passionless impersonality of the unknown and unknowable, which science shows everywhere underlying the thin veil of phenomena" (*Life*, i. 239). In other respects his personal creed was a kind of scientific Calvinism. There is an interesting passage in an essay written in 1892, "An Apologetic Eirenicism," which has not been republished, which illustrates this: "It is the secret of the superiority of the best of the religions to the majority of their opponents that they substantially recognize these realities of things, however strange the forms in which they clothe their conceptions. The doctrines of predestination, of original sin, of the innate depravity of man and the evil fate of the greater part of the race, of the primacy of Satan in this world, of the essential villainy of matter, of a malevolent Demirgus subordinate to a benevolent Almighty, who has only lately revealed himself, faulty as they are, appear to me to be vastly nearer the truth than that 'liberal' popular illusions that babies are all born good, and that the example of a corrupt society is responsible for their failure to remain so, that it is given to everybody to reach the ethical ideal if he will only try; that all partial evil is universal good, and other optimistic figments, such as that which represents 'Providence' under the guise of a paternal philanthropist, and bids us believe that everything will come right (according to our notions) at last." But his "slender definite creed," R. H. Hutton, who was associated with him in the Metaphysical Society, thought—and no doubt rightly—in no respect "represented the cravings of his larger nature."

From 1880 onwards till the very end of his life, Huxley was continuously occupied in a controversial campaign against orthodox beliefs. As Professor W. R. Woodson justly said of his earlier polemics: "They were certainly among the principal agents in winning a larger measure of toleration for the critical examination of fundamental beliefs, and for the free expression of honest reverent doubt." He threw Christianity overboard bodily and with little

appreciation of its historic effect as a civilizing agency. He thought that "the exact nature of the teachings and the convictions of Jesus is extremely uncertain" (*Essays*, v. 348). "What we are usually pleased to call religion nowadays is, for the most part, Hellenized Judaism" (*Essays*, iv. 162). His final analysis of what "since the second century, has assumed to itself the title of Orthodox Christianity" is a "varying compound of some of the best and some of the worst elements of Paganism and Judaism moulded in practice by the innate character of certain people of the Western world" (*Essays*, v. 142). He concludes "That this Christianity is doomed to fall is, to my mind, beyond a doubt; but its fall will neither be sudden nor speedy" (*l.c.*). He did not omit, however, to do justice to "the bright side of Christianity," and was deeply impressed with the life of Catherine of Siena. Failing Christianity, he thought that some other "hypothesis of men's hopes" will arise (*Essays*, v. 254). His latest speculations on ethical problems are perhaps the least satisfactory of his writings, as he wrote: "The moral sense is a very complex affair—dependent in part upon associations of pleasure and pain, approbation and disapprobation, formed by education in early youth, but in part also on an innate sense of moral beauty and ugliness (how originated need not be discussed), which is possessed by some people in great strength, while some are totally devoid of it" (*Life*, ii. 305). This is an intuitional theory, and he compares the moral with the aesthetic sense, which he repeatedly declares to be intuitive; thus: "All the understanding in the world is either intuitive or the result of the training of the intellect. This is beautiful and this is ugly" (*Essays*, ix. 80). In the Romanes Lecture delivered in 1894, in which this passage occurs, he defines "law and morals" to be "restraints upon the struggle for existence between men in society." It follows that "the ethical process is in opposition to the cosmic process," to which the struggle for existence belongs (*Essays*, ix. 31). Apparently he thought that the moral sense in its origin was intuitional and in its development utilitarian. "Morality commenced with society" (*Essays*, v. 52). The "ethical process" is the "gradual strengthening of the social good" (*Essays*, ix. 35). "The cosmic process has no sort of relation to moral ends" (*l.c.* p. 83); "of moral purpose I see no trace in nature. That is an article of exclusive human manufacture" (*Life*, ii. 268). The cosmic process Huxley identified with evil, and the ethical process with good; the two are in necessary conflict. "The reality at the bottom of the doctrine of original sin" is the "innate tendency to self-assertion" inherited by man from the cosmic order (*Essays*, ix. 27). "The actions we call sinful are part and parcel of the struggle for existence" (*Life*, ii. 282). "The prospect of attaining untroubled happiness is 'an illusion'" (*Essays*, ix. 44), and the cosmic process "in the long run will get the best of the contest, and 'resume its sway' when evolution enters on its downward course" (*l.c.* p. 45). This approaches pure pessimism, and though in Huxley's view the "pessimism of Schopenhauer is a nightmare" (*Essays*, ix. 200), his own philosophy of life is not distinguishable, and is often expressed in the same language. The cosmic order is obviously non-moral (*Essays*, ix. 197). That it is, as has been said, immoral is really meaningless. Pain and suffering are affections which imply a complex nervous organization, and we are not justified in projecting them into nature external to ourselves. Darwin and A. R. Wallace disagreed with Huxley in seeing rather the joyous than the suffering side of nature. Nor can it be assumed that the descending scale of evolution will reproduce the ascent, or that man will ever be conscious of his doom.

As has been said, Huxley never thoroughly grasped the Darwinian principle. He thought "transmutation may take place without transition" (*Life*, i. 173). In other words, that evolution is accomplished by leaps and not by the accumulation of small variations. He recognized the struggle for existence, but not the gradual adjustment of the organism to its environment, which is the key to "natural selection." In highly civilized societies he thought that the former was at an end (*Essays*, ix. 46) and had been replaced by the "struggle for enjoyment" (*l.c.* p. 40). But a consideration of the stationary population of France might have shown him that the effect in the one case may be as restrictive as in the other. So far from natural selection being in abeyance under modern social conditions, "it is," as Professor Karl Pearson points out, "something we run up against at once, almost as soon as we examine a mortality table." (*Biometrika*, 1896, p. 76). The inevitable contest, whether we like it or not, is that the future evolution of humanity as much a part of the cosmic process as its past history, and Huxley's attempt to shut the door on it cannot be maintained scientifically.

AUTHORITIES.—*Life and Letters of Thomas Henry Huxley*, by his son Leonard Huxley (2 vols., 1900); *Scientific Memoirs of T. H. Huxley* (4 vols., 1898-1901); *Collected Essays by T. H. Huxley* (9 vols., 1898); *Thomas Henry Huxley, a Sketch of his Life and Work*, by P. Chalmers Mitchell, M.A. (Oxon., 1900); a critical study founded on careful research and of great value. (W. T. T.-D.)

**HUY** (Lat. *Houim*, and Flem. *Hoey*), a town of Belgium, on the right bank of the Meuse, at the point where it is joined by the Hoyoux. Pop. (1904) 14,164. It is 19 m. E. of Namur and a trifle less west of Liège. Huy certainly dates from the 7th century, and, according to some, was founded by the emperor



Antonijns in A.D. 148. Its situation is striking, with its grey citadel crowning a grey rock, and the fine collegiate church (with a 13th-century gateway) of Notre Dame built against it. The citadel is now used partly as a depot of military equipment and partly as a prison. The ruins are still shown of the abbey of Neumouster founded by Peter the Hermit on his return from the first crusade. He was buried there in 1115, and a statue was erected in his memory in the abbey grounds in 1858. Neumouster was one of seventeen abbeys in this town alone dependent on the bishopric of Liège. Huy is surrounded by vineyards, and the bridge which crosses the Meuse at this point connects the fertile Hesbaye north of the river with the rocky and barren Condroz south of it.

**HUYGENS, CHRISTIAAN** (1629-1695), Dutch mathematician, mechanician, astronomer and physicist, was born at the Hague on the 14th of April 1629. He was the second son of Sir Constantijn Huygens. From his father he received the rudiments of his education, which was continued at Leiden under A. Vinnius and F. van Schooten, and completed in the juridical school of Breda. His mathematical bent, however, soon diverted him from legal studies, and the perusal of some of his earliest theorems enabled Descartes to predict his future greatness. In 1649 he accompanied the mission of Henry, count of Nassau, to Denmark, and in 1651 entered the lists of science as an assailant of the unsound system of quadratures adopted by Gregory of St Vincent. This first essay (*Exetasis quadraturae circuli*, Leiden, 1651) was quickly succeeded by his *Theoremata de quadratura hyperboles, ellipsis, et circuli*; while, in a treatise entitled *De circuli magnitudine inventa*, he made, three years later, the closest approximation so far obtained to the ratio of the circumference to the diameter of a circle.

Another class of subjects was now to engage his attention. The improvement of the telescope was justly regarded as a *sine qua non* for the advancement of astronomical knowledge. But the difficulties interposed by spherical and chromatic aberration had arrested progress in that direction until, in 1655, Huygens, working with his brother Constantijn, hit upon a new method of grinding and polishing lenses. The immediate results of the clearer definition obtained were the detection of a satellite to Saturn (the sixth in order of distance from its primary), and the resolution into their true form of the abnormal appendages to that planet. Each discovery in turn was, according to the prevailing custom, announced to the learned world under the veil of an anagram—removed, in the case of the first, by the publication, early in 1656, of the little tract *De Saturni luna observatio nova*; but retained, as regards the second, until 1659, when in the *Systema Saturnium* the varying appearances of the so-called "triple planet" were clearly explained as the phases of a ring inclined at an angle of 28° to the ecliptic. Huygens was also in 1656 the first effective observer of the Orion nebula; he delineated the bright region still known by his name, and detected the multiple character of its nuclear star. His application of the pendulum to regulate the movement of clocks sprang from his experience of the need for an exact measure of time in observing the heavens. The invention dates from 1656; on the 16th of June 1657 Huygens presented his first "pendulum-clock" to the states-general; and the *Horologium*, containing a description of the requisite mechanism, was published in 1658.

His reputation now became cosmopolitan. As early as 1655 the university of Angers had distinguished him with an honorary degree of doctor of laws. In 1663, on the occasion of his second visit to England, he was elected a fellow of the Royal Society, and imparted to that body in January 1666 a clear and concise statement of the laws governing the collision of elastic bodies. Although these conclusions were arrived at independently, and, as it would seem, several years previous to their publication, they were in great measure anticipated by the communications on the same subject of John Wallis and Christopher Wren, made respectively in November and December 1668.

Huygens had before this time fixed his abode in France. In 1665 Colbert made to him on behalf of Louis XIV. an offer

too tempting to be refused, and between the following year and 1681 his residence in the philosophic seclusion of the Bibliothèque du Roi was only interrupted by two short visits to his native country. His *magnum opus* dates from this period. The *Horologium oscillatorium*, published with a dedication to his royal patron in 1673, contained original discoveries sufficient to have furnished materials for half a dozen striking disquisitions. His solution of the celebrated problem of the "centre of oscillation" formed in itself an important event in the history of mechanics. Assuming as an axiom that the centre of gravity of any number of interdependent bodies cannot rise higher than the point from which it fell, he arrived, by anticipating in the particular case the general principle of the conservation of *vis viva*, at correct although not strictly demonstrated conclusions. His treatment of the subject was the first successful attempt to deal with the dynamics of a system. The determination of the true relation between the length of a pendulum and the time of its oscillation; the invention of the theory of evolutes; the discovery, hence ensuing, that the cycloid is its own evolute, and is strictly isochronous; the ingenious although practically inoperative idea of correcting the "circular error" of the pendulum by applying cycloidal cheeks to clocks—were all contained in this remarkable treatise. The theorems on the composition of forces in circular motion with which it concluded formed the true prelude to Newton's *Principia*, and would alone suffice to establish the claim of Huygens to the highest rank among mechanical inventors.

In 1681 he finally severed his French connexions, and returned to Holland. The harsher measures which about that time began to be adopted towards his co-religionists in France are usually assigned as the motive of this step. He now devoted himself during six years to the production of lenses of enormous focal distance, which, mounted on high poles, and connected with the eye-piece by means of a cord, formed what were called "aerial telescopes." Three of his object-glasses, of respectively 123, 180 and 210 ft. focal length, are in the possession of the Royal Society. He also succeeded in constructing an almost perfectly achromatic eye-piece, still known by his name. But his researches in physical optics constitute his chief title-deed to immortality. Although Robert Hooke in 1668 and Ignace Pardies in 1672 had adopted a vibratory hypothesis of light, the conception was a mere floating possibility until Huygens provided it with a sure foundation. His powerful scientific imagination enabled him to realize that all the points of a wave-front originate partial waves, the aggregate effect of which is to reconstitute the primary disturbance at the subsequent stages of its advance, thus accomplishing its propagation; so that each primary undulation is the envelope of an indefinite number of secondary undulations. This resolution of the original wave is the well-known "Principle of Huygens," and by its means he was enabled to prove the fundamental laws of optics, and to assign the correct construction for the direction of the extraordinary ray in uniaxial crystals. These investigations, together with his discovery of the "wonderful phenomenon" of polarization, are recorded in his *Traité de la lumière*, published at Leiden in 1690, but composed in 1678. In the appended treatise *Sur la Cause de la pesanteur*, he rejected gravitation as a universal quality of matter, although admitting the Newtonian theory of the planetary revolutions. From his views on centrifugal force he deduced the oblate figure of the earth, estimating its compression, however, at little more than one-half its actual amount.

Huygens never married. He died at the Hague on the 8th of June 1695, bequeathing his manuscripts to the university of Leiden, and his considerable property to the sons of his younger brother. In character he was as estimable as he was brilliant in intellect. Although, like most men of strong origination power, he assimilated with difficulty the ideas of others, his tardiness sprang rather from inability to depart from the track of his own methods than from reluctance to acknowledge the merits of his competitors.

In addition to the works already mentioned, his *Cosmotheoros*—

a speculation concerning the inhabitants of the planets—was printed posthumously at the Hague in 1698, and appeared almost simultaneously in an English translation. A volume entitled *Opera posthumum* (Leiden, 1793) contained his "Dioptrica," in which the ratio between the respective focal lengths of object-glass and eye-glass is given as the measure of magnifying power, together with the shorter essays *De vitris figurandis*, *De corona et parheliis*, &c. An early tract *De rationibus in Judo alicae*, printed in 1657, with Schooten's *Exercitationes mathematicae*, is notable as one of the first formal treatises on the theory of probabilities; nor should his investigations of the properties of the catenary, logarithmic and catenary curves be left unnoticed. His invention of the spiral watch-spring was explained in the *Journal des sçavans* (F. 25, 1675). An edition of his works was published by G. J. 's Gravesande, in four quarto volumes entitled *Opera varia* (Leiden, 1724) and *Opera reliqua* (Amsterdam, 1728). His scientific correspondence was edited by P. J. Uyenbroek from manuscripts preserved at Leiden, with the title *Christiani Hugenii alicorūque seculi XVII. virorum celeberrimorum exercitationes mathematicae et philosophicae* (the Hague, 1833).

The publication of a monumental edition of the letters and works of Huygens was undertaken at the Hague by the *Société Hollandaise des Sciences*, with the heading *Œuvres de Christian Huygens* (1888), &c. Ten quarto volumes, comprising the whole of his correspondence, had already been issued in 1905. A biography of Huygens was prefixed to his *Opera varia* (1724); his *Éloge* in the character of a French academician was printed by J. A. N. Condorcet in 1773. Consult further: P. J. Uyenbroek, *Oratio de fratribus Christiano alique Constantino Hugenio* (Groningen, 1838); P. Harting, *Christiaan Huygens in zijn Leven en Werken geschet* (Groningen, 1868); J. B. J. Delambre, *Hist. de l'astronomie moderne* (ii. 549); J. E. Montucla, *Hist. des mathématiques* (ii. 84, 412, 549); M. Chasles, *Aperçu historique sur l'origine des méthodes en géométrie*, pp. 101-109; E. Dühring, *Kritische Geschichte der allgemeinen Principien der Mechanik*, Abschnitt (ii. 120, 163, iii. 227); A. Berry, *A Short History of Astronomy*, p. 200; R. Wolf, *Geschichte der Astronomie*, passim; Houzeau, *Bibliographie astronomique* (ii. 169); F. Kaiser, *Astr. Nachr.* (xxv. 245, 1847); *Tijdschrift voor de Wetenschappen* (f. 7, 1848); *Allgemeine deutsche Biographie* (M. B. Cantor); J. C. Poggendorff, *Biog. lit. Handwörterbuch*. (A. M. C.)

**HUYGENS, SIR CONSTANTIJN** (1596-1687), Dutch poet and diplomatist, was born at the Hague on the 4th of September 1596. His father, Christiaan Huygens, was secretary to the state council, and a man of great political importance. At the baptism of the child, the city of Breda was one of his sponsors, and the admiral Justinus van Nassau the other. He was trained in every polite accomplishment, and before he was seven could speak French with fluency. He was taught Latin by Johannes Dedelus, and soon became a master of classic versification. He developed not only extraordinary intellectual gifts but great physical beauty and strength, and was one of the most accomplished athletes and gymnasts of his age; his skill in playing the lute and in the arts of painting and engraving attracted general attention before he began to develop his genius as a writer. In 1616 he proceeded, with his elder brother, to the university of Leiden. He stayed there only one year, and in 1618 went to London with the English ambassador Dudley Carleton; he remained in London for some months, and then went to Oxford, where he studied for some time in the Bodleian Library, and to Woodstock, Windsor and Cambridge; he was introduced at the English court, and played the lute before James I. The most interesting feature of this visit was the intimacy which sprang up between the young Dutch poet and Dr Donne, for whose genius Huygens preserved through life an unbounded admiration. He returned to Holland in company with the English contingent of the synod of Dort, and in 1619 he proceeded to Venice in the diplomatic service of his country; on his return he nearly lost his life by a foolhardy exploit, namely, the scaling of the topmost spire of Strassburg cathedral. In 1621 he published one of his most weighty and popular poems, his *Batava Tempe*, and in the same year he proceeded again to London, as secretary to the ambassador, Wijngaerden, but returned in three months. His third diplomatic visit to England lasted longer, from the 5th of December 1621 to the 1st of March 1623. During his absence, his volume of satires, *'t Costelick Mal*, dedicated to Jacob Cats, appeared at the Hague. In the autumn of 1622 he was knighted by James I. He published a large volume of miscellaneous poems in 1625 under the title of *Olorum libri sex*; and in the same year he was appointed private secretary to the stadholder.

In 1627 Huygens married Susanna van Baerle, and settled at the Hague; four sons and a daughter were born to them. In 1630 Huygens was called to a seat in the privy council, and he continued to exercise political power with wisdom and vigour for many years, under the title of the lord of Zuylichem. In 1634 he is supposed to have completed his long-talked-of version of the poems of Donne, fragments of which exist. In 1637 his wife died; and he immediately began to celebrate the virtues and pleasures of their married life in the remarkable didactic poem called *Dagwerck*, which was not published till long afterwards. From 1639 to 1641 he occupied himself by building a magnificent house and garden outside the Hague, and by celebrating their beauties in a poem entitled *Hofwijck*, which was published in 1653. In 1647 he wrote his beautiful poem of *Oogentroost* or "Eye Consolation," to gratify his blind friend Lucretia van Trollo. He made his solitary effort in the dramatic line in 1657, when he brought out his comedy of *Trijntje Cornelis Klacht*, which deals, in rather broad humour, with the adventures of the wife of a ship's captain at Zaandam. In 1658 he rearranged his poems, and issued them with many additions, under the title of *Corn Flowers*. He proposed to the government that the present highway from the Hague to the sea at Scheveningen should be constructed, and during his absence on a diplomatic mission to the French court in 1666 the road was made as a compliment to the venerable statesman, who expressed his gratitude in a descriptive poem entitled *Zeestraat*. Huygens edited his poems for the last time in 1672, and died in his ninety-first year, on the 28th of March 1687. He was buried, with the pomp of a national funeral, in the church of St Jacob, on the 4th of April. His second son, Christiaan, the eminent astronomer, is noticed separately.

Constantijn Huygens is the most brilliant figure in Dutch literary history. Other statesmen surpassed him in political influence, and at least two other poets surpassed him in the value and originality of their writings. But his figure was more dignified and splendid, his talents were more varied, and his general accomplishments more remarkable than those of any other person of his age, the greatest age in the history of the Netherlands. Huygens is the *grand seigneur* of the republic, the type of aristocratic oligarchy, the jewel and ornament of Dutch life. When we consider his imposing character and the positive value of his writings, we may well be surprised that he has not found a modern editor. It is a disgrace to Dutch scholarship that no complete collection of the writings of Huygens exists. His autobiography, *De vita propria sermone libri duo*, did not see the light until 1817, and his remarkable poem, *Chyswerck*, was not printed until 1841. As a poet Huygens shows a finer sense of form than any other early Dutch writer; the language, in his hands, becomes as flexible as Italian. His epistles and lighter pieces, in particular, display his metrical ease and facility to perfection. (E. G.)

**HUYSMANS**, the name of four Flemish painters who matriculated in the Antwerp guild in the 17th century. Cornelis the elder, apprenticed in 1633, passed for a mastership in 1636, and remained obscure. Jacob, apprenticed to Frans Wouters in 1650, wandered to England towards the close of the reign of Charles II., and competed with Lely as a fashionable portrait painter. He executed a portrait of the queen, Catherine of Braganza, now in the national portrait gallery, and Horace Walpole assigns to him the likeness of Lady Bellasis, catalogued at Hampton Court as a work of Lely. His portrait of Izaak Walton in the National Gallery shows a disposition to imitate the styles of Rubens and Van Dyke. According to most accounts he died in London in 1666. Jan Baptist Huysmans, born at Antwerp in 1654, matriculated in 1676-1677, and died there in 1715-1716. He was younger brother to Cornelis Huysmans the second, who was born at Antwerp in 1648, and educated by Gaspar de Wit and Jacob van Artois. Of Jan Baptist little or nothing has been preserved, except that he registered numerous apprentices at Antwerp, and painted a landscape dated 1697 now in the Brussels museum. Cornelis the second is the only master of the name of Huysmans whose talent was largely acknowledged. He received lessons from two artists, one of whom was familiar with the Roman art of the Poussins, whilst the other inherited the scenic style of the school of Rubens. He combined the two in a rich, highly coloured, and usually effective style, which, however, was not free from monotony.

Seldom attempting anything but woodside views with fancy backgrounds, half Italian, half Flemish, he painted with great facility, and left numerous examples behind. At the outset of his career he practised at Malines, where he married in 1682, and there too he entered into some business connexion with van der Meulen, for whom he painted some backgrounds. In 1706 he withdrew to Antwerp, where he resided till 1717, returning then to Malines, where he died on the 1st of June 1727.

Though most of his pictures were composed for cabinets rather than churches, he sometimes emulated van Artois in the production of large sacred pieces, and for many years his "Christ on the Road to Emmaus" adorned the choir of Notre Dame of Malines. In the gallery of Nantes, where three of his small landscapes are preserved, there hangs an "Investment of Luxembourg," by van der Meulen, of which he is known to have laid in the background. The national galleries of London and Edinburgh contain each one example of his skill. Bleinheim, too, and other private galleries in England, possess one or more of his pictures. But most of his works are on the European continent.

**HUYSMANS, JORIS KARL** (1848-1907), French novelist, was born at Paris on the 5th of February 1848. He belonged to a family of artists of Dutch extraction; he entered the ministry of the interior, and was pensioned after thirty years' service. His earliest venture in literature, *Le Dragoir à épices* (1874), contained stories and short prose poems showing the influence of Baudelaire. *Marthe* (1876), the life of a courtesan, was published in Brussels, and Huysmans contributed a story, "Sac au dos," to *Les Soirées de Médan*, the collection of stories of the Franco-German war published by Zola. He then produced a series of novels of everyday life, including *Les Sœurs Vatar* (1879), *En Ménage* (1881), and *À vue d'eau* (1882), in which he outdid Zola in minute and uncompromising realism. He was influenced, however, more directly by Flaubert and the brothers de Goncourt than by Zola. In *L'Art moderne* (1883) he gave a careful study of impressionism and in *Certains* (1886) a series of studies of contemporary artists. *À Rebours* (1884), the history of the morbid tastes of a decadent aristocrat, des Esseintes, created a literary sensation, its caricature of literary and artistic symbolism covering much of the real beliefs of the leaders of the aesthetic revolt. In *La-Bas* Huysmans's most characteristic hero, Durtal, makes his appearance. Durtal is occupied in writing the life of Gilles de Rais; the insight he gains into Satanism is supplemented by modern Parisian students of the black art; but already there are signs of a leaning to religion in the sympathetic figures of the religious bell-ringer of Saint Sulpice and his wife. *En Route* (1895) relates the strange conversion of Durtal to mysticism and catholicism in his retreat to La Trappe. In *La Cathédrale* (1898), Huysmans's symbolistic interpretation of the cathedral of Chartres, he develops his enthusiasm for the purity of Catholic ritual. The life of *Sainte Lydvine de Schiedam* (1901), an exposition of the value of suffering, gives further proof of his conversion; and *L'Oblat* (1903) describes Durtal's retreat to the Val des Saints, where he is attached as an oblate to a Benedictine monastery. Huysmans was nominated by Edmond de Goncourt as a member of the Académie des Goncourt. He died as a devout Catholic, after a long illness of cancer in the palate on the 13th of May 1907. Before his death he destroyed his unpublished MSS. His last book was *Les Foules de Lourdes* (1906).

See Arthur Symonds, *Studies in two Literatures* (1897) and *The Symbolist Movement in Literature* (1899); Jean Lionnet in *L'Évolution des idées* (1903); Eugène Gilbert in *France et Belgique* (1905); J. Sargeret in *Les Grands écrivains* (1906).

**HUYSUM, JAN VAN** (1682-1740), Dutch painter, was born at Amsterdam in 1682, and died in his native city on the 8th of February 1740. He was the son of Justus van Huysum, who is said to have been expeditious in decorating doorways, screens and vases. A picture by this artist is preserved in the gallery of Brunswick, representing Orpheus and the Beasts in a wooded landscape, and here we have some explanation of his son's fondness for landscapes of a conventional and Arcadian kind; for Jan van Huysum, though skilled as a painter of still life, believed himself to possess the genius of a landscape painter.

Half his pictures in public galleries are landscapes, views of imaginary lakes and harbours with impossible ruins and classic edifices, and woods of tall and motionless trees—the whole very glossy and smooth, and entirely lifeless. The earliest dated work of this kind is that of 1717, in the Louvre, a grove with maidens culling flowers near a tomb, ruins of a portico, and a distant palace on the shores of a lake bounded by mountains.

It is doubtful whether any artist ever surpassed van Huysum in representing fruit and flowers. It has been said that his fruit has no savour and his flowers have no perfume—in other words, that they are hard and artificial—but this is scarcely true. In substance fruit and flower are delicate and finished imitations of nature in its more subtle varieties of matter. The fruit has an incomparable bluish of down, the flowers have a perfect delicacy of tissue. Van Huysum, too, shows supreme art in relieving flowers of various colours against each other, and often against a light and transparent background. He is always bright, sometimes even gaudy. Great taste and much grace and elegance are apparent in the arrangement of bouquets and fruit in vases adorned with bas reliefs or in baskets on marble tables. There is exquisite and faultless finish everywhere. But what van Huysum has not is the breadth, the bold effectiveness, and the depth of thought of de Heem, from whom he descends through Abrahamignon.

Some of the finest of van Huysum's fruit and flower pieces have been in English private collections: those of 1723 in the earl of Ellesmere's gallery, others of 1730-1732 in the collections of Hope and Ashburton. One of the best examples is now in the National Gallery (1736-1737). No public museum has finer and more numerous specimens than the Louvre, which boasts of four landscapes and six panels with still life; then see Berlin and Amsterdam with four fruit and flower pieces; then St Petersburg, Munich, Hanover, Dresden, the Hague, Brunswick, Vienna, Carlsruhe and Copenhagen.

**HWANG HO** [HOANG HO], the second largest river in China. It is known to foreigners as the Yellow river—a name which is a literal translation of the Chinese. It rises among the Kuen-lun mountains in central Asia, its head-waters being in close proximity to those of the Yangtze-Kiang. It has a total length of about 2400 m. and drains an area of approximately 400,000 sq. m. The main stream has its source in two lakes named Tsaring-nor and Oring-nor, lying about 35° N., 97° E., and after flowing with a south-easterly course it bends sharply to the north-west and north, entering China in the province of Kansuh in lat. 36°. After passing Lanchow-fu, the capital of this province, the river takes an immense sweep to the north and north-east, until it encounters the rugged barrier ranges that here run north and south through the provinces of Shansi and Chihi. By these ranges it is forced due south for 500 m., forming the boundary between the provinces of Shansi and Shensi, until it finds an outlet eastwards at Tung Kwan—a pass which for centuries has been renowned as the gate of Asia, being indeed the sole commercial passage between central China and the West. At Tung Kwan the river is joined by its only considerable affluent in China proper, the Wei (Wei-ho), which drains the large province of Shensi, and the combined volume of water continues its way at first east and then north-east across the great plain to the sea. At low water in the winter season the discharge is only about 36,000 cu. ft. per second, whereas during the summer flood it reaches 116,000 ft. or more. The amount of sediment carried down is very large, though no accurate observations have been made. In the account of Lord Macartney's embassy, which crossed the Yellow river in 1792, it was calculated to be 17,520 million cub. ft. a year, but this is considered very much over the mark. Two reasons, however, combine to render it probable that the sedimentary matter is very large in proportion to the volume of water: the first being the great fall, and the consequently rapid current over two-thirds of the river's course; the second that the drainage area is nearly all covered with deposits of loess, which, being very friable, readily gives way before the rainfall and is washed down in large quantity. The ubiquity of this loess or yellow earth, as the Chinese call it, has in fact given its name both to the river which carries it in solution and to the sea (the Yellow Sea) into which it is discharged. It is calculated

by Dr Guppy (*Journal of China Branch of Royal Asiatic Society*, vol. xvi.) that the sediment brought down by the three northern rivers of China, viz., the Yangtze, the Hwang-ho and the Peiho, is 24,000 million cub. ft. per annum, and is sufficient to fill up the whole of the Yellow Sea and the Gulf of Pechili in the space of about 36,000 years.

Unlike the Yangtze, the Hwang-ho is of no practical value for navigation. The silt and sand form banks and bars at the mouth, the water is too shallow in winter and the current is too strong in summer, and, further, the bed of the river is continually shifting. It is this last feature which has earned for the river the name "China's sorrow." As the silt-laden waters debouch from the rocky bed of the upper reaches on to the plains, the current slackens, and the coarser detritus settles on the bottom. By degrees the bed rises, and the people build embankments to prevent the river from overflowing. As the bed rises the embankments must be raised too, until the stream is flowing many feet above the level of the surrounding country. As time goes on the situation becomes more and more dangerous; finally, a breach occurs, and the whole river pours over the country, carrying destruction and ruin with it. If the breach cannot be repaired the river leaves its old channel entirely and finds a new exit to the sea along the line of least resistance. Such in brief has been the story of the river since the dawn of Chinese history. At various times it has discharged its waters alternately on the side of the other of the great mass of mountains forming the promontory of Shantung, and by mouths as far apart from each other as 500 m. At each change it has worked havoc and disaster by covering the cultivated fields with 2 or 3 ft. of sand and mud.

A great change in the river's course occurred in 1851, when a breach was made in the north embankment near Kaifengfu in Honan. At this point the river bed was some 25 ft. above the plain; the water consequently forsook the old channel entirely and poured over the level country, finally seizing on the bed of a small river called the Tsing, and thereby finding an exit to the sea. Since that time the new channel thus carved out has remained the proper course of the river, the old or southerly channel being left quite dry. It required some fifteen or more years to repair damages from this outbreak, and to confine the stream by new embankments. After that there was for a time comparative immunity from inundations, but in 1882 fresh outbreaks again began. The most serious of all took place in 1887, when it appeared probable that there would be again a permanent change in the river's course. By dint of great exertions, however, the government succeeded in closing the breach, though not till January 1889, and not until there had been immense destruction of life and property. The outbreak on this occasion occurred, as all the more serious outbreaks have done, in Honan, a few miles west of the city of Kaifengfu. The stream poured itself over the level and fertile country to the southwards, sweeping whole villages before it, and converting the plain into one vast lake. The area affected was not less than 50,000 sq. m. and the loss of life was computed at over one million. Since 1887 there have been a series of smaller outbreaks, mostly at points lower down and in the neighbourhood of Chinanfu, the capital of Shantung. These perpetually recurring disasters entail a heavy expense on the government; and from the mere pecuniary point of view it would well repay them to call in the best foreign engineering skill available, an expedient, however, which has not commended itself to the Chinese authorities. (G. J.)

**HWICCE**, one of the kingdoms of Anglo-Saxon Britain. Its exact dimensions are unknown; they probably coincided with those of the old diocese of Worcester, the early bishops of which bore the title "Episcopus Hwiccorum." It would therefore include Worcestershire, Gloucestershire except the Forest of Dean, the southern half of Warwickshire, and the neighbourhood of Bath. The name Hwicce survives in Wychwood in Oxfordshire and Whichford in Warwickshire. These districts, or at all events the southern portion of them, were according to the *Anglo-Saxon Chronicle*, s.a. 577, originally conquered by the West Saxons under Ceawlin. In later times, however, the kingdom of the Hwicce appears to have been always subject to Mercian supremacy, and possibly it was separated from Wessex in the time of Edwin. The first kings of whom we read were two brothers, Eanhere and Eanfrith, probably contemporaries of Wulfher. They were followed by a king named Osric, a contemporary of Æthelred, and he by a king Oshere. Oshere had three sons who reigned after him, Æthelheard, Æthelweard and Æthelric. The two last named appear to have been reigning in the year 706. At the beginning of Offa's reign we again find the kingdom ruled by three brothers, named Eanberht, Uhtred and Aldred, the two latter of whom lived until about 780. After them the title of king seems to have been given up. Their successor Æthelmund, who was killed in a campaign against

Wessex in 802, is described only as an earl. The district remained in possession of the rulers of Mercia until the fall of that kingdom. Together with the rest of English Mercia it submitted to King Alfred about 877-883 under Earl Æthelred, who possibly himself belonged to the Hwicce. No genealogy or list of kings has been preserved, and we do not know whether the dynasty was connected with that of Wessex or Mercia.

See Bede, *Historia eccles.* (edited by C. Plummer) iv. 13 (Oxford, 1896); W. de B. Birch, *Cartularium Saxonicum*, 43, 51, 76, 85, 116, 117, 122, 163, 187, 232, 233, 238 (Oxford, 1885-1889). (F. G. M. B.)

**HYACINTH** (Gr. *ἵακίνθος*), also called **JACINTH** (through Ital. *giacinto*), one of the most popular of spring garden flowers. It was in cultivation prior to 1597, at which date it is mentioned by Gerard. Rea in 1665 mentions several single and double varieties as being then in English gardens, and Justice in 1754 describes upwards of fifty single-flowered varieties, and nearly one hundred double-flowered ones, as a selection of the best from the catalogues of two then celebrated Dutch growers. One of the Dutch sorts, called *La Reine de Femmes*, a single white, is said to have produced from thirty-four to thirty-eight flowers in a spike, and on its first appearance to have sold for 50 guilders a bulb; while one called *Ouvrinnaar*, or *Conqueror*, a double blue, sold at first for 100 guilders, *Gloria Mundi* for 500 guilders, and *Koning Saloman* for 600 guilders. Several sorts are at that date mentioned as blooming well in water-glasses. Justice relates that he himself raised several very valuable double-flowered kinds from seeds, which many of the sorts he describes are noted for producing freely.

The original of the cultivated hyacinth, *Hyacinthus orientalis*, a native of Greece and Asia Minor, is by comparison an insignificant plant, bearing on a spike only a few small, narrow-lobed, waxy blue flowers, resembling in form those of our common bluebell. So great has been the improvement effected by the florists, and chiefly by the Dutch, that the modern hyacinth would scarcely be recognized as the descendant of the type above referred to, the spikes being long and dense, composed of a large number of flowers; the spikes produced by strong bulbs not unfrequently measure 6 to 9 in. in length and from 7 to 9 in. in circumference, with the flowers closely set on from bottom to top. Of late years much improvement has been effected in the size of the individual flowers and the breadth of their recurring lobes, as well as in securing increased brilliancy and depth of colour.

The peculiarities of the soil and climate of Holland are so very favourable to their production that Dutch florists have made a speciality of the growth of these and other bulbous-rooted flowers. Hundreds of acres are devoted to the growth of hyacinths in the vicinity of Haarlem, and bring in a revenue of several hundreds of thousands of pounds. Some notion of the vast number imported into England annually may be formed from the fact that, for the supply of flowering plants to Covent Garden, one market grower alone produces from 60,000 to 70,000 in pots under glass, their blooming period being accelerated by artificial heat, and extending from Christmas onwards until they bloom naturally in the open ground.

In the spring flower garden few plants make a more effective display than the hyacinth. Dotted in clumps in the flower borders, and arranged in masses of well-contrasted colours in beds in the flower garden, there are no flowers which impart during their season—March and April—a gayer tone to the parterre. The bulbs are rarely grown a second time, either for indoor or outdoor culture, though with care they might be utilized for the latter purpose; and hence the enormous numbers which are procured each recurring year from Holland.

The first hyacinths were single-flowered, but towards the close of the 17th century double-flowered ones began to appear, and till a recent period these bulbs were the most esteemed. At the present time, however, the single-flowered sorts are in the ascendant, as they produce more regular and symmetrical spikes of blossom, the flowers being closely set and more or less horizontal in direction, while most of the double sorts have the bells distant and dependent, so that the spike is loose and by comparison

ineffective. For pot culture, and for growth in water-glasses especially, the single-flowered sorts are greatly to be preferred. Few if any of the original kinds are now in cultivation, a succession of new and improved varieties having been raised, the demand for which is regulated in some respects by fashion.

The hyacinth delights in a rich light sandy soil. The Dutch incorporate freely with their naturally light soil a compost consisting of one-third coarse sea or river sand, one-third rotten cow dung without litter and one-third leaf-mould. The soil they renovated remains its qualities for six or seven years, but hyacinths are not planted upon the same place for two years successively, intermediary crops of narcissus, crocus or tulips being taken. A good compost for hyacinths is sandy loam, decayed leaf-mould, rott'n cow dung and sharp sand in equal parts, the whole being collected and laid up in a heap and turned over occasionally. Well-drained beds made up of this soil, and refreshed with a portion of new compost annually, would grow the hyacinth to perfection. The best time to plant the bulbs is towards the end of September and during October; they should be arranged in rows, 6 to 8 in. asunder, there being four rows in each bed. The bulbs should be sunk about 4 to 6 in. deep, with a small quantity of clean sand placed below and around each of them. The beds should be covered with decayed tan-bark, coco-nut fibre or half-rotten dung litter. As the flower-stems appear, they are tied to rigid but slender stakes to preserve them from accident. If the bulbs are at all prized, the stems should be broken off as soon as the flowering is over, so as not to exhaust the bulbs; the leaves, however, must be allowed to grow till matured, but as soon as they assume a yellow colour, the bulbs are taken up, and the roots are cut near their base, and the bulbs laid out in a dry airy, shady place to ripen, after which they are cleaned of loose earth and skin, ready for storing. It is the practice in Holland, about a month after the bloom, or when the tips of the leaves assume a withered appearance, to take up the bulbs, and to lay them sideways on the ground, covering them with an inch or two of earth. About three weeks later they are again taken up and cleaned. In the store-room they should be kept dry, well-aired and apart from each other.

Plants are better adapted for the hyacinth for pot culture as greenhouse decorative plants; and by the aid of forcing they may be had in bloom as early as Christmas. They flower fairly well in 5-in. pots, the stronger bulbs in 6-in. pots. To bloom at Christmas, they should be potted early in September, in a compost resembling that already recommended for the open-air beds; and, to keep up a succession of bloom, others should be potted at intervals of a few weeks till the middle or end of November. The tops of the bulbs should be about level with the soil, and if a little sand is put immediately around the roots, the plants will do much better. They are set in an open place on a dry hard bed of ashes, and be covered over to a depth of 6 or 8 in. with the same material or with fibre or soil; and when the roots are well developed, which will take from six to eight weeks, they may be removed to a frame, and gradually exposed to light, and then placed in a forcing pit in a heat of from 60° to 70°. When the flowers are fairly open, they may be removed to the greenhouse or conservatory.

The hyacinth may be very successfully grown in glasses for ornament in dwelling-houses. The glasses are tied to the neck with rain or even tap water, a few lumps of charcoal being dropped into them. The bulbs are placed in the hollow provided for them, so that their base just touches the water. This may be done in September or October. They are then set in a dark cupboard for a few weeks till roots are freely produced, and then gradually exposed to light. The early-flowering single white Roman hyacinth, a small-growing pure white variety, remarkable for its fragrance, is well adapted for forcing, as it can be had in bloom if required by November. For windows it grows well in the small glasses commonly used for crucifixes; and for decorative purposes should be planted about five bulbs in a 5-in. pot, or in pans holding a dozen each. If grown for cut flowers it can be planted thickly in boxes of any convenient size. It is highly esteemed during the winter months by florists.

The Spanish hyacinth (*H. amethystinus*) and *H. azureus* are charming little bulbs for growing in masses in the rock garden or front of the flower border. The older botanists included in the genus *Hyacinthus* species of *Muscari*, *Scilla* and other genera of bell-shaped flowers, and the name of hyacinth is still popularly applied to several other bulbous plants. Thus *Muscari botryoides* is the grape hyacinth, 6 in., blue or white, the handsomest; *M. moschatum*, the musk hyacinth, 10 in., has peculiar livid greenish-yellow flowers and a strong musky odour; *M. comosum* var. *monstrosum*, the feather hyacinth, bears sterile flowers broken up into a featherlike mass; *M. racemosum*, the starch hyacinth, is a native with deep blue plumed flowers. The Cape hyacinth is *Galliotia candicans*, a magnificent border plant, 3-4 ft. high, with large drooping white bell-shaped flowers; the star hyacinth, *Scilla maritima*; the Peruvian hyacinth or Cuban lily, *S. peruviana*, a native of the Mediterranean region, to which Linnaeus gave the species name *peruviana* on a mistaken assumption of its origin; the wild hyacinth or blue-bell, known variously as *Endymion nonscriptum*, *Hyacinthus nonscriptus* or *Scilla nutans*; the wild hyacinth of western North America, *Camassia scouletiana*. They all flourish in good garden soil of a gritty nature.

**HYACINTH**, or **JACINTH**, in mineralogy, a variety of zircon (*q.v.*) of yellowish red colour, used as a gem-stone. The *hyacinthus* of ancient writers must have been our sapphire, or blue corundum, while the hyacinth of modern mineralogists may have been the stone known as *lyncarium* (Λυγκάριον). The Hebrew word *leshem*, translated figure in the Authorized Version (Ex. xxviii. 19), from the Λύβινον of the Septuagint, appears in the Revised Version as *jacinth*, but with a marginal alternative of *amber*. Both *jacinth* and *amber* may be reddish yellow, but their identification is doubtful. As our *jacinth* (zircon) is not known in ancient Egyptian work, Professor Flinders Petrie has suggested that the *leshem* may have been a yellow quartz, or perhaps agate. Some old English writers describe the *jacinth* as yellow, whilst others refer to it as a blue stone, and the *hyacinthus* of some authorities seems undoubtedly to have been our sapphire. In Rev. xx. 20 the Revised Version retains the word *jacinth*, but gives *sapphire* as an alternative.

Most of the gems known in trade as hyacinth are only garnets—generally the deep orange-brown hessonite or cinnamom-stone—and many of the antique engraved stones reputed to be hyacinth are probably garnets. The difference may be detected optically, since the garnet is singly and the hyacinth doubly refracting; moreover the specific gravity affords a simple means of diagnosis, that of garnet being only about 3.7, whilst hyacinth may have a density as high as 4.7. Again, it was shown many years ago by Sir A. H. Church that most hyacinths, when examined by the spectroscope, show a series of dark absorption bands, due perhaps to the presence of some rare element such as uranium or erbium.

Hyacinth is not a common mineral. It occurs, with other zircons, in the gem-gravels of Ceylon, and very fine stones have been found as pebbles at Mudgee in New South Wales. Crystals of zircon, with all the typical characters of hyacinth, occur at Expailly, Le Puy-en-Velay, in Central France, but they are not large enough for cutting. The stones which have been called *Compostella* hyacinths are simply ferruginous quartz from Santiago de Compostella in Spain. (F. W. R.)\*

**HYACINTHUS**, in Greek mythology, the youngest son of the Spartan king Amyclae, who reigned at Amyclae (so Pausanias iii. 1. 3, iii. 10. 5; and Apollodorus i. 3. 3, iii. 10. 3). Other stories make him son of Oebalus, of Eurotas, or of Pierus and the nymph Clio (see Hyginus, *Fabulae*, 271; Lucian, *De saltatione*, 45, and *Dial. deor.* 14). According to the general story, which is probably late and composite, his great beauty attracted the love of Apollo, who killed him accidentally when teaching him to throw the *discus* (quoit); others say that Zephyrus (or Boreas) out of jealousy deflected the quoit so that it hit Hyacinthus on the head and killed him. According to the representation on the tomb at Amyclae (Pausanias, *loc. cit.*) Hyacinthus was translated into heaven with his virgin sister Polyboea. Out of his blood there grew the flower known as the hyacinth, the petals of which were marked with the mournful exclamation AI, AI, "alas" (cf. "that sanguine flower inscribed with woe"). This Greek hyacinth cannot have been the flower which now bears the name: it has been identified with a species of iris and with the larkspur (*delphinium Atiacis*), which appear to have the markings described. The Greek hyacinth was also said to have sprung from the blood of Ajax. Evidently the Greek authorities confused both the flowers and the traditions.

The death of Hyacinthus was celebrated at Amyclae by the second most important of Spartan festivals, the Hyacinthia, which took place in the Spartan month Hecatombes. What month this was is not certain. Arguing from Xenophon (*Hell.* iv. 5) we get May; assuming that the Spartan Hecatombes is the Attic Hecatombaion, we get July; or again it may be the Attic Scirophorion, June. At all events the Hyacinthia was an early summer festival. It lasted three days, and the rites gradually passed from mourning for Hyacinthus to rejoicings

\* The word is probably derived from an Indo-European root, meaning "youthful," found in Latin, Greek, English and Sanskrit. Some have suggested that the first two letters are from *bea*, to rain, (cf. Hyades).

in the majesty of Apollo, the god of light and warmth, and giver of the ripe fruits of the earth (see a passage from Polycrates, *Laconica*, quoted by Athenaeus 139 D; criticized by L. R. Farnell, *Cults of the Greek States*, iv. 266 foll.). This festival is clearly connected with vegetation, and marks the passage from the youthful verdure of spring to the dry heat of summer and the ripening of the corn.

The precise relation which Apollo bears to Hyacinthus is obscure. The fact that at Tarentum a Hyacinthus tomb is ascribed by Polybius to Apollo Hyacinthus (not Hyacinthus) has led some to think that the personalities are one, and that the hero is merely an emanation from the god; confirmation is sought in the Apolline appellation *τερπάρειος*, alleged by Hesychius to have been used in Laconia, and assumed to describe a composite figure of Apollo-Hyacinthus. Against this theory is the essential difference between the two figures. Hyacinthus is a chthonian vegetation god whose worshippers are afflicted and sorrowful; Apollo, though interested in vegetation, is never regarded as inhabiting the lower world, his death is not celebrated in any ritual, his worship is joyous and triumphant, and finally the Amyclæan Apollo is specifically the god of war and song. Moreover, Pausanias describes the monument at Amyclæe as consisting of a rude figure of Apollo standing on an altar-shaped base which formed the tomb of Hyacinthus. Into the latter offerings were put for the hero before gifts were made to the god.

On the whole it is probable that Hyacinthus belongs originally to the pre-Dorian period, and that his story was appropriated and woven into their own Apollo myth by the conquering Dorians. Possibly he may be the apotheosis of a pre-Dorian king of Amyclæe. J. G. Frazer further suggests that he may have been regarded as spending the winter months in the underworld and returning to earth in the spring when the "hyacinth" blooms. In this case his festival represents perhaps both the Dorian conquest of Amyclæe and the death of spring before the ardent heat of the summer sun, typified as usual by the *discus* (quoit) with which Apollo is said to have slain him. With the growth of the hyacinth from his blood should be compared the oriental stories of violets springing from the blood of Attis, and roses and anemones from that of Adonis. As a youthful vegetation god, Hyacinthus may be compared with Linus and Scephrus, both of whom are connected with Apollo Agæus.

See L. R. Farnell, *Cults of the Greek States*, vol. iv. (1907), pp. 125 foll., 264 foll.; J. G. Frazer, *Adonis, Attis, Osiris* (1906), bk. ii. ch. 7; S. Wide, *Lakonische Kulte*, p. 290; E. Rhode, *Psyche*, 3rd ed. i. 137 foll.; Roscher, *Lexikon d. griech. u. röm. Myth.*, s.v. "Hyakinthos" (Greve); L. Preller, *Griechische Mythol.*, 4th ed. i. 248 foll. (J. M. M.).

**HYADES** ("the rainy ones"), in Greek mythology, the daughters of Atlas and Aethra; their number varies between two and seven. As a reward for having brought up Zeus at Dodona and taken care of the infant Dionysus Hyes, whom they conveyed to Ino (sister of his mother Demeter) at Thebes when his life was threatened by Lycurgus, they were translated to heaven and placed among the stars (Hyginus, *Poët. astron.* ii. 21). Another form of the story combines them with the Pleiades. According to this they were twelve (or fifteen) sisters, whose brother Hyas was killed by a snake while hunting in Libya (Ovid, *Fast.* v. 165; Hyginus, *Fab.* 192). They lamented him so bitterly that Zeus, out of compassion, changed them into stars—five into the Hyades, at the head of the constellation of the Bull, the remainder into the Pleiades. Their name is derived from the fact that the rainy season commenced when they rose at the same time as the sun (May 7-21); the original conception of them is that of the fertilizing principle of moisture. The Romans derived the name from *ēs* (pig), and translated it by *Suculae* (Cicero, *De nat. deorum*, ii. 43).

**HYATT, ALPHEUS** (1838-1902), American naturalist, was born at Washington, D.C., on the 5th of April 1838. From 1858 to 1862 he studied at Harvard, where he had Louis Agassiz for his master, and in 1863 he served as a volunteer in the Civil War, attaining the rank of captain. In 1867 he was appointed curator of the Essex Institute at Salem, and in 1870 became professor of zoology and palaeontology at the Massachusetts

Institute of Technology (resigned 1888), and custodian of the Boston Society of Natural History (curator in 1881). In 1886 he was appointed assistant for palaeontology in the Cambridge museum of comparative anatomy, and in 1889 was attached to the United States Geological Survey as palaeontologist for the Trias and Jura. He was the chief founder of the American Society of Naturalists, of which he acted as first president in 1883, and he also took a leading part in establishing the marine biological laboratories at Annisquam and Woods Hole, Mass. He died at Cambridge on the 15th of January 1902.

His works include *Observations on Fresh-water Polyzoa* (1866); *Fossil Cephalopods of the Museum of Comparative Zoology* (1872); *Revision of North American Porifera* (1875-1877); *Genera of Fossil Cephalopoda* (1883); *Larval Theory of the Origin of Cellular Tissue* (1884); *Genesis of the Arietidae* (1889); and *Phylogeny of an acquired characteristic* (1894). He wrote the section on Cephalopoda in Karl von Zittel's *Palaeontologie* (1900), and his well-known study on the fossil pond snails of Steinheim ("The Genesis of the Tertiary Species of Planorbis at Steinheim") appeared in the *Memoirs of the Boston Natural History Society* in 1880. He was one of the founders and editors of the *American Naturalist*.

**HYBLA**, the name of several cities in Sicily. The best known historically, though its exact site is uncertain, is Hybla Major, near (or by some supposed to be identical with) Megara Hyblæa (*q.v.*); another Hybla, known as Hybla Minor or Galeatis, is represented by the modern Paternò; while the site of Hybla Heræa is to be sought near Ragusa.

**HYBRIDISM**. The Latin word *hybrida*, *hibrida* or *ibrida* has been assumed to be derived from the Greek *ἵβρις*, an insult or outrage, and a hybrid or mongrel has been supposed to be an outrage on nature, an unnatural product. As a general rule animals and plants belonging to distinct species do not produce offspring when crossed with each other, and the term hybrid has been employed for the result of a fertile cross between individuals of different species, the word mongrel for the more common result of the crossing of distinct varieties. A closer scrutiny of the facts, however, makes the term hybridism less isolated and more vague. The words species and genus, and still more subspecies and variety, do not correspond with clearly marked and sharply defined zoological categories, and no exact line can be drawn between the various kinds of crossings from those between individuals apparently identical to those belonging to genera universally recognized as distinct. Hybridism therefore grades into mongrelism, mongrelism into cross-breeding, and cross-breeding into normal pairing, and we can say little more than that the success of the union is the more unlikely or more unnatural the further apart the parents are in natural affinity.

The interest in hybridism was for a long time chiefly of a practical nature, and was due to the fact that hybrids are often found to present characters somewhat different from those of either parent. The leading facts have been known in the case of the horse and ass from time immemorial. The earliest recorded observation of a hybrid plant is by J. G. Gmelin towards the end of the 17th century; the next is that of Thomas Fairchild, who in the second decade of the 18th century, produced the cross which is still grown in gardens under the name of "Fairchild's Sweet William." Linnaeus made many experiments in the cross-fertilization of plants and produced several hybrids, but Joseph Gottlieb Kölreuter (1733-1806) laid the first real foundation of our scientific knowledge of the subject. Later on Thomas Andrew Knight, a celebrated English horticulturist, devoted much successful labour to the improvement of fruit trees and vegetables by crossing. In the second quarter of the 19th century C. F. Gärtner made and published the results of a number of experiments that had not been equalled by any earlier worker. Next came Charles Darwin, who first in the *Origin of Species*, and later in *Cross and Self-Fertilization of Plants*, subjected the whole question to a critical examination, reviewed the known facts and added many to them.

Darwin's conclusions were summed up by G. J. Romanes in the 9th edition of this *Encyclopædia* as follows:—

1. The laws governing the production of hybrids are identical, or nearly identical, in the animal and vegetable kingdoms.
2. The sterility which so generally attends the crossing of two specific forms is to be distinguished as of two kinds, which, although

often confounded by naturalists, are in reality quite distinct. For the sterility may obtain between the two parent species when first crossed, or it may first assert itself in their hybrid progeny. In the latter case the hybrids, although possibly produced without any appearance of infertility on the part of their parent species, nevertheless prove more or less infertile among themselves, and also with members of either parent species.

3. The degree of both kinds of infertility varies in the case of different species, and in that of their hybrid progeny, from absolute sterility up to complete fertility. Thus, to take the case of plants, "when pollen from a plant of one family is placed on the stigma of a plant of a distinct family, it exerts no more influence than so much inorganic dust. From this absolute zero of fertility, the pollen of different species, applied to the stigma of some one species of the same genus, yields a perfect gradation in the number of seeds produced, up to nearly complete, or even quite complete, fertility; so, in hybrids themselves, there are some which never have produced, and probably never would produce, even with the pollen of the pure parents, a single fertile seed; but in some of these cases a first trace of fertility may be detected, by the pollen of one of the pure parent species causing the flower of the hybrid to wither earlier than it otherwise would have done; and the early withering of the flower is well known to be a sign of incipient fertilization. From this extreme degree of sterility we have self-fertilized hybrids producing a greater and greater number of seeds up to perfect fertility."

4. Although there is, as a rule, a certain parallelism, there is no fixed relation between the degree of sterility manifested by the parent species when crossed and that which is manifested by their hybrid progeny. There are, for example, cases in which two pure species can be crossed with unusual facility, while the resulting genera are remarkably sterile; and, contrariwise, there are species which can only be crossed with extreme difficulty, though the hybrids, when produced, are very fertile. Even within the limits of the same genus, these two opposite cases may occur.

5. When two species are reciprocally crossed, i.e. male A with female B, and male B with female A, the degree of sterility often differs greatly in the two cases. The sterility of the resulting hybrids may differ likewise.

6. The degree of sterility of first crosses and of hybrids runs, to a certain extent, parallel with the systematic affinity of the forms which are united. For species belonging to distinct genera can rarely, and those belonging to distinct families can never, be crossed. The parallelism, however, is far from complete; for a multitude of closely allied species will not unite, or unite with extreme difficulty, whilst other species, widely different from each other, can be crossed with perfect facility. Nor does the difficulty depend on ordinary constitutional differences; for annual and perennial plants, deciduous and evergreen trees, plants flowering at different seasons, inhabiting different stations, and naturally living under the most opposite climates, can often be crossed with ease. The difficulty or facility apparently depends exclusively on the sexual constitution of the species which are crossed, or on their sexual elective affinity.

There are many new records as to the production of hybrids. Horticulturists have been extremely active and successful in their attempts to produce new flowers or new varieties of vegetables by seminal or graft-hybrids, and any florist's catalogue or the account of any special plant, such as is to be found in Foster-Melliar's *Book of the Rose*, is in great part a history of successful hybridization. Much special experimental work has been done by botanists, notably by de Vries, to the results of whose experiments we shall recur. Experiments show clearly that the obtaining of hybrids is in many cases merely a matter of taking sufficient trouble, and the successful crossing of genera is not infrequent.

Focke, for instance, cites cases where hybrids were obtained between *Brassica* and *Raphanus*, *Galium* and *Asperula*, *Campanula* and *Phyteuma*, *Verbascum* and *Celsia*. Among animals, new records and new experiments are almost equally numerous. Boveri has crossed *Echinus microtuberculatus* with *Sphaerechinus granularis*. Thomas Hunt Morgan even obtained hybrids between *Asterias*, a starfish, and *Arbacia*, a sea-urchin, a cross as remote as would be that between a fish and a mammal. Vernon got many hybrids by fertilizing the eggs of *Strongyloprotus lividus* with the sperm of *Sphaerechinus*. Standfuss has carried on an enormous series of experiments with Lepidopteran insects, and has obtained very large series of hybrids, of which he has kept careful record. Lepidopterists generally begin to suspect that many curious forms offered by dealers as new species are products got by crossing known species. Apelló has succeeded with Teleostean fish; Gebhardt and others with Amphibia. Elliot and Suctchet have studied carefully the question of hybridization occurring normally among birds, and have got together a very large body of evidence. Among the cases cited by Elliot the most striking are that of the hybrid between *Colinus cafer* and *C. auratus*, which occurs over a very wide area of North America and is known as *C. hybridus*, and the hybrid between *Euplocamus lineatus* and *E. horsfieldi*, which appears to be common in

Assam. St M. Podmore has produced successful crosses between the wood-pigeon (*Columba palumbus*) and a domesticated variety of the rock pigeon (*C. livia*). Among mammals noteworthy results have been obtained by Professor Cossar Ewart, who has bred nine zebra hybrids by crossing mares of various sizes with a zebra stallion, and who has studied in addition three hybrids out of zebra mares, one sired by a donkey, the others by ponies. Crosses have been made between the common rabbit (*Lepus castuleus*) and the guinea-pig (*Cavia cobaya*), and examples of the results have been exhibited in the Zoological Gardens of Sydney, New South Wales. The Carnivora generally are very easy to hybridize, and many successful experiments have been made with animals in captivity. Karl Hagenbeck of Hamburg has produced crosses between the lion (*Felis leo*) and the tiger (*F. tigris*). What was probably a "tri-hybrid" in which lion, leopard and jaguar were mingled was exhibited by a London showman in 1908. Crosses between various species of the smaller cats have been fertile on many occasions. The black bear (*Ursus americanus*) and the European brown bear (*U. arctos*) bred in the London Zoological Gardens in 1859, but the three cubs did not reach maturity. Hybrids between the brown bear and the grizzly-bear (*U. horribilis*) have been produced in Cologne, whilst at Halle since 1874 a series of successful matings of polar (*U. maritimus*) and brown bears have been made. Examples of these hybrid bears have been exhibited by the London Zoological Society. The London Zoological Society has also successfully mated several species of antelopes, for instance, the water-bucks *Kobus ellipsiprymnus* and *K. unctuosus*, and Selous's antelope *Limnotragus selousi* with *L. gratus*.

The causes militating against the production of hybrids have also received considerable attention. Delage, discussing the question, states that there is a general proportion between sexual attraction and zoological affinity, and in many cases hybrids are not naturally produced simply from absence of the stimulus to sexual mating, or because of preferential mating within the species or variety. In addition to differences of habit, temperament, time of maturity, and so forth, gross structural differences may make mating impossible. Thus Escherich contends that among insects the peculiar structure of the genital appendages makes cross-impregnation impossible, and there is reason to believe that the specific peculiarities of the modified sexual palps in male spiders have a similar result.

The difficulties, however, may not exist, or may be overcome by experiment, and frequently it is only careful management that is required to exert little attraction. Thus it has been found that when the pollen of one species does not succeed in fertilizing the ovules of another species, yet the reciprocal cross may be successful; that is to say, the pollen of the second species may fertilize the ovules of the first. H. M. Vernon, working with sea-urchins, found that the obtaining of hybrids depended on the relative maturity of the sexual products. The difficulties in crossing apparently may extend to the chemiotoxic processes of the actual sexual cells. Thus when the spermatozoa of an urchin were placed in a drop of seawater containing ripe eggs of an urchin and of a starfish, the former eggs became surrounded by clusters of the male cells, while the latter appeared to exert little attraction for the alien germ-cells. Finally, when the actual impregnation of the egg is possible naturally, it has been secured by artificial means, the development of the hybrid may stop at an early stage. Thus hybrids between the urchin and the starfish, animals belonging to different classes, reached only the stage of the pluteus larva. A. D. Apelló, experimenting with Teleostean fish, found that very often impregnation and segmentation occurred, but that the development broke down immediately afterwards. W. Gebhardt, crossing *Rana esculenta* with *R. arvalis*, found that the cleavage of the ovum was normal, but that abnormality began with the gastrula, and that development at last stopped. In a very general fashion there appears to be a parallel between the zoological affinity and the extent to which the incomplete development of the hybrid proceeds.

As to the sterility of hybrids *inter se*, or with either of the parent forms, information is still wanted. Delage, summing up the evidence in a general way, states that mongrels are more fertile and stronger than their parents, while hybrids are at least equally hardy but less fertile. While many of the hybrid products of horticulturists are certainly infertile, others appear to be indefinitely fertile.

Focke, it is true, states that the hybrids between *Primula auricula* and *P. hirsuta* are fertile for many generations, but not indefinitely so; but, while this may be true for the particular case, there seems no reason to doubt that many plant hybrids are quite fertile. In the case of animals the evidence is rather against fertility. Standfuss, who has made experiments lasting over many years, and who has dealt with many genera of Lepidoptera, obtained no fertile hybrid females, although he found that hybrid males paired readily and successfully with pure-bred females of the parent races. Elliot,

dealing with birds, concluded that no hybrids were fertile with one another beyond the second generation, but thought that they were fertile with members of the parent races. Wallace, on the other hand, cites from Quatrefages the case of hybrids between the moths *Bombyx cynthia* and *B. arriada*, which were stated to be fertile *inter se* for eight generations. He also states that hybrids between the sheep and goat have a limited fertility *inter se*. Charles Darwin, however, had evidence that some hybrid pheasants were completely fertile, and he himself interbred the progeny of crosses between the common and Chinese geese, whilst there appears to be no doubt as to the complete fertility of the crosses between many species of ducks, J. L. Bonhote having interbred in various crosses for several generations the mallard (*Anas boschas*), the Indian spot-bill duck (*A. poecilorhynchos*), the New Zealand grey duck (*A. superciliosa*) and the pin-tail (*Dasula acuta*). Podmore's pigeon hybrids were fertile *inter se*, a specimen having been exhibited at the London Zoological Gardens. The hybrids between the brown and polar bears bred at Halle proved to be fertile, both with one of the parent species and with one another.

Cornevin and Lesbire state that in 1873 an Arab mule was fertilized in Africa by a stallion, and gave birth to female offspring which she suckled. All three were brought to the Jardin d'Acclimatation in Paris, and there the mule had a second female colt to the same father, and subsequently two male colts in succession to an ass and to a stallion. The female progeny were fertilized, but their offspring were feeble and died at birth. Cossar Ewart gives an account of a recent Indian case in which a female mule gave birth to a male colt. He points out, however, that many mistakes have been made about the breeding of hybrids, and is not altogether inclined to accept this supposed case. Very little has been published with regard to the most important question, as to the actual condition of the sexual organs and cells in hybrids. There does not appear to be gross anatomical defect to account for the infertility of hybrids, but microscopical examination in a large number of cases is wanted. Cossar Ewart, to whom indeed much of the most interesting recent work on hybrids is due, states that in male zebra-hybrids the sexual cells were immature, the tails of the spermatozoa being much shorter than those of the similar cells in stallions and zebras. He adds, however, that the male hybrids he examined were young, and might not have been sexually mature. He examined microscopically the ovary of a female zebra-hybrid and found one large and several small Graafian follicles, in all respects similar to those in a normal mare or female zebra. A careful study of the sexual organs in stallions and plant hybrids is very much to be desired, but it may be said they are so far as our present knowledge goes there is not to be expected any obvious microscopical cause of the relative infertility of hybrids.

The relative variability of hybrids has received considerable attention from many writers. Horticulturists, as Bateson has written, are "aware of the great and striking variations which occur in so many orders of plants when hybridization is effected." The phrase has been used "breaking the constitution of a plant" to indicate the effect produced in the offspring of a hybrid union, and the device is frequently used by those who are seeking for novelties to introduce on the market. It may be said generally that hybrids are variable, and that the products of hybrids are still more variable. J. L. Bonhote found extreme variations amongst his hybrid ducks. Y. Delage states that in reciprocal crosses there is always a marked tendency for the offspring to resemble the male parents; he quotes from Huxley that the mule, whose male parent is an ass, is more like the ass, and that the hinny, whose male parent is a horse, is more like the horse. Standfuss found among Lepidoptera that males were produced much more often than females, and that these males paired readily. The freshly hatched larvae closely resembled the larvae of the female parent, but in the course of growth the resemblance to the male increased, the extent of the final approximation to the male depending on the relative phylogenetic age of the two parents, the parent of the older species being prepotent. In reciprocal pairing, he found that the male was able to transmit the characters of the parents in a higher degree. Cossar Ewart, in relation to zebra hybrids, has discussed the matter of resemblance to parents in very great detail, and fuller information must be sought in his writings. He shows that the wild parent is not necessarily prepotent, although many writers have urged that view. He described three hybrids bred out of a zebra mare by different horses, and found in all cases that the resemblance to the male or horse parent was more profound. Similarly, zebra-donkey hybrids out of zebra mares bred in France and in Australia were in characters and disposition far more like the donkey parents. The results which he obtained in the hybrids which he bred

from a zebra stallion and different mothers were more variable, but there was rather a balance in favour of zebra disposition and against zebra shape and marking.

"Of the nine zebra-horse hybrids I have bred," he says, "only two in their make and disposition take decidedly after the wild parent. As explained fully below, all the hybrids differ profoundly in the plan of their markings from the zebra, while in their ground colour they take after their respective dams or the ancestors of their dams far more than after the zebra—the hybrid out of the yellow and white Iceland pony, e.g. instead of being light in colour, as I anticipated, is for the most part of a dark dun colour, with but indistinct stripes. The hoofs, mane and tail of the hybrids are at the most intermediate, but this is perhaps partly owing to reversion towards the ancestors of these respective dams. In their disposition and habits they all undoubtedly agree more with the wild sire."

Ewart's experiments and his discussion of them also throw important light on the general relation of hybrids to their parents. He found that the coloration and pattern of his zebra hybrids resembled far more those of the Somali or Grévy's zebra than those of their sire—a Burchell's zebra. In a general discussion of the stripings of horses, asses and zebras, he came to the conclusion that the Somali zebra represented the older type, and that therefore his zebra hybrids furnished important evidence of the effect of crossing in producing reversion to ancestral type. The same subject has of course been discussed at length by Darwin, in relation to the cross-breeding of varieties of pigeons; but the modern experimentalists who are following the work of Mendel interpret reversion differently (see MENDELISM).

*Graft-Hybridism*.—It is well known that, when two varieties or allied species are grafted together, each retains its distinctive characters. But to this general, if not universal, rule there are on record several alleged exceptions, in which either the scion is said to have partaken of the qualities of the stock, the stock of the scion, or each to have affected the other. Supposing any of these influences to have been exerted, the resulting product would deserve to be called a graft-hybrid. It is clearly a matter of great interest to ascertain whether such formation of hybrids by grafting is really possible; for, if even one instance of such formation could be unequivocally proved, it would show that sexual and asexual reproduction are essentially identical.

The cases of alleged graft-hybridism are exceedingly few, considering the enormous number of grafts that are made every year by horticulturists, and have been so made for centuries. Of these cases the most celebrated are those of Adam's laburnum (*Cytisus Adami*) and the bizzarrìa orange. Adam's laburnum is now flourishing in numerous places throughout Europe, all the trees having been raised as cuttings from the original graft, which was made by inserting a bud of the purple laburnum into a stock of the yellow. M. Adam, who made the graft, has left on record that from it there sprang the existing hybrid. There can be no question as to the truly hybrid character of the latter—all the peculiarities of both parent species being often blended in the same raceme, flower or even petal; but until the experiment shall have been successfully repeated there must always remain a strong suspicion that, notwithstanding the assertion and doubtless the belief of M. Adam, the hybrid arose as a cross in the ordinary way of seminal reproduction. Similarly, the bizzarrìa orange, which is unquestionably a hybrid between the bitter orange and the citron—since it presents the remarkable spectacle of these two different fruits blended into one—is stated by the gardener who first succeeded in producing it to have arisen as a graft-hybrid; but here again a similar doubt, similarly due to the need of corroboration, attaches to the statement. And the same remark applies to the still more wonderful case of the so-called trifacial orange, which blends three distinct kinds of fruit in one, and which is said to have been produced by artificially splitting and uniting the seeds taken from the three distinct species, the fruits of which now occur blended in the triple hybrid.

The other instances of alleged graft-hybridism are too numerous to be here noticed in detail; they refer to jessamine, ash, hazel, vine, hyacinth, potato, beet and rose. Of these the cases of the vine, beet and rose are the strongest as evidence of graft-hybridization, from the fact that some of them were produced



as the result of careful experiments made by very competent experimentalists. On the whole, the results of some of these experiments, although so few in number, must be regarded as making out a strong case in favour of the possibility of graft-hybridism. For it must always be remembered that, in experiments of this kind, negative evidence, however great in amount, may be logically dissipated by a single positive result.

**Theory of Hybridism.**—Charles Darwin was interested in hybridism as an experimental side of biology, but still more from the bearing of the facts on the theory of the origin of species. It is obvious that although hybridism is occasionally possible as an exception to the general infertility of species *inter se*, the exception is still more minimized when it is remembered that the hybrid progeny usually display some degree of sterility. The main facts of hybridism appear to lend support to the old doctrine that there are placed between all species the barriers of mutual sterility. The argument for the fixity of species appears still stronger when the general infertility of species crossing is contrasted with the general fertility of the crossing of natural and artificial varieties. Darwin himself, and afterwards G. J. Romanes, showed, however, that the theory of natural selection did not require the possibility of the commingling of specific types, and that there was no reason to suppose that the mutation of species should depend upon their mutual crossing. There existed more than enough evidence, and this has been added since, to show that infertility with other species is no criterion of a species, and that there is no exact parallel between the degree of affinity between forms and their readiness to cross. The problem of hybridism is no more than the explanation of the generally reduced fertility of remoter crosses as compared with the generally increased fertility of crosses between organisms slightly different. Darwin considered and rejected the view that the inter-sterility of species could have been the result of natural selection.

"At one time it appeared to me probable," he wrote (*Origin of Species*, 6th ed. p. 247), "as it has to others, that the sterility of first crosses and of hybrids might have been slowly acquired through the natural selection of slightly lessened degrees of fertility, which, like any other variation, spontaneously appeared in certain individuals of one variety when crossed with those of another variety. For it would clearly be advantageous to two varieties or incipient species if they could be kept from blending, on the same principle necessary that when man is selecting at the same time two varieties, it should be known that he should keep them separate. In the first place, it may be remarked that species inhabiting distinct regions are often sterile when crossed; now it could clearly have been of no advantage to such separated species to have been rendered mutually sterile and, consequently, this could not have been effected through natural selection; but it may perhaps be argued that, if a species were rendered sterile with some one compatriot, sterility with other species would follow as a necessary consequence. In the second place, it is almost as much opposed to the theory of natural selection as to that of special creation, that in reciprocal crosses the male element of one form should have been rendered utterly impotent on a second form, whilst at the same time the male element of this second form is enabled freely to fertilize the first; for this peculiar state of the reproductive system could hardly have been attained to either species."

Darwin came to the conclusion that the sterility of crossed species must be due to some principle quite independent of natural selection. In his search for such a principle he brought together much evidence as to the instability of the reproductive system, pointing out in particular how frequently wild animals in captivity fail to breed, whereas some domesticated races have been so modified by confinement as to be fertile together although they are descended from species probably mutually infertile. He was disposed to regard the phenomena of differential sterility as, so to speak, by-products of the process of evolution. G. J. Romanes afterwards developed his theory of physiological selection, in which he supposed that the appearance of differential fertility within a species was the starting-point of new species; certain individuals by becoming fertile only *inter se* proceeded along lines of modification diverging from the lines followed by other members of the species. Physiological selection in fact would operate in the same fashion as geographical isolation; if a portion of a species separated on an island tends to become

a new species, so also a portion separated by infertility with the others would tend to form a new species. According to Romanes, therefore, mutual infertility was the starting-point, not the result, of specific modification. Romanes, however, did not associate his interesting theory with a sufficient number of facts, and it has left little mark on the history of the subject. A. R. Wallace, on the other hand, has argued that sterility between incipient species may have been increased by natural selection in the same fashion as other favourable variations are supposed to have been accumulated. He thought that "some slight degree of infertility was a not infrequent accompaniment of the external differences which always arise in a state of nature between varieties and incipient species."

Weismann concluded, from an examination of a series of plant hybrids, that from the same cross hybrids of different character may be obtained, but that the characters are determined at the moment of fertilization; for he found that all the flowers on the same hybrid plant resembled one another in the minutest details of colour and pattern. Darwin already had pointed to this act of fertilization as the determining point, and it is in this direction that the theory of hybridism has made the greatest advance.

The starting-point of the modern views comes from the experiments and conclusions on plant hybrids made by Gregor Mendel and published in 1865. It is uncertain if Darwin had paid attention to this work; Romanes, writing in the 9th edition of this *Encyclopaedia*, cited it without comment. First H. de Vries, then W. Bateson and a series of observers returned to the work of Mendel (see MENDELISM), and made it the foundation of much experimental work and still more theory. It is still too soon to decide if the confident predictions of the Mendelians are justified, but it seems clear that a combination of Mendel's numerical results with Weismann's (see HEREDITY) conception of the particulate character of the germ-plasm, or hereditary material, is at the root of the phenomena of hybridism, and that Darwin was justified in supposing it to lie outside the sphere of natural selection and to be a fundamental fact of living matter.

**AUTHORITIES.**—Apelló, "Über einige Resultate der Kreuzbefruchtung bei Knochenfischen," *Bergens mus. aarbog* (1894); Bateson, "Hybridization and Cross-breeding," *Journal of the Royal Horticultural Society* (1900); J. L. Bonhote, "Hybrid Ducks," *Proc. Zool. Soc. of London* (1905), p. 147; Boveri, article "Befruchtung," in *Ergebnisse der Anatomie und Entwicklungsgeschichte von Merkel und Bonnet*, i. 385-485; Cornevin et Lesbre, "Étude sur un hybride issu d'une mule féconde et d'un cheval," *Rev. Sci.* li. 144; Charles Darwin, *Origin of Species* (1859), *The Effects of Cross and Self-Fertilization in the Vegetable Kingdom* (1878); Delage, *La Structure du protoplasma et les théories sur l'hérédité* (1895, with a literature); de Vries, "The Law of Disjunction of Hybrids," *Comptes rendus* (1900), p. 845; Elliot, *Hybridism*; Escherich, "Die biologische Bedeutung der Genitätshänge der Insecten," *Verh. s. B. Wien*, xlii. 225; Ewart, *The Penycuik Experiments* (1899); Focke, *Die Pflanzen-Mischlinge* (1881); Foster-Melliar, *The Book of the Rose* (1894); C. F. Gaertner, various papers in *Flora*, 1828, 1831, 1832, 1833, 1836, 1847, on "Bastard-Pflanzen"; Gebhardt, "Über die Bastardirung von *Rana esculenta* mit *R. arvalis*," *Inaug. Dissert.* (Breslau, 1894); G. Mendel, "Versuche über Pflanzen-Hybriden," *Verh. Natur. Vers. in Brünn* (1865), pp. 1-52; Morgan, "Experimental Studies," *Anat. Anz.* (1893), p. 141; *id.* p. 803; G. J. Romanes, "Physiological Selection," *Jour. Linn. Soc.* xix. 337; H. Scherren, "Notes on Hybrid Bears," *Proc. Zool. Soc. of London* (1907), p. 431; Saunders, *Proc. Roy. Soc.* (1897), lxii. 11; Standfuss, "Études de zoologie expérimentale," *Arch. Sci. Nat.* vi. 495; Suchetet, "Les Oiseaux hybrides rencontrés à l'état sauvage," *Mém. Soc. Zool.* v. 253-525, and vi. 26-45; Veron, "The Relation between the Hybrid and Parent Forms of Echinoid Larvae," *Proc. Roy. Soc.* lxx. 350; Wallace, *Darwinism* (1889); Weismann, *The Germ-Plasm* (1893). (P. C. M.)

**HYDANTOIN** (glycolyl urea),  $C_2H_4N_2O_2$  or  $CO \begin{matrix} \text{NH-CH}_2 \\ | \\ \text{NH-CO} \end{matrix}$

the ureide of glycollic acid, may be obtained by heating allantoin or alloxan with hydrochloric acid, or by heating bromacetyl urea with alcoholic ammonia. It crystallizes in needles, melting at 216° C.

When hydrolysed with baryta water yields hydantoin

(glycoluric) acid,  $\text{H}_2\text{N}\cdot\text{CO}\cdot\text{NH}\cdot\text{CH}_2\cdot\text{CO}_2\text{H}$ , which is readily soluble in hot water, and on heating with hydriodic acid decomposes into ammonia, carbon dioxide and glycolic,  $\text{CH}_2\cdot\text{NH}_2\cdot\text{CO}_2\cdot\text{H}$ . Many substituted hydantoines are known; the  $\alpha$ -alkyl hydantoines are formed on fusion of aldehyde- or ketone-cyanhydrins with urea, the  $\beta$ -alkyl hydantoines from the fusion of mono-alkyl glycolic with urea, and the  $\gamma$ -alkyl hydantoines from the action of alkalis and alkyl iodides on the  $\alpha$ -compounds.  $\gamma$ -Methyl hydantoin has been obtained as a splitting product of caffeine (E. Fischer, *Ann.*, 1882, 215, p. 253).

**HYDE**, the name of an English family distinguished in the 17th century. Robert Hyde of Norbury, Cheshire, had several sons, of whom the third was Lawrence Hyde of Gussage St Michael, Dorsetshire. Lawrence's son Henry was father of Edward Hyde, earl of Clarendon (*q.v.*), whose second son by his second wife was Lawrence, earl of Rochester (*q.v.*); another son was Sir Lawrence Hyde, attorney-general to Anne of Denmark, James I.'s consort; and a third son was Sir Nicholas Hyde (d. 1631), chief-justice of England. Sir Nicholas entered parliament in 1601 and soon became prominent as an opponent of the court, though he does not appear to have distinguished himself in the law. Before long, however, he deserted the popular party, and in 1626 he was employed by the duke of Buckingham in his defence to impeachment by the Commons; and in the following year he was appointed chief-justice of the king's bench, in which office it fell to him to give judgment in the celebrated case of Sir Thomas Darnell and others who had been committed to prison on warrants signed by members of the privy council, which contained no statement of the nature of the charge against the prisoners. In answer to the writ of *habeas corpus* the attorney-general relied on the prerogative of the crown, supported by a precedent of Queen Elizabeth's reign. Hyde, three other judges concurring, decided in favour of the crown, but without going so far as to declare the right of the crown to refuse indefinitely to show cause against the discharge of the prisoners. In 1629 Hyde was one of the judges who condemned Eliot, Holles and Valentine for conspiracy in parliament to resist the king's orders; refusing to admit their plea that they could not be called upon to answer out of parliament for acts done in parliament. Sir Nicholas Hyde died in August 1631.

Sir Lawrence Hyde, attorney-general to Anne of Denmark, had eleven sons, four of whom were men of some mark. Henry was an ardent royalist who accompanied Charles II. to the continent, and returning to England was beheaded in 1650; Alexander (1598-1667) became bishop of Salisbury in 1665; Edward (1607-1659) was a royalist divine who was nominated dean of Windsor in 1658, but died before taking up the appointment, and who was the author of many controversial works in Anglican theology; and Robert (1595-1665) became recorder of Salisbury and represented that borough in the Long Parliament, in which he professed royalist principles, voting against the attainder of Strafford. Having been imprisoned and deprived of his recordership by the parliament in 1645/6, Robert Hyde gave refuge to Charles II. on his flight from Worcester in 1651, and on the Restoration he was knighted and made a judge of the common pleas. He died in 1665. Henry Hyde (1672-1753), only son of Lawrence, earl of Rochester, became 4th earl of Clarendon and 2nd earl of Rochester, both of which titles became extinct at his death. He was in no way distinguished, but his wife Jane Hyde, countess of Clarendon and Rochester (d. 1725), was a famous beauty celebrated by the homage of Swift, Prior and Pope, and by the groundless scandal of Lady Mary Wortley Montagu. Two of her daughters, Jane, countess of Essex, and Catherine, duchess of Queensberry, were also famous beauties of the reign of Queen Anne. Her son, Henry Hyde (1710-1753), known as Viscount Cornbury, was a Tory and Jacobite member of parliament, and an intimate friend of Bolingbroke, who addressed to him his *Letters on the Study and Use of History*, and *On the Spirit of Patriotism*. In 1750 Lord Cornbury was created Baron Hyde of Hindon, but, as he predeceased his father, this title reverted to the latter and became extinct at his death. Lord Cornbury was celebrated as a wit and a conversationalist.

By his will he bequeathed the papers of his great-grandfather, Lord Clarendon, the historian, to the Bodleian Library at Oxford.

See Lord Clarendon, *The Life of Edward, Earl of Clarendon* (3 vols., Oxford, 1827); Edward Foss, *The Judges of England* (London, 1848-1854); Anthony à Wood, *Athenae oxonienses* (London, 1813-1820); Samuel Pepys, *Diary and Correspondence*, edited by Lord Braybrooke (4 vols., London, 1854).

**HYDE, THOMAS** (1636-1703), English Orientalist, was born at Billingsley, near Bridgnorth, in Shropshire, on the 29th of June 1636. He inherited his taste for linguistic studies, and received his first lessons in some of the Eastern tongues, from his father, who was rector of the parish. In his sixteenth year Hyde entered King's College, Cambridge, where, under Wheelock, professor of Arabic, he made rapid progress in Oriental languages, so that, after only one year of residence, he was invited to London to assist Brian Walton in his edition of the *Polyglott Bible*. Besides correcting the Arabic, Persian and Syriac texts for that work, Hyde transcribed into Persian characters the Persian translation of the Pentateuch, which had been printed in Hebrew letters at Constantinople in 1546. To this work, which Archbishop Ussher had thought well-nigh impossible even for a native of Persia, Hyde appended the Latin version which accompanies it in the *Polyglott*. In 1658 he was chosen Hebrew reader at Queen's College, Oxford, and in 1659, in consideration of his erudition in Oriental tongues, he was admitted to the degree of M.A. In the same year he was appointed under-keeper of the Bodleian Library, and in 1665 librarian-in-chief. Next year he was collated to a prebend at Salisbury, and in 1673 to the archdeaconry of Gloucester, receiving the degree of D.D. shortly afterwards. In 1691 the death of Edward Pococke opened up to Hyde the Laudian professorship of Arabic; and in 1697, on the deprivation of Roger Altham, he succeeded to the regius chair of Hebrew and a canonry of Christ Church. Under Charles II., James II. and William III. Hyde discharged the duties of Eastern interpreter to the court. Worn out by his unremitting labours, he resigned his librarianship in 1701, and died at Oxford on the 18th of February 1703. Hyde, who was one of the first to direct attention to the vast treasures of Oriental antiquity, was an excellent classical scholar, and there was hardly an Eastern tongue accessible to foreigners with which he was not familiar. He had even acquired Chinese, while his writings are the best testimony to his mastery of Turkish, Arabic, Syriac, Persian, Hebrew and Malay.

In his chief work, *Historia religionis veterum Persarum* (1700), he made the first attempt to correct from Oriental sources the errors of the Greek and Roman historians who had described the religion of the ancient Persians. His other writings and translations comprise *Tabulae longitudinum et latitudinum stellarum fixarum ex observatione principis Ulugh Beighi* (1665), to which his notes have given additional value; *Quatuor evangelia et acta apostolorum lingua Malica, characteribus Europaeis* (1677); *Epistola de mensuris et ponderibus serum sive sinensium* (1688), appended to Bernard's *De mensuris et ponderibus antiquis; Abraham Perisul itinera mundi* (1691); and *De ludis orientaliibus libri II.* (1694).

With the exception of the *Historia religionis*, which was republished by Hunt and Costard in 1760, the writings of Hyde, including some unpublished MSS., were collected and printed by Dr Gregory Sharpe in 1767 under the title *Syngnet dissertationum quas olim . . . Thomas Hyde separatim edidit*. There is a life of the author prefixed. Hyde also published a catalogue of the Bodleian Library in 1674.

**HYDE**, a market town and municipal borough in the Hyde parliamentary division of Cheshire, England,  $\frac{7}{8}$  m. E. of Manchester, by the Great Central railway. Pop. (1901) 32,766. It lies in the densely populated district in the north-east of the county, on the river Tame, which here forms the boundary of Cheshire with Lancashire. To the east the outlying hills of the Peak district of Derbyshire rise abruptly. The town has cotton weaving factories, spinning mills, print-works, iron foundries and machine works; also manufacturers of hats and margarine. There are extensive coal mines in the vicinity. Hyde is wholly of modern growth, though it contains a few ancient houses, such

as Newton Hall, in the part of the town so called. The old family of Hyde held possession of the manor as early as the reign of John. The borough, incorporated in 1881, is under a mayor, 6 aldermen and 18 councillors. Area, 3081 acres.

**HYDE DE NEUVILLE, JEAN GUILLAUME, BARON** (1776-1857), French politician, was born at La Charité-sur-Loire (Nièvre) on the 24th of January 1776, the son of Guillaume Hyde, who belonged to an English family which had emigrated with the Stuarts after the rebellion of 1745. He was only seventeen when he successfully defended a man denounced by Fouché before the revolutionary tribunal of Nevers. From 1793 onwards he was an active agent of the exiled princes; he took part in the Royalist rising in Berry in 1796, and after the *coup d'état* of the 18th Brumaire (November 9, 1799) tried to persuade Bonaparte to recall the Bourbons. An accusation of complicity in the infernal machine conspiracy of 1800-1801 was speedily retracted, but Hyde de Neuville retired to the United States, only to return after the Restoration. He was sent by Louis XVIII. to London to endeavour to persuade the British government to transfer Napoleon to a remoter and safer place of exile than the isle of Elba, but the negotiations were cut short by the emperor's return to France in March 1815. In January 1816 de Neuville became French ambassador at Washington, where he negotiated a commercial treaty. On his return in 1821 he declined the Constantinople embassy, and in November 1822 was elected deputy for Cosne. Shortly afterwards he was appointed French ambassador at Lisbon, where his efforts to oust British influence culminated, in connexion with the *coup d'état* of Dom Miguel (April 30, 1824), in his suggestion to the Portuguese minister to invite the armed intervention of Great Britain. It was assumed that this would be refused, in view of the loudly proclaimed British principle of non-intervention, and that France would then be in a position to undertake a duty that Great Britain had declined. The scheme broke down, however, owing to the attitude of the reactionary party in the government of Paris, which disapproved of the Portuguese constitution. This destroyed his influence at Lisbon, and he returned to Paris to take his seat in the Chamber of Deputies. In spite of his pronounced Royalism, he now showed Liberal tendencies, opposed the policy of Villèle's cabinet, and in 1828 became a member of the moderate administration of Martignac as minister of marine. In this capacity he showed active sympathy with the cause of Greek independence. During the Polignac ministry (1829-1830) he was again in opposition, being a firm upholder of the charter; but after the revolution of July 1830 he entered an all but solitary protest against the exclusion of the legitimate line of the Bourbons from the throne, and resigned his seat. He died in Paris on the 28th of May 1857.

His *Mémoires et souvenirs* (3 vols., 1888), compiled from his notes by his niece, the vicomtesse de Bardonnet and the baronne Laurenceau, are of great interest for the Revolution and the Restoration.

**HYDE PARK**, a small township of Norfolk county, Massachusetts, U.S.A., about 8 m. S.W. of the business centre of Boston. Pop. (1890) 10,193; (1900) 13,244, of whom 3805 were foreign-born; (1910 census) 15,507. Its area is about 43 sq. m. It is traversed by the New York, New Haven & Hartford railway, which has large repair shops here, and by the Neponset river and smaller streams. The township contains the villages of Hyde Park, Readville (in which there is the famous "Weil" trotting-track), Fairmount, Hazelwood and Clarendon Hills. Until about 1856 Hyde Park was a farmstead. The value of the total factory product increased from \$4,383,959 in 1900 to \$6,739,307 in 1905, or 53.7%. In 1868 Hyde Park was incorporated as a township, being formed of territory taken from Dorchester, Dedham and Milton.

**HYDERABAD**, or **HAIDARABAD**, a city and district of British India, in the Sind province of Bombay. The city stands on a hill about 3 m. from the left bank of the Indus, and had a population in 1901 of 69,378. Upon the site of the present fort is supposed to have stood the ancient town of Nerankot, which in the 8th century submitted to Mohammed bin Kasim. In 1768 the present city was founded by Ghulam Shah Kalhora;

and it remained the capital of Sind until 1843, when, after the battle of Meeanee, it was surrendered to the British, and the capital transferred to Karachi. The city is built on the most northerly hills of the Ganga range, a site of great natural strength. In the fort, which covers an area of 36 acres, is the arsenal of the province, transferred thither from Karachi in 1861, and the palaces of the ex-mirs of Sind. An excellent water supply is derived from the Indus. In addition to manufactures of silk, gold and silver embroidery, lacquered ware and pottery, there are three factories for ginning cotton. There are three high schools, training colleges for masters and mistresses, a medical school, an agricultural school for village officials, and a technical school. The city suffered from plague in 1896-1897.

The DISTRICT OF HYDERABAD has an area of 8201 sq. m., with a population in 1901 of 989,030, showing an increase of 15% in the decade. It consists of a vast alluvial plain, on the left bank of the Indus, 216 m. long and 48 broad. Fertile along the course of the river, it degenerates towards the east into sandy wastes, sparsely populated, and defying cultivation. The monotony is relieved by the fringe of forest which marks the course of the river, and by the avenues of trees that line the irrigation channels branching eastward from this stream. The south of the district has a special feature in its large natural water-courses (called *dhoras*) and basin-like shallows (*chhaus*), which retain the rains for a long time. A limestone range called the Ganga and the pleasant frequency of garden lands break the monotonous landscape. The principal crops are millets, rice, oil-seeds, cotton and wheat, which are dependent on irrigation, mostly from government canals. There is a special manufacture at Hala of glazed pottery and striped cotton cloth. Three railways traverse the district: (1) one of the main lines of the North-Western system, following the Indus valley and crossing the river near Hyderabad; (2) a broad-gauge branch running south to Badin, which will ultimately be extended to Bombay; and (3) a metre-gauge line from Hyderabad city into Rajputana.

**HYDERABAD, HAIDARABAD**, also known as the Nizam's Dominions, the principal native state of India in extent, population and political importance; area, 82,698 sq. m.; pop. (1901) 11,141,142, showing a decrease of 3.4% in the decade; estimated revenue 4½ crores of Hyderabad rupees (£2,500,000). The state occupies a large portion of the eastern plateau of the Deccan. It is bounded on the north and north-east by Berar, on the south and south-east by Madras, and on the west by Bombay. The country presents much variety of surface and feature; but it may be broadly divided into two tracts, distinguished from one another geologically and ethnically, which are locally known from the languages spoken as Telingana and Marathwara. In some parts it is mountainous, wooded and picturesque, in others flat and undulating. The open country includes lands of all descriptions, including many rich and fertile plains, much good land not yet brought under cultivation, and numerous tracts too sterile ever to be cultivated. In the north-west the geological formations are volcanic, consisting principally of trap, but in some parts of basalt; in the middle, southern and south-western parts the country is overlaid with gneissic formations. The territory is well watered, rivers being numerous, and tanks or artificial pieces of water abundant, especially in Telingana. The principal rivers are the Godavari, with its tributaries the Dudna, Manjira and Pranahita; the Wardha, with its tributary the Penganga; and the Kistna, with its tributary the Tungabhadra. The climate may be considered in general good; and as there are no arid bare deserts, hot winds are little felt.

More than half the revenue of the state is derived from the land, and the development of the country by irrigation and railways has caused considerable expansion in this revenue, though the rate of increase in the decade 1891-1901 was retarded by a succession of unfavourable seasons. The soil is generally fertile, though in some parts it consists of *chilka*, a red and gritty mould little fitted for purposes of agriculture. The principal crops are millets of various kinds, rice, wheat, oil-seeds, cotton,

tobacco, sugar-cane, and fruits and garden produce in great variety. Silk, known as *tussur*, the produce of a wild species of worm, is utilized on a large scale. Lac, suitable for use as a resin or dye, gums and oils are found in great quantities. Hides, raw and tanned, are articles of some importance in commerce. The principal exports are cotton, oil-seeds, country-clothes and hides; the imports are salt, grain, timber, European piece-goods and hardware. The mineral wealth of the state consists of coal, copper, iron, diamonds and gold; but the development of these resources has not hitherto been very successful. The only coal mine now worked is the large one at Singareni, with an annual out-turn of nearly half a million tons. This coal has enabled the nizām's guaranteed state railway to be worked so cheaply that it now returns a handsome profit to the state. It also gives encouragement to much-needed schemes of railway extension, and to the erection of cotton presses and of spinning and weaving mills. The Hyderabad-Godavari railway (opened in 1901) traverses a rich cotton country, and cotton presses have been erected along the line. The currency of the state is based on the *hali sikka*, which contains approximately the same weight of silver as the British rupee, but its exchange value fell heavily after 1803, when free coinage ceased in the mint. In 1904, however, a new coin (the Mahbubia rupee) was minted; the supply was regulated, and the rate of exchange became about 115 = 100 British rupees. The state suffered from famine during 1900, the total number of persons in receipt of relief rising to nearly 500,000 in June of that year. The nizām met the demands for relief with great liberality.

The nizām of Hyderabad is the principal Mohammedan ruler in India. The family was founded by Asaf Jah, a distinguished Turkoman soldier of the emperor Aurangzeb, who in 1713 was appointed subahdar of the Deccan, with the title of nizām-ul-mulk (regulator of the state), but eventually threw off the control of the Delhi court. Asaf Jah's death in 1748 was followed by an internecine struggle for the throne among his descendants, in which the British and the French took part. At one time the French nominee, Salabat Jang, established himself with the help of Bussy. But finally, in 1761, when the British had secured their predominance throughout southern India, Nizām Ali took his place and ruled till 1803. It was he who confirmed the grant of the Northern Circars in 1766, and joined in the two wars against Tippon Sultan in 1792 and 1799. The additions of territory which he acquired by these wars were afterwards (1800) ceded to the British, as payment for the subsidiary force which he had undertaken to maintain. By a later treaty in 1853, the districts known as Berar were "assigned" to defray the cost of the Hyderabad contingent. In 1857 when the Mutiny broke out, the attitude of Hyderabad as the premier native state and the cynosure of the Mahomedans in India became a matter of extreme importance; but Afzul-ud-Dowla, the father of the present ruler, and his famous minister, Sir Salar Jang, remained loyal to the British. An attack on the residency was repulsed, and the Hyderabad contingent displayed their loyalty in the field against the rebels. In 1902 by a treaty made by Lord Curzon, Berar was leased in perpetuity to the British government, and the Hyderabad contingent was merged in the Indian army. The nizām Mir Mahbub Ali Khan Bahadur, Asaf Jah, a direct descendant of the famous nizām-ul-mulk, was born on the 18th of August 1866. On the death of his father in 1869 he succeeded to the throne as a minor, and was invested with full powers in 1884. He is notable as the originator of the Imperial Service Troops, which now form the contribution of the native chiefs to the defence of India. On the occasion of the Panjdeh incident in 1885 he made an offer of money and men, and subsequently on the occasion of Queen Victoria's Jubilee in 1887 he offered 20 lakhs (£1,300,000) annually for three years for the purpose of frontier defence. It was finally decided that the native chiefs should maintain small but well-equipped bodies of infantry and cavalry for imperial defence. For many years past the Hyderabad finances were in a very unhealthy condition; the expenditure consistently outran the revenue, and the nobles, who held their tenure under an obsolete feudal

system, vied with each other in ostentatious extravagance. But in 1902, on the revision of the Berar agreement, the nizām received 25 lakhs (£167,000) a year for the rent of Berar, thus substituting a fixed for a fluctuating source of income, and a British financial adviser was appointed for the purpose of reorganizing the resources of the state.

See S. H. Bilgrami and C. Willmott, *Historical and Descriptive Sketch of the Nizām's Dominions* (Bombay, 1883-1884).

**HYDERABAD** or **HAIDARABAD**, capital of the above state, is situated on the right bank of the river Musi, a tributary of the Kistna, with Golconda to the west, and the residency and its bazaars and the British cantonment of Secunderabad to the north-east. It is the fourth largest city in India; pop. (1901) 448,466, including suburbs and cantonment. The city itself is in shape a parallelogram, with an area of more than 2 sq. m. It was founded in 1589 by Mahommed Kuli, fifth of the Kutb Shahi kings, of whose period several important buildings remain as monuments. The principal of these is the Char Minar or Four Minarets (1591). The minarets rise from arches facing the cardinal points, and stand in the centre of the city, with four roads radiating from their base. The Ashur Khana (1594), a ceremonial building, the hospital, the Gosha Mahal palace and the Mecca mosque, a sombre building designed after a mosque at Mecca, surrounding a paved quadrangle 360 ft. square, were the other principal buildings of the Kutb Shahi period, though the mosque was only completed in the time of Aurangzeb. The city proper is surrounded by a stone wall with thirteen gates, completed in the time of the first nizām, who made Hyderabad his capital. The suburbs, of which the most important is Chadarghat, extend over an additional area of 9 sq. m. There are several fine palaces built by various nizāms, and the British residency is an imposing building in a large park on the left bank of the Musi, N.E. of the city. The bazaars surrounding it, and under its jurisdiction, are extremely picturesque and are thronged with natives from all parts of India. Four bridges crossed the Musi, the most notable of which was the Furana Pul, of 23 arches, built in 1593. On the 27th and 28th of September 1908, however, the Musi, swollen by torrential rainfall (during which 15 in. fell in 36 hours), rose in flood to a height of 12 ft. above the bridges and swept them away. The damage done was widespread; several important buildings were involved, including the palace of Salar Jang and the Victoria zenana hospital, while the beautiful grounds of the residency were destroyed. A large and densely populated part of the city was wrecked, and thousands of lives were lost. The principal educational establishments are the Nizām college (first grade), engineering, law, medical, normal, industrial and Sanskrit schools, and a number of schools for Europeans and Eurasians. Hyderabad is an important centre of general trade, and there is a cotton mill in its vicinity. The city is supplied with water from two notable works, the Husain Sagar and the Mir Alam, both large lakes retained by great dams. Secunderabad, the British military cantonment, is situated 5½ m. N. of the residency; it includes Bolaram, the former headquarters of the Hyderabad contingent.

**HYDER ALI**, of HAIDAR 'ALI (c. 1722-1782), Indian ruler and commander. This Mahomedan soldier-adventurer, who, followed by his son Tippon, became the most formidable Asiatic rival the British ever encountered in India, was the great-grandson of a *fakir* or wandering ascetic of Islam, who had found his way from the Punjab to Gulburga in the Eccan, and the second son of a *naik* or chief constable at Budikota, near Kolar in Mysore. He was born in 1722, or according to other authorities 1717. An elder brother, who like himself was early turned out into the world to seek his own fortune, rose to command a brigade in the Mysore army, while Hyder, who never learned to read or write, passed the first years of his life aimlessly in sport and sensuality, sometimes, however, acting as the agent of his brother, and meanwhile acquiring a useful familiarity with the tactics of the French when at the height of their reputation under Dupleix. He is said to have induced his brother to employ a Parsee to purchase artillery and small arms from the Bombay

government, and to enrol some thirty sailors of different European nations as gunners, and is thus credited with having been "the first Indian who formed a corps of sepoys armed with firelocks and bayonets, and who had a train of artillery served by Europeans." At the siege of Devanhalli (1749) Hyder's services attracted the attention of Nanjiraj, the minister of the raja of Mysore, and he at once received an independent command; within the next twelve years his energy and ability had made him completely master of minister and raja alike, and in everything but in name he was ruler of the kingdom. In 1763 the conquest of Kanara gave him possession of the treasures of Bednor, which he resolved to make the most splendid capital in India, under his own name, thenceforth changed from Hyder Naik into Hyder Ali Khan Bahadur; and in 1765 he retrieved previous defeat at the hands of the Mahrattas by the destruction of the Nairs or military caste of the Malabar coast, and the conquest of Calicut. Hyder Ali now began to occupy the serious attention of the Madras government, which in 1766 entered into an agreement with the nizamat to furnish him with troops to be used against the common foe. But hardly had this alliance been formed when a secret arrangement was come to between the two Indian powers, the result of which was that Colonel Smith's small force was met with a united army of 80,000 men and 100 guns. British dash and sepoy fidelity, however, prevailed, first in the battle of Chengam (September 3rd, 1767), and again still more remarkably in that of Tiruvannamalai (Trinomalai). On the loss of his recently made fleet and forts on the western coast, Hyder Ali now offered overtures for peace; on the rejection of these, bringing all his resources and strategy into play, he forced Colonel Smith to raise the siege of Bangalore, and brought his army within 5 m. of Madras. The result was the treaty of April 1766, providing for the mutual restitution of all conquests, and for mutual aid and alliance in defensive war; it was followed by a commercial treaty in 1770 with the authorities of Bombay. Under these arrangements Hyder Ali, when defeated by the Mahrattas in 1772, claimed British assistance, but in vain; this breach of faith stung him to fury, and thenceforward he and his son did not cease to thirst for vengeance. His time came when in 1778 the British, on the declaration of war with France, resolved to drive the French out of India. The capture of Mahé on the coast of Malabar in 1779, followed by the annexation of lands belonging to a dependent of his own, gave him the needed pretext. Again master of all that the Mahrattas had taken from him, and with empire extended to the Kistna, he descended through the passes of the Ghats amid burning villages, reaching Conjeeveram, only 45 m. from Madras, unopposed. Not till the smoke was seen from St Thomas's Mount, where Sir Hector Munro commanded some 5200 troops, was any movement made; then, however, the British general sought to effect a junction with a smaller body under Colonel Baillie recalled from Guntur. The incapacity of these officers, notwithstanding the splendid courage of their men, resulted in the total destruction of Baillie's force of 2800 (September 10th, 1780). Warren Hastings sent from Bengal Sir Eyre Coote, who, though repulsed at Chidambaram, defeated Hyder thrice successively in the battles of Porto Novo, Pollilur and Sholingarh, while Tippon was forced to raise the siege of Wandiwash, and Vellore was provisioned. On the arrival of Lord Macartney as governor of Madras, the British fleet captured Negapatnam, and forced Hyder Ali to confess that he could never ruin a power which had command of the sea. He had sent his son Tippon to the west coast, to seek the assistance of the French fleet, when his death took place suddenly at Chittur in December 1782.

See L. B. Bowring, *Haidar Ali and Tipu Sultan*, "Rulers of India" series (1893). For the personal character, and administration of Hyder Ali see the *History of Hyder Naik*, written by Mir Hussein Ali Khan Kirmani (translated from the Persian by Colonel Miles, and published by the Oriental Translation Fund), and the curious work written by M. Le Maître de La Tour, commandant of his artillery (*Histoire d'Hyder-Ali Khan, Paris, 1783*). For the whole life and times see Walker, *Historical Sketches of the South of India* (1810-1817); Aitchison's *Treaties*, vol. v. (2nd ed., 1876); and Pearson, *Memoirs of Schwartz* (1834).

**HYDRA** (or *SIDRA*, *NIDRA*, *IDERO*, &c.; anc. *Hydræ*), an island of Greece, lying about 4 m. off the S.E. coast of Argolis in the Peloponnesus, and forming along with the neighbouring island of Dokos (Dhoko) the Bay of Hydra. Pop. about 6200. The greatest length from south-west to north-east is about 11 m., and the area is about 21 sq. m.; but it is little better than a rocky and treeless ridge with hardly a patch or two of arable soil. Hence the epigram of Antonios Krieztes to the queen of Greece: "The island produces prickly pears in abundance, splendid sea captains and excellent prime ministers." The highest point, Mount Ere, so called (according to Miaooules) from the Albanian word for wind, is 1058 ft. high. The next in importance is known as the Prophet Elias, from the large convent of that name on its summit. It was there that the patriot Theodoros Kolokotronis was imprisoned, and a large pine tree is still called after him. The fact that in former times the island was richly clad with woods is indicated by the name still employed by the Turks, *Tchamizaa*, the place of pines; but it is only in some favoured spots that a few trees are now to be found. Tradition also has it that it was once a well-watered island (hence the designation *Hydræ*), but the inhabitants are now wholly dependent on the rain supply, and they have sometimes had to bring water from the mainland. This lack of fountains is probably to be ascribed in part to the effect of earthquakes, which are not infrequent; that of 1769 continued for six whole days. Hydra, the chief town, is built near the middle of the northern coast, on a very irregular site, consisting of three hills and the intervening ravines. From the sea its white and handsome houses present a picturesque appearance, and its streets though narrow are clean and attractive. Besides the principal harbour, round which the town is built, there are three other ports on the north coast—Mandraki, Molo, Panagia, but none of them is sufficiently sheltered. Almost all the population of the island is collected in the chief town, which is the seat of a bishop, and has a local court, numerous churches and a high school. Cotton and silk weaving, tanning and shipbuilding are carried on, and there is a fairly active trade.

Hydra was of no importance in ancient times. The only fact in its history is that the people of Hermione (a city on the neighbouring mainland now known by the common name of *Kastri*) surrendered it to Samian refugees, and that from these the people of Troezen received it in trust. It appears to be completely ignored by the Byzantine chroniclers. In 1580 it was chosen as a refuge by a body of Albanians from Korkynias in Troezenia; and other emigrants followed in 1590, 1628, 1635, 1640, &c. At the close of the 17th century the Hydriotes took part in the reviving commerce of the Peloponnesus; and in course of time they extended their range. About 1716 they began to build *sakturia* (of from 10 to 15 tons burden), and to visit the islands of the Aegean; not long after they introduced the *latinadika* (40-50 tons), and sailed as far as Alexandria, Constantinople, Trieste and Venice; and by and by they ventured to France and even America. From the grain trade of south Russia more especially they derived great wealth. In 1813 there were about 22,000 people in the island, and of these 10,000 were seafarers. At the time of the outbreak of the war of Greek independence the total population was 28,190, of whom 16,460 were natives and the rest foreigners. One of their chief families, the Konduriotti, was worth £2,000,000. Into the struggle the Hydriotes flung themselves with rare enthusiasm and devotion, and the final deliverance of Greece was mainly due to the service rendered by their fleets.

See Pouqueville, *Voy. de la Grèce*, vol. vi.; Antonios Miaooules, *Τόπιμος περί της νήσου Τήρας* (Munich, 1834); Id. *Συναρτή Ιστορία των ναυπηγών διά των πλοίων των τριών νήσων, Τήρας, Περγάου και Φαρών* (Nauplia, 1833); Id. *Ιστορία της νήσου Τήρας* (Athens, 1874); G. D. Krieztes, *Ιστορία της νήσου Τήρας* (Patras, 1860).

**HYDRA** (watersnake), in Greek legend, the offspring of Typhon and Echidna, a gigantic monster with nine heads (the number is variously given), the centre one being immortal. Its haunt was a hill beneath a plane tree near the river Amymon, in the marshes of Lerna by Argos. The destruction of this Lernaean

hydra was one of the twelve "labours" of Heracles, which he accomplished with the assistance of Iolaus. Finding that as soon as one head was cut off two grew up in its place, they burnt out the roots with firebrands, and at last severed the immortal head from the body, and buried it under a mighty block of rock. The arrows dipped by Heracles in the poisonous blood or gall of the monster ever afterwards inflicted fatal wounds. The generally accepted interpretation of the legend is that "the hydra denotes the damp, swampy ground of Lerna with its numerous springs (*κεφαλαί*, heads); its poison the miasmatic vapours rising from the stagnant water; its death at the hands of Heracles the introduction of the culture and consequent purification of the soil" (Preller). A euhemeristic explanation is given by Palaephatus (39). An ancient king named Lernus occupied a small citadel named Hydra, which was defended by 50 bowmen. Heracles besieged the citadel and hurled firebrands at the garrison. As often as one of the defenders fell, two others at once stepped into his place. The citadel was finally taken with the assistance of the army of Iolaus and the garrison slain.

See Hesiod, *Theog.*, 313; Euripides, *Hercules furens*, 419; Pausanias ii. 37; Apollodorus ii. 5, 2; Diod. Sic. iv. 11; Roscher's *Lexikon der Mythologie*. In the article GREEK ART, fig. 20 represents the slaying of the Lernaean hydra by Heracles.

**HYDRA**, in astronomy, a constellation of the southern hemisphere, mentioned by Eudoxus (4th century B.C.) and Aratus (3rd century B.C.), and catalogued by Ptolemy (27 stars), Tycho Brahe (16) and Hevelius (31). Interesting objects are: the nebula *H. IV. 27 Hydrae*, a planetary nebula, gaseous and whose light is about equal to an 8th magnitude star;  $\epsilon$  *Hydrae*, a beautiful triple star, composed of two yellow stars of the 4th and 6th magnitudes, and a blue star of the 7th magnitude; *R. Hydrae*, a long period (425 days) variable, the range in magnitude being from 4 to 9.7; and *U. Hydrae*, an irregularly variable, the range in magnitude being 4.5 to 6.

**HYDRACRYLIC ACID** (ethylene lactic acid),  $\text{CH}_2\text{OH}\cdot\text{CH}_2\cdot\text{CO}_2\text{H}$ , an organic oxyacid prepared by acting with silver oxide and water on  $\beta$ -iodopropionic acid, or from ethylene by the addition of hypochlorous acid, the addition product being then treated with potassium cyanide and hydrolysed by an acid. It may also be prepared by oxidizing the trimethylene glycol obtained by the action of hydrobromic acid on allylbromide. It is a syrupy liquid, which on distillation is resolved into water and the unsaturated acrylic acid,  $\text{CH}_2=\text{CH}\cdot\text{CO}_2\text{H}$ . Chromic and nitric acids oxidize it to oxalic acid and carbon dioxide. Hydracrylic aldehyde,  $\text{CH}_2\text{OH}\cdot\text{CH}_2\cdot\text{CHO}$ , was obtained in 1904 by J. U. Nef (*Ann.* 335, p. 210) as a colourless oil by heating acrolein with water. Dilute alkalis convert it into crotonaldehyde,  $\text{CH}_3\cdot\text{CH}=\text{CH}\cdot\text{CHO}$ .

**HYDRANGEA**, a popular flower, the plant to which the name is most commonly applied being *Hydrangea Hortensia*, a low deciduous shrub, producing rather large oval strongly-veined leaves in opposite pairs along the stem. It is terminated by a massive globular corymbose head of flowers, which remain a long period in an ornamental condition. The normal colour of the flowers, the majority of which have neither stamens nor pistil, is pink; but by the influence of sundry agents in the soil, such as alum or iron, they become changed to blue. There are numerous varieties, one of the most noteworthy being "Thomas Hogg" with pure white flowers. The part of the inflorescence which appears to be the flower is an exaggerated expansion of the sepals, the other parts being generally abortive. The perfect flowers are small, rarely produced in the species above referred to, but well illustrated by others, in which they occupy the inner parts of the corymb, the larger showy neuter flowers being produced at the circumference.

There are upwards of thirty species, found chiefly in Japan, in the mountains of India, and in North America, and many of them are familiar in gardens. *H. Hortensia* (a species long known in cultivation in China and Japan) is the most useful for decoration, as the head of flowers lasts long in a fresh state, and by the aid of forcing can be had for a considerable period

for the ornamentation of the greenhouse and conservatory. Their natural flowering season is towards the end of the summer, but they may be had earlier by means of forcing. *H. japonica* is another fine conservatory plant, with foliage and habit much resembling the last named, but this has flat corymbs of flowers, the central ones small and perfect, and the outer ones only enlarged and neuter. This also produces pink or blue flowers under the influence of different soils.

The Japanese species of hydrangea are sufficiently hardy to grow in any tolerably favourable situation, but except in the most sheltered localities they seldom blossom to any degree of perfection in the open air, the head of blossom depending on the uninjured development of a well-ripened terminal bud, and this growth being frequently affected by late spring frosts. They are much more useful for pot-culture indoors, and should be reared from cuttings of shoots having the terminal bud plump and prominent, put in during summer, these developing a single head of flowers the succeeding summer. Somewhat larger plants may be had by nipping out the terminal bud and inducing three or four shoots to start in its place, and these, being steadily developed and well ripened, should each yield its inflorescence in the following summer, that is, when two years old. Large plants grown in tubs and vases are fine subjects for large conservatories, and useful for decorating terrace walks and similar places during summer, being housed in winter, and started under glass in spring.

*Hydrangea paniculata* var. *grandiflora* is a very handsome plant; the branched inflorescence under favourable circumstances is a yard or more in length, and consists of large spreading masses of crowded white neuter flowers which completely conceal the few inconspicuous fertile ones. The plant attains a height of 8 to 10 ft. and when in flower late in summer and in autumn is a very attractive object in the shrubbery.

The Indian and American species, especially the latter, are quite hardy, and some of them are extremely effective.

**HYDRASTINE**,  $\text{C}_{11}\text{H}_{21}\text{NO}_6$ , an alkaloid found with berberine in the root of golden seal, *Hydrastis canadensis*, a plant indigenous to North America. It was discovered by Durand in 1851, and its chemistry formed the subject of numerous communications by E. Schmidt and M. Freund (see *Ann.*, 1892, 271, p. 311) who, aided by P. Fritsch (*Ann.*, 1895, 286, p. 1), established its constitution. It is related to narcotine, which is methoxy hydrastine. The root of golden seal is used in medicine under the name hydrastis rhizome, as a stomachic and nerve stimulant.

**HYDRATE**, in chemistry, a compound containing the elements of water in combination; more specifically, a compound containing the monovalent hydroxyl or OH group. The first and more general definition includes substances containing water of crystallization; such salts are said to be hydrated, and when deprived of their water to be dehydrated or anhydrous. Compounds embraced by the second definition are more usually termed *hydroxides*, since at one time they were regarded as combinations of an oxide with water, for example, calcium oxide or lime when slaked with water yielded calcium hydroxide, written formerly as  $\text{CaO}\cdot\text{H}_2\text{O}$ . The general formulae of hydroxides are:  $\text{M}^+\text{OH}$ ,  $\text{M}^{II}(\text{OH})_2$ ,  $\text{M}^{III}(\text{OH})_3$ ,  $\text{M}^{IV}(\text{OH})_4$ , &c., corresponding to the oxides  $\text{M}_2\text{O}$ ,  $\text{M}^{II}\text{O}$ ,  $\text{M}^{III}\text{O}$ ,  $\text{M}^{IV}\text{O}$ , &c., the Roman index denoting the valency of the element. There is an important difference between non-metallic and metallic hydroxides; the former are invariably acids (oxyacids), the latter are more usually basic, although acidic metallic oxides yield acidic hydroxides. Elements exhibiting strong basic or oxygenic characters yield the most stable hydroxides; in other words, stable hydroxides are associated with elements belonging to the extreme groups of the periodic system, and unstable hydroxides with the central members. The most stable basic hydroxides are those of the alkali metals, viz. lithium, sodium, potassium, rubidium and caesium, and of the alkaline earth metals, viz. calcium, barium and strontium; the most stable acidic hydroxides are those of the elements placed in groups VB, VIB and VIIB of the periodic table.

**HYDRAULICS** (Gr. ὕδωρ, water, and αἰδός, a pipe), the branch of engineering science which deals with the practical applications of the laws of hydromechanics.

### I. THE DATA OF HYDRAULICS<sup>1</sup>

§ 1. *Properties of Fluids.*—The fluids to which the laws of practical hydraulics relate are substances the parts of which possess very great mobility, or which offer a very small resistance to distortion independently of inertia. Under the general heading Hydromechanics a fluid is defined to be a substance which yields continually to the slightest tangential stress, and hence in a fluid at rest there can be no tangential stress. But, further, in fluids such as water, air, steam, &c., to which the present division of the article relates, the tangential stresses that are called into action between contiguous portions during distortion or change of figure are always small compared with the weight, inertia, pressure, &c., which produce the visible motions it is the object of hydraulics to estimate. On the other hand, while a fluid passes easily from one form to another, it opposes considerable resistance to change of volume.

It is easily deduced from the absence or smallness of the tangential stress that contiguous portions of fluid act on each other with a pressure which is exactly or very nearly normal to the interface which separates them. The stress must be a pressure, not a tension, or the parts would separate. Further, at any point in a fluid the pressure in all directions must be the same; or, in other words, the pressure on any small element of surface is independent of the orientation of the surface.

§ 2. Fluids are divided into liquids, or incompressible fluids, and gases, or compressible fluids. Very great changes of pressure change the volume of liquids only by a small amount, and if the pressure on them is reduced to zero they do not sensibly dilate. In gases or compressible fluids the volume alters sensibly for small changes of pressure, and if the pressure is indefinitely diminished they dilate without limit.

In ordinary hydraulics, liquids are treated as absolutely incompressible. In dealing with gases the changes of volume which accompany changes of pressure must be taken into account.

§ 3. Viscous fluids are those in which change of form under a continued stress proceeds gradually and increases indefinitely. A very viscous fluid opposes great resistance to change of form in a short time, and yet may be deformed considerably by a small stress acting for a long period. A block of pitch is more easily splintered than indented by a hammer, but under the action of the mere weight of its parts acting for a long enough time it flattens out and flows like a liquid.

All actual fluids are viscous. They oppose a resistance to the relative motion of their parts. This resistance diminishes with the velocity of the relative motion, and becomes zero in a fluid the parts of which are relatively at rest. When the relative motion of different parts of a fluid is small, the viscosity may be neglected without introducing important errors. On the other hand, where there is considerable relative motion,

the viscosity may be expected to have an influence too great to be neglected.

#### Measurement of Viscosity. Coefficient of Viscosity.

Suppose the plane  $ab$ , fig. 2 of area  $\omega$ , to move with the velocity  $V$  relatively to the surface  $cd$  and parallel to it.

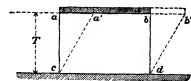

FIG. 1.

Let the space between be filled with liquid. The layers of liquid in contact with  $ab$  and  $cd$  adhere to them. The intermediate layers all offering an equal resistance to shearing or distortion, the rectangle of fluid  $abcd$  will take the form of the parallelogram  $a'b'cd$ . Further, the resistance to the motion of  $ab$  may be expressed in the form

$$R = \kappa \omega V, \quad (1)$$

where  $\kappa$  is a coefficient the nature of which remains to be determined.

If we suppose the liquid between  $ab$  and  $cd$  divided into layers as shown in fig. 2, it will be clear that the stress  $R$  acts, at each dividing face, forwards in the direction of motion if we consider the upper layer, backwards if we consider the lower layer. Now suppose the original thickness of the layer  $T$  increased to  $nT$ ; if the bounding plane in its new position has the velocity  $nV$ , the shearing at each dividing face will be exactly the same as before, and the resistance must therefore be the same. Hence,

$$R = \kappa' \omega (nV). \quad (2)$$

But equations (1) and (2) may both be expressed in one equation if  $\kappa$  and  $\kappa'$  are replaced by a constant varying inversely as the thickness of the layer. Putting  $\kappa = \mu/T$ ,  $\kappa' = \mu/nT$ ,

$$R = \mu \omega V/T;$$

or, for an indefinitely thin layer,

$$R = \mu \omega V/dt, \quad (3)$$

an expression first proposed by L. M. H. Navier. The coefficient  $\mu$  is termed the coefficient of viscosity.

According to J. Clerk Maxwell, the value of  $\mu$  for air at  $60^\circ$  Fahr. in pounds, when the velocities are expressed in feet per second, is

$$\mu = 0.000\ 000\ 025\ 6(461^2 + \theta);$$

that is, the coefficient of viscosity is proportional to the absolute temperature and independent of the pressure.

The value of  $\mu$  for water at  $77^\circ$  Fahr. is, according to H. von Helmholtz and G. Piotrowski,

$$\mu = 0.000\ 018\ 8,$$

the units being the same as before. For water  $\mu$  decreases rapidly with increase of temperature.

§ 4. When a fluid flows in a very regular manner, as for instance when it flows in a capillary tube, the velocities vary gradually at any moment from one point of the fluid to a neighbouring point. The layer adjacent to the sides of the tube adheres to it and is at rest.

The layers more interior than this slide on each other. But the resistance developed by these regular movements is very small. If in large pipes and open channels there were a

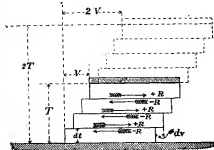

FIG. 2.

similar regularity of movement, the neighbouring filaments would acquire, especially near the sides, very great relative velocities. V. J. Boussinesq has shown that the central filament in a semicircular canal of 1 metre radius, and inclined at a slope of only 0.001, would have a velocity of 187 metres per second,<sup>2</sup> the layer next the boundary remaining at rest. But before such a difference of velocity can arise, the motion of the fluid becomes much more complicated. Volumes of fluid are detached continually from the boundaries, and, revolving, form eddies traversing the fluid in all directions, and sliding with finite relative velocities against those surrounding them. These slidings develop resistances incomparably greater than the viscous resistance due to movements varying continuously from point to point. The movements which produce the phenomena commonly ascribed to fluid friction must be regarded as rapidly or even suddenly varying from one point to another. The internal resistances to the motion of the fluid do not depend merely on the general velocities of translation at different points of the fluid (or what Boussinesq terms the mean local velocities), but rather on the intensity at each point of the eddying agitation. The problems of hydraulics are therefore much more complicated than problems in which a regular motion of the fluid is assumed, hindered by the viscosity of the fluid.

### RELATION OF PRESSURE, DENSITY, AND TEMPERATURE OF LIQUIDS

§ 5. *Units of Volume.*—In practical calculations the cubic foot and gallon are largely used, and in metric countries the litre and cubic metre (= 1000 litres). The imperial gallon is now exclusively used in England, but the United States have retained the old English wine gallon.

<sup>1</sup> Except where other units are given, the units throughout this article are feet, pounds, pounds per sq. ft., feet per second.

<sup>2</sup> *Journal de M. Liouville*, t. xiii. (1868); *Mémoires de l'Académie des Sciences de l'Institut de France*, t. xxiii. xxiv. (1877).

1 cub. ft.	= 6.236 imp. gallons	= 7.481 U.S. gallons.
1 imp. gallon	= 0.1605 cub. ft.	= 1.200 U.S. gallons.
1 U.S. gallon	= 0.1337 cub. ft.	= 0.8333 imp. gallon.
1 litre	= 0.2201 imp. gallon	= 0.2641 U.S. gallon.

**Density of Water.**—Water at 53° F. and ordinary pressure contains 62.4 lb per cub. ft., or 10 lb per imperial gallon at 62° F. The litre contains one kilogram of water at 4° C. or 1000 kilograms per cubic metre. River and spring water is not sensibly denser than pure water. But average sea water weighs 64 lb per cub. ft. at 53° F. The weight of water per cubic unit will be denoted by  $G$ . Ice free from air weighs 57.28 lb per cub. ft. (Leduc).

§ 6. **Compressibility of Liquids.**—The most accurate experiments show that liquids are sensibly compressed by very great pressures, and that up to a pressure of 65 atmospheres, or about 1000 lb per sq. in., the compression is proportional to the pressure. The chief results of experiment are given in the following table. Let  $V_1$  be the volume of a liquid in cubic feet under a pressure  $p_1$  lb per sq. ft., and  $V_2$  its volume under a pressure  $p_2$ . Then the cubical compression is  $(V_2 - V_1)/V_1$ , and the ratio of the increase of pressure  $p_2 - p_1$  to the cubical compression is sensibly constant. That is,  $k = (p_2 - p_1)V_1/(V_2 - V_1)$  is constant. This constant is termed the *elasticity of volume*. With the notation of the differential calculus,

$$k = dp / \left( -\frac{dV}{V} \right) = -V \frac{dp}{dV}$$

*Elasticity of Volume of Liquids.*

	Canton.	Oersted.	Colladon and Sturm.	Regnault.
Water	45,990,000	45,900,000	42,660,000	44,090,000
Sea water	52,900,000	..	..	..
Mercury	705,300,000	..	626,100,000	604,500,000
Oil	44,090,000	..	..	..
Alcohol	32,600,000	..	23,100,000	..

According to the experiments of Grassi, the compressibility of water diminishes as the temperature increases, while that of ether, alcohol and chloroform is increased.

§ 7. **Change of Volume and Density of Water with Change of Temperature.**—Although the change of volume of water with change of temperature is so small that it may generally be neglected in ordinary hydraulic calculations, yet it should be noted that there is a change of volume which should be allowed for in very exact calculations. The values of  $\rho$  in the following short table, which gives data enough for hydraulic purposes, are taken from Professor Everett's *System of Units*.

*Density of Water at Different Temperatures.*

Temperature.		$\rho$	$G$	Temperature.		$\rho$	$G$
Cent.	Fahr.	Density of Water.	Weight of 1 cub. ft. in lb.	Cent.	Fahr.	Density of Water.	Weight of 1 cub. ft. in lb.
0	32.0	.999884	62.417	20	68.0	.998272	62.316
1	33.8	.999941	62.420	22	71.6	.997839	62.289
2	35.6	.999982	62.423	24	75.2	.997380	62.261
3	37.4	1.000004	62.424	24	75.8	.996979	62.229
4	39.2	1.000013	62.425	28	82.4	.996344	62.196
5	41.0	1.000003	62.424	30	86	.995778	62.161
6	42.8	.999983	62.423	35	95	.99499	62.093
7	44.6	.999946	62.421	40	104	.99236	61.947
8	46.4	.999899	62.418	45	113	.99038	61.823
9	48.2	.999837	62.414	50	122	.98821	61.688
10	50.0	.999760	62.409	55	131	.98583	61.540
11	51.8	.999668	62.403	60	140	.98339	61.387
12	53.6	.999562	62.396	65	149	.98091	61.224
13	55.4	.999443	62.389	70	158	.97795	61.048
14	57.2	.999312	62.381	75	167	.97499	60.863
15	59.0	.999173	62.373	80	176	.97195	60.674
16	60.8	.999015	62.363	85	185	.96880	60.477
17	62.6	.998854	62.353	90	194	.96557	60.275
18	64.4	.998667	62.341	100	212	.95866	59.884
19	66.2	.998473	62.329				

The weight per cubic foot has been calculated from the values of  $\rho$ , on the assumption that 1 cub. ft. of water at 39.2° Fahr. is 62.425 lb. For ordinary calculations in hydraulics, the density of water (which will in future be denoted by the symbol  $G$ ) will be taken at 62.4 lb per cub. ft., which is its density at 53° Fahr. It may be noted also that ice at 32° Fahr. contains 57.3 lb per cub. ft. The values of  $\rho$  are the densities in grammes per cubic centimetre.

§ 8. **Pressure Column. Free Surface Level.**—Suppose a small vertical pipe introduced into a liquid at any point P (fig. 3). Then the liquid will rise in the pipe to a level OO, such that the pressure due to the column in the pipe exactly balances the pressure on its mouth. If the fluid is in motion the mouth of the pipe must be supposed accurate parallel to the direction of motion, or the impact of the liquid at the mouth of the pipe will have an influence on the height of the column. If this condition is complied with,

the height  $h$  of the column is a measure of the pressure at the point P. Let  $\omega$  be the area of section of the pipe,  $h$  the height of the pressure column,  $p$  the intensity of pressure at P; then

$$p\omega = Gh\omega,$$

$$p/G = h;$$

that is,  $h$  is the height due to the pressure at  $p$ . The level OO will be termed the free surface level corresponding to the pressure at P.

RELATION OF PRESSURE, TEMPERATURE, AND DENSITY OF GASES

§ 9. **Relation of Pressure, Volume, Temperature and Density in Compressible Fluids.**—Certain problems on the flow of air and steam are so similar to those relating to the flow of water that they are conveniently treated together. It is necessary, therefore, to state as briefly as possible the properties of compressible fluids so far as knowledge of them is requisite in the solution of these problems. Air may be taken as a type of these fluids, and the numerical data here given will relate to air.

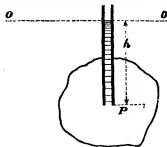

FIG. 3.

*Relation of Pressure*

*and Volume at Constant Temperature.*—At constant temperature the pressure  $p$  and volume  $V$  of a given quantity of air is a constant (Boyle's law).

Let  $p_0$  be mean atmospheric pressure (2116.8 lb per sq. ft.),  $V_0$  the volume of 1 lb of air at 32° Fahr. under the pressure  $p_0$ . Then

$$p_0 V_0 = 26214. \quad (1)$$

If  $G_0$  is the weight per cubic foot of air in the same conditions,

$$G_0 = 1/V_0 = 2116.8/26214 = .08075. \quad (2)$$

For any other pressure  $p$ , at which the volume of 1 lb is  $V$  and the weight per cubic foot is  $G$ , the temperature being 32° Fahr.,

$$pV = p_0 V_0 = 26214; \text{ or } G = p/26214. \quad (3)$$

*Change of Pressure or Volume by Change of Temperature.*—Let  $p_0, V_0, G_0$ , as before be the pressure, the volume of a pound in cubic feet, and the weight of a cubic foot in pounds, at 32° Fahr. Let  $p, V, G$  be the same quantities at a temperature  $t$  (measured strictly by the air thermometer, the degrees of which differ a little from those of a mercurial thermometer). Then, by experiment,

$$pV = p_0 V_0 (460.6 + t)/(460.6 + 32) = p_0 V_0 \tau_0, \quad (4)$$

where  $\tau, \tau_0$  are the temperatures  $t$  and 32° reckoned from the absolute zero, which is  $-460.6$ ° Fahr.;

$$p/G = \text{per } (G_0 \tau_0), \quad (4a)$$

$$p/G = \text{per } (G_0 \tau_0 \text{ per } \tau). \quad (5)$$

If  $p_0 = 2116.8, G_0 = .08075, \tau_0 = 460.6 + 32 = 492.6$ , then

$$p/G = 53.2\tau. \quad (5a)$$

Or quite generally  $p/G = R\tau$  for all gases, if  $R$  is a constant varying inversely as the density of the gas at 32° F. For steam  $R = 85.5$ .

## II. KINEMATICS OF FLUIDS

§ 10. **Moving fluids** as commonly observed are conveniently classified thus:

- (1) *Streams* are moving masses of indefinite length, completely or incompletely bounded laterally by solid boundaries. When the solid boundaries are complete, the flow is said to take place in a pipe. When the solid boundary is incomplete and leaves the upper surface of the fluid free, it is termed a stream bed or channel or canal.
- (2) A stream bounded laterally by differently moving fluid of the same kind is termed a *current*.
- (3) A *jet* is a stream bounded by fluid of a different kind.
- (4) An *eddy, vortex or whirlpool* is a mass of fluid the particles of which are moving circularly or spirally.
- (5) In a stream we may often regard the particles as flowing along definite paths in space. A chain of particles following each other along such a constant path may be termed a fluid filament or elementary stream.

§ 11. **Steady and Unsteady, Uniform and Varying Motion.**—There are two quite distinct ways of treating hydrodynamical questions. We may either fix attention on a given mass of fluid and consider its changes of position and energy under the action of the stresses to which it is subjected, or we may have regard to a given fixed portion of space, and consider the volume and energy of the fluid entering and leaving that space.



If, in following a given path  $ab$  (fig. 4), a mass of water  $a$  has a constant velocity, the motion is said to be uniform. The kinetic energy of the mass  $a$  remains unchanged. If the velocity varies from point to point of the path, the motion is called varying motion. If at a given point  $a$  in space, the particles of water always arrive with the same velocity and in the same direction, during any given time, then the motion is termed steady motion. On the contrary, if at the point  $a$  the velocity or direction varies from moment to moment the motion is termed unsteady. A river which excavates its own bed is in unsteady motion so long as the slope and form of the bed is changing. It, however,

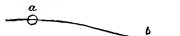

FIG. 4.

tends always towards a condition in which the bed ceases to change, and it is then said to have reached a condition of permanent regime. No river probably is in an absolutely permanent regime, except perhaps in rocky channels. In other cases the bed is scoured more or less during the rise of a flood, and silted again during the subsidence of the flood. But while many streams of a torrential character change the condition of their bed often and to a large extent, in others the changes are comparatively small and not easily observed.

As a stream approaches a condition of steady motion, its regime becomes permanent. Hence steady motion and permanent regime are sometimes used as meaning the same thing. The one, however, is a definite term applicable to the motion of the water, the other a less definite term applicable in strictness only to the condition of the stream bed.

§ 12. *Theoretical Notions on the Motion of Water.*—The actual motion of the particles of water is in most cases very complex. To simplify hydrodynamic problems, simpler modes of motion are assumed, and the results of theory so obtained are compared experimentally with the actual motions.

*Motion in Plane Layers.*—The simplest kind of motion in a stream is one in which the particles initially situated in any plane cross

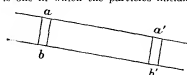

FIG. 5.

to be motion in plane layers. In such motion the internal work in deforming the layer may usually be disregarded, and the resistance to the motion is confined to the circumference.

*Laminar Motion.*—In the case of streams having solid boundaries, it is observed that the central parts move faster than the lateral parts. To take account of these differences of velocity, the stream may be conceived to be divided into thin laminae, having cross sections somewhat similar to the solid boundary of the stream, and sliding on each other. The different laminae can then be treated as having differing velocities according to any law either observed or deduced from their mutual friction. A much closer approximation to the real motion of ordinary streams is thus obtained.

*Stream Line Motion.*—In the preceding hypothesis, all the particles in each lamina have the same velocity at any given cross section of the stream. If this assumption is abandoned, the cross section of the stream must be supposed divided into indefinitely small areas, each representing the section of a fluid filament. Then these filaments may have any law of variation of velocity assigned to them. If the motion is steady motion these fluid filaments (or as they are then termed *stream lines*) will have fixed positions in space.

*Periodic Unsteady Motion.*—In ordinary streams with rough boundaries, it is observed that at any given point the velocity varies from moment to moment in magnitude and direction, but that the average velocity for a sensible period (say for 5 or 10 minutes) varies very little either in magnitude or velocity. It has hence

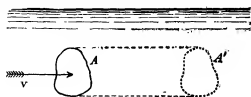

FIG. 6.

been conceived that the variations of direction and magnitude of the velocity are periodic, and that, if for each point of the stream the mean velocity and direction of motion were substituted for the actual more or less varying motions, the motion of the stream might be treated as steady stream line or steady laminar motion.

§ 13. *Volume of Flow.*—Let  $A$  (fig. 6) be any ideal plane surface, of area  $\omega$ , in a stream, normal to the direction of motion, and let  $V$

be the velocity of the fluid. Then the volume flowing through the surface  $A$  in unit time is

$$Q = \omega V. \quad (1)$$

Thus, if the motion is rectilinear, all the particles at any instant in the surface  $A$  will be found after one second in a similar surface  $A'$ , at a distance  $V$ , and as each particle is followed by a continuous thread of other particles, the volume of flow is the right prism  $AA'$  having a base  $\omega$  and length  $V$ .

If the direction of motion makes an angle  $\theta$  with the normal to the surface, the volume of flow is represented by an oblique prism  $AA'$  (fig. 7), and in that case

$$Q = \omega V \cos \theta.$$

If the velocity varies at different points of the surface, let the surface be divided into very small portions, for each of which the



FIG. 7.

velocity may be regarded as constant. If  $d\omega$  is the area and  $v$ , or  $v \cos \theta$ , the normal velocity for this element of the surface, the volume of flow is

$$Q = \int v d\omega, \text{ or } \int v \cos \theta d\omega,$$

as the case may be.

§ 14. *Principle of Continuity.*—If we consider any completely bounded fixed space in a moving liquid initially and finally filled continuously with liquid, the inflow must be equal to the outflow. Expressing the inflow with a positive and the outflow with a negative sign, and estimating the volume of flow  $Q$  for all the boundaries,  $\Sigma Q = 0$ .

In general the space will remain filled with fluid if the pressure at every point remains positive. There will be a break of continuity, if at any point the pressure becomes negative, indicating that the stress at that point is tensile. In the case of ordinary water this statement requires modification. Water contains a variable amount of air in solution, often about one-twentieth of its volume. This air is disengaged and breaks the continuity of the liquid, if the pressure falls below a point corresponding to its tension. It is for this reason that pumps will not draw water to the full height due to atmospheric pressure.

*Application of the Principle of Continuity to the case of a Stream.*—If  $A_1, A_2$  are the areas of two normal cross sections of a stream, and  $V_1, V_2$  are the velocities of the stream at those sections, then from the principle of continuity,

$$V_1 A_1 = V_2 A_2; \quad (2)$$

that is, the normal velocities are inversely as the areas of the cross sections. This is true of the mean velocities, if at each section the velocity of the stream varies. In a river of varying slope the velocity varies with the slope. It is easy therefore to see that in parts of large cross section the slope is smaller than in parts of small cross section.

If we conceive a space in a liquid bounded by normal sections at  $A_1, A_2$  and between  $A_1, A_2$  by stream lines (fig. 8), then, as there is no flow across the stream lines,

$$V_1 A_1 = A_2 A_2,$$

as in a stream with rigid boundaries.

In the case of compressible fluids the variation of volume due to the difference of pressure at the two sections must be taken into

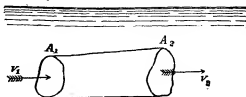

FIG. 8.

account. If the motion is steady the weight of fluid between two cross sections of a stream must remain constant. Hence the weight flowing in must be the same as the weight flowing out. Let  $p_1, p_2$  be the pressures,  $v_1, v_2$  the velocities,  $G_1, G_2$  the weight per cubic foot of fluid, at cross sections of a stream of areas  $A_1, A_2$ . The volumes of inflow and outflow are

$$A_1 v_1 \text{ and } A_2 v_2,$$

and, if the weights of these are the same,

$$G_1 A_1 v_1 = G_2 A_2 v_2;$$

and hence, from (5a) § 9, if the temperature is constant,

$$p_1 A_1 v_1 = p_2 A_2 v_2. \quad (3)$$

§ 15. *Stream Lines*.—The characteristic of a perfect fluid, that is, a fluid free from viscosity, is that the pressure between any two parts into which it is divided by a plane must be normal to the plane. One consequence of this is that the particles can have no rotation impressed upon them, and the motion of such a fluid is irrotational. A stream line is the line, straight or curved, traced by a particle in a current of fluid in irrotational movement. In a steady current

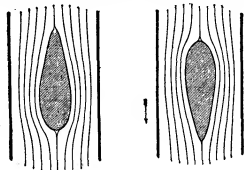

FIG. 9.

each stream line preserves its figure and position unchanged, and marks the track of a stream of particles forming a fluid filament or elementary stream. A current in steady irrotational movement may be conceived to be divided by insensibly thin partitions following the course of the stream lines into a number of elementary streams. If the positions of these partitions are so adjusted that the volumes of flow in all the elementary streams are equal, they represent to the mind the velocity as well as the direction of motion of the particles in different parts of the current, for the velocities

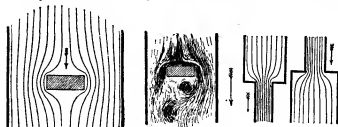

FIG. 10.

FIG. 11.

FIG. 12.

are inversely proportional to the cross sections of the elementary streams. No actual fluid is devoid of viscosity, and the effect of viscosity is to render the motion of a fluid sinuous, or rotational or eddying under most ordinary conditions. At very low velocities in a tube of moderate size the motion of water may be nearly pure stream line motion. But at some velocity, smaller as the diameter of the tube is greater, the motion suddenly becomes tumultuous. The laws of simple stream line motion have hitherto been investigated theoretically, and from mathematical difficulties have only been determined for certain simple cases. Professor H. S. Hele Shaw has found means of exhibiting stream line motion in a number of very interesting cases experimentally. Generally in these experiments a thin sheet of fluid is caused to flow between two parallel plates of glass. In the earlier experiments streams of very small air bubbles introduced into the water current rendered visible the motions of the water. By the use of a lantern the image of a portion of the current can be shown on a screen or photographed. In later experiments streams of coloured liquid at regular distances were introduced into the sheet and these much more clearly marked out the forms of the stream lines. With a fluid sheet 0.02 in. thick, the stream lines were found to be stable at almost any required velocity. For certain simple cases Professor Hele Shaw has shown that the experimental stream lines of a viscous fluid are

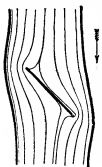

FIG. 13.

so far as can be measured identical with the calculated stream lines of a perfect fluid. Sir G. G. Stokes pointed out that in this case, either from the thinness of the stream between its glass walls, or the slowness of the motion, or the high viscosity of the liquid, or from a combination of all these, the flow is regular, and the effects of inertia disappear, the viscosity dominating everything. Glycerine gives the stream lines very satisfactorily.

FIG. 9 shows the stream lines of a sheet of fluid passing a fairly

shipshaped body such as a screwshaft strut. The arrow shows the direction of motion of the fluid. FIG. 10 shows the stream lines for a very thin glycerine sheet passing a non-shipshaped body, the stream lines being practically perfect. FIG. 11 shows one of the earlier air-bubble experiments with a thicker sheet of water. In this case the stream lines break up behind the obstruction, forming an eddying wake. FIG. 12 shows the stream lines of a fluid passing a sudden contraction or sudden enlargement of a pipe. Lastly, FIG. 13 shows the stream lines of a current passing an oblique plane. H. S. Hele Shaw, "Experiments on the Nature of the Surface Resistance in Pipes and on Ships," *Trans. Inst. Naval Arch.* (1897). "Investigation of Stream Line Motion under certain Experimental Conditions," *Trans. Inst. Naval Arch.* (1898). "Stream Line Motion of a Viscous Fluid," *Report of British Association* (1898).

### III. PHENOMENA OF THE DISCHARGE OF LIQUIDS FROM ORIFICES AS ASCERTAINED BY EXPERIMENTS

§ 16. When a liquid issues vertically from a small orifice, it forms a jet which rises nearly to the level of the free surface of the liquid

in the vessel from which it flows. The difference of level  $h_r$  (fig. 14) is so small that it may be at once suspected to be due either to air resistance on the surface of the jet or to the viscosity of the liquid or to friction against the sides of the orifice. Neglecting for the moment these small quantities, we may infer, from the elevation of the jet, that each molecule on leaving the orifice possessed the velocity required to lift it against gravity to the height  $h$ . From ordinary dynamics, the relation between the velocity and height of projection is given by the equation

$$v = \sqrt{2gh}. \quad (1)$$

As this velocity is nearly reached in the flow from well-formed orifices, it is sometimes called the theoretical velocity of discharge. This relation was first obtained by Torricelli.

If the orifice is of a suitable conoidal form, the water issues in filaments normal to the plane of the orifice. Let  $\omega$  be the area of the orifice, then the discharge per second must be, from eq. (1),

$$Q = \omega v = \omega \sqrt{2gh} \text{ nearly.} \quad (2)$$

This is sometimes quite improperly called the theoretical discharge for any kind of orifice. Except for a well-formed conoidal orifice the result is not approximate even, so that if it is supposed to be based on a theory the theory is a false one.

*Use of the term Head in Hydraulics.*—The term *head* is an old millwright's term, and meant primarily the height through which a mass of water descended in actuating a hydraulic machine. Since the water in fig. 14 descends through a height  $h$  to the orifice, we may say there are  $h$  ft. of head above the orifice. Still more generally any mass of liquid  $h$  ft. above a horizontal plane may be said to have  $h$  ft. of elevation head relatively to that datum plane. Further, since the pressure  $p$  at the orifice which produces outflow is connected with  $h$  by the relation  $p/G = h$ , the quantity  $p/G$  may be termed the pressure head at the orifice. Lastly, the velocity  $v$  is connected with  $h$  by the relation  $v^2/2g = h$ , so that  $v^2/2g$  may be termed the head due to the velocity  $v$ .

§ 17. *Coefficients of Velocity and Resistance.*—As the actual velocity of discharge differs from  $\sqrt{2gh}$  by a small quantity, let the actual velocity

$$= v_a = c_v \sqrt{2gh}, \quad (3)$$

where  $c_v$  is a coefficient to be determined by experiment, called the *coefficient of velocity*. This coefficient is found to be tolerably constant for different heads with well-formed simple orifices, and it very often has the value 0.97.

The difference between the velocity of discharge and the velocity due to the head may be reckoned in another way. The total height  $h$  causing outflow consists of two parts—one part  $h_r$  expended effectively in producing the velocity of outflow, another  $h_f$  in overcoming the resistances due to viscosity and friction. Let

$$h_r = c_r h,$$

where  $c_r$  is a coefficient determined by experiment, and called the *coefficient of resistance* of the orifice. It is tolerably constant for different heads with well-formed orifices. Then

$$v_a = \sqrt{2gh_r} = \sqrt{2gh/(1+c_r)}. \quad (4)$$

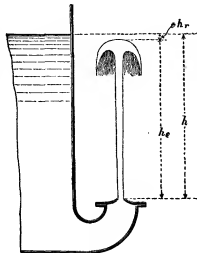

FIG. 14.

The relation between  $c_a$  and  $c_c$  for any orifice is easily found:—

$$v_a = c_a \sqrt{2gh} = \sqrt{2gh/(1+c_r)} \\ c_a = \sqrt{1/(1+c_r)} \quad (5) \\ c_r = 1/c_a^2 - 1 \quad (5a)$$

Thus if  $c_a = 0.97$ , then  $c_r = 0.0628$ . That is, for such an orifice about 6½% of the head is expended in overcoming frictional resistances to flow.

**Coefficient of Contraction—Sharp-edged Orifices in Plane Surfaces.**—When a jet issues from an aperture in a vessel, it may either spread

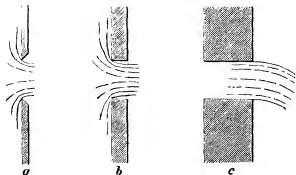

FIG. 15.

clear from the inner edge of the orifice as at  $a$  or  $b$  (fig. 15), or it may adhere to the sides of the orifice as at  $c$ . The former condition will be found if the orifice is bevelled outwards as at  $a$ , so as to be sharp edged, and it will also occur generally for a prismatic aperture like  $b$ , provided the thickness of the plate in which the aperture is formed is less than the diameter of the jet. But if the thickness is greater the condition shown at  $c$  will occur.

When the discharge occurs as at  $a$  or  $b$ , the filaments converging towards the orifice continue to converge beyond it, so that the section of the jet where the filaments have become parallel is smaller than the section of the orifice. The inertia of the filaments opposes sudden change of direction of motion at the edge of the orifice, and the convergence continues for a distance of about half the diameter of the orifice beyond it. Let  $\omega$  be the area of the orifice, and  $\omega_a$  the area of the jet at the point where convergence ceases; then  $c_c$  is a coefficient to be determined experimentally for each kind of orifice, called the *coefficient of contraction*. When the orifice is a sharp-edged orifice in a plane surface, the value of  $c_c$  is on the average 0.64, or the section of the jet is very nearly five-eighths of the area of the orifice.

**Coefficient of Discharge.**—In applying the general formula  $Q = \omega v$  to a stream, it is assumed that the filaments have a common velocity  $v$  normal to the section  $\omega$ . But if the jet contracts, it is at the contracted section of the jet that the direction of motion is normal to a transverse section of the jet. Hence the actual discharge when contraction occurs is  $Q_a = c_a \omega \times c_c \omega = c_c c_a \omega v$  (2gh), or simply, if  $c = c_c c_a$ ,  $Q_a = c \omega v$  (2gh), where  $c$  is called the *coefficient of discharge*. Thus for a sharp-edged plane orifice  $c = 0.97 \times 0.64 = 0.62$ .

§ 18. **Experimental Determination of  $c_a$ ,  $c_c$ , and  $c$ .**—The coefficient of contraction  $c_c$  is directly determined by measuring the dimensions of the jet.

Let OX, OY (fig. 17) be horizontal and vertical axes, the origin being at the orifice. Let  $h$  be the head, and  $x, y$  the coordinates of a point A on the parabolic path of the jet. If  $v_a$  is the velocity at

the orifice, and  $t$  the time in which a particle moves from O to A, then

$$x = v_a t; \quad y = \frac{1}{2} g t^2.$$

Eliminating  $t$ ,

$$v_a = \sqrt{(gx^2/2y)}.$$

Then

$$c_a = v_a / \sqrt{(2gh)} = \sqrt{(x^2/4yh)}.$$

In the case of large orifices such as weirs, the velocity can be directly determined by using a Pitot tube (§ 144).

The coefficient of discharge, for this practical purpose is the most important of the three coefficients, is best determined by tank

measurement of the flow from the given orifice in a suitable time. If  $Q$  is the discharge measured in the tank per second, then  $c = Q/\omega \sqrt{(2gh)}$ . Measurements of this kind though simple in principle are not free from some practical difficulties, and require much care. In fig. 18 is shown an arrangement of measuring tank.

The orifice is fixed in the wall of the cistern A and discharges either into the waste channel BB, or into the measuring tank. There is a short trough on rollers C which when run under the jet directs the discharge into the tank, and when run back again allows the discharge to drop

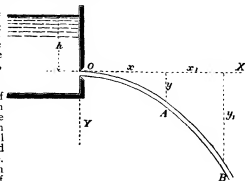

FIG. 17.

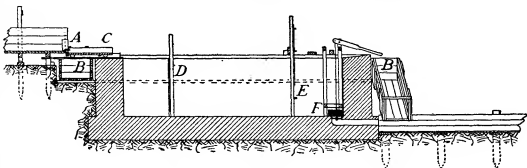

FIG. 18.

into the waste channel. D is a stilling screen to prevent agitation of the surface at the measuring point, E, and F is a discharge valve for emptying the measuring tank. The rise of level in the tank, the time of the flow and the head over the orifice at that time must be exactly observed.

For well made sharp-edged orifices, small relatively to the water surface in the supply reservoir, the coefficients under different conditions of head are pretty exactly known. Suppose the same quantity of water is made to flow in succession through such an orifice and through another orifice of which the coefficient is required, and when the rate of flow is constant the heads over each orifice are noted. Let  $h_1, h_2$  be the heads,  $\omega_1, \omega_2$  the areas of the orifices,  $c_1, c_2$  the coefficients. Then since the flow through each orifice is the same

$$Q = c_1 \omega_1 \sqrt{(2gh_1)} = c_2 \omega_2 \sqrt{(2gh_2)} \\ c_2 = c_1 (\omega_1/\omega_2) \sqrt{(h_1/h_2)}.$$

§ 19. **Coefficients for Bellmouths and Bellmouthed Orifices.**—If an orifice is furnished with a mouthpiece exactly of the form of the

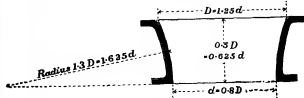

FIG. 19.

contracted vein, then the whole of the contraction occurs within the mouthpiece, and if the area of the orifice is measured at the smaller end,  $c_p$  must be put = 1. It is often desirable to contract the ends of pipes, to avoid the loss of head which occurs if this is

not done; and such a bellmouth may also have the form of the contracted jet. Fig. 19 shows the proportions of such a bellmouth or bellmouth orifice, which approximates to the form of the contracted jet sufficiently for any practical purpose.

For such an orifice L. J. Weisbach found the following values of the coefficients with different heads.

Head over orifice, in ft. = $h$	.66	1.64	11.48	55.77	337.93
Coefficient of velocity = $c_v$	.959	.967	.975	.994	.994
Coefficient of resistance = $c_r$	.087	.069	.052	.012	.012

As there is no contraction after the jet issues from the orifice,  $c_c = 1$ ,  $c = c_v$ ; and therefore

$$Q = c_v c_w \sqrt{2gh} = \omega \sqrt{2gh} / (1 + c_r).$$

§ 20. *Coefficients for Sharp-edged or virtually Sharp-edged Orifices.*—There are a very large number of measurements of discharge from sharp-edged orifices under different conditions of head. An account of these and a very careful tabulation of the average values of the coefficients will be found in the *Hydraulics* of the late Hamilton Smith (Wiley & Sons, New York, 1886). The following short table abstracted from a larger one will give a fair notion of how the coefficient varies according to the most trustworthy of the experiments.

*Coefficient of Discharge for Vertical Circular Orifices, Sharp-edged, with free Discharge into the Air.*  $Q = c_w \omega \sqrt{2gh}$ .

Head measured to Centre of Orifice.	Diameters of Orifice.						
	.02	.04	.10	.20	.40	.60	1.0
	Values of $C$ .						
0.3	..	..	.621	..	..	..	..
0.4	..	.637	.618	..	..	..	..
0.6	.655	.630	.613	.601	.596	.588	..
0.8	.648	.626	.610	.601	.597	.594	.583
1.0	.644	.623	.608	.600	.598	.595	.591
2.0	.632	.614	.604	.599	.599	.597	.595
4.0	.623	.609	.602	.599	.598	.597	.596
8.0	.614	.605	.600	.598	.597	.596	.596
20.0	.601	.599	.596	.596	.596	.596	.594

At the same time it must be observed that differences of sharpness in the edge of the orifice and some other circumstances affect the results, so that the values found by different careful experimenters are not a little discrepant. When exact measurement of flow has to be made by a sharp-edged orifice it is desirable that the coefficient for the particular orifice should be directly determined.

The following results were obtained by Dr H. T. Bovey in the laboratory of McGill University.

*Coefficient of Discharge for Sharp-edged Orifices.*

Head in ft.	Form of Orifice.							
	Circular.	Square.		Rectangular Ratio of Sides 4:1.		Rectangular Ratio of Sides 16:1.		Triangular.
		Sides vertical.	Diagonal vertical.	Long Sides vertical.	Long Sides horizontal.	Long Sides vertical.	Long Sides horizontal.	
1	.620	.627	.628	.642	.643	.663	.664	.636
2	.613	.620	.628	.634	.636	.650	.651	.628
4	.608	.616	.618	.628	.629	.641	.642	.623
6	.607	.614	.616	.626	.627	.637	.637	.620
8	.606	.613	.614	.623	.625	.634	.635	.619
10	.605	.612	.613	.622	.624	.632	.633	.618
12	.604	.611	.612	.622	.623	.631	.631	.618
14	.604	.610	.612	.621	.622	.630	.630	.618
16	.603	.610	.611	.620	.622	.630	.630	.617
18	.603	.610	.611	.620	.621	.630	.630	.616
20	.603	.609	.611	.620	.621	.629	.628	.616

The orifice was 0.196 sq. in. area and the reductions were made with  $g = 32.176$  the value for Montreal. The value of the coefficient appears to increase as (perimeter) / (area) increases. It decreases as the head increases. It decreases a little as the size of the orifice is greater.

Very careful experiments by J. G. Mair (*Proc. Inst. Civ. Eng.* lxxvii.) on the discharge from circular orifices gave the results shown on top of next column.

The edges of the orifices were got up with scrapers to a sharp square edge. The coefficients generally fall as the head increases and as the diameter increases. Professor W. C. Unwin found that the results agree with the formula

$$c = 0.6075 + 0.0098 \sqrt{h} - 0.0037d,$$

where  $h$  is in feet and  $d$  in inches.

*Coefficients of Discharge from Circular Orifices.*  
Temperature  $51^\circ$  to  $55^\circ$ .

Head in feet $h$ .	Diameters of Orifices in Inches ( $d$ ).						
	1	1½	1½	2	2½	2½	3
Coefficients ( $c$ ).							
.75	.616	.614	.616	.610	.616	.607	.609
1.0	.613	.612	.612	.611	.612	.611	.604
1.25	.613	.614	.610	.608	.612	.608	.605
1.50	.610	.612	.611	.606	.610	.607	.605
1.75	.612	.611	.611	.605	.611	.607	.605
2.00	.609	.613	.609	.606	.609	.606	.605

The following table, compiled by J. T. Fanning (*Treatise on Water Supply Engineering*), gives values for rectangular orifices in vertical plane surfaces, the head being measured, not immediately over the orifice, where the surface is depressed, but to the still-water surface at some distance from the orifice. The values were obtained by graphic interpolation, all the most reliable experiments being plotted and curves drawn so as to average the discrepancies.

*Coefficients of Discharge for Rectangular Orifices, Sharp-edged, in Vertical Plane Surfaces.*

Head to Centre of Orifice.	Ratio of Height to Width.							
	4	2	1½	1	½	½	½	½
Feet.								
0.2	4 ft. high, 1 ft. wide.	2 ft. high, 1 ft. wide.	1½ ft. high, 1 ft. wide.	1 ft. high, 1 ft. wide.	0.75 ft. high, 1 ft. wide.	0.5 ft. high, 1 ft. wide.	0.25 ft. high, 1 ft. wide.	0.125 ft. high, 1 ft. wide.
.3	..	..	..	..	..	..	.6293	.6333
.4	..	..	..	..	..	..	.6140	.6306
.5	..	..	..	..	..	..	.6150	.6313
.6	..	..	..	..	.5984	.6063	.6156	.6317
.7	..	..	..	..	.5904	.6074	.6162	.6319
.8	..	..	..	.6130	.6000	.6082	.6165	.6322
.9	..	..	..	.6134	.6006	.6086	.6168	.6323
1.0	..	..	..	.6135	.6010	.6090	.6172	.6320
1.25	..	.6188	.6140	.618	.6095	.6173	.6317	.6312
1.50	..	.6187	.6144	.626	.6100	.6172	.6313	.6303
1.75	..	.6186	.6145	.6033	.6103	.6168	.6307	.6296
2	..	.6183	.6144	.6036	.6104	.6166	.6302	.6291
2.25	..	.6180	.6143	.6029	.6103	.6165	.6293	.6286
2.50	.6290	.6176	.6139	.6043	.6102	.6157	.6282	.6278
2.75	.6280	.6173	.6136	.6043	.6101	.6155	.6274	.6273
3	.6273	.6170	.6132	.6048	.6100	.6153	.6267	.6267
3.5	.6250	.6160	.6123	.6050	.6094	.6146	.6254	.6254
4	.6245	.6150	.6110	.6047	.6085	.6136	.6236	.6236
4.5	.6226	.6138	.6100	.6044	.6074	.6125	.6222	.6222
5	.6208	.6124	.6088	.6038	.6063	.6114	.6202	.6202
6	.6158	.6094	.6063	.6020	.6044	.6087	.6154	.6154
7	.6124	.6064	.6038	.6011	.6032	.6058	.6110	.6114
8	.6090	.6036	.6022	.6010	.6022	.6033	.6073	.6087
9	.6060	.6020	.6014	.6010	.6015	.6020	.6045	.6070
10	.6035	.6015	.6010	.6010	.6010	.6010	.6030	.6060
15	.6040	.6018	.6010	.6011	.6012	.6013	.6033	.6066
20	.6045	.6024	.6012	.6012	.6014	.6018	.6035	.6067
25	.6048	.6028	.6014	.6012	.6016	.6022	.6040	.6083
30	.6054	.6034	.6017	.6013	.6018	.6027	.6044	.6092
35	.6060	.6039	.6021	.6014	.6022	.6032	.6049	.6103
40	.6066	.6045	.6025	.6015	.6026	.6037	.6055	.6114
45	.6054	.6052	.6029	.6016	.6030	.6043	.6062	.6125
50	.6086	.6060	.6034	.6018	.6035	.6050	.6070	.6140

§ 21. *Orifices with Edges of Sensible Thickness.*—When the edges of the orifice are not bevelled outwards, but have a sensible thickness, the coefficient of discharge is somewhat altered. The following table gives values of the coefficient of discharge for the arrangements of the orifice shown in vertical section at P, Q, R (fig. 20). The plan of all the orifices is shown at S. The planks forming the orifice and sluice were each 2 in. thick, and the orifices were all 24 in. wide. The heads were measured immediately over the orifice. In this case,

$$Q = cb(H+h) \sqrt{2g(H+h)/2}.$$

§ 22. *Partially Suppressed Contraction.*—Since the contraction of the jet is due to the convergence towards the orifice of the issuing streams, it will be diminished if for any portion of the edge of the orifice the convergence is prevented. Thus, if an internal rim or border is applied to part of the edge of the orifice (fig. 21), the convergence for so much of the edge is suppressed. For such cases G. Bidone found the following empirical formulae applicable:—

Table of Coefficients of Discharge for Rectangular Vertical Orifices in Fig. 20.

Head $h$ above upper edge of Orifice in feet.	Height of Orifice, $H-h$ , in feet.											
	1:31			0:66			0:16			0:10		
	P	Q	R	P	Q	R	P	Q	R	P	Q	R
0.328	0.598	0.644	0.648	0.634	0.665	0.668	0.691	0.664	0.666	0.710	0.694	0.696
0.656	0.609	0.653	0.657	0.640	0.672	0.675	0.685	0.687	0.688	0.696	0.704	0.706
0.787	0.612	0.655	0.659	0.641	0.674	0.677	0.684	0.690	0.692	0.694	0.706	0.708
0.984	0.616	0.656	0.660	0.641	0.675	0.678	0.683	0.693	0.695	0.692	0.709	0.711
1.968	0.618	0.649	0.653	0.640	0.676	0.679	0.678	0.695	0.697	0.688	0.710	0.712
3.28	0.608	0.632	0.634	0.638	0.674	0.676	0.673	0.691	0.695	0.680	0.704	0.705
4.27	0.602	0.624	0.626	0.637	0.673	0.675	0.672	0.693	0.694	0.678	0.701	0.702
4.92	0.598	0.620	0.622	0.637	0.673	0.674	0.672	0.692	0.693	0.676	0.699	0.699
5.58	0.596	0.618	0.620	0.637	0.672	0.673	0.672	0.692	0.693	0.676	0.698	0.698
6.56	0.595	0.615	0.617	0.636	0.671	0.672	0.671	0.691	0.692	0.675	0.696	0.696
9.84	0.592	0.611	0.612	0.634	0.669	0.670	0.668	0.689	0.690	0.672	0.693	0.693

For rectangular orifices,  
 $c_c = 0.62(1 + 0.152n/p)$ ;  
 and for circular orifices,  
 $c_c = 0.62(1 + 0.128n/p)$ ;

when  $n$  is the length of the edge of the orifice over which the border extends, and  $p$  is the whole length of edge or perimeter of the orifice. The following are the values of  $c_c$  when the border extends over  $\frac{1}{2}$ ,  $\frac{1}{3}$  or  $\frac{1}{4}$  of the whole perimeter:—

$n/p$	Rectangular Orifices.	Circular Orifices.
0.25	0.643	0.640
0.50	0.667	0.660
0.75	0.691	0.680

For larger values of  $n/p$  the formulæ are not applicable. C. R. Bornemann has shown, however, that these formulæ for suppressed contraction are not reliable.

§ 23. *Imperfect Contraction.*—If the sides of the vessel approach near to the edge of the orifice, they interfere with the convergence of the streams to which the contraction is due, and the contraction is then modified. It is generally stated that the influence of the sides begins to be felt if their distance from the edge of the orifice is less than 2.7 times the corresponding

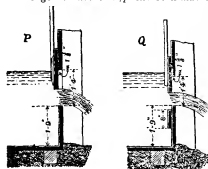

FIG. 20.



FIG. 21.

width of the orifice. The coefficients of contraction for this case are imperfectly known.

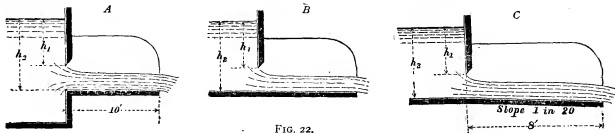

FIG. 22.

§ 24. *Orifices Furnished with Channels of Discharge.*—These external borders to an orifice also modify the contraction. The following coefficients of discharge were obtained with openings 8 in. wide, and small in proportion to the channel of approach (fig. 22, A, B, C).

$h_2, h_1$ in feet.	$h_1$ in feet.									
	0.656	1.64	3.28	6.56	13.12	3.28	4.92	6.56	8.24	9.84
A	.480	.511	.542	.574	.599	.601	.601	.601	.601	.601
B	.480	.510	.538	.566	.592	.600	.602	.602	.601	.601
C	.527	.553	.574	.592	.607	.610	.610	.609	.608	.606
A	.488	.577	.624	.631	.625	.624	.619	.613	.606	.606
B	.487	.571	.606	.617	.626	.628	.627	.623	.618	.618
C	.485	.614	.633	.645	.652	.651	.650	.650	.649	.649

§ 25. *Inversion of the Jet.*—When a jet issues from a horizontal orifice, or is of small size compared with the head, it presents no

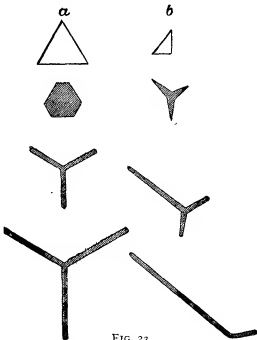

FIG. 23.

marked peculiarity of form. But if the orifice is in a vertical surface, and if its dimensions are not small compared with the head,

it undergoes a series of singular changes of form after leaving the orifice. These were first investigated by G. Bidone (1781-1839); subsequently H. G. Magnus (1802-1870) measured jets from different orifices; and later Lord Rayleigh (*Proc. Roy. Soc.* xxix. 71) investigated them anew.

Fig. 23 shows some forms, the upper figure giving the shape of the orifices, and the others sections of the jet. The jet first contracts as described above, in consequence of the convergence of the fluid streams within the vessel, retaining, however, a form similar to that of the orifice. Afterwards it expands into sheets in planes perpendicular to the sides of the orifice. Thus the jet from a triangular orifice expands into three sheets, in planes bisecting at right angles the three sides of the triangle. Generally a jet from an orifice, in the form of a regular polygon of  $n$  sides, forms  $n$  sheets in planes perpendicular to the sides of the polygon.

Bidone explains this by reference to the simpler case of meeting streams. If two equal streams having the same axis, but moving in opposite directions, meet, they spread out into a thin disk normal to the common axis of the streams. If the directions of two streams intersect obliquely they spread into a symmetrical sheet perpendicular to the plane of the streams.

Let  $a_1, a_2$  (fig. 24) be two points in an orifice at depths  $h_1, h_2$  from the free surface. The filaments issuing at  $a_1, a_2$  will have the different velocities  $\sqrt{2gh_1}$  and  $\sqrt{2gh_2}$ .

Consequently they will tend to describe parabolic paths  $a_1c$  and  $a_2c$  of different horizontal range, and intersecting in the point  $c$ . But since two filaments cannot simultaneously flow through the same point, they must exercise mutual pressure, and will be deflected out of the paths they tend to describe. It is this mutual pressure which causes the expansion of the jet into sheets.

Lord Rayleigh pointed out that, when the orifices are small and the head is not great, the expansion of the sheets in directions perpendicular to the direction of flow reaches a limit. Sections taken at greater distance from the orifice show a contraction of the sheets until a compact form is reached similar to that at the first contraction. Beyond this point, if the jet retains its coherence, sheets are thrown out again, but in directions bisecting the angles between the previous sheets. Lord Rayleigh accepts an explanation of this contraction first suggested by H. Buff (1805-1878), namely, that it is due to surface tension.

§ 26. *Influence of Temperature on Discharge of Orifices.*—Professor W. C. Unwin found (*Phil. Mag.*, October 1878, p. 281) that for sharp-edged orifices temperature has a very small influence on the discharge. For an orifice 1 cm. in diameter with heads of about 1 to 1½ ft. the coefficients were:—

Temperature F.	C.
205°	094
62°	098
For a conoidal or bell-mouthed orifice 1 cm. diameter the effect of temperature was greater:—	
Temperature F.	C.
190°	0987
130°	0974
60°	0942

an increase in velocity of discharge of 4% when the temperature increased 130°.

J. C. Maist repeated these experiments on a much larger scale (*Proc. Inst. Civ. Eng.* lxxiv.). For a sharp-edged orifice 2½ in. diameter, with a head of 1.75 ft., the coefficient was 0.604 at 57° and 0.607 at 179° F., a very small difference. With a conoidal orifice the coefficient was 0.961 at 55° and 0.981 at 170° F. The corresponding coefficients of resistance are 0.0828 and 0.0391, showing that the resistance decreases to about half at the higher temperature.

§ 27. *Fire Hose Nozzles.*—Experiments have been made by J. R. Freeman on the coefficient of discharge from smooth cone nozzles used for fire purposes. The coefficient was found to be 0.983 for ½-in. nozzle; 0.982 for ¾ in.; 0.972 for 1 in.; 0.976 for 1¼ in.; and 0.971 for 1½ in. The nozzles were fixed on a taper play-pipe, and the coefficient includes the resistance of this pipe (*Amer. Soc. Civ. Eng.* xvi., 1889). Other forms of nozzle were tried such as ring nozzles for which the coefficient was smaller.

#### IV. THEORY OF THE STEADY MOTION OF FLUIDS.

§ 28. The general equation of the steady motion of a fluid given under Hydrodynamics furnishes immediately three results as to the distribution of pressure in a stream which may be taken as follows:

(a) If the motion is rectilinear and uniform, the variation of pressure is the same as in a fluid at rest. In a stream flowing in an

open channel, for instance, when the effect of eddies produced by the roughness of the sides is neglected, the pressure at each point is simply the hydrostatic pressure due to the depth below the free surface.

(b) If the velocity of the fluid is very small, the distribution of pressure is approximately the same as in a fluid at rest.

(c) If the fluid molecules take precisely the accelerations which they would have if independent and submitted only to the external forces, the pressure is uniform. Thus in a jet falling freely in the air the pressure throughout any cross section is uniform and equal to the atmospheric pressure.

(d) In any bounded plane section traversed normally by streams which are rectilinear for a certain distance on either side of the section, the distribution of pressure is the same as in a fluid at rest.

#### DISTRIBUTION OF ENERGY IN INCOMPRESSIBLE FLUIDS.

§ 29. *Application of the Principle of the Conservation of Energy to Cases of Stream Line Motion.*—The external and internal work done on a mass is equal to the change of kinetic energy produced. In many hydraulic questions this principle is difficult to apply, because from the complicated nature of the motion produced it is difficult to estimate the total kinetic energy generated, and because in some cases the internal work done in overcoming frictional or viscous resistances cannot be ascertained; but in the case of stream line motion it furnishes a simple and important result known as Bernoulli's theorem.

Let AB (fig. 25) be any one elementary stream, in a steadily moving fluid mass. Then, from the steadiness of the motion, AB is a fixed path in space through which a stream of fluid is constantly flowing. Let OO be the free surface and XX any horizontal datum line. Let

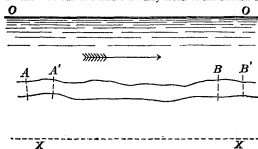

FIG. 25.

$\omega$  be the area of a normal cross section,  $v$  the velocity,  $p$  the intensity of pressure, and  $z$  the elevation above XX, of the elementary stream AB at A, and  $\omega', v', p', z'$  the same quantities at B. Suppose that in a short time  $t$  the mass of fluid initially occupying AB comes to A'B'. Then AA', BB' are equal to  $v't, v't$ , and the volumes of fluid AA', BB' are the equal inflow and outflow  $\omega Q = \omega'v't$ , in the given time. If we suppose the filament AB surrounded by other filaments moving with not very different velocities, the frictional or viscous resistance on its surface will be small enough to be neglected, and if the fluid is incompressible no internal work is done in change of volume. Then the work done by external forces will be equal to the kinetic energy produced in the time considered.

The normal pressures on the surface of the mass (excluding the ends A, B) are at each point normal to the direction of motion, and do no work. Hence the only external forces to be reckoned are gravity and the pressures on the ends of the stream.

The work of gravity when AB falls to A'B' is the same as that of transferring AA' to BB'; that is,  $GQ(z-z')$ . The work of the pressures on the ends, reckoning that at B negative, because it is opposite to the direction of motion, is  $(p\omega \times v't) - (p'\omega' \times v't) = Q(p-p')$ . The change of kinetic energy in the time  $t$  is the difference of the kinetic energy originally possessed by AA' and that finally acquired by BB', for in the intermediate part A'B there is no change of kinetic energy, in consequence of the steadiness of the motion. But the mass of AA' and BB' is  $GQ/g$ , and the change of kinetic energy is therefore  $(GQ/g)(v'^2/2 - v^2/2)$ . Equating this to the work done on the mass AB,

$$GQ(z-z') + Q(p-p') = (GQ/g)(v'^2/2 - v^2/2).$$

Dividing by  $GQ$  and rearranging the terms,

$$z^2/2g + p/G + v^2/2g + z = v'^2/2g + p'/G + z'; \quad (1)$$

or, as A and B are any two points,

$$z^2/2g + p/G + v^2/2g + z = \text{constant} = H. \quad (2)$$

Now  $v^2/2g$  is the head due to the velocity  $v$ ,  $p/G$  is the head equivalent to the pressure, and  $z$  is the elevation above the datum (see § 16). Hence the terms on the left are the total head due to velocity, pressure, and elevation at a given cross section of the filament,  $z$  is easily seen to be the work in foot-pounds which would be done by 1 lb of fluid falling to the datum line, and similarly  $p/G$  and  $v^2/2g$  are the quantities of work which would be done by 1 lb of fluid due to the pressure  $p$  and velocity  $v$ . The expression on the left of the equation is, therefore, the total energy of the stream at the section considered, per lb of fluid, estimated with reference to the

datum line XX. Hence we see that in stream line motion, under the restrictions named above, the total energy per lb of fluid is uniformly distributed along the stream line. If the free surface of the fluid OD is taken as the datum, and  $-h$ ,  $-h_1$  are the depths of A and B measured down from the free surface, the equation takes the form

$$v^2/2g + p/G - h = v_1^2/2g + p_1/G - h_1; \quad (3)$$

or generally

$$v^2/2g + p/G - h = \text{constant}. \quad (3a)$$

§ 30. *Second Form of the Theorem of Bernoulli.*—Suppose at the two sections A, B (fig. 26) of an elementary stream small vertical pipes are introduced, which may be termed pressure columns

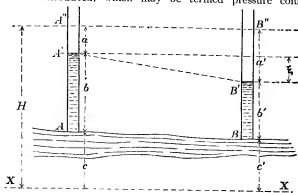

FIG. 26.

(§ 8), having their lower ends accurately parallel to the direction of flow. In such tubes the water will rise to heights corresponding to the pressures at A and B. Hence  $b = p/G$ , and  $b' = p_1/G$ . Consequently the tops of the pressure columns A' and B' will be at total heights  $b + c = p/G + z$  and  $b' + c' = p_1/G + z_1$  above the datum line XX. The difference of level of the pressure column tops, or the fall of free surface level between A and B, is therefore

$$\xi = (p - p_1)/G + (z - z_1);$$

and this by equation (1), § 29 is  $(v_1^2 - v^2)/2g$ . That is, the fall of free surface level between two sections is equal to the difference of the heights due to the velocities at the sections. The line A'B' is sometimes called the line of hydraulic gradient, though this term is also used in cases where friction needs to be taken into account. It is the line the height of which above datum is the sum of the elevation and pressure head at that point, and it falls below a horizontal line A'B' drawn at H ft. above XX by the quantities  $a = v^2/2g$  and  $a' = v_1^2/2g$ , when friction is absent.

§ 31. *Illustrations of the Theorem of Bernoulli.* In a lecture to the mechanical section of the British Association in 1875, W. Froude gave some experimental illustrations of the principle of Bernoulli. He remarked that it was a common but erroneous impression that a fluid exercises in a contracting pipe A (fig. 27) an excess of pressure against the entire converging surface which it meets, and that, conversely, as it enters an enlargement B, a relief of pressure is experienced by the entire diverging surface of the pipe. Further it is commonly assumed that when passing through a contraction C, there is in the narrow neck an excess of pressure due to the squeezing together of the liquid at that point. These impressions are in no respect correct; the pressure is smaller as the section of the pipe is smaller and conversely.

Fig. 28 shows a pipe so formed that a contraction is followed by an enlargement, and fig. 29 one in which an enlargement is followed by a contraction. The vertical pressure columns show the decrease of pressure at the contraction and increase of pressure at the enlargement. The line abc in both figures shows the variation of free surface level, supposing the pipe frictionless. In actual pipes, however, work is expended in friction against the pipe; the

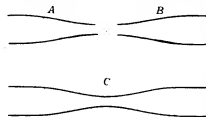

FIG. 27.

total head diminishes in proceeding along the pipe, and the free surface level is a line such as abc, falling below abc.

Froude further pointed out that, if a pipe contracts and enlarges again to the same size, the resultant pressure on the converging part exactly balances the resultant pressure on the diverging part so that there is no tendency to move the pipe bodily when water flows through it. Thus the conical part AB (fig. 30) presents the same

projected surface as HI, and the pressures parallel to the axis of the pipe, normal to these projected surfaces, balance each other. Similarly the pressures on BC, CD balance those on GH, EG. In the same way, in any combination of enlargements and contractions, a balance of pressures, due to the flow of liquid parallel to the

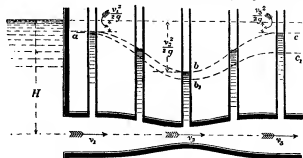

FIG. 28.

axis of the pipe, will be found, provided the sectional area and direction of the ends are the same.

The following experiment is interesting. Two cisterns provided with converging pipes were placed so that the jet from one was exactly opposite the entrance to the other. The cisterns being filled

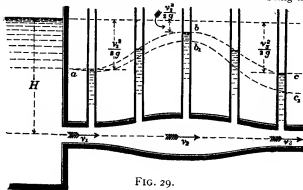

FIG. 29.

very nearly to the same level, the jet from the left-hand cistern A entered the right-hand cistern B (fig. 31), shooting across the free space between them without any waste, except that due to indirectness of aim and want of exact correspondence in the form of the orifices. In the actual experiment there was 18 in. of head in the right and 20½ in. of head in the left-hand cistern, so that about

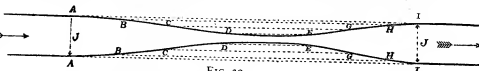

FIG. 30.

2½ in. were wasted in friction. It will be seen that in the open space between the orifices there was no pressure, except the atmospheric pressure acting uniformly throughout the system.

§ 32. *Venturi Meter.*—An ingenious application of the variation of pressure and velocity in a converging and diverging pipe has been

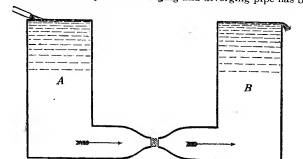

FIG. 31.

made by Clemens Herschel in the construction of what he terms a Venturi Meter for measuring the flow in water mains. Suppose that as in fig. 32, a contraction is made in a water main, the change of section being gradual to avoid the production of eddies. The ratio  $\rho$

of the cross sections at A and B, that is at inlet and throat, is in actual meters 5 to 1 to 20 to 1, and is very carefully determined by the maker of the meter. Then, if  $v$  and  $u$  are the velocities at A and B,  $u = \rho v$ . Let pressure pipes be introduced at A, B and C,

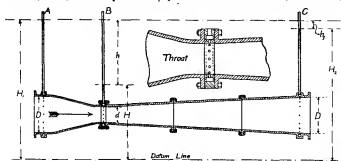

FIG. 32.

and let  $H_1, H_2, H_3$  be the pressure heads at those points. Since the velocity at B is greater than at A the pressure will be less. Neglecting friction

$$H_1 + v^2/2g = H + u^2/2g,$$

$$H_2 - H = (u^2 - v^2)/2g = (\rho^2 - 1)v^2/2g.$$

Let  $h = H_1 - H$  be termed the Venturi head, then

$$u = \sqrt{[\rho^2/2gh/(\rho^2 - 1)]},$$

from which the velocity through the throat and the discharge of the main can be calculated if the areas at A and B are known and  $h$  observed. Thus if the diameters at A and B are 4 and 12 in., the areas are 12.57 and 113.1 sq. in., and  $\rho = 9$ ,

$$u = \sqrt{81/80v} (2gh) = 1.007\sqrt{2gh}.$$

If the observed Venturi head is 12 ft.,

$$u = 28 \text{ ft. per sec.},$$

and the discharge of the main is

$$28 \times 12.57 = 351 \text{ cub. ft. per sec.}$$

Hence by a simple observation of pressure difference, the flow in the main at any moment can be determined. Notice that the pressure height at C will be the same as at A except for a small loss  $h_f$  due to friction and eddying between A and B. To get the pressure at the throat very exactly Herschel surrounds it by an annular passage communicating with the throat by several small holes, sometimes formed in vulcanite to prevent corrosion. This is constructed to prevent eddying as much as possible. There is some eddy loss. The main effect of this is to cause a loss of head between A and C which may vary from a fraction of a foot to perhaps 5 ft. at the highest velocities at which a meter can be used. The eddying also affects a little the Venturi head  $h$ . Consequently an experimental coefficient must be determined for each meter by tank measurement. The range of this coefficient is, however, surprisingly small. It is allowed for friction,  $u = k\sqrt{[\rho^2/(\rho^2 - 1)]\sqrt{2gh}}$ , then Herschel found values of  $k$  from 0.97 to 1.0 for throat velocities varying from 8 to 28 ft. per sec. The meter is extremely convenient. At Staines reservoirs there are two meters of this type on mains 94 in. in diameter. Herschel contrived a recording arrangement which records the variation of flow from hour to hour and also the total flow in any given time. In Great Britain the meter is constructed by S. Kent, who has made improvements in the recording arrangement.

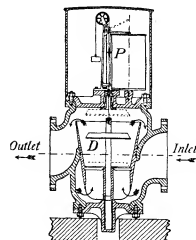

FIG. 33.

of the water. If the discharge of the main increases the disk rises, but as it rises its position in the chamber is such that in consequence of the larger area the velocity is less. It finds, therefore, a new position of equilibrium. A pencil P records on a drum moved by clockwork the position of the disk, and from this the variation of flow is inferred.

§ 33. Pressure, Velocity and Energy in Different Stream Lines.—The equation of Bernoulli gives the variation of pressure and velocity

from point to point along a stream line, and shows that the total energy of the flow across any two sections is the same. Two other directions may be defined, one normal to the stream line and in the plane containing its radius of curvature at any point, the other normal to the stream line and the radius of curvature. For the problems most practically useful it will be sufficient to consider the stream lines as parallel to a vertical or horizontal plane. If the motion is in a vertical plane, the action of gravity must be taken into the reckoning; if the motion is in a horizontal plane, the terms expressing variation of elevation of the filament will disappear.<sup>1</sup>

Let AB, CD (fig. 34) be two consecutive stream lines, at present assumed to be in a vertical plane, and PQ a normal to these lines

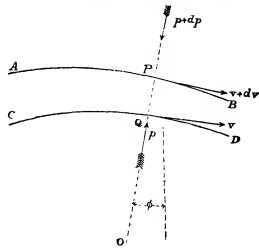

FIG. 34.

making an angle  $\phi$  with the vertical. Let P, Q be two particles moving along these lines at a distance  $PQ = ds$ , and let  $z$  be the height of Q above the horizontal plane with reference to which the energy is measured,  $v$  its velocity, and  $p$  its pressure. Then, if H is the total energy at Q per unit of weight of fluid,

$$H = z + p/G + v^2/2g.$$

Differentiating, we get

$$dH = dz + dp/G + vdv/g, \quad (1)$$

for the increment of energy between Q and P. But

$$dz = PQ \cos \phi = ds \cos \phi;$$

$$\therefore dH = dp/G + vdv/g + ds \cos \phi, \quad (1a)$$

where the last term disappears if the motion is in a horizontal plane.

Now imagine a small cylinder of section  $\omega$  described round PQ as an axis. This will be in equilibrium under the action of its centrifugal force, its weight and the pressure on its ends. But its volume is  $\omega ds$  and its weight  $G\omega ds$ . Hence, taking the components of the forces parallel to PQ—

$$\omega dp = G\omega ds/g - G\omega \cos \phi ds,$$

where  $\rho$  is the radius of curvature of the stream line at Q. Consequently, introducing these values in (1),

$$dH = v^2 ds/g + vdv/g = (v/g)(v/\rho + dv/ds) ds. \quad (2)$$

## CURRENTS

§ 34. Rectilinear Current.—Suppose the motion is in parallel straight stream lines (fig. 35) in a vertical plane. Then  $\rho$  is infinite, and from eq. (2), § 33,

$$dH = vdv/g.$$

Comparing this with (1) we see that

$$\begin{aligned} ds + dp/G &= 0; \\ \therefore z + p/G &= \text{constant}; \end{aligned} \quad (3)$$

or the pressure varies hydrostatically as in a fluid at rest. For two stream lines in a horizontal plane,  $z$  is constant, and therefore  $p$  is constant.

Radiating Current.—Suppose water flowing radially between horizontal parallel planes, at a distance apart =  $\delta$ . Conceive two cylindrical sections of the current at radii  $r_1$  and  $r_2$ , where the velocities are  $v_1$  and  $v_2$ , and the pressures  $p_1$  and  $p_2$ . Since the flow across each cylindrical section of the current is the same,

$$\begin{aligned} Q &= 2\pi r_1 \delta v_1 = 2\pi r_2 \delta v_2 \\ r_1 v_1 &= r_2 v_2 \\ r_1/r_2 &= v_2/v_1. \end{aligned} \quad (4)$$

<sup>1</sup> The following theorem is taken from a paper by J. H. Cotterill, "On the Distribution of Energy in a Mass of Fluid in Steady Motion," *Phil. Mag.*, February 1876.



The velocity would be infinite at radius 0, if the current could be conceived to extend to the axis. Now, if the motion is steady,

$$H = p_1/G + v_1^2/2g = p_2/G + v_2^2/2g; \\ = p_3/G + r_1^2 v_1^2/r_2^2 2g; \\ (p_2 - p_1)/G = v_1^2 (1 - r_1^2/r_2^2)/2g; \\ p_2/G = H - r_1^2 v_1^2/r_2^2 2g. \quad (5)$$

Hence the pressure increases from the interior outwards, in a way indicated by the pressure columns in fig. 36, the curve through the free surfaces of the pressure columns being, in a radial section, the quasi-hyperbola of the form  $xy^2 = c^2$ . This curve is asymptotic to a horizontal line,  $H$  ft. above the line from which the pressures are measured, and to the axis of the current.

**Free Circular Vortex.**—A free circular vortex is a revolving mass of water, in which the stream lines are concentric circles, and in which

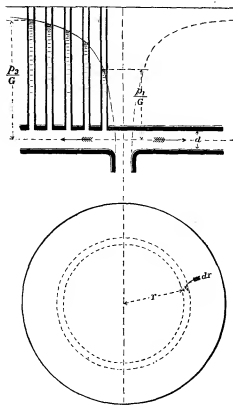

FIG. 36.

the total head for each stream line is the same. Hence, if by any slow radial motion portions of the water strayed from one stream line to another, they would take freely the velocities proper to their new positions under the action of the existing fluid pressures only.

For such a current, the motion being horizontal, we have for all the circular elementary streams

$$H = p/G + v^2/2g = \text{constant}; \\ \therefore dH = dp/G + v dv/g = 0. \quad (7)$$

Consider two stream lines at radii  $r$  and  $r + dr$  (fig. 36). Then in (2), § 33,  $\rho = r$  and  $ds = dr$ ,

$$v^2 dr / gr + v dv / g = 0, \\ dv/v = -dr/r, \\ v \propto 1/r, \quad (8)$$

precisely as in a radiating current; and hence the distribution of pressure is the same, and formulæ 5 and 6 are applicable to this case.

**Free Spiral Vortex.**—As in a radiating and circular current the equations of motion are the same, they will also apply to a vortex in which the motion is compounded of these motions in any proportions, provided the radial component of the motion varies inversely as the radius as in a radial current, and the tangential component varies inversely as the radius as in a free vortex. Then the whole velocity at any point will be inversely proportional to the radius of the point, and the fluid will describe stream lines having a constant inclination to the radius drawn to the axis of the current. That is, the stream lines will be logarithmic spirals. When water is delivered from the circumference of a centrifugal pump or turbine into a chamber, it forms a free vortex of this kind. The water flows spirally outwards, its velocity diminishing and its

pressure increasing according to the law stated above, and the head along each spiral stream line is constant.

§ 35. **Forced Vortex.**—If the law of motion in a rotating current is different from that in a free vortex, some force must be applied to cause the variation of velocity. The simplest case is that of a rotating current in which all the particles have equal angular velocity, as for instance when they are driven round by radiating paddles revolving uniformly. Then in equation (2), § 33, considering two circular stream lines of radii  $r$  and  $r + dr$  (fig. 37), we have  $\rho = r$ ,  $ds = dr$ . If the angular velocity is  $\omega$ , then  $v = \omega r$  and  $dv = \omega dr$ . Hence

$dH = \omega^2 r dr / g + \omega^2 r dr / g = 2\omega^2 r dr / g$ , because the motion is horizontal,

$$dp/G + \omega^2 r dr / g = 2\omega^2 r dr / g, \\ dp/G = \omega^2 r dr / g, \\ p/G = \omega^2 r^2 / 2g + \text{constant}. \quad (9)$$

Let  $p_1, r_1, v_1$  be the pressure, radius and velocity of one cylindrical section,  $p_2, r_2, v_2$  those of another; then

$$p_1/G - \omega^2 r_1^2 / 2g = p_2/G - \omega^2 r_2^2 / 2g; \\ (p_2 - p_1)/G = \omega^2 (r_2^2 - r_1^2) / 2g = (v_2^2 - v_1^2) / 2g. \quad (10)$$

That is, the pressure increases from within outwards in a curve

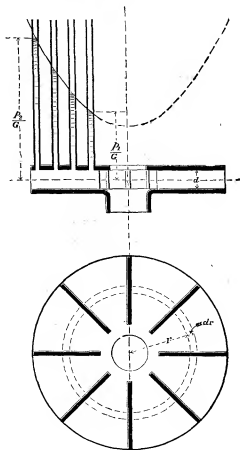

FIG. 37.

which in radial sections is a parabola, and surfaces of equal pressure are paraboloids of revolution (fig. 37).

#### DISSIPATION OF HEAD IN SHOCK

§ 36. **Relation of Pressure and Velocity in a Stream in Steady Motion when the Changes of Section of the Stream are Abrupt.**—When a stream changes section abruptly, rotating eddies are formed which dissipate energy. The energy absorbed in producing rotation is at once abstracted from that effective in causing the flow, and sooner or later it is wasted by frictional resistances due to the rapid relative motion of the eddying parts of the fluid. In such cases the work thus expended internally in the fluid is too important to be neglected, and the energy thus lost is commonly termed energy lost in shock. Suppose fig. 38 to represent a stream having such an abrupt change of section. Let AB, CD be normal sections at points where ordinary stream line motion has not been disturbed and where it has been re-established. Let  $\omega, p, v$  be the area of section, pressure and velocity at AB, and  $\omega_1, p_1, v_1$  corresponding quantities at CD. Then if no work were expended internally, and assuming the stream horizontal, we should have

$$p/G + v^2/2g = p_1/G + v_1^2/2g. \quad (1)$$

But if work is expended in producing irregular eddying motion, the head at the section CD will be diminished.

Suppose the mass ABCD comes in a short time  $t$  to  $A'B'C'D'$ . The resultant force parallel to the axis of the stream is

$$p_0 + p_0(\omega_1 - \omega) - p_1\omega_1,$$

where  $p_0$  is put for the unknown pressure on the annular space between AB and EF. The impulse of that force is

$$\{p_0 + p_0(\omega_1 - \omega) - p_1\omega_1\}t.$$

The horizontal change of momentum in the

same time is the difference of the momenta of CDC'D' and ABA'B', because the amount of momentum between A'B' and CD remains unchanged if the motion is steady. The volume of ABA'B' or CDC'D', being the inflow and outflow in the time  $t$ , is  $Q't = \omega_1\omega_1 t$ , and the momentum of these masses is  $(G/g)Q't\omega_1$  and  $(G/g)Q't\omega$  respectively. The change of mo-

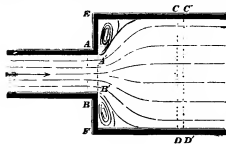

FIG. 38.

ment is therefore  $(G/g)Q't(\omega_1 - \omega)$ . Equating this to the impulse,

$$\{p_0 + p_0(\omega_1 - \omega) - p_1\omega_1\}t = (G/g)Q't(\omega_1 - \omega).$$

Assume that  $p_0 = p$ , the pressure at AB extending unchanged through the portions of fluid in contact with AE, BF which lie out of the path of the stream. Then (since  $Q = \omega_1 v_1$ )

$$(p - p_1) = (G/g)v_1(\omega_1 - \omega);$$

$$p_1/G - p_1/G = v_1(\omega_1 - \omega)/g; \quad (2)$$

$$p_1/G + v_1^2/2g = p_1/G + v_1^2/2g + (v_1 - v_1)^2/2g. \quad (3)$$

This differs from the expression (1), § 29, obtained for cases where no sensible internal work is done, by the last term on the right. That is,  $(v_1 - v_1)^2/2g$  has to be added to the total head at CD, which is  $p_1/G + v_1^2/2g$ , to make it equal to the total head at AB, or  $(v_1 - v_1)^2/2g$  is the head lost in shock at the abrupt change of section. But  $v_1 - v_1$  is the relative velocity of the two parts of the stream. Hence, when an abrupt change of section occurs, the head due to the relative velocity is lost in shock, or  $(v_1 - v_1)^2/2g$  foot-pounds of energy is wasted for each pound of fluid. Experiment verifies this result, so that the assumption that  $p_0 = p$  appears to be admissible.

If there is no shock,

$$p_1/G = p_1/G + (v_1 - v_1)^2/2g.$$

$$p_1/G = p_1/G - v_1(v_1 - v_1)/g.$$

Hence the pressure head at CD in the second case is less than in the former by the quantity  $(v_1 - v_1)^2/2g$ , or, putting  $\omega_1 v_1 = \omega v$ , by the quantity

$$(v^2/2g)(1 - \omega/\omega_1)^2. \quad (4)$$

## V. THEORY OF THE DISCHARGE FROM ORIFICES AND MOUTHPIECES

§ 37. *Minimum Coefficient of Contraction.* *Re-entrant Mouthpiece of Borda.*—In one special case the coefficient of contraction can be determined theoretically, and as it is the case where the convergence of the streams approaching the orifice takes place through the greatest possible angle, the coefficient thus determined is the minimum coefficient.

Let fig. 39 represent a vessel with vertical sides, OO being the free water surface, at which the pressure is  $p_0$ . Suppose the liquid issues by a horizontal mouthpiece, which is re-entrant and of the greatest length which permits the jet to spring clear from the inner end of the orifice, without adhering to its sides. With such an orifice the velocity near the points CD is negligible, and the pressure at those points may be taken equal to the hydrostatic pressure due to the depth from the free surface. Let  $\omega$  be the area of the mouthpiece AB,  $\omega'$  that of the contracted jet  $\omega'$

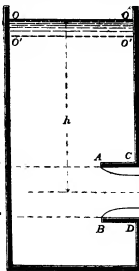

FIG. 39.

and the pressure at those points may be taken equal to the hydrostatic pressure due to the depth from the free surface. Let  $\omega$  be the area of the mouthpiece AB,  $\omega'$  that of the contracted jet  $\omega'$

Suppose that in a short time  $t$ , the mass O'oa' comes to the position O'O' a'a'; the impulse of the horizontal external forces acting on the mass during that time is equal to the horizontal change of momentum.

The pressure on the side OC of the mass will be balanced by the pressure on the opposite side OE, and so for all other portions of the vertical surfaces of the mass, excepting the portion EF opposite the mouthpiece and the surface AaaB of the jet. On EF the pressure is simply the hydrostatic pressure due to the depth, that is,  $(p_0 + G'h)\Omega$ . On the surface and section AaaB of the jet, the horizontal resultant of the pressure is equal to the atmospheric pressure  $p_0$  acting on the vertical projection AB of the jet; that is, the resultant pressure is  $p_0\Omega$ . Hence the resultant horizontal force for the whole mass is  $(p_0 + G'h)\Omega - p_0\Omega = G'h\Omega$ . Its impulse in the time  $t$  is  $G'h\Omega t$ . Since the motion is steady there is no change of momentum between O'O' and aa'. The change of horizontal momentum is, therefore, the difference of the horizontal momentum lost in the space O'OO'O' and gained in the space a'aa'a'. In the former space there is no horizontal momentum.

The volume of the space a'aa'a' is  $\omega\omega't$ ; the mass of liquid in that space is  $(G/g)\omega\omega't$ ; its momentum is  $(G/g)\omega\omega'v't$ . Equating impulse to momentum gained,

$$G'h\Omega t = (G/g)\omega\omega'v't;$$

$$\therefore \omega\omega'\Omega = gh\omega'v';$$

$$\therefore v' = 2gh, \text{ and } \omega/\Omega = v'/v;$$

$$\therefore \omega/\Omega = \frac{1}{2} = c_c;$$

But

a result confirmed by experiment with mouthpieces of this kind. A similar theoretical investigation is not possible for orifices in plane surfaces, because the velocity along the sides of the vessel in the neighbourhood of the orifice is not so small that it can be neglected. The resultant horizontal pressure is therefore greater than  $G'h\Omega$ , and the contraction is less. The experimental values of the coefficient of discharge for a re-entrant mouthpiece are 0.5149 (Borda), 0.5547 (Bidone), 0.5324 (Weisbach), values which differ little from the theoretical value, 0.5, given above.

§ 38. *Velocity of Filaments issuing in a Jet.*—A jet is composed of fluid filaments or elementary streams, which start into motion at some point in the interior of the vessel from which the fluid is discharged, and gradually acquire the velocity of the jet. Let Mm, fig. 40 be such a filament, the point M being taken where the velocity is insensibly small, and m at the most contracted section of the jet, where the filaments have become parallel and exercise uniform mutual pressure.

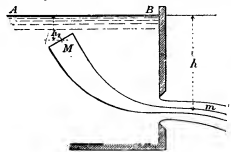

FIG. 40.

Take the free surface AB for datum line, and let  $p_1$ ,  $v_1$ ,  $h_1$  be the pressure, velocity and depth below datum at M;  $p$ ,  $v$ ,  $h$ , the corresponding quantities at m. Then § 29, eq. (30),

$$v_1^2/2g + p_1/G - h_1 = v^2/2g + p/G - h. \quad (1)$$

But at M, since the velocity is insensible, the pressure is the hydrostatic pressure due to the depth; that is,  $v_1 = 0$ ,  $p_1 = p_0 + G'h_1$ . At m,  $p = p_0$ , the atmospheric pressure round the jet. Hence, inserting these values,

$$0 + p_0/G + h_1 - h_1 = v^2/2g + p_0/G - h;$$

$$v^2/2g = h;$$

$$\text{or } v = \sqrt{2gh} = 8.025\sqrt{h}. \quad (2a)$$

That is, neglecting the viscosity of the fluid, the velocity of filaments at the contracted section of the jet is simply the velocity due to the difference of level of the free surface in the reservoir and the orifice.

If the orifice is small in dimensions compared with  $h$ , the filaments will all have nearly the same velocity, and if  $h$  is measured to the centre of the orifice, the equation above gives the mean velocity of the jet.

*Case of a Submerged Orifice.*—Let the orifice discharge below the level of the tail water. Then using the notation shown in fig. 41, we have at M,  $v_1 = 0$ ,  $p_1 = G'h_1 + p_0$  at m,  $p = G'h_2 + p_0$ . Inserting these values in (3), § 29,

$$0 + h_1 + p_0/G - G'h_1 = v^2/2g + h_2 - h_2 + p_0/G;$$

$$v^2/2g = h_2 - h_1 = h. \quad (3)$$

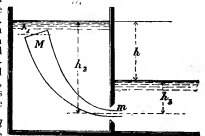

FIG. 41.

where  $h$  is the difference of level of the head and tail water, and may be termed the effective head producing flow.

**Case where the Pressures are different on the Free Surface and at the Orifice.**—Let the fluid flow from a vessel in which the pressure is  $p_0$  into a vessel in which the pressure is  $p$ , fig. 42. The pressure  $p_0$  will produce the same effect as a layer of fluid of thickness  $p_0/G$  added to the head water; and the pressure  $p$  will produce the same effect as a layer of thickness  $p/G$  added to the tail water. Hence the effective difference of level, or effective head producing flow, will be

$$h = h_0 + p_0/G - p/G;$$

FIG. 42.

and the velocity of discharge will be

$$v = \sqrt{2g[h_0 + (p_0 - p)/G]}.$$

We may express this result by saying that differences of pressure at the free surface and at the orifice are to be reckoned as part of the effective head.

Hence in all cases thus far treated the velocity of the jet is the velocity due to the effective head, and the discharge, allowing for contraction of the jet, is

$$Q = c\omega v = c\omega\sqrt{2gh},$$

where  $\omega$  is the area of the orifice,  $c\omega$  the area of the contracted section of the jet, and  $h$  the effective head measured to the centre of the orifice. If  $h$  and  $\omega$  are taken in feet,  $Q$  is in cubic feet per second.

It is obvious, however, that this formula assumes that all the filaments have sensibly the same velocity. That will be true for horizontal orifices, and very approximately true in other cases, if the dimensions of the orifice are not large compared with the head  $h$ . In large orifices in say a vertical surface, the value of  $h$  is different for different filaments, and then the velocity of different filaments is not sensibly the same.

#### SIMPLE ORIFICES—HEAD CONSTANT

§ 39. **Large Rectangular Jets from Orifices in Vertical Plane Surfaces.**—Let an orifice in a vertical plane surface be so formed that it produces a jet having

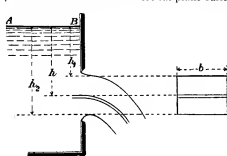

FIG. 43.

second in this lamina is therefore  $b\sqrt{2gh} dh$ , and that of the whole jet is therefore

$$Q = \int_0^{h_1} b\sqrt{2gh} dh = \frac{2}{3} b\sqrt{2g} [h_1^{3/2} - h_2^{3/2}],$$

where the first factor on the right is a coefficient depending on the form of the orifice.

Now an orifice producing a rectangular jet must itself be very approximately rectangular. Let  $B$  be the breadth,  $H_1, H_2$ , the depths to the upper and lower edges of the orifice. Put

$$b(h_1^3 - h_2^3)/B(H_1^3 - H_2^3) = c.$$

Then the discharge, in terms of the dimensions of the orifice, instead of those of the jet, is

$$Q = \frac{2}{3} c B \sqrt{2g} (H_1^3 - H_2^3),$$

the formula commonly given for the discharge of rectangular orifices. The coefficient  $c$  is not, however, simply the coefficient of contraction, the value of which is

$$b(h_2 - h_1)/B(H_2 - H_1),$$

and not that given in (7). It cannot be assumed, therefore, that  $c$  in equation (8) is constant, and in fact it is found to vary for different values of  $B/H_2$  and  $B/H_1$ , and must be ascertained experimentally.

**Relation between the Expressions (5) and (8).**—For a rectangular

orifice the area of the orifice is  $\omega = B(H_2 - H_1)$ , and the depth measured to its centre is  $\frac{1}{2}(H_2 + H_1)$ . Putting these values in (5),

$$Q_1 = cB(H_2 - H_1)\sqrt{2g(H_2 + H_1)}.$$

From (8) the discharge is

$$Q_2 = \frac{2}{3} cB\sqrt{2g}(H_1^3 - H_2^3).$$

Hence, for the same value of  $c$  in the two cases,

$$\frac{Q_2}{Q_1} = \frac{2}{3} \frac{(H_1^3 - H_2^3)}{(H_2 - H_1)\sqrt{2g(H_2 + H_1)}}.$$

Let  $H_1/H_2 = \sigma$ , then

$$\frac{Q_2}{Q_1} = 0.9427 (1 - \sigma^3) / [1 - \sigma\sqrt{1 + \sigma}].$$

If  $H_1$  varies from 0 to  $\infty$ ,  $\sigma = (H_1/H_2)$  varies from 0 to 1. The following table gives values of the two estimates of the discharge for different values of  $\sigma$  :—

$H_1/H_2 = \sigma$ .	$Q_2/Q_1$ .	$H_1/H_2 = \sigma$ .	$Q_2/Q_1$ .
0.0	.943	0.8	.999
0.2	.979	0.9	.999
0.5	.995	1.0	1.000
0.7	.998		

Hence it is obvious that, except for very small values of  $\sigma$ , the simpler equation (5) gives values sensibly identical with those of (8). When  $\sigma < 0.5$  it is better to use equation (8) with values of  $c$  determined experimentally for the particular proportions of orifice which are in question.

§ 40. **Large Jets having a Circular Section from Orifices in a Vertical Plane Surface.**—Let fig. 44 represent the section of the jet,  $OO$  being

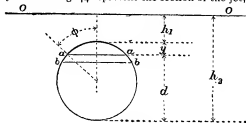

FIG. 44.

the free surface level in the reservoir. The discharge through the horizontal strip  $abcd$ , of breadth  $aa' = b$ , between the depths  $h_1 + y$  and  $h_1 + y + dy$ , is

$$dQ = b\sqrt{2g(h_1 + y)} dy.$$

The whole discharge of the jet is

$$Q = \int_0^d b\sqrt{2g(h_1 + y)} dy.$$

But  $b = d \sin \phi$ ;  $y = \frac{1}{2}d(1 - \cos \phi)$ ;  $dy = \frac{1}{2}d \sin \phi d\phi$ . Let  $\epsilon = d/(2h_1 + d)$ , then

$$Q = \frac{1}{2} d^2 \sqrt{2g} \int_0^\pi \sin^2 \phi \sqrt{1 - \epsilon \cos \phi} d\phi.$$

From eq. (5), putting  $\omega = \pi d^2/4$ ,  $h = h_1 + d/2$ ,  $c = 1$  when  $d$  is the diameter of the jet and not that of the orifice,

$$Q_1 = \frac{1}{2} \pi d^2 \sqrt{2g} (h_1 + d/2),$$

$$Q/Q_1 = 2/\pi \int_0^\pi \sin^2 \phi \sqrt{1 - \epsilon \cos \phi} d\phi.$$

For

$$h_1 = 0, \epsilon = 0 \text{ and } Q/Q_1 = 1;$$

and for

$$h_1 = 0, \epsilon = 1 \text{ and } Q/Q_1 = 0.96.$$

So that in this case also the difference between the simple formula (5) and the formula above, in which the variation of head at different parts of the orifice is taken into account, is very small.

#### NOTCHES AND WEIRS

§ 41. **Notches, Weirs and Byewashes.**—A notch is an orifice extending up to the free surface level in the reservoir from which the discharge takes place. A weir is a structure over which the water flows, the discharge being in the same conditions as for a notch. The formula of discharge for an orifice of this kind is ordinarily deduced by putting  $H_2 = 0$  in the formula for the corresponding orifice, obtained as in the preceding section. Thus for a rectangular notch, put  $H_2 = 0$  in (8). Then

$$Q = \frac{2}{3} c B \sqrt{2g} (H_1)^{3/2},$$

where  $H$  is put for the depth to the crest of the weir or the bottom of the notch. Fig. 45 shows the mode in which the discharge occurs in the case of a rectangular notch or weir with a level crest. As the free surface level falls very sensibly near the notch, the head  $H$  should be measured at some distance back from the notch, at a point where the velocity of the water is very small.

Since the area of the notch opening is  $BH$ , the above formula is of the form

$$Q = c \times BH \times k \sqrt{2gH},$$

where  $k$  is a factor depending on the form of the notch and expressing the ratio of the mean velocity of discharge to the velocity due to the depth  $H$ .

§ 42. **Francis's Formula for Rectangular Notches.**—The jet discharged through a rectangular notch has a section smaller than  $BH$ , (a) because of the fall of the water surface from the point where  $H$

is measured towards the weir, (b) in consequence of the crest contraction, (c) in consequence of the end contractions. It may be pointed out that while the diminution of the section of the jet due to the surface fall and to the crest contraction is proportional to the length of the weir, the end contractions have nearly the same effect whether the weir is wide or narrow.

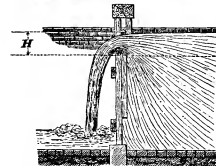
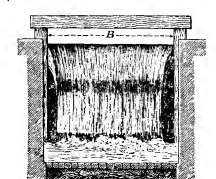

FIG. 45.

width of the jet is  $l - 0.1nH$ , where  $n$  is the number of end contractions of the stream. The contractions due to the fall of surface and to the crest contraction are proportional to the width of the jet. Hence, if  $cH$  is the thickness of the stream over the weir, measured at the contracted section, the section of the jet will be  $c(l - 0.1nH)H$  and (§ 41) the mean velocity will be  $\frac{3}{2}\sqrt{2gH}$ . Consequently the discharge will be given by an equation of the form

$$Q = \frac{3}{2}c(l - 0.1nH)H\sqrt{2gH} = 3.35c(l - 0.1nH)H^{\frac{3}{2}}$$

This is Francis's formula, in which the coefficient of discharge  $c$  is much more nearly constant for different values of  $l$  and  $h$  than in the ordinary formula. Francis found for  $c$  the mean value 0.622, the weir being sharp-edged.

§ 43. *Triangular Notch* (fig. 46).—Consider a lamina issuing between the depths  $h$  and  $h + dh$ . Its area, neglecting contraction, will be  $b dh$ , and the velocity at that depth is  $\sqrt{2gh}$ . Hence the discharge for this lamina is

$$b\sqrt{2gh} dh. \quad \text{But} \quad B/b = H/(H-h); \quad b = B(H-h)/H.$$

Hence discharge of lamina

$$= B(H-h)\sqrt{2gh} dh/H;$$

and total discharge of notch

$$= Q = B\sqrt{2g} \int_0^H (H-h)h dh/H = \frac{2}{3}B\sqrt{2g} H^{\frac{3}{2}}.$$

*Coefficients for the Discharge over Weirs, derived from the Experiments of T. E. Blackwell. When more than one experiment was made with the same head, and the results were pretty uniform, the resulting coefficients are marked with an (\*). The effect of the converging wing-boards is very strongly marked.*

Head, in inches measured from still Water in Reservoir.	Sharp Edge.		Planks 2 in. thick, square on Crest.					Crests 3 ft. wide.					
	3 ft. long.	10 ft. long.	3 ft. long.	6 ft. long.	10 ft. long.	10 ft. long, wing-boards making an angle of 60°.	3 ft. long, level.	3 ft. long, fall 1 in 12.	3 ft. long, fall 1 in 12.	6 ft. long, level.	10 ft. long, level.	10 ft. long, fall 1 in 12.	
1	.677	.809	.467	.459	.435 <sup>1</sup>	.754	.452	.545	.467	..	.381	.467	
2	.675	.803	.509*	.501	.585*	.675	.482	.546	.533	..	.479*	.495*	
3	.630	.642*	.563*	.597*	.569*	..	.441	.537	.539	..	.492*	..	
4	.617	.656	.540	.575	.602*	..	.656	.431	.455	..	.497*	..	
5	.602	.630*	.588	.601*	.609*	.671	.479	.516	..	..	.518	..	
6	.593	..	.593*	.608*	.576*	..	.501*	..	.531	.507	.513	.543	
7	..	..	.617*	.608*	.576*	..	.488	.513	.527	.497	..	..	
8	..	.581	.606*	.590*	.548*	..	.479	.491	..	..	.468	.507	
9	..	.530	.600	.569	.558*	..	.476	.492*	.498	.48*	.486	..	
10	..	..	.614*	.539	.534	..	..	..	..	.465*	.455	..	
12	..	..	..	.525*	.534	..	..	..	..	.467*	..	..	
14	..	..	..	.549*	..	..	..	..	..	..	..	..	

<sup>1</sup>The discharge per second varied from .461 to .665 cub. ft. in two experiments. The coefficient .435 is derived from the mean value.

or, introducing a coefficient to allow for contraction,

$$Q = \frac{2}{3}cB\sqrt{2g}H^{\frac{3}{2}}$$

When a notch is used to gauge a stream of varying flow, the ratio  $B/H$  varies if the notch is rectangular, but is constant if the notch is triangular. This led Professor James Thomson to suspect that the coefficient of discharge,  $c$ , would be much more constant with different values of  $H$  in a triangular notch than in a rectangular notch, and this has been experimentally shown to be the case.

Hence a triangular notch is more suitable for accurate gaugings than a rectangular notch. For a sharp-edged triangular notch Professor J. Thomson found  $c = 0.617$ . It will be seen, as in § 41, that since  $\frac{1}{2}BH$  is the area of section of the stream through the notch, the formula is again of the form

$$Q = c \times \frac{1}{2}BH \times \sqrt{2g}H,$$

where  $k = \frac{1}{2}B$  is the ratio of the mean velocity in the notch to the velocity at the depth  $H$ . It may easily be shown that for all notches the discharge can be expressed in this form.

§ 44. *Weir with a Broad Sloping Crest.*—Suppose a weir formed with a broad crest so sloped that the streams flowing over it have a movement sensibly rectilinear and uniform (fig. 47). Let the inner edge be so rounded as to prevent a crest contraction. Consider a filament  $aa'$ , the point  $a$  being so far back from the weir that the

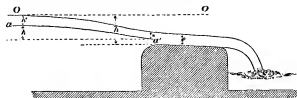

FIG. 47.

velocity of approach is negligible. Let  $OO$  be the surface level in the reservoir, and let  $a$  be at a height  $h'$  below  $OO$ , and  $h'$  above  $a'$ . Let  $h$  be the distance from  $OO$  to the weir crest and  $e$  the thickness of the stream upon it. Neglect atmospheric pressure, which has no influence on the pressure at  $a$  is  $Gh'$ ; at  $a'$  it is  $Gz$ . If  $v$  be the velocity at  $a'$ ,

$$v^2/2g = h' + h'' - z = h - e;$$

$$Q = be\sqrt{2g(h-e)}.$$

Theory does not furnish a value for  $e$ , but  $Q = 0$  for  $e = 0$  and for  $e = h$ .  $Q$  has therefore a maximum for a value of  $e$  between  $0$  and  $h$ , obtained by equating  $dQ/de$  to zero. This gives  $e = \frac{1}{2}h$ , and, inserting this value,

$$Q = 0.385 bh\sqrt{2g}h,$$

as a maximum value of the discharge with the conditions assigned. Experiment shows that the actual discharge is very approximately equal to this maximum, and the formula is more legitimately applicable to the discharge over broad-crested weirs and to cases such as the discharge with free upper surface through large masonry

sluice openings than the ordinary weir formula for sharp-edged weirs. It should be remembered, however, that the friction on the sides and crest of the weir has been neglected, and that this tends to reduce a little the discharge. The formula is equivalent to the ordinary weir formula with  $c = 0.577$ .

#### SPECIAL CASES OF DISCHARGE FROM ORIFICES

§ 45. Cases in which the Velocity of Approach needs to be taken into Account. *Rectangular Orifices and Notches.*—In finding the velocity at the orifice in the preceding investigations, it has been assumed that the head  $h$  has been measured from the free surface of still water above the orifice. In many cases which occur in practice the channel of approach to an orifice or notch is not so large, relatively to the stream through the orifice or notch, that the velocity in it can be disregarded.

Let  $h_1, h_2$  (fig. 48) be the heads measured from the free surface to the top and bottom edges of a rectangular orifice, at a point in the

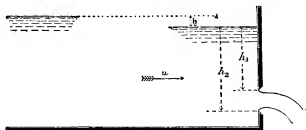

FIG. 48.

channel of approach where the velocity is  $u$ . It is obvious that a fall of the free surface,

$$\bar{h} = u^2/2g$$

has been somewhere expended in producing the velocity  $u$ , and hence the true heads measured in still water would have been  $h_1 + \bar{h}$  and  $h_2 + \bar{h}$ . Consequently the discharge, allowing for the velocity of approach, is

$$Q = \frac{3}{2}cb\sqrt{2g}[(h_2 + \bar{h})^{\frac{3}{2}} - (h_1 + \bar{h})^{\frac{3}{2}}]. \quad (1)$$

And for a rectangular notch for which  $h_1 = 0$ , the discharge is

$$Q = \frac{3}{2}cb\sqrt{2g}[(h_2 + \bar{h})^{\frac{3}{2}} - \bar{h}^{\frac{3}{2}}]. \quad (2)$$

In cases where  $u$  can be directly determined, these formulæ give the discharge quite simply. When, however,  $u$  is only known as a function of the section of the stream in the channel of approach, they become complicated. Let  $\Omega$  be the sectional area of the channel where  $h_1$  and  $h_2$  are measured. Then  $u = Q/\Omega$  and  $\bar{h} = Q^2/2g\Omega^2$ .

This value introduced in the equations above would render them excessively cumbersome. In cases therefore where  $\Omega$  only is known, it is best to proceed by approximation. Calculate an approximate value  $Q'$  of  $Q$  by the equation

$$Q' = \frac{3}{2}cb\sqrt{2g}[h_2^{\frac{3}{2}} - h_1^{\frac{3}{2}}].$$

Then  $\bar{h} = Q'^2/2g\Omega^2$ . This value of  $\bar{h}$  introduced in the equations above will give a second and much more approximate value of  $Q$ .

§ 46. *Partially Submerged Rectangular Orifices and Notches.*—When the tail water is above the lower but below the upper edge of the orifice, the flow in the two parts of the orifice, into which it is divided by the surface of the tail water, takes place under different conditions. A filament  $M_1m_1$  (fig. 49) in the upper part of the orifice issues with a head  $h'$  which may have any value between

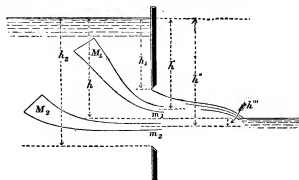

FIG. 49.

$h_1$  and  $h$ . But a filament  $M_2m_2$  issuing in the lower part of the orifice has a velocity due to  $h' - h''$ , or  $h$ , simply. In the upper part of the orifice the head is variable, in the lower constant. If  $Q_1, Q_2$  are the discharges from the upper and lower parts of the orifice,  $b$  the width of the orifice, then

$$Q_1 = \frac{3}{2}cb\sqrt{2g}(h_1^{\frac{3}{2}} - h^{\frac{3}{2}}) \quad \left. \vphantom{Q_1} \right\} \\ Q_2 = cb(h_2 - h)\sqrt{2gh} \quad \left. \vphantom{Q_2} \right\} \quad (3)$$

In the case of a rectangular notch or weir,  $h_1 = 0$ . Inserting this value, and adding the two portions of the discharge together, we get for a drowned weir

$$Q = cb\sqrt{2g}h(h_2 - h)^{\frac{3}{2}}, \quad (4)$$

where  $h$  is the difference of level of the head and tail water, and  $h_2$  is the head from the free surface above the weir to the weir crest (fig. 50).

From some experiments by Messrs A. Fteley and F. P. Stearns (*Trans. Am. Soc. C.E.*, 1883, p. 102) some values of the coefficient  $c$  can be reduced

$h_1/h_2$	$c'$	$h_1/h_2$	$c$
0-1	0-629	0-7	0-578
0-2	0-614	0-8	0-583
0-3	0-600	0-9	0-596
0-4	0-590	0-95	0-607
0-5	0-582	1-00	0-628
0-6	0-578		

If velocity of approach is taken into account, let  $\bar{h}$  be the head due to that velocity; then, adding  $\bar{h}$  to each of the heads in the equations (3), and reducing, we get for a weir

$$Q = cb\sqrt{2g}[(h_2 + \bar{h})(h_2 + \bar{h})^{\frac{3}{2}} - \frac{3}{2}(h_1 + \bar{h})^{\frac{3}{2}}]. \quad (5)$$

an equation which may be useful in estimating flood discharges.

*Bridge Piers and other Obstructions in Streams.*—When the piers of a bridge are erected in a stream they create an obstruction to the flow of the stream, which causes a difference of surface-level above and below the pier (fig. 51). If it is necessary to estimate this difference of level, the flow between the piers may be treated as if it occurred over a drowned weir. But the value of  $c$  in this case is imperfectly known.

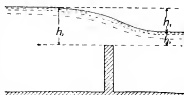

FIG. 50.

§ 47. *Bazin's Researches on Weirs.*—H. Bazin has executed a long series of researches on the flow over weirs, so systematic and complete that they almost supersede other observations. The account of them is contained in a series of papers in the *Annales des Ponts et Chaussées* (October 1888, January 1890, November 1891, February 1894, December 1896, 2nd trimestre 1898). Only a very abbreviated account can be given here. The general plan of the experiments was to establish first the coefficients of discharge for a standard weir without end contractions; next to establish weirs of other types in series with the standard weir on a channel with steady flow, to compare the observed heads on the different weirs and to determine their coefficients from the discharge computed at the standard weir. A channel was constructed parallel to the Canal de Bourgogne, taking water from it through three sluices  $0.3 \times 1.0$  metres. The water enters a masonry chamber 15 metres long by 4 metres wide where it is stilled and passes into the canal at the end of which is the standard weir. The canal has a length of 15 metres, a width of 2 metres and a depth of 1.6 metres. From



FIG. 51.)

this extends a channel 200 metres in length with a slope of 1 mm. per metre. The channel is 2 metres wide with vertical sides. The channels were constructed of concrete rendered with cement. The water levels were taken in chambers constructed near the canal, by floats actuating an index on a dial. Hook gauges were used in determining the heads on the weirs.

*Standard Weir.*—The weir crest was 3.72 ft. above the bottom of the canal and formed by a plate  $\frac{1}{4}$  in. thick. It was sharp-edged with free overfall. It was as wide as the canal so that end contractions were suppressed, and enlargements were formed below the crest to admit air under the water sheet. The channel below the weir was used as a gauging tank. Gaugings were made with the weir 2 metres in length and afterwards with the weir reduced to 1 metre and 0.5 metre in length, the end contractions being suppressed in all cases. Assuming the general formula

$$Q = mh\sqrt{2gh}, \quad (1)$$

Bazin arrives at the following values of  $m$ :-

*Coefficients of Discharge of Standard Weir.*

Head $h$ metres.	Head $h$ feet.	$m$
0.05	.164	0.4485
0.10	.328	0.4336
0.15	.492	0.4284
0.20	.656	0.4262
0.25	.820	0.4259
0.30	.984	0.4266
0.35	1.148	0.4275
0.40	1.312	0.4286
0.45	1.476	0.4299
0.50	1.640	0.4313
0.55	1.804	0.4327
0.60	1.968	0.4341

Bazin compares his results with those of Fteley and Stearns in 1877 and 1879, correcting for a different velocity of approach, and finds a close agreement.

*Influence of Velocity of Approach.*—To take account of the velocity of approach  $u$  it is usual to replace  $h$  in the formula by  $h+au^2/2g$  where  $a$  is a coefficient not very well ascertained. Then

$$Q = \mu(h+au^2/2g)\sqrt{2g(h+au^2/2g)} \\ = \mu h\sqrt{2gh}\sqrt{(1+au^2/2gh)} \quad (2)$$

The original simple equation can be used if

$$m = \mu(1+au^2/2gh)^{\frac{1}{2}} \\ \text{or very approximately, since } au^2/2gh \text{ is small,} \\ m = \mu(1+\frac{1}{2}au^2/2gh) \quad (3)$$

Now if  $p$  is the height of the weir crest above the bottom of the canal (fig. 52),  $u = Q/(p+h)$ . Replacing  $Q$  by its value

$$u^2/2gh = Q^2/[2gh^2(p+h)^2] \\ = m^2(h/(p+h))^2 \quad (4)$$

so that (3) may be written

$$m = \mu[1+k\{h/(p+h)\}^2] \quad (5)$$

Gaugings were made with weirs of 0.75, 0.50, 0.35, and 0.24 metres height above the canal bottom and the results compared with those of the standard weir taken at the same time. The discussion of the results leads to the following values of  $m$  in the general equation (1):-

$$m = \mu(1+2.5u^2/2gh) \\ = \mu[1+0.55\{h/(p+h)\}^2]$$

Values of  $\mu$ -

Head $h$ metres.	Head $h$ feet.	$\mu$
0.05	.164	0.4481
0.10	.328	0.4322
0.20	.656	0.4215
0.30	.984	0.4174
0.40	1.312	0.4144
0.50	1.640	0.4118
0.60	1.968	0.4092

An approximate formula for  $\mu$  is:

$$\mu = 0.405 + 0.003/h \quad (h \text{ in metres}) \\ \mu = 0.405 + 0.01/h \quad (h \text{ in feet}).$$

*Inclined Weirs.*—Experiments were made in which the plank weir was inclined up or down stream, the crest being sharp and the end contraction suppressed. The following are coefficients by which the discharge of a vertical weir should be multiplied to obtain the discharge of the inclined weir.

		Coefficient.
Inclination up stream . . .	1 to 1	0.93
" " " " " " " " " "	3 to 2	0.94
" " " " " " " " " "	3 to 1	0.96
Vertical weir . . . . .	" "	1.00
Inclination down stream . . .	3 to 1	1.04
" " " " " " " " " "	3 to 2	1.07
" " " " " " " " " "	1 to 1	1.10
" " " " " " " " " "	1 to 2	1.12
" " " " " " " " " "	1 to 3	1.09

The coefficient varies appreciably, if  $h/p$  approaches unity, which case should be avoided.

In all the preceding cases the sheet passing over the weir is detached completely from the weir and its under-surface is subject to atmospheric pressure. These conditions permit the most exact determination of the coefficient of discharge. If the sides of the canal below the weir are not so arranged as to permit the access of air under the sheet, the phenomena are more complicated. So long as the head does not exceed a certain limit the sheet is detached

from the weir, but encloses a volume of air which is at less than atmospheric pressure, and the tail water rises under the sheet. The discharge is a little greater than for free overflow. At greater head the air disappears from below the sheet and the sheet is said to be "drowned." The drowned sheet may be independent of the tail water level or influenced by it. In the former case the fall is followed by a rapid, terminating in a standing wave. In the latter case when the foot of the sheet is drowned the level of the tail water influences the discharge even if it is below the weir crest.

*Weirs with Flat Crests.*—The water sheet may spring clear from the upstream edge or may adhere to the flat crest falling free beyond the downstream edge. In the

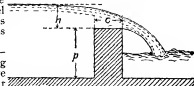

FIG. 53.

former case the condition is that of a sharp-edged weir and it is realized when the head is at least double the width of crest. It may arise if the head is at least  $1\frac{1}{2}$  the width of crest. Between these limits the condition of the sheet is unstable. When the sheet is adherent the coefficient  $m$  depends on the ratio of the head  $h$  to the width of crest  $c$  (fig. 53), and is given by the equation

$$m = m_1 [0.70 - 0.185h/c], \text{ where } m_1 \text{ is the coefficient for a sharp-edged weir in similar conditions. Rounding the upstream edge even to a small extent modifies the discharge. If } R \text{ is the radius of the rounding the coefficient } m \text{ is increased in the ratio } 1 \text{ to } 1 + R/h \text{ nearly. The results are limited to } R \text{ less than } \frac{1}{2}h.$$

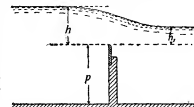

FIG. 54.

*Drowned Weirs.*—Let  $h$  (fig. 54) be the height of head water above the weir crest. Then Bazin obtains as the approximate formula for the coefficient of discharge

$$m = 1.05m_1[1 + kh/p] \sqrt{\{(h-h_1)/h\}}$$

where  $a$  before  $m_1$  is the coefficient for a sharp-edged weir in similar conditions, that is, when the sheet is free and the weir of the same height.

§ 48. *Separating Weirs.*—Many towns derive their water-supply from streams in high moorland districts, in which the flow is extremely variable. The water is collected in large storage reservoirs, from which a uniform supply can be sent to the town. In

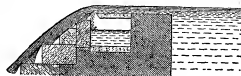

FIG. 55.



Plan of Cast Iron Key

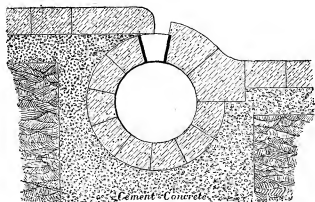

FIG. 56.

such cases it is desirable to separate the coloured water which comes down the streams in high floods from the purer water of ordinary flow. The latter is sent into the reservoirs; the former is allowed

to flow away down the original stream channel, or is stored in separate reservoirs and used as compensation water. To accomplish the separation of the flood and ordinary water, advantage is taken of the different horizontal range of the parabolic path of the water falling over a weir, as the depth on the weir and, consequently, the velocity change. Fig. 55 shows one of these separating weirs in the form in which they were first introduced on the Manchester Waterworks; fig. 56 a more modern weir of the same kind designed by Sir A. Binnie for the Bradford Waterworks. When the quantity of water coming down the stream is not excessive, it drops over the weir into a transverse channel leading to the reservoirs. In flood, the water springs over the mouth of this channel and is led into a waste channel.

It may be assumed, probably with accuracy enough for practical purposes, that the particles describe the parabolas due to the mean velocity of the water passing over the weir, that is, to a velocity

$$\frac{1}{2} \sqrt{(2gh)}$$

where  $h$  is the head above the crest of the weir.

Let  $cb = x$  be the width of the orifice and  $ac = y$  the difference of level of its edges (fig. 57). Then, if a particle passes from  $a$  to  $b$  in  $t$  seconds,

$$y = \frac{1}{2}gt^2, \quad x = \frac{1}{2} \sqrt{(2gh)t};$$

$$\therefore y = \frac{1}{16}x^2/h,$$

which gives the width  $x$  for any given difference of level  $y$  and head  $h$ , which the jet will just pass over the orifice. Set off  $ad$  vertically

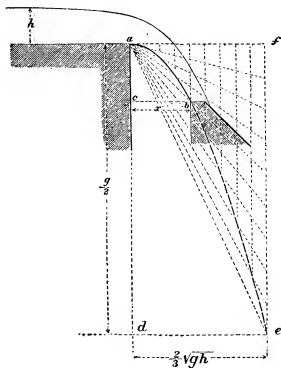

FIG. 57.

and equal to  $\frac{2}{3} \sqrt{2gh}$  on any scale;  $af$  horizontally and equal to  $\frac{1}{3} \sqrt{(2gh)}$ . Divide  $af, fe$  into an equal number of equal parts. Join  $a$  with the divisions on  $ef$ . The intersections of these lines with verticals from the divisions on  $af$  give the parabolic path of the jet.

#### MOUTHPIECES—HEAD CONSTANT

§ 49. *Cylindrical Mouthpieces.*—When water issues from a short cylindrical pipe or mouthpiece of a length at least equal to  $1\frac{1}{2}$  times its smallest transverse dimension, the stream, after contraction within the mouthpiece, expands to fill it and issues full bore, or without contraction, at the point of discharge. The discharge is found to be about one-third greater than that from a simple orifice of the same size. On the other hand, the energy of the fluid per unit of weight is less than that of the stream from a simple orifice with the same head, because part of the energy is wasted in eddies produced at the point where the stream expands to fill the mouthpiece, the action being something like that which occurs at an abrupt change of section.

Let fig. 58 represent a vessel discharging through a cylindrical mouthpiece at the depth  $h$  from the free surface, and let the axis of the jet  $XX$  be taken as the datum with reference to which the head is estimated. Let  $\omega$  be the area of the mouthpiece,  $\omega'$  the area of the stream at the contracted section  $EF$ . Let  $v, \rho$  be the velocity and pressure at  $EF$ , and  $v_1, \rho_1$  the same quantities at  $GH$ . If the discharge is into the air,  $\rho_1$  is equal to the atmospheric pressure  $\rho_a$ . The total head of any filament which goes to form the jet, taken

at a point where its velocity is sensibly zero, is  $h + \rho_a/G$ ; at  $EF$  the total head is  $v^2/2g + \rho/G$ ; at  $GH$  it is  $v_1^2/2g + \rho_1/G$ .

Between  $EF$  and  $GH$  there is a loss of head due to abrupt change of velocity, which from eq. (3), § 36, may have the value

$$\frac{(v-v_1)^2}{2g}$$

Adding this head lost to the head at  $GH$ , before equating it to the heads at  $EF$  and at the point where the filaments start into motion,—  
 $h + \rho_a/G = v_1^2/2g + \rho_1/G = v_1^2/2g + \rho_1/G + (v-v_1)^2/2g$ .  
 But  $\omega v = \omega_1 v_1$ , and  $\omega = c_c \omega_1$ , if  $c_c$  is the coefficient of contraction within the mouthpiece. Hence

$$v = \Omega v_1 / \omega = v_1 / c_c$$

Supposing the discharge into the air, so that  $\rho_1 = \rho_a$ ,

$$h + \rho_a/G = v_1^2/2g + \rho_a/G + (v_1^2/2g) (1/c_c - 1)^2;$$

$$\frac{(v_1/2g) [1 + (1/c_c - 1)^2]}{c_c} = h;$$

$$\therefore v_1 = \sqrt{(2gh)} \sqrt{1 + (1/c_c - 1)^2}; \quad (1)$$

where the coefficient on the right is evidently the coefficient of velocity for the cylindrical

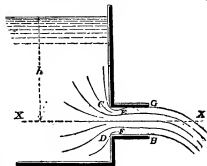

FIG. 58.

mouthpiece in terms of the coefficient of contraction at  $EF$ . Let  $c_c = 0.64$ , the value for simple orifices, then the coefficient of velocity is

$$c_v = 1/\sqrt{1 + (1/c_c - 1)^2}$$

$$= 0.87 \quad (2)$$

The actual value of  $c_c$  found by experiment is 0.82, which does not differ more from the theoretical value than might be expected if the friction of the mouthpiece is allowed for. Hence, for mouthpieces of this kind, and for the section at  $GH$ ,

$$c_c = 0.82 \quad c_v = 1.00 \quad c = 0.82,$$

$$Q = 0.82 \Omega \sqrt{(2gh)}$$

It is easy to see from the equations that the pressure  $p$  at  $EF$  is less than atmospheric pressure. Eliminating  $v_1$ , we get

$$(p_a - p)/G = \frac{1}{2}gh \text{ nearly.} \quad (3)$$

or

$$p = p_a - \frac{1}{2}Gh \text{ per sq. ft.}$$

If a pipe connected with a reservoir on a lower level is introduced into the mouthpiece at the part where the contraction is formed (fig. 59), the water will rise in this pipe to a height

$$KL = (p_a - p)/G = \frac{1}{2}h \text{ nearly.}$$

If the distance  $X$  is less than this, the water from the lower reservoir will be forced continuously into the jet by the atmospheric pressure, and discharged with it. This is the crudest form of a kind of pump known as the jet pump.

§ 50. *Convergent Mouthpieces.*—With convergent mouthpieces there is a contraction within the mouthpiece causing a loss of head, and a diminution of the velocity of discharge, as with cylindrical mouthpieces. There is also a second contraction of the stream outside the mouthpiece. Hence the discharge is given by an equation of the form

$$Q = c_c c_v \Omega \sqrt{(2gh)}, \quad (4)$$

where  $\Omega$  is the area of the external end of the mouthpiece, and  $c_v \Omega$  the section of the contracted jet beyond the mouthpiece.

*Convergent Mouthpieces (Castle's Experiments).—Smallest diameter of orifice = 0.0585 ft. Length of mouthpiece = 2.6 Diameters.*

Angle of Convergence.	Coefficient of Contraction, $c_c$	Coefficient of Velocity, $c_v$	Coefficient of Discharge, $c$
0° 0'	.999	.830	.829
1° 36'	1.000	.866	.866
3° 10'	1.001	.894	.895
4° 10'	1.002	.910	.912
5° 26'	1.004	.920	.924
7° 52'	.998	.931	.929
8° 58'	.992	.942	.934
10° 20'	.987	.950	.938
12° 4'	.986	.955	.942
13° 24'	.983	.962	.946
14° 28'	.979	.966	.941
16° 36'	.969	.971	.938
19° 28'	.953	.970	.924
21° 0'	.945	.971	.918
23° 0'	.937	.974	.913
29° 58'	.919	.975	.896
40° 20'	.887	.980	.869
48° 50'	.861	.984	.847

The maximum coefficient of discharge is that for a mouthpiece with a convergence of  $13^\circ 24'$ .

The values of  $c_v$  and  $c_c$  must here be determined by experiment. The above table gives values sufficient for practical purposes. Since

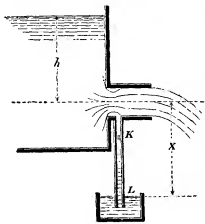

FIG. 59.

the contraction becomes greater with the convergence, or, what is the same thing,  $c_c$  diminishes, and on the other hand the loss of energy diminishes, so that  $c_v$  increases with the convergence, there is an angle for which the product  $c_c c_v$ , and consequently the discharge, is a maximum.

§ 51. *Divergent Mouthpiece.*—Suppose a mouthpiece so designed that there is no abrupt change in the section or velocity of the stream passing through it. It may have a form at the inner end approximately the same as that of a simple contracted vein, and may then enlarge gradually, as shown in fig. 60. Suppose that at EF it becomes cylindrical, so that the jet may be taken to be of the diameter EF. Let  $\omega$ ,  $v$ ,  $p$  be the section, velocity and pressure at CD, and  $\Omega$ ,  $v_1$ ,  $p_1$  the same quantities at EF,  $p_a$  being as usual the atmospheric pressure, or pressure on the free surface AB. Hence since there is no loss of energy, except the small frictional resistance of the surface of the mouthpiece,

$$h + p_a/G = v^2/2g + p/G = v_1^2/2g + p_1/G$$

If the jet discharges into the air,  $p_1 = p_a$ ; and  $v_1^2/2g = h$ ;  $v_1 = \sqrt{2gh}$ ; or, if a coefficient is introduced to allow for friction,  $v_1 = c_v \sqrt{2gh}$ ; where  $c_v$  is about 0.97 if the mouthpiece is smooth and well formed.

$$Q = \Omega v_1 = c_v \Omega v_1 \sqrt{2gh}$$

Hence the discharge depends on the area of the stream at EF, and not at all on that at CD, and the latter may be made as small as we please without affecting the amount of water discharged.

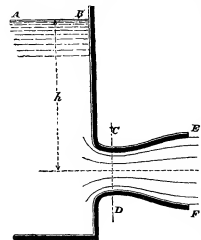

FIG. 60.

There is, however, a limit to this. As the velocity at CD is greater than at EF the pressure is less, and therefore less than atmospheric pressure, if the discharge is into the air. If CD is so contracted that  $p = 0$ , the continuity of flow is impossible. In fact the stream disengages itself from the mouthpiece for some value of  $p$  greater than 0 (fig. 61).

From the equations,

$$p/G = p_a/G - (v^2 - v_1^2)/2g$$

$$\text{Let } \Omega/\omega = m. \text{ Then}$$

$$v = v_1 m;$$

$$p/G = p_a/G - v_1^2(m^2 - 1)/2g$$

$$= p_a/G - (m^2 - 1)h;$$

whence we find that  $p/G$  will become zero or negative if

$$\Omega/\omega \equiv \sqrt{\{(h + p_a/G)/h\}}$$

$$\approx \sqrt{1 + p_a/Gh};$$

or, putting  $p_a/G = 34$  ft., if

$$\Omega/\omega \equiv \sqrt{\{(h + 34)/h\}}.$$

In practice there will be an interruption of the full bore flow with a less ratio of  $\Omega/\omega$ , because of the disengagement of air from the water. But, supposing this does not occur, the maximum discharge of a mouthpiece of this kind is

$$Q = \omega v \sqrt{2g(h + p_a/G)};$$

that is, the discharge is the same as for a well-bellmouthed mouthpiece of area  $\omega$ , and without the expanding part, discharging into a vacuum.

§ 52. *Jet Pump.*—A divergent mouthpiece may be applied to act as a pump, as shown in fig. 62. The water which supplies the energy

required for pumping enters at A. The water to be pumped enters at B. The streams combine at DD where the velocity is greatest and the pressure least. Beyond DD the stream enlarges in section,

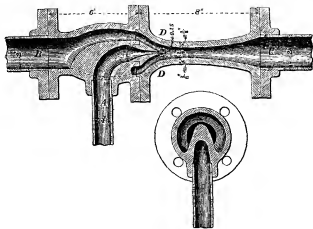

FIG. 62.

and its pressure increases, till it is sufficient to balance the head due to the height of the lift, and the water flows away by the discharge pipe C.

Fig. 63 shows the whole arrangement in a diagrammatic way. A is the reservoir which supplies the water that effects the pumping;

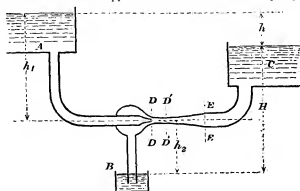

FIG. 63.

B is the reservoir of water to be pumped; C is the reservoir into which the water is pumped.

#### DISCHARGE WITH VARYING HEAD

§ 53. *Flow from a Vessel when the Effective Head varies with the Time.*—Various useful problems arise relating to the time of emptying and filling vessels, reservoirs, lock chambers, &c., where the flow is dependent on a head which increases or diminishes during the operation. The simplest of these problems is the case of filling or emptying a vessel of constant horizontal section.

*Time of Emptying or Filling a Vertical-sided Lock Chamber.*—Suppose the lock chamber, which has a water surface of  $\Omega$  square ft., is emptied through a sluice in the tail gates, of area  $\omega$ , placed below the tail-water level. Then the effective head producing flow through the sluice is the difference of level in the chamber and tail bay. Let H (fig. 64) be the initial difference of level,  $h$  the difference

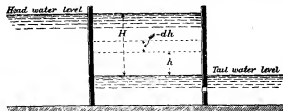

FIG. 64.

of level after  $t$  seconds. Let  $-dh$  be the fall of level in the chamber during an interval  $dt$ . Then in the time  $dt$  the volume in the chamber is altered by the amount  $-\Omega dh$ , and the outflow from the sluice in the same time is  $\omega v \sqrt{2gh} dt$ . Hence the differential equation connecting  $h$  and  $t$  is

$$\omega v \sqrt{2gh} dt + \Omega dh = 0.$$



For the time  $t$ , during which the initial head  $H$  diminishes to any other value  $h$ ,

$$-\Omega(\omega\sqrt{2g}) \int_h^H dh/\sqrt{h} = \int_0^t dt.$$

$$\therefore t = 2\Omega(\sqrt{H} - \sqrt{h})/(\omega\sqrt{2g})$$

$$= (\Omega/\omega)\sqrt{(2H/g) - (2h/g)}.$$

For the whole time of emptying, during which  $h$  diminishes from  $H$  to 0,

$$T = (\Omega/\omega)\sqrt{(2H/g)}.$$

Comparing this with the equation for flow under a constant head, it will be seen that the time is double that required for the discharge of an equal volume under a constant head.

The time of filling the lock through a sluice in the head gates is exactly the same, if the sluice is below the tail-water level. But if the sluice is above the tail-water level, then the head is constant till the level of the sluice is reached, and afterwards it diminishes with the time.

#### PRACTICAL USE OF ORIFICES IN GAUGING WATER

§ 54. If the water to be measured is passed through a known orifice under an arrangement by which the constancy of the head is ensured, the amount which passes in a given time can be ascertained by the formulæ already given. It will obviously be best to make the orifices of the forms for which the coefficients are most accurately determined; hence sharp-edged orifices or notches are most commonly used.

*Water Inch.*—For measuring small quantities of water circular sharp-edged orifices have been used. The discharge from a circular orifice one French inch in diameter, with a head of one line above the top edge, was termed by the older hydraulic writers a water-inch. A common estimate of its value was 14 pints per minute, or 677 English cub. ft. in 24 hours. An experiment by C. Bossut gave 634 cub. ft. in 24 hours (see Navier's edition of *Belidor's Arch. Hydr.*, p. 212).

L. J. Weisbach points out that measurements of this kind would be made more accurately with a greater head over the orifice, and he proposes that the head should be equal to the diameter of the orifice. Several equal orifices may be used for larger discharges.

*Pin Ferrules or Measuring Cocks.*—To give a tolerably definite supply of water to houses, without the expense of a meter, a ferrule with an orifice of a definite size, or a cock, is introduced in the service-pipe. If the head in the water main is constant, then a definite quantity of water would be delivered in a given time. The arrangement is not a very satisfactory one, and acts chiefly as a check on extravagant use of water. It is interesting here chiefly as an example of regulation of discharge by means of an orifice.

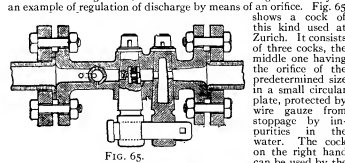

FIG. 65.

consumer for emptying the pipes. The one on the left and the measuring cock are connected by a key which can be locked by a padlock, which is under the control of the water company.

§ 55. *Measurement of the Flow in Streams.*—To determine the quantity of water flowing off the ground in small streams, which is available for water supply or for obtaining water power, small temporary weirs are often used. These may be formed of planks supported by piles and puddled to prevent leakage. The measurement of the head may be made by a thin-edged scale at a short distance behind the weir, where the water surface has not begun to slope down to the weir and where the velocity of approach is not high. The measurements are conveniently made from a short pile driven into the bed of the river, accurately level with the crest of the weir (fig. 66). Then if at any moment the head is  $h$ , the discharge is, for a rectangular notch of breadth  $b$ ,

$$Q = \frac{2}{3}cbh\sqrt{2gh}$$

where  $c = 0.62$ ; or, better, the formula in § 42 may be used.

Gauging weirs are most commonly in the form of rectangular notches; and care should be taken that the crest is accurately horizontal, and that the weir is normal to the direction of flow of the stream. If the planks are thick, they should be bevelled (fig. 67), and then the edge may be protected by a metal plate about  $\frac{1}{16}$  in. thick to secure the requisite accuracy of form and sharpness of edge. In permanent gauging weirs, a cast steel plate is sometimes used to form the edge of the weir crest. The weir should be large enough to discharge the maximum volume flowing in the stream, and at the same time it is desirable that the minimum head should

not be too small (say half a foot) to decrease the effects of errors of measurement. The section of the jet over the weir should not exceed one-fifth the section of the stream behind the weir, or the velocity of approach will need to be taken into account. A triangular notch is very suitable for measurements of this kind.

If the flow is variable, the head  $h$  must be recorded at equidistant intervals of time, say twice daily, and then for each 12-hour period

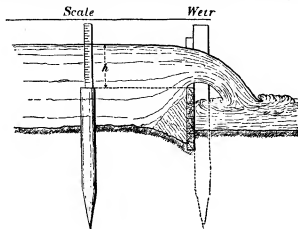

FIG. 66.

the discharge must be calculated for the mean of the heads at the beginning and end of the time. As this involves a good deal of troublesome calculation, E. Sang proposed to use a scale so graduated as to read off the discharge in cubic feet per second. The lengths of the principal graduations of such a scale are easily calculated by putting  $Q = 1, 2, 3, \dots$  in the ordinary formulæ for notches; the intermediate graduations may be taken accurately enough by subdividing equally the distances between the principal graduations.

The accurate measurement of the discharge of a stream by means of a weir is, however, in practice, rather more difficult than might

be inferred from the simplicity of the principle of the operation. Apart from the difficulty of selecting a suitable coefficient of discharge, which need not be serious if the form of the weir and the nature of its crest are properly attended to, other difficulties of measurement arise. The length of the weir should be very accurately determined, and if the weir is rectangular its deviations from exactness of level should be tested. Then the agitation of the water, the ripple on its surface, and the adhesion of the water to the scale on which the head is measured, are liable to introduce errors. Upon a weir 10 ft. long, with 1 ft. depth of water flowing over, an error of 1-1000th of a foot in measuring the head, or an error of 1-100th of a foot in measuring the length of the weir, would cause an error in computing the discharge of 2 cub. ft. per minute.

*Hook Gauge.*—For the determination of the surface level of water, the most accurate instrument is the hook gauge used first by U. Boyden of Boston, in 1840. It consists of a fixed frame with scale and vernier. In the instrument in fig. 68 the vernier is fixed to the frame, and the scale slides vertically. The scale carries at its lower end a hook with a fine point, and the scale can be raised or lowered by a fine pitched screw. If the hook is depressed below the water surface and then raised by the screw, the moment of its reaching the water surface will be very distinctly marked, by the reflection from a small capillary elevation of the water surface over the point of the hook. In ordinary light, differences of level of the water of .001 of a foot are easily detected by the hook gauge. If such a gauge is used to determine the heads at a weir, the hook should

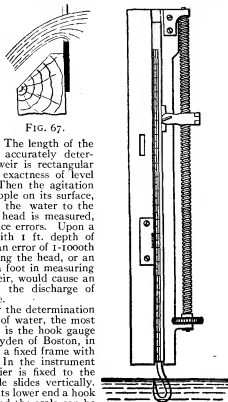

FIG. 68

first be set accurately level with the weir crest, and a reading taken. Then the difference of the reading at the water surface and that for the weir crest will be the head at the weir.

§ 56. *Modules used in Irrigation.*—In distributing water for irrigation, the charge for the water may be simply assessed on the area of the land irrigated for each consumer, a method followed in India; or a regulated quantity of water may be given to each consumer, and the charge may be made proportional to the quantity of water supplied, a method employed for a long time in Italy and other parts of Europe. To deliver a regulated quantity of water

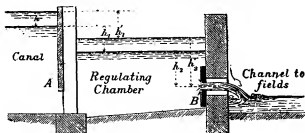

FIG. 69.

from the irrigation channel, arrangements termed modules are used. These are constructions intended to maintain a constant or approximately constant head above an orifice of fixed size, or to regulate the size of the orifice so as to give a constant discharge, notwithstanding the variation of level in the irrigating channel.

§ 57. *Italian Module.*—The Italian modules are masonry constructions, consisting of a regulating chamber, to which water is admitted by an adjustable sluice from the canal. At the other end of the chamber is an orifice in a thin flagstone of fixed size. By means of the adjustable sluice a tolerably constant head above the fixed orifice is maintained, and therefore there is a nearly constant discharge of ascertainable amount through the orifice, into the channel leading to the fields which are to be irrigated.

In fig. 69, A is the adjustable sluice by which water is admitted to the regulating chamber; B is the fixed orifice through which the water is discharged. The sluice A is adjusted from time to time by the canal officers, so as to bring the level of the water in the regulating chamber to a fixed level marked on the wall of the chamber. When

time to time. It has further the advantage that the cultivator, by observing the level of the water in the chamber, can always see whether or not he is receiving the proper quantity of water.

On each canal the orifices are of the same height, and intended to work with the same normal head, the width of the orifices being varied to suit the demand for water. The unit of discharge varies on different canals, being fixed in each case by legal arrangements. Thus on the Canal Lodi the unit of discharge or one module of water is the discharge through an orifice 1.12 ft. high, 0.12416 ft. wide, with a head of 0.32 ft. above the top edge of the orifice, or .88 ft. above the centre. This corresponds to a discharge of about 0.6165 cub. ft. per second.

In the most elaborate Italian modules the regulating chamber is arched over, and its dimensions are very exactly prescribed. Thus in the modules of the Naviglio Grande of Milan, shown in fig. 70, the measuring orifice is cut in a thin stone slab, and so placed that the discharge is into the air with free contraction on all sides. The

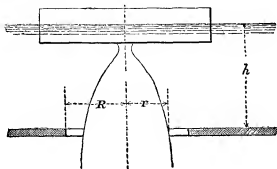

FIG. 71.

adjusting sluice is placed with its sill flush with the bottom of the canal, and is provided with a rack and lever and locking arrangement. The covered regulating chamber is about 20 ft. long, with a breadth 1.64 ft. greater than that of the discharging orifice. At precisely the normal level of the water in the regulating chamber, there is a ceiling of planks intended to still the agitation of the water. A block of stone serves to indicate the normal level of the water in the chamber. The water is discharged into an open channel 0.655 ft. wider than the orifice, spaying out till it is 1.637 ft. wider than the orifice, and about 18 ft. in length.

§ 58. *Spanish Module.*—On the canal of Isabella II., which supplies water to Madrid, a module much more perfect in principle than the Italian module is employed. Part of the water is supplied for irrigation, and as it is very valuable, its strict measurement is essential.

The module (fig. 72) consists of two chambers one above the other, the upper chamber being in free communication with the irrigation canal, and the lower chamber discharging by a culvert to the fields. In the arched roof between the chambers there is a circular sharp-edged orifice in a bronze plate. Hanging in this there is a bronze plug of variable diameter suspended from a hollow brass float. If the water level in the canal lowers, the plug descends and gives an enlarged opening, and conversely. Thus a perfectly constant discharge with a varying head can be obtained, provided no clogging or silting of the chambers prevents the free discharge of the water or the rise and fall of the float. The theory of the module is very simple. Let  $R$  (fig. 71) be the radius of the fixed opening,  $r$  the radius of the plug at a distance  $h$  from the plane of flotation of the float, and  $Q$  the required discharge of the module. Then

$$Q = c_1 r \sqrt{R^2 - r^2} \sqrt{2gh}.$$

Taking  $c = 0.63$ ,

$$Q = 15.88(R^2 - r^2) \sqrt{h};$$

$$r = \sqrt{R^2 - Q/15.88 \sqrt{h}}.$$

Choosing a value for  $R$ , successive values of  $r$  can be found for different values of  $h$ , and from these the curve of the plug can be drawn. The module shown in fig. 72 will discharge 1 cubic metre per second. The fixed opening is 0.2 metre diameter, and the greatest head above the fixed orifice is 1 metre. The use of this module involves a great sacrifice of level between the canal and the fields. The module is described in Sir C. Scott-Moncrieff's *Irrigation in Southern Europe*.

§ 59. *Reservoir Gauging Basins.*—In obtaining the power to store the water of streams in reservoirs, it is usual to concede to riparian

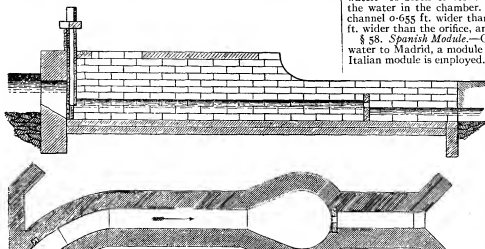
FIG. 70.—Scale  $\frac{1}{16}$ .

adjusted it is locked. Let  $\omega_1$  be the area of the orifice through the sluice at A, and  $\omega_2$  that of the fixed orifice at B; let  $h_1$  be the difference of level between the surface of the water in the canal and regulating chamber;  $h_2$  the head above the centre of the discharging orifice, when the sluice has been adjusted and the flow has become steady;  $Q$  the normal discharge in cubic feet per second. Then, since the flow through the orifices at A and B is the same,

$$Q = c_1 \omega_1 \sqrt{2gh_1} = c_2 \omega_2 \sqrt{2gh_2},$$

where  $c_1$  and  $c_2$  are the coefficients of discharge suitable for the two orifices. Hence

$$c_1 \omega_1 / c_2 \omega_2 = \sqrt{h_2 / h_1}.$$

If the orifice at B opened directly into the canal without any intermediate regulating chamber, the discharge would increase for a given change of level in the canal in exactly the same ratio. Consequently the Italian module in no way moderates the fluctuations of discharge, except so far as it affords means of easy adjustment from

owners below the reservoirs a right to a regulated supply throughout the year. This compensation water requires to be measured in such a way that the millowners and others interested in the matter can assure themselves that they are receiving a proper quantity, and they are generally allowed a certain amount of control as to the times during which the daily supply is discharged into the stream.

flows over this, without entering it, on a floor of cast-iron plates. If the discharge is to be tested, the water is turned for a definite time into the gauging basin, by suddenly opening and closing a sluice at *c*. The volume of flow can be ascertained from the depth in the gauging chamber. A mechanical arrangement (fig. 73) was designed for securing an absolutely constant head over the orifices at *a, a*. The orifices were formed in a cast-iron plate capable of sliding up and

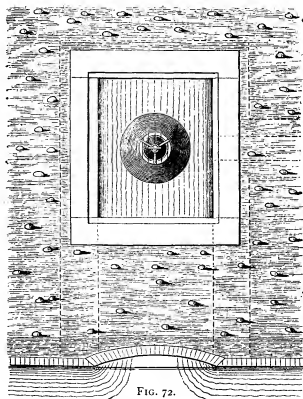
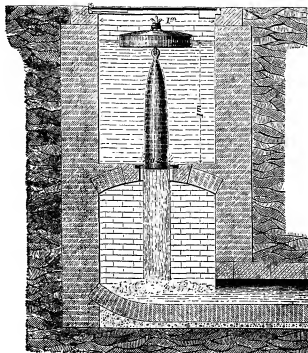

FIG. 72.

Fig. 74 shows an arrangement designed for the Manchester water works. The water enters from the reservoir a chamber A, the object of which is to still the irregular motion of the water. The admission is regulated by sluices at *b, b, b*. The water is discharged by orifices or notches at *a, a*, over which a tolerably constant head is maintained by adjusting the sluices at *b, b, b*. At any time the millowners can see whether the discharge is given and whether the proper head is maintained over the orifices. To test at any time the discharge of the orifices, a gauging basin B is provided. The water ordinarily

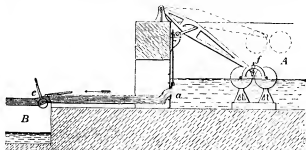

FIG. 73.—Scale 1/10.

down, without sensible leakage, on the face of the wall of the chamber. The orifice plate was attached by a link to a lever, one end of which rested on the wall and the other on floats *f* in the chamber A. The floats rose and fell with the changes of level in the chamber, and raised and lowered the orifice plate at the same time. This

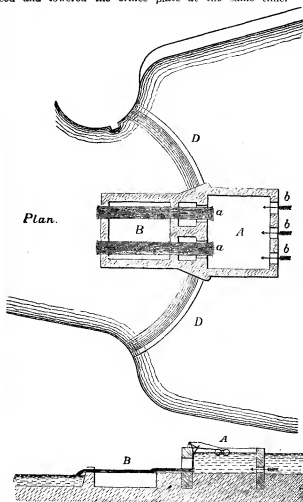

FIG. 74.—Scale 1/10.

mechanical arrangement was not finally adopted, careful watching of the sluices at *b, b, b*, being sufficient to secure a regular discharge. The arrangement is then equivalent to an Italian module, but on a large scale.

§ 60. Professor Fleeming Jenkin's Constant Flow Valve.—In the modules thus far described constant discharge is obtained by varying the area of the orifice through which the water flows. Professor F. Jenkin has contrived a valve in which a constant pressure head is obtained, so that the orifice need not be varied (Roy. Scot. Society

of Arts, 1876). Fig. 75 shows a valve of this kind suitable for a 6-in. water main. The water arriving by the main C passes through an equilibrium valve D into the chamber A, and thence through a sluice O, which can be set for any required area of opening, into the discharging main B. The object of the arrangement is to secure a constant difference of pressure between the chambers A and B, so that a constant discharge flows through the stop valve O. The equilibrium valve D is rigidly connected with a plunger P loosely fitted in a diaphragm, separating A from a chamber B<sub>1</sub> connected by a pipe B, with the discharging main B. Any increase of the difference of pressure in A and B will drive the plunger up and close the

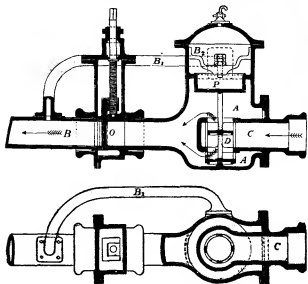

FIG. 75.—Scale  $\frac{1}{4}$ .

equilibrium valve, and conversely a decrease of the difference of pressure will cause the descent of the plunger and open the equilibrium valve wider. Thus a constant difference of pressure is obtained in the chambers A and B. Let  $\omega$  be the area of the plunger in square feet,  $p$  the difference of pressure in the chambers A and B in pounds per square foot,  $w$  the weight of the plunger and valve. Then if at any moment  $p\omega$  exceeds  $w$  the plunger will rise, and if it is less than  $w$  the plunger will descend. Apart from friction, and assuming the valve D to be strictly an equilibrium valve, since  $\omega$  and  $w$  are constant,  $p$  must be constant also, and equal to  $w/\omega$ . By making  $w$  small and  $\omega$  large, the difference of pressure required to ensure the working of the apparatus may be made very small. Valves working with a difference of pressure of  $\frac{1}{2}$  in. of water have been constructed.

## VI. STEADY FLOW OF COMPRESSIBLE FLUIDS.

§ 61. *External Work during the Expansion of Air.*—If air expands without doing any external work, its temperature remains constant.

This result was first experimentally demonstrated by J. P. Joule. It leads to the conclusion that, however air changes its state, the internal work done is proportional to the change of temperature. When, in expanding, air does work against an external resistance, either heat must be supplied or the temperature falls.

To fix the conditions, suppose 1 lb of air confined behind a piston of 1 sq. ft. area (fig. 76). Let the initial pressure be  $p_1$  and the volume of the air  $v_1$ , and suppose this to expand to the pressure  $p_2$  and volume  $v_2$ . If  $p$  and  $v$  are the corresponding pressure and volume at any intermediate point in the expansion, the work done on the piston during the expansion from  $v$  to  $v+dv$  is  $p dv$ , and the whole work during the expansion from  $v_1$  to  $v_2$ , represented by the area  $abcd$ , is

$$\int_{v_1}^{v_2} p dv.$$

Amongst possible cases two may be selected.

Case 1.—So much heat is supplied to the air during expansion that the temperature remains constant. Hyperbolic expansion.

Then  $p v = p_1 v_1$ .  
Work done during expansion per pound of air

$$= \int_{v_1}^{v_2} p dv = p_1 v_1 \int_{v_1}^{v_2} \frac{dv}{v} \\ = p_1 v_1 \log_e v_2/v_1 = p_1 v_1 \log_e p_1/p_2. \quad (1)$$

Since the weight per cubic foot is the reciprocal of the volume per pound, this may be written

$$(p_1/G_1) \log_e G_1/G_2. \quad (1a)$$

Then the expansion curve  $ab$  is a common hyperbola.

Case 2.—No heat is supplied to the air during expansion. Then the air loses an amount of heat equivalent to the external work done and the temperature falls. Adiabatic expansion.

In this case it can be shown that

$$p v^\gamma = p_1 v_1^\gamma,$$

where  $\gamma$  is the ratio of the specific heats of air at constant pressure and volume. Its value for air is 1.408, and for dry steam 1.135.

Work done during expansion per pound of air

$$= \int_{v_1}^{v_2} p dv = p_1 v_1^\gamma \int_{v_1}^{v_2} \frac{dv}{v^{\gamma+1}} \\ = -\frac{p_1 v_1^\gamma}{\gamma} \left[ \frac{1}{v^{\gamma-1}} \right]_{v_1}^{v_2} \\ = -\frac{p_1 v_1^\gamma}{\gamma} \left[ \frac{1}{v_2^{\gamma-1}} - \frac{1}{v_1^{\gamma-1}} \right] \\ = \frac{p_1 v_1^\gamma}{\gamma} \left[ \frac{1}{v_1^{\gamma-1}} - \frac{1}{v_2^{\gamma-1}} \right]. \quad (2)$$

The value of  $p_1 v_1^\gamma$  for any given temperature can be found from the data already given.

As before, substituting the weights  $G_1, G_2$  per cubic foot for the volumes per pound, we get for the work of expansion

$$\frac{p_1(G_1)}{\gamma} \left[ \frac{1}{v_1^{\gamma-1}} - \frac{1}{v_2^{\gamma-1}} \right] \quad (2a) \\ = \frac{p_1 v_1}{\gamma} \left[ \frac{1}{v_1^{\gamma-1}} - \frac{1}{v_2^{\gamma-1}} \right]. \quad (2b)$$

§ 62. *Modification of the Theorem of Bernoulli's for the Case of a Compressible Fluid.*—In the application of the principle of work to a filament of compressible fluid, the internal work done by the expansion of the fluid, or absorbed in its compression, must be taken into account. Suppose, as before, that AB (fig. 77) comes to A'B' in a short time  $t$ . Let  $p_1, \omega_1, v_1, G_1$  be the pressure, sectional area of stream, velocity and weight of a cubic foot at A, and  $p_2, \omega_2, v_2, G_2$  the same quantities at B. Then, from the steadiness of motion, the weight of fluid passing A in any given time must be equal to the weight passing B:

$$G_1 \omega_1 v_1 t = G_2 \omega_2 v_2 t.$$

Let  $z_1, z_2$  be the heights of the sections A and B above any given datum. Then the work of gravity on the mass AB in  $t$  seconds is

$$G_1 \omega_1 v_1 t (z_1 - z_2) = W(z_1 - z_2),$$

where  $W$  is the weight of gas passing A or B per second. As in the case of an incompressible fluid, the work of the pressures on the ends of the mass AB is

$$\frac{p_1 \omega_1 v_1 t - p_2 \omega_2 v_2 t}{G_1/G_2 - p_2/G_2} W t.$$

The work done by expansion of  $Wt$  lb of fluid between A and B is  $Wt \int_{v_1}^{v_2} p dv$ . The change of kinetic energy as before is  $(W/2g)(v_2^2 - v_1^2)t$ . Hence, equating work to change of kinetic energy,

$$W(z_1 - z_2)t + \frac{p_1 \omega_1 v_1 t - p_2 \omega_2 v_2 t}{G_1/G_2 - p_2/G_2} W t + Wt \int_{v_1}^{v_2} p dv = (W/2g)(v_2^2 - v_1^2)t; \\ \therefore z_1 + p_1/G_1 + v_1^2/2g = z_2 + p_2/G_2 + v_2^2/2g - \int_{v_1}^{v_2} p dv. \quad (1)$$

Now the work of expansion per pound of fluid has already been given. If the temperature is constant, we get (eq. 1a, § 61)

$$z_1 + p_1/G_1 + v_1^2/2g = z_2 + p_2/G_2 + v_2^2/2g - (p_1/G_1) \log_e (G_1/G_2).$$

But at constant temperature  $p_1/G_1 = p_2/G_2$ ;

$$\therefore z_1 + v_1^2/2g = z_2 + v_2^2/2g - (p_1/G_1) \log_e (p_1/p_2), \quad (2)$$

or, neglecting the difference of level,

$$(v_2^2 - v_1^2)/2g = (p_1/G_1) \log_e (p_1/p_2). \quad (2a)$$

Similarly, if the expansion is adiabatic (eq. 2a, § 61),

$$z_1 + p_1/G_1 + v_1^2/2g = z_2 + p_2/G_2 + v_2^2/2g - \frac{p_1(G_1)}{\gamma} \left[ \frac{1}{v_1^{\gamma-1}} - \frac{1}{v_2^{\gamma-1}} \right]; \quad (3)$$

or neglecting the difference of level

$$(v_2^2 - v_1^2)/2g = \frac{p_1(G_1)}{\gamma} \left[ \frac{1}{v_1^{\gamma-1}} - \frac{1}{v_2^{\gamma-1}} \right] - p_2/G_2. \quad (3a)$$

It will be seen hereafter that there is a limit in the ratio  $p_1/p_2$  beyond which these expressions cease to be true.

§ 63. *Discharge of Air from an Orifice.*—The form of the equation of work for a steady stream of compressible fluid is

$$z_1 + p_1/G_1 + v_1^2/2g = z_2 + p_2/G_2 + v_2^2/2g - (p_1/G_1) \left[ \frac{1}{v_1^{\gamma-1}} - \frac{1}{v_2^{\gamma-1}} \right].$$

the expansion being adiabatic, because in the flow of the streams of air through an orifice no sensible amount of heat can be communicated from outside.

Suppose the air flows from a vessel, where the pressure is  $p_1$  and the velocity sensibly zero, through an orifice, into a space where the pressure is  $p_2$ . Let  $v_1$  be the velocity of the jet at a point where the convergence of the streams has ceased, so that the pressure in the jet is also  $p_2$ . As air is light, the work of gravity will be small compared with that of the pressures and expansion, so that  $\rho_2 v_2$  may be neglected. Putting these values in the equation above—

$$p_1 G_1 = p_2(G_2 + v_2^2/2g - (p_1/G_1) \{1/(\gamma-1)\} \{1 - (p_2/p_1)^{(\gamma-1)/\gamma} - v_2^2/2g = p_1(G_1 - p_2/G_2 + (p_1/G_1) \{1/(\gamma-1)\} \{1 - (p_2/p_1)^{(\gamma-1)/\gamma} - (p_1/G_1) \{1/(\gamma-1)\} - (p_2/p_1)^{(\gamma-1)/\gamma} \} (\gamma-1) - (p_2/p_1)^{(\gamma-1)/\gamma} \} (\gamma-1) - p_2/G_2$$

But  $p_1 G_1 \gamma = p_2 G_2 \gamma \therefore p_2/G_2 = (p_1/G_1) (p_2/p_1)^{(\gamma-1)/\gamma}$   
 $v_2^2/2g = (p_1/G_1) \{1/(\gamma-1)\} \{1 - (p_2/p_1)^{(\gamma-1)/\gamma}\} \quad (1)$

or  $v_2^2/2g = 1/\gamma(\gamma-1) \{1 - (p_2/p_1)^{(\gamma-1)/\gamma}\} \quad (2)$   
 an equation commonly ascribed to L. J. Weisbach (*Civilingenieur*, 1856), though it appears to have been given earlier by A. J. C. Barre de Saint Venant and L. Wantzel.

It has already (§ 9, eq. 40) been seen that

$$p_1/G_1 = (p_2/G_2)(r_1/r_0)$$

where for air  $p_2 = 2116.8$ ,  $G_0 = 0.8075$  and  $r_0 = 492.6$ .

$$v_2^2/2g = 1/\gamma r_1 \gamma / G_0 r_0 (\gamma-1) \{1 - (p_2/p_1)^{(\gamma-1)/\gamma}\} \quad (2)$$

or, inserting numerical values,

$$v_2^2/2g = 183.6 r_1 \{1 - (p_2/p_1)^{0.99}\} \quad (2a)$$

which gives the velocity of discharge  $v_2$  in terms of the pressure and absolute temperature,  $p_2$ ,  $r_1$ , in the vessel from which the air flows, and the pressure  $p_1$  in the vessel into which it flows.

Proceeding now as for liquids, and putting  $\omega$  for the area of the orifice and  $c$  for the coefficient of discharge, the volume of air discharged per second at the pressure  $p_2$  and temperature  $r_1$  is

$$Q_2 = c\omega v_2 = c\omega \sqrt{[2g\gamma p_1/(\gamma-1)G_1] \{1 - (p_2/p_1)^{(\gamma-1)/\gamma}\}} \\ = 108.7c\omega \sqrt{r_1 \{1 - (p_2/p_1)^{0.99}\}} \quad (3)$$

If the volume discharged  $\omega$  in the vessel from which the air flows, let  $Q_1$  be that volume; then

$$p_1 Q_1 \gamma = p_2 Q_2 \gamma;$$

$$Q_1 = (p_2/p_1)^{1/\gamma} Q_2;$$

$$Q_2 = c\omega \sqrt{[2g\gamma p_1/(\gamma-1)G_1] \{1 - (p_2/p_1)^{(\gamma-1)/\gamma}\}} \\ Q_1 = c\omega \sqrt{[2g\gamma p_1/(\gamma-1)G_1] \{1 - (p_2/p_1)^{(\gamma-1)/\gamma}\} \{1 - (p_2/p_1)^{1/\gamma}\}}; \text{ then}$$

$$Q_1 = c\omega \sqrt{[2g\gamma p_1/(\gamma-1)G_1] \{1 - (p_2/p_1)^{1/\gamma}\}}; \text{ then} \\ Q_1 = 108.7c\omega p_1 \sqrt{r_1 \psi} \quad (4)$$

The weight of air at pressure  $p_1$  and temperature  $r_1$  is

$$G_1 = p_1/53.2 r_1 \text{ lb per cubic foot.}$$

Hence the weight of air discharged is

$$W = G_1 Q_1 = c\omega \sqrt{[2g\gamma p_1 G_1/(\gamma-1)]} \\ = 2.043c\omega p_1 \sqrt{W/r_1} \quad (5)$$

Weisbach found the following values of the coefficient of discharge  $c$ —

Conoidal mouthpieces of the form of the contracted vein with effective pressures of +23 to +1 atmosphere	$c =$	0.97 to 0.99
Circular sharp-edged orifices		0.563 „ 0.788
Short cylindrical mouthpieces		0.81 „ 0.84
The same rounded at the inner end		0.92 „ 0.93
Conical converging mouthpieces		0.90 „ 0.99

§ 64. *Limit to the Application of the above Formulæ.*—In the formulæ above it is assumed that the fluid issuing from the orifice expands from the pressure  $p_1$  to the pressure  $p_2$ , while passing from the vessel to the jet considered in estimating the area  $\omega$ . Hence  $p_2$  is strictly the pressure in the jet at the plane of the external orifice in the case of mouthpieces, or at the plane of the contracted section in the case of simple orifices. Till recently it was tacitly assumed that this pressure  $p_2$  was identical with the general pressure external to the orifice. R. D. Napier first discovered that, when the ratio  $p_2/p_1$  exceeded a value which does not greatly differ from 0.5, this was no longer true. In that case the expansion of the fluid down to the external pressure is not completed at the time it reaches the plane of the contracted section, and the pressure there is greater than the general external pressure; or, what amounts to the same thing, the section of the jet where the expansion is completed is a section which is greater than the area  $c\omega$  of the contracted section of the jet, and may be greater than the area  $\omega$  of the orifice. Napier made experiments with steam which showed that, so long as  $p_2/p_1 > 0.5$ , the formulæ above were trustworthy, when  $p_2$  was taken to be the general external pressure, but that, if  $p_2/p_1 < 0.5$ , then the pressure at the contracted section was independent of the external pressure and equal to 0.5 $p_1$ . Hence in such cases the constant value 0.5 should be substituted in the formulæ for the ratio of the internal and external pressures  $p_2/p_1$ .

It is easily deduced from Weisbach's theory that, if the pressure external to an orifice is gradually diminished, the weight of air discharged per second increases to a maximum for a value of the ratio

$$p_2/p_1 = [2/(\gamma+1)]^{\gamma/\gamma-1} \\ = 0.527 \text{ for air} \\ = 0.58 \text{ for dry steam.}$$

For a further decrease of external pressure the discharge diminishes,—a result no doubt improbable. The new view of Weisbach's formula is that from the point where the maximum is reached, or not greatly differing from it, the pressure at the contracted section ceases to diminish.

A. F. Fiegener showed (*Civilingenieur* xx., 1874) that for air flowing from well-rounded mouthpieces there is no discontinuity of the law of flow, as Napier's hypothesis implies, but the curve of flow bends so sharply that Napier's rule may be taken to be a good approximation to the true law. The limiting value of the ratio  $p_2/p_1$ , for which Weisbach's formula, as originally understood, ceases to apply, is for air 0.5767; and this is the number to be substituted for  $p_2/p_1$  in the formulæ when  $p_2/p_1$  falls below that value. For later researches on the flow of air, reference may be made to G. A. Zeuner's paper (*Civilingenieur*, 1871), and Fiegener's papers (*ibid.*, 1877, 1878).

VII. FRICTION OF LIQUIDS.

§ 65. When a stream of fluid flows over a solid surface, or conversely when a stream moves in still fluid, a resistance to the motion is generated, commonly termed fluid friction. It is due to the viscosity of the fluid, but generally the laws of fluid friction are very different from those of simple viscous resistance. It would appear that at all speeds, except the slowest, rotating eddies are formed by the roughness of the solid surface, or by abrupt changes of velocity distributed throughout the fluid, and the energy expended in producing these eddying motions is gradually lost in overcoming the viscosity of the fluid in regions more or less distant from that where they are first produced.

The laws of fluid friction are generally stated thus:—

1. The frictional resistance is independent of the pressure between the fluid and the solid against which it flows. This may be verified by a simple direct experiment. C. H. Coulomb, for instance, oscillated a disk under water, first with atmospheric pressure acting on the water surface, afterwards with the atmospheric pressure removed. No difference in the rate of decrease of the oscillations was observed. The chief proof that the friction is independent of the pressure is that no difference of resistance has been observed in water mains and in other cases, where water flows over solid surfaces under widely different pressures.
2. The frictional resistance of large surfaces is proportional to the area of the surface.
3. At low velocities of not more than 1 in. per second for water, the frictional resistance increases directly as the relative velocity of the fluid and the surface against which it flows. At velocities of  $\frac{1}{2}$  ft. per second and greater velocities, the frictional resistance is more nearly proportional to the square of the relative velocity.

In many treatises on hydraulics it is stated that the frictional resistance is independent of the nature of the solid surface. The explanation of this was supposed to be that a film of fluid remained attached to the solid surface, the resistance being generated between this fluid layer and layers more distant from the surface. At extremely low velocities the solid surface does not seem to have much influence on the friction. In Coulomb's experiments a metal surface covered with tallow, and oscillated in water, had exactly the same resistance as a clean metal surface, and when sand was scattered over the tallow the resistance was only very slightly increased. The earlier calculations of the resistance of water at higher velocities in iron and wood pipes and earthen channels seemed to give a similar result. These, however, were erroneous, and it is now well understood that differences of roughness of the solid surface very greatly influence the friction, at such velocities as are common in engineering practice. H. P. C. Darcy's experiments, for instance, showed that in old and incrustated water mains the resistance was twice or sometimes thrice as great as in new and clean mains.

§ 66. *Ordinary Expressions for Fluid Friction at Velocities not Extremely Small.*—Let  $f$  be the frictional resistance estimated in pounds per square foot of surface at a velocity of 1 ft. per second;  $\omega$  the area of the surface in square feet; and  $v$  its velocity in feet per second relatively to the water in which it is immersed. Then, in accordance with the laws stated above, the total resistance of the surface is

$$R = f\omega v^2 \quad (1)$$

where  $f$  is a quantity approximately constant for any given surface. If

$$\xi = 2g/f/G, \\ R = \xi G \omega v^2 / 2g, \quad (2)$$

where  $\xi$  is, like  $f$ , nearly constant for a given surface, and is termed the coefficient of friction.

The following are average values of the coefficient of friction for water, obtained from experiments on large plane surfaces, moved in an indefinitely large mass of water.

	Coefficient of Friction, $\xi$	Frictional Resistance in lb per sq. ft. $f$
New well-painted iron plate	-00489	-00473
Painted and planed plank (Beaufoy)	-00350	-00339
Surface of iron ships (Rankine)	-00362	-00351
Varnished surface (Froude)	-00258	-00250
Fine sand surface	-00418	-00405
Coarser sand surface	-00503	-00488

The distance through which the frictional resistance is overcome is  $r$  ft. per second. The work expended in fluid friction is therefore given by the equation—

$$\text{Work expended} = f w^2 \text{ foot-pounds per second} \quad (3)$$

$$= \xi G w^3 / 2g$$

The coefficient of friction and the friction per square foot of surface can be indirectly obtained from observations of the discharge of pipes and canals. In obtaining them, however, some assumptions as to the motion of the water must be made, and it will be better therefore to discuss these values in connexion with the cases to which they are related.

Many attempts have been made to express the coefficient of friction in a form applicable to low as well as high velocities. The older hydraulic writers considered the resistance termed fluid friction to be made up of two parts,—a part due directly to the distortion of the mass of water and proportional to the velocity of the water relatively to the solid surface, and another part due to kinetic energy imparted to the water striking the roughnesses of the solid surface and proportional to the square of the velocity. Hence they proposed to take

$$\xi = \alpha + \beta v$$

in which expression the second term is of greatest importance at very low velocities, and of comparatively little importance at velocities over about  $\frac{1}{2}$  ft. per second. Values of  $\xi$  expressed in this and similar forms will be given in connexion with pipes and canals.

All these expressions must at present be regarded as merely empirical expressions serving practical purposes.

The frictional resistance will be seen to vary through wider limits than these expressions allow, and to depend on circumstances of which they do not take account.

§ 67. *Coulomb's Experiments.*—The first direct experiments on fluid friction were made by Coulomb, who employed a circular disk suspended by a thin brass wire and oscillated in its own plane. His experiments were chiefly made at very low velocities. When the disk is rotated to any given angle, it oscillates under the action of its inertia and the torsion of the wire. The oscillations diminish gradually in consequence of the work done in overcoming the friction of the disk. The diminution furnishes a means of determining the friction.

Fig. 78 shows Coulomb's apparatus. LK supports the wire and disk;  $ag$  is the brass wire, the torsion of which causes the oscillations; DS is a graduated disk serving to measure the angles through which the apparatus oscillates. To this the friction disk is rigidly attached hanging in a vessel of water. The friction disks were from 4.7 to 7.7 in. diameter, and they generally made one oscillation in from 20 to 30 seconds, through angles varying from  $360^\circ$  to  $6^\circ$ . When the velocity of the circumference of the disk was less than 6 in. per second, the resistance was sensibly proportional to the velocity.

Fig. 78.

*Beaufoy's Experiments.*—Towards the end of the 18th century Colonel Mark Beaufoy (1764-1827) made an immense mass of experiments on the resistance of bodies moved through water (*Nautical and Hydraulic Experiments*, London, 1831). Of these the only ones directly bearing on surface friction were some made in 1796 and 1798. Smooth painted planks were drawn through water and

the resistance measured. For two planks differing in area by 46 sq. ft., at a velocity of 10 ft. per second, the difference of resistance, measured on the difference of area, was 0.339 lb per square foot. Also the resistance varied as the 1.949th power of the velocity.

§ 68. *Froude's Experiments.*—The most important direct experiments on fluid friction at ordinary velocities are those made by William Froude (1810-1879) at Torquay. The method adopted in these experiments was to tow a board in a still water canal, the velocity and the resistance being registered by very ingenious recording arrangements. The general arrangement of the apparatus is shown in fig. 79. AA is the board the resistance of which is to be determined. B is a cut-water giving a fine entrance to the plane surfaces of the board. CC is a bar to which the board AA is attached, and which is suspended by a parallel motion from a carriage running on rails above the still water canal. G is a link by which the resistance of the board is transmitted to a spiral spring H. A bar I rigidly connects the other end of the spring to the carriage. The dotted lines K, L indicate the position of a couple of levers by which the extension of the spring is caused to move a pen M, which records the extension on a greatly increased scale, by a line drawn on the paper cylinder N. This cylinder revolves at a speed proportionate to that of the carriage, its motion being obtained from the axle of the carriage wheels. A second pen O, receiving jerks at every second and a quarter from a clock P, records time on the paper cylinder. The scale for the line of resistance is ascertained by stretching the spiral spring by known weights. The boards used for the experiment

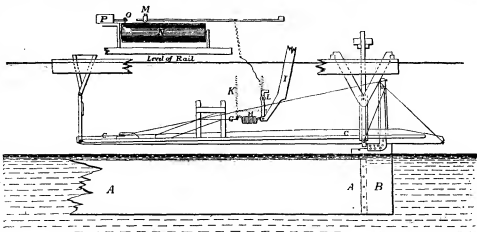

Fig. 79.

were  $\frac{3}{8}$  in. thick, 19 in. deep, and from 1 to 50 ft. in length, cutwater included. A lead keel counteracted the buoyancy of the board. The boards were covered with various substances, such as paint, varnish, Hay's composition, tinfoil, &c., so as to try the effect of different degrees of roughness of surface. The results obtained by Froude may be summarized as follows:—

1. The friction per square foot of surface varies very greatly for different surfaces, being generally greater as the sensible roughness of the surface is greater. Thus, when the surface of the board was covered as mentioned below, the resistance for boards 50 ft. long, at 10 ft. per second, was—

Tinfoil or varnish	0.25 lb per sq. ft.
Calico	0.47 " "
Fine sand	0.405 " "
Coarser sand	0.488 " "

2. The power of the velocity to which the friction is proportional varies for different surfaces. Thus, with short boards 2 ft. long,

For tinfoil the resistance varied as  $v^{2.16}$ .

For other surfaces the resistance varied as  $v^{2.00}$ .

With boards 50 ft. long,

For varnish or tinfoil the resistance varied as  $v^{2.83}$ .

For sand the resistance varied as  $v^{2.07}$ .

3. The average resistance per square foot of surface was much greater for short than for long boards; or, what is the same thing, the resistance per square foot at the forward part of the board was greater than the friction per square foot of portions more starward. Thus,

		Mean Resistance in lb per sq. ft.
Varnished surface	2 ft. long	0.41
	50 "	0.25
Fine sand surface	2 "	0.81
	50 "	0.495

This remarkable result is explained thus by Froude: "The portion of surface that goes first in the line of motion, in experiencing resistance from the water, must in turn communicate motion to the water, in the direction in which it is itself travelling. Consequently

the portion of surface which succeeds the first will be rubbing, not against stationary water, but against water partially moving in its own direction, and cannot therefore experience so much resistance from it."

§ 69. The following table gives a general statement of Froude's results. In all the experiments in this table, the boards had a fine cutwater and a fine stern end or run, so that the resistance was entirely due to the surface. The table gives the resistances per square foot in pounds, at the standard speed of 600 feet per minute, and the power of the speed to which the friction is proportional, so that the resistance at other speeds is easily calculated.

	Length of Surface, or Distance from Cutwater, in feet.											
	2 ft.			8 ft.			20 ft.			50 ft.		
	A	B	C	A	B	C	A	B	C	A	B	C
Varnish	2.00	.41	.390	1.85	.325	.264	1.85	.278	.240	1.83	.250	.226
Paraffin	..	.38	.370	1.94	.314	.260	1.93	.271	.237	..	..	..
Tinfol	..	2.10	.30	.295	1.99	.278	.263	1.90	.262	1.83	.246	.232
Calico	1.93	.87	.725	1.92	.626	.504	1.89	.531	.447	1.87	.474	.423
Fine sand	2.00	.77	.760	2.00	.583	.481	2.00	.480	.384	2.00	.405	.337
Medium sand	2.00	.90	.730	2.00	.625	.488	2.00	.534	.464	2.00	.488	.456
Coarse sand	2.00	1.10	.880	2.00	.714	.520	2.00	.588	.490	..	..	..

Columns A give the power of the speed to which the resistance is approximately proportional.

Columns B give the mean resistance per square foot of the whole surface of a board of the lengths stated in the table.

Columns C give the resistance in pounds of a square foot of surface at the distance sternward from the cutwater stated in the heading.

Although these experiments do not directly deal with surfaces of greater length than 50 ft., they indicate what would be the resistances of longer surfaces. For at 50 ft. the decrease of resistance for an increase of length is so small that it will make no very great difference in the estimate of the friction whether we suppose it to continue to diminish at the same rate or not to diminish at all. For a varnished surface the friction at 10 ft. per second diminishes from 0.41 to 0.32 lb per square foot when the length is increased from 2 to 8 ft., but it only diminishes from 0.278 to 0.250 lb per square foot for an increase from 20 ft. to 50 ft.

If the decrease of friction sternwards is due to the generation of a current accompanying the moving plane, there is not at first any reason why the decrease should not be greater than that shown by the experiments. The current accompanying the board might be assumed to gain in volume and velocity sternwards, till the velocity was nearly the same as that of the moving plane and the friction per square foot nearly zero. That this does not happen appears to be due to the mixing up of the current with the still water surrounding it. Part of the water in contact with the board at any point, and receiving energy of motion from it, passes afterwards to distant regions of still water, and portions of still water are fed in towards the board to take its place. In the forward part of the board more kinetic energy is given to the current than is diffused into surrounding space, and the current gains in velocity. At a greater distance back there is an approximate balance between the energy communicated to the water and that diffused. The velocity of the current accompanying the board becomes constant or nearly constant, and the friction per square foot is therefore nearly constant also.

§ 70. *Friction of Rotating Disks.*—A rotating disk is virtually a surface of unlimited extent and it is convenient for experiments on friction with different surfaces at different speeds. Experiments carried out by Professor W. C. Unwin (*Proc. Inst. Civ. Eng.* lxxx.) are useful both as illustrating the laws of fluid friction and as giving data for calculating the resistance of the disks of turbines and centrifugal pumps. Disks of 10, 15 and 20 in. diameter fixed on a vertical shaft were rotated by a belt driven by an engine. They were enclosed in a cistern of water between parallel top and bottom fixed surfaces. The cistern was suspended by three fine wires. The friction of the disk is equal to the tendency of the cistern to rotate, and this was measured by balancing the cistern by a fine silk cord passing over a pulley and carrying a scale pan in which weights could be placed.

If  $\omega$  is an element of area on the disk moving with the velocity  $v$ , the friction on this element is  $f\omega v^n$ , where  $f$  and  $n$  are constant for any given kind of surface. Let  $r$  be the angular velocity of rotation,  $R$  the radius of the disk. Consider a ring of the surface between  $r$  and  $r+dr$ . Its area is  $2\pi r dr$ , its velocity  $\omega r$  and the friction of this ring is  $f2\pi r dr \omega^n r^n$ . The moment of the friction about the axis of rotation is  $2\pi r \omega^n r^{n+2} dr$ , and the total moment of friction for the two sides of the disk is

$$M = 4\pi \omega^n \int_0^R r^{n+2} dr = [4\pi \omega^n / (n+3)] R^{n+3}$$

If  $N$  is the number of revolutions per sec.,

$$M = [2\pi^{n+2} \omega^{n+1} N^{n+1} / (n+3)] / R^{n+3}$$

and the work expended in rotating the disk is

$$M\omega = [2\pi^{n+2} R^{n+2} N^{n+1} / (n+3)] / R^{n+3} \text{ foot lb per sec.}$$

The experiments give directly the values of  $M$  for the disks corre-

sponding to any speed  $N$ . From these the values of  $f$  and  $n$  can be deduced,  $f$  being the friction per square foot at unit velocity. For comparison with Froude's results it is convenient to calculate the resistance at 10 ft. per second, which is  $F = f/10^n$ .

The disks were rotated in chambers 22 in. diameter and 3, 6 and 12 in. deep. In all cases the friction of the disks increased a little as the chamber was made larger. This is probably due to the stilling of the eddies against the surface of the chamber and the leading back of the stiller water to the disk. Hence the friction depends not only on the surface of the disk but to some extent on the surface of the chamber in which it rotates. If the surface of the chamber is made rougher by covering with coarse sand there is also an increase of resistance.

For the smoother surfaces the friction varied as the 1.85th power of the velocity. For the rougher surfaces the power of the velocity to which the resistance was proportional varied from 1.9 to 2.1. This is in agreement with Froude's results.

Experiments with a bright brass disk showed that the friction decreased with increase of temperature. The diminution between 41° and 130° F. amounted to 18%. In the general equation  $M = c_1 N^n$  for any given disk,

$$c_1 = 0.1328(1 - 0.0021t)$$

where  $c_1$  is the value of  $c$  for a bright brass disk 0.85 ft. in diameter at a temperature  $t$ ° F. The disks used were either polished or made rougher by varnish or by fine sand. The following table gives a comparison of the results obtained with the disks and Froude's results on planks 50 ft. long. The values given are the resistances per square foot at 10 ft. per sec.

Froude's Experiments.	Disk Experiments.
Tinfol surface . . . . . 0.232	Bright brass . . . . . 0.202 to 0.229
Varnish . . . . . 0.226	Varnish . . . . . 0.220 to 0.233
Fine sand . . . . . 0.337	Fine sand . . . . . 0.339
Medium sand . . . . . 0.456	Very coarse sand . . . . . 0.587 to 0.715

#### VIII. STEADY FLOW OF WATER IN PIPES OF UNIFORM SECTION.

§ 71. The ordinary theory of the flow of water in pipes, on which all practical formulae are based, assumes that the variation of velocity at different points in any cross section may be neglected. The water is considered as moving in plane layers, which are driven through the pipe against the frictional resistance, by the difference of pressure at or elevation of the ends of the pipe. If the motion is steady the velocity at each cross section remains the same from moment to moment, and if the cross sectional area is constant the velocity at all sections must be the same. Hence the motion is uniform. The most important resistance to the motion of the water is the surface friction of the pipe, and it is convenient to estimate this independently of some smaller resistances which will be accounted for presently.

In any portion of a uniform pipe, excluding for the present the ends of the pipe, the water enters and leaves at the same velocity.

For that portion therefore the work of the external forces and of the surface friction must be equal. Let fig. 80 represent a very short portion of the pipe, of length  $dl$ , between cross sections at  $z$  and  $z+dz$  ft. above any horizontal datum line  $xx$ , the pressures at the cross sections being  $p$  and  $p+dp$  lb per square foot. Further,

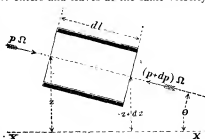

FIG. 80.

let  $Q$  be the volume of flow or discharge of the pipe per second,  $\omega$  the area of a normal cross section, and  $x$  the perimeter of the pipe. The  $Q$  cubic feet, which flow through the space considered per second, weigh  $Q\omega$  lb, and fall through a height  $-dz$  ft. The work done by gravity is then

$$-GQdz;$$

a positive quantity if  $dz$  is negative, and vice versa. The resultant pressure parallel to the axis of the pipe is  $p - (p+dp) = -dp$  lb per square foot of the cross section. The work of this pressure on the volume  $Q$  is

$$-Qdp.$$

The only remaining force doing work on the system is the friction against the surface of the pipe. The area of that surface is  $x dl$ .

The work expended in overcoming the frictional resistance per second is (see § 66, eq. 3)

$$-fGx d\omega^2 / 2g,$$

or, since  $Q = \omega v$ ,

$$-fG(x/\omega) Q(\omega^2 / 2g) dl;$$

the negative sign being taken because the work is done against a resistance. Adding all these portions of work, and equating the result to zero, since the motion is uniform,—

$$-GQdz - Qdp - \int \xi(\chi/\Omega) Q(v^2/2g) dl = 0.$$

Dividing by  $GQ$ ,

$$dz + dp/G + \int \xi(\chi/\Omega)(v^2/2g) dl = 0.$$

Integrating,

$$z + p/G + \int \xi(\chi/\Omega)(v^2/2g) dl = \text{constant.} \quad (1)$$

§ 72. Let A and B (fig. 81) be any two sections of the pipe for which  $p, z, l$  have the values  $p_1, z_1, l_1$ , and  $p_2, z_2, l_2$ , respectively. Then

$$z_1 + p_1/G + \int \xi(\chi/\Omega)(v^2/2g) dl_1 = z_2 + p_2/G + \int \xi(\chi/\Omega)(v^2/2g) dl_2;$$

or, if  $l_1 - l_2 = L$ , rearranging the terms,

$$\int v^2/2g = (1/L) \{ (z_1 + p_1/G) - (z_2 + p_2/G) \} \Omega/\chi. \quad (2)$$

Suppose pressure columns introduced at A and B. The water will rise in those columns to the heights  $p_1/G$  and  $p_2/G$  due to the

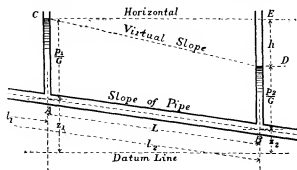

FIG. 81.

pressures  $p_1$  and  $p_2$  at A and B. Hence  $(z_1 + p_1/G) - (z_2 + p_2/G)$  is the quantity represented in the figure by DE, the fall of level of the pressure columns, or *virtual fall* of the pipe. If there were no friction in the pipe, then by Bernoulli's equation there would be no fall of level of the pressure columns, the velocity being the same at A and B. Hence DE or  $h$  is the head lost in friction in the distance AB. The quantity DE/AB =  $h/L$  is termed the *virtual slope* of the pipe or *virtual fall per foot of length*. It is sometimes termed very conveniently the *relative fall*. It will be denoted by the symbol  $\xi$ .

The quantity  $\Omega/\chi$  which appears in many hydraulic equations is called the hydraulic mean radius of the pipe. It will be denoted by  $m$ .

Introducing these values,

$$\int v^2/2g = mh/L = mi. \quad (3)$$

For pipes of circular section, and diameter  $d$ ,

$$m = \Omega/\chi = \frac{1}{4} \pi d^2 / \pi d = \frac{1}{4} d. \quad (4)$$

Then

$$\int v^2/2g = \frac{1}{4} h d/L = \frac{1}{4} i d; \quad (4a)$$

or

$$h = \int \xi(4L/d)(v^2/2g); \quad (4a)$$

which shows that the head lost in friction is proportional to the head due to the velocity, and is found by multiplying that head by the coefficient  $4L/d$ . It is assumed above that the atmospheric pressure at C and D is the same, and this is usually nearly the case. But if C and D are at greatly different levels the excess of barometric pressure at C, in fact of water, must be added to  $p_2/G$ .

§ 73. *Hydraulic Gradient or Line of Virtual Slope.*—Join CD. Since the head lost in friction is proportional to  $L$ , any intermediate pressure column between A and B will have its free surface on the line CD, and the vertical distance between CD and the pipe at any point measures the pressure, exclusive of atmospheric pressure, in the pipe at that point. If the pipe were laid along the line CD instead of AB, the water would flow at the same velocity by gravity without any change of pressure from section to section. Hence CD is termed the *virtual slope* or *hydraulic gradient* of the pipe. It is the line of free surface level for each point of the pipe.

If an ordinary pipe, connecting reservoirs open to the air, rises at any joint above the line of virtual slope, the pressure at that point is less than the atmospheric pressure transmitted through the pipe. At such a point there is a liability that air may be disengaged from the water, and the flow stopped or impeded by the accumulation of air. If the pipe rises more than 34 ft. above the line of virtual slope, the pressure is negative. But as this is impossible, the continuity of the flow will be broken.

If the pipe is not straight, the line of virtual slope becomes a curved line, but since in actual pipes the vertical alterations of level are generally small, compared with the length of the pipe, distances measured along the pipe are sensibly proportional to distances

measured along the horizontal projection of the pipe. Hence the line of hydraulic gradient may be taken to be a straight line without error of practical importance.

§ 74. *Case of a Uniform Pipe connecting two Reservoirs, when all the Resistances are taken into account.*—Let  $h$  (fig. 82) be the difference of level of the reservoirs, and  $v$  the velocity, in a pipe of length  $L$  and diameter  $d$ . The whole work done per second is virtually the removal of  $Q$  cub. ft. of water from the surface of the upper reservoir to the surface of the lower reservoir, that is  $GQh$  foot-pounds. This is expended in three ways. (1) The head  $v^2/2g$ , corresponding to an expenditure of  $GQv^2/2g$  foot-pounds of work, is employed in giving energy of motion to the water. This isulti-

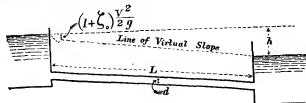

FIG. 82.

mately wasted in eddying motions in the lower reservoir. (2) A portion of head, which experience shows may be expressed in the form  $\xi_0 v^2/2g$ , corresponding to an expenditure of  $GQ\xi_0 v^2/2g$  foot-pounds of work, is employed in overcoming the resistance at the entrance to the pipe. (3) As already shown the head expended in overcoming the surface friction of the pipe is  $\int \xi(4L/d)(v^2/2g)$  corresponding to  $GQ\xi(4L/d)(v^2/2g)$  foot-pounds of work. Hence

$$\begin{aligned} GQh &= GQv^2/2g + GQ\xi_0 v^2/2g + GQ\xi \cdot 4L/d \cdot v^2/2g; \\ h &= (1 + \xi_0 + \xi \cdot 4L/d) v^2/2g, \\ v &= 8 \cdot 025 \sqrt{hd / \{ (1 + \xi_0) d + 4\xi L \}}. \end{aligned} \quad (5)$$

If the pipe is bellmouthed,  $\xi_0$  is about  $\cdot 08$ . If the entrance to the pipe is cylindrical,  $\xi_0 = 0 \cdot 505$ . Hence  $1 + \xi_0 = 1 \cdot 08$  to  $1 \cdot 505$ . In general this is so small compared with  $\xi \cdot 4L/d$ , that, for practical calculations, it may be neglected; that is, the losses of head other than the loss in surface friction are left out of the reckoning. It is only in short pipes and at high velocities that it is necessary to take account of the first two terms in the bracket, as well as the third. For instance, in pipes for the supply of turbines,  $v$  is usually limited to 2 ft. per second, and the pipe is bellmouthed. Then  $1 \cdot 08 v^2/2g = 0 \cdot 067$  ft. In pipes for towns' supply  $v$  may range from 2 to 4½ ft. per second, and then  $1 \cdot 5 v^2/2g = 0 \cdot 1$  to  $0 \cdot 5$  ft. In either case this amount of head is small compared with the whole virtual fall in the cases which most commonly occur.

When  $d$  and  $v$  or  $d$  and  $h$  are given, the equations above are solved quite simply. When  $v$  and  $h$  are given and  $d$  is required, it is better to proceed by approximation. Find an approximate value of  $d$  by assuming a probable value for  $\xi$  as mentioned below. Then from that value of  $d$  find a corrected value for  $\xi$  and repeat the calculation.

The equation above may be put in the form

$$h = (4\xi^2/d) \{ (1 + \xi_0) d + 4\xi L \} + L v^2/2g; \quad (6)$$

from which it is clear that the head expended at the mouthpiece is equivalent to that of a length

$$(1 + \xi_0) d / 4\xi$$

of the pipe. Putting  $1 + \xi_0 = 1 \cdot 505$  and  $\xi = 0 \cdot 01$ , the length of pipe equivalent to the mouthpiece is 37·6  $d$  nearly. This may be added to the actual length of the pipe to allow for mouthpiece resistance in approximate calculations.

§ 75. *Coefficient of Friction for Pipes discharging Water.*—From the average of a large number of experiments, the value of  $\xi$  for ordinary iron pipes is

$$\xi = 0 \cdot 007567. \quad (7)$$

But practical experience shows that no single value can be taken applicable to very different cases. The earlier hydraulicians occupied themselves chiefly with the dependence of  $\xi$  on the velocity. Having regard to the difference of the law of resistance at very low and at ordinary velocities, they assumed that  $\xi$  might be expressed in the form

$$\xi = a + \beta/v.$$

The following are the best numerical values obtained for  $\xi$  so expressed:—

	$a$	$\beta$
R. de Prony (from 51 experiments)	0·006836	0·001116
J. F. d'Aubuisson de Voisins	0·00673	0·001211
J. A. Eytelwein	0·005493	0·00143

Weisbach proposed the formula

$$4\xi = a + \beta/\sqrt{v} = 0 \cdot 003598 + 0 \cdot 004289/\sqrt{v}. \quad (8)$$



§ 76. *Darcy's Experiments on Friction in Pipes.*—All previous experiments on the resistance of pipes were superseded by the remarkable researches carried out by H. P. G. Darcy (1803-1858), the Inspector-General of the Paris water works. His experiments were carried out on a scale, under a variation of conditions, and with a degree of accuracy which leaves little to be desired, and the results obtained are of very great practical importance. These results may be stated thus:—

1. For new and clean pipes the friction varies considerably with the nature and polish of the surface of the pipe. For clean cast iron it is about 1½ times as great as for cast iron covered with pitch. 2. The nature of the surface has less influence when the pipes are old and incrustated with deposits, due to the action of the water. Thus old and incrustated pipes give twice as great a frictional resistance as new and clean pipes. Darcy's coefficients were chiefly determined from experiments on new pipes. He doubles these coefficients for old and incrustated pipes, in accordance with the results of a very limited number of experiments on pipes containing incrustations and deposits.

3. The coefficient of friction may be expressed in the form  $\zeta = \alpha + \beta/d$ ; but in pipes which have been some time in use it is sufficiently accurate to take  $\zeta = \alpha_1$  simply, where  $\alpha_1$  depends on the diameter of the pipe alone, but  $\alpha$  and  $\beta$  on the other hand depend both on the diameter of the pipe and the nature of its surface. The following are the values of the constants.

For pipes which have been some time in use, neglecting the term depending on the velocity;

$$\zeta = \alpha(1 + \beta/d). \tag{9}$$

	$\alpha$	$\beta$
For drawn wrought-iron or smooth cast-iron pipes . . . . .	·004973	·084
For pipes altered by light incrustations . . . . .	·00996	·084

These coefficients may be put in the following very simple form, without sensibly altering their value:—

$$\left. \begin{aligned} \text{For clean pipes . . . . .} & \zeta = \cdot005(1 + 1/12d) \\ \text{For slightly incrustated pipes . . . . .} & \zeta = \cdot01(1 + 1/12d) \end{aligned} \right\} \tag{9a}$$

*Darcy's Value of the Coefficient of Friction  $\zeta$  for Velocities not less than 4 in. per second.*

Diameter of Pipe in Inches.	$\zeta$		Diameter of Pipe in Inches.	$\zeta$	
	New Pipes.	Incrusted Pipes.		New Pipes.	Incrusted Pipes.
2	0·00750	0·01500	18	·00528	·01056
3	·00667	·01333	21	·00524	·01048
4	·00625	·01250	24	·00521	·01042
5	·00600	·01200	27	·00519	·01037
6	·00583	·01167	30	·00517	·01033
7	·00571	·01143	36	·00514	·01028
8	·00563	·01128	42	·00512	·01024
9	·00556	·01111	48	·00510	·01021
12	·00542	·01083	54	·00509	·01019
15	·00533	·01067			

These values of  $\zeta$  are, however, not exact for widely differing velocities. To embrace all cases Darcy proposed the expression

$$\zeta = (\alpha + \alpha_1/d) + (\beta + \beta_1/d^2)/v; \tag{10}$$

which is a modification of Coulomb's, including terms expressing the influence of the diameter and of the velocity. For clean pipes Darcy found these values

$$\begin{aligned} \alpha &= \cdot004346 \\ \alpha_1 &= \cdot0003992 \\ \beta &= \cdot0010182 \\ \beta_1 &= \cdot000005205. \end{aligned}$$

It has become not uncommon to calculate the discharge of pipes by the formula of E. Gauguillet and W. R. Kutter, which will be discussed under the head of channels. For the value of  $c$  in the relation  $v = c\sqrt{mi}$ , Gauguillet and Kutter take

$$c = \frac{41.6 + 1.811(n + \cdot00281/i)}{1 + \sqrt{(41.6 + \cdot00281/i)(n/\sqrt{m})}}$$

where  $n$  is a coefficient depending only on the roughness of the pipe. For pipes uncoated as ordinarily laid  $n = 0.013$ . The formula is very cumbersome, its form is not rationally justifiable and it is not at all clear that it gives more accurate values of the discharge than simpler formulae.

§ 77. *Later Investigations on Flow in Pipes.*—The foregoing statement gives the theory of flow in pipes so far as it can be put in a simple rational form. But the conditions of flow are really more complicated than can be expressed in any rational form. Taking

even selected experiments the values of the empirical coefficient  $\zeta$  range from 0.16 to 0.0028 in different cases. Hence means of discriminating the probable value of  $\zeta$  are necessary in using the equations for practical purposes. To a certain extent the knowledge that  $\zeta$  decreases with the size of the pipe and increases very much with the roughness of its surface is a guide, and Darcy's method of dealing with these causes of variation is very helpful. But a further difficulty arises from the discordance of the results of different experiments. For instance F. P. Stearns and J. M. Gale both experimented on clean asphalted cast-iron pipes, 4 ft. in diameter. According to one set of gaugings  $\zeta = \cdot0051$ , and according to the other  $\zeta = \cdot0041$ . It is impossible in such cases not to suspect some error in the observations or some difference in the condition of the pipes not noticed by the observers.

It is not likely that any formula can be found which will give exactly the discharge of any given pipe. For one of the chief factors in any such formula must express the exact roughness of the pipe surface, and there is no scientific measure of roughness. The most that can be done is to limit the choice of the coefficient for a pipe within certain comparatively narrow limits. The experiments on fluid friction show that the power of the velocity to which the resistance is proportional is not exactly the square. Also in determining the form of his equation for  $\zeta$  Darcy used only eight out of his seventeen series of experiments, and there is reason to think that some of these were exceptional. Barré de Saint-Venant was the first to propose a formula with two constants,

$$dh/dl = mV^n,$$

where  $m$  and  $n$  are experimental constants. If this is written in the form

$$\log m + n \log v = \log (dh/dl),$$

we have, as Saint-Venant pointed out, the equation to a straight line, of which  $m$  is the ordinate at the origin and  $n$  the ratio of the slope. If a series of experimental values are plotted logarithmically the determination of the constants is reduced to finding the straight line which most nearly passes through the plotted points. Saint-Venant found for  $n$  the value of 1.71. In a memoir on the influence of temperature on the movement of water in pipes (Berlin, 1854) by G. H. L. Hagen (1797-1884) another modification of the Saint-Venant formula was given. This is  $h/l = mv^n/d^5$ , which involves three experimental coefficients. Hagen found  $n = 1.75$ ;  $x = 1.25$ ; and  $m$  was then nearly independent of variations of  $v$  and  $d$ . But the range of cases examined was small. In a remarkable paper in the *Trans. Roy. Soc.*, 1883, Professor Osborne Reynolds made much clearer the change from regular stream line motion at low velocities to the eddying motion, which occurs in almost all the cases with which the engineer has to deal. Partly by reasoning, partly by induction from the form of logarithmically plotted curves of experimental results, he arrived at the general equation  $h/l = c(v^n/d^{5-n})P^{m-n}$ , where  $n = 1$  for low velocities and  $n = 1.7$  to 2 for ordinary velocities. It is a function of the temperature. Neglecting variations of temperature Reynolds's formula is identical with Hagen's if  $x = 3/n$ . For practical purposes Hagen's form is the more convenient.

*Values of Index of Velocity.*

Surface of Pipe.	Authority.	Diameter of Pipe in Metres.	Values of $n$ .
Tin plate	Bossut . . . . .	·036	1.697
		·054	1.730
Wrought iron (gas pipe)	Hamilton Smith	·0159	1.756
		·0267	1.770
Lead . . . . .	Darcy . . . . .	·014	1.866
		·027	1.755
Clean brass	Mair . . . . .	·041	1.760
		·036	1.795
Asphalted	Hamilton Smith	·0266	1.760
		·4185	1.850
Stearns	W. W. Bonn	·306	1.880
		1.219	1.880
Riveted wrought iron	Hamilton Smith	·2776	1.804
		·3219	1.892
Wrought iron (gas pipe)	Darcy . . . . .	·3749	1.852
		·0122	1.900
New cast iron	Darcy . . . . .	·0266	1.899
		·0395	1.838
Cleaned cast iron	Darcy . . . . .	·0819	1.950
		·137	1.923
Incrusted cast iron	Darcy . . . . .	·188	1.957
		·50	1.950
Incrustated cast iron	Darcy . . . . .	·0364	1.835
		·0801	2.000
Cleaned cast iron	Darcy . . . . .	·247	2.000
		·397	2.07
Incrusted cast iron	Darcy . . . . .	·0359	1.980
		·0795	1.990
		·2432	1.990

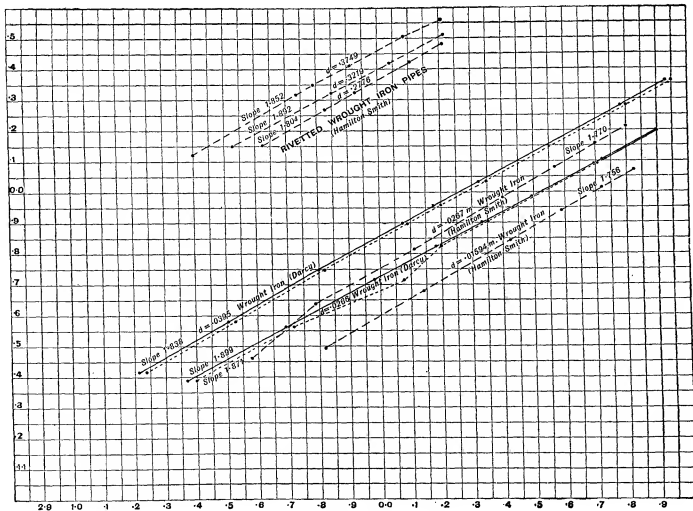

FIG. 83.

In 1886, Professor W. C. Unwin plotted logarithmically all the most trustworthy experiments on flow in pipes then available.<sup>1</sup> Fig. 83 gives one such plotting. The results of measuring the slopes of the lines drawn through the plotted points are given in the table.

It will be seen that the values of the index  $n$  range from 1.72 for the smoothest and cleanest surface, to 2.00 for the roughest. The numbers after the brackets are rounded off numbers.

The value of  $n$  having been thus determined, values of  $m/d^2$  were next found and averaged for each pipe. These were again plotted logarithmically in order to find a value for  $x$ . The lines were not very regular, but in all cases the slope was greater than 1 to 1, so that the value of  $x$  must be greater than unity. The following table gives the results and a comparison of the value of  $x$  and Reynolds's value  $3-n$ .

Kind of Pipe.	$n$	$3-n$	$x$
Tin plate	1.72	1.28	1.100
Wrought iron (Smith)	1.75	1.25	1.210
Asphalted pipes	1.85	1.15	1.127
Wrought iron (Darcy)	1.87	1.13	1.680
Rivetted wrought iron	1.87	1.13	1.390
New cast iron	1.95	1.05	1.168
Cleaned cast iron	2.00	1.00	1.168
Incruated cast iron	2.00	1.00	1.160

With the exception of the anomalous values for Darcy's wrought-iron pipes, there is no great discrepancy between the values of  $x$  and  $3-n$ , but there is no appearance of relation in the two quantities. For the present it appears preferable to assume that  $x$  is independent of  $n$ .

It is now possible to obtain values of the third constant  $m$ , using the values found for  $n$  and  $x$ . The following table gives the results, the values of  $m$  being for metric measures.

Here, considering the great range of diameters and velocities in the experiments, the constancy of  $m$  is very satisfactorily close. The asphalted pipes give rather variable values. But, as some of these were new and some old, the variation is, perhaps, not surprising. The incruated pipes give a value of  $m$  quite double that for new pipes but that is perfectly consistent with what is known of fluid friction in other cases.

Kind of Pipe.	Diameter in Metres.	Value of $m$ .	Mean Value of $m$ .	Authority.
Tin plate	0.036	0.01607	0.01686	Bossut
	0.054	0.01676		
Wrought iron	0.016	0.01302	0.01310	Hamilton Smith
	0.027	0.01319		
	0.027	0.01749		
	0.306	0.02058		
Asphalted pipes	0.306	0.02107	0.01831	Hamilton Smith W. W. Bonn W. W. Bonn Lampe Sicarns Gale
	0.419	0.01650		
	1.219	0.01317		
	1.219	0.02107		
	0.278	0.01370		
Rivetted wrought iron	0.322	0.01440	0.01403	Hamilton Smith
	0.375	0.01390		
	0.432	0.01368		
	0.657	0.01448		
	0.082	0.01725		
New cast iron	0.137	0.01427	0.01658	Darcy
	0.188	0.01734		
	0.500	0.01745		
	0.500	0.01979		
Cleaned cast iron	0.245	0.02091	0.01994	Darcy
	0.297	0.01913		
	0.036	0.03693		
Incruated cast iron	0.080	0.03539	0.03643	Darcy
	0.243	0.03706		

<sup>1</sup> "Formulae for the Flow of Water in Pipes," *Industries* (Manchester, 1886).

## General Mean Values of Constants.

The general formula (Hagen's)  $h/l = mv^3/d^5 \cdot 2g$  can therefore be taken to fit the results with convenient closeness, if the following mean values of the coefficients are taken, the unit being a metre:—

Kind of Pipe.	<i>m</i>	<i>x</i>	<i>n</i>
Tin plate	0.169	1.10	1.72
Wrought iron	0.131	1.21	1.75
Asphalted iron	0.183	1.127	1.85
Riveted wrought iron	0.140	1.390	1.87
New cast iron	0.166	1.168	1.95
Cleaned cast iron	0.199	1.168	2.0
Incrusted cast iron	0.264	1.160	2.0

The variation of each of these coefficients is within a comparatively narrow range, and the selection of the proper coefficient for any given case presents no difficulty, if the character of the surface of the pipe is known.

It only remains to give the values of these coefficients when the quantities are expressed in English feet. For English measures the following are the values of the coefficients:—

Kind of Pipe.	<i>m</i>	<i>x</i>	<i>n</i>
Tin plate	0.265	1.10	1.72
Wrought iron	0.226	1.21	1.75
Asphalted iron	0.254	1.127	1.85
Riveted wrought iron	0.200	1.390	1.87
New cast iron	0.215	1.168	1.95
Cleaned cast iron	0.243	1.168	2.0
Incrusted cast iron	0.440	1.160	2.0

§ 78. *Distribution of Velocity in the Cross Section of a Pipe.*—Darcy made experiments with a Pitot tube in 1850 on the velocity at different points in the cross section of a pipe. He deduced the relation

$$V - v = 11.3(r/R)\sqrt{v},$$

where *V* is the velocity at the centre and *v* the velocity at radius *r* in a pipe of radius *R* with a hydraulic gradient *i*. Later Bazin repeated the experiments and extended them (*Mém. de l'Académie des Sciences*, xxxii. No. 6). The most important result was the ratio of mean to central velocity. Let  $b = R/\sqrt{U^2}$ , where *U* is the mean velocity in the pipe; then  $V/U = 1 + 0.93\sqrt{b}$ . A very useful result for practical purposes is that at 0.74 of the radius of the pipe the velocity is equal to the mean velocity. Fig. 84 gives the velocities at different radii as determined by Bazin.

§ 79. *Influence of Temperature on the Flow through Pipes.*—Very careful experiments on the flow through a pipe 0.1236 ft. in diameter

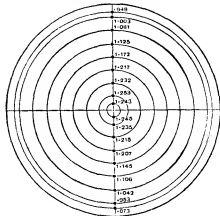
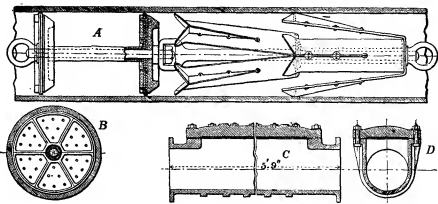

FIG. 84.

FIG. 85. Scale  $\frac{1}{2}$ .

and 25 ft. long, with water at different temperatures, have been made by J. G. Mair (*Proc. Inst. Civ. Eng.* lxxvii.). The loss of head was measured from a point 1 ft. from the inlet, so that the loss at entry was eliminated. The 1½ in. pipe was made smooth inside and to gauge, by drawing a mandril through it. Plotting the results logarithmically, it was found that the resistance for all temperatures varied very exactly as  $v^{1.795}$ , the index being less than 2 as in other experiments with very smooth surfaces. Taking the ordinary equation of flow  $h = (4L/D)(v^2/g)$ , then for heads varying from 1 ft. to nearly 4 ft., and velocities in the pipe varying from 4 ft. to 9 ft. per second, the values of *f* were as follows:—

Temp. F.	<i>f</i>	Temp. F.	<i>f</i>
57	0.044 to 0.052	100	0.039 to 0.042
70	0.041 to 0.045	110	0.037 to 0.041
80	0.041 to 0.045	120	0.037 to 0.041
90	0.040 to 0.045	130	0.035 to 0.039
		160	0.035 to 0.038

This shows a marked decrease of resistance as the temperature rises. If Professor Osborne Reynolds's equation is assumed  $h = mLv^3/d^5 \cdot 2g$ , and *n* is taken 1.795, then values of *m* at each temperature are practically constant:—

Temp. F.	<i>m</i> .	Temp. F.	<i>m</i> .
57	0.000276	100	0.000244
70	0.000263	110	0.000235
80	0.000257	120	0.000229
90	0.000250	130	0.000225
		160	0.000206

where again a regular decrease of the coefficient occurs as the temperature rises. In experiments on the friction of disks at different temperatures Professor W. C. Unwin found that the resistance was proportional to constant  $\times (1 + 0.002t)$  and the values of *m* given above are expressed almost exactly by the relation

$$m = 0.000311(1 + 0.00215t).$$

In tank experiments on ship models for small ordinary variations of temperature, it is usual to allow a decrease of 3% of resistance for 10° F. increase of temperature.

§ 80. *Influence of Deposits in Pipes on the Discharge.* *Scraping Water Mains.*—The influence of the condition of the surface of a pipe on the friction is shown by various facts known to the engineers of waterworks. In pipes which convey certain kinds of water, oxidation proceeds rapidly and the discharge is considerably diminished. A main laid at Torquay in 1858, 14 m. in length, consists of 10-in., 9-in. and 8-in. pipes. It was not protected from corrosion by any coating. But it was found to the surprise of the engineer that in eight years the discharge had diminished to 51% of the original discharge. J. G. Appold suggested an apparatus for scraping the interior of the pipe, and this was constructed and used under the direction of William Froude (see "Incrustation of Iron Pipes," by W. Ingham, *Proc. Inst. Mech. Eng.*, 1899). It was found that by scraping the interior of the pipe the discharge was increased 36%. The scraping requires to be repeated at intervals. After each scraping the discharge diminishes rather rapidly to 10% and afterwards more slowly, the diminution in a year being about 25%.

Fig. 85 shows a scraper for water mains, similar to Appold's but modified in details, as constructed by the Glenfield Company, at Kilmarnock. A is a longitudinal section of the pipe, showing the scraper in place; B is an end view of the plungers, and C, D sections of the boxes placed at intervals on the main for introducing or withdrawing the scraper. The apparatus consists of two plungers, packed with leather so as to fit the main pretty closely. On the spindle of these plungers are fixed eight steel scraping blades, with curved scraping edges fitting the surface of the main. The apparatus is placed in the main by removing the cover from one of the boxes shown at C, D. The cover is then replaced, water pressure is admitted behind the plungers, and the apparatus driven through the

main. At Lancaster after twice scraping the discharge was increased 56½%, at Oswestry 54½%. The increased discharge is due to the diminution of the friction of the pipe by removing the roughnesses due to oxidation. The scraper can be easily followed when the mains are about 3 ft. deep by the noise it makes. The average speed of the scraper at Torquay is 2½ m. per hour. At Torquay 49% of the deposit is iron rust, the rest being silica, lime and organic matter.

In the opinion of some engineers it is inadvisable to use the scraper. The incrustation is only temporarily removed, and if the use of the scraper is continued the life of the pipe is reduced. The only treatment effective in preventing or retarding the incrustation due to corrosion is to coat the pipes when hot with a smooth and perfect layer of pitch. With certain waters such as those derived from the chalk the incrustation is of a different character, consisting of nearly pure calcium carbonate. A deposit of another character which has led to trouble in some mains is a black slime containing a good deal of iron not derived from the pipes. It appears to be an

organic growth. Filtration of the water appears to prevent the growth of the slime, and its temporary removal may be effected by a kind of brush scraper devised by G. F. Deacon (see " Deposits in Pipes," by Professor J. C. Campbell Brown, *Proc. Inst. Civ. Eng.*, 1903-1904).

§ 81. *Flow of Water through Fire Hose.*—The hose pipes used for fire purposes are of very varied character, and the roughness of the surface varies. Very careful experiments have been made by J. R. Freeman (*Am. Soc. Civ. Eng.*, xxi., 1889). It was noted that under pressure the diameter of the hose increased sufficiently to have a marked influence on the discharge. In reducing the results the true diameter has been taken. Let  $v$  = mean velocity in ft. per sec.;  $r$  = hydraulic mean radius or one-fourth the diameter in feet;  $i$  = hydraulic gradient. Then  $v = \sqrt{(ri)}$ .

	Diameter in Inches.	Gallons (United States) per min.	$i$	$v$	$n$
Solid rubber hose	2.65	215	.1863	12.50	123.3
	"	344	.4714	20.00	124.0
Woven cotton, rubber lined	2.47	200	.2464	13.40	119.1
Woven cotton, rubber lined	2.49	200	.2427	13.20	117.7
Knit cotton, rubber lined	2.68	132	.0809	7.50	111.6
Knit cotton, rubber lined	2.69	204	.2357	11.00	100.1
Woven cotton, rubber lined	2.12	154	.3448	14.00	113.4
Woven cotton, rubber lined	2.53	54.8	.0261	3.50	94.3
Unlined linen hose	2.60	57.9	.0414	3.50	73.9
	"	331	1.1624	20.00	79.6

§ 82. *Reduction of a Long Pipe of Varying Diameter to an Equivalent Pipe of Uniform Diameter.* Dupuit's Equation.—Water mains for the supply of towns often consist of a series of lengths, the diameter being the same for each length, but differing from length to length. In approximate calculations of the head lost in such mains, it is generally accurate enough to neglect the smaller losses of head and to have regard to the pipe friction only, and then the calculations may be facilitated by reducing the main to a main of uniform diameter, in which there would be the same loss of head. Such a uniform main will be termed an equivalent main.

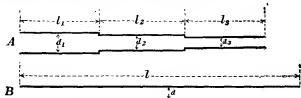

FIG. 86.

In fig. 86 let A be the main of variable diameter, and B the equivalent uniform main. In the given main of variable diameter A, let

$l_1, l_2, \dots$  be the lengths,  
 $d_1, d_2, \dots$  the diameters,  
 $v_1, v_2, \dots$  the velocities,  
 $i_1, i_2, \dots$  the slopes,

for the successive portions, and let  $l, d, v$  and  $i$  be corresponding quantities for the equivalent uniform main B. The total loss of head in A due to friction is

$$h = i_1 l_1 + i_2 l_2 + \dots \\ = \zeta (v_1^2 4l_1 / 2gd_1) + \zeta (v_2^2 4l_2 / 2gd_2) + \dots$$

and in the uniform main

$$i l = \zeta (v^2 4l / 2gd).$$

If the mains are equivalent, as defined above,

$$\zeta (v^2 4l / 2gd) = \zeta (v_1^2 4l_1 / 2gd_1) + \zeta (v_2^2 4l_2 / 2gd_2) + \dots$$

But, since the discharge is the same for all portions,

$$\frac{1}{2} \pi d^2 v = \frac{1}{2} \pi d_1^2 v_1 = \frac{1}{2} \pi d_2^2 v_2 = \dots \\ v_1 = v d^2 / d_1^2; v_2 = v d^2 / d_2^2 \dots$$

Also suppose that  $\zeta$  may be treated as constant for all the pipes. Then

$$l d = (d^4 / d_1^4) (l_1 / d_1) + (d^4 / d_2^4) (l_2 / d_2) + \dots \\ l d = (d^4 / d_1^4) l_1 + (d^4 / d_2^4) l_2 + \dots$$

which gives the length of the equivalent uniform main which would have the same total loss of head for any given discharge.

§ 83. *Other Losses of Head in Pipes.*—Most of the losses of head in pipes, other than that due to surface friction against the pipe, are due to abrupt changes in the velocity of the stream producing eddies. The kinetic energy of these is deducted from the general energy of translation, and practically wasted.

*Sudden Enlargement of Section.*—Suppose a pipe enlarges in section from an area  $\omega_0$  to an area  $\omega_1$  (fig. 87); then

$$v_1 / v_0 = \omega_0 / \omega_1;$$

or, if the section is circular,

$$v_1 / v_0 = (d_0 / d_1)^2.$$

The head lost at the abrupt change of velocity has already been shown to be the head due to the relative velocity of the two parts of the stream. Hence head lost

$$h_s = (v_0 - v_1)^2 / 2g = (\omega_0 / \omega_1 - 1)^2 v_0^2 / 2g = ((d_0 / d_1)^2 - 1)^2 v_0^2 / 2g \\ \text{or } h_s = \zeta v_0^2 / 2g,$$

if  $\zeta$  is put for the expression in brackets.

$\omega_1 / \omega_0 =$	1.1	1.2	1.5	1.7	1.8	1.9	2.0	2.5	3.0	3.5	4.0	4.5	5.0	6.0	7.0	8.0
$d_1 / d_0 =$	1.05	1.10	1.22	1.30	1.34	1.38	1.41	1.58	1.73	1.87	2.00	2.24	2.45	2.65	2.83	
$\zeta =$	.01	.04	.25	.40	.46	.51	.55	1.00	2.25	4.00	6.25	9.00	12.00	25.00	36.00	49.00

*Abrupt Contraction of Section.*—When water passes from a larger to a smaller section, as in figs. 88, 89, a contraction is formed, and the contracted stream abruptly expands to fill the section of the pipe.

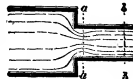

FIG. 88.

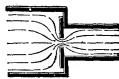

FIG. 89.

Let  $\omega$  be the section and  $v$  the velocity of the stream at  $bb$ . At  $aa$  the section will be  $c_0 \omega$ , and the velocity  $(\omega / c_0 \omega) v = v / c_0$ , where  $c_0$  is the coefficient of contraction. Then the head lost is

$$h_m = (v / c_0 - v)^2 / 2g = (1 / c_0 - 1)^2 v^2 / 2g;$$

and, if  $c_0$  is taken 0.64,

$$h_m = 0.316 v^2 / 2g.$$

The value of the coefficient of contraction for this case is, however, not well ascertained, and the result is somewhat modified by friction. For water entering a cylindrical, not bell-mouthed, pipe from a reservoir of indefinitely large size, experiment gives

$$h_m = 0.505 v^2 / 2g.$$

If there is a diaphragm at the mouth of the pipe as in fig. 89, let  $\omega_1$  be the area of this orifice. Then the area of the contracted stream is  $c_0 \omega_1$ , and the head lost is

$$h_s = ((\omega / c_0 \omega_1) - 1)^2 v^2 / 2g \\ = \zeta v^2 / 2g$$

if  $\zeta$ , is put for  $\{(\omega / c_0 \omega_1) - 1\}^2$ . Weisbach has found experimentally the following values of the coefficient, when the stream approaching the orifice was considerably larger than the orifice:—

$\omega_1 / \omega =$	0.1	0.2	0.3	0.4	0.5	0.6	0.7	0.8	0.9	1.0
$c_0 =$	.616	.614	.612	.610	.607	.603	.601	.598	.596	
$\zeta =$	231.7	50.00	10.78	6.612	5.256	3.077	1.876	1.160	0.734	0.480

When a diaphragm was placed in a tube of uniform section (fig. 90)



FIG. 90.

the following values were obtained,  $\omega_1$  being the area of the orifice and  $\omega$  that of the pipe:—

$\omega_1 / \omega =$	0.1	0.2	0.3	0.4	0.5	0.6	0.7	0.8	0.9	1.0
$c_0 =$	.624	.632	.643	.650	.681	.712	.755	.813	.892	1.00
$\zeta =$	325.9	47.77	30.83	7.801	1.753	1.796	.797	.398	.060	.000

**Elbows.**—Weisbach considers the loss of head at elbows (fig. 91) to be due to a contraction formed by the stream. From experiments with a pipe  $\frac{1}{4}$  in. diameter, he found the loss of head

$$\zeta_e = 0.9457 \sin^2 \phi + 2.047 \sin^4 \frac{1}{2} \phi. \quad (5)$$

$\phi =$	30°	40°	60°	80°	90°	100°	110°	130°	140°
$\zeta_e =$	0.046	0.139	0.364	0.740	0.984	1.366	1.596	1.861	2.158

Hence at a right-angled elbow the whole head due to the velocity very nearly is lost.

**Bends.**—Weisbach traces the loss of head at curved bends to a similar cause to that at elbows, but the coefficients for bends are not very satisfactorily ascertained. Weisbach obtained for the loss of head at a bend in a pipe of circular section

$$\zeta_b = \zeta v^2 / 2g; \quad (6)$$

$$\zeta_b = 0.131 + 1.847 (d/2\rho)^2,$$

where  $d$  is the diameter of the pipe and  $\rho$  the radius of curvature of the bend. The resistance at bends is small and at present very ill determined.

**Valves, Cocks and Sluices.**—These produce a contraction of the water-stream, similar to that for an abrupt diminution of section already discussed. The loss of head may be taken as before to be

$$\zeta_v = \zeta v^2 / 2g; \quad (7)$$

where  $v$  is the velocity in the pipe beyond the valve and  $\zeta_v$  a coefficient determined by experiment. The following are Weisbach's results.

**Sluice in Pipe of Rectangular Section** (fig. 92). Section at sluice =  $\omega_1$  in pipe =  $\omega$ .

$\omega_1/\omega =$	1.0	0.9	0.8	0.7	0.6	0.5	0.4	0.3	0.2	0.1
$\zeta_v =$	0.00	.09	.39	.95	2.08	4.02	8.12	17.8	44.5	193

**Sluice in Cylindrical Pipe** (fig. 93).

Ratio of height of opening to diameter of pipe	1.0	$\frac{3}{4}$	$\frac{1}{2}$	$\frac{1}{3}$	$\frac{1}{4}$	$\frac{1}{5}$	$\frac{1}{6}$	$\frac{1}{7}$	$\frac{1}{8}$	$\frac{1}{9}$
$\omega_1/\omega =$	1.00	0.948	856	.740	.600	.466	.315	.159		
$\zeta_v =$	0.00	0.07	0.26	0.81	3.06	5.53	17.0	97.3		



FIG. 93.

**Cock in a Cylindrical Pipe** (fig. 94). Angle through which cock is turned =  $\theta$ .

$\theta =$	5°	10°	15°	20°	25°	30°	35°
Ratio of cross sections	.926	.850	.772	.692	.613	.535	.458
$\zeta_v =$	.05	.29	.75	1.56	3.10	5.47	9.68

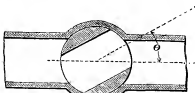

FIG. 94.

$\theta =$	40°	45°	50°	55°	60°	65°	82°
Ratio of cross sections	.385	.315	.250	.190	.137	.091	0
$\zeta_v =$	17.3	31.2	52.6	106	206	486	∞

**Throttle Valve in a Cylindrical Pipe** (fig. 95)

$\theta =$	5°	10°	15°	20°	25°	30°	35°	40°
$\zeta_v =$	.24	.52	.90	1.54	2.51	3.91	6.22	10.8

$\theta =$	45°	50°	55°	60°	65°	70°	90°
$\zeta_v =$	18.7	32.6	58.8	118	256	751	∞

§ 84. **Practical Calculations on the Flow of Water in Pipes.**—In the following explanations it will be assumed that the pipe is of so great a length that only the loss of head in friction against the surface of the pipe needs to be considered. In general it is one of the four quantities  $d$ ,  $v$ ,  $Q$  or  $Q$  which requires to be determined. For simplicity the loss of head  $h$  is given by the relation  $h = \zeta l$ , this need not be separately considered.

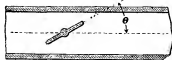

FIG. 95.

There are then three equations (see eq. 4, § 72, and 9a, § 76) for the solution of such problems as arise:—

$$\zeta = \alpha(1 + 1/12d); \quad (1)$$

where  $\alpha = 0.005$  for new and  $\alpha = 0.01$  for incrustated pipes.

$$\zeta v^2 / 2g = \zeta d; \quad (2)$$

$$Q = \frac{1}{2} \pi d^2 v. \quad (3)$$

**Problem 1.** Given the diameter of the pipe and its virtual slope, to find the discharge and velocity of flow. Here  $d$  and  $\alpha$  are given, and  $Q$  and  $v$  are required. Find  $\zeta$  from (1); then  $v$  from (2); lastly  $Q$  from (3). This case presents no difficulty.

By combining equations (1) and (2),  $v$  is obtained directly:—

$$v = \sqrt{g(d/\zeta 2g)} = \sqrt{g(2\alpha) \sqrt{d(1/12 + 1/24d)}}. \quad (4)$$

$$\text{For new pipes } \sqrt{g(2\alpha)} = 56.72$$

$$\text{For incrustated pipes } \sqrt{g(2\alpha)} = 40.13$$

For pipes not less than 1, or more than 4 ft. in diameter, the mean values of  $\zeta$  are

$$\text{For new pipes } \dots \dots \dots 0.00526$$

$$\text{For incrustated pipes } \dots \dots \dots 0.01052$$

Using these values we get the very simple expressions—

$$v = 55.31 \sqrt{d} \quad (\text{for new pipes}) \quad (4a)$$

$$= 39.11 \sqrt{d} \quad (\text{for incrustated pipes}).$$

Within the limits stated, these are accurate enough for practical purposes, especially as the precise value of the coefficient  $\zeta$  cannot be known for each special case.

**Problem 2.** Given the diameter of a pipe and the velocity of flow, to find the virtual slope and discharge. The discharge is given by (3); the proper value of  $\zeta$  by (1); and the virtual slope by (2). This also presents no special difficulty.

**Problem 3.** Given the diameter of the pipe and the discharge, to find the virtual slope and velocity. Find  $v$  from (3);  $\zeta$  from (1); lastly  $l$  from (2). If we combine (1) and (2) we get

$$l = \zeta (v^2 / 2g) \quad (4) \quad d = 2\alpha [1 + 1/12d] v^2 / g; \quad (5)$$

and, taking the mean values of  $\zeta$  for pipes from 1 to 4 ft. diameter, given above, the approximate formulæ are

$$l = 0.0003268 \frac{v^2 d}{g} \quad \text{for new pipes} \quad (5a)$$

$$= 0.0006536 \frac{v^2 d}{g} \quad \text{for incrustated pipes} \quad (5b)$$

**Problem 4.** Given the virtual slope and the velocity, to find the diameter of the pipe and the discharge. The diameter is obtained from equations (2) and (1), which give the quadratic expression

$$d^2 - d(2\alpha v^2 / g) - \alpha v^2 / g = 0. \quad (6)$$

$$\therefore d = \alpha v^2 / g + \sqrt{\{(\alpha v^2 / g)^2 + (\alpha v^2 / g)^2\}}. \quad (6)$$

For practical purposes, the approximate equations

$$d = 2\alpha v^2 / g + 1/12 \quad (6a)$$

$$= 0.00031 \frac{v^2}{g} + 0.83 \quad \text{for new pipes}$$

$$= 0.00062 \frac{v^2}{g} + 0.83 \quad \text{for incrustated pipes}$$

are sufficiently accurate. **Problem 5.** Given the virtual slope and the discharge, to find the diameter of the pipe and velocity of flow. This case, which often occurs in designing, is the one which is least easy of direct solution. From equations (2) and (3) we get—

$$d^3 = 32 \zeta^2 Q^2 / g v^2. \quad (7)$$

If now the value of  $\zeta$  in (1) is introduced, the equation becomes very cumbersome. Various approximate methods of meeting the difficulty may be used.

(a) Taking the mean values of  $\zeta$  given above for pipes of 1 to 4 ft. diameter we get

$$d = \sqrt{\{32 \zeta^2 Q^2 / g v^2\}} \quad (8)$$

$$= 0.2216 \sqrt{Q^2 / v^2} \quad \text{for new pipes}$$

$$= 0.2541 \sqrt{Q^2 / v^2} \quad \text{for incrustated pipes;}$$

equations which are interesting as showing that when the value of  $\zeta$  is doubled the diameter of pipe for a given discharge is only increased by 13%.

(b) A second method is to obtain a rough value of  $d$  by assuming  $\zeta = a$ . This value is

$$d' = \sqrt[5]{(32Q^2/g\pi^2)\sqrt{a} \approx 0.6319 \sqrt[5]{(Q^2/i)\sqrt{a}}$$

Then a very approximate value of  $\zeta$  is

$$\zeta' = a(1 + 1/12d')$$

and a revised value of  $d$ , not sensibly differing from the exact value, is

$$d'' = \sqrt[5]{(32Q^2/g\pi^2)\sqrt{\zeta'} \approx 0.6319 \sqrt[5]{(Q^2/i)\sqrt{\zeta'}}$$

(c) Equation 7 may be put in the form

$$d = \sqrt[5]{(32aQ^2/g\pi^2)\sqrt{(1+1/12d)}} \quad (9)$$

Expanding the term in brackets,

$$\sqrt{(1+1/12d)} = 1 + 1/60d - 1/1800d^2 \dots$$

Neglecting the terms after the second,

$$d = \sqrt[5]{(32a/g\pi^2)\sqrt{(Q^2/i)} \cdot [1 + 1/60d]}$$

$$= \sqrt[5]{(32a/g\pi^2)\sqrt{(Q^2/i)} + 0.01667(9a)}$$

$$\text{and}$$

$$\sqrt[5]{(32a/g\pi^2)} = 0.219 \text{ for new pipes}$$

$$= 0.252 \text{ for incrustated pipes.}$$

§ 85. Arrangement of Water Mains for Towns' Supply.—Town mains are usually supplied by gravitation from a service reservoir, which in turn is supplied by gravitation from a storage reservoir or by pumping from a lower level. The service reservoir should contain three days' supply or in important cases much more. Its elevation should be such that water is delivered at a pressure of at least about 100 ft. to the highest parts of the district. The greatest pressure in the mains is usually about 200 ft., the pressure for which ordinary pipes and fittings are designed. Hence if the district supplied has

reservoir from the same datum. Set up next heights  $AA_1, BB_1, \dots$  representing the minimum pressure height necessary for the adequate supply of each locality. Then  $A_1B_1C_1D_1, \dots$  is a line which should form a lower limit to the line of virtual slope. Then if heights  $h_a, h_b, h_c, \dots$  are taken representing the actual losses of head in each length  $h_1, h_2, h_3, \dots$  of the main,  $A_2B_2C_2, \dots$  will be the line of virtual slope, and it will be obvious at what points such as  $D_2$  and  $E_2$ , the pressure is deficient, and a different choice of diameter of main is required. For any point  $x$  in the length of the main, we have

FIG. 98.

Pressure height =  $H - H_1 - (h_a + h_b + \dots + h_x)$ .

Where no other circumstance limits the loss of head to be assigned to a given length of main, a consideration of the safety of the main from fracture by hydraulic shock leads to a limitation of the velocity of flow. Generally the velocity in water mains lies between  $1\frac{1}{2}$  and  $4\frac{1}{2}$  ft. per second. Occasionally the velocity in pipes reaches 10 ft. per second, and in hydraulic machinery working under enormous pressures even 20 ft. per second. Usually the velocity diminishes along the main as the discharge diminishes, so as to reduce somewhat the total loss of head which is liable to render the pressure insufficient at the end of the main.

J. T. Fanning gives the following velocities as suitable in pipes for towns' supply:—

Diameter in inches	4	8	12	18	24	30	36
Velocity in feet per sec.	2.5	3.0	3.5	4.5	5.3	6.2	7.0

§ 87. Branched Pipe connecting Reservoirs at Different Levels.—Let  $A, B, C$  (Fig. 98) be three reservoirs connected by the arrangement of pipes shown,  $A_1, d_1, Q_1, v_1; h_1, d_2, Q_2, v_2; h_1, d_3, Q_3, v_3$  being the length, diameter, discharge and velocity in the three portions of the main pipe. Suppose the dimensions and positions of the pipes known and the discharges required.

If a pressure column is introduced at  $X$ , the water will rise to a height  $XR$ , measuring the pressure at  $X$ , and  $aR, bR, cR$  will be the lines of virtual slope. If the free surface level at  $R$  is above  $b$ , the reservoir  $A$  supplies  $B$  and  $C$ , and if  $R$  is below  $b$ ,  $A$  and  $B$  supply  $C$ . Consequently there are three cases:—

- I.  $R$  above  $b; Q_1 = Q_2 + Q_3$ .
- II.  $R$  level with  $b; Q_1 = Q_2; Q_2 = 0$ .
- III.  $R$  below  $b; Q_1 + Q_2 = Q_3$ .

To determine which of these conditions to be dealt with in the given conditions, suppose the pipe from  $X$  to  $B$  closed by a sluice. Then there is a simple main, and the height of free surface  $h'$  at  $X$  can be determined. For this condition

$$h_a - h' = f(v_1^2/2g)(4h_1/d_1^5)$$

$$= 32fQ^2h_1/g\pi^2d_1^5;$$

$$h' - h_c = f(v_2^2/2g)(4h_2/d_2^5)$$

$$= 32fQ^2h_2/g\pi^2d_2^5;$$

where  $Q'$  is the common discharge of the two portions of the pipe. Hence

$$(h_a - h')/(h' - h_c) = l_1d_2^5/l_2d_1^5,$$

from which  $h'$  is easily obtained. If then  $h'$  is greater than  $h_b$ , opening the sluice between  $X$  and  $B$  will allow flow towards  $B$ , and the case in hand is case I. If  $h'$  is less than  $h_b$ , opening the sluice will allow flow from  $B$ , and the case is case III. If  $h' = h_b$ , the case is case II., and is already completely solved.

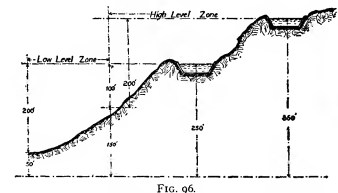

FIG. 96.

great variations of level it must be divided into zones of higher and lower pressure. Fig. 96 shows a district of two zones each with its service reservoir and a range of pressure in the lower district from 100 to 200 ft. The total supply required is in England about 25 gallons per head per day. But in many towns, and especially in America, the supply is considerably greater, but also in many cases

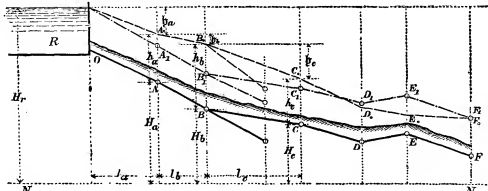

FIG. 97.

a good deal of the supply is lost by leakage of the mains. The supply through the branch mains of a distributing system is calculated from the population supplied. But in determining the capacity of the mains the fluctuation of the demand must be allowed for. It is usual to take the maximum demand at twice the average demand. Hence

The true value of  $h$  must lie between  $h'$  and  $h_0$ . Choose a new value of  $h$ , and recalculate  $Q_1, Q_2, Q_3$ . Then if

$$Q_1 > Q_2 + Q_3 \text{ in case I,}$$

or  $Q_1 + Q_2 > Q_3$  in case III,

or the value chosen for  $h$  is too small, and a new value must be chosen.

If

$$Q_1 < Q_2 + Q_3 \text{ in case I,}$$

or  $Q_1 + Q_2 < Q_3$  in case III,

or the value of  $h$  is too great.

Since the limits between which  $h$  can vary are in practical cases not very distant, it is easy to approximate to values sufficiently accurate.

§ 88. *Water Hammer.*—If in a pipe through which water is flowing a sluice is suddenly closed so as to arrest the forward movement of the water, there is a rise of pressure which in some cases is serious enough to burst the pipe. This action is termed water hammer or water ram. The fluctuation of pressure is an oscillating one and gradually dies out. Care is usually taken that sluices should only be closed gradually and then the effect is inappreciable. Very careful experiments on water hammer were made by N. J. Joukowski at Moscow in 1898 (*Stoss in Wasserleitungen*, St Petersburg, 1900), and the results are generally confirmed by experiments made by E. B. Weston and R. C. Carpenter in America. Joukowski used pipes, 2, 4 and 6 in. diameter from 1000 to 2500 ft. in length. The sluice closed in 0.03 second, and the fluctuations of pressure were automatically registered. The maximum excess pressure due to water-hammer action was as follows:—

Pipe 4-in. diameter.		Pipe 6-in. diameter.	
Velocity ft. per sec.	Excess Pressure. lb per sq. in.	Velocity ft. per sec.	Excess Pressure. lb per sq. in.
0.5	31	0.6	43
2.9	168	3.9	173
4.1	232	5.6	369
9.2	519	7.5	426

In some cases, in fixing the thickness of water mains, 100 lb per sq. in. excess pressure is allowed to cover the effect of water hammer. With the velocities usual in water mains, especially as no valves can be quite suddenly closed, this appears to be a reasonable allowance (see also Carpenter, *Am. Soc. Mech. Eng.*, 1893).

#### IX. FLOW OF COMPRESSIBLE FLUIDS IN PIPES

§ 89. *Flow of Air in Long Pipes.*—When air flows through a long pipe, by far the greater part of the work expended is used in overcoming frictional resistances due to the surface of the pipe. The work expended in friction generates heat, which for the most part must be developed in and given back to the air. Some heat may be transmitted through the sides of the pipe to surrounding materials, but in experiments hitherto made the amount so conducted away appears to be very small, and if no heat is transmitted the air in the tube must remain sensibly at the same temperature during expansion. In other words, the expansion may be regarded as isothermal expansion, the heat generated by friction exactly neutralizing the cooling due to the work done. Experiments on the pneumatic tubes used for the transmission of messages, by R. S. Culley and R. Sabine (*Proc. Inst. Civ. Eng.* xliiii.), show that the change of temperature of the air flowing along the tube is much less than it would be in adiabatic expansion.

§ 90. *Differential Equation of the Steady Motion of Air Flowing in a Long Pipe of Uniform Section.*—When air expands at a constant absolute temperature  $\tau$ , the relation between the pressure  $p$  in pounds per square foot and the density or weight per cubic foot  $G$  is given by the equation

$$p/G = c\tau, \quad (1)$$

where  $c = 53.15$ . Taking  $\tau = 521$ , corresponding to a temperature of 60° Fahr.,

$$c\tau = 27690 \text{ foot-pounds.} \quad (2)$$

The equation of continuity, which expresses the condition that in steady motion the same weight of fluid,  $W$ , must pass through each cross section of the stream in the unit of time, is

$$G\Omega u = W = \text{constant}, \quad (3)$$

where  $\Omega$  is the section of the pipe and  $u$  the velocity of the air. Combining (1) and (3),

$$\Omega u p / W = c\tau = \text{constant.} \quad (3a)$$

Since the work done by gravity on the air during its flow through a pipe, due to variations of its level is generally small compared with the work done by changes of pressure, the former may in many cases be neglected.

Consider a short length  $dl$  of the pipe limited by sections  $A_0, A_1$  at a distance  $dl$  (fig. 99). Let  $p, u$  be the pressure and velocity at  $A_0$ ,  $p+dp$  and  $u+du$  those at  $A_1$ . Further, suppose that in a very short

time  $dt$  the mass of air between  $A_0A_1$  comes to  $A_0'A_1'$  so that  $A_0'A_0' = udt$  and  $A_1'A_1' = (u+du)dt$ . Let  $\Omega$  be the section, and  $m$  the hydraulic mean radius of the pipe, and  $W$  the weight of air flowing through the pipe per second.

From the steadiness of the motion the weight of air between the sections  $A_0A_1$  and  $A_0'A_1'$  is the same. That is,

$$Wdt = G\Omega udt = G\Omega(u+du)dt.$$

By analogy with liquids the head lost in friction is, for the length  $dl$  (see § 72, eq. 3),  $\zeta(u^2/2g)(dl/m)$ . Let  $H = u^2/2g$ . Then the head lost is  $\zeta(H)m/dl$ ; and, since  $Wdt$  lb of air flow through the pipe in the time considered, the work expended in friction is  $-\zeta(H)mW/dl$ . The change of kinetic energy in  $dt$  seconds is the difference of the kinetic energy of  $A_0'A_1'$  and  $A_0A_1$ , that is,

$$(W/dl)dt(u+du)^2 - u^2/2 = (W/dl)u du = WdH/dl.$$

The work of expansion when  $\Omega udt$  cub. ft. of air at a pressure  $p$  expand to  $\Omega(u+du)dt$  cub. ft. is  $\Omega p du dt$ . But from (3a)  $u = c\tau W/\Omega p$ , and therefore

$$du/dp = -c\tau W/\Omega p^2.$$

And the work done by expansion is  $-(c\tau W/p)dp/dl$ .

The work done by gravity on the mass between  $A_0$  and  $A_1$  is zero if the pipe is horizontal, and may in other cases be neglected without great error. The work of the pressures at the sections  $A_0A_1$  is

$$p\Omega udt - (p+dp)\Omega(u+du)dt \\ = -(pdu + udp)\Omega dt$$

But from (3a)

$$pu = \text{constant,}$$

$$pdu + udp = 0,$$

and the work of the pressures is zero. Adding together the quantities of work, and equating them to the change of kinetic energy,

$$WdH/dl = -(c\tau W/p)dp/dl - \zeta(H)mW/dl$$

$$dH/H + (c\tau/p)dp/p + \zeta(H)m/dl = 0,$$

$$dH/H + (c\tau/H)dp/p + d\zeta/dl = 0. \quad (4)$$

But

$$u = c\tau W/\Omega p,$$

and

$$H = u^2/2g = c^2\tau^2 W^2/2g\Omega^2 p^2,$$

$$\therefore dH/H + (c\tau^2 W^2/2g\Omega^2)dp/p^2 + d\zeta/dl = 0. \quad (4a)$$

For tubes of uniform section  $m$  is constant; for steady motion  $W$  is constant; and for isothermal expansion  $\tau$  is constant. Integrating,

$$\log H + (c\tau^2 W^2/2g\Omega^2) \log p + \zeta l/m = \text{constant}; \quad (5)$$

for

$$l = 0, \text{ let } H = H_0, \text{ and } p = p_0;$$

and for

$$l = l, \text{ let } H = H_1, \text{ and } p = p_1;$$

$$\log(H_1/H_0) + (c\tau^2 W^2/2g\Omega^2)(p_1^2 - p_0^2)/p_0^2 + d\zeta/m = 0. \quad (5a)$$

where  $p_0$  is the greater pressure and  $p_1$  the less, and the flow is from  $A_0$  towards  $A_1$ .

By replacing  $W$  and  $H$ ,

$$\log(p_0/p_1) + (c\tau u_0^2/p_0^2)(p_1^2 - p_0^2) + \zeta l/m = 0. \quad (6)$$

Here the initial velocity in the pipe is

$$u_0 = \sqrt{\{[c\tau(p_0^2 - p_1^2)]/[p_0^2 \zeta l/m + \log(p_0/p_1)]\}}. \quad (7)$$

When  $l$  is great,  $\log(p_0/p_1)$  is comparatively small, and then

$$u_0 = \sqrt{\{[c\tau m/\zeta l](p_0^2 - p_1^2)/p_0^2\}}. \quad (7a)$$

a very simple and easily used expression. For pipes of circular section  $m = d/4$ , where  $d$  is the diameter:—

$$u_0 = \sqrt{\{[c\tau d/4\zeta l](p_0^2 - p_1^2)/p_0^2\}}; \quad (7b)$$

or approximately

$$u_0 = (1.1319 - 0.7263(p_1/p_0) \sqrt{[c\tau d/4\zeta l]}). \quad (7c)$$

§ 91. *Coefficient of Friction for Air.*—A discussion by Professor Unwin of the experiments by Culley and Sabine on the rate of transmission of light carriers through pneumatic tubes, in which there is steady flow of air not sensibly affected by any resistances other than surface friction, furnished the value  $\zeta = .007$ . The pipes were lead pipes, slightly moist,  $\frac{1}{2}$  in. (0.187 ft.) in diameter, and in lengths of 2000 to nearly 6000 ft.

In some experiments on the flow of air through cast-iron pipes A. Arson found the coefficient of friction to vary with the velocity and diameter of the pipe. Putting

$$\zeta = a/\tau + \beta, \quad (8)$$

he obtained the following values:—

Diameter of Pipe in feet.	$a$	$\beta$	$\zeta$ for 100 ft. per second.
1.64	-.00129	-.00483	-.00612
1.07	-.00972	-.00640	-.00650
.83	-.01525	-.00704	-.00719
.338	-.03604	-.00941	-.00977
.266	-.03790	-.00959	-.00997
.164	-.04158	-.01167	-.01212

It is worth while to try if these numbers can be expressed in the form proposed by Darcy for water. For a velocity of 100 ft. per second, and without much error for higher velocities, these numbers agree fairly with the formula

$$\zeta = 0.005(1 + 3/10d), \quad (9)$$

which only differs from Darcy's value for water in that the second term, which is always small except for very small pipes, is larger.

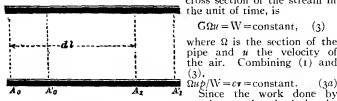

FIG. 99.

Some later experiments on a very large scale, by E. Stockalper at the St Gotthard Tunnel, agree better with the value

$$\zeta = 0.0028(1 + 3/10d).$$

These pipes were probably less rough than Arson's.

When the variation of pressure is very small, it is no longer safe to neglect the variation of level of the pipe. For that case we may neglect the work done by expansion, and then

$$\rho_0 - \rho_1 - \rho_0/C_0 - \rho_1/C_1 - \zeta(\rho_1^2/2g) = 0, \quad (10)$$

precisely equivalent to the equation for the flow of water,  $\rho_0$  and  $\rho_1$  being the elevations of the two ends of the pipe above any datum,  $\rho_0$  and  $\rho_1$  the pressures,  $C_0$  and  $C_1$  the densities, and  $v$  the mean velocity in the pipe. This equation may be used for the flow of coal gas.

§ 92. *Distribution of Pressure in a Pipe in which Air is Flowing.*—From equation (7a) it results that the pressure  $p$ , at  $l$  ft. from that end of the pipe where the pressure is  $p_0$ , is

$$p = p_0 \sqrt{1 - \zeta l u_0^2 / m g c r}; \quad (11)$$

which is of the form

$$p = \sqrt{(a l + b)}$$

for any given pipe with given end pressures. The curve of free surface level for the pipe is, therefore, a parabola with horizontal axis. Fig. 100 shows calculated curves of pressure for two of Sabine's experiments, in one of which the pressure was greater than atmo-

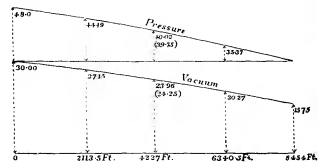

FIG. 100.

spheric pressure, and in the other less than atmospheric pressure. The observed pressures are given in brackets and the calculated pressures without brackets. The pipe was the pneumatic tube between Fenchurch Street and the Central Station, 2818 yds. in length. The pressures are given in inches of mercury.

*Variation of Velocity in the Pipe.*—Let  $p_0$ ,  $u_0$  be the pressure and velocity at a given section of the pipe;  $p$ ,  $u$ , the pressure and velocity at any other section. From equation (3a)

$$u p = c r W \Omega = \text{constant};$$

so that, for any given uniform pipe,

$$u p = u_0 p_0, \quad (12)$$

which gives the velocity at any section in terms of the pressure, which has already been determined. Fig. 101 gives the velocity

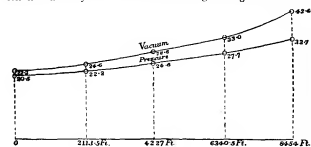

FIG. 101.

curves for the two experiments of Culley and Sabine, for which the pressure curves have already been drawn. It will be seen that the velocity increases considerably towards that end of the pipe where the pressure is least.

§ 93. *Weight of Air Flowing per Second.*—The weight of air discharged per second is (equation 3a)—

$$W = \Omega u_0 p_0 / c r.$$

From equation (7b), for a pipe of circular section and diameter  $d$ ,

$$W = \frac{1}{2} \pi \sqrt{[g d^3 (p_0^2 - p_1^2)] / c r}, \quad (13)$$

Approximately

$$W = (6916 p_0 - 4438 p_1) (d^3 / \zeta^2)^{1/2}. \quad (13a)$$

§ 94. *Application to the Case of Pneumatic Tubes for the Transmission of Messages.*—In Paris, Berlin, London, and other towns, it has been found cheaper to transmit messages in pneumatic tubes

than to telegraph by electricity. The tubes are laid underground with easy curves; the messages are made into a roll and placed in a light felt carrier, the resistance of which in the tubes in London is only  $\frac{1}{2}$  oz. A current of air forced into the tube or drawn through it propels the carrier. In most systems the current of air is steady and continuous, and the carriers are introduced or removed without materially altering the flow of air.

*Time of Transit through the Tube.*—Putting  $t$  for the time of transit from  $o$  to  $l$ ,

$$t = \int_0^l dl/u,$$

From (4a) neglecting  $dH/H$ , and putting  $m = d/4$ ,

$$dl = g d^2 p^2 dp / 2 \zeta W^2 c r.$$

From (1) and (3)

$$\begin{aligned} u &= W c r / p \Omega; \\ dl/u &= g d^2 p^2 dp / 2 \zeta W^2 c^2 r^2; \\ t &= \int_{p_1}^{p_0} \frac{g d^2 \Omega^2 p^2 dp}{2 \zeta W^2 c^2 r^2} \\ &= g d^2 (\rho_0^3 - \rho_1^3) / 6 \zeta W^2 c^2 r^2. \end{aligned} \quad (14)$$

But

$$\begin{aligned} W &= \rho u_0 \Omega / c r; \\ \therefore t &= g d^2 c r (\rho_0^3 - \rho_1^3) / 6 \zeta \rho^2 u_0^3 \\ &= \frac{2}{3} \zeta l (\rho_0^3 - \rho_1^3) / 6 (\zeta c r d) (l / (\rho_0^3 - \rho_1^3)). \end{aligned} \quad (15)$$

If  $r = 521^\circ$ , corresponding to  $60^\circ F.$ ,

$$t = .00141 \zeta l \Omega (\rho_0^3 - \rho_1^3) / d l (\rho_0^3 - \rho_1^3); \quad (15a)$$

which gives the time of transmission in terms of the initial and final pressures and the dimensions of the tube.

*Mean Velocity of Transmission.*—The mean velocity is  $l/t$ ; or, for  $r = 521^\circ$ ,

$$u_{\text{mean}} = 0.708 \sqrt{[d (\rho_0^3 - \rho_1^3)] / \zeta l (\rho_0^3 - \rho_1^3)}. \quad (16)$$

The following table gives some results:—

	Absolute Pressures in lbs per sq. in.		Mean Velocities for Tubes of a length in feet.				
	$p_0$	$p_1$	1000	2000	3000	4000	5000
Vacuum {	15	5	99.4	70.3	57.4	49.7	44.5
Working {	15	10	67.2	47.5	38.8	34.4	30.1
Pressure {	25	15	40.5	33.0	28.6	25.6	23.1
Working {	30	15	74.6	52.7	43.1	37.3	33.3
			84.7	60.0	49.0	42.4	37.9

*Limiting Velocity in the Pipe when the Pressure at one End is diminished indefinitely.*—If in the last equation there be put  $p_1 = 0$ , then

$$u_{\text{mean}} = 0.708 \sqrt{d / \zeta l};$$

where the velocity is independent of the pressure  $p_0$  at the other end, a result which apparently must be absurd. Probably for long pipes, as for orifices, there is a limit to the ratio of the initial and terminal pressures for which the formula is applicable.

## X. FLOW IN RIVERS AND CANALS

§ 95. *Flow of Water in Open Canals and Rivers.*—When water flows in a pipe the section at any point is determined by the form of the boundary. When it flows in an open channel with free upper surface, the section depends on the velocity due to the dynamical conditions.

Suppose water admitted to an unfilled canal. The channel will gradually fill, the section and velocity at each point gradually changing. But if the inflow to the canal at its head is constant, the increase of cross section and diminution of velocity at each point attain after a time a limit. Thereafterward the section and velocity at each point are constant, and the motion is steady, or permanent regime is established.

If when the motion is steady the sections of the stream are all equal, the motion is uniform. By hypothesis, the inflow  $\Omega$  is constant for all sections, and  $\Omega$  is constant; therefore  $v$  must be constant also from section to section. The case is then one of uniform steady motion. In most artificial channels the form of section is constant, and the bed has a uniform slope. In that case the motion is uniform, the depth is constant, and the stream surface is parallel to the bed. If when steady motion is established the sections are unequal, the motion is steady motion with varying velocity from section to section. Ordinary rivers are in this condition, especially where the flow is modified by weirs or obstructions. Short unobstructed lengths of a river may be treated as of uniform section without great error, the mean section in the length being put for the actual sections.

In all actual streams the different fluid filaments have different velocities, those near the surface and centre moving faster than those near the bottom and sides. The ordinary formulae for the flow of streams rest on a hypothesis that this variation of velocity may be neglected, and that all the filaments may be treated as having a common velocity equal to the mean velocity of the stream. On this hypothesis, a plane layer  $abab$  (fig. 102) between sections normal



to the direction of motion is treated as sliding down the channel to  $a'a'b'b'$  without deformation. The component of the weight parallel to the channel bed balances the friction against the channel, and in estimating the friction the velocity of rubbing is taken to be the mean velocity of the stream. In actual streams, however, the velocity of rubbing on which the friction depends is not the mean

$v =$	0.3	0.5	0.7	1	1½
$\zeta =$	0.01215	0.01025	0.00944	0.00883	0.00836

velocity of the stream, and is not in any simple relation with it, for channels of different forms. The theory is therefore obviously based on an imperfect hypothesis. However, by taking variable values for the coefficient of friction, the errors of the ordinary formulæ are to a great extent neutralized, and they may be used without leading to practical errors. Formulæ have been obtained based on less restricted hypotheses, but at present they are not practically so reliable, and are more complicated than the formulæ obtained in the manner described above.

FIG. 102.

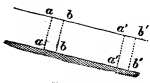

§ 96. *Steady Flow of Water with Uniform Velocity in Channels of Constant Section.*—Let  $aa'$ ,  $bb'$  (fig. 103) be two cross sections normal to the direction of motion at a distance  $dl$ . Since the mass  $aa'bb'$  moves uniformly, the external forces acting on it are in equilibrium. Let  $P$  be the area of the cross sections,  $\chi$  the wetted perimeter,

restricted hypotheses, but at present they are not practically so reliable, and are more complicated than the formulæ obtained in the manner described above.

FIG. 103.

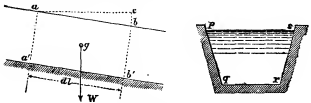

$pg + qr + rs$ , of a section. Then the quantity  $m = \Omega \chi$  is termed the hydraulic mean depth of the section. Let  $v$  be the mean velocity of the stream, which is taken as the common velocity of all the particles,  $i$ , the slope or fall of the stream in feet, per foot, being the ratio  $bc/ab$ .

The external forces acting on  $aa'bb'$  parallel to the direction of motion are three:—(a) The pressures on  $aa'$  and  $bb'$ , which are equal and opposite since the sections are equal and similar, and the mean pressures on each are the same. (b) The component of the weight  $W$  of the mass in the direction of motion, acting at its centre of gravity  $g$ . The weight of the mass  $aa'bb'$  is  $Gdl$ , and the component of the weight in the direction of motion is  $Gdl \times$  the cosine of the angle between  $Wg$  and  $ab$ , that is,  $Gdl \cos abc = Gdl \cos ab = Gdl \cos i$ . (c) There is the friction of the stream on the sides and bottom of the channel. This is proportional to the area  $\chi dl$  of rubbing surface and to a function of the velocity which may be written  $f(v)$ ;  $f(v)$  being the friction per sq. ft. at a velocity  $v$ . Hence the friction is  $-\chi dl f(v)$ . Equating the sum of the forces to zero,

$$\frac{Gdl}{f(v)} G = \chi dl f(v) = 0, \quad (1)$$

But it has been already shown (§ 66) that  $f(v) = \zeta G \Omega^2 / 2g$ ,

$$\therefore \zeta \Omega^2 / 2g = m. \quad (2)$$

This may be put in the form

$$v = \sqrt{2g/\zeta} \sqrt{m} = c \sqrt{mi}; \quad (2a)$$

where  $c$  is a coefficient depending on the roughness and form of the channel.

The coefficient of friction  $\zeta$  varies greatly with the degree of roughness of the channel sides, and somewhat also with the velocity. It must also be made to depend on the absolute dimensions of the section, to eliminate the error of neglecting the variations of velocity in the cross section. A common mean value assumed for  $\zeta$  is 0.00757. The range of values will be discussed presently.

It is often convenient to estimate the fall of the stream in feet per mile, instead of in feet per foot. If  $f$  is the fall in feet per mile,

$$f = 5280 i.$$

Putting this and the above value of  $i$  in (2a), we get the very simple and long-known approximate formula for the mean velocity of a stream—

$$v = \frac{1}{2} \sqrt{2mf}. \quad (3)$$

The flow down the stream per second, or discharge of the stream, is

$$Q = \Omega v = \Omega c \sqrt{mi}. \quad (4)$$

§ 97. *Coefficient of Friction for Open Channels.*—Various expressions have been proposed for the coefficient of friction  $\zeta$  for channels as for pipes. Weisbach, giving attention chiefly to the

variation of the coefficient of friction with the velocity, proposed an expression of the form

$$\zeta = \alpha(1 + \beta v), \quad (5)$$

and from 255 experiments obtained for the constants the values

$$\alpha = 0.007409; \beta = 0.020.$$

This gives the following values at different velocities:—

2	3	5	7	10	15
0.00812	0.00788	0.00769	0.00761	0.00755	0.00750

In using this value of  $\zeta$  when  $v$  is not known, it is best to proceed by approximation.

§ 98. *Darcy and Bazin's Expression for the Coefficient of Friction.*—Darcy and Bazin's researches have shown that  $f$  varies very greatly for different degrees of roughness of the channel bed, and that it also varies with the dimensions of the channel. They give for  $f$  an empirical expression (similar to that for pipes) of the form

$$f = \alpha(1 + \beta/m); \quad (6)$$

where  $m$  is the hydraulic mean depth. For different kinds of channels they give the following values of the coefficient of friction:—

Kind of Channel.	$\alpha$	$\beta$
I. Very smooth channels, sides of smooth cement or planed timber	0.00294	0.10
II. Smooth channels, sides of ashlar, brick-work, planks	0.00373	0.23
III. Rough channels, sides of rubble masonry or pitched with stone	0.00471	0.82
IV. Very rough canals in earth	0.00549	4.10
V. Torrential streams encumbered with detritus	0.00785	5.74

The last values (Class V.) are not Darcy and Bazin's, but are taken from experiments by Gauguillet and Kutter on Swiss streams.

The following table very much facilitates the calculation of the mean velocity and discharge of channels, when Darcy and Bazin's value of the coefficient of friction is used. Taking the general formula for the mean velocity already given in equation (2a) above,

$$v = c \sqrt{mi},$$

where  $c = \sqrt{2g/\zeta}$ , the following table gives values of  $c$  for channels of different degrees of roughness, and for such values of the hydraulic mean depths as are likely to occur in practical calculations:—

Values of  $c$  in  $v = c \sqrt{mi}$ , deduced from Darcy and Bazin's Values.

Hydraulic Mean Depth = $m$ .	Hydraulic Mean Depth = $m$ .					Hydraulic Mean Depth = $m$ .				
	Very Smooth Channels, Cement, Ashlar or Brickwork.	Smooth Channels, Rubble Masonry.	Rough Channels, Rubble Masonry.	Very Rough Channels, Rubble Masonry.	Excessively Rough Channels, Rubble Masonry.	Very Smooth Channels, Cement, Ashlar or Brickwork.	Smooth Channels, Rubble Masonry.	Rough Channels, Rubble Masonry.	Very Rough Channels, Rubble Masonry.	Excessively Rough Channels, Rubble Masonry.
.25	125	95	57	26	18.5	8.5	147	130	112	89
.5	135	110	72	36	25.6	9.0	147	130	112	90
.75	139	116	81	42	30.8	9.5	147	130	112	90
1.0	141	119	87	48	34.9	10.0	147	130	112	91
1.5	143	122	94	56	41.2	11	147	130	112	92
2.0	144	124	98	62	46.0	11	147	130	112	93
2.5	145	126	101	67	50	11	147	130	112	94
3.0	145	126	104	70	53	14	147	130	112	95
3.5	146	127	105	73	55	15	147	130	114	96
4.0	146	128	106	76	58	16	147	130	114	97
4.5	146	128	107	78	60	17	147	130	114	97
5.0	146	128	108	80	62	18	147	130	114	98
5.5	146	129	109	82	64	20	147	131	114	98
6.0	147	129	110	84	65	25	148	131	115	100
6.5	147	129	110	85	66	30	148	131	115	102
7.0	147	129	110	86	67	40	148	131	116	103
7.5	147	129	111	87	68	50	148	131	116	104
8.0	147	130	111	88	69	60	148	131	117	105

§ 99. *Gauguillet and Kutter's Modified Darcy Formula.*—Starting from the general expression  $v = c \sqrt{mi}$ , Gauguillet and Kutter examined the variations of  $c$  for a wider variety of cases than those discussed by Darcy and Bazin. Darcy and Bazin's experiments were confined to channels of moderate section, and to a limited variation of slope. Gauguillet and Kutter brought into the discussion two very distinct and important additional series of results. The gaugings of the Mississippi by A. A. Humphreys and H. L. Abbot afford data of discharge for the case of a stream of exceptionally large section and of very low slope. On the other hand, their own measurements of the flow in the regulated channels of some

Swiss torrents gave data for cases in which the inclination and roughness of the channels were exceptionally great. Darcy and Bazin's experiments alone were conclusive as to the dependence of the coefficient  $c$  on the dimensions of the channel and on its roughness of surface. Plotting values of  $c$  for channels of different inclination appeared to indicate that it also depended on the slope of the stream. Taking the Mississippi data only, they found

$$c = 256 \text{ for an inclination of } 0\text{-}0034 \text{ per thousand,} \\ = 154 \text{ " " " } 0\text{-}02 \text{ " " "}$$

so that for very low inclinations no constant value of  $c$  independent of the slope would furnish good values of the discharge. In small rivers, on the other hand, the values of  $c$  vary little with the slope. As regards the influence of roughness of the sides of the channel a different law holds. For very small channels differences of roughness have a great influence on the discharge, but for very large channels different degrees of roughness have but little influence, and for indefinitely large channels the influence of different degrees of roughness must be assumed to vanish. The coefficients given by Darcy and Bazin are different for each of the classes of channels of different roughness, even when the dimensions of the channel are infinite. But, as it is much more probable that the influence of the nature of the sides diminishes indefinitely as the channel is larger, this must be regarded as a defect in their formula.

Comparing their own measurements in torrential streams in Switzerland with those of Darcy and Bazin, Ganguillet and Kutter found that the four classes of coefficients proposed by Darcy and Bazin were insufficient to cover all cases. Some of the Swiss streams gave results which showed that the roughness of the bed was markedly greater than in any of the channels tried by the French engineers. It was necessary therefore in adopting the plan of arranging the different channels in classes of approximately similar roughness to increase the number of classes. Especially an additional class was required for channels obstructed by detritus.

To obtain a new expression for the coefficient in the formula

$$v = \sqrt{(2g/\zeta)} \sqrt{(mi)} = c \sqrt{(mi)},$$

Ganguillet and Kutter proceeded in a purely empirical way. They found that an expression of the form

$$c = a/(1 + \beta/\sqrt{m})$$

could be made to fit the experiments somewhat better than Darcy's expression. Inverting this, we get

$$1/c = 1/a + \beta/a\sqrt{m},$$

an equation to a straight line having  $1/\sqrt{m}$  for abscissa,  $1/c$  for ordinate, and inclined to the axis of abscissae at an angle the tangent of which is  $\beta/a$ .

Plotting the experimental values of  $1/c$  and  $1/\sqrt{m}$ , the points so found indicated a curved rather than a straight line, so that  $\beta$  must depend on  $a$ . After much comparison the following form was arrived at—

$$c = (A + l/n)/(1 + Aa/\sqrt{m}),$$

where  $n$  is a coefficient depending only on the roughness of the sides of the channel, and  $A$  and  $l$  are new coefficients, the value of which remains to be determined. From what has been already stated, the coefficient  $c$  depends on the inclination of the stream, decreasing as the slope  $i$  increases.

$$\text{Let } A = a + \beta/i.$$

$$\text{Then } c = (a + \beta/n + \beta/i)/(1 + \beta/i)n\sqrt{m},$$

the form of the expression for  $c$  ultimately adopted by Ganguillet and Kutter.

For the constants  $a$ ,  $l$ ,  $\beta$  Ganguillet and Kutter obtain the values 23, 1 and 0.00155 for metrical measures, or 41.6, 1.811 and 0.00281 for English feet. The coefficient of roughness  $n$  is found to vary from 0.008 to 0.050 for either metrical or English measures.

The most practically useful values of the coefficient of roughness  $n$  are given in the following table:—

Nature of Sides of Channel.	Coefficient of Roughness $n$ .
Well-planned timber	0.009
Cement plaster	0.010
Plaster of cement with one-third sand	0.013
Unplanned planks	0.011
Ashtar and brickwork.	0.013
Canvas on frames	0.015
Rubble masonry	0.017
Canals in very firm gravel	0.020
Rivers and canals in perfect order, free from stones or weeds	0.025
Rivers and canals in inadequately good order, not quite free from stones and weeds	0.030
Rivers and canals in bad order, with weeds and detritus	0.035
Torrential streams encumbered with detritus	0.050

Ganguillet and Kutter's formula is so cumbersome that it is difficult to use without the aid of tables.

Lewis D'A. Jackson published complete and extensive tables for facilitating the use of the Ganguillet and Kutter formula (*Canal*

and Culvert Tables, London, 1878). To lessen calculation he puts the formula in this form:—

$$M = n(41.6 + 0.00281/i); \\ v = (\sqrt{m}n)/\{(M + 1.811)/(M + \sqrt{m})\} \sqrt{(mi)}.$$

The following table gives a selection of values of  $M$ , taken from Jackson's tables:—

$i =$	Values of $M$ for $n =$						
	0.010	0.012	0.015	0.017	0.020	0.025	0.030
0.0001	3.2260	3.8712	4.8390	5.4842	6.4520	8.0650	9.6780
0.0002	1.8210	2.1852	2.7315	3.0957	3.6420	4.5525	5.4630
0.0004	1.1185	1.3422	1.6777	1.9014	2.2370	2.7962	3.3555
0.0006	0.8843	1.0612	1.3204	1.5033	1.7686	2.2107	2.6529
0.0008	0.7672	0.9206	1.1508	1.3244	1.5344	1.9180	2.3016
0.0010	0.6870	0.8304	1.0455	1.1849	1.3949	1.7425	2.0910
0.0015	0.5284	0.6341	0.7926	0.8983	1.0668	1.3210	1.5832
0.0020	0.4772	0.5666	0.7083	0.8027	0.9444	1.1805	1.4166
0.0025	0.4535	0.5442	0.6802	0.7709	0.9077	1.1337	1.3605
0.0030	0.4441	0.5329	0.6661	0.7550	0.8882	1.1102	1.3323
0.0040	0.4300	0.5160	0.6450	0.7310	0.8600	1.0750	1.2900
0.0050	0.4254	0.5105	0.6381	0.7232	0.8500	1.0635	1.2762

A difficulty in the use of this formula is the selection of the coefficient of roughness. The difficulty is one which no theory will overcome, because no absolute measure of the roughness of stream beds is possible. For channels lined with timber or masonry the difficulty is not so great. The constants in that case are few and sufficiently defined. But in the case of ordinary canals and rivers the case is different, the coefficients having a much greater range. For artificial canals in rammed earth or gravel  $n$  varies from 0.0163 to 0.0301. For natural channels or rivers  $n$  varies from 0.020 to 0.035.

In Jackson's opinion even Kutter's numerical classification of channels seem inadequately graduated, and he proposes for artificial canals the following classification:—

- I. Canals in very firm gravel, in perfect order  $n = 0.02$
- II. Canals in earth, above the average in order  $n = 0.025$
- III. Canals in earth, in fair order  $n = 0.025$
- IV. Canals in earth, below the average in order  $n = 0.0275$
- V. Canals in earth, in rather bad order, partially overgrown with weeds and obstructed by detritus  $n = 0.03$

Ganguillet and Kutter's formula has been considerably used partly from its adoption in calculating tables for irrigation work in India. But it is an empirical formula of an unsatisfactory form. Some engineers apparently have assumed that because it is complicated it must be more accurate than simple formulae. Comparison with the results of gaugings shows that this is not the case. The term involving the slope was introduced to secure agreement with some early experiments on the Mississippi, and there is strong reason for doubting the accuracy of these results.

§ 100. *Bazin's New Formula.*—Bazin subsequently re-examined all the trustworthy gaugings of flow in channels and proposed a modification of the original Darcy formula which appears to be more satisfactory than any hitherto suggested (*Étude d'une nouvelle formule*, Paris, 1898). He points out that Darcy's original formula, which is of the form  $mi^{1/2} = a + \beta/m$ , does not agree with experiments on channels as well as with experiments on pipes. It is an objection to it that if  $m$  increases indefinitely the limit towards which  $mi^{1/2}$  tends is different for different values of the roughness. It would seem that if the dimensions of a canal are indefinitely increased the variation of resistance due to differing roughness should vanish. This objection is met if it is assumed that  $\sqrt{(mi)^2} = a + \beta/\sqrt{m}$ , so that if  $a$  is a constant  $mi^{1/2}$  tends to the limit  $a$  when  $m$  increases. A very careful discussion of the results of gaugings shows that they can be expressed more satisfactorily by this new formula than by Ganguillet and Kutter's. Putting the equation in the form  $v^2/2g = mi$ ,  $v = 0.002394(1 + \beta/\sqrt{m})$ , where  $v$  has the following values:—

- I. Very smooth sides, cement, planed plank,  $v = 0.100$
- II. Smooth sides, planks, brickwork  $v = 0.290$
- III. Rubble masonry sides  $v = 0.833$
- IV. Sides of very smooth earth, or pitching  $v = 1.539$
- V. Canals in earth in ordinary condition  $v = 2.353$
- VI. Canals in earth exceptionally rough  $v = 3.168$

§ 101. *The Vertical Velocity Curve.*—If at each point along a vertical representing the depth of a stream, the velocity at that point is plotted horizontally, the curve obtained is the vertical velocity curve and it has been shown by many observations that it approximates to a parabola with horizontal axis. The vertex of the parabola is at the level of the greatest velocity. Thus in fig. 104 OA is the vertical at which velocities are observed;  $v_0$  is the surface velocity;  $v_1$  the maximum and  $v_2$  the bottom velocity; B C D is the vertical velocity curve which corresponds with a parabola having its vertex at C. The mean velocity at the vertical is

$$v_m = \frac{1}{3}(2v_2 + v_1 + (d_2/d_1)(v_0 - v_2)).$$

*The Horizontal Velocity Curve.*—Similarly if at each point along a horizontal representing the width of the stream the velocities are

plotted, a curve is obtained called the horizontal velocity curve. In streams of symmetrical section this is a curve symmetrical about the centre line of the stream. The velocity varies little near the centre of the stream, but very rapidly near the banks. In unsymmetrical sections the greatest velocity is at the point where the stream is deepest, and the general form of the horizontal velocity curve is roughly similar to the section of the stream.

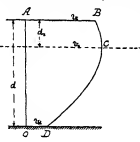

FIG. 104.

the vertical and horizontal velocity curves and the contours of equal velocity in a rectangular channel, from one of Bazin's gaugings.

§ 103. *Experimental Observations on the Vertical Velocity Curve.*—A preliminary difficulty arises in observing the velocity at a given point in a stream because the velocity rapidly varies, the motion not being strictly steady. If an average of several velocities at the same point is taken, or the average velocity for a sensible period of time, this average is found to be constant. It may be inferred that

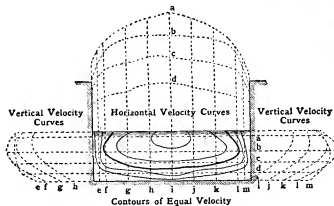

FIG. 105.

though the velocity at a point fluctuates about a mean value, the fluctuations being due to eddying motions superposed on the general motion of the stream, yet these fluctuations produce effects which disappear in the mean of a series of observations and, in calculating the volume of flow, may be disregarded.

In the next place it is found that in most of the best observations on the velocity in streams, the greatest velocity at any vertical is found not at the surface but at some distance below it. In various river gaugings the depth  $d_s$  at the centre of the stream has been found to vary from 0 to 0.3d.

§ 104. *Influence of the Wind.*—In the experiments on the Mississippi the vertical velocity curves in calm weather was found to agree fairly with a parabola, the greatest velocity being at  $\frac{1}{8}$ ths of the depth of the stream from the surface. With a wind blowing down stream the surface velocity is increased, and the axis of the parabola approaches the surface. On the contrary, with a wind blowing up stream the surface velocity is diminished, and the axis of the parabola is lowered, sometimes to half the depth of the stream. The American observers drew from their observations the conclusion that there was an energetic retarding action at the surface of a stream like that due to the bottom and sides. If there were such a retarding action the position of the filament of maximum velocity below the surface would be explained.

It is not difficult to understand that a wind acting on surface ripples or waves should accelerate or retard the surface motion of the stream, and the Mississippi results may be accepted so far as showing that the surface velocity of a stream is variable when the mean velocity of the stream is constant. Hence observations of surface velocity by floats or otherwise should only be made in very calm weather. But it is very difficult to suppose that, in still air, there is a resistance at the free surface of the stream at all analogous to that at the sides and bottom. Further, in very careful experiments, P. P. Boileau found the maximum velocity, though raised a little above its position for calm weather, still at a considerable distance below the surface, even when the wind was blowing down stream with a velocity greater than that of the stream, and when the action of the air must have been an accelerating and not a retarding action. A much more probable explanation of the diminution

of the velocity at and near the free surface is that portions of water, with a diminished velocity from retardation by the sides or bottom, are thrown off in eddying masses and mingle with the rest of the stream. These eddying masses modify the velocity in all parts of the stream, but have their greatest influence at the free surface. Reaching the free surface they spread out and remain there, mingling with the water at that level and diminishing the velocity which would otherwise be found there.

*Influence of the Wind on the Depth at which the Maximum Velocity is found.*—In the gaugings of the Mississippi the vertical velocity curve was found to agree well with a parabola having a horizontal axis at some distance below the water surface, the ordinate of the parabola at the axis being the maximum velocity of the section. During the gaugings the force of the wind was registered on a scale ranging from 0 for a calm to 10 for a hurricane. Arranging the velocity curves in three sets—(1) with the wind blowing up stream, (2) the wind blowing down stream, (3) calm or wind blowing across stream—it was found that an up-stream wind lowered, and a down-stream wind raised, the axis of the parabolic velocity curve. In calm weather the axis was at  $\frac{1}{8}$ ths of the total depth from the surface for all conditions of the stream.

Let  $k'$  be the depth of the axis of the parabola,  $m$  the hydraulic mean depth,  $f$  the number expressing the force of the wind, which may range from +10 to -10, positive if the wind is up stream, negative if it is down stream. Then Humphreys and Abbot find their results agree with the expression

$$k'/m = 0.317 \pm 0.06f.$$

Fig. 106 shows the parabolic velocity curves according to the American observers for calm weather, and for an up- or down-stream wind of a force represented by 4.

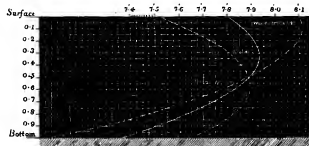

FIG. 106.

It is impossible at present to give a theoretical rule for the vertical velocity curve, but in very many gaugings it has been found that a parabola with horizontal axis fits the observed results fairly well. The mean velocity on any vertical in a stream varies from 0.85 to 0.92 of the surface velocity at that vertical, and on the average if  $v_s$  is the surface and  $v_m$  the mean velocity at a vertical  $v_m = \frac{1}{2}v_s$ , a result useful in float gauging. On any vertical there is a point at which the velocity is equal to the mean velocity, and if this point were known it would be useful in gauging. Humphreys and Abbot in the Mississippi found the mean velocity at 0.66 of the depth; G. H. L. Hagen and H. Heinenmann at 0.56 to 0.58 of the depth. The mean of observations by various observers gave the mean velocity at from 0.587 to 0.62 of the depth, the average of all being almost exactly 0.6 of the depth. The mid-depth velocity is therefore nearly equal to, but a little greater than, the mean velocity on a vertical. If  $v_{mid}$  is the mid-depth velocity, then on the average  $v_m = 0.988v_{mid}$ .

§ 105. *Mean Velocity on a Vertical from Two Velocity Observations.*—A. J. C. Cunningham, in gaugings on the Ganges canal, found the following useful results. Let  $v_s$  be the surface,  $v_m$  the mean, and  $v_{sd}$  the velocity at the depth  $xd$ ; then

$$v_m = \frac{1}{2}(v_s + 3v_{sd}) \\ = \frac{1}{2}(v_{.211}^2 + v_{.789}^2).$$

§ 106. *Ratio of Mean to Greatest Surface Velocity, for the whole Cross Section in Trapezoidal Channels.*—It is often very important to be able to deduce the mean velocity, and thence the discharge, from observation of the greatest surface velocity. The simplest method of gauging small streams and channels is to observe the greatest surface velocity by floats, and thence to deduce the mean velocity. In general in streams of fairly regular section the mean velocity for the whole section varies from 0.7 to 0.85 of the greatest surface velocity. For channels not widely differing from those experimented on by Bazin, the expression obtained by him for the ratio of surface to mean velocity may be relied on as at least a good approximation to the truth. Let  $v_s$  be the greatest surface velocity,  $v_m$  the mean velocity of the stream. Then, according to Bazin,

$$v_m = v_s - 25.4 \sqrt{(mi)} \\ v_m = c \sqrt{(mi)},$$

where  $c$  is a coefficient, the values of which have been already given in the table in § 98. Hence

$$v_m = c v_s / (c + 25.4).$$

Values of Coefficient  $c/(c+25.4)$  in the Formula  $v_m = cv_m/(c+25.4)$ .

Hydraulic Mean Depth in ft.	Very Smooth Channels, Cement.	Smooth Channels, Ashlar or Brickwork.	Rough Channels, Rubble Masonry.	Very Rough Channels, Canals in Earth.	Channels encumbered with Detritus.
0.25	.83	.79	.69	.51	.42
0.5	.84	.81	.74	.58	.48
0.75	.84	.82	.76	.63	.55
1.0	.85	..	.77	.65	.58
2.0	..	.83	.79	.71	.64
3.0	..	..	.80	.73	.67
4.0	..	..	.81	.75	.70
5.0	..	..	..	.76	.71
6.0	..	.84	..	.77	.72
7.0	..	..	..	.78	.73
8.0	..	..	..	..	..
9.0	..	..	.82	..	.74
10.0	..	..	..	..	..
15.0	..	..	..	.79	.75
20.0	..	..	..	.80	.76
30.0	..	..	.82	..	.77
40.0	..	..	..	..	..
50.0	..	..	..	..	.79

§ 107. *River Bends.*—In rivers flowing in alluvial plains, the windings which already exist tend to increase in curvature by the scouring away of material from the outer bank and the deposition of detritus along the inner bank. The sinuosities sometimes increase till a loop is formed with only a narrow strip of land between the two encroaching branches of the river. Finally a "cut off" may occur, a waterway being opened through the strip of land and the loop

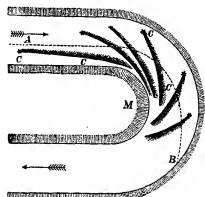

FIG. 107.

left separated from the stream, forming a horse-shoe shaped lagoon or marsh. Professor James Thomson pointed out (*Proc. Roy. Soc.*, 1877, p. 356; *Proc. Inst. of Mech. Eng.*, 1879, p. 456) that the usual supposition

is that the water tending to go forwards in a straight line rushes against the outer bank and scours it, at the same time creating deposits at the inner bank. That view is very far from a complete account of the matter, and Professor Thomson gave a much more ingenious account of the action at the bend, which he completely confirmed by experiment.

When water moves round a circular curve under the action of gravity only, it takes a motion like that in a free vortex. Its velocity is greater parallel to the axis of the stream at the inner than at the outer side of the bend. Hence the scouring at the outer side and the deposit at the inner side of the bend are not due to mere difference of velocity of flow in the general direction of the stream; but, in virtue of the centrifugal force, the water passing round the bend presses outwards, and the free surface in a radial cross section has a slope from the inner side upwards to the outer side (fig. 108). For the greater part of the water flowing in curved paths, this difference of pressure produces no tendency to transverse motion.

But the water immediately in contact with the rough bottom and sides of the channel is retarded, and its centrifugal force is insufficient to balance the pressure due to the greater depth at the outside of the bend. It therefore flows inwards towards the inner side of the bend, carrying with it detritus which is deposited at the inner bank. Conjointly with this flow inwards along the bottom and sides, the



FIG. 108.

flow flows inwards towards the inner side of the bend, carrying with it detritus which is deposited at the inner bank. Conjointly with this flow inwards along the bottom and sides, the

Depth of water in terms of radius	$\kappa$	.01	.05	.10	.15	.20	.25	.30	.35	.40	.45	.50	.55	.60	.65	.70	.75	.80	.85	.90	.95	1.0	
Hydraulic mean depth in terms of radius	$\mu$	..	.00668	.0211	.0523	.0963	.1478	.1974	.2452	.2912	.3356	.3785	.4199	.4599	.4985	.5358	.5718	.6074	.6426	.6774	.7118	.7458	.7794
Waterway in terms of square of radius	$\nu$	..	.00180	.0111	.0398	.0867	.1515	.2248	.3042	.3888	.4778	.5704	.6668	.7672	.8718	.9804	1.0932	1.2104	1.3322	1.4588	1.5904	1.7270	1.8688

general mass of water must flow outwards to take its place. Fig. 107 shows the directions of flow as observed in a small artificial stream, by means of light seeds and specks of aniline dye. The lines CC show the directions of flow immediately in contact with the sides and bottom. The dotted line AB shows the direction of motion of floating particles on the surface of the stream.

§ 108. *Discharge of a River taken flowing at different Depths.*—When frequent observations must be made on the flow of a river or canal, the depth of which varies at different times, it is very convenient to have to observe the depth only. A formula can be established giving the flow in terms of the depth. Let  $Q$  be the discharge in cubic feet per second;  $H$  the depth of the river in some straight and uniform part. Then  $Q = aH + bH^2$ , where the constants  $a$  and  $b$  must be found by preliminary gaugings in different conditions of the river. M. C. Moqueury found for the upper Saône,  $Q = 64.7H + 8.2H^2$  in metric measures, or  $Q = 696H + 26.8H^2$  in English measures.

§ 109. *Forms of Section of Channels.*—The simplest form of section for channels is the semicircular or nearly semicircular channel (fig. 109), a form now often adopted from the facility with which it can be

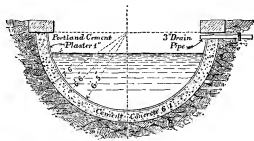

FIG. 109.

executed in concrete. It has the advantage that the rubbing surface is less in proportion to the area than in any other form.

Wooden channels or flumes, of which there are examples on a large scale in America, are rectangular in section, and the same form is adopted for wrought and cast-iron aqueducts. Channels built with brickwork or masonry may be also rectangular, but they are often trapezoidal, and are always so if the sides are pitched with masonry laid dry. In a trapezoidal channel, let  $b$  (fig. 110)

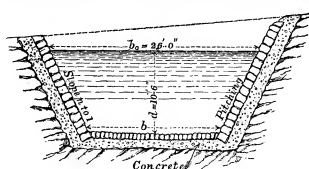

FIG. 110.

be the bottom breadth,  $b_0$  the top breadth,  $d$  the depth, and let the slope of the sides be  $n$  horizontal to 1 vertical. Then the area of section is  $\Omega = (b + nd)d = (b + nd)d$ , and the wetted perimeter  $x = b + 2nd \sqrt{(n^2 + 1)}$ .

When a channel is simply excavated in earth it is always originally trapezoidal, though it becomes more or less rounded in course of time. The slope of the sides then depends on the stability of the earth, a slope of 2 to 1 being the one most commonly adopted.

Figs. 111, 112 show the form of canals excavated in earth, the former being the section of a navigation canal and the latter the section of an irrigation canal.

§ 110. *Channels of Circular Section.*—The following short table facilitates calculations of the discharge with different depths of water in the channel. Let  $r$  be the radius of the channel section; then for a depth of water =  $\kappa r$ , the hydraulic mean radius is  $\mu r$  and the area of section of the waterway  $\nu r^2$ , where  $\kappa$ ,  $\mu$ , and  $\nu$  have the following values:—

§ 111. *Egg-Shaped Channels or Sewers.*—In sewers for discharging storm water and house drainage the volume of flow is extremely variable; and there is a great liability for deposits to be left when the flow is small, which are not removed during the short periods when the flow is large. The sewer in consequence becomes choked.

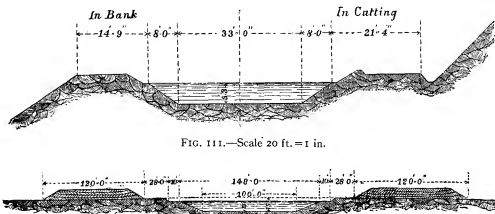

FIG. 111.—Scale 20 ft. = 1 in.



FIG. 112.—Scale 80 ft. = 1 in.

To obtain uniform scouring action, the velocity of flow should be constant or nearly so; a complete uniformity of velocity cannot be obtained with any form of section suitable for sewers, but an approximation to uniform velocity is obtained by making the sewers of oval section. Various forms of oval have been suggested, the simplest being one in which the radius of the crown is double the radius of the invert, and the greatest width is two-thirds the height, and the section of such a sewer is shown in fig. 113, the numbers marked on the figure being proportional numbers.

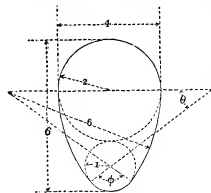

FIG. 113.

§ 112. *Problems on Channels in which the Flow is Steady and at Uniform Velocity.*—The general equations given in §§ 96, 98 are

$$\begin{aligned} \bar{v} &= \alpha(1 + \beta/m); & (1) \\ \Omega^2/2g &= m\bar{v}; & (2) \\ Q &= \Omega\bar{v}. & (3) \end{aligned}$$

*Problem I.*—Given the transverse section of stream and discharge, to find the slope. From the dimensions of the section find  $\Omega$  and  $m$ ; from (1) find  $\bar{v}$ , from (3) find  $v$ , and lastly from (2) find  $i$ .

*Problem II.*—Given the transverse section and slope, to find the discharge. Find  $v$  from (2), then  $Q$  from (3).

*Problem III.*—Given the discharge and slope, and either the breadth, depth, or general form of the section of the channel, to determine its remaining dimensions. This must generally be solved by approximations. A breadth or depth or both are chosen, and the discharge calculated. If this is greater than the given discharge, the dimensions are reduced and the discharge recalculated.

Since  $m$  lies generally between the limits  $m=d$  and  $m=3d$ , where  $d$  is the depth of the stream, and since, moreover, the velocity varies as  $\sqrt{m}$  so that an error in the value of  $m$  leads only to a much less error in the value of the velocity calculated from it, we may proceed thus. Assume a value for  $m$ , and calculate  $v$  from it. Let  $v_1$  be this first approximation to  $v$ . Then  $Q/v_1$  is a first approximation to  $\Omega$ , say  $\Omega_1$ . With this value of  $\Omega_1$  design the section of the channel; calculate a second value for  $m$ ; calculate from it a second value of  $v$ , and from that a second value for  $\Omega$ . Repeat the process till the successive values of  $m$  approximately coincide.

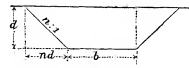

FIG. 114.

§ 113. *Economical Form of Channel for given Side Slopes.*—Suppose the channel is to be trapezoidal in section (fig. 114), and that the sides are to have a given slope. Let the longitudinal slope of the stream be given, and also the mean velocity. An infinite number of channels

could be found satisfying the foregoing conditions. To render the problem determinate, let it be remembered that, since for a given discharge  $\Omega \propto \sqrt{x}$ , other things being the same, the amount of excavation will be least for that channel which has the least wetted perimeter.

Let  $d$  be the depth and  $b$  the bottom width of the channel, and let the sides slope  $n$  horizontal to 1 vertical (fig. 114), then

$$\begin{aligned} \Omega &= (b + nd)d; \\ x &= b + 2d\sqrt{n^2 + 1}. \end{aligned}$$

Both  $\Omega$  and  $x$  are to be minima. Differentiating, and equating to zero,

$$\begin{aligned} (db/dd + n)d + b + nd &= 0, \\ db/dd + 2d\sqrt{n^2 + 1} &= 0; \end{aligned}$$

eliminating  $db/dd$ ,

$$\begin{aligned} [n - 2\sqrt{n^2 + 1}]d + b + nd &= 0; \\ b &= 2[\sqrt{n^2 + 1} - n]d. \end{aligned}$$

But

$$\Omega/x = (b + nd)d / [b + 2d\sqrt{n^2 + 1}].$$

Inserting the value of  $b$ ,

$$m = \Omega/x = \{2d\sqrt{n^2 + 1} - nd\} / \{2d\sqrt{n^2 + 1} - 2nd\} = \frac{1}{2}d.$$

That is, with given side slopes, the section is least for a given discharge when the hydraulic mean depth is half the actual depth.

A simple construction gives the form of the channel which fulfils

this condition, for it can be shown that when  $m = \frac{1}{2}d$  the sides of the channel are tangential to a semicircle drawn on the water line.

Since therefore

$$\begin{aligned} \Omega/x &= \frac{1}{2}d, \\ \Omega &= \frac{1}{2}xd. \end{aligned} \quad (1)$$

Let ABCD be the channel (fig. 115); from E the centre of AD drop perpendiculars EF, EG, EH on the sides.

Let

$$AB = CD = a; \quad BC = b; \quad EF = EH = c; \quad \text{and} \quad EG = d.$$

$$\begin{aligned} \Omega &= \text{area AEB} + \text{BEC} + \text{CED}, \\ &= ac + \frac{1}{2}bd. \\ x &= 2a + b. \end{aligned}$$

Putting these values in (1),

$$ac + \frac{1}{2}bd = (a + \frac{1}{2}b)d; \quad \text{and hence } c = d.$$

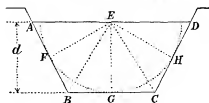

FIG. 115.

That is, EF, EG, EH are all equal, hence a semicircle struck from E with radius equal to the depth of the stream will pass through F and H and be tangential to the sides of the channel.

To draw the channel, describe a semicircle on a horizontal line with radius = depth of channel. The bottom will be a horizontal tangent of that semicircle, and the sides tangents drawn at the required side slopes.

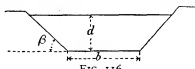

FIG. 116.

The above result may be obtained thus (fig. 116):—

$$x = b + 2d/\sin \beta; \quad (1)$$

$$\Omega = d(b + d \cot \beta); \quad (2)$$

$$\Omega/d^2 = b/d + \cot \beta; \quad (3)$$

From (1) and (2),

$$x = \Omega/d - d \cot \beta + 2d/\sin \beta.$$

This will be a minimum for

$$\begin{aligned} d\Omega/dd &= \Omega/d^2 + \cot \beta - 2d/\sin^2 \beta = 0, \\ \Omega/d^2 &= 2 \operatorname{cosec} \beta - \cot \beta. \end{aligned} \quad (4)$$

or

$$d = \sqrt{\Omega \sin \beta / (2 - \cos \beta)}.$$

or

$$b/d = 2(1 - \cos \beta) / \sin \beta = 2 \tan \frac{1}{2} \beta.$$

Proportions of Channels of Maximum Discharge for given Area and Side Slopes. Depth of channel =  $d$ ; Hydraulic mean depth =  $h$ ; Area of section =  $\Omega$ .

	Inclination of Sides to Horizon.	Ratio of Side Slopes.	Area of Section $\Omega$ .	Bottom Width.	Top width = twice length of each Side Slope.
Semicircle	60° 0'	3 : 5	1.571d <sup>2</sup>	0	2d
Semi-hexagon	60° 0'	3 : 5	1.732d <sup>2</sup>	1.155d	2.310d
Semi-square	90° 0'	0 : 1	2d <sup>2</sup>	2d	2d
	75° 58'	1 : 4	1.812d <sup>2</sup>	1.562d	2.062d
	63° 26'	1 : 2	1.736d <sup>2</sup>	1.236d	2.236d
	53° 8'	3 : 4	1.750d <sup>2</sup>	$d$	5.00d
	45° 0'	1 : 1	1.828d <sup>2</sup>	0.828d	2.828d
	38° 40'	1 1/2 : 1	1.952d <sup>2</sup>	0.702d	3.202d
	33° 42'	1 : 1	2.106d <sup>2</sup>	0.606d	3.606d
	29° 44'	1 : 1	2.282d <sup>2</sup>	0.532d	4.032d
	26° 34'	2 : 1	2.472d <sup>2</sup>	0.472d	4.472d
	23° 58'	2 : 1	2.674d <sup>2</sup>	0.424d	4.924d
	21° 48'	2 1/2 : 1	2.885d <sup>2</sup>	0.385d	5.385d
	19° 58'	3 : 1	3.104d <sup>2</sup>	0.354d	5.854d
	18° 26'	3 : 1	3.325d <sup>2</sup>	0.325d	6.325d

Half the top width is the length of each side slope. The wetted perimeter is the sum of the top and bottom widths.

§ 114. Form of Cross Section of Channel in which the Mean Velocity is Constant with Varying Discharge.—In designing waste channels from canals, and in some other cases, it is desirable that the mean velocity should be restricted within narrow limits with very different volumes of discharge. In channels of trapezoidal form the velocity increases and diminishes with the discharge. Hence when the discharge is large there is danger of erosion, and when it is small of silting or obstruction by weeds. A theoretical form of section for which the mean velocity would be constant can be found, and, although this is not very suitable for practical purposes, it can be more or less approximated to in actual channels.

Let fig. 117 represent the cross section of the channel. From the symmetry of the section, only half the channel need be considered.

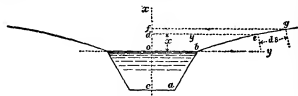

Scale 1/8 Inch = 1 Foot.

FIG. 117.

Let  $obac$  be any section suitable for the minimum flow, and let it be required to find the curve  $beg$  for the upper part of the channel so that the mean velocity shall be constant. Take  $o$  as origin of coordinates, and let  $de, fg$  be two levels of the water above  $ob$ .

Let  $ob = b/2$ ;  $de = y$ ;  $fg = y + dy$ ,  $od = x$ ,  $oe = x + dx$ ;  $eg = ds$ .

The condition to be satisfied is that

$$v = c \sqrt{(m)}$$

should be constant, whether the water-level is at  $ob, de, or fg$ . Consequently

$$m = \text{constant} = k$$

for all three sections, and can be found from the section  $obac$ . Hence also

$$\frac{\text{Increment of section}}{\text{Increment of perimeter}} = \frac{ydx}{ds} = k.$$

$$y^2 dx^2 = k^2 ds^2 = k^2 (dx^2 + dy^2) \text{ and } dx = k dy / \sqrt{(y^2 - k^2)}.$$

Integrating,

$$x = k \log_e \{y + \sqrt{(y^2 - k^2)}\} + \text{constant};$$

and, since  $y = b/2$  when  $x = 0$ ,

$$x = k \log_e \{y + \sqrt{(y^2 - k^2)}\} / \{b + \sqrt{(b^2 - k^2)}\}.$$

Assuming values for  $y$ , the values of  $x$  can be found and the curve drawn.

This figure has been drawn for a channel the minimum section of which is a half hexagon on 4 ft. depth. Hence  $k = 2$ ;  $b = 9/2$ ; the rapid flattening of the side slopes is remarkable.

#### STEADY MOTION OF WATER IN OPEN CHANNELS OF VARYING CROSS SECTION AND SLOPE

§ 115. In every stream the discharge of which is constant, or may be regarded as constant for the time considered, the velocity at different places depends on the slope of the bed. Except at certain exceptional points the velocity will be greater as the slope of the bed is greater, and, as the velocity and cross section of the stream vary inversely, the section of the stream will be least where the

velocity and slope are greatest. If in a stream of tolerably uniform slope an obstruction such as a weir is built, that will cause an alteration of flow similar to that of an alteration of the slope of the bed for a greater or less distance above the weir, and the originally uniform cross section of the stream will become a varied one. In such cases it is often of much practical importance to determine the longitudinal section of the stream.

The cases now considered will be those in which the changes of velocity and cross section are gradual and not abrupt, and in which the only internal work which needs to be taken into account is that due to the friction of the stream bed, as in cases of uniform motion. Further, the motion will be supposed to be steady, the mean velocity at each given cross section remaining constant, though it varies from section to section along the course of the stream.

Let fig. 118 represent a longitudinal section of the stream,  $A_0 A_1$  being the water surface,  $B_0 B_1$  the stream bed. Let  $A_0 B_0, A_1 B_1$  be

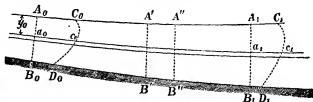

FIG. 118.

cross sections normal to the direction of flow. Suppose the mass of water  $A_0 B_0 A_1 B_1$  comes in a short time  $\theta$  to  $C_0 D_0 C_1 D_1$ , and let the work done on it be made equivalent to its change of kinetic energy during that period. Let  $l$  be the length  $A_0 A_1$  of the portion of the stream considered, and  $z$  the fall of surface level in that distance. Let  $Q$  be the discharge of the stream per second.

Change of Kinetic Energy.—At the end of the time  $\theta$  there are as many particles possessing the same velocities in the space  $C_0 D_0 A_1 B_1$  as at the beginning. The change of kinetic energy is therefore the difference of the kinetic energies of  $A_0 B_0 C_0 D_0$  and  $A_1 B_1 C_1 D_1$ .

Let fig. 119 represent the cross section  $A_0 B_0$ , and let  $\omega$  be a small element of its area at a point where the velocity is  $v$ . Let  $\Omega$  be the whole area of the cross section and  $u_0$  the mean velocity for the whole cross section. From the definition of mean velocity we have

$$u_0 = \Sigma \omega v / \Omega_0.$$

Let  $v = u_0 + w$ , where  $w$  is the difference between the velocity at the small element  $\omega$  and the mean velocity. For the whole cross section,  $\Sigma w = 0$ .

The mass of fluid passing through the element of section  $\omega$ , in  $\theta$  seconds, is  $(G/\theta)\omega\theta$ , and its kinetic energy is  $(G/\theta)\omega\theta^3$ . For the whole section, the kinetic energy of the mass  $A_0 B_0 C_0 D_0$  passing in  $\theta$  seconds is

$$\begin{aligned} (G/\theta) \Sigma \omega u_0^3 &= (G/\theta) \Sigma \omega (u_0^3 + 3u_0^2 w + 3u_0 w^2 + w^3), \\ &= (G/\theta) \Sigma \omega (u_0^3 + \Sigma w^2 (3u_0 + w^2)). \end{aligned}$$

The factor  $3u_0 + w$  is equal to  $2u_0 + v$ , a quantity necessarily positive. Consequently  $\Sigma w^2 > \Omega_0 w^2$ , and consequently the kinetic energy of  $A_0 B_0 C_0 D_0$  is greater than

$$(G/\theta) \Sigma \Omega_0 u_0^3 \text{ or } (G/\theta) \Sigma Q u_0^3,$$

which would be its value if all the particles passing the section had the same velocity  $u_0$ . Let the kinetic energy be taken at

$$a (G/\theta) \Sigma \Omega_0 u_0^3 = a (G/\theta) \Sigma Q u_0^3,$$

where  $a$  is a corrective factor, the value of which was estimated by J. B. C. J. Bélanger at 1.1. Its precise value is not of great importance.

In a similar way we should obtain for the kinetic energy of  $A_1 B_1 C_1 D_1$  the expression

$$a (G/\theta) \Sigma \Omega_1 u_1^3 = a (G/\theta) \Sigma Q u_1^3,$$

where  $\Omega_1, u_1$  are the section and mean velocity at  $A_1 B_1$ , and where  $a$  may be taken to have the same value as before without any important error.

Hence the change of kinetic energy in the whole mass  $A_0 B_0 A_1 B_1$  in  $\theta$  seconds is

$$a (G/\theta) \Sigma Q (u_1^3 - u_0^3). \quad (1)$$

Motion Work of the Weight and Pressures.—Consider a small filament  $a_0 a_1$  which comes in  $\theta$  seconds to  $c_0 c_1$ . The work done by gravity during that movement is the same as if the portion  $a_0 a_1$  were carried to  $a_1 c_1$ . Let  $dQ$  be the volume of  $a_0 a_1$  or  $a_1 c_1$ , and  $y_0, y_1$  the depths of  $a_0, a_1$  from the surface of the stream. Then the volume

<sup>1</sup> Boussinesq has shown that this mode of determining the corrective factor  $a$  is not satisfactory.

$dQ\theta$  or  $GdQ\theta$  pounds falls through a vertical height  $z+y_1-y_2$ , and the work done by gravity is

$$GdQ\theta(z+y_1-y_2).$$

Putting  $p_a$  for atmospheric pressure, the whole pressure per unit of area at  $a_0$  is  $Gy_0+p_a$ , and that at  $a_1$  is  $-(Gy_1+p_a)$ . The work of these pressures is

$$G(y_0+p_a/G-y_1-p_a/G)dQ\theta = G(y_0-y_1)dQ\theta.$$

Adding this to the work of gravity, the whole work is  $GzdQ\theta$ ; or, for the whole cross section,

$$Gz\Omega\theta. \quad (2)$$

Work expended in Overcoming the Friction of the Stream Bed.—Let  $A'B'$ ,  $A''B''$  be two cross sections at distances  $s$  and  $s+ds$  from  $A_0B_0$ . Between these sections the velocity may be treated as uniform, because by hypothesis the changes of velocity from section to section are gradual. Hence, to this short length of stream the equation for uniform motion is applicable. But in that case the work in overcoming the friction of the stream bed between  $A'B'$  and  $A''B''$  is

$$GQ\theta f(u^2/2g)(\chi/\Omega)ds,$$

where  $u$ ,  $\chi$ ,  $\Omega$  are the mean velocity, wetted perimeter, and section at  $A'B'$ . Hence the whole work lost in friction from  $A_0B_0$  to  $A_1B_1$  will be

$$GQ\theta \int_s^l f(u^2/2g)(\chi/\Omega)ds. \quad (3)$$

Equating the work given in (2) and (3) to the change of kinetic energy given in (1)

$$\frac{a(GQ\theta/2g)(u_1^2-u_0^2)}{2} = Gz\theta\Omega - GQ\theta \int_s^l f(u^2/2g)(\chi/\Omega)ds;$$

$$\therefore z = a(u_1^2-u_0^2)/2g + \int_s^l f(u^2/2g)(\chi/\Omega)ds.$$

§ 116. *Fundamental Differential Equation of Steady Varied Motion.*—Suppose the equation just found to be applied to an indefinitely short length  $ds$  of the stream, limited by the end sections  $ab$ ,  $a_1b_1$ , taken for simplicity normal to the stream bed (fig. 120). For that short length of stream the fall of surface level, or difference of level of

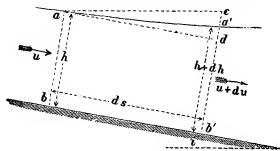

FIG. 120.

$a$  and  $a_1$ , may be written  $ds$ . Also, if we write  $u$  for  $u_0$ , and  $u+du$  for  $u_1$ , the term  $(u_1^2-u_0^2)/2g$  becomes  $udu/g$ . Hence the equation applicable to an indefinitely short length of the stream is

$$dz = udu/g + (\chi/\Omega) f(u^2/2g)ds. \quad (1)$$

From this equation some general conclusions may be arrived at as to the form of the longitudinal section of the stream, but, as the investigation is somewhat complicated, it is convenient to simplify it by restricting the conditions of the problem.

*Modification of the Formula for the Restricted Case of a Stream flowing in a Prismatic Stream Bed of Constant Slope.*—Let  $i$  be the constant slope of the bed. Draw  $ad$  parallel to the bed, and  $ac$  horizontal. Then  $ds$  is sensibly equal to  $a'd'$ . The depths of the stream,  $h$  and  $h+dh$ , are sensibly equal to  $ab$  and  $a'b'$ , and therefore  $dh = a'd'$ . Also  $cd$  is the fall of the bed in the distance  $ds$ , and is equal to  $ids$ . Hence

$$dz = a'd' - cd - a'd' = ids - dh. \quad (2)$$

Since the motion is steady—

$$Q = \Omega u = \text{constant.}$$

Differentiating,

$$\Omega du + u d\Omega = 0;$$

$$\therefore du = -u d\Omega/\Omega.$$

Let  $x$  be the width of the stream, then  $d\Omega = xdh$  very nearly. Inserting this value,

$$du = -(ux/\Omega)dh. \quad (3)$$

Putting the values of  $du$  and  $ds$  found in (2) and (3) in equation (1),

$$ids - dh = -(\chi x/\Omega) f(u^2/2g)dh + (\chi/\Omega) f(u^2/2g)ds.$$

Further Restriction to the Case of a Stream of Rectangular Section and of Indefinite Width.—The equation might be discussed in the form just given, but it becomes a little simpler if restricted in the way just stated. For, if the stream is rectangular,  $xh = \Omega$ , and if  $x$  is large compared with  $h$ ,  $\Omega/x = sh/x = h$  nearly. Then equation (4) becomes

$$dh/ds = i(1 - f(u^2/2g)h)/(1 - u^2/g)h. \quad (5)$$

§ 117. *General Indications as to the Form of Water Surface furnished by Equation (5).*—Let  $A_0A_1$  (fig. 121) be the water surface,

$B_0B_1$  the bed in a longitudinal section of the stream, and  $ab$  any section at a distance  $s$  from  $B_0$ , the depth  $ab$  being  $h$ . Suppose  $B_0B_1$ ,  $B_0A_1$  taken as rectangular coordinate axes, then  $dh/ds$  is the trigonometric tangent of the angle which the surface of the stream at  $a$  makes with the axis  $B_0B_1$ . This tangent  $dh/ds$  will be positive, if the stream is increasing in depth in the direction  $B_0B_1$ ; negative,

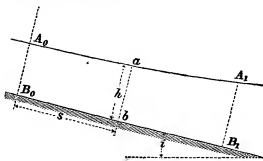

FIG. 121.

if the stream is diminishing in depth from  $B_0$  towards  $B_1$ . If  $dh/ds = 0$  the surface of the stream is parallel to the bed, as in cases of uniform motion. But from equation (4)

$$dh/ds = 0, \text{ if } i - (\chi/\Omega) f(u^2/2g) = 0;$$

$$\therefore f(u^2/2g) = (\Omega/\chi) i = m_1,$$

which is the well-known general equation for uniform motion, based on the same assumptions as the equation for varied steady motion now being considered. The case of uniform motion is therefore a limiting case between two different kinds of varied motion.

Consider the possible changes of value of the fraction

$$(1 - f(u^2/2g)h)/(1 - u^2/g)h.$$

As  $h$  tends towards the limit  $0$ , and consequently  $u$  is large, the numerator tends to the limit  $-\infty$ . On the other hand if  $h = \infty$ , in which case  $u$  is small, the numerator becomes equal to  $1$ . For a value  $H$  of  $h$  given by the equation

$$1 - f(u^2/2g)H = 0,$$

$$H = u^2/2g,$$

we fall upon the case of uniform motion. The results just stated may be tabulated thus:—

$$\text{For } h = 0, H, > H, \infty,$$

the numerator has the value  $-\infty, 0, > 0, 1$ .

Next consider the denominator. If  $h$  becomes very small, in which case  $u$  must be very large, the denominator tends to the limit  $-\infty$ . As  $h$  becomes very large and  $u$  consequently very small, the denominator tends to the limit  $1$ . For  $h = u^2/g$ , or  $u = \sqrt{gh}$ , the denominator becomes zero. Hence, tabulating these results as before:—

$$\text{For } h = 0, u^2/g, > u^2/g, \infty,$$

the denominator becomes  $-\infty, 0, > 0, 1$ .

§ 118. *Case 1.*—Suppose  $h > u^2/g$ , and also  $h > H$ , or the depth greater than that corresponding to uniform motion. In this case  $dh/ds$  is positive, and the stream increases in depth in the direction of flow. In fig. 122 let  $B_0B_1$  be the bed,  $C_0C_1$  a line parallel to the bed and at a height above it equal to  $H$ . By hypothesis, the surface

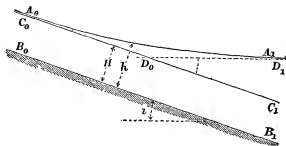

FIG. 122.

$A_0A_1$  of the stream is above  $C_0C_1$ , and it has just been shown that the depth of the stream increases from  $B_0$  towards  $B_1$ . But going up stream  $dh/ds$  approaches more and more nearly the value  $1$ , and therefore  $dh/ds$  approaches the limit  $0$ , or the surface of the stream is asymptotic to  $C_0C_1$ . Going down stream  $h$  increases and  $u$  diminishes, the numerator and denominator of the fraction  $(1 - f(u^2/2g)h)/(1 - u^2/g)h$  both tend towards the limit  $1$ , and  $dh/ds$  to the limit  $1$ . That is, the surface of the stream tends to become asymptotic to a horizontal line  $D_0D_1$ .

The form of water surface here discussed is produced when the flow of a stream originally uniform is altered by the construction of a weir. The raising of the water surface above the level  $C_0C_1$  is termed the backwater due to the weir.

§ 119. *Case 2.*—Suppose  $h > u^2/g$ , and also  $h < H$ . Then  $dh/ds$  is

negative, and the stream is diminishing in depth in the direction of flow. In fig. 123 let  $B_0B_1$  be the stream bed as before;  $C_0C_1$  a line drawn parallel to  $B_0B_1$  at a height above it equal to  $H$ . By hypothesis the surface  $A_0A_1$  of the stream is below  $C_0C_1$ , and the depth has just been shown to diminish from  $B_0$  towards  $B_1$ . Going up stream  $h$  approaches the limit  $H$ , and  $dh/ds$  tends to the limit zero. That is, up stream  $A_0A_1$  is asymptotic to  $C_0C_1$ . Going down stream  $h$  diminishes and  $u$  increases; the

inequality  $h > u^2/g$  diminishes; the denominator of the fraction  $(1 - \zeta u^2/2gi)/(1 - u^2/gb)$  tends to the limit zero, and consequently  $dh/ds$  tends to  $\infty$ . That is, down stream  $A_0A_1$  tends to a direction perpendicular to the bed. Before, however, this limit was reached the assumptions on which the general equation is based would cease to be even approximately true, and the equation would cease to be applicable. The filaments would have a relative motion, which would make the influence of internal friction in the fluid too important to be neglected. A stream surface of this form

may be produced if there is an abrupt fall in the bed of the stream (fig. 124).

On the Ganges canal, as originally constructed, there were abrupt falls precisely of this kind, and it appears

that the lowering of the water surface and increase of velocity which such falls occasion, for a distance of some miles up stream, was not foreseen. The result was that, the velocity above the falls being greater than was intended, the bed was scoured and considerable damage was done to the works. "When the canal was first opened the water was allowed to pass freely over the crests of the overfalls, which were laid on the level of the bed of the earthen channel; erosion of bed and sides for some miles up rapidly followed, and it soon became apparent that means must be adopted for raising the surface of the stream at those points (that is, the crests of the falls). Planks were accordingly fixed in the grooves above the bridge arches, or temporary weirs were formed over which the water was allowed to fall; in some cases the surface of the water was thus raised above its normal height, causing a backwater in the channel above." (Crofton's Report on the Ganges Canal, p. 14). Fig. 125 represents in an exaggerated form what probably occurred, the diagram being intended

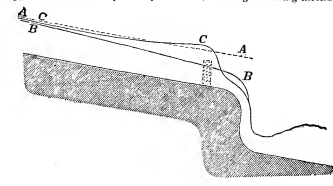

FIG. 125.

to represent some miles' length of the canal bed above the fall.  $AA'$  parallel to the canal bed is the level corresponding to uniform motion with the intended velocity of the canal. In consequence of the presence of the ogee fall, however, the water surface would take some such form as  $BB'$ , corresponding to Case 2 above, and the velocity would be greater than the intended velocity, nearly in the inverse ratio of the actual to the intended depth. By constructing a weir on the crest of the fall, as shown by dotted lines, a new water surface  $CC'$  corresponding to Case 1 would be produced, and by suitably choosing the height of the weir this might be made to agree approximately with the intended level  $AA'$ .

§ 120. Case 3.—Suppose a stream flowing uniformly with a depth  $h < u^2/g$ . For a stream in uniform motion  $\zeta u^2/2g = mi$ , or if the

stream is of indefinitely great width, so that  $m = H$ , then  $\zeta u^2/2g = H$ , and  $H = \zeta u^2/2gi$ . Consequently the condition stated above involves that

$$\zeta u^2/2gi < u^2/g, \text{ or that } i > \zeta/2.$$

If such a stream is interfered with by the construction of a weir which raises its level, so that its depth at the weir becomes  $h_1 > u^2/g$ , then for a portion of the stream the depth  $h$  will satisfy the conditions  $h < u^2/g$  and  $h > H$ , which are not the same as those assumed in the two previous cases. At some point of the stream above the weir the depth  $h$  becomes equal to  $u^2/g$ , and at that point  $dh/ds$  becomes infinite, or the surface of the stream is normal to the bed. It is obvious that at that point the influence of internal friction will be too great to be neglected, and the general equation will cease to represent the true conditions of the motion of the water. It is known that, in cases such as this, there occurs an abrupt rise of the free surface of the stream, or a standing wave is formed, the conditions of motion of which will be examined presently.

It appears that the condition necessary to give rise to a standing wave is that  $i > \zeta/2$ . Now  $\zeta$  depends for different channels on the roughness of the channel and its hydraulic mean depth. Bazin calculated the values of  $\zeta$  for channels of different degrees of roughness and different depths given in the following table, and the corresponding minimum values of  $i$  for which the exceptional case of the production of a standing wave may occur.

Nature of Bed of Stream.	Slope below which a Standing Wave is impossible in feet per foot.	Standing Wave Formed.	
		Slope in feet per foot.	Least Depth in feet.
Very smooth cemented surface	0.00147	0.002	0.262
		0.003	.098
		0.004	.065
Ashlar or brickwork	0.00186	0.003	.394
		0.004	.197
		0.006	.098
Rubble masonry	0.00235	0.004	1.181
		0.006	.525
		0.010	.262
Earth	0.00275	0.006	3.478
		0.010	1.542
		0.015	.919

## STANDING WAVES

§ 121. The formation of a standing wave was first observed by Bidone. Into a small rectangular masonry channel, having a slope of 0.023 ft. per foot, he admitted water till it flowed uniformly with a depth of 0.2 ft. He then placed a plank across the stream which raised the level just above the obstruction to 0.95 ft. He found that the stream above the obstruction was sensibly unaffected up to a point 15 ft. from it. At that point the depth suddenly increased from 0.2 ft. to 0.56 ft. The velocity of the stream in the part unaffected by the obstruction was 5.54 ft. per second. Above the point where the abrupt change of depth occurred  $u^2 = 5.54^2 = 30.7$ , and  $gh = 32.2 \times 0.2 = 6.44$ ; hence  $u^2$  was  $> gh$ . Just below the abrupt change of depth  $u = 5.54 \times 0.2/0.56 = 1.97$ ;  $u^2 = 3.88$ ; and  $gh = 32.2 \times 0.56 = 18.03$ ; hence at this point  $u^2 < gh$ . Between these two points, therefore,  $u^2 = gh$ ; and the condition for the production of a standing wave occurred.

The change of level at a standing wave may be found thus. Let fig. 126 represent the longitudinal section of a stream and  $ab, cd$

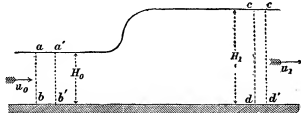

FIG. 126.

cross sections normal to the bed, which for the short distance considered may be assumed horizontal. Suppose the mass of water  $abcd$  to come to  $a'b'c'd'$  in a short time  $t$ ; and let  $u_0, u_1$  be the velocities at  $ab$  and  $cd, \Omega_0, \Omega_1$  the areas of the cross sections. The force causing change of momentum in the mass  $abcd$  estimated horizontally is simply the difference of the pressures on  $ab$  and  $cd$ . Putting  $h_0, h_1$  for the depths of the centres of gravity of  $abcd$  and measured down from the free water surface, the force is  $G(h_0\Omega_0 - h_1\Omega_1)$  pounds, and the impulse in  $t$  seconds is  $G(h_0\Omega_0 - h_1\Omega_1)t$  second pounds. The horizontal change of momentum is the difference of the momenta of  $cd c'd'$  and  $aba'b'$ ; that is,

$$(G/g)(\Omega_1 u_1^2 - \Omega_0 u_0^2)t.$$



Hence, equating impulse and change of momentum,

$$C(Gh_0\Omega_0 - h_0\Omega_0) = (G/g^2)(\Omega_1 u_1^2 - \Omega_0 u_0^2);$$

$$\therefore h_0\Omega_0 = h_0\Omega_0 + (\Omega_1 u_1^2 - \Omega_0 u_0^2)/g. \quad (1)$$

For simplicity let the section be rectangular, of breadth  $B$  and depths  $H_0$  and  $H_1$ , at the two cross sections considered; then  $h_0 = \frac{1}{2}H_0$  and  $h_1 = \frac{1}{2}H_1$ . Hence

$$H_0^2 - H_1^2 = (2/g)(H_1 u_1^2 - H_0 u_0^2).$$

But, since  $\Omega_0 u_0 = \Omega_1 u_1$ , we have

$$u_1^2 = u_0^2 H_0^2 / H_1^2,$$

$$H_0^2 - H_1^2 = (2u_0^2/g)(H_0^2/H_1 - H_0). \quad (2)$$

This equation is satisfied if  $H_0 = H_1$ , which corresponds to the case of uniform motion. Dividing by  $H_0 - H_1$ , the equation becomes

$$(H_0/H_1)(H_0 + H_1) = 2u_0^2/g; \quad (3)$$

$$\therefore H_1 = \sqrt{(2gu_0^2/g) + \frac{1}{4}H_0} - \frac{1}{2}H_0. \quad (4)$$

In Bidone's experiment  $u_0 = 5.54$ , and  $H_0 = 0.2$ . Hence  $H_1 = 0.52$ , which agrees very well with the observed height.

§ 122. A standing wave is frequently produced at the foot of a weir. Thus in the ogee falls originally constructed on the Ganges canal a standing wave was observed as shown in fig. 127. The water falling over the weir crest  $A$  acquired a very high velocity on the

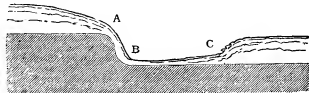

FIG. 127.

steep slope  $AB$ , and the section of the stream at  $B$  became very small. It easily happened, therefore, that at  $B$  the depth  $h < u^2/g$ . In flowing along the rough apron of the weir the velocity  $u$  diminished and the depth  $h$  increased. At a point  $C$ , where  $h$  became equal to  $u^2/g$ , the conditions for producing the standing wave occurred. Beyond  $C$  the free surface abruptly rose to the level corresponding to uniform motion with the assigned slope of the lower reach of the canal.

A standing wave is sometimes formed on the down stream side of bridges the piers of which obstruct the flow of the water. Some interesting cases of this kind are described in a paper on the "Floods in the Nerbudda Valley" in the *Proc. Inst. Civ. Eng.* vol. xxvii. p. 222, by A. C. Howden. Fig. 128 is compiled from the data given in that paper. It represents the section of the stream at pier 8 of the Towah Viaduct, during the flood of 1865. The ground level is not exactly given by Howden, but has been inferred from data given on another drawing. The velocity of the stream was not observed, but the author states it was probably the same as at the Gunjal river during a similar flood, that is 16.58 ft. per second. Now, taking the depth on the down stream face of the pier at 26 ft., the velocity necessary for the production of a standing wave would be  $u = \sqrt{gh} = \sqrt{(32.2 \times 26)} = 29$  ft. per second nearly. But the velocity at this

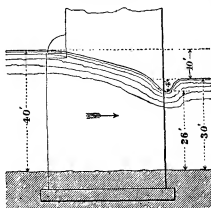

FIG. 128.

point was probably from Howden's statements  $16.58 \times \frac{2}{3} = 23.5$  ft., an agreement as close as the approximate character of the data would lead us to expect.

## XI. ON STREAMS AND RIVERS

§ 123. *Catchment Basin.*—A stream or river is the channel for the discharge of the available rainfall of a district, termed its catchment basin. The catchment basin is surrounded by a ridge or watershed line, continuous except at the point where the river finds an outlet. The area of the catchment basin may be determined from a suitable contoured map on a scale of at least 1 in 100,000. Of the whole rainfall on the catchment basin, a part only finds its way to the stream. Part is directly re-evaporated, part is absorbed by vegetation, part may escape by percolation into neighbouring districts. The following table gives the relation of the average stream discharge to the average rainfall on the catchment basin (Tiefenbacher).

	Ratio of average Discharge to average Rainfall.	Loss by Evaporation, &c., in per cent of total Rainfall.
Cultivated land and spring-forming declivities . . .	.3 to .33	67 to 70
Wooded hills slopes . . .	.35 to .45	55 to 65
Naked inflexible mountains	.55 to 1.60	40 to 45

§ 124. *Flood Discharge.*—The flood discharge can generally only be determined by examining the greatest height to which floods have been known to rise. To produce a flood the rainfall must be heavy and widely distributed, and to produce a flood of exceptional height the duration of the rainfall must be so great that the flood waters of the most distant affluents reach the point considered, simultaneously with those from nearer points. The larger the catchment basin the less probable is it that all the conditions tending to produce a maximum discharge should simultaneously occur. Further, lakes and the river bed itself act as storage reservoirs during the rise of water level and diminish the rate of discharge, or serve as flood moderators. The influence of these is often important, because very heavy rain storms are in most countries of comparatively short duration. Tiefenbacher gives the following estimate of the flood discharge of streams in Europe:—

	Flood discharge of Streams per Second per Square Mile of Catchment Basin.
In flat country . . . . .	8.7 to 12.5 cub. ft.
In hilly districts . . . . .	17.5 to 22.5 "
In moderately mountainous districts	36.2 to 45.0 "
In very mountainous districts . . .	50.0 to 75.0 "

It has been attempted to express the decrease of the rate of flood discharge with the increase of extent of the catchment basin by empirical formulae. Thus Colonel P. P. L. O'Connell proposed the formula  $y = M\sqrt{x}$ , where  $M$  is a constant called the modulus of the river, the value of which depends on the amount of rainfall, the physical characters of the basin, and the extent to which the floods are moderated by storage of the water. If  $M$  is small for any given river, it shows that the rainfall is small, or that the permeability or slope of the sides of the valley is such, or that the water does not drain rapidly to the river, or that lakes and river bed moderate the rise of the floods. If values of  $M$  are known for a number of rivers, they may be used in inferring the probable discharge of other similar rivers. For British rivers  $M$  varies from 0.43 for a small stream draining meadow land to 37 for the Tyne. Generally it is about 15 or 20. For large European rivers  $M$  varies from 16 for the Seine to 67.5 for the Danube. For the Nile  $M = 11$ , a low value which results from the immense length of the Nile throughout which it receives no affluent, and probably also from the influence of lakes. For different tributaries of the Mississippi  $M$  varies from 13 to 56. For various Indian rivers it varies from 40 to 303, this variation being due to the great variations of rainfall slope and character of Indian rivers.

In some of the tank projects in India, the flood discharge has been calculated from the formula  $D = C\sqrt{A}^2$ , where  $D$  is the discharge in cubic yards per hour from  $n$  square miles of basin. The constant  $C$  was taken = 61,523 in the designs for the Ekrooka tank, = 75,000 on Ganges and Godavery works, and = 10,000 on Madras works.

§ 125. *Action of a Stream on its Bed.*—If the velocity of a stream exceeds a certain limit, depending on its size, and on the size, heaviness, form and coherence of the material of which its bed is composed, it scours its bed and carries forward the materials. The quantity of material which a given stream can carry in suspension depends on the size and density of the particles in suspension, and is greater as the velocity of the stream is greater. If in one part of its course the velocity of a stream is great enough to scour the bed and the water becomes loaded with silt, and in a subsequent part of the river's course the velocity is diminished, then part of the transported material must be deposited. Probably deposit and scour go on simultaneously over the whole river bed, but in some parts the rate of scour is in excess of the rate of deposit, and in other parts the rate of deposit is in excess of the rate of scour. Deep streams appear to have the greatest scouring power at any given velocity. It is possible that the difference is strictly a difference of transporting, not of scouring action. Let fig. 129 represent a section of a stream. The material lifted at  $a$  will be diffused through the mass of the stream and deposited at different distances down stream. The average path of a particle lifted at  $a$  will be some such curve as

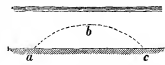

FIG. 129.

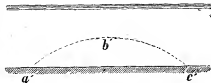

FIG. 130.

and the average distance of transport each time a particle is lifted

will be represented by  $ac$ . In a deeper stream such as that in fig. 130, the average height to which particles are lifted, and, since the rate of vertical fall through the water may be assumed the same as before, the average distance  $a^2c$  of transport will be greater. Consequently, although the scouring action may be identical in the two streams, the velocity of transport of material down stream is greater as the depth of the stream is greater. The effect is that the deep stream excavates its bed more rapidly than the shallow stream.

§ 126. *Bottom Velocity at which Scour commences.*—The following bottom velocities were determined by P. L. G. Dubaut to be the maximum velocities consistent with stability of the stream bed for different materials.

Darcy and Bazin give, for the relation of the mean velocity  $v_m$  and bottom velocity  $v_b$ .

$$v_m = v_b + 10.87\sqrt{(v_b)}$$

But

$$\sqrt{mi} = v_b \sqrt{(g/2g)}$$

$$\therefore v_m = v_b(1 + 10.87\sqrt{(g/2g)})$$

Taking a mean value for  $g$ , we get

$$v_m = 1.312v_b$$

and from this the following values of the mean velocity are obtained:—

	Bottom Velocity $=v_b$	Mean Velocity $=v_m$
1. Soft earth . . . . .	0.25	.33
2. Loam . . . . .	0.50	.65
3. Sand . . . . .	1.00	1.30
4. Gravel . . . . .	2.00	2.62
5. Pebbles . . . . .	3.40	4.46
6. Broken stone, flint . . . . .	4.00	5.25
7. Chalk, soft shale . . . . .	5.00	6.56
8. Rock in beds . . . . .	6.00	7.87
9. Hard rock . . . . .	10.00	13.12

The following table of velocities which should not be exceeded in channels is given in the *Ingenieurs Taschenbuch* of the Verein "Hütte":—

	Surface Velocity.	Mean Velocity.	Bottom Velocity.
Slimy earth or brown clay . . . . .	.49	.36	.26
Clay . . . . .	.98	.75	.52
Firm sand . . . . .	1.97	1.51	1.02
Pebbly bed . . . . .	4.00	3.15	2.30
Boulder bed . . . . .	5.00	4.03	3.08
Commerate of slaty fragments . . . . .	7.28	6.10	4.90
Seriated rocks . . . . .	8.00	7.45	6.00
Hard rocks . . . . .	14.00	12.15	10.36

§ 127. *Regime of a River Channel.*—A river channel is said to be in a state of regime, or stability, when it changes little in draught or form in a series of years. In some rivers the deepest part of the channel changes its position perpetually, and is seldom found in the same place in two successive years. The sinuousness of the river also changes by the erosion of the banks, so that at time the position of the river is completely altered. In other rivers the change from year to year is very small, but probably the regime is never perfectly stable except where the rivers flow over a rocky bed.

If a river had a constant discharge it would gradually modify its bed till a permanent regime was established. But as the volume

happen if by artificial means the erosion of the banks is prevented. If a river flows in soil incapable of resisting its tendency to scour it is necessarily sinuous (§ 107), for the slightest deflection of the current to either side begins an erosion which increases progressively till a considerable bend is formed. If such a river is straightened it becomes sinuous again unless its banks are protected from scour.

§ 128. *Longitudinal Section of River Bed.*—The declivity of rivers decreases from source to mouth. In their higher parts rapid and torrential, flowing over beds of gravel or boulders, they enlarge in volume by receiving affluent streams, their slope diminishes, their bed consists of smaller materials, and finally they reach the sea. Fig. 131 shows the length in miles, and the surface fall in feet per mile, of the Tyne and its tributaries.

The decrease of the slope is due to two causes. (1) The action of the transporting power of the water, carrying the smallest debris the greatest distance, causes the bed to be less stable near the mouth than in the higher parts of the river; and, as the river adjusts its slope to the stability of the bed by scouring or increasing its sinuousness when the slope is too great, and by silting or straightening its course if the slope is too small, the decreasing stability of the bed would coincide with a decreasing slope. (2) The increase of volume and section of the river leads to a decrease of slope; for the larger the section the less slope is necessary to ensure a given velocity.

The following investigation, though it relates to a purely arbitrary case, is not without interest. Let it be assumed, to make the conditions definite—(1) that a river flows over a bed of uniform resistance to scour, and let it be further assumed that to maintain stability the velocity of the river in these circumstances is constant from source to mouth; (2) suppose the sections of the river at all points are similar, so that,  $b$  being the breadth of the river at any point, its hydraulic mean depth is  $ab$  and its section is  $ab^2$ , where  $a$  and  $c$  are constants applicable to all parts of the river; (3) let us further assume that the discharge increases uniformly in consequence of the supply from affluents, so that, if  $l$  is the length of the river from its source to any given point, the discharge there will be  $kl$ , where  $k$  is another constant applicable to all points in the course of the river.

Let AB (fig. 132) be the longitudinal section of the river, whose source is at A; and take A for the origin of vertical and horizontal coordinates. Let C be a point whose ordinates are  $x$  and  $y$ , and let the river at C have the breadth  $b$ , the slope  $i$ , and the velocity  $v$ .

Since velocity  $\propto$  area of section = discharge,  $cb^2 = kl$ , or  $b = \sqrt{(kl/cv)}$ . Hydraulic mean depth =  $ab = \sqrt{(kl/cv)}$ .

But, by the ordinary formula for the flow of rivers,  $mi = v^2i^2$ ;

$$\therefore i = v^2/m = (v^2/a^2)\sqrt{(c/kl)}$$

But  $i$  is the tangent of the angle which the curve at C makes with the axis of X, and is therefore  $dy/dx$ . Also, as the slope is small,  $l = AC = AD = x$  nearly.

$$\therefore dy/dx = (v^2/a^2)\sqrt{(c/kx)}$$

and, remembering that  $v$  is constant,

$$y = (2v^2/a^2)\sqrt{(cx/k)}$$

or

$$y^2 = \text{constant} \times x;$$

so that the curve is a common parabola, of which the axis is horizontal and the vertex at the source. This may be considered an ideal longitudinal section, to which actual rivers approximate more or less, with exceptions due to the varying hardness of their beds, and the irregular manner in which their volume increases.

§ 129. *Surface Level of River.*—The surface level of a river is a plane changing constantly in position from changes in the volume of water discharged, and more slowly from changes in the river bed, and the circumstances affecting the drainage into the river.

For the purposes of the engineer, it is important to determine (1) the extreme low water level, (2) the extreme high water or flood level, and (3) the highest navigable level.

1. *Low Water Level* cannot be absolutely known, because a river reaches its lowest level only at rare intervals, and because alterations in the cultivation of the land, the drainage, the removal of forests, the removal or erection of obstructions in the river bed, &c., gradually alter the conditions of discharge. The lowest level of which records can be found is taken as the conventional or approximate low water level, and allowance is made for possible changes.

2. *High Water or Flood Level.*—The engineer assumes as the highest flood level the highest level of which records can be obtained. In forming a judgment of the data available, it must be remembered that the highest level at one point of a river is not always simultaneous

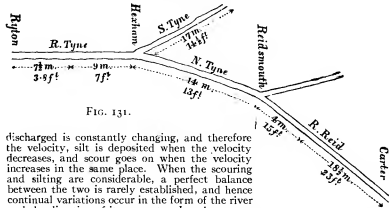

FIG. 131.

discharged is constantly changing, and therefore the velocity, silt is deposited when the velocity decreases, and scour goes on when the velocity increases in the same place. When the scouring and silting are considerable, a perfect balance between the two is rarely established, and hence continual variations occur in the form of the river and the direction of its currents. In other cases, where the action is less violent, a tolerable balance may be established, and the deepening of the bed by scour at one time is compensated by the silting at another. In that case the general regime is permanent, though alteration is constantly going on. This is more likely to

with the attainment of the highest level at other points, and that the rise of a river in flood is very different in different parts of its course. In temperate regions, the floods of rivers seldom rise more than 2 to 6 ft. above low-water level, but in the tropics the rise of floods is greater.

3. *Highest Navigable Level.*—When the river rises above a certain level, navigation becomes difficult from the increase of the velocity of the current, or from submergence of the tow paths, or from the headway under bridges becoming insufficient. Ordinarily the highest navigable level may be taken to be that at which the river begins to overflow its banks.

§ 130. *Relative Value of Different Materials for Submerged Works.*—That the power of water to remove and transport different materials depends on their density has an important bearing on the selection of materials for submerged works. In many cases, as in the aprons or floorings beneath bridges, or in front of locks or falls, and in the formation of training walls and breakwaters by *pierres perdues*, which have to resist a violent current, the materials of which the structures are composed should be of such a size and weight as to be able individually to resist the scouring action of the water. The heaviest materials will therefore be the best; and the different value of materials in this respect will appear much more striking, if it is remembered that all materials lose part of their weight in water. A block whose volume is  $V$  cubic feet, and whose density in air is  $w$  lb per cubic foot, weighs in air  $wV$  lb, but in water only  $(w-62.4)V$  lb.

	Weight of a Cub. Ft. in lb.	
	In Air.	In Water.
Basalt . . . . .	187.3	124.9
Brick . . . . .	130.0	67.6
Brickwork . . . . .	112.0	49.6
Granite and limestone . . . . .	170.0	107.6
Sandstone . . . . .	144.0	81.6
Masonry . . . . .	116-144	53.6-81.6

§ 131. *Inundation Deposits from a River.*—When a river carrying silt periodically overflows its banks, it deposits silt over the area flooded, and gradually raises the surface of the country. The silt is deposited in greatest abundance where the water first leaves the river. It hence results that the section of the country assumes a peculiar form, the river flowing in a trough along the crest of a ridge, from which the land slopes downwards on both sides. The silt deposited from the water forms two wedges, having their thick ends towards the river (fig. 133).



FIG. 133.

This is strikingly the case with the Mississippi, and that river is now kept from flooding immense areas by artificial embankments or levees. In India, the term *deltic segment* is sometimes applied to that portion of a river running through deposits formed by inundation, and having this characteristic section. The irrigation of the country in this case is very easy; a comparatively slight raising of the river surface by a weir or anicut gives a command of level which permits the water to be conveyed to any part of the district.

§ 132. *Deltas.*—The name delta was originally given to the  $\Delta$ -shaped portion of Lower Egypt, included between seven branches of the Nile. It is now given to the whole of the alluvial tracts round river mouths formed by deposition of sediment from the river, where its velocity is checked on its entrance to the sea. The characteristic feature of these alluvial deltas is that the river traverses them, not in a single channel, but in two or many bifurcating branches. Each branch has a tract of the delta under its influence, and gradually raises the surface of that tract, and extends it seaward. As the delta extends itself seaward, the conditions of discharge through the different branches change. The water finds the passage through one of the branches less obstructed than through the others; the velocity and scouring action in that branch are increased; in the others they diminish. The one channel gradually absorbs the whole of the water supply, while the other branches silt up. But as the mouth of the new main channel extends seaward the resistance increases both from the greater length of the channel and the formation of shoals at its mouth, and the river tends to form new bifurcations AC or AD (fig. 134), and one of these may in time become the main channel of the river.

§ 133. *Field Operations preliminary to a Study of River Improvement.*—There are required (1) a plan of the river, on which the positions of lines of levelling and cross sections are marked; (2) a longitudinal section and numerous cross sections of the river; (3) a series of gaugings of the discharge at different points and in different conditions of the river.

*Longitudinal Section.*—This requires to be carried out with great accuracy. A line of stakes is planted, following the sinuosities of the

river, and chained and levelled. The cross sections are referred to the line of stakes, both as to position and direction. The determination of the surface slope is very difficult, partly from its extreme smallness, partly from oscillation of the water. Cunningham recommends that the slope be taken in a length of 2000 ft. by four simultaneous observations, two on each side of the river.

§ 134. *Cross Sections*—A stake is planted flush with the water, and its level relatively to some point on the line of levels is determined. Then the depth of the water is determined at a series of points (if

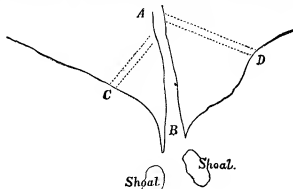

FIG. 134.

possible at uniform distances) in a line starting from the stake and perpendicular to the thread of the stream. To obtain these, a wire may be stretched across with equal distances marked on it by hanging tags. The depth at each of these tags may be obtained by a light wooden staff, with a disk-shaped shoe 4 to 6 in. in diameter. If the depth is great, soundings may be taken by a chain and weight. To ensure the wire being perpendicular to the thread of the stream, it is desirable to stretch two other wires similarly graduated, one above and the other below, at a distance of 20 to 40 yds. A number of floats being then thrown in, it is observed whether they pass the same graduation on each wire.

For large and rapid rivers the cross section is obtained by sounding in the following way. Let AC (fig. 135) be the line on which soundings are required. A base line AB is measured out at right angles to AC, and ranging staves are set up at AB and at D in line with AC. A boat is allowed to drop down stream, and, at the moment it comes in line with AD, the lead is dropped, and an observer in the boat takes, with a box sextant, the angle AEB subtended by AB. The sounding line may have a weight of 14 lb of lead, and, if the boat drops down stream slowly, it may hang near the bottom, so that the observation is made instantly. In extensive surveys of the Mississippi observers with theodolites were stationed at A and B. The theodolite at A was directed towards C, that at B was kept on the boat. When the boat came on the line AC, the observer at A signalled, the sounding line was dropped, and the observer at B read off the angle ABE. By repeating observations a number of soundings are obtained, which can be plotted in their proper position, and the form of the river bed drawn by connecting the extremities of the lines. From the section can be measured the sectional area of the stream  $\Omega$  and its wetted perimeter  $x$ ; and from these the hydraulic mean depth  $m$  can be calculated.

FIG. 135.

§ 135. *Measurement of the Discharge of Rivers.*—The area of cross section multiplied by the mean velocity gives the discharge of the stream. The height of the river with reference to some fixed mark should be noted whenever the velocity is observed, as the velocity and area of cross section are different in different states of the river. To determine the mean velocity various methods may be adopted; and, since no method is free from liability to error, either from the difficulty of the observations or from uncertainty as to the ratio of the mean velocity to the velocity observed, it is desirable that more than one method should be used.

#### INSTRUMENTS FOR MEASURING THE VELOCITY OF WATER

§ 136. *Surface Floats* are convenient for determining the surface velocities of a stream, though their use is difficult near the banks. The floats may be small balls of wood, of wax or of hollow metal, so loaded as to float nearly flush with the water surface. To render

them visible they may have a vertical painted stem. In experiments on the Seine, cork balls  $1\frac{1}{2}$  in. diameter were used, loaded to float flush with the water, and provided with a stem. In A. J. C. Cunningham's observations at Koorkee, the floats were thin circular disks of English deal, 3 in. diameter and  $\frac{1}{4}$  in. thick. For observations near the banks, floats 1 in. diameter and  $\frac{1}{4}$  in. thick were used. To render them visible a tuft of cotton wool was used loosely fixed in a hole at the centre.

The velocity is obtained by allowing the float to be carried down, and noting the time of passage over a measured length of the stream. If  $v$  is the velocity of any float,  $t$  the time of passing over a length  $l$ , then  $v=l/t$ . To mark out distinctly the length of stream over which the floats pass, two ropes may be stretched across the stream at a distance apart, which varies usually from 50 to 250 ft., according to the size and rapidity of the river. In the Koorkee experiments a length of run of 50 ft. was found best for the central two-fifths of the width, and 25 ft. for the remainder, except very close to the banks, where the run was made 12 ft. only. The longer the run the less is the proportionate error of the time observations, but on the other hand the greater the deviation of the floats from a straight course parallel to the axis of the stream. To mark the precise position at which the floats cross the ropes, Cunningham used short white rope pendants, hanging so as nearly to touch the surface of the water, in this case the streams were 80 to 180 ft. in width. In wider streams the use of ropes to mark the length of run is impossible, and recourse must be had to box sextants or theodolites to mark the path of the floats.

Let AB (fig. 136) be a measured base line strictly parallel to the thread of the stream, and AA<sub>1</sub>, BB<sub>1</sub> lines at right angles to AB marked out by ranging rods at A<sub>1</sub> and B<sub>1</sub>.

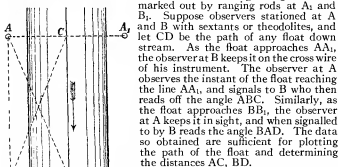

FIG. 136.

Suppose observers stationed at A and B with sextants or theodolites, and let CD be the path of any float down stream. As the float approaches AA<sub>1</sub>, the observer at B keeps it on the cross wire of his instrument. The observer at A observes the instant of the float reaching the line AA<sub>1</sub>, and signals to B who then reads off the angle ABC. Similarly, as the float approaches BB<sub>1</sub>, the observer at A keeps it in sight, and when signalled to by B reads the angle BAD. The data so obtained are sufficient for plotting the path of the float and determining the distances AC, BD. The time taken by the float in passing over the measured distance may be observed by a chronograph, started as the float passes the upper rope or line, and stopped when it passes the lower. In Cunningham's observations two chronometers were sometimes used, the time of passing one end of the run being noted on one, and that of passing the other end of the run being noted on the other. The chronometers were compared immediately before the observations. In other cases a single chronometer was used placed midway of the run. The moment of the floats passing the ends of the run was signalled to a time-keeper at the chronometer by shouting. It was found quite possible to count the chronometer beats to the nearest half second, and in some cases to the nearest quarter second.

§ 137. *Sub-surface Floats.*—The velocity at different depths below the surface of a stream may be obtained by sub-surface floats, used precisely in the same way as surface floats. The most usual arrangement is to have a large float, of slightly greater density than water, and a very light surface float. The motion of the combined arrangement is not sensibly different from that of the large float, and the small surface float enables an observer to note the path and velocity of the sub-surface float. The instrument is, however, not free from objection. If the large submerged float is made of very nearly the same density as water, then it is liable to be thrown upwards by very slight eddies in the water, and it does not maintain its position at the depth at which it is intended to float. On the other hand, if the large float is made sensibly heavier than water, the indicating or surface float must be made rather large, and then it to some extent influences the motion of the submerged float.

Fig. 137 shows one form of sub-surface float. It consists of a couple of tin plates bent at a right angle and soldered together at the angle. This is connected with a wooden ball at the surface by a very thin wire or cord. As the tin alone makes a heavy submerged float, it is better to attach to the tin float some pieces of wood to diminish its weight in water. Fig. 138 shows the form of submerged float used

by Cunningham. It consists of a hollow metal ball connected to a slice of cork, which serves as the surface float.

§ 138. *Twin Floats.*—Suppose two equal and similar floats (fig. 139) connected by a wire. Let one float be a little lighter and the other a little heavier than water. Then the velocity of the combined

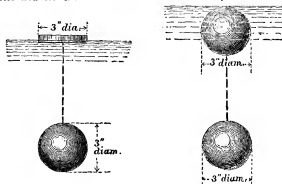

FIG. 138.

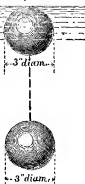

FIG. 139.

floats will be the mean of the surface velocity and the velocity at the depth at which the heavier float swims, which is determined by the length of the connecting wire. Thus if  $v_1$  is the surface velocity and  $v_2$  the velocity at the depth to which the lower float is sunk, the velocity of the combined floats will be

$$v = \frac{1}{2}(v_1 + v_2).$$

Consequently, if  $v$  is observed, and  $v_2$  determined by an experiment with a single float,

$$v_1 = 2v - v_2.$$

According to Cunningham, the twin float gives better results than the sub-surface float.

§ 139. *Velocity Rods.*—Another form of float is shown in fig. 140. This consists of a cylindrical rod loaded at the lower end so as to float nearly vertical in water. A wooden rod, with a metal cap at the bottom in which shot can be placed, answers better than anything else, and sometimes the wooden rod is made in lengths, which can be screwed together so as to suit streams of different depths. A tuft of cotton wool at the top serves to make the float more easily visible. Such a rod, so adjusted in length that it sinks nearly to the bed of the stream, gives directly the mean velocity of the whole vertical section in which it floats.

§ 140. *Revy's Current Meter.*—No instrument has been so much used in directly determining the velocity of a stream at a given point as the screw current meter. Of this there are a dozen varieties at least. As an example of the instrument in its simplest form, Revy's meter may be selected. This is an ordinary screw meter of a larger size than usual, more carefully made, and with its details carefully studied (figs. 141, 142). It was designed after experience in gauging the great South American rivers. The screw, which is actuated by the water, is 6 in. in diameter, and is of the type of the Griffiths screw used in ships. The hollow spherical boss serves to make the weight of the screw sensibly equal to its displacement, so that friction is much reduced. On the axis  $aa$  of the screw is a worm which drives the counter. This consists of two worm wheels  $g$  and  $h$  fixed on a common axis. The worm wheels are carried on a frame attached to the pin  $l$ . By means of a string attached to  $l$  they can be pulled into gear with the worm, or dropped out of gear and stopped at any instant. A nut  $m$  can be screwed up, if necessary, to keep the counter permanently in gear. The worm is two-threaded, and the worm wheel  $g$  has 200 teeth. Consequently it makes one rotation for two rotations of the screw, and the number of rotations up to 100 is marked by the passage of the graduations on its edge in front of a fixed index. The second worm wheel has 106 teeth, and its edge is divided into 49 divisions. Hence it falls behind the first wheel one division for a complete rotation of the latter. The number of hundreds of rotations of the screw are therefore shown by the number of divisions on the index in gear. One difficulty in the use of the ordinary screw meter is that particles of grit, getting into the working parts, very sensibly alter the friction, and therefore the speed of the meter. Revy obviates this by enclosing the counter in a brass box with a glass face. This box is filled with pure water, which ensures a constant coefficient of friction for the rubbing parts, and prevents any mud or grit hindering its way in. In order that the meter may place itself with the axis parallel to the current, it is pivoted on a vertical axis and directed by a large vane shown in fig. 142. To give the vane



FIG. 140.

more directing power the vertical axis is nearer the screw than in ordinary meters, and the vane is larger. A second horizontal vane is attached by the screws  $x$ , the object of which is to allow the meter to rest on the ground without the motion of the screw being interfered with. The string or wire for starting and stopping the meter is

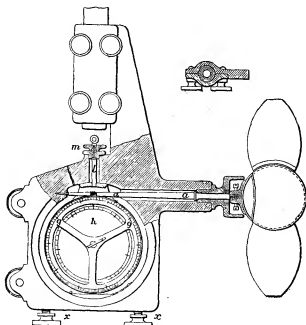

FIG. 141.

carried through the centre of the vertical axis, so that the strain on it may not tend to pull the meter oblique to the current. The pitch of the screw is about 9 in. The screws at  $x$  serve for filling the meter with water. The whole apparatus is fixed to a rod (fig. 142), of a length proportionate to the depth, or for very great depths it is fixed to a weighted bar lowered by ropes, a plan invented by Revy. The instrument is generally used thus. The reading of the counter is noted, and it is put out of gear. The meter is then lowered into the water to the required position from a platform between two boats, or better from a temporary bridge. Then the counter is put into gear for one, two or five minutes. Lastly, the instrument is raised and the counter again read. The velocity is deduced from the number of rotations in unit time by the formulæ given below. For surface velocities the counter may be kept permanently in gear, the screw being started and stopped by hand.

§ 141. *The Harlachner Current Meter.*—In this ordinary counting apparatus is abandoned. A worm drives a worm wheel, which makes an electrical contact once for each 100 rotations of the worm. This contact gives a signal above water. With this arrangement, a series of velocity observations can be made, without removing the instrument from the water, and a number of practical difficulties attending the accurate starting and stopping of the ordinary counter are entirely got rid of. Fig. 143 shows the meter. The worm wheel  $g$  makes one rotation for 100 of the screw. A pin moving the lever  $v$  makes the electrical contact. The wires  $b, c$  are led through a gas pipe  $B$ ; this also serves to adjust the meter to any required position on the wooden rod  $dd$ . The rudder or vane is shown at  $WH$ . The galvanic current acts on the electromagnet  $m$ , which is fixed in a small metal box containing also the battery. The magnet exposes and withdraws a coloured disk at an opening in the cover of the box.

§ 142. *Amsler Laffon Current Meter.*—A very convenient and accurate current meter is constructed by Amsler Laffon of Schaffhausen. This can be used on a rod, and put into and out of gear by a ratchet. The peculiarity in this case is that there is a double ratchet, so that one pull on the string puts the counter into gear and a second puts it out of gear. The string may be slack during the action of the meter, and there is less uncertainty than when the

counter has to be held in gear. For deep streams the meter  $A$  is suspended by a wire with a heavy lenticular weight below (fig. 144). The wire is payed out from a small winch  $D$ , with an index showing the depth of the meter, and passes over a pulley  $B$ . The meter is in gimbals and is directed by a conical rudder which keeps it facing the stream with its axis horizontal. There is an electric circuit from a battery  $C$  through the meter, and a contact is made closing the circuit every 100 revolutions. The moment the circuit closes a bell rings. By a subsidiary arrangement, when the foot of the instrument, 0.3 metres below the axis of the meter, touches the ground the circuit is also closed and the bell rings. It is easy to distinguish the continuous ring when the ground is reached from the short ring when the counter signals. A convenient winch for the wire is so graduated that if

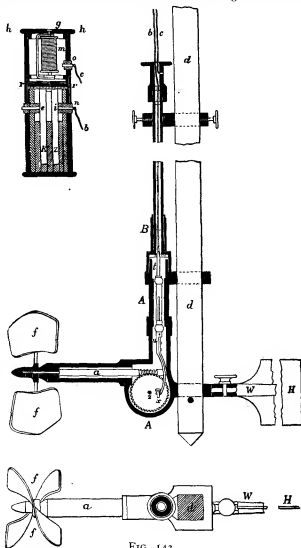

FIG. 143.

set when the axis of the meter is at the water surface it indicates at any moment the depth of the meter below the surface. Fig. 144 shows the meter as used on a boat. It is a very convenient instrument for obtaining the velocity at different depths and can also be used as a sounding instrument.

§ 143. *Determination of the Coefficients of the Current Meter.*—Suppose a series of observations has been made by towing the meter in still water at different speeds, and that it is required to ascertain from these the constants of the meter. If  $v$  is the velocity of the water and  $n$  the observed number of rotations per second, let

$$v = \alpha + \beta n \quad (1)$$

where  $\alpha$  and  $\beta$  are constants. Now let the meter be towed over a measured distance  $L$ , and let  $N$  be the revolutions of the meter and  $t$  the time of transit. Then the speed of the meter relatively to the water is  $L/t = n$  feet per second, and the number of revolutions per second is  $N/t = n$ . Suppose  $m$  observations have been made in this way, furnishing corresponding values of  $v$  and  $n$ , the speed in each trial being as uniform as possible,

$$\begin{aligned} \Sigma n &= n_1 + n_2 + \dots \\ \Sigma v &= v_1 + v_2 + \dots \\ \Sigma nv &= n_1 v_1 + n_2 v_2 + \dots \\ \Sigma n^2 &= n_1^2 + n_2^2 + \dots \\ [\Sigma n]^2 &= [n_1 + n_2 + \dots]^2 \end{aligned}$$

peculiarity in this case is that there is a double ratchet, so that one pull on the string puts the counter into gear and a second puts it out of gear. The string may be slack during the action of the meter, and there is less uncertainty than when the

Then for the determination of the constants  $\alpha$  and  $\beta$  in (1), by the method of least squares—

$$\alpha = \frac{\sum n^2 \sum v - \sum n \sum nv}{m \sum n^2 - [\sum n]^2},$$

$$\beta = \frac{m \sum nv - \sum v \sum n}{m \sum n^2 - [\sum n]^2}.$$

In a few cases the constants for screw current meters have been determined by towing them in R. E. Froude's experimental tank in

stream and to check oscillations of the water column. Let the difference of level of a pair of tubes A and B (fig. 145) be taken to be  $h = kv^2/2g$ , then  $k$  may be taken to be a corrective coefficient whose value in well-shaped instruments is very nearly unity. By placing his instrument in front of a boat towed through water Darcy found  $k = 1.034$ ; by placing the instrument in a stream the velocity of which had been ascertained by floats, he found  $k = 1.006$ ; by readings taken in different parts of the section of a canal in which a known volume of water was flowing, he found  $k = 0.993$ . He believed the

first value to be too high in consequence of the disturbance caused by the boat. The mean of the other two values is almost exactly unity (*Recherches hydrauliques*, Darcy and Bazin, 1865, p. 63). W. B. Gregory used somewhat differently formed Pitot tubes for which the  $k = 1$  [*Am. Soc. Mech. Eng.*, 1903, 25]. T. E. Stanton used a Pitot tube in determining the velocity of an air current, and for his instrument he found  $k = 1.030$  to  $k = 1.032$  ("On the Resistance of Plane Surfaces in a Current of Air," *Proc. Inst. Civ. Eng.*, 1904, 156).

One objection to the Pitot tube in its original form was the great difficulty and inconvenience of reading the height  $h$  in the immediate neighbourhood of the stream surface. This is obviated in the Darcy gauge, which can be removed from the stream to be read.

Fig. 146 shows a Darcy gauge. It consists of two Pitot tubes having their mouths at right angles. In the instrument shown, the two tubes, formed of copper in the lower part, are united into one for strength, and the mouths of the tubes open vertically and horizontally. The upper part of the tubes is of glass, and they are provided with a brass scale and two verniers  $b, b$ . The whole instrument is supported on a vertical rod or small pile AA, the fixing at B permitting the instrument to be adjusted to any height on the rod, and at the same time allowing free rotation, so that it can be held parallel to the current. At  $c$  is a two-way cock, which can be opened or closed by cords. If this is shut, the instrument can be lifted out of the stream for reading. The glass tubes are connected at top by a brass fixing, with a stop cock  $a$ , and a flexible tube and mouthpiece  $m$ . The use of this is as follows. If the velocity is re-

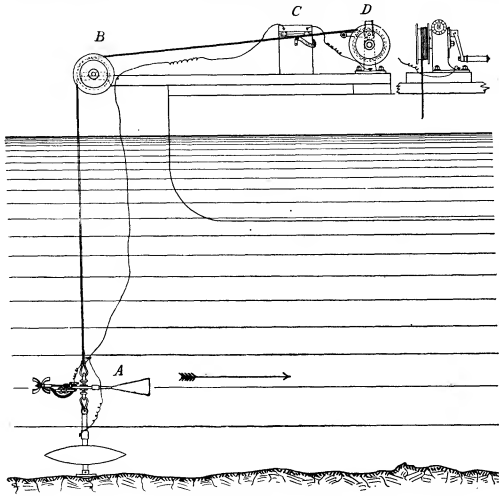

FIG. 144.

quired at a point near the surface of the stream, one at least of the water columns would be below the level at which it could be read. It would be in the copper part of the instrument. Suppose then a little air is sucked out by the tube  $m$ , and the cock  $a$  closed, the two columns will be forced up an amount corresponding to the difference between atmospheric pressure and that in the tubes. But the difference of level will remain unaltered.

When the velocities to be measured are not very small, this instrument is an admirable one. It requires observation only of a single linear quantity, and does not require any time observation. The law connecting the velocity and the observed height is a rational one, and it is not absolutely necessary to make any experiments on the coefficient of the instrument. If we take  $v = kv\sqrt{2gh}$ , then it appears from Darcy's experiments that for a well-formed instrument  $k$  does not sensibly differ from unity. It gives the velocity at a definite point in the stream. The chief difficulty arises from the fact that at any given point in a stream the velocity is not absolutely constant, but varies a little from moment to moment. Darcy in some of his experiments took several readings, and deduced the velocity from the mean of the highest and lowest.

§ 145. *Perrotil Hydrodynamometer*.—This consists of a frame  $abcd$  (fig. 147) placed vertically in the stream, and of a height not less than the stream's depth. The two vertical members of this frame are connected by cross bars, and united above water by a circular bar, situated in the vertical plane and carrying a horizontal graduated circle  $ef$ . This whole system is movable round its axis, being suspended on a pivot at  $g$  connected with the fixed support  $mn$ . Other horizontal arms serve as guides. The central vertical rod  $gr$  forms a torsion rod, being fixed at  $r$  to the frame  $abcd$ , and passing freely upwards through the guides, it carries a horizontal

which the resistance of ship models is ascertained. In that case the data are found with exceptional accuracy.

§ 144. *Darcy Gauge or modified Pitot Tube*.—A very old instrument for measuring velocities, invented by Henri Pitot in 1730 (*Histoire de l'Académie des Sciences*, 1732, p. 376), consisted simply of a vertical glass tube with a right-angled bend, placed so that its mouth was normal to the direction of flow (fig. 145).

The impact of the stream on the mouth of the tube balances a column in the tube, the height of which is approximately  $h = v^2/2g$ ,

where  $v$  is the velocity at the depth  $x$ . Placed with its mouth parallel to the stream the water inside the tube is nearly at the same level as the surface of the stream, and turned with the mouth down stream, the fluid sinks a depth  $h' = v^2/2g$  nearly, though the tube in that case interferes with the free flow of the liquid and somewhat modifies the result. Pitot expanded

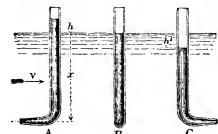

FIG. 145.

the mouth of the tube so as to form a funnel or bell mouth. In that case he found by experiment

$$h = 1.5v^2/2g.$$

But there is more disturbance of the stream. Darcy preferred to make the mouth of the tube very small to avoid interference with the

needle moving over the graduated circle *ef*. The support *g*, which carries the apparatus, also receives in a tubular guide the end of the torsion rod *gr* and a set screw for fixing the upper end of the torsion rod when necessary. The impulse of the stream of water is received on a circular disk *x*, in the plane of the torsion rod and the frame *abcd*. To raise and lower the apparatus easily, it is not fixed directly to the rod *mn*, but to a tube *kl* sliding on *mn*.

Suppose the apparatus arranged so that the disk *x* is at that level of the stream where the velocity is to be determined. The plane

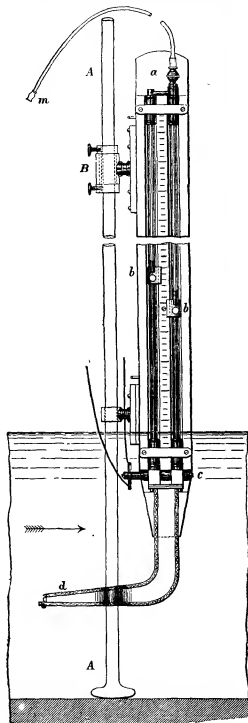

FIG. 146.

*abcd* is placed parallel to the direction of motion of the water. Then the disk *x* (acting as a rudder) will place itself parallel to the stream on the down stream side of the frame. The torsion rod will be unstrained, and the needle will be at zero on the graduated circle. If, then, the instrument is turned by pressing the needle, till the plane *abcd* of the disk and the zero of the graduated circle is at right angles to the stream, the torsion rod will be twisted through an angle which measures the normal impulse of the stream on the disk *x*. That angle

will be given by the distance of the needle from zero. Observation shows that the velocity of the water at a given point is not constant. It varies between limits more or less wide. When the apparatus is nearly in its right position, the set screw at *g* is made to clamp the torsion spring. Then the needle is fixed, and the apparatus carrying the graduated circle oscillates. It is not, then, difficult to note the mean angle marked by the needle.

Let *r* be the radius of the torsion rod, *l* its length from the needle over *ef* to *r*, and *α* the observed torsion angle. Then the moment of the couple due to the molecular forces in the torsion rod is

$$M = E_c l \alpha / l;$$

where  $E_c$  is the modulus of elasticity for torsion, and  $l$  the polar moment of inertia of the section of the rod. If the rod is of circular section,  $l = \frac{1}{2} \pi r^4$ . Let  $R$  be the radius of the disk, and  $b$  its leverage, or the distance of its centre from the axis of the torsion rod. The moment of the pressure of the water on the disk is

$$Fb = kb(G/2g) \pi R^2 \alpha^2,$$

where  $G$  is the heaviness of water and  $k$  an experimental coefficient. Then

$$E_c l \alpha / l = kb(G/2g) \pi R^2 \alpha^2.$$

For any given instrument,

$$v = c \sqrt{\alpha},$$

where  $c$  is a constant coefficient for the instrument.

The instrument as constructed had three disks which could be used at will. Their radii and leverages were in feet

	R =	b =
1st disk	0.052	0.16
2nd "	0.105	0.32
3rd "	0.210	0.66

For a thin circular plate, the coefficient  $k = 1.12$ . In the actual instrument the torsion rod was a brass wire 0.06 in. diameter and 6½ ft. long. Supposing  $\alpha$  measured in degrees, we get by calculation

$$v = 0.335 \sqrt{\alpha}; 0.115 \sqrt{\alpha}; 0.042 \sqrt{\alpha}.$$

Very careful experiments were made with the instrument. It was fixed to a wooden turning bridge, revolving over a circular channel of 2 ft. width, and about 76 ft. circumferential length. An allowance was made for the slight current produced in the channel. These experiments gave for the coefficient  $c$ , in the formula  $v = c \sqrt{\alpha}$ ,

1st disk, $c = 0.3126$	for velocities of 3 to 16 ft.
2nd "	0.1177 " " 1½ to 3½ "
3rd "	0.0349 " " less than 1½ "

The instrument is preferable to the current meter in giving the velocity in terms of a single observed quantity, the angle of torsion, while the current meter involves the observation of two quantities, the number of rotations and the time. The current meter, except in some improved forms, must be withdrawn from the water to read the result of each experiment, and the law connecting the velocity and number of rotations of a current meter is less well-determined than that connecting the pressure on a disk and the torsion of the wire of a hydromonometer.

The Pitot tube, like the hydromonometer, does not require a time observation. But, where the velocity is a varying one, and consequently the columns of water in the Pitot tube are oscillating, there is room for doubt as to whether, at any given moment of closing the cock, the difference of level exactly measures the impulse of the stream at the moment. The Pitot tube also fails to give measurable indications of very low velocities.

#### PROCESSES FOR GAUGING STREAMS

§ 146. *Gauging by Observation of the Maximum Surface Velocity.*—The method of gauging which involves the least trouble is to determine the surface velocity at the thread of the stream, and to deduce from it the mean velocity of the whole cross section. The maximum surface velocity may be determined by floats or by a current meter. Unfortunately the ratio of the maximum surface to the mean velocity is extremely variable. Thus putting  $v_s$  for the surface velocity at the thread of the stream, and  $v_m$  for the mean velocity of the whole cross section,  $v_m/v_s$  has been found to have the following values:—

	$v_m/v_s$
De Prony, experiments on small wooden channels	0.8164
Experiments on the Seine	0.62
Destrem and De Prony, experiments on the Neva	0.78
Boileau, experiments on canals	0.82
Baugartner, experiments on the Garonne	0.80
Brünings (mean)	0.85
Cunningham, Solani aqueduct	0.823

Various formulæ, either empirical or based on some theory of the vertical and horizontal velocity curves, have been proposed for determining the ratio  $v_m/v_a$ . Bazin found from his experiments the empirical expression

$$v_m = v_a - 25.4\sqrt{m};$$

where  $m$  is the hydraulic mean depth and  $\delta$  the slope of the stream.

In the case of irrigation canals and rivers, it is often important to determine the discharge either daily or at other intervals of time, while the depth and consequently the mean velocity is varying. Cunningham (*Roorkee Prof. Papers*, iv, 77), has shown that, for a given part of such a stream, where the bed is regular and of permanent section, a simple formula may be found for the variation of the central surface velocity with the depth. When once the constants of this formula have been determined by measuring the central surface velocity and depth, in different conditions of the stream, the surface velocity can be obtained by simply observing the depth of the stream, and from this the mean velocity and discharge can be calculated. Let  $z$  be the depth of the stream, and  $v_s$  the surface velocity, both measured at the thread of the stream.  $v_s = 0.75z + c$ ; where  $c$  is a constant which for the Solani aqueduct had the values 1.9 to 2, the depths being 6 to 10 ft., and the velocities  $3\frac{1}{2}$  to  $4\frac{1}{2}$  ft. Without any assumption of a formula, however, the surface velocities, or still better the mean velocities, for different conditions of the stream may be plotted on a diagram in which the abscissæ are depths and the ordinates velocities. The continuous curve through points so found would then always give the velocity for any observed depth of the stream, without the need of making any new float or current meter observations.

§ 147. *Mean Velocity determined by observing a Series of Surface Velocities.*—The ratio of the mean velocity to the surface velocity in one longitudinal section is better ascertained than the ratio of the central surface velocity to the mean velocity of the whole cross section. Suppose the river divided into a number of compartments by equidistant longitudinal planes, and the surface velocity observed in each compartment. From this the mean velocity in each compartment and the discharge can be calculated. The sum of the partial discharges will be the total discharge of the stream. When wires or ropes can be stretched across the stream, the compartments can be marked out by tags attached to them. Suppose two such ropes stretched across the stream, and floats dropped in above the upper rope. By observing within which compartment the path of the float lies, and noting the time of transit between the ropes, the surface velocity in each compartment can be ascertained. The mean velocity in each compartment is 0.85 to 0.91 of the surface velocity in that compartment. Putting  $k$  for this ratio, and  $v_1, v_2, \dots$  for the observed velocities, in compartments of area  $\Omega_1, \Omega_2, \dots$  then the total discharge is

$$Q = k(\Omega_1 v_1 + \Omega_2 v_2 + \dots).$$

If several floats are allowed to pass over each compartment, the mean of all those corresponding to one compartment is to be taken as the surface velocity of that compartment.

This method is very applicable in the case of large streams or rivers too wide to stretch a rope across. The paths of the floats are then ascertained in this way. Let fig. 148 represent a portion of the river, which should be straight and free from obstructions.

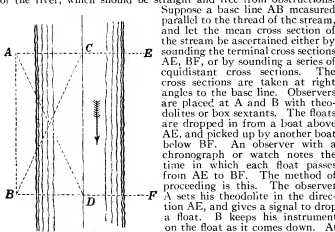

FIG. 148

A calls out. B clamps his instrument and reads the angle ABC, and the time observer begins to note the time of transit. B now points his instrument in the direction BF, and A keeps the float on the cross wire of his instrument. At the moment the float arrives at D in the line BF, the observer B calls out. A clamps his instrument and reads off the angle BAD, and the time observer notes the time of transit from C to D. Thus all the data are determined for plotting the path CD of the float and determining its velocity. By dropping in a series of floats, a number of surface velocities can be determined. When all these have been plotted, the river can be

divided into convenient compartments. The observations belonging to each compartment are then averaged, and the mean velocity and discharge calculated. It is obvious that, as the surface velocity is greatly altered by wind, experiments of this kind should be made in very calm weather.

The ratio of the surface velocity to the mean velocity in the same vertical section is ascertained from the formulæ for the vertical velocity curve already given (§ 101). Exner, in *Erbkam's Zeitschrift* for 1875, gave the following convenient formula. Let  $v$  be the mean and  $V$  the surface velocity in any given vertical longitudinal section, the depth of which is  $h$

$$\frac{v}{V} = (1 + 0.1478h/h)/(1 + 0.2216\sqrt{h}).$$

If vertical velocity rods are used instead of common floats, the mean velocity is directly determined for the vertical section in which the rod floats. This formula of reduction is then necessary. The observed velocity has simply to be multiplied by the area of the compartment to which it belongs.

§ 148. *Mean Velocity of the Stream from a Series of Mid Depth Velocities.*—In the gaugings of the Mississippi it was found that the mid depth velocity differed by only a very small quantity from the mean velocity in the vertical section, and it was uninfluenced by wind. If therefore a series of mid depth velocities are determined by double floats or by a current meter, they may be taken to be the mean velocities of the compartments in which they occur, and no formula of reduction is necessary. If floats are used, the method is precisely the same as that described in the last paragraph for surface floats. The paths of the double floats are observed and plotted, and the mean taken of those corresponding to each of the compartments into which the river is divided. The discharge is the sum of the products of the observed mean mid depth velocities and the areas of the compartments.

§ 149. *P. P. Boileau's Process for Gauging Streams.*—Let  $U$  be the mean velocity at a given section of a stream,  $V$  the maximum velocity, or that of the principal filament, which is generally a little below the surface,  $W$  and  $w$  the greatest and least velocities at the surface. The distance of the principal filament from the surface is generally less than one-fourth of the depth of the stream;  $W$  is a little less than  $V$ ; and  $U$  lies between  $W$  and  $w$ . As the surface velocities change continuously from the centre towards the sides there are at the surface two filaments having a velocity equal to  $U$ . The determination of the position of these filaments, which Boileau terms the gauging filaments, cannot be effected entirely by theory. But, for sections of a stream in which there are no abrupt changes of depth, their position can be very approximately assigned. Let  $\Delta$  and  $\delta$  be the horizontal distances of the surface filament, having the velocity  $W$ , from the gauging filament, which has the velocity  $U$ , and from the bank on one side. Then

$$\Delta/\delta = c^2\sqrt{[(W+2u)/7](W-w)},$$

$c$  being a numerical constant. From gaugings by Humphreys and Abbot, Bazin and Baumgarten, the values  $c = 0.919, 0.922$  and  $0.925$  are obtained. Boileau adopts as a mean value 0.922. Hence, if  $W$  and  $w$  are determined by float gauging or otherwise,  $\Delta$  can be found, and then a single velocity observation at  $\Delta$  ft. from the filament will give the mean velocity, without need of any reduction, the mean velocity of the stream. More conveniently  $W, w$ , and  $U$  can be measured from a horizontal surface velocity curve, obtained from a series of float observations.

§ 150. *Direct Determination of the Mean Velocity by a Current Meter or Darcy Gauge.*—The only method of determining the mean velocity at a cross section of a stream which involves no assumption of the ratio of the mean velocity to other quantities is this—a plank bridge is fixed across the stream near its surface. From this, velocities are observed at a sufficient number of points in the cross section of the stream, evenly distributed over its area. The mean of these is the true mean velocity of the stream. In Darcy and Bazin's experiments on small streams, the velocity was thus observed at 36 points in the cross section.

When the stream is too large to fix a bridge across it, the observations may be taken from a boat, or from a couple of boats with a gangway between them, anchored successively at a series of points across the width of the stream. The position of the boat for each series of observations is fixed by angular observations to a base line on shore.

§ 151. *A. R. Harlacher's Graphic Method of determining the Discharge from a Series of Current Meter Observations.*—Let ABC (fig. 149) be the cross section of a river at which a complete series of

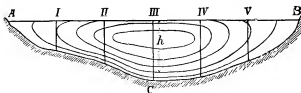

FIG. 149.

current meter observations have been taken. Let I., II., III., ... be the verticals at different points of which the velocities were measured.



Suppose the depths at I, II, III, . . . (fig. 149), set off as vertical ordinates in fig. 150, and on these vertical ordinates suppose the velocities set off horizontally at their proper depths. Thus, if  $v$  is the measured velocity at the depth  $h$  from the surface in fig. 149, on vertical marked III., then at III. in fig. 150 take  $cd = h$  and  $ac = v$ . Then  $d$  is a point in the vertical velocity curve for the vertical III., and, all the velocities for that ordinate being similarly set off, the curve can be drawn. Suppose all the vertical velocity curves I. . . V. (fig. 150), thus drawn. On each of these figures draw verticals corresponding to velocities of  $x, 2x, 3x \dots$  ft. per second. Then for instance  $cd$  at III. (fig. 150) is the depth at which a velocity of  $2x$  ft. per second existed on the vertical III. in fig. 149 and if  $cd$  is set off at III in fig. 149 it gives a point in a curve passing through points of the section where the velocity was  $2x$  ft. per second. Set off on each of the verticals in fig. 149 all the depths thus found in the corresponding diagram in fig. 150. Curves drawn through the corresponding points on the verticals are curves of equal velocity.

The discharge of the stream per second may be regarded as a solid having the cross section of the river (fig. 149) as a base, and cross

out in this way. The upper figure shows the section of the river and the positions of the verticals at which the soundings and gaugings were taken. The lower gives the curves of equal velocity, worked out from the current meter observations, by the aid of vertical velocity curves. The vertical scale in this figure is ten times as great as in the other. The discharge calculated from the contour curves is 14,1087 cubic metres per second. In the lower figure some other interesting curves are drawn. Thus, the uppermost dotted curve is the curve through points at which the maximum velocity was found; it shows that the maximum velocity was always a little below the surface, and at a greater depth at the centre than at the sides. The next curve shows the depth at which the mean velocity for each vertical was found. The next is the curve of equal velocity corresponding to the mean velocity of the stream; that is, it passes through points in the cross section where the velocity was identical with the mean velocity of the stream.

## HYDRAULIC MACHINES

§ 152. Hydraulic machines may be broadly divided into two classes: (1) *Motors*, in which water descending from a higher to a lower level, or from a higher to a lower pressure, gives up energy which is available for mechanical operations; (2) *Pumps*, in which the energy of a steam engine or other motor is expended in raising water from a lower to a higher level. A few machines such as the ram and jet pump combine the functions of motor

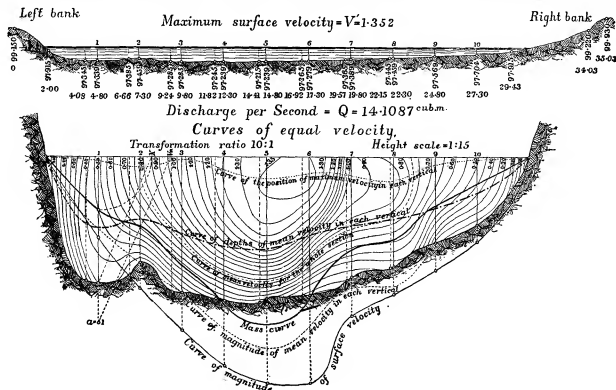

FIG. 151.

sections normal to the plane of fig. 149 given by the diagrams in fig. 150. The curves of equal velocity may therefore be considered as contour lines of the solid whose volume is the discharge of the stream per second. Let  $\Omega_0$  be the area of the cross section of the river,  $\Omega_1, \Omega_2, \dots$  the areas contained by the successive curves of equal velocity, or, if these cut the surface of the stream, by the curves and that surface. Let  $x$  be the difference of velocity for which the successive curves are drawn, assumed above for simplicity at 1 ft. per second. Then the volume of the successive layers of the solid body whose volume represents the discharge, limited by successive planes passing through the contour curves, will be

$$\frac{1}{2}x(\Omega_0 + \Omega_1), \frac{1}{2}x(\Omega_1 + \Omega_2), \text{ and so on.}$$

Consequently the discharge is

$$Q = x \left\{ \frac{1}{2}(\Omega_0 + \Omega_n) + \Omega_1 + \Omega_2 + \dots + \Omega_{n-1} \right\}.$$

The areas  $\Omega_0, \Omega_1, \dots$  are easily ascertained by means of the polar planimeter. A slight difficulty arises in the part of the solid lying above the last contour curve. This will have generally a height which is not exactly  $x$ , and a form more rounded than the other layers and less like a conical frustum. The volume of this may be estimated separately, and taken to be the area of its base (the area  $\Omega_n$ ) multiplied by  $\frac{1}{2}$  to  $\frac{1}{3}$  its height.

Fig. 151 shows the results of one of Harlacher's gaugings worked

and pump. It may be noted that constructively pumps are essentially reversed motors. The reciprocating pump is a reversed pressure engine, and the centrifugal pump a reversed turbine. Hydraulic machine tools are in principle motors combined with tools, and they now form an important special class.

Water under pressure conveyed in pipes is a convenient and economical means of transmitting energy and distributing it to many scattered working points. Hence large and important hydraulic systems are adopted in which at a central station water is pumped at high pressure into distributing mains, which convey it to various points where it actuates hydraulic motors operating cranes, lifts, dock gates, and in some cases riveting and shearing machines. In this case the head driving the hydraulic machinery is artificially created, and it is the convenience of distributing power in an easily applied form to distant points which makes the system advantageous. As there is some unavoidable loss in creating an artificial head this system is most suitable for driving machines which work intermittently

(see POWER TRANSMISSION). The development of electrical methods of transmitting and distributing energy has led to the utilization of many natural waterfalls so situated as to be useless without such a means of transferring the power to points where it can be conveniently applied. In some cases, as at Niagara, the hydraulic power can only be economically developed in very large units, and it can be most conveniently subdivided and distributed by transformation into electrical energy. Partly from the development of new industries such as paper-making from wood pulp and electro-metallurgical processes, which require large amounts of cheap power, partly from the facility with which energy can now be transmitted to great distances electrically, there has been a great increase in the utilization of water-power in countries having natural waterfalls. According to the twelfth census of the United States the total amount of water-power reported as used in manufacturing establishments in that country was 1,130,431 h.p. in 1870; 1,263,343 h.p. in 1890; and 1,727,258 h.p. in 1900. The increase was 8.4% in the decade 1870-1880, 3.1% in 1880-1890, and no less than 36.7% in 1890-1900. The increase is the more striking because in this census the large amounts of hydraulic power which are transmitted electrically are not included.

## XII. IMPACT AND REACTION OF WATER

§ 153. When a stream of fluid in steady motion impinges on a solid surface, it presses on the surface with a force equal and opposite to that by which the velocity and direction of motion of the fluid are changed. Generally, in problems on the impact of fluids, it is necessary to neglect the effect of friction between the fluid and the surface on which it moves.

*During Impact the Velocity of the Fluid relatively to the Surface on which it impinges remains unchanged in Magnitude.*—Consider a mass of fluid flowing in contact with a solid surface also in motion, the motion of both fluid and solid being estimated relatively to the earth. Then the motion of the fluid may be resolved into two parts, one a motion equal to that of the solid, and in the same direction, the other a motion relatively to the solid. The motion which the fluid has in common with the solid cannot at all be influenced by the contact. The relative component of the motion of the fluid can only be altered in direction, but not in magnitude. The fluid moving in contact with the surface can only have a relative motion parallel to the surface, while the pressure between the fluid and solid, if friction is neglected, is normal to the surface. The pressure therefore can only deviate the fluid, without altering the magnitude of the relative velocity. The unchanged common component and, combined with it, the deviated relative component give the resultant final velocity, which may differ greatly in magnitude and direction from the initial velocity.

From the principle of momentum, the impulse of any mass of fluid reaching the surface in any given time is equal to the change of momentum estimated in the same direction. The pressure between the fluid and surface, in any direction, is equal to the change of momentum in that direction of so much fluid as reaches the surface in one second. If  $P_a$  is the pressure in any direction,  $m$  the mass of fluid impinging per second,  $v_a$  the change of velocity in the direction of  $P_a$  due to impact, then

$$P_a = mv_a.$$

If  $v_1$  (fig. 152) is the velocity and direction of motion before impact,  $v_2$  that after impact, then  $v$  is the total change of motion due to impact.

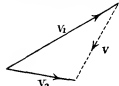

FIG. 152.

The resultant pressure of the fluid on the surface is in the direction of  $v_1$  and is equal to  $v$  multiplied by the mass impinging per second. That is, putting  $P$  for the resultant pressure,

$$P = mv.$$

Let  $P$  be resolved into two components,  $N$  and  $T$ , normal and tangential to the direction of motion of the solid on which the fluid impinges. Then  $N$  is a lateral force producing a pressure on the supports

$$\eta = Tu / (GQv^2/2g).$$

$$\eta = Tu / (GQv^2/2g).$$

of the solid,  $T$  is an effort which does work on the solid. If  $u$  is the velocity of the solid,  $Tu$  is the work done per second by the fluid in moving the solid surface.

Let  $Q$  be the volume, and  $GQ$  the weight of the fluid impinging per second, and let  $v_1$  be the initial velocity of the fluid before striking the surface. Then  $GQv_1^2/2g$  is the original kinetic energy of  $Q$  cub. ft. of fluid, and the efficiency of the stream considered as an arrangement for moving the solid surface is

$$\eta = Tu / (GQv^2/2g).$$

§ 154. *Set deviated entirely in one Direction.*—Geometrical Solution (fig. 153).—Suppose a jet of water impinges on a surface  $ac$  with a velocity  $ab$ , and let it be wholly deviated in planes parallel to the figure. Also let  $ae$  be the velocity and direction of motion of the

surface. Join  $eb$ ; then the water moves with respect to the surface in the direction and with the velocity  $eb$ . As this relative velocity is unaltered by contact with the surface, take  $cd = eb$ , tangent to the surface at  $c$ , then  $cd$  is the relative motion of the water with respect to the surface at  $c$ . Take  $df$  equal and parallel to  $ae$ . Then  $fc$  (obtained by compounding the relative motion of water to surface and common velocity of water and surface) is the absolute velocity and direction

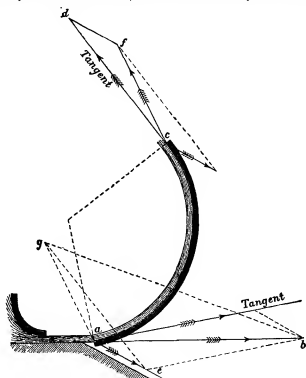

FIG. 153.

of the water leaving the surface. Take  $ag$  equal and parallel to  $fc$ . Then, since  $ab$  is the initial and  $ag$  the final velocity and direction of motion,  $gb$  is the total change of motion of the water. The resultant pressure on the plane is in the direction  $gb$ . Join  $eg$ . In the triangle  $gae$ ,  $ae$  is equal and parallel to  $df$ , and  $ag$  to  $fc$ . Hence  $eg$  is equal and parallel to  $cd$ . But  $cd = eb =$  relative motion of water and surface. Hence the change of motion of the water is represented in magnitude and direction by the third side of an isosceles triangle, of which the other sides are equal to the relative velocity of the water and surface, and parallel to the initial and final directions of relative motion.

### SPECIAL CASES

§ 155. (1) *A Jet impinges on a plane surface at rest, in a direction normal to the plane* (fig. 154).—Let a jet whose section is  $\omega$  impinge with a velocity  $v$  on a plane surface at rest,

in a direction normal to the plane. The particles approach the plane, are gradually deviated, and finally flow away parallel to the plane, having then no velocity in the original direction of the jet. The quantity of water impinging per second is  $\omega v$ . The pressure on the plane, which is equal to the change of momentum per second, is  $P = (G/g)\omega v^2$ .

(2) *If the plane is moving in the direction of the jet with the velocity  $u$ , the quantity impinging per second is  $\omega(v+u)$ .* The momentum of this quantity before impact is  $(G/g)\omega v(v+u)$ . After impact, the water still possesses the velocity  $u$  in the direction of the jet; and the momentum, in that direction, of so much water as impinges in one second, after impact, is  $(G/g)\omega u(v+u)$ . The pressure on the plane, which is the change of momentum per second, is the difference of these quantities or  $P = (G/g)\omega(v^2 - u^2)$ . This differs from the expression obtained in the previous case, in that the relative velocity of the water and plane  $v+u$  is substituted for  $v$ . The expression may be written  $P = 2 \times G \times \omega \times v(u+v)^2/2g$ , where the last two terms are the volume of a prism of water whose section is the area of the jet and whose length is the head due to the relative velocity. The pressure on the plane is twice the weight of that prism of water. The work done when the plane



FIG. 154.

is moving in the same direction as the jet is  $Pu = (G/g)\omega(v-u)u$  foot-pounds per second. There issue from the jet  $\omega v$  cub. ft. per second, and the energy of this quantity before impact is  $(G/2g)\omega v^2$ . The efficiency of the jet is therefore  $\eta = 2(v-u)u/v^2$ . The value of  $u$  which makes this a maximum is found by differentiating and equating the differential coefficient to zero:—

$$d\eta/du = 2(v^2 - 4vu + 3u^2)/v^3 = 0;$$

$$\therefore u = v \text{ or } \frac{2}{3}v.$$

The former gives a minimum, the latter a maximum efficiency.

Putting  $u = \frac{2}{3}v$  in the expression above,  
 $\eta \text{ max.} = \frac{8}{27}$ .

(3) If, instead of one plane moving before the jet, a series of planes are introduced at short intervals at the same point, the quantity of water impinging on the series will be  $\omega v$  instead of  $\omega(v-u)$ , and the whole pressure =  $(G/g)\omega v(v-u)$ . The work done is  $(G/g)\omega v u(v-u)$ . The efficiency  $\eta = (G/g)\omega v u(v-u) \div (G/2g)\omega v^2 = 2u(v-u)/v^2$ . This becomes a maximum for  $d\eta/du = 2(v-2u) = 0$ , or  $u = \frac{1}{2}v$ , and the  $\eta = \frac{1}{2}$ . This result is often used as an approximate expression for the velocity of greatest efficiency when a jet of water strikes the floats of a water wheel. The work wasted in this case is half the whole energy of the jet when the floats run at the best speed.

§ 156. (4) *Case of a Jet impinging on a Concave Cup Vane.* velocity of water  $v$ , velocity of vane in the same direction  $u$  (fig. 155), weight impinging per second =  $Gv(v-u)$ .

If the cup is hemispherical, the water leaves the cup in a direction parallel to the jet. Its relative velocity is  $v-u$  when approaching the cup, and  $-(v-u)$  when leaving it. Hence its absolute velocity when leaving the cup is  $u - (v-u) = 2u - v$ . The change of momentum per second =  $(G/g)\omega v(v-u) \{v - (2u - v)\} = 2(G/g)\omega v(v-u)^2$ . Comparing this with case 2, it is seen that the pressure on a hemispherical cup is double that on a flat plane. The work done on the cup =  $2(G/g)\omega v(v-u)u$  foot-pounds per second. The efficiency of the jet is greatest when  $v = 3u$ ; in that case the efficiency =  $\frac{1}{3}$ .

If a series of cup vanes are introduced in front of the jet, so that the quantity of water acted upon is  $\omega v$  instead of  $\omega(v-u)$ , then the whole pressure on the chain of cups is  $(G/g)\omega v(v-2u+v) = 2(G/g)\omega v(v-u)$ . In this case the efficiency is greatest when  $v = 2u$ , and the maximum efficiency is unity, or all the energy of the water is expended on the cups.

§ 157. (5) *Case of a Flat Vane oblique to the Jet* (fig. 156).—This case presents some difficulty. The water spreading on the plane in all

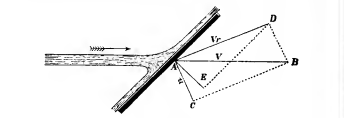

FIG. 156.

directions from the point of impact, different particles leave the plane with different absolute velocities. Let  $AB = v$  = velocity of water,  $AC = u$  = velocity of plane. Then, completing the parallelogram,  $AD$  represents in magnitude and direction the relative velocity of water and plane. Draw  $AE$  normal to the plane and  $DE$  parallel to the plane. Then the relative velocity  $AD$  may be regarded as consisting of two components, one  $AE$  normal, the other  $DE$  parallel to the plane. On the assumption that friction is insensible,  $DE$  is unaffected by impact, but  $AE$  is destroyed. Hence  $AE$  represents the entire change of velocity due to impact and the direction of that change. The pressure on the plane is in the direction  $AE$ , and its amount is = mass of water impinging per second  $\times AE$ .

Let  $\angle DAE = \theta$ , and let  $AD = v_r$ . Then  $AE = v_r \cos \theta$ ;  $DE = v_r \sin \theta$ . If  $Q$  is the volume of water impinging on the plane per second, the change of momentum is  $(G/g)Qv_r \cos \theta$ . Let  $AC = u$  = velocity of the plane, and let  $AC$  make the angle  $CAE = \delta$  with the normal to the plane. The velocity of the plane in the direction  $AE = u \cos \delta$ . The work of the jet on the plane =  $(G/g)Qv_r \cos \theta u \cos \delta$ . The same problem may be thus treated algebraically (fig. 157). Let  $\angle BAF = \alpha$ , and  $\angle CAF = \delta$ . The velocity  $v$  of the water may be decomposed into  $AF = v \cos \alpha$  normal to the plane, and  $FB = v \sin \alpha$  parallel to the plane. Similarly the velocity of the plane =  $u = AC = BD$  can be decomposed into  $BG = FE = u \cos \delta$  normal to the plane, and  $CG = u \sin \delta$  parallel to the plane. As friction is neglected, the velocity of the water parallel to the plane is unaffected by the impact, but its component  $v \cos \alpha$  normal to the plane becomes after

impact the same as that of the plane, that is,  $u \cos \delta$ . Hence the change of velocity during impact =  $AE = v \cos \alpha - u \cos \delta$ . The change of momentum per second, and consequently the normal

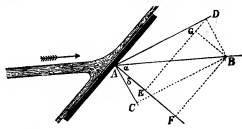

FIG. 157.

pressure on the plane is  $N = (G/g)Q(v \cos \alpha - u \cos \delta)$ . The pressure in the direction in which the plane is moving is  $P = N \cos \delta = (G/g)Q(v \cos \alpha - u \cos \delta) \cos \delta$ , and the work done on the plane is  $Pu = (G/g)Q(v \cos \alpha - u \cos \delta) u \cos \delta$ , which is the same expression as before, since  $AE = v_r \cos \theta = v \cos \alpha - u \cos \delta$ .

In one second the plane moves so that the point  $A$  (fig. 158) comes to  $C$ , or from the position shown in full lines to the position shown in dotted lines. If the plane remained stationary, a length  $AB = v$  of the jet would impinge on the plane, but since the plane moves in the same direction as the jet, only the length  $HB = AB - AH$  impinges on the plane.

But  $AH = AC \cos \delta / \cos \alpha$ , and therefore  $HB = v - u \cos \delta / \cos \alpha$ . Let  $\omega$  = sectional area of jet; volume impinging on plane per second =  $Q = \omega(v - u \cos \delta / \cos \alpha)$ . Inserting this in the formula above, we get

$$N = \frac{G}{g} \frac{\omega}{\cos \alpha} (v \cos \alpha - u \cos \delta)^2; \quad (1)$$

$$P = \frac{G}{g} \frac{\omega \cos \delta}{\cos \alpha} (v \cos \alpha - u \cos \delta)^2; \quad (2)$$

$$Pu = \frac{G}{g} \frac{\omega \cos \delta}{\cos \alpha} (v \cos \alpha - u \cos \delta)^2 u. \quad (3)$$

Three cases may be distinguished:—  
(a) The plane is at rest. Then  $u = 0$ ,  $N = (G/g)\omega v^2 \cos^2 \alpha$ ; and the work done on the plane and the efficiency of the jet are zero.

(b) The plane moves parallel to the jet. Then  $\delta = \alpha$ , and  $Pu = (G/g)\omega u \cos^2 \alpha (v-u)^2$ , which is a maximum when  $u = \frac{1}{2}v$ . When  $u = \frac{1}{2}v$  then  $Pu \text{ max.} = \frac{1}{8}(G/g)\omega v^3 \cos^2 \alpha$ , and the efficiency =  $\eta = \frac{1}{4} \cos^2 \alpha$ .

(c) The plane moves perpendicularly to the jet. Then  $\delta = 90^\circ - \alpha$ ;  $\cos \delta = \sin \alpha$ ; and  $Pu = \frac{G}{g} \omega v u \frac{\sin \alpha}{\cos \alpha} (v \cos \alpha - u \sin \alpha)^2$ . This is a maximum when  $u = \frac{1}{2}v \cos \alpha$ .

When  $u = \frac{1}{2}v \cos \alpha$ , the maximum work and the efficiency are the same as in the last case.

§ 158. *Best Form of Vane to receive Water.*—When water impinges normally or obliquely on a plane, it is scattered in all directions after impact, and the work carried away by the water is then generally lost, from the impossibility of dealing afterwards with streams of water deviated in so many directions. By suitably forming the vane,

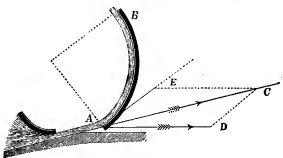

FIG. 159.

however, the water may be entirely deviated in one direction, and the loss of energy from agitation of the water is entirely avoided.

Let  $AB$  (fig. 159) be a vane, on which a jet of water impinges at the point  $A$  and in the direction  $AC$ . Take  $AC = v$  = velocity of

water, and let AD represent in magnitude and direction the velocity of the vane. Completing the parallelogram, DC or AE represents the direction in which the water is moving relatively to the vane. If the lip of the vane at A is tangential to AE, the water will not have its direction suddenly changed when it impinges on the vane, and will therefore have no tendency to spread laterally. On the contrary it will be so gradually deviated that it will glide up the vane in the direction AB. This is sometimes expressed by saying that the vane receives the water without shock.

§ 159. *Floats of Poncelet Water Wheels.*—Let AC (fig. 160) represent the direction of a thin horizontal stream of water having the

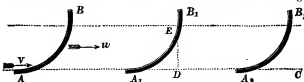

FIG. 160.

velocity  $v$ . Let AB be a curved float moving horizontally with velocity  $u$ . The relative motion of water and float is then initially horizontal, and equal to  $v-u$ .

In order that the float may receive the water without shock, it is necessary and sufficient that the lip of the float at A should be tangential to the direction AC of relative motion. At the end of  $(v-u)/g$  seconds the float moving with the velocity  $u$  comes to the position  $A_1B_1$ , and during this time a particle of water received at A and gliding up the float with the relative velocity  $v-u$ , attains a height  $DE = (v-u)^2/2g$ . At E the water comes to relative rest. It then descends along the float, and when after  $2(v-u)/g$  seconds the float has come to  $A_2B_2$ , the water will again have reached the lip at  $A_2$  and will quit it tangentially, that is, in the direction  $CA_2$ , with a relative velocity  $(v-u) = -v(2g/DE)$  acquired under the influence of gravity. The absolute velocity of the water leaving the float is therefore  $u - (v-u) = 2u - v$ . If  $u = \frac{1}{2}v$ , the water will drop off the bucket deprived of all energy of motion. The whole of the work of the jet must therefore have been expended in driving the float. The water will have been received without shock and discharged without velocity. This is the principle of the Poncelet wheel, but in that case the floats move over an arc of a large circle; the stream of water has considerable thickness (about 8 in.); in order to get the water into and out of the wheel, it is then necessary that the lip of the float should make a small angle (about  $15^\circ$ ) with the direction of its motion. The water quits the wheel with a little of its energy of motion remaining.

§ 160. *Pressure on a Curved Surface when the Water is deviated wholly in one Direction.*—When a jet of water impinges on a curved surface in such a direction that it is received without shock, the pressure on the surface is due to its gradual deviation from its first direction. On any portion of the area the pressure is equal and opposite to the force required to cause the deviation of so much water as rests on that surface. In common language, it is equal to the centrifugal force of that quantity of water.

Case 1. *Surface Cylindrical and Stationary.*—Let AB (fig. 161) be the surface, having its axis at O and its radius  $r$ . Let the water impinge at A tangentially, and quit the surface tangentially at B. Since the surface is at rest,  $v$  is both the absolute velocity of the water and the velocity relatively to the surface, and this remains unchanged during contact with the surface, because the deviating force is at each point perpendicular to the direction of motion. The water is deviated through an angle  $BCD = AOB = \phi$ . Each particle of water of weight  $p$  exerts radially a centrifugal force  $p\omega^2 r/g$ . Let the thickness of the stream  $= t$ . Then the weight of water resting on the

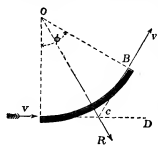

FIG. 161.

unit of surface  $= Gt$  lb; and the normal pressure per unit of surface  $= n = Gt\omega^2 r/g$ . The resultant of the radial pressures uniformly distributed from A to B will be a force acting in the direction OC bisecting AOB, and its magnitude will equal that of a force of intensity  $n$  acting on the projection of AB on a plane perpendicular to the direction OC. The length of the chord AB  $= 2r \sin \frac{1}{2}\phi$ ; let  $b$  = breadth of the surface perpendicular to the plane of the figure. The resultant pressure per surface

$$= R = 2rb \sin \frac{\phi}{2} \times \frac{Gt}{g} \times \frac{v^2}{r} = 2 \frac{G}{g} b\omega^2 r \sin \frac{\phi}{2},$$

which is independent of the radius of curvature. It may be inferred that the resultant pressure is the same for any curved surface of the same projected area, which deviates the water through the same angle.

Case 2. *Cylindrical Surface moving in the Direction AC with Velo-*

city  $u$ .—The relative velocity  $= v-u$ . The final velocity BF (fig. 162) is found by combining the relative velocity  $BD = v-u$  tangential to the surface with the velocity  $BE = u$  of the surface. The intensity of normal pressure, as in the last case, is  $(G/g)t(v-u)^2/r$ . The resultant

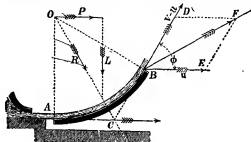

FIG. 162.

normal pressure  $R = 2(G/g)bt(v-u)^2 \sin \frac{1}{2}\phi$ . This resultant pressure may be resolved into two components  $P$  and  $L$ , one parallel and the other perpendicular to the direction of the vane's motion. The former is an effort doing work on the vane. The latter is a lateral force which does no work.

$$P = R \sin \frac{1}{2}\phi = (G/g)bt(v-u)^2(1 - \cos \phi);$$

$$L = R \cos \frac{1}{2}\phi = (G/g)bt(v-u)^2 \sin \phi.$$

The work done by the jet on the vane is  $Pu = (G/g)btu(v-u)^2(1 - \cos \phi)$ , which is a maximum when  $u = \frac{1}{2}v$ . This result can also be obtained by considering that the work done on the plane must be equal to the energy lost by the water, when friction is neglected.

If  $\phi = 180^\circ$ ,  $\cos \phi = -1$ ,  $1 - \cos \phi = 2$ ; then  $P = 2(G/g)bt(v-u)^2$ , the same result as for a concave cup.

§ 161. *Position which a Movable Plane takes in Flowing Water.*—When a rectangular plane, movable about an axis parallel to one of its sides, is placed in an infinite current of fluid, it takes a position such that the resultant of the normal pressures on the two sides of the axis passes through the axis.

If, therefore, planes pivoted so that the ratio  $a/b$  (fig. 163) is varied are placed in water, and the angle they make with the direction of the stream is observed, the position of the resultants of the pressures on the plane is determined for different angular positions. Experiments of this kind have been made by Hagen. Some of his results are given in the following table:—

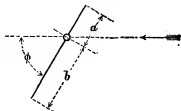

FIG. 163.

	Larger plane.	Smaller Plane.
$a/b = 1.0$	$\phi = \dots$	$\phi = 90^\circ$
0.9	$75^\circ$	$72\frac{1}{2}^\circ$
0.8	$60^\circ$	$57^\circ$
0.7	$48^\circ$	$43^\circ$
0.6	$25^\circ$	$29^\circ$
0.5	$13^\circ$	$13^\circ$
0.4	$8\frac{1}{2}^\circ$	$6\frac{1}{2}^\circ$
0.3	$4^\circ$	$\dots$

§ 162. *Direct Action distinguished from Reaction (Rankine, Steam Engine, § 147).*

The pressure which a jet exerts on a vane can be distinguished into two parts, viz.:

(1) The pressure arising from changing the direct component of the velocity of the water into the velocity of the vane. In fig. 153, § 154,  $ab \cos \delta ae$  is the direct component of the water's velocity, or component in the direction of motion of vane. This is changed into the velocity  $ae$  of the vane. The pressure due to direct impulse is then

$$P_1 = GQ(ab \cos \delta ae - ae)/g.$$

For a flat vane moving normally, this direct action is the only action producing pressure on the vane.

(2) The term reaction is applied to the additional action due to the direction and velocity with which the water glances off the vane. It is this which is diminished by the friction between the water and the vane. In case 2, § 160, the direct pressure is

$$P_1 = Gbt(v-u)^2/g.$$

That due to reaction is

$$P_2 = -Gbt(v-u)^2 \cos \phi/g.$$

If  $\phi < 90^\circ$ , the direct component of the water's motion is not wholly converted into the velocity of the vane, and the whole

pressure due to direct impulse is not obtained. If  $\phi > 90^\circ$ ,  $\cos \phi$  is negative and an additional pressure due to reaction is obtained.

§ 163. *Jet Propeller*.—In the case of vessels propelled by a jet of water (fig. 764), driven sternwards from orifices at the side of the vessel, the water, originally at rest outside the vessel, is drawn into the ship and caused to move with the forward velocity  $V$  of the ship. Afterwards it is projected sternwards from the jets with a velocity  $v$  relatively to the ship, or  $v - V$  relatively to the earth. If  $\Omega$  is the total sectional area of the jets,  $\Omega v$  is the quantity of water discharged per second. The momentum generated per second in a sternward direction is  $(G/g)\Omega v(v - V)$ , and this is equal to the forward acting reaction  $P$  which propels the ship.



FIG. 164.

The energy carried away by the water

$$= \frac{1}{2} (G/g)\Omega v(v - V)^2. \quad (1)$$

The useful work done on the ship

$$PV = (G/g)\Omega v(v - V)V. \quad (2)$$

Adding (1) and (2), we get the whole work expended on the water, neglecting friction:—

$$W = \frac{1}{2} (G/g)\Omega v(\rho^2 - V^2).$$

Hence the efficiency of the jet propeller is

$$PV/W = 2V/(v + V). \quad (3)$$

This increases towards unity as  $v$  approaches  $V$ . In other words, the less the velocity of the jets exceeds that of the ship, and therefore the greater the area of the orifice of discharge, the greater is the efficiency of the propeller.

In the "Waterwitch"  $v$  was about twice  $V$ . Hence in this case the theoretical efficiency of the propeller, friction neglected, was about  $\frac{1}{3}$ .

§ 164. *Pressure of a Steady Stream in a Uniform Pipe on a Plane normal to the Direction of Motion*.—Let CD (fig. 165) be a plane

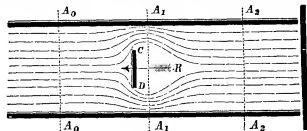

FIG. 165.

placed normally to the stream which, for simplicity, may be supposed to flow horizontally. The fluid filaments are deviated in front of the plane, form a contraction at  $A_1A_1$ , and converge again, leaving a mass of eddying water behind the plane. Suppose the section  $A_0A_0$  taken at a point where the parallel motion has not begun to be disturbed, and  $A_2A_2$  where the parallel motion is re-established. Then since the same quantity of water with the same velocity passes  $A_0A_0$ ,  $A_2A_2$  in any given time, the external forces produce no change of momentum on the mass  $A_0A_0A_2A_2$ , and must therefore be in equilibrium. If  $\Omega$  is the section of the stream at  $A_0A_0$  or  $A_2A_2$ , and  $\omega$  the area of the plate CD, the area of the contracted section of the stream at  $A_1A_1$  will be  $c_c(\Omega - \omega)$ , where  $c_c$  is the coefficient of contraction. Hence, if  $v$  is the velocity at  $A_0A_0$  or  $A_2A_2$ , and  $v_1$  the velocity at  $A_1A_1$ ,

$$\begin{aligned} v_1\Omega &= c_c v(\Omega - \omega); \\ \therefore v_1 &= v\Omega/c_c(\Omega - \omega). \end{aligned} \quad (1)$$

Let  $p_0$ ,  $p_1$ ,  $p_2$  be the pressures at the three sections. Applying Bernoulli's theorem to the sections  $A_0A_0$  and  $A_1A_1$ ,

$$\frac{p_0}{\rho} + \frac{v^2}{2g} = \frac{p_1}{\rho} + \frac{v_1^2}{2g}$$

Also, for the sections  $A_1A_1$  and  $A_2A_2$ , allowing that the head due to the relative velocity  $v_1 - v$  is lost in shock:—

$$\frac{p_1}{\rho} + \frac{v_1^2}{2g} = \frac{p_2}{\rho} + \frac{v^2}{2g} + \frac{(v_1 - v)^2}{2g};$$

$$\therefore p_0 - p_2 = G(v_1 - v)^2/2g; \quad (2)$$

or, introducing the value in (1),

$$p_0 - p_2 = \frac{G}{2g} \left( \frac{\Omega}{c_c(\Omega - \omega)} - 1 \right)^2 v^2 \quad (3)$$

Now the external forces in the direction of motion acting on the mass  $A_0A_0A_2A_2$  are the pressures  $p_0\Omega$ ,  $-p_2\Omega$  at the ends, and the reaction  $-R$  of the plane on the water, which is equal and opposite to the pressure of the water on the plane. As these are in equilibrium,

$$\begin{aligned} (p_0 - p_2)\Omega - R &= 0; \\ \therefore R &= G\Omega \left( \frac{\Omega}{c_c(\Omega - \omega)} - 1 \right)^2 \frac{v^2}{2g}; \end{aligned} \quad (4)$$

an expression like that for the pressure of an isolated jet on an infinitely extended plane, with the addition of the term in brackets, which depends only on the areas of the stream and the plane. For a given plane, the expression in brackets diminishes as  $\Omega$  increases. If  $\Omega = \rho$ , the equation (4) becomes

$$R = G\omega \frac{v^2}{2g} \left\{ \rho \left( \frac{\rho}{c_c(\rho - 1)} - 1 \right)^2 \right\}, \quad (4a)$$

which is of the form

$$R = G\omega(v^2/2g)K,$$

where  $K$  depends only on the ratio of the sections of the stream and plane.

For example, let  $c_c = 0.85$ , a value which is probable, if we allow that the sides of the pipe act as internal borders to an orifice. Then

$$K = \rho \left( 1.176 \frac{\rho - 1}{\rho - 1} - 1 \right)^2.$$

$\rho =$	$K =$
1	0
2	3.66
3	1.75
4	1.29
5	1.10
10	.94
50	2.00
100	3.50

The assumption that the coefficient of contraction  $c_c$  is constant for different values of  $\rho$  is probably only true when  $\rho$  is not very large. Further, the increase of  $K$  for large values of  $\rho$  is contrary to experience, and hence it may be inferred that the assumption that all the filaments have a common velocity  $v_1$  at the section  $A_1A_1$  and a common velocity  $v$  at the section  $A_2A_2$  is not true when the stream is very much larger than the plane. Hence, in the expression

$$R = KG\omega v^2/2g,$$

$K$  must be determined by experiment in each special case. For a cylindrical body putting  $\omega$  for the section,  $c_c$  for the coefficient of contraction,  $c_c(\Omega - \omega)$  for the area of the stream at  $A_1A_1$ ,

$$v_1 = v\Omega/c_c(\Omega - \omega); \quad v_2 = v\Omega(\Omega - \omega);$$

or, putting  $\rho = \Omega/\omega$ ,

$$v_1 = v\rho/c_c(\rho - 1), \quad v_2 = v\rho/(\rho - 1).$$

Then

$$R = K_1 G\omega v^2/2g,$$

where

$$K_1 = \rho \left\{ \left( \frac{\rho}{\rho - 1} \right)^2 \left( \frac{1}{c_c} - 1 \right)^2 + \left( \frac{\rho}{\rho - 1} - 1 \right)^2 \right\}.$$

Taking  $c_c = 0.85$  and  $\rho = 4$ ,  $K_1 = 0.467$ , a value less than before. Hence there is less pressure on the cylinder than on the thin plane.

§ 165. *Distribution of Pressure on a Surface on which a Jet impinges normally*.—The principle of momentum gives readily enough the total or resultant pressure of a jet impinging on a plane surface, but in some cases it is useful to know the distribution of the pressure.

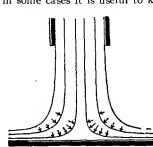

FIG. 166.

The problem in the case in which the plane is struck normally, and the jet spreads in all directions, is one of great complexity, but even in that case the maximum intensity of the pressure is easily assigned. Each layer of water flowing from an orifice is gradually deviated (fig. 166) by contact with the surface, and during deviation exercises a centrifugal pressure towards the axis of the jet. The force exerted by each small mass of water is normal to its path and inversely as the radius of curvature of the path.

Hence the greatest pressure on the plane must be at the axis of the jet, and the pressure must decrease from the axis outwards, in some such way as is shown by the curve of pressure in fig. 167, the branches of the curve being probably asymptotic to the plane.

For simplicity suppose the jet is a vertical one. Let  $h_1$  (fig. 167) be the depth of the orifice from the free surface, and  $v_1$  the velocity of discharge. Then, if  $\omega$  is the area of the orifice, the quantity of water impinging on the plane is obviously

$$Q = \omega v_1 = \omega \sqrt{2gh_1};$$

that is, supposing the orifice rounded, and neglecting the coefficient of discharge.

The velocity with which the fluid reaches the plane is, however, greater than this, and may reach the value

$$v = \sqrt{2gh_1};$$

where  $h$  is the depth of the plane below the free surface. The external layers of fluid subjected throughout, after leaving the orifice, to the atmospheric pressure will attain the velocity  $v$ , and will flow away with this velocity unchanged except by friction. The layers towards the interior of the jet, being subjected to a pressure greater than atmospheric pressure, will attain a less velocity, and so much less as they are nearer the centre of the jet. But the pressure

can in no case exceed the pressure  $v^2/2g$  or  $h$  measured in feet of water, or the direction of motion of the water would be reversed, and there would be reflux. Hence the maximum intensity of the pressure

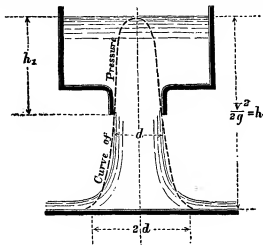

FIG. 167.

of the jet on the plane is  $h$  ft. of water. If the pressure curve is drawn with pressures represented by feet of water, it will touch the free water surface at the centre of the jet.

Suppose the pressure curve rotated so as to form a solid of revolution. The weight of water contained in that solid is the total pressure of the jet on the surface, which has already been determined. Let  $V$  = volume of this solid, then  $GV$  is its weight in pounds. Consequently

$$GV = (G/g) \omega v; \\ V = 2\omega \sqrt{h} x.$$

We have already, therefore, two conditions to be satisfied by the pressure curve.

Some very interesting experiments on the distribution of pressure on a surface struck by a jet have been made by J. S. Beresford (*Prof. Papers on Indian Engineering*, No. cccxxii.), with a view to afford information as to the forces acting on the aprons of weirs. Cylindrical jets  $\frac{1}{2}$  in. to 2 in. diameter, issuing from a vessel in which the water level was constant, were allowed to fall vertically on a brass plate 9 in. in diameter. A small hole in the brass plate communicated by a flexible tube with a vertical pressure column. Arrangements were made by which this aperture could be moved  $\frac{1}{8}$  in. at a time across the area struck by the jet. The height of the pressure column, for each position of the aperture, gave the pressure at that point of the area struck by the jet. When the aperture was

Fig. 168 shows the pressure curves obtained in three experiments with three jets of the sizes shown, and with the free surface level in the reservoir at the heights marked.

Experiment 1. Jet .475 in. diameter.			Experiment 2. Jet .988 in. diameter.			Experiment 3. Jet 1.95 in. diameter.		
Height from Free Surface to Brass Plate in inches.	Distance from Axis of jet in inches.	Pressure in inches of Water.	Height from Free Surface to Brass Plate in inches.	Distance from Axis of jet in inches.	Pressure in inches of Water.	Height from Free Surface to Brass Plate in inches.	Distance from Axis of jet in inches.	Pressure in inches of Water.
43	0	40.5	42.15	0	42	27.15	0	26.9
"	-.05	39.40	"	.05	41.9	"	-.08	26.9
"	-.1	37.5-39.5	"	.1	41.5-41.8	"	-.13	26.8
"	-.15	35	"	.15	41	"	-.18	26.5-26.6
"	-.2	33.5-37	"	.2	40.3	"	-.23	26.4-26.5
"	-.25	31	"	.25	39.2	"	-.28	26.3-26.6
"	-.3	21-27	"	.3	37.5	27	-.33	26.2
"	-.35	21	"	.35	34.8	"	-.38	25.9
"	-.4	14	"	.4	27	"	-.43	25.5
"	-.45	8	42.25	.45	23	"	-.48	25
"	-.5	3.5	"	.5	18.5	"	-.53	24.5
"	-.55	1	"	.6	13	"	-.58	24
"	-.6	0.5	"	.65	8.3	"	-.63	23.3
"	-.65	0	"	.7	5	"	-.68	22.5
			"	.75	3	"	-.73	21.8
			"	.8	2.2	"	-.78	21
			"	.85	1.6	"	-.83	20.3
			"	.95	1	"	-.88	19.3
						"	-.93	18
						"	-.98	17
						26.5	1.13	13.5
							1.18	12.5
							1.23	10.8
							1.28	9.5
							1.33	8
							1.38	7
							1.43	6.3
							1.48	5
							1.53	4.3
							1.58	3.5
							1.9	2

As the general form of the pressure curve has been already indicated, it may be assumed that its equation is of the form

$$y = ab^{-x^2} \quad (1)$$

But it has already been shown that for  $x=0$ ,  $y=h$ , hence  $a=h$ . To determine the remaining constant, the other condition may be used, that the solid formed by rotating the pressure curve represents the total pressure on the plane. The volume of the solid is

$$V = \int_0^{\infty} 2\pi xy dx \\ = 2\pi h \int_0^{\infty} b^{-x^2} dx \\ = (\pi h / \log_e b) \left[ -b^{-x^2} \right]_0^{\infty} \\ = \pi h / \log_e b.$$

Using the condition already stated,

$$2\omega \sqrt{h} x = \pi h / \log_e b, \\ \log_e b = (\pi / 2\omega) \sqrt{h/h} x.$$

Putting the value of  $b$  in (2) in eq. (1), and also  $r$  for the radius of the jet at the orifice, so that  $\omega = \pi r^2$ , the equation to the pressure curve is

$$y = hc^{-4} \sqrt{\frac{h}{r^2} \frac{x^2}{r^2}}.$$

§ 166. *Resistance of a Plane moving through a Fluid, or Pressure of a Current on a Plane.*—When a thin plate moves through the air, or through an indefinitely large mass of still water, in a direction normal to its surface, there is an excess of pressure on the anterior face and a diminution of pressure on the posterior face. Let  $v$  be the relative velocity of the plate and fluid,  $\Omega$  the area of the plate,  $G$  the density of the fluid,  $h$  the height due to the velocity, then the total resistance is expressed by the equation

$$R = fG\Omega v^2/2g \text{ pounds or } fG\Omega h;$$

where  $f$  is a coefficient having about the value 1.3 for a plate moving in still fluid, and 1.8 for a current impinging on a fixed plane, whether the fluid is air or water. The difference in the value of the coefficient in the two cases is perhaps due to errors of experiment. There is a similar resistance to motion in the case of all bodies of "unfair" form, that is, in which the surfaces over which the water slides are not of gradual and continuous curvature.

The stress between the fluid and plate arises chiefly in this way.

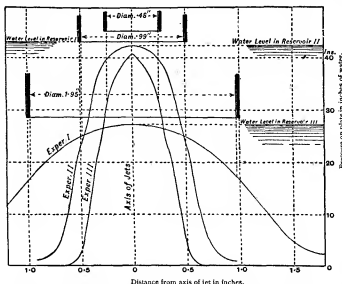

FIG. 168.—Curves of Pressure of Jets impinging normally on a Plane.

exactly in the axis of the jet, the pressure column was very nearly level with the free surface in the reservoir supplying the jet; that is, the pressure was very nearly  $v^2/2g$ . As the aperture moved away from the axis of the jet, the pressure diminished, and it became insensibly small at a distance from the axis of the jet about equal to the diameter of the jet. Hence, roughly, the pressure due to the jet extends over an area about four times the area of section of the jet.

The streams of fluid deviated in front of the plate, supposed for definiteness to be moving through the fluid, receive from it forward momentum. Portions of this forward moving water are thrown off laterally at the edges of the plate, and diffused through the surrounding fluid, instead of falling to their original position behind the plate. Other portions of comparatively still water are dragged into motion to fill the space left behind the plate; and there is thus a pressure less than hydrostatic pressure at the back of the plate. The whole resistance to the motion of the plate is the sum of the excess of pressure in front and deficiency of pressure behind. This resistance is independent of any friction or viscosity in the fluid, and is due simply to its inertia resisting a sudden change of direction at the edge of the plate.

Experiments made by a whirling machine, in which the plate is fixed on a long arm and moved circularly, gave the following values of the coefficient  $f$ . The method is not free from objection, as the centrifugal force causes a flow outwards across the plate.

Approximate Area of Plate in sq. ft.	Values of $f$ .		
	Borda.	Hutton.	Thibault.
0.13	1.39	1.24	..
0.25	1.49	1.43	1.525
0.63	1.64	..	..
1.11	..	..	1.784

There is a steady increase of resistance with the size of the plate, in part or wholly due to centrifugal action.

P. L. G. Du Buat (1723-1806) made experiments on a plane 1 ft. square, moved in a straight line in water at 3 to 64 ft. per second. Calling  $m$  the coefficient of excess of pressure in front, and  $n$  the coefficient of deficiency of pressure behind, so that  $f = m + n$ , he found the following values:—

$$m = 1; n = 0.433; f = 1.433.$$

The pressures were measured by pressure columns. Experiments by A. J. Morin (1795-1880), G. Pieter (1793-1871) and L. Didion (1798-1878) on plates of 0.3 to 2.7 sq. ft. area, drawn vertically through water, gave  $f = 2.18$ ; but the experiments were made in a reservoir of comparatively small depth. For similar plates moved through air they found  $f = 1.36$ , a result more in accordance with those which precede.

For a fixed plane in a moving current of water E. Mariotte found  $f = 2.15$ . Du Buat, in experiments in a current of water like those mentioned above, obtained the values  $m = 1.186$ ;  $n = 0.670$ ;  $f = 1.856$ . Thibault exposed to wind pressure planes of 1.17 and 2.5 sq. ft. area, and found  $f$  to vary from 1.658 to 2.125, the mean value being  $f = 1.834$ , a result agreeing well with Du Buat.

§ 167. *Stanton's Experiments on the Pressure of Air on Surfaces.*—At the National Physical Laboratory, London, T. E. Stanton carried out a series of experiments on the distribution of pressure on surfaces in a current of air passing through an air trunk. These were on a small scale but with exceptionally accurate means of measurement. These experiments differ from those already given in that the plane is small relatively to the cross section of the current (*Proc. Inst. Civ. Eng.* clvi., 1904). Fig. 169 shows the distribution of pressure on square plate  $ab$  is the plate in vertical section.  $acb$  the distribution of pressure on the windward and  $adb$  that on the leeward side of the central section. Similarly  $aeb$  is the distribution of pressure on the windward and  $afb$  on the leeward side of a diagonal section. The intensity of pressure at the centre of the plate on the windward side was in all cases  $P = Gv^2/2g$  lb per sq. ft., where  $G$  is the weight of a cubic foot of air and  $v$  the velocity of the current in ft. per sec. On the leeward side the negative pressure is uniform except near the edges, and its value depends on the form of the plate. For a circular plate the pressure on the leeward side was  $0.48 Gv^2/2g$  and for a rectangular plate  $0.66 Gv^2/2g$ . For circular or square plates the resultant pressure on the plate was  $P = 0.00126 v^2$  lb per sq. ft., where  $v$  is the velocity of the current in ft. per sec. On a long narrow rectangular plate the resultant pressure was nearly 60% greater than on a circular plate. In later tests on larger planes in free air, Stanton found resistances 18% greater than those observed with small planes in the air trunk.

§ 168. *Case when the Direction of Motion is oblique to the Plane.*—The determination of the pressure between a fluid and a plane in this case is of importance in many practical questions, for instance, in assigning the load due to wind pressure on sloping and curved roofs, and experiments have been made by Hutton, Vince, and Thibault on planes moved circularly through air and water on a whirling machine.

Let  $AB$  (fig. 170) be a plane moving in the direction  $R$  making an angle  $\phi$  with the plane. The resultant pressure between the fluid and the plane will be a normal pressure  $N$ . The component  $R$  of this normal pressure is the resistance to the motion of the plane and the other component  $L$  is a lateral force resisted by the guides which support the plane. Obviously

$$R = N \sin \phi;$$

$$L = N \cos \phi.$$

In the case of wind pressure on a sloping roof surface,  $R$  is the horizontal and  $L$  the vertical component of the normal pressure.

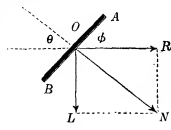

FIG. 170.

In experiments with the whirling machine it is the resistance to motion,  $R$ , which is directly measured. Let  $P$  be the pressure on a plane moved normally through a fluid. Then, for the same plane inclined at an angle  $\phi$  to its direction of motion, the resistance was found by Hutton to be

$$R = P(\sin \phi)^2 + 242 \cos \phi.$$

A simpler and more convenient expression given by Colonel Duchemin is

$$R = 2P \sin^2 \phi / (1 + \sin^2 \phi).$$

Consequently, the total pressure between the fluid and plane is

$$N = 2P \sin \phi / (1 + \sin^2 \phi) = 2P / (\operatorname{cosec} \phi + \sin \phi),$$

and the lateral force is

$$L = 2P \sin \phi \cos \phi / (1 + \sin^2 \phi).$$

In 1872 some experiments were made for the Aeronautical Society on the pressure of air on oblique planes. These plates, of 1 to 2 ft. square, were balanced by ingenious mechanism designed by F. H. Wenham and Spencer Browning, in such a manner that both the pressure in the direction of the air current and the lateral force were separately measured. These planes were placed opposite a blast from a fan issuing from a wooden pipe 18 in. square. The pressure of the blast varied from  $\frac{1}{8}$  to 1 in. of water pressure. The following are the results given in pounds per square foot of the plane, and a comparison of the experimental results with the pressures given by Duchemin's rule. These last values are obtained by taking  $P = 3.31$ , the observed pressure on a normal surface:—

Angle between Plane and Direction of Blast	15°	20°	60°	90°
Horizontal pressure $R$	0.4	0.61	2.73	3.31
Lateral pressure $L$	1.6	1.96	1.26	..
Normal pressure $\sqrt{L^2 + R^2}$	1.65	2.05	3.01	3.31
Normal pressure by Duchemin's rule	1.605	2.027	3.276	3.31

## WATER MOTORS

In every system of machinery deriving energy from a natural water-fall there exist the following parts:—

1. A supply channel or head race, leading the water from the highest accessible level to the site of the machine. This may be an open channel of earth, masonry or wood, laid at as small a slope as is consistent with the delivery of the necessary supply of water, or it may be a closed cast or wrought-iron pipe, laid at the natural slope of the ground, and about 3 ft. below the surface. In some cases part of the head race is an open channel, part a closed pipe. The channel often starts from a small storage reservoir, constructed near the stream supplying the water motor, in which the water accumulates when the motor is not working. There are sluices or penstocks by which the supply can be cut off when necessary.

2. Leading from the motor there is a tail race, culvert, or discharge pipe delivering the water after it has done its work at the lowest convenient level.

3. A waste channel, weir, or bye-wash is placed at the origin of the head race, by which surplus water, in floods, escapes.

4. The motor itself, of one of the kinds to be described presently, which either overcomes a useful resistance directly, as in the case of a ram acting on a lift or crane chain, or indirectly by actuating transmissive machinery, as when a turbine drives the shafting, belting and gearing of a mill. With the motor is usually combined regulating machinery for adjusting the power and speed to the work done. This may be controlled in some cases by automatic governing machinery.

§ 160. *Water Motors with Artificial Sources of Energy.*—The great convenience and simplicity of water motors has led to their adoption in certain cases, where no natural source of water power is available. In these cases, an artificial source of water power is created by using a steam-engine to pump water to a reservoir at a great elevation, or to pump water into a closed reservoir in which there is great pressure. The water flowing from the reservoir through hydraulic engines gives back the energy expended, less so much as has been wasted by friction. Such arrangements are most useful where a continuously acting steam engine stores up energy by pumping the water, while the work done by the hydraulic engines is done intermittently.

§ 170. *Energy of a Water-fall.*—Let  $H$  be the total fall of level from the point where the water is taken from a natural stream to the point where it is discharged into it again. Of this total fall a portion, which can be estimated independently, is expended in overcoming the resistances of the head and tail races or the supply and discharge pipes. Let this portion of head wasted be  $h_1$ . Then the available head to work the motor is  $H = H_1 - h_1$ . It is this available head which should be used in all calculations of the proportions of the motor. Let  $Q$  be the supply of water per second. Then  $QGH$  foot-pounds per second is the gross available work of the fall. The power of the fall may be utilized in three ways. (a) The  $Q$  G pounds of water may be placed on a machine at the highest level, and descending in contact with it a distance of  $H$  ft., the work done will be (neglecting losses from friction or leakage)  $QGH$  foot-pounds per second. (b) Or the water may descend in a closed pipe from the higher to the lower level, in which case, with the same reservation as before, the pressure at the foot of the pipe will be  $p = GH$  pounds per square foot. If the water with this pressure acts on a movable piston like that of a steam engine, it will drive the piston so that the volume described is  $Q$  cubic feet per second. Then the work done will be  $pQ = GHQ$  foot-pounds per second as before. (c) Or lastly, the water may be allowed to acquire the velocity  $v = \sqrt{2GH}$  by its descent. The kinetic energy of  $Q$  cubic feet will then be  $\frac{1}{2}Qv^2/g = QGH$ , and if the water is allowed to impinge on surfaces suitably curved which bring it finally to rest, it will impart to these the same energy as in the previous cases. (Motors which receive energy mainly in the three ways described in (a), (b), (c) may be termed gravity, pressure and inertia motors respectively. Generally, if  $Q$  ft. per second of water act by weight through a distance  $h_1$ , at a pressure  $p$  due to  $h_2$  ft. of fall, and with a velocity  $v$  due to  $h_3$  ft. of fall, so that  $h_1 + h_2 + h_3 = H$ , then, apart from energy wasted by friction or leakage or imperfection of the machine, the work done will be

$$GQh_1 + pQ + (G/2)Q(v^2/2g) = GQH \text{ foot pounds,}$$

the same as if the water acted simply by its weight while descending  $H$  ft.

§ 171. *Site for Water Motor.*—Wherever a stream flows from a higher to a lower level it is possible to erect a water motor. The amount of power obtainable depends on the available head and the supply of water. In choosing a site the engineer will select a portion of the stream where there is an abrupt natural fall, or at least a considerable slope of the bed. He will have regard to the facility of constructing the channels which are to convey the water, and will take advantage of any bend in the river which enables him to shorten them. He will have accurate measurements made of the quantity of water flowing in the stream, and he will endeavour to ascertain the average quantity available throughout the year, the minimum quantity in dry seasons, and the maximum for which bye-wash channels must be provided. In many cases the natural fall can be increased by a dam or weir thrown across the stream. The engineer will also examine to what extent the head will vary in different seasons, and whether it is necessary to sacrifice part of the fall and give a steep slope to the tail race to prevent the motor being drowned by backwater in floods. Streams fed from lakes which form natural reservoirs or fed from glaciers are less variable than streams depending directly on rainfall, and are therefore advantageous for water-power purposes.

§ 172. *Water Power at Holyoke, U.S.A.*—About 85 m. from the mouth of the Connecticut river there was a fall of about 60 ft. in a short distance, forming what were called the Grand Rapids, below which the river turned sharply, forming a kind of peninsula on which the city of Holyoke is built. In 1845 the magnitude of the water-power available attracted attention, and it was decided to build a dam across the river. The ordinary flow of the river is 6000 cub. ft. per sec., giving a gross power of 30,000 h.p. In dry seasons the power is 20,000 h.p., or occasionally less. From above the dam a system of canals takes the water to mills on three levels. The first canal starts with a width of 140 ft. and depth of 22 ft., and supplies

the highest range of mills. A second canal takes the water which has driven turbines in the highest mills and supplies it to a second series of mills. There is a third canal on a still lower level supplying the lowest mills. The water then finds its way back to the river. With the grant of a mill site is also lased the right to use the water-power. A mill-power is defined as 38 cub. ft. of water per sec. during 16 hours per day on a fall of 20 ft. This gives about 60 h.p. effective. The charge for the power water is at the rate of 20s. per h.p. per annum.

§ 173. *Action of Water in a Water Motor.*—Water motors may be divided into water-pressure engines, water-wheels and turbines.

Water-pressure engines are machines with a cylinder and piston or ram, in principle identical with the corresponding part of a steam-engine. The water is alternately admitted to and discharged from the cylinder, causing a reciprocating action of the piston or plunger. It is admitted at a high pressure and discharged at a low one, and consequently work is done on the piston. The water in these machines never acquires a high velocity, and for the most part the kinetic energy of the water is wasted. The useful work is due to the difference of the pressure of admission and discharge, whether that pressure is due to the weight of a column of water of more or less considerable height, or is artificially produced in ways to be described presently.

Water-wheels are large vertical wheels driven by water falling from a higher to a lower level. In most water-wheels, the water acts directly by its weight loading one side of the wheel and so causing rotation. But in all water-wheels a portion, and in some a considerable portion, of the work due to gravity is first employed to generate kinetic energy in the water; during its action on the water-wheel the velocity of the water diminishes, and the wheel is therefore in part driven by the impulse due to the change of the water's momentum. Water-wheels are therefore motors on which the water acts, partly by weight, partly by impulse.

Turbines are wheels, generally of small size compared with water wheels, driven chiefly by the impulse of the water. Before entering the moving part of the turbine, the water is allowed to acquire a considerable velocity; during its action on the turbine this velocity is diminished, and the impulse due to the change of momentum drives the turbine.

In designing or selecting a water motor it is not sufficient to consider only its efficiency in normal conditions of working. It is generally quite as important to know how it will act with a scanty water supply or a diminished head. The greatest difference in water motors is in their adaptability to varying conditions of working.

#### *Water-pressure Engines.*

§ 174. In these the water acts by pressure either due to the height of the column in a supply pipe descending from a high-level reservoir, or created by pumping. Pressure engines were first used in mine-pumping on waterfalls of greater height than could at that time be utilized by water wheels. Usually they were single acting, the water-pressure lifting the heavy pump rods which then made the return or pumping stroke by their own weight. To avoid losses by fluid friction and shock the velocity of the water in the pipes and passages was restricted to from 3 to 10 ft. per second, and the mean speed of plunger to 1 ft. per second. The stroke was long and the number of strokes 3 to 6 per minute. The pumping lift being constant, such engines worked practically always at full load, and the efficiency was high, about 84%. But they were cumbersome machines. They are described in Weisbach's *Mechanics of Engineering*.

The convenience of distributing energy from a central station to scattered working-points by pressure water conveyed in pipes—a system invented by Lord Armstrong—has already been mentioned. This system has led to the development of a great variety of hydraulic pressure engines of very various types. The cost of pumping the pressure water to some extent restricts its use to intermittent operations, such as working lifts and cranes, punching, shearing and riveting machines, forging and flanging presses. To keep down the cost of the distributing



mains very high pressures are adopted, generally 700 lb per sq. in. or 1600 ft. of head or more.

In a large number of hydraulic machines worked by water at high pressure, especially lifting machines, the motor consists of a direct, single acting ram and cylinder. In a few cases double-acting pistons and cylinders are used; but they involve a water-tight packing of the piston not easily accessible. In some cases pressure engines are used to obtain rotative movement, and then two double-acting cylinders or three single-acting cylinders are used, driving a crank shaft. Some double-acting cylinders have a piston rod half the area of the piston. The pressure water acts continuously on the annular area in front of the piston. During the forward stroke the pressure on the front of the piston balances half the pressure on the back. During the return stroke the pressure on the front is unopposed. The water in front of the piston is not exhausted, but returns to the supply pipe. As the frictional losses in a fluid are independent of the pressure, and the work done increases directly as the pressure, the percentage loss decreases for given velocities of flow as the pressure increases. Hence for high-pressure machines somewhat greater velocities are permitted in the passages than for low-pressure machines. In supply mains the velocity is from 3 to 6 ft. per second, in valve passages 5 to 10 ft. per second, or in extreme cases 20 ft. per second, where there is less object in economizing energy. As the water is incompressible, slide valves must have neither lap nor lead, and piston valves are preferable to ordinary slide valves. To prevent injurious compression from exhaust valves closing too soon in rotative engines with a fixed stroke, small self-acting relief valves are fitted to the cylinder ends, opening outwards against the pressure into the valve chest. Imprisoned water can then escape without overstraining the machines.

In direct single-acting lift machines, in which the stroke is fixed, and in rotative machines at constant speed it is obvious that the cylinder must be filled at each stroke irrespective of the amount of work to be done. The same amount of water is used whether much or little work is done, or whether great or small weights are lifted. Hence while pressure engines are very efficient at full load, their efficiency decreases as the load decreases. Various arrangements have been adopted to diminish this defect in engines working with a variable load. In lifting machinery there is sometimes a double ram, a hollow ram enclosing a solid ram. By simple arrangements the solid ram only is used for small loads, but for large loads the hollow ram is locked to the solid ram, and the two act as a ram of larger area. In rotative engines the case is more difficult. In Hastie's and Rigg's engines the stroke is automatically varied with the load, increasing when the load is large and decreasing when it is small. But such engines are complicated and have not achieved much success. Where pressure engines are used simplicity is generally a first consideration, and economy is of less importance.

§ 175. *Efficiency of Pressure Engines.*—It is hardly possible to form a theoretical expression for the efficiency of pressure engines, but some general considerations are useful. Consider the case of a long stroke hydraulic ram, which has a fairly constant velocity  $v$  during the stroke, and valves which are fairly wide open during most of the stroke. Let  $A$  be the ratio of area of ram to area of valve passage, a ratio which may vary in ordinary cases from 4 to 12. Then the loss in shock of the water entering the cylinder will be  $(v-1)^2/2g$  in ft. of head. The friction in the supply pipe is also proportional to  $v^2$ . The energy carried away in exhaust will be proportional to  $v^3$ . Hence the total hydraulic losses may be taken to be approximately  $\tau v^2/2g$  ft., where  $\tau$  is a coefficient depending on the proportions of the machine. Let  $f$  be the friction of the ram packing and mechanism reckoned in lb per sq. ft. of ram area. Then if the supply-pipe pressure driving the machine is  $p$  lb per sq. ft., the effective working pressure will be

$$p - G\tau v^2/2g - f \text{ lb per sq. ft.}$$

Let  $A$  be the area of the ram in sq. ft.,  $v$  its velocity in ft. per sec. The useful work done will be

$$(p - G\tau v^2/2g - f)Av \text{ ft. lb per sec.,}$$

and the efficiency of the machine will be

$$\eta = (p - G\tau v^2/2g - f)/p.$$

This shows that the efficiency increases with the pressure  $p$ , and diminishes with the speed  $v$ , other things being the same. If in

regulating the engine for varying load the pressure is throttled, part of the available head is destroyed at the throttle valve, and  $p$  in the bracket above is reduced. Direct-acting hydraulic lifts, without intermediate gearing, may have an efficiency of 95% during the working stroke. If a hydraulic lifter is used with ropes and sheaves to change the speed of the ram to the speed of the lift, the efficiency may be only 50%. E. B. Ellington has given the efficiency of lifts with hydraulic balance at 85% during the working stroke. Large pressure engines have an efficiency of 85%, but small rotative engines probably not more than 50% and that only when fully loaded.

§ 176. *Direct-Acting Hydraulic Lift* (fig. 171).—This is the simplest of all kinds of hydraulic motor. A cage  $W$  is lifted directly by water pressure acting in a cylinder  $C$ , the length of which is a little greater than the lift. A ram or plunger  $R$  of the same length is attached to the cage. The water-pressure admitted by a cock to the cylinder forces up the ram, and when the supply valve is closed and the discharge valve opened, the ram descends. In this case the ram is 9 in. diameter, with a stroke of 49 ft. It consists of lengths of wrought-iron pipe screwed together perfectly water-tight, the lower end being closed by a cast-iron plug. The ram works in a cylinder 11 in. diameter of 9 ft. lengths of flanged cast-iron pipe. The ram passes water-tight through the cylinder cover, which is provided with double hat leathers to prevent leakage outwards or inwards. As the weight of the ram and cage is much more than sufficient to cause a descent of the cage, part of the weight is balanced. A chain attached to the cage passes over a pulley at the top of the lift, and carries at its free end a balance weight  $B$ , working in  $T$  iron guides. Water is admitted to the cylinder from a 4-in. supply pipe through a two-way slide, worked by a rack, spindle and endless rope. The lift works under 73 ft. of head, and lifts 1350 lb at 2 ft. per second. The efficiency is from 75 to 80%.

The principal prejudicial resistance to the motion of a ram of this kind is the friction of the cup leathers which make the joint between the cylinder and ram. Some experiments by John Hick give for the friction of these leathers the following formula. Let  $F$  = the total friction in pounds;

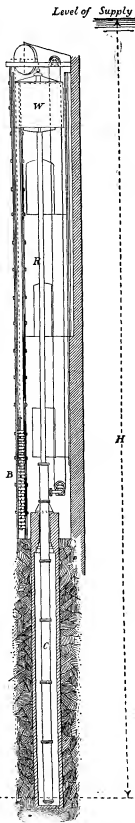

FIG. 171.

$d$  = diameter of ram in ft.;  $p$  = water-pressure in pounds per sq. ft.;  $k$  = coefficient.

$F = k p d$

$k = 0.00393$  if the leathers are new or badly lubricated;  
 $= 0.00262$  if the leathers are in good condition and well lubricated.

Since the total pressure on the ram is  $P = \frac{1}{2} \pi d^2 p$ , the fraction of the total pressure expended in overcoming the friction of the leathers is  $F/P = .0054/d$  to  $.0033/d$ ,  $d$  being in feet.

Let  $H$  be the height of the pressure column measured from the free surface of the supply reservoir to the bottom of the ram in its lowest position,  $H_2$  the height from the discharge reservoir to the same point,  $h$  the height of the ram above its lowest point at any moment,  $S$  the length of stroke,  $\Omega$  the area of the ram,  $W$  the weight of cage,  $R$  the weight of ram,  $B$  the weight of balance weight,  $w$  the weight of balance chain per foot run,  $F$  the friction of the cup leather and slides. Then, neglecting fluid friction, if the ram is rising the accelerating force is

$$P_1 = G(H-h)\Omega - R - W + B - w(S-h) + wh - F,$$

and if the ram is descending

$$P_2 = -G(H_2-h)\Omega + W + R - B + w(S-h) - wh - F.$$

If  $w = \frac{1}{2} G\Omega$ ,  $P_1$  and  $P_2$  are constant throughout the stroke; and the moving force in ascending and descending is the same, if

$$B = W + R + wS - G\Omega(H_2 + H)/2.$$

Using the values just found for  $w$  and  $B$ ,

$$P_1 = P_2 = \frac{1}{2} G\Omega(H_2 - H) - F.$$

Let  $W + R + wS + B = U$ , and let  $P$  be the constant accelerating force acting on the system, then the acceleration is  $(P/U)g$ . The velocity at the end of the stroke is (assuming the friction to be constant)

$$v = \sqrt{(2PgS/U)};$$

and the mean velocity of ascent is  $\frac{1}{2}v$ .

§ 177. *Armstrong's Hydraulic Jigger*.—This is simply a single-acting hydraulic cylinder and ram, provided with sheaves so as to give motion to a wire rope or chain. It is used in various forms of lift and crane. Fig. 172 shows the arrangement. A hydraulic ram or plunger  $B$  works in a stationary cylinder  $A$ . Ram and cylinder carry sets of sheaves over which passes a chain or rope, fixed at one end to the cylinder, and at the other connected over guide pulleys to a lift or crane. For each pair of pulleys, one on the cylinder and one on the ram, the movement of the free end of the rope is doubled compared with that of the ram. With three pairs of pulleys the free end of the rope has a movement equal to six times the stroke of the ram, the force exerted being in the inverse proportion.

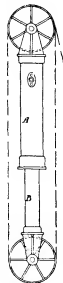

FIG. 172.

§ 178. *Rotative Hydraulic Engines*.—Valve-gear mechanism similar in principle to that of steam engines can be applied to actuate the admission and discharge valves, and the pressure engine is then converted into a continuously-acting motor.

Let  $H$  be the available fall to work the engine after deducting the loss of head in the supply and discharge pipes,  $Q$  the supply of water in cubic feet per second, and  $\eta$  the efficiency of the engine. Then the horse-power of the engine is

$$H.P. = \eta GQH/550.$$

The efficiency of large slow-moving pressure engines is  $\eta = .66$  to  $.8$ . In small motors of this kind probably  $\eta$  is not greater than  $.5$ . Let  $v$  be the mean velocity of the piston, then its diameter  $d$  is given by the relation

$$Q = \pi d^2 v / 4 \text{ in double-acting engines,} \\ = \pi d^2 v / 8 \text{ in single-acting engines.}$$

If there are  $n$  cylinders put  $Q/n$  for  $Q$  in these equations.

Small rotative pressure engines form extremely convenient motors for hoists, capstans or winches, and for driving small machinery. The single-acting engine has the advantage that the pressure of the piston on the crank pin is always in one direction; there is then no knocking as the dead centres are passed. Generally three single-acting cylinders are used, so that the engine will readily start in all positions, and the driving effort on the crank pin is very uniform.

*Brotherhood Hydraulic Engine*.—Three cylinders at angles of  $120^\circ$  with each other are formed in one casting with the frame. The

plungers are hollow trunks, and the connecting rods abut in cylindrical recesses in them and are connected to a common crank pin. A circular valve disk with concentric segmental ports revolves at the same rate as the crank over ports in the valve face common to the three cylinders. Each cylinder is always in communication with either an admission or exhaust port. The blank parts of the circular valve close the admission and exhaust ports alternately. The fixed valve face is of lignum vitae in a metal recess, and the revolving valve is of gun-metal. In the case of a small capstan engine the cylinders are  $\frac{3}{4}$  in. diameter and  $\frac{3}{4}$  in. stroke. At 40 revs. per minute, the piston speed is 31 ft. per minute. The ports are 1 in. diameter or  $\frac{1}{2}$  of the piston area, and the mean velocity in the ports 6.4 ft. per sec. With 700 lb per sq. in. water pressure and an efficiency of 50% the engine is about 3 h.p. A common arrangement is to have three parallel cylinders acting on a three-throw crank shaft, the cylinders oscillating on trunnions.

*Hastie's Engine*.—Fig. 173 shows a similar engine made by Messrs Hastie of Greenock.  $C$ ,  $G$ ,  $G$  are the three plungers which pass out of the cylinders through cup leathers, and act on the same crank pin.  $A$  is the inlet pipe which communicates with the cock  $B$ . This cock controls the action of the engine, being so constructed that it acts as a reversing valve when the handle  $C$  is in its extreme positions and as a brake when in its middle position. The ports of the cylinders are in communication with the exhaust. Two passages are formed in the framing leading from the cock  $B$  to the ends of the cylinders, one being in communication with the supply pipe  $A$ , the other with the discharge pipe  $D$ . These passages end as shown at  $E$ . The oscillation of the cylinders puts them alternately in communication with each of these passages, and thus the water is alternately admitted and exhausted.

In any ordinary rotative engine the length of stroke is invariable. Consequently the consumption of water depends simply on the speed of the engine, irrespective of the effort overcome. If the power of the engine must be varied without altering the number of rotations, then the stroke must be made variable. Messrs Hastie have contrived an exceedingly ingenious method of varying the stroke automatically, in proportion to the amount of work to be done (fig. 174). The crank pin  $I$  is carried in a slide  $H$  moving in a disk  $M$ . In this is a double cam  $K$  acting on two small steel rollers  $J$ ,  $L$  attached to the slide  $H$ . If the cam rotates it moves the slide and increases or decreases the radius of the circle in which the crank pin  $I$  rotates. The disk  $M$  is keyed on a hollow shaft surrounding the driving shaft  $P$ , to which the cam is attached.

The hollow shaft  $N$  has two snugs to which the chains  $RR$  are attached (fig. 175). The shaft  $P$  carries the spring case  $SS$  to which also are attached the other ends of the chains. When the engine is at rest the springs extend themselves, rotating the hollow shaft  $N$  and the frame  $M$ , so as to place the crank pin  $I$  at its nearest position to the axis of rotation. When a resistance has to be overcome, the shaft  $N$  rotates

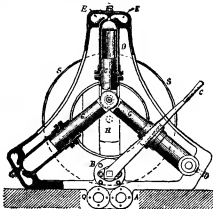

FIG. 173.

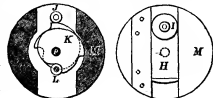

FIG. 174.

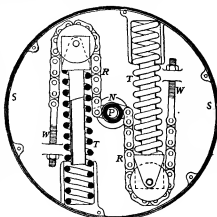

FIG. 175.

relatively to P, compressing the springs, till their resistance balances the pressure due to the resistance to the rotation of P. The engine then commences to work, the crank pin being in the position in which the turning effort just overcomes the resistance. If the resistance diminishes, the springs force out the chains and shorten the stroke of the plungers, and vice versa. The following experiments, on an engine of this kind working a hoist, show how the automatic arrangement adjusted the water used to the work done. The lift was 22 ft., and the water pressure in the cylinders 80 lb per sq. in.

Weight lifted, in lb	Chain only	427	633	745	857	969	1081	1193	
Water used, in gallons		7½	10	14	16	17	20	21	22

§ 170. *Accumulator Machinery.*—It has already been pointed out that it is in some cases convenient to use a steam engine to create an artificial head of water, which is afterwards employed in driving water-pressure machinery. Where power is required intermittently, for short periods, at a number of different points, as, for instance, in moving the cranes, lock gates, &c., of a dockyard, a separate steam engine and boiler at each point is very inconvenient; nor can engines worked from a common boiler be used, because of the great loss of heat and the difficulties which arise out of condensation in the pipes. If a tank, into which water is continuously pumped, can be placed at a great elevation, the water can then be used in hydraulic machinery in a very convenient way. Each hydraulic machine is put in communication with the tank by a pipe, and on opening a valve it commences work, using a quantity of water directly proportional to the work done. No attendance is required when the machine is not working.

A site for such an elevated tank is, however, seldom available, and in place of it a beautiful arrangement termed an accumulator, invented by Lord Armstrong, is used. This consists of a tall vertical cylinder; into this works a solid ram through cup leathers or hemp packing, and the ram is loaded by fixed weights, so that the pressure in the cylinder is 700 lb or 800 lb per sq. in. In some cases the ram is fixed and the cylinder moves on it.

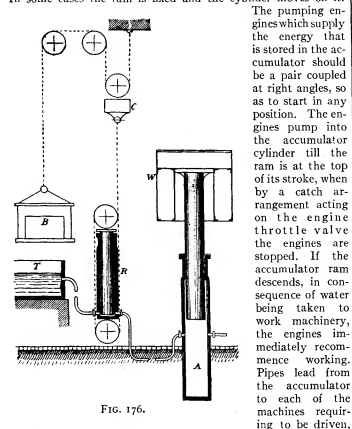

FIG. 176.

and do not require to be of large size, as the pressure is so great.

Fig. 176 shows a diagrammatic way the scheme of a system of accumulator machinery. A is the accumulator, with its ram carry-

ing a cylindrical wrought-iron tank W, in which weights are placed to load the accumulator. At R is one of the pressure engines or jiggers, worked from the accumulator, discharging the water after use into the tank T. In this case the pressure engine is shown working a set of blocks, the fixed block being on the ram cylinder, the running block on the ram. The chain running over these blocks works a lift cage C, the speed of which is as many times greater than that of the ram as there are plies of chain on the block tackle. B is the balance weight of the cage.

In the use of accumulators on shipboard for working gun gear or steering gear, the accumulator ram is loaded by springs, or by steam pressure acting on a piston much larger than the ram.

R. H. Tweddell has used accumulators with a pressure of 2000 lb per sq. in. to work hydraulic riveting machinery.

The amount of energy stored in the accumulator, having a ram  $d$  in. in diameter, a stroke of  $S$  ft., and delivering at  $p$  lb pressure per sq. in., is

$$\frac{\pi}{4} p d^2 S \text{ foot-pounds.}$$

Thus, if the ram is 9 in. the stroke 20 ft., and the pressure 800 lb per sq. in., the work stored in the accumulator when the ram is at the top of the stroke is 1,017,600 foot-pounds, that is, enough to drive a machine requiring one horse power for about half an hour. As, however, the pumping engine replaces water as soon as it is drawn off, the working capacity of the accumulator is very much greater than this. Tweddell found that an accumulator charged at 1250 lb discharged at 1225 lb per sq. in. Hence the friction was equivalent to  $12\frac{1}{2}$  lb per sq. in. and the efficiency 98%.

When a very great pressure is required a differential accumulator (fig. 177) is convenient. The ram is fixed and passes through both ends of the cylinder, but is of different diameters at the two ends, A and B. Hence if  $d_1$ ,  $d_2$  are the diameters of the ram in inches and  $p$  the required pressure in lb per sq. in., the load required is  $\frac{1}{2} p \pi (d_1^2 - d_2^2)$ . An accumulator of this kind used with riveting machines has  $d_1 = 5\frac{1}{2}$  in.,  $d_2 = 4\frac{1}{2}$  in. The pressure is 2000 lb per sq. in. and the load 5.4 tons.

Sometimes an accumulator is loaded by water or steam pressure instead of by a dead weight. Fig. 178 shows the arrangement. A piston A is connected to a plunger B of much smaller area. Water pressure, say from town mains, is admitted below A, and the high pressure water is pumped into and discharged from the cylinder C in which B works. If  $r$  is the ratio of the areas of A and B, then, neglecting friction, the pressure in the upper cylinder is  $r$  times that under the piston A. With a variable rate of supply and demand from the upper cylinder, the piston A rises and falls, maintaining always a constant pressure in the upper cylinder.

#### Water Wheels.

##### § 180. *Overshot and High Breast Wheels.*

—When a water fall ranges between 10 and 70 ft. and the water supply is from 3 to 25 cub. ft. per second, it is possible to construct a bucket wheel on which the water acts chiefly by its weight. If the variation of the head-water level does not exceed 2 ft., an overshot wheel may be used (fig. 179). The water is then projected over the summit of the wheel, and falls in a parabolic path into the buckets. With greater variation of head-water level, a pitch-back or high breast wheel is better. The water falls over the top of a sliding sluice into the wheel, on the same side as the head race channel. By adjusting the height of the sluice, the requisite supply is given to the wheel in all positions of the head-water level.

The wheel consists of a cast-iron or wrought-iron axle C supporting the weight of the wheel. To this are attached two

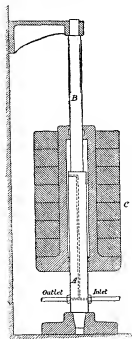

FIG. 177.

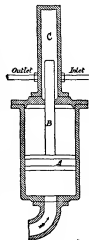

FIG. 178.

sets of arms A of wood or iron, which support circular segmental plates, B, termed shrouds. A cylindrical sole plate *dd* extends between the shrouds on the inner side. The buckets are formed

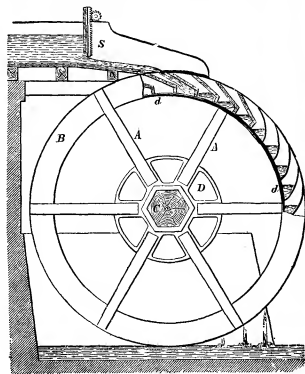

FIG. 179.

by wood planks or curved wrought-iron plates extending from shroud to shroud, the back of the buckets being formed by the sole plate.

The efficiency may be taken at 0.75. Hence, if *h.p.* is the effective horse power, *H* the available fall, and *Q* the available water supply per second,

$$h.p. = 0.75(GQH/550) = 0.085 QH.$$

If the peripheral velocity of the water wheel is too great, water is thrown out of the buckets before reaching the bottom of the fall. In practice, the circumferential velocity of water wheels of the kind now described is from  $4\frac{1}{2}$  to 10 ft. per second, about 6 ft. being the usual velocity of good iron wheels not of very small size. In order that the water may enter the buckets easily, it must have a greater velocity than the wheel. Usually the velocity of the water at the point where it enters the wheel is from 9 to 12 ft. per second, and to produce this it must enter the wheel at a point 16 to 27 in. below the head-water level. Hence the diameter of an overshot wheel may be

$$D = H - 1\frac{1}{2} \text{ to } H - 2\frac{1}{2} \text{ ft.}$$

Overshot and high breast wheels work badly in back-water, and hence if the tail-water level varies, it is better to reduce the diameter of the wheel so that its greatest immersion in flood is not more than 1 ft. The depth *d* of the shrouds is about 10 to 16 in. The number of buckets may be about

$$N = \pi D/d.$$

Let *v* be the peripheral velocity of the wheel. Then the capacity of that portion of the wheel which passes the sluice in one second is

$$Q_1 = \pi b(D-d^2)/D \\ = \pi b d \text{ nearly,}$$

*b* being the breadth of the wheel between the shrouds. If, however, this quantity of water were allowed to pass on to the wheel the buckets would begin to spill their contents almost at the top of the fall. To diminish the loss from spilling, it is not only necessary to give the buckets a suitable form, but to restrict the water supply to one-fourth or one-third of the gross bucket capacity. Let *m* be the value of this ratio; then, *Q* being the supply of water per second,

$$Q = mQ_1 = mbdv.$$

This gives the breadth of the wheel if the water supply is known. The form of the buckets should be determined thus. The outer element of the bucket should be in the direction of motion of the water entering relatively to the wheel, so that the water may enter without splashing or shock. The buckets should retain the water as long as possible, and the width of opening of the buckets should be  $\frac{2}{3}$  or  $\frac{3}{4}$  greater than the thickness of the sheet of water entering.

For a wooden bucket (fig. 180, A), take *ab* = distance between two buckets on periphery of wheel. Make *cd* =  $\frac{1}{2}$  *eb*, and *bc* =  $\frac{1}{2}$  to  $\frac{1}{4}$  *ab*. Join *cd*. For an iron bucket (fig. 180, B), take *ed* =  $\frac{1}{2}$  *eb*; *bc* =  $\frac{1}{2}$  *ab*. Draw *co* making an angle of  $10^\circ$  to  $15^\circ$  with the radius at *c*. On *Oc* take a centre giving a circular arc passing near *d*, and round the curve into the radial part of the bucket *de*.

There are two ways in which the power of a water wheel is given off to the machinery driven. In wooden wheels and wheels with rigid arms, a spur or bevil wheel keyed on the axle of the turbine will transmit

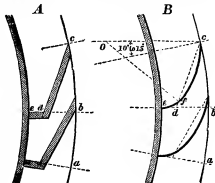

FIG. 180.

the power to the shafting. It is obvious that the whole turning moment due to the weight of the water is then transmitted through the arms and axle of the water wheel. When the water wheel is an iron one, it usually has light iron suspension arms incapable of resisting the bending action due to the transmission of the turning effort to the axle. In that case spur segments are bolted to one of the shrouds, and the pinion to which the power is transmitted is placed so that the teeth in gear are, as nearly as may be, on the line of action of the resultant of the weight of the water in the loaded arc of the wheel.

The largest high breast wheels ever constructed were probably the four wheels, each 50 ft. in diameter, and of 125 h.p., erected by Sir W. Fairbairn in 1825 at Catrine in Ayrshire. These wheels are still working.

§ 181. *Poncelet Water Wheel*.—When the fall does not exceed 6 ft., the best water motor to adopt in many cases is the Poncelet undershot water wheel. In this the water acts very nearly in the same way as in a turbine, and the Poncelet wheel, although slightly less efficient than the best turbines, in normal conditions of working, is superior to most of them when working with a reduced supply of water. A general notion of the action of the water on a Poncelet wheel has already been given in § 159. Fig. 181 shows its construction. The water penned back between the side walls of the wheel pit is allowed to flow to the

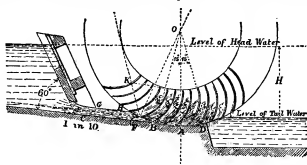

FIG. 181.

wheel under a movable sluice, at a velocity nearly equal to the velocity due to the whole fall. The water is guided down a slope of 1 in 10, or a curved race, and enters the wheel without shock. Gliding up the curved floats it comes to rest, falls back, and acquires at the point of discharge a backward velocity relative to the wheel nearly equal to the forward velocity of the wheel. Consequently it leaves the wheel deprived of nearly the whole of its original kinetic energy.

Taking the efficiency at 0.60, and putting *H* for the available fall, *h.p.* for the horse-power, and *Q* for the water supply per second,

$$h.p. = 0.068 QH.$$

The diameter *D* of the wheel may be taken arbitrarily. It should not be less than twice the fall and is more often four times the fall. For ordinary cases the smallest convenient diameter is 14 ft. with a straight, or 10 ft. with a curved, approach channel. The radial

depth of buckets should be at least half the fall, and radius of curvature of buckets about half the radius of the wheel. The shrouds are usually of cast iron with flanges to receive the buckets. The buckets may be of iron  $\frac{3}{4}$  in. thick bolted to the flanges with  $\frac{1}{8}$  in. bolts.

Let  $H'$  be the fall measured from the free surface of the head-water to the point  $F$  where the mean layer enters the wheel; then the velocity at which the water enters is  $v = \sqrt{2gH'}$ , and the best circumferential velocity of the wheel is  $V = 0.95v$  to  $0.6v$ . The number of rotations of the wheel per second is  $N = V/\pi D$ . The thickness of the sheet of water entering the wheel is very important. The best thickness according to experiment is 8 to 10 in. The maximum thickness should not exceed 12 to 15 in., when there is a surplus water supply. Let  $t$  be the thickness of the sheet of water entering the wheel, and  $b$  its width; then

$$bqv = Q; \text{ or } b = Q/vq.$$

Grashof takes  $e = \frac{1}{2}H$ , and then

$$b = 6Q/H\sqrt{2gH}.$$

Allowing for the contraction of the stream, the area of opening through the sluice may be 1.25  $bc$  to 1.3  $bc$ . The inside width of the wheel is made about 4 in. greater than  $b$ .

Several constructions have been given for the floats of Poncelet wheels. One of the simplest is that shown in figs. 181, 182.

Let  $OA$  (fig. 181) be the vertical radius of the wheel. Set off  $OB$ ,  $OD$  making angles of  $15^\circ$  with  $OA$ . Then  $BD$  may be the length of

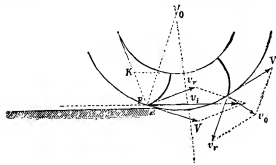

FIG. 182.

the close breasting fitted to the wheel. Draw the bottom of the head race  $BC$  at a slope of 1 in 10. Parallel to this, at distances  $\frac{1}{2}e$  and  $e$ , draw  $EF$  and  $GH$ . Then  $EF$  is the mean layer, and  $GH$  the surface layer entering the wheel. Join  $OF$ , and make  $\angle OFK = 23^\circ$ . Take  $FK = 0.5$  to  $0.7 H$ . Then  $K$  is the centre from which the bucket curve is struck and  $KF$  is the radius. The depth of the shrouds must be sufficient to prevent the water from rising over the top of the float. It is  $\frac{1}{2}H$  to  $\frac{3}{4}H$ . The number of buckets is not very important. They are usually 1 ft. apart on the circumference of the wheel.

The efficiency of a Poncelet wheel has been found in experiments to reach 0.68. It is better to take it at 0.6 in estimating the power of the wheel, so as to allow some margin.

In fig. 182  $v_1$  is the initial and  $v_2$  the final velocity of the water,  $v_0$  parallel to the vane the relative velocity of the water and wheel, and  $V$  the velocity of the wheel.

### Turbines.

§ 182. The name turbine was originally given in France to any water motor which revolved in a horizontal plane, the axis being vertical. The rapid development of this class of motors dates from 1827, when a prize was offered by the Société d'Encouragement for a motor of this kind, which should be an improvement on certain wheels then in use. The prize was ultimately awarded to Benoit Fourneyron (1802-1867), whose turbine, but little modified, is still constructed.

**Classification of Turbines.**—In some turbines the whole available energy of the water is converted into kinetic energy before the water acts on the moving part of the turbine. Such turbines are termed *Impulse* or *Action Turbines*, and they are distinguished by this that the wheel passages are never entirely filled by the water. To ensure this condition they must be placed a little above the tail water and discharge into free air. Turbines in which part only of the available energy is converted into kinetic energy before the water enters the wheel are termed *Pressure* or *Reaction Turbines*. In these there is a pressure which in some cases amounts to half the head in the clearance space between the guide vanes and wheel vanes. The velocity with which the water enters the wheel is due to the difference between the pressure due to the head and the pressure in the clearance space. In pressure turbines the wheel passages must

be continuously filled with water for good efficiency, and the wheel may be and generally is placed below the tail water level.

Some turbines are designed to act normally as impulse turbines discharging above the tail water level. But the passages are so designed that they are just filled by the water. If the tail water rises and drowns the turbine they become pressure turbines with a small clearance pressure, but the efficiency is not much affected. Such turbines are termed *Limit turbines*.

Next there is a difference of constructive arrangement of turbines, which does not very essentially alter the mode of action of the water. In axial flow or so-called parallel flow turbines, the water enters and leaves the turbine in a direction parallel to the axis of rotation, and the paths of the molecules lie on cylindrical surfaces concentric with that axis. In radial outward and inward flow turbines, the water enters and leaves the turbine in directions normal to the axis of rotation, and the paths of the molecules lie exactly or nearly in planes normal to the axis of rotation. In outward flow turbines the general direction of flow is away from the axis, and in inward flow turbines towards the axis. There are also mixed flow turbines in which the water enters normally and is discharged parallel to the axis of rotation.

Another difference of construction is this, that the water may be admitted equally to every part of the circumference of the turbine wheel or to a portion of the circumference only. In the former case, the condition of the wheel passages is always the same; they receive water equally in all positions during rotation. In the latter case, they receive water during a part of the rotation only. The former may be termed turbines with complete admission, the latter turbines with partial admission. A reaction turbine should always have complete admission. An impulse turbine may have complete or partial admission.

When two turbine wheels similarly constructed are placed on the same axis, in order to balance the pressures and diminish journal friction, the arrangement may be termed a twin turbine.

If the water, having acted on one turbine wheel, is then passed through a second on the same axis, the arrangement may be termed a compound turbine. The object of such an arrangement would be to diminish the speed of rotation.

Many forms of reaction turbine may be placed at any height not exceeding 30 ft. above the tail water. They then discharge into an air-tight suction pipe. The weight of the column of water in this pipe balances part of the atmospheric pressure, and the difference of pressure, producing the flow through the turbine, is the same as if the turbine were placed at the bottom of the fall.

I. Impulse Turbines.	II. Reaction Turbines.
(Wheel passages not filled, and discharging above the tail water.)	(Wheel passages filled, discharging above or below the tail water or into a suction-pipe.)
(a) Complete admission. (Rare.)	Always with complete admission.
(b) Partial admission. (Usual.)	Always with complete admission.

Axial flow, outward flow, inward flow, or mixed flow.

Simple turbines; twin turbines; compound turbines.

§ 183. *The Simple Reaction Wheel.*—It has been shown, in § 162, that, when water issues from a vessel, there is a reaction on the vessel tending to cause motion in a direction opposite to that of the jet. This principle was applied in a rotating water motor at a very early period, and the Scotch turbine, at one time much used, differs in no essential respect from the older form of reaction wheel.

The old reaction wheel consisted of a vertical pipe balanced on a vertical axis, and supplied with water (fig. 183). From the bottom of the vertical pipe two or more hollow horizontal arms extended, at the ends of which were orifices from which the water was discharged. The reaction of the jets caused the rotation of the machine.

Let  $H$  be the available fall measured from the level of the water in the vertical pipe to the centres of the orifices,  $r$  the radius from the axis of rotation to the centres of the orifices,  $v$  the velocity of discharge through the jets,  $\omega$  the angular velocity of



FIG. 183.

the machine. When the machine is at rest the water issues from the orifices with the velocity  $\sqrt{2gH}$  (friction being neglected). But when the machine rotates the water in the arms rotates also, and is in the condition of a forced vortex, all the particles having the same angular velocity. Consequently the pressure in the arms at the orifices is  $H + a^2v^2/2g$  ft. of water, and the velocity of discharge through the orifices is  $v = \sqrt{2g(H + a^2v^2)}$ . If the total area of the orifices is  $a$ , the quantity discharged from the wheel per second is

$$Q = av = av \sqrt{2g(H + a^2v^2)}$$

While the water passes through the orifices with the velocity  $v$ , the orifices are moving in the opposite direction with the velocity  $av$ . The absolute velocity of the water is therefore

$$v - av = \sqrt{2g(H + a^2v^2)} - av$$

The momentum generated per second is  $(GQ/g)(v - av)$ , which is numerically equal to the force driving the motor at the radius  $r$ . The work done by the water in rotating the wheel is therefore

$$(GQ/g)(v - ar)ar \text{ foot-pounds per sec.}$$

The work expended by the water fall is  $GQH$  foot-pounds per second. Consequently the efficiency of the motor is

$$\eta = \frac{(v - ar) ar}{gH} = \frac{\{ \sqrt{2g(H + a^2v^2)} - av \} ar}{gH}$$

$$\text{Let } \sqrt{2g(H + a^2v^2)} = av + \frac{gH}{ar} \frac{gH^2}{2a^2v^2} \dots$$

$$\text{then } \eta = 1 - gH/2ar + \dots$$

which increases towards the limit 1 as  $ar$  increases towards infinity. Neglecting friction, therefore, the maximum efficiency is reached when the wheel has an infinitely great velocity of rotation. But this condition is impracticable to realize, and even, at practicable but high velocities of rotation, the friction would considerably reduce the efficiency. Experiment seems to show that the best efficiency is reached when  $av = \sqrt{2gH}$ . Then the efficiency apart from friction is

$$\eta = \sqrt{1 - (2a^2v^2) - ar} \frac{ar}{gH} \\ = 0.414 a^2 v^2 / 2gH = 0.828,$$

about 17% of the energy of the fall being carried away by the water discharged. The actual efficiency realized appears to be about 6%, so that about 21% of the energy of the fall is lost in friction, in addition to the energy carried away by the water.

#### § 184. General Statement of Hydrodynamical Principles necessary for the Theory of Turbines.

(a) When water flows through any pipe-shaped passage, such as the passage between the vanes of a turbine wheel, the relation between the changes of pressure and velocity is given by Bernoulli's theorem (§ 29). Suppose that, at a section A of such a passage,  $h_1$  is the pressure measured in feet of water,  $v_1$  the velocity, and  $z_1$  the elevation above any horizontal datum plane, and that at a section B the same quantities are denoted by  $h_2$ ,  $v_2$ ,  $z_2$ . Then

$$h_1 - h_2 = (v_2^2 - v_1^2)/2g + z_2 - z_1. \quad (1)$$

If the flow is horizontal,  $z_2 = z_1$ ; and

$$h_1 - h_2 = (v_2^2 - v_1^2)/2g. \quad (1a)$$

(b) When there is an abrupt change of section of the passage, or an abrupt change of section of the stream due to a contraction, then, in applying Bernoulli's equation allowance must be made for the loss of head in shock (§ 36). Let  $v_1$ ,  $v_2$  be the velocities before and after the abrupt change, then a stream of velocity  $v_1$  impinges on a stream at a velocity  $v_2$ , and the relative velocity is  $v_1 - v_2$ . The head lost is  $(v_1 - v_2)^2/2g$ . Then equation (1a) becomes

$$h_1 - h_2 = (v_2^2 - v_1^2)/2g - (v_1 - v_2)^2/2g = v_2(v_1 - v_2). \quad (2)$$

To diminish as much as possible the loss of energy from irregular eddying motions, the change of section in the turbine passages must be very gradual, and the curvature without discontinuity.

(c) *Equality of Angular Impulse and Change of Angular Momentum.*—Suppose that a couple, the moment of which is  $M$ , acts on a body of weight  $W$  for  $t$  seconds, during which it moves from  $A_1$  to  $A_2$  (fig. 184). Let  $v_1$  be the velocity of the body at  $A_1$ ,  $v_2$  its velocity at  $A_2$ , and let  $p_1$ ,  $p_2$  be the perpendiculars from  $C$  on  $v_1$  and  $v_2$ . Then  $Mt$  is termed the angular impulse of the couple, and the quantity

$$(W/g)(v_2 p_2 - v_1 p_1)$$

is the change of angular momentum relatively to  $C$ . Then, from the equality of angular impulse and change of angular momentum

$$Mt = (W/g)(v_2 p_2 - v_1 p_1),$$

or, if the change of momentum is estimated for one second,

$$M = (W/g)(v_2 p_2 - v_1 p_1).$$

Let  $r_1$ ,  $r_2$  be the radii drawn from  $C$  to  $A_1$ ,  $A_2$ , and let  $w_1$ ,  $w_2$  be the components of  $v_1$ ,  $v_2$ , perpendicular to these radii, making angles  $\beta$  and  $\alpha$  with  $v_1$ ,  $v_2$ . Then

$$v_1 = w_1 \sec \beta; \quad v_2 = w_2 \sec \alpha;$$

$$p_1 = r_1 \cos \beta; \quad p_2 = r_2 \cos \alpha.$$

$$\therefore M = (W/g)(w_2 r_2 - w_1 r_1), \quad (3)$$

where the moment of the couple is expressed in terms of the radii drawn to the positions of the body at the beginning and end of a second, and the tangential components of its velocity at those points.

Now the water flowing through a turbine enters at the admission surface and leaves at the discharge surface of the wheel, with its angular momentum relatively to the axis of the wheel changed. It therefore exerts a couple  $-M$  tending to rotate the wheel, equal and opposite to the couple  $M$  which the wheel exerts on the water. Let  $Q$  cub. ft. enter and leave the wheel per second, and let  $w_1$ ,  $w_2$  be the tangential components of the velocity of the water at the receiving and discharging surfaces of the wheel,  $r_1$ ,  $r_2$  the radii of those surfaces. By the principle above,

$$-M = (GQ/g)(w_2 r_2 - w_1 r_1), \quad (4)$$

If  $\alpha$  is the angular velocity of the wheel, the work done by the water on the wheel is

$$T = Ma = (GQ/g)(w_2 r_2 - w_1 r_1) a \text{ foot-pounds per second.}$$

§ 185. *Partial and Headed Fall.*—Let  $H$  be the total difference of level from the head-water to the tail-water surface. Of this total head a portion is expended in overcoming the resistances of the head race, tail race, supply pipe, or other channel conveying the water. Let  $h_p$  be that loss of head, which varies with the local conditions in which the turbine is placed. Then

$$H = H - h_p,$$

is the available head for working the turbine, and on this the calculations for the turbine should be based. In some cases it is necessary to place the turbine above the tail-water level, and there is then a fall  $h$  from the centre of the outlet surface of the turbine to the tail-water level which is wasted, but which is properly one of the losses belonging to the turbine itself. In that case the velocities of the water in the turbine should be calculated for a head  $H - h$ , but the efficiency of the turbine for the head  $H$ .

§ 186. *Gross Efficiency and Hydraulic Efficiency of a Turbine.*—Let  $T_a$  be the useful work done by the turbine, in foot-pounds per second,  $T$  the work expended in friction of the turbine shaft, gearing, &c., a quantity which varies with the local conditions in which the turbine is placed. Then the effective work done by the water in the turbine is

$$T = T_a - T_f.$$

The gross efficiency of the whole arrangement of turbine, races, and transmissive machinery is

$$\eta = T_a / GQH, \quad (6)$$

And the hydraulic efficiency of the turbine alone is

$$\eta = T / GQH. \quad (7)$$

It is this last efficiency only with which the theory of turbines is concerned.

From equations (5) and (7) we get

$$\eta GQH = (GQ/g)(w_2 r_2 - w_1 r_1) a; \\ \eta = (w_2 r_2 - w_1 r_1) a / gH. \quad (8)$$

This is the fundamental equation in the theory of turbines. In general,  $w_1$  and  $w_2$ , the tangential components of the water's motion on entering and leaving the wheel, are completely independent. That the efficiency may be as great as possible, it is obviously necessary that  $w_2 = 0$ . In that case

$$\eta = w_1 r_1 a / gH. \quad (9)$$

$w_1$  is the circumferential velocity of the wheel at the inlet surface. Calling this  $V_1$ , the equation becomes

$$\eta = w_1 V_1 / gH. \quad (9a)$$

This remarkably simple equation is the fundamental equation in the theory of turbines. It was first given by Reiche (*Turbinenbau*, 1877).

§ 187. *General Description of a Reaction Turbine.*—Professor James Thomson's inward flow or vortex turbine has been selected as the type of reaction turbines. It is one of the best in normal conditions of working, and the mode of regulation introduced is decidedly superior to that in most reaction turbines. Figs. 185 and 186 are external views of the turbine case; figs. 187 and 188 are the corresponding sections; fig. 189 is the turbine wheel. The example chosen for illustration has suction pipes, which permit the turbine to be placed above the tail-water level. The water enters the turbine by cast-iron supply pipes at  $A$ , and is discharged through two suction pipes  $S$ ,  $S$ . The water

<sup>1</sup> In general, because when the water leaves the turbine wheel it ceases to act on the machine. If deflecting vanes or a whirlpool are added to a turbine at the discharging side, then  $v_1$  may in part depend on  $v_2$ , and the statement above is no longer true.

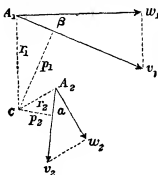

FIG. 184.

on entering the case distributes itself through a rectangular supply chamber SC, from which it finds its way equally to the four guide-blade passages G, G, G, G. In these passages it

in equal proportions from each guide-blade passage. It consists of a centre plate *b* (fig. 189) keyed on the shaft *aa*, which passes through stuffing boxes on the suction pipes. On each side of

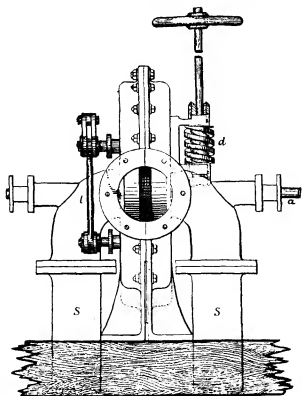

FIG. 185.

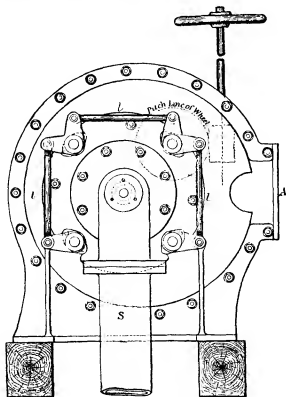

FIG. 186.

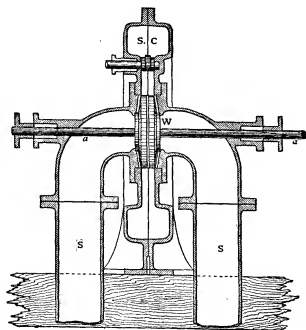

FIG. 187.

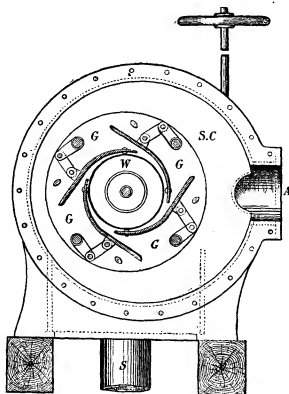

FIG. 188.

acquires a velocity about equal to that due to half the fall, and is directed into the wheel at an angle of about  $10^\circ$  or  $12^\circ$  with the tangent to its circumference. The wheel *W* receives the water

the centre plate are the curved wheel vanes, on which the pressure of the water acts, and the vanes are bounded on each side by dished or conical cover plates *c, c*. Joint-rings *j, j* on the cover

plates make a sufficiently water-tight joint with the casing, to prevent leakage from the guide-blade chamber into the suction pipes. The pressure near the joint rings is not very great, probably not one-fourth the total head. The wheel vane

receive the water without shock, and deliver it into central spaces, from which it flows on either side to the suction pipes. The mode of regulating the power of the turbine is very simple. The guide-blades are pivoted to the case at their inner ends, and they are connected by a link-work, so that they all open and close simultaneously and equally. In this way the area of opening through the guide-blades is altered without materially altering the angle or the other conditions of the delivery into the wheel. The guide-blade gear may be variously arranged.

In this example four

spindles, passing through the case, are linked to the guide-blades inside the case, and connected together by the links

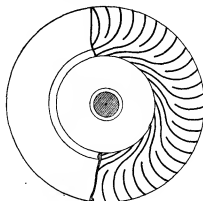

FIG. 189.

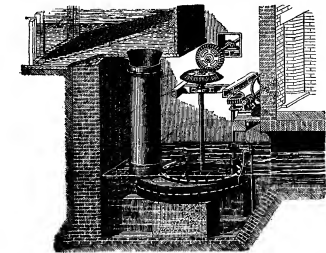

FIG. 190.

$l, l, l$  on the outside of the case. A worm wheel on one of the spindles is rotated by a worm  $d$ , the motion being thus slow

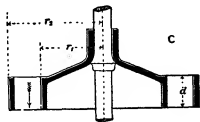
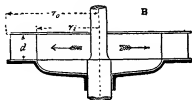
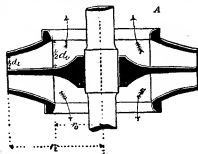

FIG. 192.

enough to adjust the guide-blades very exactly. These turbines are made by Messrs Gilkes & Co. of Kendal

Fig. 190 shows another arrangement of a similar turbine, with some adjuncts not shown in the other drawings. In this case the turbine rotates horizontally, and the turbine case is placed entirely below the tail water. The water is supplied to the turbine by a vertical pipe, over which is a wooden pentrough, containing a strainer, which prevents sticks and other solid bodies getting into the turbine. The turbine rests on three foundation stones, and the pivot for the vertical shaft being under water, there is a screw and lever arrangement for adjusting it as it wears. The vertical shaft gives motion to the machinery driven by a pair of bevel wheels. On the right are the worm and wheel for working the guide-blade gear.

§ 188. *Hydraulic Power at Niagara.*—The largest development of hydraulic power is that at Niagara. The Niagara Falls Power Company have constructed two power houses on the United States side, the first with 10 turbines of 5000 h.p. each, and the second with 10 turbines of 5500 h.p. The effective fall is 136 to 140 ft. In the first power house the turbines are twin outward flow reaction turbines with vertical shafts running at 250 revs. per minute and driving the dynamos direct. In the second power house the turbines

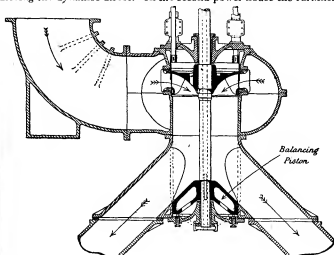

FIG. 191.

are inward flow turbines with draft tubes or suction pipes. Fig. 191 shows a section of one of these turbines. There is a balancing piston keyed on the shaft, to the under side of which the pressure due to the fall is admitted, so that the weight of turbine, vertical shaft, and part of the dynamo is water borne. About 70,000 h.p. is daily distributed electrically from these two power houses. The Canadian Niagara Power Company are erecting a power house to contain eleven units of 10,250 h.p. each, the turbines being twin inward flow reaction turbines. The Electrical Development Company of Ontario are erecting a power house to contain 11 units of 12,500 h.p. each. The Ontario Power Company are carrying out another scheme for developing 200,000 h.p. by twin inward flow turbines of 12,000 h.p. each. Lastly the Niagara Falls Power and Manufacturing Company on the United States side have a station giving 35,000 h.p. and are constructing another to furnish 100,000 h.p. The mean flow of the Niagara river is about 222,000 cub. ft. per second with a fall of 160 ft. The works in progress if completed will utilize 650,000 h.p. and require 48,000 cub. ft. per second of 21% of the mean flow of the river (Unwin, "The Niagara Falls Power Stations," *Proc. Inst. Mech. Eng.*, 1906).

§ 189. *Different Forms of Turbine Wheel.*—The wheel of a turbine or part of the machine on which the water acts is an annular space, furnished with curved vanes dividing it into passages exactly or

partially rectangular in cross section. For radial flow turbines the wheel may have the form A or B, fig. 192, A being most usual with



inward, and B with outward flow turbines. In A the wheel vanes are fixed on each side of a centre plate keyed on the turbine shaft. The vanes are limited by slightly-coned annular cover plates. In B the vanes are fixed on one side of a disk, keyed on the shaft, and limited by a cover plate parallel to the disk. Parallel flow or axial flow turbines have the wheel as in C. The vanes are limited by two concentric cylinders.

### Theory of Reaction Turbines.

§ 190. *Velocity of Whirl and Velocity of Flow.*—Let  $acb$  (fig. 193) be the path of the particles of water in a turbine wheel. That

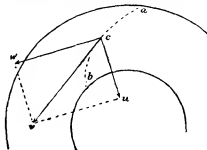

FIG. 193.

plane will be in a plane normal to the axis of rotation in radial flow turbines, and on a cylindrical surface in axial flow turbines. At any point  $c$  of the path the water will have some velocity  $v$ , in the direction of a tangent to the path. That velocity may be resolved into two components, a whirling velocity  $w$  in the direction of the wheel's rotation at the point  $c$ , and a component  $u$  at right angles to this, radial in radial flow, and parallel to the axis in axial flow turbines. This second component is termed the velocity of flow. Let  $v_0, w_0, u_0$  be the velocity of the water, the whirling velocity and velocity of flow at the outlet surface of the wheel, and  $v_1, w_1, u_1$  the same quantities at the inlet surface of the wheel. Let  $\alpha$  and  $\beta$  be the angles which the water's direction of motion makes with the direction of motion of the wheel at those surfaces. Then

$$\begin{aligned} w_0 &= v_0 \cos \beta; & u_0 &= v_0 \sin \beta \\ w_1 &= v_1 \cos \alpha; & u_1 &= v_1 \sin \alpha \end{aligned} \quad (10)$$

The velocities of flow are easily ascertained independently from the dimensions of the wheel. The velocities of flow at the inlet and outlet surfaces of the wheel are normal to those surfaces. Let  $\Omega$  be the areas of the outlet and inlet surfaces of the wheel, and  $Q$  the volume of water passing through the wheel per second; then

$$v_0 = Q/\Omega_0; \quad v_1 = Q/\Omega_1 \quad (11)$$

Using the notation in fig. 191, we have, for an inward flow turbine (neglecting the space occupied by the vanes),

$$\Omega_0 = 2\pi r_0 d_0; \quad \Omega_1 = 2\pi r_1 d_1 \quad (12a)$$

Similarly, for an outward flow turbine,

$$\Omega_0 = 2\pi r_0 d; \quad \Omega_1 = 2\pi r_1 d; \quad (12b)$$

and, for an axial flow turbine,

$$\Omega_0 = \Omega_1 = \pi(r_2^2 - r_1^2) \quad (12c)$$

*Relative and Common Velocity of the Water and Wheel.*—There is another way of resolving the velocity of the water. Let  $V$  be the velocity of the wheel at the point  $c$ , fig. 194. Then the velocity of the water may be resolved into a component  $V$ , which the water has in common with the wheel, and a component  $v_r$ , which is the velocity of the water relatively to the wheel.

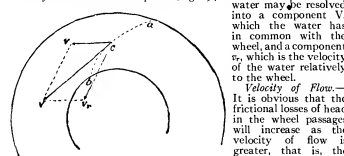

FIG. 194.

It is obvious that the frictional losses of head in the wheel passages will increase as the velocity of flow is greater, that is, the smaller the wheel is made. But if the wheel works under water, the skin friction of the wheel cover increases as the diameter of the wheel is made greater, and in any case the weight of the wheel and consequently the journal friction increase as the wheel is made larger. It is therefore desirable to choose, for the velocity of flow, as large a value as is consistent with the condition that the frictional losses in the wheel passages are a small fraction of the total head.

The values most commonly assumed in practice are these:—

$$\text{In axial flow turbines, } u_0 = u_1 = 0.15 \text{ to } 0.2 \sqrt{2gH};$$

$$\text{In outward flow turbines, } u_0 = 0.25 \sqrt{2g(H-0.2)};$$

$$u_1 = 0.21 \text{ to } 0.17 \sqrt{2g(H-0.2)};$$

$$\text{In inward flow turbines, } u_0 = u_1 = 0.125 \sqrt{2gH}.$$

§ 191. *Speed of the Wheel.*—The best speed of the wheel depends partly on the frictional losses, which the ordinary theory of turbines

disregards. It is best, therefore, to assume for  $V_0$  and  $V_1$  values which experiment has shown to be most advantageous.

In axial flow turbines, the circumferential velocities at the mean radius of the wheel may be taken

$$V_0 = V_1 = 0.6 \sqrt{2gH} \text{ to } 0.66 \sqrt{2gH}.$$

In a radial outward flow turbine,

$$V_1 = 0.56 \sqrt{2g(H-0.5)}$$

$$V_0 = V_1 r_0 / r_1,$$

where  $r_0, r_1$  are the radii of the outlet and inlet surfaces.

In a radial inward flow turbine,

$$V_1 = 0.66 \sqrt{2gH},$$

$$V_0 = V_1 r_0 / r_1.$$

If the wheel were stationary and the water flowed through it, the water would follow paths parallel to the wheel vane curves, at least when the vanes were so close that irregular motion was prevented. Similarly, when the wheel is in motion, the water follows paths relatively to the wheel, which are curves parallel to the wheel vanes. Hence the relative component,  $v_r$ , of the water's motion at  $c$  is tangential to a wheel vane curve drawn through the point  $c$ . Let  $v_0, V_0, u_0$  be the velocity of the water and its common and relative components at the outlet surface of the wheel, and let  $v_1, V_1, u_1$  be the same quantities at the inlet surface; and let  $\theta$  and  $\phi$  be the angles the wheel vanes make with the inlet and outlet surfaces; then

$$\begin{aligned} v_r^2 &= \sqrt{(v_0^2 + V_0^2 - 2V_0 v_0 \cos \phi)} \\ v_r &= \sqrt{(v_1^2 + V_1^2 - 2V_1 v_1 \cos \theta)} \end{aligned} \quad (13)$$

equations which may be used to determine  $\phi$  and  $\theta$ .

§ 192. *Condition determining the Angle of the Vanes at the Outlet Surface of the Wheel.*—It has been shown that, when the water leaves

the wheel, it should have no tangential velocity, if the efficiency is to be as great as possible; that is,  $w_0 = 0$ . Hence, from (10),  $\cos \beta = 0$ ,  $\beta = 90^\circ$ ,  $u_0 = v_0$ , and the direction of the water's motion is normal to the outlet surface of the wheel, radial in radial flow, and axial in axial flow turbines.

Drawing  $v_0$  or  $u_0$  radial or axial as the case may be, and  $V_0$  tangential to the direction of motion,  $v_{r0}$  can be found by the parallelogram of velocities. From fig. 195,

$$\tan \phi = v_{r0}/V_0 = u_0/V_0; \quad (14)$$

but  $\phi$  is the angle which the wheel vane makes with the outlet surface of the wheel, which is thus determined when the velocity of flow  $u_0$  and velocity of the wheel  $V_0$  are known. When  $\phi$  is thus determined,

$$v_{r0} = u_0 \operatorname{cosec} \phi = V_0 \sqrt{1 + u_0^2/V_0^2}. \quad (14a)$$

*Correction of the Angle  $\phi$  to allow for Thickness of Vanes.*—In determining  $\phi$ , it is most convenient to calculate its value approximately at first, from a value of  $u_0$  obtained by neglecting the thickness of the vanes. As, however, this angle is the most important angle in the turbine, the value should be afterwards corrected to allow for the vane thickness.

Let

$$\phi' = \tan^{-1}(u_0/V_0) = \tan^{-1}(Q/\Omega_0 V_0)$$

be the first or approximate value of  $\phi$ , and let  $t$  be the thickness, and  $n$  the number of wheel vanes which reach the outlet surface of the wheel. As the vanes cut the outlet surface approximately at the angle  $\phi'$ , their width measured on that surface is  $t \operatorname{cosec} \phi'$ . Hence the space occupied by the vanes on the outlet surface is

$$\begin{aligned} \text{For A, fig. 192, } ntd \operatorname{cosec} \phi \\ \text{B, fig. 192, } ntd \operatorname{cosec} \phi \\ \text{C, fig. 192, } nt(r_2 - r_1) \operatorname{cosec} \phi \end{aligned} \quad (15)$$

Call this area occupied by the vanes  $\omega$ . Then the true value of the clear discharging outlet of the wheel is  $\Omega_0 - \omega$ , and the true value of  $u_0$  is  $Q/(\Omega_0 - \omega)$ . The corrected value of the angle of the vanes will be

$$\phi = \tan^{-1}[Q/(\Omega_0 - \omega)]. \quad (16)$$

§ 193. *Head producing Velocity with which the Water enters the Wheel.*—Consider the variation of pressure in a wheel passage, which satisfies the condition that the sections change so gradually that there is no loss of head in shock. When the flow is in a horizontal plane, there is no work done by gravity on the water passing through the wheel. In the case of an axial flow turbine, in which the flow is vertical, the fall  $d$  between the inlet and outlet surfaces should be taken into account.

Let  $V_i, V_o$  be the velocities of the wheel at the inlet and outlet surfaces,

$v_i, v_o$  the velocities of the water,  
 $u_i, u_o$  the velocities of flow,  
 $v_{r_i}, v_{r_o}$  the relative velocities,  
 $h_i, h_o$  the pressures, measured in feet of water,  
 $r_i, r_o$  the radii of the wheel,  
 $\theta$  the angular velocity of the wheel.

At any point in the path of a portion of water, at radius  $r$ , the velocity  $v$  of the water may be resolved into a component  $V = ar$  equal to the velocity at that point of the wheel, and a relative component  $v_r$ . Hence the motion of the water may be considered to consist of two parts:—(a) a motion identical with that in a forced vortex of constant angular velocity  $a$ ; (b) a flow along curves parallel to the wheel vane curves. Taking the latter first, and using Bernoulli's theorem, the change of pressure due to flow through the wheel passages is given by the equation

$$h'_i + v_r^2/2g = h'_o + v_r^2/2g;$$

$$h'_i - h'_o = (v_{r_i}^2 - v_{r_o}^2)/2g.$$

The variation of pressure due to rotation in a forced vortex is

$$h'_i - h'_o = (V_i^2 - V_o^2)/2g.$$

Consequently the whole difference of pressure at the inlet and outlet surfaces of the wheel is

$$h_i - h_o = h'_i + h'_o - h'_o - h'_o = h'_o + (V_i^2 - V_o^2)/2g + (v_{r_i}^2 - v_{r_o}^2)/2g. \quad (17)$$

Case 1. *Axial Flow Turbines.*— $V_i = V_o$ ; and the first term on the right, in equation 17, disappears. Adding, however, the work of gravity due to a fall of  $d$  ft. in passing through the wheel,

$$h_i - h_o = (v_{r_i}^2 - v_{r_o}^2)/2g - d. \quad (17a)$$

Case 2. *Outward Flow Turbines.*—The inlet radius is less than the outlet radius, and  $(V_i^2 - V_o^2)/2g$  is negative. The centrifugal head diminishes the pressure at the inlet surface, and increases the velocity with which the water enters the wheel. This somewhat increases the frictional loss of head. Further, if the wheel varies in velocity from variations in the useful work done, the quantity  $(V_i^2 - V_o^2)/2g$  increases when the turbine speed increases, and vice versa. Consequently the flow into the turbine increases when the speed increases, and diminishes when the speed diminishes, and this again augments the variation of speed. The action of the centrifugal head in an outward flow turbine is therefore prejudicial to steadiness of motion. For this reason  $r_o/r_i$  is made small, generally about 5:4. Even then a governor is sometimes required to regulate the speed of the turbine.

Case 3. *Inward Flow Turbines.*—The inlet radius is greater than the outlet radius, and the centrifugal head diminishes the velocity of flow into the turbine. This tends to diminish the frictional losses, but it has a more important influence in securing steadiness of motion. Any increase of speed diminishes the flow into the turbine, and vice versa. Hence the variation of speed is less than the variation of resistance overcome. In the so-called centre vent wheels in America, the ratio  $r_o/r_i$  is about 5:4, and then the influence of the centrifugal head is not very important. Professor James Thomson first pointed out the advantage of a much greater difference of radii. By making  $r_o/r_i = 2:1$ , the centrifugal head balances about half the head in the supply chamber. Then the velocity through the guide-blades does not exceed the velocity due to half the fall, and the action of the centrifugal head in securing steadiness of speed is considerable.

Since the total head producing flow through the turbine is  $H - b$ , and of this  $h_i - h_o$  is expended in overcoming the pressure in the wheel, the velocity of flow into the wheel is

$$v_i = c_v \sqrt{2g(H - b - (V_i^2 - V_o^2)/2g + (v_{r_i}^2 - v_{r_o}^2)/2g)}, \quad (18)$$

where  $c_v$  may be taken 0.96.

From (14a),

$$v_{r_i} = V_o \sqrt{1 + u_i^2/V_o^2}.$$

It will be shown immediately that

$$v_{r_i} = u_i \cos \theta;$$

or, as this is only a small term, and  $\theta$  is on the average  $90^\circ$ , we may take, for the present purpose,  $v_{r_i} = u_i$  nearly.

In inserting these values, and remembering that for an axial flow turbine  $V_i = V_o$ ,  $b = 0$ , and the fall  $d$  in the wheel is to be added,

$$v_i = c_v \sqrt{2g \left\{ H - \frac{V_o^2}{2g} \left( 1 + \frac{u_i^2}{V_o^2} \right) + \frac{u_i^2}{2g} - d \right\}}.$$

For an outward flow turbine,

$$v_i = c_v \sqrt{2g \left\{ H - b - \frac{V_o^2}{2g} \left( 1 + \frac{u_i^2}{V_o^2} \right) + \frac{u_i^2}{2g} \right\}}.$$

For an inward flow turbine,

$$v_i = c_v \sqrt{2g \left\{ H - \frac{V_o^2}{2g} \left( 1 + \frac{u_i^2}{V_o^2} \right) + \frac{u_i^2}{2g} \right\}}.$$

§ 194. *Angle which the Guide-Blades make with the Circumference of the Wheel.*—At the moment the water enters the wheel, the radial component of the velocity is  $u_i$ , and the velocity is  $v_i$ . Hence, if  $\gamma$  is the angle between the guide-blades and a tangent to the wheel

$$\gamma = \sin^{-1}(u_i/v_i).$$

This angle can, if necessary, be corrected to allow for the thickness of the guide-blades.

§ 195. *Condition determining the Angle of the Vanes at the Inlet Surface of the Wheel.*—The single condition necessary to be satisfied at the inlet surface of the wheel is that the water should enter the wheel without shock. This condition is satisfied if the direction of relative motion of the water and wheel is parallel to the first element of the wheel vanes.

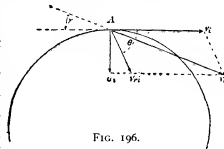

FIG. 196.

Let  $A$  (fig. 196) be a point on the inlet surface of the wheel, and let  $v_i$  represent in magnitude and direction the velocity of the water entering the wheel, and  $V_t$  the velocity of the wheel. Completing the parallelogram,  $v_r$  is the direction of relative motion. Hence the angle between  $v_i$  and  $V_t$  is the angle  $\theta$  which the vanes should make with the inlet surface of the wheel.

§ 196. *Example of the Method of designing a Turbine.*—Professor James Thomson's Inward Flow Turbine.—

Let  $H$  = the available fall after deducting loss of head in pipes and channels from the gross fall;

$Q$  = the supply of water in cubic feet per second; and  $\eta$  = the efficiency of the turbine.

The work done per pound per second is  $\eta Q H$ , and the horse-power of the turbine is  $h.p. = \eta Q H / 550$ . If  $\eta$  is taken at 0.75, an allowance will be made for the frictional losses in the turbine, the leakage and the friction of the turbine shaft. Then  $h.p. = 0.085 Q H$ .

The velocity of flow through the turbine (uncorrected for the space occupied by the vanes and guide-blades) may be taken

$$u_i = u_o = 0.125 \sqrt{2gH},$$

in which case about  $\frac{1}{2}$ th of the energy of the fall is carried away by the water discharged.

The areas of the outlet and inlet surface of the wheel are then

$$2\pi r_o d_o = 2\pi r_i d_i = Q / 0.125 \sqrt{2gH}.$$

If we take  $r_o$ , so that the axial velocity of discharge from the central orifices of the wheel is equal to  $u_o$ , we get

$$r_o = 0.3984 \sqrt{Q \sqrt{H}},$$

$$d_o = r_o.$$

If, to obtain considerable steadying action of the centrifugal head,  $r_i = 2r_o$ , then  $d_i = \frac{1}{2}d_o$ .

*Speed of the Wheel.*—Let  $V_i = 0.66 \sqrt{2gH}$ , or the speed due to half the fall nearly. Then the number of rotations of the turbine per second is

$$N = V_i / 2\pi r_i = 1.0579 \sqrt{H \sqrt{H} / Q};$$

also  $V_o = V_i r_o / r_i = 0.33 \sqrt{2gH}$ .

*Angle of Vanes with Outlet Surface.*

$$\tan \phi = u_o / V_o = 0.125 / 0.33 = 37.88;$$

$$\phi = 21^\circ \text{ nearly.}$$

If this value is revised for the vane thickness it will ordinarily become about  $25^\circ$ .

*Velocity with which the Water enters the Wheel.*—The head producing the velocity is

$$H - (V_i^2/2g)(1 + u_i^2/V_i^2) + u_i^2/2g$$

$$= H \{ 1 - 4.356(1 + 0.0358) + 0.156 \}$$

$$= 0.5646H.$$

Then the velocity is

$$V_i = 96 \sqrt{2g(0.5646H)} = 0.721 \sqrt{2gH}.$$

*Angle of Guide-Blades.*

$$\sin \gamma = u_i / v_i = 0.125 / 0.721 = 0.173;$$

$$\gamma = 10^\circ \text{ nearly.}$$

*Tangential Velocity of Water entering Wheel.*

$$u_i = v_i \cos \gamma = 0.7101 \sqrt{2gH}.$$

*Angle of Vanes at Inlet Surface.*

$$\cot \theta = (u_i - V_i) / u_i = (-7.101 - 66) / 125 = -4.008;$$

$$\theta = 68^\circ \text{ nearly.}$$

*Hydraulic Efficiency of Wheel.*

$$\eta = u_i V_i / gH = 7.101 \times 66 \times 2$$

$$= 0.937.$$

This, however, neglects the friction of wheel covers and leakage. The efficiency from experiment has been found to be 0.75 to 0.80.

*Impulse and Partial Admission Turbines.*

§ 197. The principal defect of most turbines with complete admission is the imperfection of the arrangements for working with less than the normal supply. With many forms of reaction turbine the efficiency is considerably reduced when the regulating

sluices are partially closed, but it is exactly when the supply of water is deficient that it is most important to get out of it the greatest possible amount of work. The imperfection of the regulating arrangements is therefore, from the practical point of view, a serious defect. All turbine makers have sought by various methods to improve the regulating mechanism. B. Fourneyron, by dividing his wheel by horizontal diaphragms, virtually obtained three or more separate radial flow turbines, which could be successively set in action at their full power, but the arrangement is not altogether successful, because of the spreading of the water in the space between the wheel and guide-blades. Fontaine similarly employed two concentric axial flow turbines formed in the same casing. One was worked at full power, the other regulated. By this arrangement the loss of efficiency due to the action of the regulating sluice affected only half the water power. Many makers have adopted the expedient of erecting two or three separate turbines on the same waterfall. Then one or more could be put out of action and the others worked at full power. All these methods are rather palliatives than remedies. The movable guide-blades of Professor James Thomson meet the difficulty directly, but they are not applicable to every form of turbine.

C. Callon, in 1840, patented an arrangement of sluices for axial or outward flow turbines, which were to be closed successively as the water supply diminished. By preference the sluices were closed by pairs, two diametrically opposite sluices forming a pair. The water was thus admitted to opposite but equal arcs of the wheel, and the forces driving the turbine were symmetrically placed. As soon as this arrangement was adopted,

portion of the sluice, and stopped each time it passes a closed portion of the sluice. It is thus put into motion and stopped twice in each rotation. This gives rise to violent eddying motions and great loss of energy in shock. To prevent this, the turbine wheel with partial admission must be placed above the tail water, and the wheel passages be allowed to clear themselves of water, while passing from one open portion of the sluices to the next.

But if the wheel passages are free of water when they arrive at the open guide passages, then there can be no pressure other than atmospheric pressure in the clearance space between guides and wheel. The water must issue from the sluices with the whole velocity due to the head; received on the curved vanes of the wheel, the jets must be gradually deviated and discharged with a small final velocity only, precisely in the same way as when a single jet strikes a curved vane in the free air. Turbines of this kind are therefore termed turbines of free deviation. There is no variation of pressure in the jet during the whole time of its action on the wheel, and the whole energy of the jet is imparted to the wheel, simply by the impulse due to its gradual change of momentum. It is clear that the water may be admitted in exactly the same way to any fraction of the circumference at pleasure, without altering the efficiency of the wheel. The diameter of the wheel may be made as large as convenient, and the water admitted to a small fraction of the circumference only. Then the number of revolutions is independent of the water velocity, and may be kept down to a manageable value.

Fig. 198. *General Description of an Impulse Turbine or Turbine with Free Deviation.*—Fig. 197 shows a general sectional elevation of a Girard turbine in

which the flow is axial. The water, admitted above a horizontal floor, passes down through the annular wheel containing the guide-blades *G, G,* and thence into the revolving wheel *WW.* The revolving wheel is fixed to a hollow shaft suspended from the pivot *p.* The solid internal shaft is merely a fixed column supporting the pivot. The advantage of this is that the pivot is accessible for lubrication and adjustment. *B* is the mortise bevel wheel by which the power of the turbine is given off. The sluices are worked by the hand wheel *h,* which raises them successively, in a way to be described presently. *d, d* are the sluice rods. Figs. 198, 199 show the sectional form of the guide-blade chamber and wheel and the curves of the wheel vanes and guide-blades, when

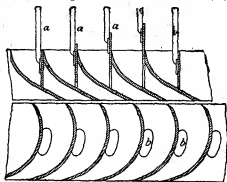

FIG. 198.

drawn on a plane development of the cylindrical section of the wheel; *a, a, a* are the sluices for cutting off the water; *b, b, b* are apertures by which the entrance or exit of air is facilitated as the buckets empty and fill. Figs. 200, 201 show the guide-blade gear. *a, a, a* are the sluice rods as before. At the top of each sluice rod is a small block *c,* having a projecting tongue, which slides in the groove of the circular cam plate *d, d.* This circular plate is supported on the frame *e,*

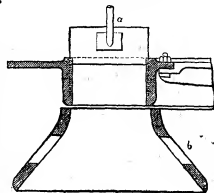

FIG. 199.

and revolves on it by means of the flanged rollers *f.* Inside, at the top, the cam plate is toothed, and gears into a spur pinion connected with the hand wheel *h.* At *gg* is an inclined groove or shunt. When the tongues of the blocks *c, c* arrive at *g,* they slide up to a second groove, or the reverse, according as the cam plate is revolved in one direction or in the other. As this operation takes place with each

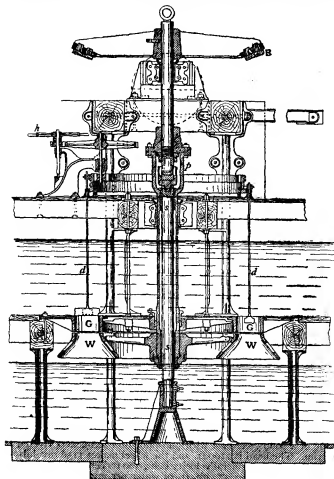

FIG. 197.

a modification of the mode of action of the water in the turbine became necessary. If the turbine wheel passages remain full of water during the whole rotation, the water contained in each passage must be put into motion each time it passes an open

sluice successively, any number of sluices can be opened or closed as desired. The turbine is of 48 horse power on 5-12 ft. fall, and the supply of water varies from 35 to 112 cub. ft. per second. The

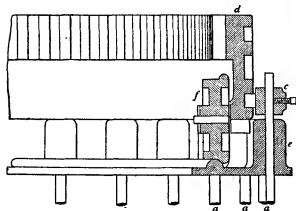

FIG. 200.

efficiency in normal working is given as 73%. The mean diameter of the wheel is 6 ft., and the speed 27.4 revolutions per minute.

As an example of a partial admission radial flow impulse turbine, a 100 h.p. turbine at Immenstadt may be taken. The fall varies from 538 to 570 ft. The external diameter of the wheel is  $4\frac{1}{2}$  ft., and

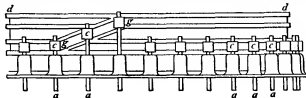

FIG. 201.

its internal diameter 3 ft. 10 in. Normal speed 400 revs. per minute. Water is discharged into the wheel by a single nozzle, shown in fig. 202 with its regulating apparatus and some of the vanes.

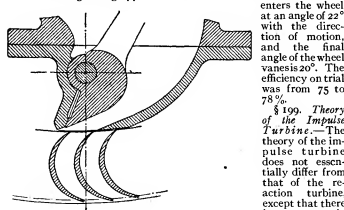

FIG. 202.

from the guide-blades. Hence the velocity with which the water enters the wheel is simply

$$v_1 = 0.96\sqrt{2g(H-b)},$$

where  $b$  is the height of the top of the wheel above the tail water. If the hydropneumatic system is used, then  $b=0$ . Let  $Q_m$  be the maximum supply of water,  $r_1$ ,  $r_2$  the internal and external radii of the wheel at the inlet surface; then

$$u_1 = Q_m / \pi(r_2^2 - r_1^2),$$

The value of  $u_1$  may be about  $0.45\sqrt{2g(H-b)}$ , whence  $r_1$ ,  $r_2$  can be determined.

The guide-blade angle is then given by the equation

$$\sin \gamma = u_1 / v_1 = 0.45 / 0.94 = .48;$$

$$\gamma = 29^\circ.$$

The value of  $u_1$  should, however, be corrected for the space occupied by the guide-blades.

The tangential velocity of the entering water is

$$u_t = v_1 \cos \gamma = 0.82\sqrt{2g(H-b)}.$$

The circumferential velocity of the wheel may be (at mean radius)

$$V_1 = 0.5\sqrt{2g(H-b)}.$$

Hence the vane angle at inlet surface is given by the equation

$$\cot \theta = (u_t - V_1) / u_1 = (0.82 - 0.5) / 0.45 = .71;$$

$$\theta = 55^\circ.$$

The relative velocity of the water striking the vane at the inlet edge is  $v_1 - u_1$ ,  $\text{cosec } \theta = 1.22u_1$ . This relative velocity remains unchanged during the passage of the water over the vane; consequently the relative velocity at the point of discharge is  $v_2 = 1.22u_1$ . Also in an axial flow turbine  $V_1 = V_2$ .

If the final velocity of the water is axial, then

$$\cos \phi = V_2 / v_2 = V_1 / v_1 = 0.5 / (1.22 \times 0.45) = \cos 24^\circ 23'.$$

This should be corrected for the vane thickness. Neglecting this,  $u_2 = v_2 \sin \phi = v_1 \sin \phi = u_1 \text{cosec } \theta \sin \phi = 0.5u_1$ . The discharging area of the wheel must therefore be greater than the inlet area in the ratio of at least 2 to 1. In some actual turbines the ratio is 7 to 3. This greater outlet area is obtained by splaying the wheel, as shown in the section (fig. 199).

§ 200. *Pelton Wheel*.—In the mining district of California about 1800 simple impulse wheels were used, termed hurdy-gurdy wheels. The wheels rotated in a vertical plane, being supported on a horizontal axis. Round the circumference were fixed flat vanes which were struck normally by a jet from a nozzle of size varying with the head and quantity of water. Such wheels have in fact long been used. They are not efficient, but they are very simple constructed. Then attempts were made to improve the efficiency, first by using hemispherical cup vanes, and then by using a double cup vane with a central dividing ridge, an arrangement invented by Pelton.

In this last form the water from the nozzle passes half to each side of the wheel, just escaping clear of the backs of the advancing buckets. Fig. 203 shows a Pelton vane. Some small modifications have been made by other makers, but they are not of any great importance. Fig. 204 shows a complete Pelton wheel with frame and casing, supply pipe and nozzle. Pelton wheels have been very largely used in America and to some extent in Europe. They are extremely simple and easy to construct or repair and on falls of 100 ft. or more are very efficient. The jet strikes tangentially to the mean radius of the buckets, and the face of the buckets is not quite radial but at right angles to the direction of the jet at the point of first impact. For greatest efficiency the peripheral velocity of the wheel at the mean radius of the buckets should be a little less than half the velocity of the jet. As the radius of the wheel can be taken arbitrarily, the number of revolutions per minute can be accommodated to that of the machinery to be driven. Pelton wheels have been made as small



FIG. 203.

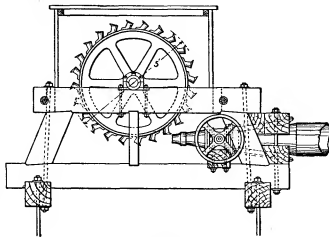

FIG. 204.

as 4 in. diameter, for driving sewing machines, and as large as 24 ft. The efficiency on high falls is about 80%. When large power is required two or three nozzles are used delivering on one wheel. The width of the buckets should be not less than seven times the diameter of the jet.

At the Comstock mines, Nevada, there is a 36-in. Pelton wheel made of a solid steel disk with phosphor bronze buckets riveted to the rim. The head is 2100 ft. and the wheel makes 1150 revolutions per minute, the peripheral velocity being 180 ft. per sec. With a  $\frac{1}{2}$ -in. nozzle the wheel uses 32 cub. ft. of water per minute and develops 100 h.p. At the Chollar shaft, Nevada, there are six Pelton wheels on a fall of 1680 ft. driving electrical generators. With  $\frac{3}{4}$ -in. nozzles each develops 125 h.p.

§ 201. *Theory of the Pelton Wheel*.—Suppose a jet with a velocity  $v$  strikes tangentially a curved vane AB (fig. 205) moving in the same direction with the velocity  $u$ . The water will flow over the vane with the relative velocity  $v-u$  and at B will have the tangential

relative velocity  $v-u$  making an angle  $\alpha$  with the direction of the vane's motion. Combining this with the velocity  $u$  of the vane, the absolute velocity of the water leaving the vane will be  $w=Bc$ . The component of  $w$  in the direction of motion of the vane is  $Ba=Bb-ab$

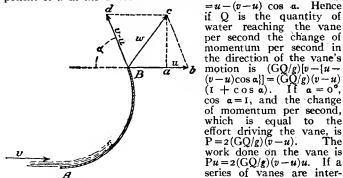

FIG. 205.

ing on the vanes per second is the total discharge of the nozzle, and the energy expended at the nozzle is  $GQv^2/2g$ . Hence the efficiency of the arrangement is, when  $\alpha=0^\circ$ , neglecting friction,

$$\eta = 2Pu/GQv^2 = 4(v-u)u/v^2$$

which is a maximum and equal to unity if  $u=v/2$ . In that case the whole energy of the jet is usefully expended in driving the series of vanes. In practice  $\alpha$  cannot be quite zero or the water leaving one vane would strike the back of the next advancing vane. Fig. 203 shows a Pelton vane. The water divides each way, and leaves the vane on each side in a direction nearly parallel to the direction of motion of the vane. The best velocity of the vane is very approximately half the velocity of the jet.

§ 202. *Regulation of the Pelton Wheel.*—At first Pelton wheels were adjusted to varying loads merely by throttling the supply. This method involves a total loss of part of the head at the sluice or throttle valve. In addition as the working head is reduced, the relation between wheel velocity and jet velocity is no longer that of greatest efficiency. Next a plan was adopted of deflecting the jet so that only part of the water reaches the wheel when the head was reduced, the rest going to waste. This involved the use of an equal quantity of water for large and small loads, but it had, what in some cases is an advantage, the effect of preventing any water hammer in the supply pipe due to the action of the regulator. In most cases now regulation is effected by varying the section of the jet. A conical needle in the nozzle can be advanced or withdrawn so as to occupy more or less of the aperture of the nozzle. Such a needle can be controlled by an ordinary governor.

§ 203. *General Considerations on the Choice of a Type of Turbine.*—The circumferential speed of any turbine is necessarily a fraction of the initial velocity of the water, and therefore is greater as the head is greater. In reaction turbines with complete admission the number of revolutions per minute becomes inconveniently great, for the diameter cannot be increased beyond certain limits without greatly reducing the efficiency. In impulse turbines with partial admission the diameter can be chosen arbitrarily and the number of revolutions kept down on high falls to any desired amount. Hence broadly reaction turbines are better and less costly on low falls, and impulse turbines on high falls. For variable water flow impulse turbines have some advantage, being more efficiently regulated. On the other hand, impulse turbines lose efficiency seriously if their speed varies from the normal speed due to the head. If the head is very variable, as it often is on low falls, and the turbine must run at the same speed whatever the head, the impulse turbine is not suitable. Reaction turbines can be constructed so as to overcome this difficulty to a great extent. Axial flow turbines with vertical shafts have the disadvantage that in addition to the weight of the turbine there is an unbalanced water pressure to be carried by the footstep or collar bearing. In radial flow turbines the hydraulic pressures are balanced. The application of turbines to drive dynamos directly has involved some new conditions. The electrical engineer generally desires a high speed of rotation, and a very constant speed at all times. The reaction turbine is generally more suitable than the impulse turbine. As the diameter of the turbine depends on the quantity of water and cannot be much varied without great inefficiency, a difficulty arises on low falls. This has been met by constructing four independent reaction turbines on the same shaft, each having of

course the diameter suitable for one-quarter of the whole discharge, and having a higher speed of rotation than a larger turbine. The turbines at Rheinfelden and Chevres are so constructed. To ensure constant speed of rotation when the head varies considerably without serious inefficiency, an axial flow turbine is generally used. It is constructed of three or four concentric rings of vanes, with independent regulating sluices, forming practically independent turbines of different radii. Any one of these or any combination can be used according to the state of the water. With a high fall the turbine of largest radius only is used, and the speed of rotation is less than with a turbine of smaller radius. On the other hand, as the fall decreases the inner turbines are used either singly or together, according to the power required. At the Zürich waterworks there are turbines of 90 h.p. on a fall varying from  $10\frac{1}{2}$  ft. to  $4\frac{1}{2}$  ft. The power and speed are kept constant. Each turbine has three concentric rings. The outermost ring gives 90 h.p. with 105 cub. ft. per second and the maximum fall. The outer and middle compartments give the same power with 140 cub. ft. per second and a fall of 7 ft. 10 in. All three compartments working together develop the power with about 250 cub. ft. per second. In some tests the efficiency was 74% with the outer ring working alone, 75.4% with the outer and middle ring working and a fall of 7 ft., and 80.7% with all the rings working.

§ 204. *Speed Governing.*—When turbines are used to drive dynamos direct, the question of speed regulation is of great importance. Steam engines using a light elastic fluid can be easily regulated by governors acting on throttle or expansion valves. It is different with water turbines using a fluid of great inertia.

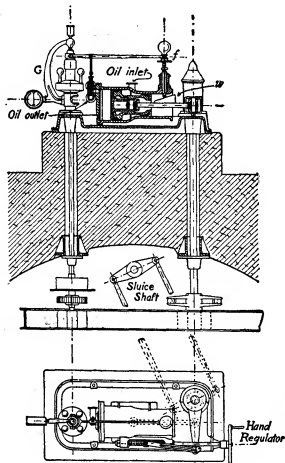

FIG. 206.

In one of the Niagara penstocks there are 400 tons of water flowing at 10 ft. per second, opposing enormous resistance to rapid change of speed of flow. The sluices of water turbines also are necessarily large and heavy. Hence relay governors must be

used, and the tendency of relay governors to hunt must be overcome. In the Niagara Falls Power House No. 1, each turbine has a very sensitive centrifugal governor acting on a ratchet relay. The governor puts into gear one or other of two ratchets driven by the turbine itself. According as one or the other ratchet is in gear the sluices are raised or lowered. By a subsidiary arrangement the ratchets are gradually put out of gear unless the governor puts them in gear again, and this prevents the over correction of the speed from the lag in the action of the governor. In the Niagara Power House No. 2, the relay is an hydraulic relay similar in principle, but rather more complicated in arrangement, to that shown in fig. 206, which is a governor used for the 1250 h.p. turbines at Lyons. The sensitive governor G opens a valve and puts into action a plunger driven by oil pressure from an oil reservoir. As the plunger moves forward it gradually closes the oil admission valve by lowering the fulcrum end *f* of the valve lever which rests on a wedge *w* attached to the plunger. If the speed is still too high, the governor re-opens the valve. In the case of the Niagara turbines the oil pressure is 1200 lb per sq. in. One millimetre of movement of the governor sleeve completely opens the relay valve, and the relay plunger exerts a force of 50 tons. The sluices can be completely opened or shut in twelve seconds. The ordinary variation of speed of the turbine with varying load does not exceed 1%. If all the load is thrown off, the momentary variation of speed is not more than 5%. To prevent hydraulic shock in the supply pipes, a relief valve is provided which opens if the pressure is in excess of that due to the head.

§ 205. *The Hydraulic Ram.*—The hydraulic ram is an arrangement by which a quantity of water falling a distance *h* forces a portion of the water to rise to a height *k*, greater than *h*. It consists of a supply reservoir (A, fig. 207), into which the water enters from some natural stream. A pipe *s* of considerable length conducts the water to a lower level, where it is discharged intermittently through a self-acting pulsating valve at *d*. The supply pipe *s* may be fitted with a flap valve for stopping the ram, and this is attached in some cases to a float, so that the ram starts and stops itself automatically, according as the supply cistern fills or empties. The lower float is just sufficient to keep open the flap after it has been raised by the action of the upper float. The length of chain is adjusted so that the upper float opens the flap when the level in the cistern is at the desired height. If the water-level falls below the lower float the flap closes. The pipe *s* should be as long and as straight as possible, and as it is subjected to considerable pressure from the sudden arrest of the motion of the water, it must be strong and strongly

this opens an aperture  $\frac{1}{4}$  in. in diameter, made in a brass screw plug *b*. The hole is reduced to  $\frac{1}{16}$  in. in diameter at the outer end of the plug and is closed by a small valve opening inwards. Through this, during the rebound after each stroke of the ram, a small quantity of air is sucked in which keeps the air vessel supplied with its elastic cushion of air.

During the recoil after a sudden closing of the valve *d*, the pressure below it is diminished and the valve opens, permitting outflow. In consequence of the flow through this valve, the water in the supply pipe acquires a gradually increasing velocity. The upward flow of the water, towards the valve *d*, increases the pressure tending to lift the valve, and at last, if the valve is not too heavy, lifts and closes it. The forward momentum of the column in the supply pipe being destroyed by the stoppage of the flow, the water exerts a pressure at the end of the pipe sufficient to open the delivery valve *a*, and to cause a portion of the water to flow into the air vessel. As the water in the supply pipe comes to rest and recoils, the valve *d* opens again and the operation is repeated. Part of the energy of the descending column is employed in compressing the air at the end of the supply pipe and expanding the pipe itself. This causes a recoil of the water which momentarily diminishes the pressure in the pipe below the pressure due to the static head. This assists in opening the valve *d*. The recoil of the water is sufficiently great to enable a pump to be attached to the ram body instead of the direct rising pipe. With this arrangement a ram working with muddy water may be employed to raise clear spring water. Instead of lifting the delivery valve as in the ordinary ram, the momentum of the column drives a sliding or elastic piston, and the recoil brings it back. This piston lifts and forces alternately the clear water through ordinary pump valves.

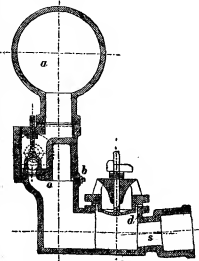

FIG. 208.

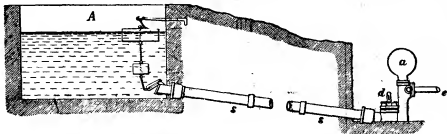

FIG. 207.

jointed. *a* is an air vessel, and *e* the delivery pipe leading to the reservoir at a higher level than A, into which water is to be pumped. Fig. 208 shows in section the construction of the ram itself. *d* is the pulsating discharge valve already mentioned, which opens inwards and downwards. The stroke of the valve is regulated by the cotter through the spindle, under which are washers by which the amount of fall can be regulated. At *o* is a delivery valve, opening outwards, which is often a ball-valve but sometimes a flap-valve. The water which is pumped passes through this valve into the air vessel *a*, from which it flows by the delivery pipe in a regular stream into the cistern to which the water is to be raised. In the vertical chamber behind the outer valve a small air vessel is formed, and into

#### PUMPS

§ 206. The different classes of pumps correspond almost exactly to the different classes of water motors, although the mechanical details of the construction are somewhat different. They are properly reversed water motors. Ordinary reciprocating pumps correspond to water-pressure engines. Chain and bucket pumps are in principle similar to water wheels in which the water acts by weight. Scoop wheels are similar to undershot water wheels, and centrifugal pumps to turbines.

*Reciprocating Pumps* are single or double acting, and differ from water-pressure engines in that the valves are moved by the water instead of by automatic machinery. They may be classed thus:—

1. *Lift Pumps.*—The water drawn through a foot valve on the ascent of the pump bucket is forced through the bucket valve when it descends, and lifted by the bucket when it reascends. Such pumps give an intermittent discharge.

2. *Plunger or Force Pumps*, in which the water drawn through the foot valve is displaced by the descent of a solid plunger, and forced through a delivery valve. They have the advantage that

the friction is less than that of lift pumps, and the packing round the plunger is easily accessible, whilst that round a lift pump bucket is not. The flow is intermittent.

3. *The Double-acting Force Pump* is in principle a double plunger pump. The discharge fluctuates from zero to a maximum and back to zero each stroke, but is not arrested for any appreciable time.

4. *Bucket and Plunger Pumps* consist of a lift pump bucket combined with a plunger of half its area. The flow varies as in a double-acting pump.

5. *Diaphragm Pumps* have been used, in which the solid plunger is replaced by an elastic diaphragm, alternately depressed into and raised out of a cylinder.

As single-acting pumps give an intermittent discharge three are generally used on cranks at  $120^\circ$ . But with all pumps the variation of velocity of discharge would cause great waste of work in the delivery pipes when they are long, and even danger from the hydraulic ramming action of the long column of water. An air vessel is interposed between the pump and the delivery pipes, of a volume from 5 to 100 times the space described by the plunger per stroke. The air in this must be replenished from time to time, or continuously, by a special air-pump. At low speeds not exceeding 30 ft. per minute the delivery of a pump is about 90 to 95% of the volume described by the plunger or bucket, from 5 to 10% of the discharge being lost by leakage. At high speeds the quantity pumped occasionally exceeds the volume described by the plunger, the momentum of the water keeping the valves open after the turn of the stroke.

The velocity of large mining pumps is about 140 ft. per minute, the indoor or suction stroke being sometimes made at 250 ft. per minute. Rotative pumping engines of large size have a plunger speed of 90 ft. per minute. Small rotative pumps are run faster, but at some loss of efficiency. Fire-engine pumps have a speed of 180 to 220 ft. per minute.

The efficiency of reciprocating pumps varies very greatly. Small reciprocating pumps, with metal valves on lifts of 15 ft., were found by Morin to have an efficiency of 16 to 40%, or on the average 25%. When used to pump water at considerable pressure, through hose pipes, the efficiency rose to from 28 to 57%, or on the average, with 50 to 100 ft. of lift, about 50%. A large pump with barrels 18 in. diameter, at speeds under 60 ft. per minute, gave the following results:—

Lift in feet	14½	34	47
Efficiency	46	60	70

The very large steam-pumps employed for waterworks, with 150 ft. or more of lift, appear to reach an efficiency of 90%, not including the friction of the discharge pipes. Reckoned on the indicated work of the steam-engine the efficiency may be 80%.

Many small pumps are now driven electrically and are usually three-throw single-acting pumps driven from the electric motor by gearing. It is not convenient to vary the speed of the motor to accommodate it to the varying rate of pumping usually required. Messrs Hayward Tyler have introduced a mechanism for varying the stroke of the pumps (Sinclair's patent) from full stroke to nil, without stopping the pumps.

§ 207. *Centrifugal Pump*.—For large volumes of water on lifts not exceeding about 60 ft. the most convenient pump is the centrifugal pump. Recent improvements have made it available also for very high lifts. It consists of a wheel or fan with curved vanes enclosed in an annular chamber. Water flows in at the centre and is discharged at the periphery. The fan may rotate in a vertical or horizontal plane and the water may enter on one or both sides of the fan. In the latter case there is no axial unbalanced pressure. The fan and its casing must be filled with water before it can start, so that if not drowned there must be a foot valve on the suction pipe. When no special attention needs to be paid to efficiency the water may have a velocity of 6 to 7 ft. in the suction and delivery pipes. The fan often has 6 to 12 vanes. For a double-inlet fan of diameter  $D$ , the diameter of the inlets is  $D/2$ . If  $Q$  is the discharge in cub. ft. per second  $D = \text{about } 0.6 \sqrt{Q}$  in average cases. The

peripheral speed is a little greater than the velocity due to the lift. Ordinary centrifugal pumps will have an efficiency of 40 to 60%.

The first pump of this kind which attracted notice was one exhibited by J. G. Appold in 1851, and the special features of his pump have been retained in the best pumps since constructed. Appold's pump raised continuously a volume of water equal to 1400 times its own capacity per minute. It had no valves, and it permitted the passage of solid bodies, such as walnuts and oranges, without obstruction to its working. Its efficiency was also found to be good.

Fig. 209 shows the ordinary form of a centrifugal pump. The pump disk and vanes B are cast in one, usually of bronze,

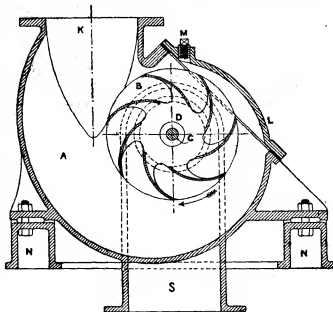

FIG. 209.

and the disk is keyed on the driving shaft C. The casing A has a spirally enlarging discharge passage into the discharge pipe K. A cover L gives access to the pump. S is the suction pipe which opens into the pump disk on both sides at D.

Fig. 210 shows a centrifugal pump differing from ordinary centrifugal pumps in one feature only. The water rises through a suction pipe S, which divides so as to enter the pump wheel W at the centre on each side. The pump disk or wheel is very similar to a turbine wheel. It is keyed on a shaft driven by a belt on a fast and loose pulley arrangement at P. The water rotating in the pump disk presses outwards, and if the speed is sufficient a continuous flow is maintained through the pump and into the discharge pipe D. The special feature in this pump is that the water, discharged by the pump disk with a whirling velocity of not inconsiderable magnitude, is allowed to continue rotation in a chamber somewhat larger than the pump. The use of this whirlpool chamber was first suggested by Professor James Thomson. It utilizes the energy due to the whirling velocity of the water which in most pumps is wasted in eddies in the discharge pipe. In the pump shown guide-blades are also added which have the direction of the stream lines in a free vortex. They do not therefore interfere with the action of the water when pumping the normal quantity, but only prevent irregular motion. At A is a plug by which the pump case is filled before starting. If the pump is above the water to be pumped, a foot valve is required to permit the pump to be filled. Sometimes instead of the foot valve a delivery valve is used, an air-pump or steam jet pump being employed to exhaust the air from the pump case.

§ 208. *Design and Proportions of a Centrifugal Pump*.—The design of the pump disk is very simple. Let  $r_1$ ,  $r_2$  be the radii of the inlet and outlet surfaces of the pump disk,  $d_1$ ,  $d_2$  the clear axial width at those radii. The velocity of flow through the pump may be taken

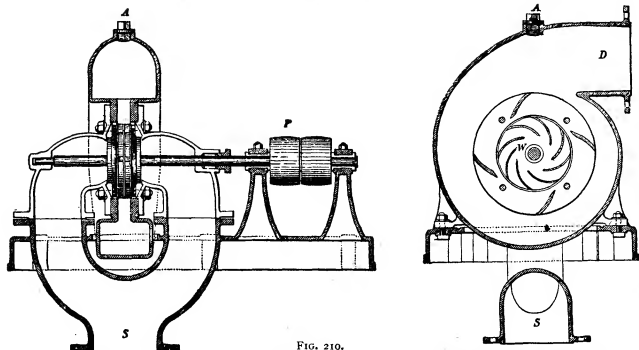

FIG. 210.

the same as for a turbine. If  $Q$  is the quantity pumped, and  $H$  the lift,

$$u_i = 0.25\sqrt{2gH} \quad (1)$$

$$2\pi r_i d_i = Q/u_i$$

Also in practice

$$d_i = 1.2r_i \dots \dots \quad (2)$$

$$r_i = 1.2571\sqrt{Q/(H \cdot u_i)}$$

Hence,

$$r_o = 2r_i$$

$$d_o = d_i \text{ or } \frac{1}{2}d_i$$

Usually

and according as the disk is parallel-sided or coned. The water enters the wheel radially with the velocity  $u_i$ , and

$$u_o = Q/2\pi r_o d_o \quad (3)$$

Fig. 211 shows the notation adopted for the velocities. Suppose the water enters the wheel with the velocity  $v_i$ , while the velocity of the wheel is  $V_i$ . Completing the parallelogram,  $v_{ri}$  is the relative velocity of the water and wheel, and is the proper direction of the wheel vanes.

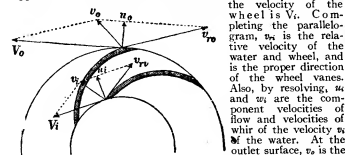

FIG. 211.

the notation is similar to that for the inlet surface.

Usually the water flows equally in all directions in the eye of the wheel, in that case  $v_i$  is radial. Then, in normal conditions of working, at the inlet surface,

$$v_i = u_i$$

$$v_{ri} = 0$$

$$\tan \theta = u_i/V_i \quad (4)$$

$$v_i = u_i \operatorname{cosec} \theta = \sqrt{(u_i^2 + V_i^2)}$$

If the pump is raising less or more than its proper quantity,  $\theta$  will not satisfy the last condition, and there is then some loss of head in shock.

At the outer circumference of the wheel or outlet surface,

$$v_o = u_o \operatorname{cosec} \phi$$

$$v_{ro} = V_o - u_o \cot \phi$$

$$v_o = \sqrt{(u_o^2 + (V_o - u_o \cot \phi)^2)} \quad (5)$$

**Variation of Pressure in the Pump Disk.**—Precisely as in the case of turbines, it can be shown that the variation of pressure between the inlet and outlet surfaces of the pump is

$$h_o - h_i = (V_o^2 - V_i^2)/2g - (v_o^2 - v_i^2)/2g$$

Inserting the values of  $v_{ri}$ ,  $v_i$  in (4) and (5), we get for normal conditions of working

$$h_o - h_i = (V_o^2 - V_i^2)/2g - u_o^2 \operatorname{cosec}^2 \phi / 2g + (u_i^2 + V_i^2)/2g$$

$$= V_o^2/2g - u_o^2 \operatorname{cosec}^2 \phi / 2g + u_i^2/2g \quad (6)$$

**Hydraulic Efficiency of the Pump.**—Neglecting disk friction, journal friction, and leakage, the efficiency of the pump can be found in the same way as that of turbines (§ 186). Let  $M$  be the moment of the couple rotating the pump, and  $\omega$  its angular velocity;  $w_o$ ,  $r_o$  the tangential velocity of the water and radius at the outlet surface;  $w_i$ ,  $r_i$  the same quantities at the inlet surface.  $Q$  being the discharge per second, the change of angular momentum per second is

$$(G/Qg)(w_o r_o - w_i r_i)$$

$$= (G/Qg)(\omega r_o^2 - \omega r_i^2)$$

Hence

In normal working,  $w_i = 0$ . Also, multiplying by the angular velocity, the work done per second is

$$Ma = (G/Qg)\omega r_o^2$$

But the useful work done in pumping is  $GQH$ . Therefore the efficiency is

$$\eta = GQH/Ma = gH/w_o r_o a = gH/w_o V_o \quad (7)$$

§ 209. **Case 1. Centrifugal Pump with no Whirlpool Chamber.**—When no special provision is made to utilize the energy of motion of the water leaving the wheel, and the pump discharges directly into a chamber in which the water is flowing to the discharge pipe, nearly the whole of the energy of the water leaving the disk is wasted. The water leaves the disk with the more or less considerable velocity  $v_o$ , and impinges on a mass flowing to the discharge pipe at the much slower velocity  $w_o$ . The radial component of  $v_o$  is almost necessarily wasted. From the tangential component there is a gain of pressure

$$(w_o^2 - v_o^2)/2g - (w_o - v_o)^2/2g$$

$$= v_o(w_o - v_o)/g$$

which will be small, if  $v_o$  is small compared with  $w_o$ . Its greatest value, if  $v_o = \frac{1}{2}w_o$ , is  $\frac{1}{8}w_o^2/2g$ , which will always be a small part of the whole head. Suppose this neglected. The whole variation of pressure in the pump disk then balances the lift and the head  $u_o^2/2g$  necessary to give the initial velocity of flow in the eye of the wheel.

$$u_o^2/2g + H = V_o^2/2g - u_o^2 \operatorname{cosec}^2 \phi / 2g + u_i^2/2g$$

$$H = V_o^2/2g - u_o^2 \operatorname{cosec}^2 \phi / 2g \quad (8)$$

or

$$V_o = \sqrt{(2gH + u_o^2 \operatorname{cosec}^2 \phi)}$$

and the efficiency of the pump is, from (7),

$$\eta = gH/\sqrt{2gH + u_o^2 \operatorname{cosec}^2 \phi} \cdot (V_o - u_o \cot \phi)$$

$$= (V_o^2 - u_o^2 \operatorname{cosec}^2 \phi) / (2V_o(V_o - u_o \cot \phi)) \quad (9)$$

For  $\phi = 90^\circ$ ,

$$\eta = (V_o^2 - u_o^2) / 2V_o^2$$

which is necessarily less than  $\frac{1}{2}$ . That is, half the work expended in driving the pump is wasted. By recurring the vanes, a plan introduced by Appold, the efficiency is increased, because the velocity  $v_o$  of discharge from the pump is diminished. If  $\phi$  is very small,

$$\operatorname{cosec} \phi = \cot \phi$$

and then

$$\eta = (V_o + u_o \operatorname{cosec} \phi) / 2V_o$$

which may approach the value  $\frac{1}{2}$ , as  $\phi$  tends towards 0. Equation (8) shows that  $u_o \operatorname{cosec} \phi$  cannot be greater than  $V_o$ . Putting  $u_o = 0.25\sqrt{2gH}$  we get the following numerical values of the efficiency and the circumferential velocity of the pump:—



$\phi$	$\eta$	$V_0 \sqrt{2gH}$
90°	0.47	1.03
45°	0.56	1.06
30°	0.65	1.12
20°	0.73	1.24
10°	0.84	1.75

$\phi$  cannot practically be made less than 20°; and, allowing for the frictional losses neglected, the efficiency of a pump in which  $\phi = 20^\circ$  is found to be about .60.

§ 210. Case 2. *Pump with a Whirlpool Chamber*, as in fig. 210.—Professor James Thomson first suggested that the energy of the water after leaving the pump disk might be utilized, if a space were left in which a free vortex could be formed. In such a free vortex the velocity varies inversely as the radius. The gain of pressure in the vortex chamber is, putting  $r_0$ ,  $r_1$  for the radii of the outlet surface of wheel and to outside of free vortex,

$$\frac{v_0^2}{2g} \left( 1 - \frac{r_0^2}{r_1^2} \right) = \frac{v_1^2}{2g} (1 - k^2),$$

if

$$k = r_0/r_1.$$

The lift is then, adding this to the lift in the last case,

$$H = [V_0^2 - u_0^2 \cos^2 \phi + v_1^2 (1 - k^2)] / 2g.$$

But

$$u_0^2 = V_0^2 - 2V_0 u_0 \cot \phi + u_0^2 \cos^2 \phi;$$

$$\therefore H = [(2 - k^2)V_0^2 - 2k^2 V_0 u_0 \cot \phi - k^2 u_0^2 \cos^2 \phi] / 2g. \quad (10)$$

Putting this in the expression for the efficiency, we find a considerable increase of efficiency. Thus with

$$\phi = 90^\circ \text{ and } k = \frac{1}{2}, \quad \eta = \frac{1}{2} \text{ nearly,}$$

$$\phi \text{ a small angle and } k = \frac{1}{2}, \quad \eta = \frac{1}{2} \text{ nearly.}$$

With this arrangement of pump, therefore, the angle at the outer ends of the vanes is of comparatively little importance. A moderate angle of 30° or 40° may very well be adopted. The following numerical values of the velocity of the circumference of the pump have been obtained by taking  $k = \frac{1}{2}$ , and  $u_0 = 0.25\sqrt{2gH}$ .

$\phi$	$V_0$
90°	.762 $\sqrt{2gH}$
45°	.842 "
30°	.911 "
20°	1.023 "

The quantity of water to be pumped by a centrifugal pump necessarily varies, and an adjustment for different quantities of water cannot easily be introduced. Hence it is that the average efficiency of pumps of this kind is in practice less than the efficiencies given above. The advantage of a vortex chamber is also generally neglected. The velocity in the supply and discharge pipes is also often made greater than is consistent with a high degree of efficiency. Velocities of 6 or 7 ft. per second in the discharge and suction pipes, when the lift is small, cause a very sensible waste of energy; 3 to 6 ft. would be much better. Centrifugal pumps of very large size have been constructed. Easton and Anderson made pumps for the North Sea canal in Holland to deliver each 670 tons of water per minute on a lift of 5 ft. The pump disks are 8 ft. diameter. J. and H. Gwynne constructed some pumps for draining the Ferrarese Marshes, which together deliver 2000 tons per minute. A pump made under Professor J. Thomson's direction for drainage works in Barbados had a pump disk 16 ft. in diameter and a whirlpool chamber 32 ft. in diameter. The efficiency of centrifugal pumps when delivering less or more than the normal quantity of water is discussed in a paper in the *Proc. Inst. Civ. Eng.* vol. 53.

§ 211. *High Lift Centrifugal Pumps*.—It has long been known that centrifugal pumps could be worked in series, each pump overcoming a part of the lift. This method has been perfected, and centrifugal pumps for very high lifts with great efficiency have been used by Sulzer and others. C. W. Darley (*Proc. Inst. Civ. Eng.*, supplement to vol. 154, p. 156) has described some pumps of this new type driven by Parsons steam turbines for the water supply of Sydney, N.S.W. Each pump was designed to deliver 1½ million gallons per twenty-four hours against a head of 240 ft. at 3300 revs. per minute. Three pumps in series give therefore a lift of 720 ft. The pump consists of a central double-sided impeller 12 in. in diameter. The water entering at the bottom divides and enters the runner at each side through a bell-mouthed passage. The shaft is provided with ring and groove glands which on the suction side keep the air out and on the pressure side prevent leakage. Some water from the pressure side leaks through the glands, but beyond the first grooves it passes into a pocket and is returned to the suction side of the pump. For the glands on the suction side water is supplied from a low-pressure service. No packing is used in the glands. During the trials no water was seen at the glands. The following are the results of tests made at Newcastle:—

	I.	II.	III.	IV.
Duration of test . . . hours	2	1.54	1.2	1.55
Steam pressure lb per sq. in.	57	57	84	55
Weight of steam per water h.p. hour . . . . . lb	27.93	30.67	28.83	27.89
Speed in revs. per min. . .	3300	3330	3710	3340
Height of suction . . . . . ft.	11	11	11	11
Total lift . . . . . ft.	762	744	917	756
Million gallons per day pumped—				
By Venturi meter . . . . .	1.573	1.499	1.689	1.503
By orifice . . . . .	1.623	1.515	1.723	1.555
Water h.p. . . . .	252	235	326	239

In trial IV. the steam was superheated 95° F. From other trials under the same conditions as trial I. the Parsons turbine uses 1.5 lb of steam per brake h.p. hour, so that the combined efficiency of turbine and pumps is about 56%, a remarkably good result.

§ 212. *Air-Lift Pumps*.—An interesting and simple method of pumping by compressed air, invented by Dr J. Pohlé of Arizona, is likely to be very useful in certain cases. Suppose a rising main placed in a deep bore hole in which there is a considerable depth of water. Air compressed to a sufficient pressure is conveyed by an air pipe and introduced at the lower end of the rising main. The air rising in the main diminishes the average density of the contents of the main, and their aggregate weight no longer balances the pressure at the lower end of the main due to its submersion. An upward flow is set up, and if the air supply is sufficient the water in the rising main is lifted to any required height.

The higher the lift above the level in the bore hole the deeper must be the point at which air is injected. Fig. 212 shows an air-lift pump constructed for W. H. Maxwell at the Tunbridge Wells water-works. There is a two-stage steam air compressor, compressing air from 90 to 100 lb per sq. in. The bore hole is 350 ft. deep, lined with steel pipes 15 in. diameter for 200 ft. and with perforated pipes 13½ in. diameter for the lower 150 ft. The rest level of the water is 96 ft. from the ground-level, and the level when pumping 32,000 gallons per hour is 120 ft. from the ground-level. The rising main is 7 in. diameter, and is carried nearly to the bottom of the bore hole and to 20 ft. above the ground-level. The air pipe is 2½ in. diameter. In a trial run 31,402 gallons per hour were raised 133 ft. above the level in the well. Trials of the efficiency of the system made at San Francisco with varying conditions will be found in a paper by E. A. Rix (*Journ. Amer. Assoc. Eng. Soc.* vol. 25,

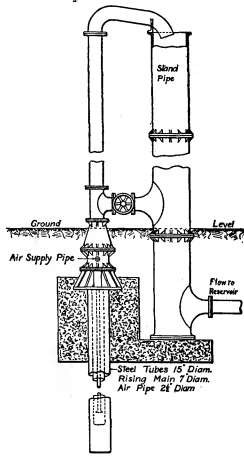

FIG. 212.

1900). Maxwell found the best results when the ratio of immersion to lift was 3 to 1 at the start and 2-2 to 1 at the end of the trial. In these conditions the efficiency was 37% calculated on the indicated h.p. of the steam-engine, and 46% calculated on the indicated work of the compressor. 2-7 volumes of free air were used to 1 of water lifted. The system is suitable for temporary purposes, especially as the quantity of water raised is much greater than could be pumped by any other system in a bore hole of a given size. It is useful for clearing a boring of sand and may be advantageously used permanently when a boring is in sand or gravel which cannot be kept out of the bore hole. The initial cost is small.

§ 213. Centrifugal Fans.—Centrifugal fans are constructed similarly to centrifugal pumps, and are used for compressing air to pressures not exceeding 10 to 15 in. of water-column. With this small variation of pressure the variation of volume and density of the air may be neglected without sensible error. The conditions of pressure and discharge for fans are generally less accurately known than in the case of pumps, and the design of fans is generally somewhat crude. They seldom have whirlpool chambers, though a large expanding outlet is provided in the case of the important Guibal fans used in mine ventilation.

It is usual to reckon the difference of pressure at the inlet and outlet of a fan in inches of water-column. One inch of water-column = 64-4 ft. of air at average atmospheric pressure = 5-2 lb per sq. ft.

Roughly the pressure-head produced in a fan without means of utilizing the kinetic energy of discharge would be  $\frac{v^2}{2g}$  ft. of air, or 0-0002  $v^2$  in. of water, where  $v$  is the velocity of the tips of the fan blades in feet per second. If  $d$  is the diameter of the fan and  $t$  the width at the external circumference, then  $\pi dt$  is the discharge area of the fan disk. If  $Q$  is the discharge in cub. ft. per sec.,  $u = Q/\pi dt$  is the radial velocity of discharge which is numerically equal to the discharge per square foot of outlet in cubic feet per second. As both the losses in the fan and the work done are roughly proportional to  $u^2$  in fans of the same type, and are also proportional to the gauge pressure  $p$ , then if the losses are to be a constant percentage of the work done  $u$  may be taken proportional to  $\sqrt{p}$ . In ordinary cases  $u$  is about  $2\sqrt{p}$ . The width  $t$  of the fan is generally from 0-35 to 0-45. Hence if  $Q$  is given, the diameter of the fan should be—

$$\begin{aligned} \text{For } t = 0-35d, \quad d &= 0-20\sqrt{Q/\sqrt{p}} \\ \text{For } t = 0-45d, \quad d &= 0-18\sqrt{Q/\sqrt{p}} \end{aligned}$$

If  $p$  is the pressure difference in the fan in inches of water, and  $N$  the revolutions of fan,

$$\begin{aligned} n &= \pi d N / 60 \quad \text{ft. per sec.} \\ N &= 1230\sqrt{p/d} \quad \text{revs. per min.} \end{aligned}$$

As the pressure difference is small, the work done in compressing the air is almost exactly  $5-2pQ$  foot-pounds per second. Usually, however, the kinetic energy of the air in the discharge pipe is not inconsiderable compared with the work done in compression. If  $w$  is the velocity of the air where the discharge pressure is measured, the air carries away  $w^2/2g$  foot-pounds per lb of air as kinetic energy. In  $Q$  cubic feet or  $0-0807Q$  lb the kinetic energy is  $0-00125 Qw^2$  foot-pounds per second.

The efficiency of fans is reckoned in two ways. If B.H.P. is the effective horse-power applied at the fan shaft, then the efficiency reckoned on the work of compression is

$$\eta = 5-2pQ/550B.H.P.$$

On the other hand, if the kinetic energy in the delivery pipe is taken as part of the useful work the efficiency is

$$\eta = (5-2pQ + 0-00125Qw^2)/550B.H.P.$$

Although the theory above is a rough one it agrees sufficiently with experiment, with some merely numerical modifications.

An extremely interesting experimental investigation of the action of centrifugal fans has been made by H. Heenan and W. Gilbert (*Proc. Inst. Civ. Eng.* vol. 123, p. 272). The fans delivered through an air trunk in which different resistances could be obtained by introducing diaphragms with circular apertures of different sizes. Suppose a fan run at constant speed with different resistances and the compression pressure, discharge and brake horse-power measured. The results put in such a diagram as is shown in fig. 213. The less the resistance to discharge, that is the larger the opening in the air trunk, the greater the quantity of air discharged at the given speed of the fan. On the other hand the compression pressure diminishes. The curve marked total gauge is the compression pressure + the velocity head in the discharge pipe, both in inches of water. This curve falls, but not nearly so much as the compression curve, when the resistance in the air trunk is diminished. The brake horse-power increases as the resistance is diminished because the volume of discharge increases very much. The curve marked efficiency is the efficiency

calculated on the work of compression only. It is zero for no discharge, and zero also when there is no resistance and all the energy given to the air is carried away as kinetic energy. There is a discharge for which this efficiency is a maximum; it is about half the discharge which there is when there is no resistance and the delivery pipe is full open. The conditions of speed and discharge corresponding to the greatest efficiency of compression are those ordinarily taken as the best normal conditions of working. The curve marked

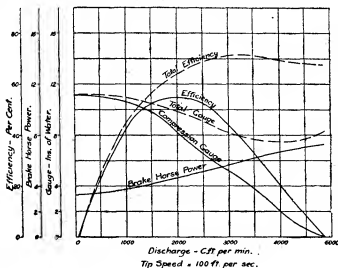

FIG. 213.

total efficiency gives the efficiency calculated on the work of compression and kinetic energy of discharge. Messrs Gilbert and Heenan found the efficiencies of ordinary fans calculated on the compression to be 40 to 60% when working at about normal conditions.

Taking some of Messrs Heenan and Gilbert's results for ordinary fans in normal conditions, they have been found to agree fairly with the following approximate rules. Let  $p_c$  be the compression pressure and  $q$  the volume discharged per second per square foot of outlet area of fan. Then the total gauge pressure due to pressure of compression and velocity of discharge is approximately:  $p = p_c + 0-0004q^2$  in. of water, so that if  $p_c$  is given,  $q$  can be found approximately. The pressure  $p$  depends on the circumferential speed  $v$  of the fan disk—

$$\begin{aligned} p &= 0-00025v^2 \text{ in. of water} \\ v &= 63\sqrt{p} \text{ ft. per sec.} \end{aligned}$$

The discharge per square foot of outlet of fan is—  
 $q = 15$  to  $18\sqrt{p}$  cub. ft. per sec.

The total discharge is

$$Q = \pi d^2 l q = 47 \text{ to } 56 d l \sqrt{p}$$

For  $l = 35d, \quad d = 0-22 \text{ to } 0-25\sqrt{Q/\sqrt{p}}$  ft.  
 $l = 45d, \quad d = 0-20 \text{ to } 0-22\sqrt{Q/\sqrt{p}}$  ft.  
 $N = 1203\sqrt{p/d}$ .

These approximate equations, which are derived purely from experiment, do not differ greatly from those obtained by the rough theory given above. The theory helps to explain the reason for the form of the empirical results. (W. C. U.)

**HYDRAZINE** (DIAMIDOGEN),  $N_2H_4$  or  $H_2N \cdot NH_2$ , a compound of hydrogen and nitrogen, first prepared by Th. Curtius in 1887 from diazo-acetic ester,  $N_2CH \cdot CO_2C_2H_5$ . This ester, which is obtained by the action of potassium nitrate on the hydrochloride of amidoacetic ester, yields on hydrolysis with hot concentrated potassium hydroxide an acid, which Curtius regarded as  $C_2H_2N_2(CO_2H)_2$ , but which A. Hantzsch and O. Silberrad (*Ber.*, 1900, 33, p. 58) showed to be  $C_2H_2N_2(CO_2H)_2$ , bisdiazo-acetic acid. On digestion of its warm aqueous solution with warm dilute sulphuric acid, hydrazine sulphate and oxalic acid are obtained. C. A. Lobry de Bruyn (*Ber.*, 1865, 28, p. 3085) prepared free hydrazine by dissolving its hydrochloride in methyl alcohol and adding sodium methylate; sodium chloride was precipitated and the residual liquid afterwards fractionated under reduced pressure. It can also be prepared by reducing potassium dinitrosulphonate in ice cold water by means of sodium amalgam:—

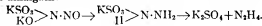

P. J. Schestakov (*J. Russ. Phys. Chem. Soc.*, 1905, 37, p. 2) obtained hydrazine by oxidizing urea with sodium hypochlorite in the presence of benzaldehyde, which, by combining with the hydrazine, protected it from oxidation. F. Raschig (German Patent 198307, 1908) obtained good yields by oxidizing ammonia with sodium hypochlorite in solutions made viscous with glue. Free hydrazine is a colourless liquid which boils at  $113.5^{\circ}\text{C}$ ., and solidifies about  $0^{\circ}\text{C}$ . to colourless crystals; it is heavier than water, in which it dissolves with rise of temperature. It is rapidly oxidized on exposure, is a strong reducing agent, and reacts vigorously with the halogens. Under certain conditions it may be oxidized to azoimide (A. W. Browne and F. F. Shetterly, *J. Amer. C.S.*, 1908, p. 58). By fractional distillation of its aqueous solution hydrazine hydrate  $\text{N}_2\text{H}_4\cdot\text{H}_2\text{O}$  (or perhaps  $\text{H}_2\text{N}\cdot\text{NH}_2\cdot\text{OH}$ ), a 'strong base, is obtained, which precipitates the metals from solutions of copper and silver salts at ordinary temperatures. It dissociates completely in a vacuum at  $143^{\circ}$ , and when heated under atmospheric pressure to  $183^{\circ}$  it decomposes into ammonia and nitrogen (A. Scott, *J. Chem. Soc.*, 1904, 85, p. 913). The sulphate  $\text{N}_2\text{H}_4\cdot\text{H}_2\text{SO}_4$ , crystallizes in tables which are slightly soluble in cold water and readily soluble in hot water; it is decomposed by heating above  $250^{\circ}\text{C}$ . with explosive evolution of gas and liberation of sulphur. By the addition of barium chloride to the sulphate, a solution of the hydrochloride is obtained, from which the crystallized salt may be obtained on evaporation.

Many organic derivatives of hydrazine are known, the most important being phenylhydrazine, which was discovered by Emil Fischer in 1877. It can be best prepared by V. Meyer and Lecco's method (*Ber.*, 1883, 16, p. 2976), which consists in reducing phenyldiazonium chloride in concentrated hydrochloric acid solution with stannous chloride also dissolved in concentrated hydrochloric acid. Phenylhydrazine is liberated from the hydrochloride so obtained by adding sodium hydroxide, the solution being then extracted with ether, the ether distilled off, and the residue purified by distillation under reduced pressure. Another method is due to E. Bamberger. The diazomium chloride, by the addition of an alkaline sulphite, is converted into a diazosulphonate, which is then reduced by zinc dust and acetic acid to phenylhydrazine potassium sulphite. This salt is then hydrolysed by heating it with hydrochloric acid—

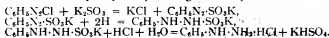

Phenylhydrazine is a colourless oily liquid which turns brown on exposure. It boils at  $241^{\circ}\text{C}$ ., and melts at  $17.5^{\circ}\text{C}$ .. It is slightly soluble in water, and is strongly basic, forming well-defined salts with acids. For the detection of substances containing the carbonyl group (such for example as aldehydes and ketones) phenylhydrazine is a very important reagent, since it combines with them with elimination of water and the formation of well-defined hydrazones (see ALDEHYDES, KETONES and SUGARS). It is a strong reducing agent; it precipitates cuprous oxide when heated with Fehling's solution, nitrogen and benzene being formed at the same time— $\text{C}_6\text{H}_5\text{NH}\cdot\text{NH}_2 + 2\text{CuO} = \text{Cu}_2\text{O} + \text{N}_2 + \text{H}_2\text{O} + \text{C}_6\text{H}_6$ . By energetic reduction of phenylhydrazine (e.g. by use of zinc dust and hydrochloric acid) ammonia and aniline are produced— $\text{C}_6\text{H}_5\text{NH}\cdot\text{NH}_2 + 2\text{H} = \text{C}_6\text{H}_5\text{NH}_2 + \text{NH}_3$ . It is also a most important synthetic reagent. It combines with aceto-acetic ester to form phenylmethylglyoxalone, from which antipyrine (q.v.) may be obtained. Indoles (q.v.) are formed by heating certain hydrazones with anhydrous zinc chloride; while semicarbazides, pyrrols (q.v.) and many other types of organic compounds may be synthesized by the use of suitable phenylhydrazine derivatives.

**HYDRAZONE**, in chemistry, a compound formed by the condensation of a hydrazine with a carbonyl group (see ALDEHYDES; KETONES).

**HYDROCARBON**, in chemistry, a compound of carbon and hydrogen. Many occur in nature in the free state; for example, natural gas, petroleum and paraffin are entirely composed of such bodies; other natural sources are india-rubber, turpentine and certain essential oils. They are also revealed by the spectroscopy in stars, comets and the sun. Of artificial productions the most fruitful and important is provided by the destructive or dry distillation of many organic substances; familiar examples are the distillation of coal, which yields ordinary lighting gas, composed of gaseous hydrocarbons, and also coal tar, which, on subsequent fractional distillations, yields many liquid and

solid hydrocarbons, all of high industrial value. For details reference should be made to the articles wherein the above subjects are treated. From the chemical point of view the hydrocarbons are of fundamental importance, and, on account of their great number, and still greater number of derivatives, they are studied as a separate branch of the science, namely, organic chemistry.

See CHEMISTRY for an account of their classification, &c.

**HYDROCELE** (Gr. *ὕδωρ*, water, and *κύημα*, tumour), the medical term for any collection of fluid other than pus or blood in the neighbourhood of the testis or cord. The fluid is usually serous. Hydrocele may be congenital or arise in the middle-aged without apparent cause, but it is usually associated with chronic orchitis or with tertiary syphilitic enlargements. The hydrocele appears as a rounded, fluctuating translucent swelling in the scrotum, and when greatly distended causes a dragging pain. Palliative treatment consists in tapping aseptically and removing the fluid, the patient afterwards wearing a suspender. The condition frequently recurs and necessitates radical treatment. Various substances may be injected; or the hydrocele is incised, the tunica partly removed and the cavity drained.

**HYDROCEPHALUS** (Gr. *ὕδωρ*, water, and *κεφαλή*, head), a term applied to disease of the brain which is attended with excessive effusion of fluid into its cavities. It exists in two forms—*acute* and *chronic hydrocephalus*. Acute hydrocephalus is another name for tuberculous meningitis (see MENINGITIS).

*Chronic hydrocephalus*, or "water on the brain," consists in an effusion of fluid into the lateral ventricles of the brain. It is not preceded by tuberculous deposit or acute inflammation, but depends upon congenital malformation or upon chronic inflammatory changes affecting the membranes. When the disease is congenital, its presence in the foetus is apt to be a source of difficulty in parturition. It is however more commonly developed in the first six months of life; but it occasionally arises in older children, or even in adults. The chief symptom is the gradual increase in size of the upper part of the head out of all proportion to the face or the rest of the body. Occurring at an age when as yet the bones of the skull have not become welded together, the enlargement may go on to an enormous extent, the spaces between the bones becoming more and more expanded. In a well-marked case the deformity is very striking; the upper part of the forehead projects abnormally, and the orbital plates of the frontal bone being inclined forwards give a downward tilt to the eyes, which have also peculiar rolling movements. The face is small, and this, with the enlarged head, gives a remarkable aged expression to the child. The body is ill-nourished, the bones are thin, the hair is scanty and fine and the teeth carious or absent.

The average circumference of the adult head is 22 in., and in the normal child it is of course much less. In chronic hydrocephalus the head of an infant three months old has measured 20 in.; and in the case of the man Cardinal, who died in Guy's Hospital, the head measured 33 in. In such cases the head cannot be supported by the neck, and the patient has to keep mostly in the recumbent posture. The expansibility of the skull prevents destructive pressure on the brain, yet this organ is materially affected by the presence of the fluid. The cerebral ventricles are distended, and the convolutions are flattened. Occasionally the fluid escapes into the cavity of the cranium, which it fills, pressing down the brain to the base of the skull. As a consequence, the functions of the brain are interfered with, and the mental condition is impaired. The child is dull, listless and irritable, and sometimes imbecile. The special senses become affected as the disease advances; sight is often lost, as is also hearing. Hydrocephalic children generally sink in a few years; nevertheless there have been instances of persons with this disease living to old age. There are, of course, grades of the affection, and children may present many of the symptoms of it in a slight degree, and yet recover, the head ceasing to expand, and becoming in due course firmly ossified.

Various methods of treatment have been employed, but the results are unsatisfactory. Compression of the head by bandages, and the administration of mercury with the view of promoting absorption of the fluid, are now little resorted to. Tapping the fluid from time to time through one of the spaces between the bones, drawing off a little, and thereafter employing gentle pressure, has been tried, but rarely with benefit. Attempts have also been made to establish a permanent drainage between the interior of the lateral ventricle and the sub-dural space, and between the lumbar region of the spine and the abdomen, but without satisfactory results. On the whole, the plan of treatment which aims at maintaining the patient's nutrition by appropriate food and tonics is the most rational and successful. (E. O.)\*

**HYDROCHARIDEAE**, in botany, a natural order of Monocotyledons, belonging to the series Helobieae. They are water-plants, represented in Britain by frog-bit (*Hydrocharis morsus-ranae*) and water-soldier (*Stratiotes aloides*). The order contains about fifty species in fifteen genera, twelve of which occur in fresh water while three are marine; and

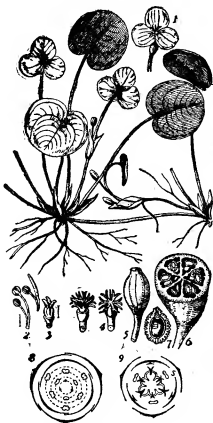

FIG. 1.—*Hydrocharis morsus-ranae*—Frog-bit—male plant.

1. Female flower.
2. Stamens, enlarged.
3. Barren pistil of male flower, enlarged.
4. Pistil of female flower.
5. Fruit.
6. Fruit cut transversely.
7. Seed.
- 8, 9. Floral diagrams of male and female flowers respectively.
10. Rudimentary stamens.

water-thyme, which has been introduced into the British Isles from North America. It is a small, submerged plant with long, slender branching stems bearing whorls of narrow toothed leaves; the flowers appear at the surface when mature. *Halophila*, *Enhalus* and *Thalassia* are submerged maritime plants found on tropical coasts, mainly in the Indian and Pacific oceans; *Halophila* has an elongated stem rooting at the nodes; *Enhalus* a short, thick rhizome, clothed with black threads resembling horse-hair, the

persistent hard-stands of the leaves; *Thalassia* has a creeping rooting stem with upright branches bearing crowded strap-shaped leaves in two rows. The flowers spring from, or are enclosed in, a spathe, and are unisexual and regular, with generally a calyx and corolla, each of three members; the stamens are in whorls of three, the inner whorls are often barren; the two to fifteen carpels form an inferior ovary containing generally numerous ovules on often large, produced, parietal placentas. The fruit is leathery or fleshy, opening irregularly. The seeds contain a large embryo and no endosperm. In

*Hydrocharis* (fig.

1), which is dioecious, the flowers are borne above the surface of the water, have conspicuous white petals, contain honey and are pollinated by insects. *Stratiotes*

has similar flowers which come above the surface only for pollination, becoming submerged again during ripening of the fruit. In *Val-*

*lissneria* (fig. 2), which is also dioecious, the small male flowers are borne in large numbers in short-stalked spathes; the petals are minute and scale-like, and only two of the three

stamens are fertile; the flowers are fertile; the flowers are raised to the surface before opening and rise to the surface, where the sepals expand and form a float bearing the two projecting semi-erect stamens. The female flowers are solitary and are raised to the surface on a long, spiral stalk; the ovary bears three broad styles, on

which some of the large, sticky pollen-grains from the floating male flowers get deposited (fig. 3). After pollination the female flower becomes drawn below the surface by the spiral contraction of the long stalk, and the fruit ripens near the bottom.

*Elodea* has polygamous flowers (that is, male, female and hermaphrodite), solitary, in slender, tubular spathes; the male flowers become detached and rise to the surface; the females are raised to the surface when mature, and receive the floating pollen from the male. The flowers of *Halophila* are submerged and apetalous.

The order is a widely distributed one; the marine forms are tropical or subtropical, but the fresh-water genera occur also in the temperate zones.

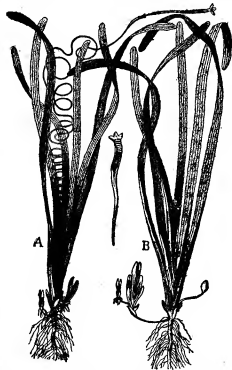

FIG. 2.—*Vallisneria spiralis*—Eel grass—about  $\frac{1}{2}$  natural size. A, Female plant; B, Male plant.

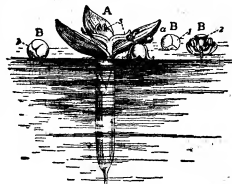

FIG. 3.

**HYDROCHLORIC ACID**, also known in commerce as "spirits of salts" and "muriatic acid," a compound of hydrogen and chlorine. Its chemistry is discussed under CHLORINE, and its manufacture under ALKALI MANUFACTURE.

**HYDRODYNAMICS** (Gr. *ὕδωρ*, water, *δύναμις*, strength), the branch of hydromechanics which discusses the motion of fluids (see HYDROMECHANICS).

**HYDROGEN** [symbol H, atomic weight 1.008 ( $\alpha=16$ )], one of the chemical elements. Its name is derived from Gr. *ὕδωρ*, water, and *γεννάω*, to produce, in allusion to the fact that water is produced when the gas burns in air. Hydrogen appears to have been recognized by Paracelsus in the 16th century; the combustibility of the gas was noticed by Turquet de Mayenne in the 17th century, whilst in 1700 N. Lemery showed that a mixture of hydrogen and air detonated on the application of a light. The first definite experiments concerning the nature of hydrogen were made in 1766 by H. Cavendish, who showed that it was formed when various metals were acted upon by dilute sulphuric or hydrochloric acids. Cavendish called it "inflammable air," and for some time it was confused with other inflammable gases, all of which were supposed to contain the same inflammable principle, "phlogiston," in combination with varying amounts of other substances. In 1781 Cavendish showed that water was the only substance produced when hydrogen was burned in air or oxygen, it having been thought previously to this date that other substances were formed during the reaction. A. L. Lavoisier making many experiments with the object of finding an acid among the products of combustion.

Hydrogen is found in the free state in some volcanic gases, in fumaroles, in the carnallite of the Staffurst potash mines (H. Precht, *Ber.*, 1886, 19, p. 2326), in some meteorites, in certain stars and nebulae, and also in the envelopes of the sun. In combination it is found as a constituent of water, of the gases from certain mineral springs, in many minerals, and in most animal and vegetable tissues. It may be prepared by the electrolysis of acidulated water, by the decomposition of water by various metals or metallic hydrides, and by the action of many metals on acids or on bases. The alkali metals and alkaline earth metals decompose water at ordinary temperatures; magnesium begins to react above 70° C., and zinc at a dull red heat. The decomposition of steam by red hot iron has been studied by H. Sainte-Claire Deville (*Comptes rendus*, 1870, 70, p. 1105) and by H. Debray (*ibid.*, 1879, 88, p. 1341), who found that at about 1500° C. a condition of equilibrium is reached. H. Moissan (*Bull. soc. chim.*, 1902, 27, p. 1141) has shown that potassium hydride decomposes cold water, with evolution of hydrogen,  $\text{KH} + \text{H}_2\text{O} = \text{KOH} + \text{H}_2$ . Calcium hydride or hydrolite, prepared by passing hydrogen over heated calcium, decomposes water similarly, 1 gram giving 1 litre of gas; it has been proposed as a commercial source (Prats Aymerych, *Abst. J.C.S.*, 1907, ii, p. 543), as has also aluminium turnings moistened with potassium cyanide and mercuric chloride, which decomposes water regularly at 70°, 1 gram giving 1.3 litres of gas (Mauricheau-Beaupré, *Comptes rendus*, 1908, 147, p. 310). Strontium hydride behaves similarly. In preparing the gas by the action of metals on acids, dilute sulphuric or hydrochloric acid is taken, and the metals commonly used are zinc or iron. So obtained, it contains many impurities, such as carbon dioxide, nitrogen, oxides of nitrogen, phosphoretted hydrogen, arseniuretted hydrogen, &c., the removal of which is a matter of great difficulty (see E. W. Morley, *Amer. Chem. Journ.*, 1890, 12, p. 460). When prepared by the action of metals on bases, zinc or aluminium and caustic soda or caustic potash are used. Hydrogen may also be obtained by the action of zinc on ammonium salts (the nitrate excepted) (Lorin, *Comptes rendus*, 1865, 60, p. 745) and by heating the alkali formates or oxalates with caustic potash or soda,  $\text{Na}_2\text{C}_2\text{O}_4 + 2\text{NaOH} = \text{H}_2 + 2\text{Na}_2\text{CO}_3$ . Technically it is prepared by the action of superheated steam on incandescent coke (see F. Hembert and Henry, *Comptes rendus*, 1885, 101, p. 797; A. Naumann and C. Pistor, *Ber.*, 1885, 18, p. 1647), or by the electrolysis of a dilute solution of caustic soda (C. Winssinger,

*Chem. Zeit.*, 1898, 22, p. 609; "Die Elektrizitäts-Aktiengesellschaft," *Zeit. f. Electrochem.*, 1901, 7, p. 857). In the latter method a 15% solution of caustic soda is used, and the electrodes are made of iron; the cell is packed in a wooden box, surrounded with sand, so that the temperature is kept at about 70° C.; the solution is replenished, when necessary, with distilled water. The purity of the gas obtained is about 97%.

Pure hydrogen is a tasteless, colourless and odourless gas of specific gravity 0.06947 (air=1) (Lord Rayleigh, *Proc. Roy. Soc.*, 1893, p. 310). It may be liquefied, the liquid boiling at  $-252.68^\circ\text{C}$ . to  $-252.84^\circ\text{C}$ ., and it has also been solidified, the solid melting at  $-264^\circ\text{C}$ . (J. Dewar, *Comptes rendus*, 1899, 129, p. 457; *Chem. News*, 1901, 84, p. 49; see also LIQUID GASES). The specific heat of gaseous hydrogen (at constant pressure) is 3.4041 (water=1), and the ratio of the specific heat at constant pressure to the specific heat at constant volume is 1.3852 (W. C. Röntgen, *Pogg. Ann.*, 1873, 148, p. 580). On the spectrum see SPECTROSCOPY. Hydrogen is only very slightly soluble in water. It diffuses very rapidly through a porous membrane, and through some metals at a red heat (T. Graham, *Proc. Roy. Soc.*, 1867, 15, p. 223; H. Sainte-Claire Deville and L. Troost, *Comptes rendus*, 1863, 56, p. 977). Palladium and some other metals are capable of absorbing large volumes of hydrogen (especially when the metal is used as a cathode in a water electrolysis apparatus). L. Troost and P. Hautefeuille (*Ann. chim. phys.*, 1874, (5) 2, p. 279) considered that a palladium hydride of composition  $\text{Pd}_2\text{H}$  was formed, but the investigations of C. Hoitsema (*Zeit. phys. Chem.*, 1895, 17, p. 1), from the standpoint of the phase rule, do not favour this view, Hoitsema being of the opinion that the occlusion of hydrogen by palladium is a process of continuous absorption. Hydrogen burns with a pale blue non-luminous flame, but will not support the combustion of ordinary combustibles. It forms a highly explosive mixture with air or oxygen, especially when in the proportion of two volumes of hydrogen to one volume of oxygen. H. B. Baker (*Proc. Chem. Soc.*, 1902, 18, p. 40) has shown that perfectly dry hydrogen will not unite with perfectly dry oxygen. Hydrogen combines with fluorine, even at very low temperatures, with great violence; it also combines with carbon, at the temperature of the electric arc. The alkali metals when warmed in a current of hydrogen, at about 360° C., form hydrides of composition  $\text{RH}(\text{R}=\text{Na}, \text{K}, \text{Rb}, \text{Cs})$ , (H. Moissan, *Bull. soc. chim.*, 1902, 27, p. 1141); calcium and strontium similarly form hydrides  $\text{CaH}_2$ ,  $\text{SrH}_2$  at a dull red heat (A. Guntz, *Comptes rendus*, 1901, 133, p. 1209). Hydrogen is a very powerful reducing agent; the gas occluded by palladium being very active in this respect, readily reducing ferric salts to ferrous salts, nitrates to nitrites and ammonia, chlorates to chlorides, &c.

For determinations of the volume ratio with which hydrogen and oxygen combine, see J. B. Dumas, *Ann. chim. phys.*, 1843 (3), 8, p. 189; O. Erdmann and R. F. Marchand, *ibid.*, p. 212; E. H. Keiser, *Ber.*, 1887, 20, p. 2323; J. P. Cooke and T. W. Richards, *Amer. Chem. Journ.*, 1888, 10, p. 191; Lord Rayleigh, *Chem. News*, 1889, 59, p. 147; E. W. Morley, *Zeit. phys. Chem.*, 1890, 20, p. 417; and S. A. Leduc, *Comptes rendus*, 1899, 128, p. 1158.

Hydrogen combines with oxygen to form two definite compounds, namely, water (*g.v.*),  $\text{H}_2\text{O}$ , and hydrogen peroxide,  $\text{H}_2\text{O}_2$ , whilst the existence of a third oxide, ozonic acid, has been indicated.

*Hydrogen peroxide*,  $\text{H}_2\text{O}_2$ , was discovered by L. J. Thénard in 1818 (*Ann. chim. phys.*, 8, p. 306). It occurs in small quantities in the atmosphere. It may be prepared by passing a current of carbon dioxide through ice-cold water, to which small quantities of barium peroxide are added from time to time (F. Duprey, *Comptes rendus*, 1862, 55, p. 736; A. J. Balard, *ibid.*, p. 758),  $\text{BaO} + \text{CO}_2 + \text{H}_2\text{O} = \text{H}_2\text{O}_2 + \text{BaCO}_3$ . E. Merck (*Abst. J.C.S.*, 1907, ii, p. 859) showed that barium percarbonate,  $\text{BaCO}_3$ , is formed when the gas is in excess; this substance readily yields the peroxide with an acid. Or barium peroxide may be decomposed by hydrochloric, hydrofluoric, sulphuric or silicofluoric acids (L. Crismer, *Bull. soc. chim.*, 1891 (3), 6, p. 24; Hanriot, *Comptes rendus*, 1885, 100, pp. 56, 172), the peroxide being added

in small quantities to a cold dilute solution of the acid. It is necessary that it should be as pure as possible since the commercial product usually contains traces of ferric, manganic and aluminium oxides, together with some silica. To purify the oxide, it is dissolved in dilute hydrochloric acid until the acid is nearly neutralized, the solution is cooled, filtered, and baryta water is added until a faint permanent white precipitate of hydrated barium peroxide appears; the solution is now filtered, and a concentrated solution of baryta water is added to the filtrate, when a crystalline precipitate of hydrated barium peroxide,  $\text{BaO}_8 \cdot \text{H}_2\text{O}$ , is thrown down. This is filtered off and well washed with water. The above methods give a dilute aqueous solution of hydrogen peroxide, which may be concentrated somewhat by evaporation over sulphuric acid *in vacuo*. H. P. Talbot and H. R. Moody (*Jour. Anal. Chem.*, 1892, 6, p. 650) prepared a more concentrated solution from the commercial product, by the addition of a 10% solution of alcohol and baryta water. The solution is filtered, and the barium precipitated by sulphuric acid. The alcohol is removed by distillation *in vacuo*, and by further concentration *in vacuo* a solution may be obtained which evolves 580 volumes of oxygen. R. Wolfenstein (*Ber.*, 1894, 27, p. 2307) prepared practically anhydrous hydrogen peroxide (containing 99.1%  $\text{H}_2\text{O}_2$ ) by first removing all traces of dust, heavy metals and alkali from the commercial 3% solution. The solution is then concentrated in an open basin on the water-bath until it contains 48%  $\text{H}_2\text{O}_2$ . The liquid so obtained is extracted with ether and the ethereal solution distilled under diminished pressure, and finally purified by repeated distillations. W. Staedel (*Zeit. f. angew. Chem.*, 1902, 15, p. 642) has described solid hydrogen peroxide, obtained by freezing concentrated solutions.

Hydrogen peroxide is also found as a product in many chemical actions, being formed when carbon monoxide and cyanogen burn in air (H. B. Dixon); by passing air through solutions of strong bases in the presence of such metals as do not react with the bases to liberate hydrogen; by shaking zinc amalgam with alcoholic sulphuric acid and air (M. Traube, *Ber.*, 1882, 15, p. 659); in the oxidation of zinc, lead and copper in presence of water, and in the electrolysis of sulphuric acid of such strength that it contains two molecules of water to one molecule of sulphuric acid (M. Berthelot, *Comptes rendus*, 1878, 86, p. 71).

The anhydrous hydrogen peroxide obtained by Wolfenstein boils at  $84.8^\circ\text{C}$ . (68 mm.); its specific gravity is 1.4906 ( $1.5^\circ\text{C}$ ). It is very explosive (W. Spring, *Zeit. anorg. Chem.*, 1895, 8, p. 424). The explosion risk seems to be most marked in the preparations which have been extracted with ether previous to distillation, and J. W. Brühl (*Ber.*, 1895, 28, p. 2847) is of opinion that a very unstable, more highly oxidized product is produced in small quantity in the process. The solid variety prepared by Staedel forms colourless, prismatic crystals which melt at  $-2^\circ\text{C}$ .; it is decomposed with explosive violence by platinum sponge, and traces of manganese dioxide. The dilute aqueous solution is very unstable, giving up oxygen readily, and decomposing with explosive violence at  $100^\circ\text{C}$ . An aqueous solution containing more than 1.5% hydrogen peroxide reacts slightly acid. Towards lupetidin [aa' dimethyl piperidine,  $\text{C}_8\text{H}_{15}\text{N}(\text{CH}_3)_2$ ] hydrogen peroxide acts as a dibasic acid (A. Marcuse and R. Wolfenstein, *Ber.*, 1901, 34, p. 2430; see also G. Bredig, *Zeit. Electrochem.*, 1901, 7, p. 622). Cryoscopic determinations of its molecular weight show that it is  $\text{H}_2\text{O}_2$ . [G. Carrara, *Rend. della Accad. dei Lincei*, 1892 (5), i. ii, p. 19; W. R. Orndorff and J. White, *Amer. Chem. Journ.*, 1893, 15, p. 347.] Hydrogen peroxide behaves very frequently as a powerful oxidizing agent; thus lead sulphide is converted into lead sulphate in presence of a dilute aqueous solution of the peroxide, the hydroxides of the alkaline earth metals are converted into peroxides of the type  $\text{MO}_2 \cdot 8\text{H}_2\text{O}$ , titanium dioxide is converted into the trioxide, iodine is liberated from potassium iodide, and nitriles (in alkaline solution) are converted into acid-amides (B. Radziszewski, *Ber.*, 1884, 17, p. 355). In many cases it is found that hydrogen peroxide will only act as an oxidant when in the presence of a

catalyst; for example, formic, glycolic, lactic, tartaric, malic, benzoic and other organic acids are readily oxidized in the presence of ferrous sulphate (H. J. H. Fenton, *Jour. Chem. Soc.*, 1900, 77, p. 60), and sugars are readily oxidized in the presence of ferric chloride (O. Fischer and M. Busch, *Ber.*, 1891, 24, p. 1871). It is sought to explain these oxidation processes by assuming that the hydrogen peroxide unites with the compound undergoing oxidation to form an addition compound, which subsequently decomposes (J. H. Kastle and A. S. Loewenhardt, *Amer. Chem. Journ.*, 1903, 29, pp. 397, 517). Hydrogen peroxide can also react as a reducing agent, thus silver oxide is reduced with a rapid evolution of oxygen. The course of this reaction can scarcely be considered as definitely settled; M. Berthelot considers that a higher oxide of silver is formed, whilst A. Baeyer and V. Villiger are of opinion that reduced silver is obtained [see *Comptes rendus*, 1001, 133, p. 555; *Ann. Chim. Phys.*, 1897 (7), 11, p. 217, and *Ber.*, 1901, 34, p. 2769]. Potassium permanganate, in the presence of dilute sulphuric acid, is rapidly reduced by hydrogen peroxide, oxygen being given off,  $2\text{KMnO}_4 + 3\text{H}_2\text{SO}_4 + 5\text{H}_2\text{O}_2 = \text{K}_2\text{SO}_4 + 2\text{MnSO}_4 + 8\text{H}_2\text{O} + 5\text{O}_2$ . Lead peroxide is reduced to the monoxide. Hypochlorous acid and its salts, together with the corresponding bromine and iodine compounds, liberate oxygen violently from hydrogen peroxide, giving hydrochloric, hydrobromic and hydroiodic acids (S. Tanatar, *Ber.*, 1899, 32, p. 1013).

On the constitution of hydrogen peroxide see C. F. Schonbein, *Jour. prak. Chem.*, 1858-1868; M. Traube, *Ber.*, 1882-1889; J. W. Brühl, *Ber.*, 1895, 28, p. 2847; 1900, 33, p. 1709; S. Tanatar, *Ber.*, 1903, 36, p. 1893.

Hydrogen peroxide finds application as a bleaching agent, as an antiseptic, for the removal of the last traces of chlorine and sulphur dioxide employed in bleaching, and for various quantitative separations in analytical chemistry (P. Jannasch, *Ber.*, 1893, 26, p. 2908). It may be estimated by titration with potassium permanganate in acid solution, with potassium ferricyanide in alkaline solution,  $2\text{K}_3\text{Fe}(\text{CN})_6 + 2\text{KOH} + \text{H}_2\text{O}_2 = 2\text{K}_3\text{Fe}(\text{CN})_6 + 2\text{H}_2\text{O} + \text{O}_2$ ; or by oxidizing arsenious acid in alkaline solution with the peroxide and back titration of the excess of arsenious acid with standard iodine (B. Grützner, *Arch. der Pharm.*, 1899, 237, p. 705). It may be recognized by the violet coloration it gives when added to a very dilute solution of potassium bichromate in the presence of hydrochloric acid; by the orange-red colour it gives with a solution of titanium dioxide in concentrated sulphuric acid; and by the precipitate of Prussian blue formed when it is added to a solution containing ferric chloride and potassium ferricyanide.

*Ozonic Acid, H<sub>2</sub>O<sub>3</sub>*. By the action of ozone on a 40% solution of potassium hydroxide, placed in a freezing mixture, an orange-brown substance is obtained, probably  $\text{K}_2\text{O}_3$ , which A. Baeyer and V. Villiger (*Ber.*, 1902, 35, p. 3038) think is derived from ozonic acid, produced according to the reaction  $\text{O}_3 + \text{H}_2\text{O} = \text{H}_2\text{O}_3$ .

**HYDROGRAPHY** (Gr.  $\text{ὕδωρ}$ , water, and  $\text{γράφω}$ , to write), the science dealing with all the waters of the earth's surface, including the description of their physical features and conditions; the preparation of charts and maps showing the position of lakes, rivers, seas and oceans, the contour of the sea-bottom, the position of shallows, deeps, reefs and the direction and volume of currents; a scientific description of the position, volume, configuration, motion and condition of all the waters of the earth. See also SURVEYING (Nautical) and OCEAN AND OCEANOGRAPHY. The Hydrographic Department of the British Admiralty, established in 1795, undertakes the making of charts for the admiralty, and is under the charge of the hydrographer to the admiralty (see CHART).

**HYDROLYSIS** (Gr.  $\text{ὕδωρ}$ , water,  $\lambda\upsilon\epsilon\omega$ , to loosen), in chemistry, a decomposition brought about by water after the manner shown in the equation  $\text{R-X} + \text{H-OH} = \text{R-H} + \text{X-OH}$ . Modern research has proved that such reactions are not occasioned by water acting as  $\text{H}_2\text{O}$ , but really by its ions (hydrions and hydroxidions), for the velocity is proportional (in accordance with the law of chemical mass action) to the concentration of these ions. This fact explains the so-called "catalytic" action of acids and bases in decomposing such compounds as the esters. The term "saponification" (Lat. *sapo*, soap) has the same meaning, but it is more properly restricted to the hydrolysis of the fats, i.e. glycerol esters of organic acids, into glycerin and a soap (see CHEMICAL ACTION).

**HYDROMECHANICS** (Gr. ὑδρομηχανικά), the science of the mechanics of water and fluids in general, including *hydrostatics* or the mathematical theory of fluids in equilibrium, and *hydro-mechanics*, the theory of fluids in motion. The practical application of hydromechanics forms the province of hydraulics (*q.v.*).

*Historical.*—The fundamental principles of hydrostatics were first given by Archimedes in his work Περὶ τῶν ὀβελίων, or *De vis quæ vehitur in humido*, about 250 B.C., and were afterwards applied to experiments by Marino Ghetaldi (1566–1627) in his *Promotus Archimedes* (1603). Archimedes maintained that each particle of a fluid mass, when in equilibrium, is equally pressed in every direction; and he inquired into the conditions according to which a solid body floating in a fluid should assume and preserve a position of equilibrium.

In the Greek school at Alexandria, which flourished under the auspices of the Ptolemies, the first attempts were made at the construction of hydraulic machinery, and about 120 B.C. the fountain of compression, the siphon, and the forcing-pump were invented by Ctesibius and Hero. The siphon is a simple instrument; but the forcing-pump is a complicated invention, which could scarcely have been expected in the infancy of hydraulics. It was probably suggested to Ctesibius by the Egyptian Wheel or *Noria*, which was common at that time, and which was a kind of chain pump, consisting of a number of earthen pots carried round by a wheel. In some of these machines the pots have a valve at the bottom, which enables them to descend without much resistance, and diminishes greatly the load upon the wheel; and, if we suppose that this valve was introduced so early as the time of Ctesibius, it is not difficult to perceive how such a machine might have led to the invention of the forcing-pump.

Notwithstanding these inventions of the Alexandrian school, its attention does not seem to have been directed to the motion of fluids; and the first attempt to investigate this subject was made by Sextus Julius Frontinus, inspector of the public fountains at Rome in the reigns of Nerva and Trajan. In his work *De aquaeductibus urbis Romæ commentarius*, he considers the methods which were at that time employed for ascertaining the quantity of water discharged from aqueducts, and the mode of distributing the waters of an aqueduct or a fountain. He remarked that the flow of water from an orifice depends not only on the magnitude of the orifice itself, but also on the height of the water in the reservoir; and that a pipe employed to carry off a portion of water from an aqueduct should, as circumstances required, have a position more or less inclined to the original direction of the current. But as he was unacquainted with the law of the velocities of running water as depending upon the depth of the orifice, the want of precision which appears in his results is not surprising.

Benedetto Castelli (1577–1634), and Evangelista Torricelli (1608–1647), two of the disciples of Galileo, applied the discoveries of their master to the science of hydrodynamics. In 1628 Castelli published a small work, *Della misura dell'acque correnti*, in which he satisfactorily explained several phenomena in the motion of fluids in rivers and canals; but he committed a great paralogism in supposing the velocity of the water proportional to the depth of the orifice below the surface of the vessel. Torricelli, observing that in a jet where the water rushed through a small ajutage it rose to nearly the same height with the reservoir from which it was supplied, imagined that it ought to move with the same velocity as if it had fallen through that height by the force of gravity, and hence he deduced the proposition that the velocities of liquids are as the square root of the head apart from the resistance of the air and the friction of the orifice. This theorem was published in 1644, at the end of his treatise *De motu gravium projectorum*, and it was confirmed by the experiments of Raffaello Magiotti on the quantities of water discharged from different ajutages under different pressures (1648).

In the hands of Blaise Pascal (1623–1662) hydrostatics assumed the dignity of a science, and, in a treatise on the equilibrium of liquids (*Sur l'équilibre des liqueurs*), found among his manuscripts after his death and published in 1663, the laws of the equilibrium of liquids were demonstrated in the most simple manner, and amply confirmed by experiments.

The theorem of Torricelli was employed by many succeeding writers; but particularly by Edmé Mariotte (1620–1684), whose *Traité du mouvement des eaux*, published after his death in the year 1686, is founded on a great variety of well-conducted experiments on the motion of fluids, performed at Versailles and Chantilly. In the discussion of some points he committed considerable mistakes. Others he treated very superficially, and in none of his experiments apparently did he attend to the diminution of efflux arising from the contraction of the liquid vein, when the orifice is merely a perforation in a thin plate; but he appears to have been the first who attempted to ascribe the discrepancy between theory and experiment to the retardation of the water's velocity through friction. His contemporary Domenico Guglielmini (1655–1710), who was inspector of the rivers and canals at Bologna, had ascribed this diminution of velocity in rivers to transverse motions arising from inequalities in their bottom. But as Mariotte observed similar obstructions even in glass pipes where no transverse currents could exist, the cause

assigned by Guglielmini seemed destitute of foundation. The French philosopher, therefore, regarded these obstructions as the effects of friction. He supposed that the filaments of water which graze along the sides of the pipe lose a portion of their velocity; that the contiguous filaments, having on this account a greater velocity, rub upon the former, and suffer a diminution of their celerity; and that the other filaments are affected with similar retardations proportional to their distance from the axis of the pipe. In this way the medium velocity of the current may be diminished, and consequently the quantity of water discharged in a given time must, from the effects of friction, be considerably less than that which is computed from theory.

The effects of friction and viscosity in diminishing the velocity of running water were noticed in the *Principia* of Sir Isaac Newton, who threw much light upon several branches of hydromechanics. At a time when the Cartesian system of vortices universally prevailed, he found it necessary to investigate that hypothesis, and in the course of his investigations he showed that the velocity of any stratum of the vortex is an arithmetical mean between the velocities of the strata which enclose it; and from this it evidently follows that the velocity of a filament of water moving in a pipe is an arithmetical mean between the velocities of the filaments which surround it. Taking advantage of these results, Henri Pitot (1695–1771) afterwards discovered that the diameters flowing from friction are inversely as the diameters of the pipes in which the fluid moves. The attention of Newton was also directed to the discharge of water from orifices in the bottom of vessels. He supposed a cylindrical vessel full of water to be perforated in its bottom with a small hole by which the water escaped, and the vessel to be supplied with water in such a manner that it always remained full at the same height. He then supposed this cylindrical column of water to be divided into two parts,—the first, which he called the "cataract," being an hyperboloid generated by the revolution of an hyperbola of the fifth degree around the axis of the cylinder which should pass through the orifice, and the second the remainder of the water in the cylindrical vessel. He considered the horizontal strata of this hyperboloid as always in motion, while the remainder of the water was in a state of rest, and imagined that there was a kind of cataract in the middle of the fluid. When the results of this theory were compared with the quantity of water actually discharged, Newton concluded that the velocity with which the water issued from the orifice was equal to that which a falling body would receive by descending through half the height of water in the reservoir. This conclusion, however, is absolutely irreconcilable with the known fact that jets of water rise nearly to the same height as their reservoirs, and Newton seems to have been aware of this objection. Accordingly, in the second edition of his *Principia*, which appeared in 1713, he abandoned this theory. He afterwards discovered the contraction of the vein of fluid (*vena contracta*), which issues from the orifice, and found that, at the distance of about a diameter of the aperture, the section of the vein was contracted in the subduplicate ratio of two to one. He regarded, therefore, the section of the contracted vein as the true orifice from which the discharge of water ought to be deduced, and the velocity of the effluent water as due to the whole height of water in the reservoir; and by this means his theory became more conformable to the results of experience, though still open to serious objections. Newton was also the first to investigate the difficult subject of the motion of waves (*q.v.*).

In 1738 Daniel Bernoulli (1700–1782) published his *Hydrodynamica seu de viribus et motibus fluidorum commentarii*. His theory of the motion of fluids, the germ of which was first published in his memoir entitled *Theoria nova de motu aquarum per canales quoscunque fluentes*, communicated to the Academy of St Petersburg as early as 1726, was founded on two suppositions, which appeared to him conformable to experience. He supposed that the surface of the fluid, contained in a vessel which is emptying itself by an orifice, remains always horizontal; and, if the fluid mass is conceived to be divided into an infinite number of horizontal strata of the same bulk, that these strata remain contiguous to each other, and that all their points descend vertically, with velocities inversely proportional to their breadth, or to the horizontal sections of the reservoir. In order to determine the motion of each stratum, he employed the principle of the *conservatio virium*, and obtained very elegant solutions. But in the absence of a general demonstration of that principle, his results did not command the confidence which they would otherwise have deserved, and it became desirable to have a theory more certain, and depending solely on the fundamental laws of mechanics. Colin Maclaurin (1698–1745) and John Bernoulli (1667–1748), who were of this opinion, resolved the problem by more direct methods, the one in his *Fluxions*, published in 1742, and the other in his *Hydraulica nunc primum detecta, et demonstrata directæ ex fundamentis pure mechanicis, which forms the fourth volume of his works*. The method employed by Maclaurin has been thought not sufficiently rigorous; and that of John Bernoulli is, in the opinion of several writers, of less clearness and precision. The theory of Daniel Bernoulli was opposed also by Jean le Rond d'Alembert. When generalizing the theory of pendulums of Jacob Bernoulli (1654–1705) he discovered a principle of dynamics so simple and general that it reduced the laws of the motions of bodies to that of their equilibrium. He applied this

principle to the motion of fluids, and gave a specimen of its application at the end of his *Dynamics* in 1743. It was more fully developed in his *Traité des fluides*, published in 1744, in which he gave simple and elegant solutions of problems relating to the equilibrium and motion of fluids. He made use of the same suppositions as Daniel Bernoulli, though his calculus was established in a very different manner. He assumed, at every instant, the actual motion of a stratum as composed of a motion which it had in the preceding instant and of a motion which it had lost; and the laws of equilibrium between the motions lost furnished him with equations representing the motion of the fluid. It remained a desideratum to express by equations the motion of a particle of the fluid in any assigned direction. These equations were found by d'Alembert from two principles—that a rectangular canal, taken in a mass of fluid in equilibrium, is itself in equilibrium, and that a portion of the fluid, in passing from one place to another, preserves the same volume when the fluid is incompressible, or dilates itself according to a given law when the fluid is elastic. His ingenious method, published in 1752, in his *Essai sur la résistance des fluides*, was brought to perfection in his *Opuscules mathématiques*, and was adopted by Leonhard Euler.

The resolution of the questions concerning the motion of fluids was effected by means of Euler's partial differential coefficients. This calculus was first applied to the motion of water by d'Alembert, and enabled both him and Euler to represent the theory of fluids in formulae rejected by no particular hypothesis.

One of the most successful labourers in the science of hydrodynamics at this period was Pierre Louis Georges Dubaut (1734-1809). Following in the steps of the Abbé Charles Bossut (*Nouvelles Expériences sur la résistance des fluides*, 1777), he published, in 1786, a revised edition of his *Principes d'hydraulique*, which contains a satisfactory theory of the motion of fluids, founded solely upon experiments. Dubaut considered that if water were a perfect fluid, and the channels in which it flowed infinitely smooth, its motion would be continually accelerated, like that of bodies descending in an inclined plane. But as the motion of rivers is not continually accelerated, and soon arrives at a state of uniformity, it is evident that the viscosity of the water, and the friction of the channel in which it descends, must equal the accelerating force. Dubaut, therefore, assumed it as a proposition of fundamental importance that, when water flows in any channel or bed, the accelerating force which obliges it to move is equal to the sum of all the resistances which it meets with, whether they arise from its own viscosity or from the friction of its bed. This principle was followed by him in the first edition of his work, which appeared in 1779. The theory contained in that edition was founded on the experiments of others, but he soon saw that a theory so new, and leading to results so different from the ordinary theory, should be founded on new experiments more direct than the former, and he was employed in the performance of these from 1780 to 1783. The experiments of Bossut were made only on pipes of a moderate declivity, but Dubaut used declivities of every kind, and made his experiments upon channels of various sizes.

The theory of running water was greatly advanced by the researches of Gaspard Riche de Prony (1755-1839). From a collection of the best experiments by previous workers he selected eighty-two (fifty-one on the velocity of water in conduit pipes, and thirty-one on its velocity in open canals); and, discussing these on physical and mechanical principles, he succeeded in drawing up general formulae, which afforded a simple expression for the velocity of running water.

J. A. Eytelwein (1764-1848) of Berlin, who published in 1801 a valuable compendium of hydraulics entitled *Handbuch der Mechanik und der Hydraulik*, investigated the subject of the discharge of water by compound pipes, the motions of jets and their impulses against plane and oblique surfaces; and he showed theoretically that a water-wheel will have its maximum effect when its circumference moves with half the velocity of the stream.

J. N. P. Hachette (1769-1834) in 1816-1817 published memoirs containing the results of experiments on the spouting of fluids and the discharge of vessels. His object was to measure the contents of a part of a fluid vein, to examine the phenomena attendant on additional tubes, and to investigate the form of the fluid vein and the results obtained when different forms of orifices are employed. Extensive experiments on the discharge of water from orifices (*Expériences hydrauliques*, Paris, 1832) were conducted under the direction of the French government by J. V. Poncelet (1788-1867) and J. A. Lesbros (1790-1860). P. P. Boileau (1811-1891) discussed their results and added experiments of his own (*Traité de la mesure des eaux courantes*, Paris, 1854). C. R. Boremann re-examined all these results with great care, and gave formulae expressing the variation of the coefficients of discharge in different conditions (*Civil Ingénieur*, 1880). Julius Weisbach (1806-1871) also made many experimental investigations on the discharge of fluids. The experiments of J. B. Francis (*Lowell Hydraulic Experiments*, Boston, Mass., 1855) led him to propose variations in the accepted formulae for the discharge over weirs, and a generation later a very complete investigation of this subject was carried out by H. Bazin. An elaborate inquiry on the flow of water over weirs was conducted by H. C. P. Darcy (1803-1858) and continued by H. Bazin, at the expense of the French government (*Recherches hydrauliques*, Paris, 1866). German

engineers have also devoted special attention to the measurement of the flow in rivers; the *Beiträge zur Hydrographie des Königreiches Böhmen* (Prague, 1872-1875) of A. R. Harlachner (1842-1890) contained valuable measurements of this kind, together with a comparison of the experimental results with the formulæ of flow that had been proposed up to the date of its publication, and important data were yielded by the gaugings of the Mississippi made for the United States government by A. A. Humphreys and H. L. Abbot, by Robert Gordon's gaugings of the Irrawaddy, and by Allen J. C. Cunningham's experiments on the Ganges canal. The friction of water, investigated for slow speeds by Coulomb, was measured for higher speeds by William Froude (1810-1879), whose work is of great value in the theory of ship resistance (*Brit. Assoc. Report.*, 1869), and stream line motion was studied by Professor Osborne Reynolds and by Professor H. S. Hele Shaw.

#### HYDROSTATICS

Hydrostatics is a science which grew originally out of a number of isolated practical problems; but it satisfies the requirement of perfect accuracy in its application to phenomena, the largest and smallest, of the behaviour of a fluid. At the same time, it delights the pure theorist by the simplicity of the logic with which the fundamental theorems may be established, and by the elegance of its mathematical operations, inasmuch that hydrostatics may be considered as the Euclidean pure geometry of mechanical science.

1. *The Different States of a Substance or Matter.*—All substance in nature falls into one of the two classes, solid and fluid; a solid substance, the land, for instance, as contrasted with a fluid, like water, being a substance which does not flow of itself.

A fluid, as the name implies, is a substance which flows, or is capable of flowing; water and air are the two fluids distributed most universally over the surface of the earth.

Fluids again are divided into two classes, termed a liquid and a gas, of which water and air are the chief examples.

A liquid is a fluid which is incompressible or practically so, i.e. it does not change in volume sensibly with change of pressure.

A gas is a compressible fluid, and the change in volume is considerable with moderate variation of pressure.

Liquids, again, can be poured from one open vessel into another, and can be kept in an uncovered vessel, but a gas tends to diffuse itself indefinitely and must be preserved in a closed reservoir.

The distinguishing characteristics of the three kinds of substance or states of matter, the solid, liquid and gas, are summarized thus in O. Lodge's *Mechanics*:—

A solid has both size and shape.

A liquid has size but not shape.

A gas has neither size nor shape.

2. *The Change of State of Matter.*—By a change of temperature and pressure combined, a substance can in general be made to pass from one state into another; thus by gradually increasing the temperature a solid piece of ice can be melted into the liquid state of water, and the water again can be boiled off into the gaseous state as steam. Again, by raising the temperature, a metal in the solid state can be melted and liquefied, and poured into a mould to assume any form desired; which is retained when the metal cools and solidifies again; the gaseous state of a metal is revealed by the spectroscope. Conversely, a combination of increased pressure and lowering of temperature will, if carried far enough, reduce a gas to a liquid, and afterwards to the solid state; and nearly every gaseous substance has now undergone this operation.

A certain critical temperature is observed in a gas, above which the liquefaction is impossible; so that the gaseous state has two subdivisions into (i.) a true gas, which cannot be liquefied, because its temperature is above the critical temperature, (ii.) a vapour, where the temperature is below the critical, and which can ultimately be liquefied by further lowering of temperature or increase of pressure.

3. *Plasticity and Viscosity.*—Every solid substance is found to be plastic more or less, as exemplified by punching, shearing and cutting; but the plastic solid is distinguished from the viscous fluid in that a plastic solid requires a certain magnitude of stress to be exceeded to make it flow, whereas the viscous liquid will yield to the slightest stress, but requires a certain length of time for the effect to be appreciable.



According to Maxwell (*Theory of Heat*) "When a continuous alteration of form is produced only by a stress exceeding a certain value, the substance is called a solid, however soft and plastic it may be. But when the smallest stress, if only continued long enough, will cause a perceptible and increasing change of form, the substance must be regarded as a viscous fluid, however hard it may be." Maxwell illustrates the difference between a soft solid and a hard liquid by a jelly and a block of pitch; also by the experiment of supporting a candle and a stick of sealing-wax; after a considerable time the sealing-wax will be found bent and so is a fluid, but the candle remains straight as a solid.

4. *Definition of a Fluid.*—A fluid is a substance which yields continually to the slightest tangential stress in its interior; that is, it can be divided very easily along any plane (given plenty of time if the fluid is viscous). It follows that when the fluid has come to rest, the tangential stress in any plane in its interior must vanish, and the stress must be entirely normal to the plane. This mechanical axiom of the *normality of fluid pressure* is the foundation of the mathematical theory of hydrostatics.

The theorems of hydrostatics are thus true for all stationary fluids, however, viscous they may be; it is only when we come to hydrodynamics, the science of the motion of a fluid, that viscosity will make itself felt and modify the theory; unless we begin by postulating the perfect fluid, devoid of viscosity, so that the principle of the normality of fluid pressure is taken to hold when the fluid is in movement.

5. *The Measurement of Fluid Pressure.*—The pressure at any point of a plane in the interior of a fluid is the intensity of the normal thrust estimated per unit area of the plane.

Thus, if a thrust of  $P$  lb is distributed uniformly over a plane area of  $A$  sq. ft., as on the horizontal bottom of the sea or any reservoir, the pressure at any point of the plane is  $P/A$  lb per sq. ft., or  $P/144A$  lb per sq. in. ( $lb/ft^2$  and  $lb/in^2$ ), in the Hospitalier notation, to be employed in the sequel.) If the distribution of the thrust is not uniform, as, for instance, on a vertical or inclined face or wall of a reservoir, then  $P/A$  represents the average pressure over the area; and the actual pressure at any point is the average pressure over a small area enclosing the point. Thus, if the thrust  $\Delta P$  be on a small plane area  $\Delta A$  ft.<sup>2</sup> enclosing a point  $B$ , the pressure  $p$  at  $B$  is the limit of  $\Delta P/\Delta A$ ; and

$$p = \lim(\Delta P/\Delta A) = dP/dA, \quad (1)$$

in the notation of the differential calculus.

6. *The Equality of Fluid Pressure in all Directions.*—This fundamental principle of hydrostatics follows at once from the principle of the normality of fluid pressure implied in the definition of a fluid in § 4. Take any two arbitrary directions in the plane of the paper, and draw a small isosceles triangle  $abc$ , whose sides are perpendicular to the two directions, and consider the equilibrium of a small triangular prism of fluid, of which the triangle is the cross section. Let  $P$ ,  $Q$  denote the normal thrust across the sides  $bc$ ,  $ca$ , and  $R$  the normal thrust across the base  $ab$ . Then, since these three forces maintain equilibrium, and  $R$  makes equal angles with  $P$  and  $Q$ , therefore  $P$  and  $Q$  must be equal. But the faces  $bc$ ,  $ca$ , over which  $P$  and  $Q$  act, are also equal, so that the pressure on each face is equal. A scalene triangle  $abc$  might also be employed, or a tetrahedron.



FIG. 1a.

It follows that the pressure of a fluid requires to be calculated in one direction only, chosen as the simplest direction for convenience.

7. *The Transmissibility of Fluid Pressure.*—Any additional pressure applied to the fluid will be transmitted equally to every point in the case of a liquid; this principle of the *transmissibility of pressure* was enunciated by Pascal, 1653, and applied by him to the invention of the *hydraulic press*.

This machine consists essentially of two communicating cylinders (Fig. 1a), filled with liquid and closed by pistons. If a thrust  $P$  lb is applied to one piston of area  $A$  ft.<sup>2</sup>, it will be balanced by a thrust  $W$  lb applied to the other piston of area  $B$  ft.<sup>2</sup>, where

$$p = P/A = W/B, \quad (1)$$

the pressure  $p$  of the liquid being supposed uniform; and, by making the ratio  $B/A$  sufficiently large, the mechanical advantage can be increased to any desired amount, and in the simplest manner possible, without the intervention of levers and machinery.

Fig. 1b shows also a modern form of the hydraulic press, applied to the operation of covering an electric cable with a lead coating.

8. *Theorem.*—In a fluid at rest under gravity the pressure is the same at any two points in the same horizontal plane; in other words, a surface of equal pressure is a horizontal plane.

This is proved by taking any two points  $A$  and  $B$  at the same

level, and considering the equilibrium of a thin prism of liquid  $AB$ , bounded by planes at  $A$  and  $B$  perpendicular to  $AB$ . As gravity and the fluid pressure on the sides of the prism act at right angles to  $AB$ , the equilibrium requires the equality of thrust on the ends  $A$  and  $B$ ; and as the areas are equal, the pressure must be equal at  $A$  and  $B$ ; and so the pressure is the same at all points in the same horizontal plane. If the fluid is a liquid, it can have a free surface without diffusing itself, as a gas would; and this free surface, being a surface of zero pressure, or more generally of uniform atmospheric pressure, will also be a surface of equal pressure, and therefore a horizontal plane.

9. *Theorem.*—The free surface of a liquid at rest under gravity is a horizontal plane. This is the characteristic distinguishing between a solid and a liquid; as, for instance, between land and water. The land has hills and valleys, but the surface of water at rest is a horizontal plane; and if disturbed the surface moves in waves.

10. *Theorem.*—In a homogeneous liquid at rest under gravity the pressure increases uniformly with the depth.

This is proved by taking the two points  $A$  and  $B$  in the same vertical line, and considering the equilibrium of the prism by resolving vertically. In this case the thrust at the lower end  $B$  must exceed the thrust at  $A$ , the upper end, by the weight of the prism of liquid; so that, denoting the cross section of the prism by  $a$  ft.<sup>2</sup>, the pressure at  $A$  and  $B$  by  $p_a$  and  $p_b$  lb/ft.<sup>2</sup>, and by  $w$  the density of the liquid estimated in lb/ft.<sup>3</sup>,

$$p_a a - p_b a = w a \cdot AB, \quad (1)$$

$$p_b = w \cdot AB + p_a. \quad (2)$$

Thus in water, where  $w = 62.4$  lb/ft.<sup>3</sup>, the pressure increases  $62.4$  lb/ft.<sup>2</sup>, or  $62.4 \div 144 = 0.433$  lb/in.<sup>2</sup> for every additional foot of depth.

11. *Theorem.*—If two liquids of different density are resting in vessels in communication, the height of the free surface of such liquid above the surface of separation is inversely as the density.

For if the liquid of density  $\sigma$  rises to the height  $h$  and of density  $\rho$  to the height  $k$ , and  $p_0$  denotes the atmospheric pressure, the pressure in the liquid at the level of the surface of separation will be  $\sigma h + p_0$  and  $\rho k + p_0$ , and these being equal we have

$$\sigma h = \rho k. \quad (1)$$

The principle is illustrated in the article *BAROMETER*, where a column of mercury of density  $\sigma$  and height  $h$ , rising in the tube to the Torricellian vacuum, is balanced by a column of air of density  $\rho$ , which may be supposed to rise as a homogeneous fluid to a height  $k$ , the height of the homogeneous atmosphere. Thus water being about 800 times denser than air and mercury 13.6 times denser than water,

$$k/h = \sigma/\rho = 800 \times 13.6 = 10,880, \quad (2)$$

and with an average barometer height of 30 in. this makes  $h$  27,200 ft. and about 8300 meters.

12. *The Head of Water or a Liquid.*—The pressure  $\sigma h$  at a depth  $h$  ft. in liquid of density  $\sigma$  is called the pressure due to a head of  $h$  ft. of the liquid. The atmospheric pressure is thus due to an average head of 30 in. of mercury, or  $30 \times 13.6 = 408 = 34$  ft. of water, or 27,200 ft. of air. The pressure of the air is a convenient unit to employ in practical work, where it is called an "atmosphere"; it is made the equivalent of a pressure of one kg/cm.<sup>2</sup>; and one ton/inch.<sup>2</sup>, employed as the unit with high pressure as in artillery, may be taken as 150 atmospheres.

13. *Theorem.*—A body immersed in a fluid is buoyed up by a force equal to the weight of the liquid displaced, acting vertically upward through the centre of gravity of the displaced liquid.

For if the body is removed, and replaced by the fluid as first, this fluid is in equilibrium under its own weight and the thrust of the surrounding fluid, which must be equal and opposite, and the surrounding fluid acts in the same manner when the body replaces the displaced fluid again; so that the resultant thrust of the fluid acts vertically upward through the centre of gravity of the fluid displaced, and is equal to the weight.

When the body is floating freely like a ship, the equilibrium of this liquid thrust with the weight of the ship requires that the weight of water displaced is equal to the weight of the ship and the two centres of gravity are in the same vertical line. So also a balloon begins to rise when the weight of air displaced is greater than the weight of the balloon, and it is in equilibrium when the weights are equal. This theorem is called generally the *principle of Archimedes*.

It is used to determine the density of a body experimentally; for if  $W$  is the weight of a body weighed in a balance in air (strictly in *vacuo*), and if  $W'$  is the weight required to balance when the body is suspended in water, then the upward thrust of the liquid

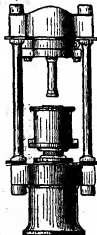

FIG. 1b.

or weight of liquid displaced is  $W-W'$ , so that the *specific gravity* (S.G.), defined as the ratio of the weight of a body to the weight of an equal volume of water, is  $W/(W-W')$ .

As stated first by Archimedes, the principle asserts the obvious fact that a body displaces its own volume of water; and he utilized it in the problem of the determination of the adulteration of the crown of Hiero. He weighed out a lump of gold and of silver of the same weight as the crown; and, immersing the three in succession in water, he found they *spilt* over measures of water in the ratio  $\frac{1}{3} : \frac{1}{4} : \frac{1}{5}$  or 32:24:44; thence it follows that the gold: silver alloy of the crown was as 11:9 by weight.

13. *Theorem*.—The resultant vertical thrust on any portion of a curved surface exposed to the pressure of a fluid at rest under gravity is the weight of fluid cut out by vertical lines drawn round the boundary of the curved surface.

*Theorem*.—The resultant horizontal thrust in any direction is obtained by drawing parallel horizontal lines round the boundary, and intersecting a plane perpendicular to their direction in a plane curve; and then investigating the thrust on this plane area, which will be the same as on the curved surface.

The *proof* of these theorems proceeds as before, employing the normality principle; they are required, for instance, in the determination of the liquid thrust on any portion of the bottom of a ship.

In casting a thin hollow object like a bell, it will be seen that the resultant upward thrust on the mould may be many times greater than the weight of metal; many a curious experiment has been devised to illustrate this property and classed as a hydrostatic paradox (Boyle, *Hydrostatical Paradoxes*, 1666).

Consider, for instance, the operation of casting a hemispherical bell, in fig. 2. As the molten metal is run in, the upward thrust on the outside mould, when the level has reached

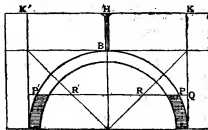

FIG. 2.

above B, to the level KK', the additional thrust is the weight of the cylinder of diameter KK' and height BH. The upward thrust is the same, however thin the metal may be in the interspace between the outer mould and the core inside; and this was formerly considered paradoxical.

*Analytical Equations of Equilibrium of a Fluid at rest under any System of Force.*

14. Referred to three fixed coordinate axes, a fluid, in which the pressure is  $p$ , the density  $\rho$ , and  $X, Y, Z$  the components of impressed force per unit mass, requires for the equilibrium of the part filling a fixed surface  $S$ , on resolving parallel to  $Ox$ ,

$$\iint \rho l dS = \iiint \rho X dx dy dz, \quad (1)$$

where  $l, m, n$  denote the direction cosines of the normal drawn outward of the surface  $S$ .

But by Green's transformation

$$\iint \rho l dS = \iiint \rho \frac{d^2 p}{dx^2} dx dy dz, \quad (2)$$

thus leading to the differential relation at every point

$$\frac{d^2 p}{dx^2} = \rho X, \quad \frac{d^2 p}{dy^2} = \rho Y, \quad \frac{d^2 p}{dz^2} = \rho Z. \quad (3)$$

The three equations of equilibrium obtained by taking moments round the axes are then found to be satisfied identically.

Hence the space variation of the pressure in any direction, or the *pressure-gradient*, is the resolved force per unit volume in that direction. The resultant force is therefore in the direction of the steepest pressure-gradient, and this is normal to the surface of equal pressure; for equilibrium to exist in a fluid the lines of force must therefore be capable of being cut orthogonally by a system of surfaces, which will be surfaces of equal pressure.

Ignoring temperature effect, and taking the density as a function of the pressure, surfaces of equal pressure are also of equal density, and the fluid is stratified by surfaces orthogonal to the lines of force;

$$\frac{1}{\rho} \frac{dp}{dx} = \frac{d\phi}{dx}, \quad \frac{1}{\rho} \frac{dp}{dy} = \frac{d\phi}{dy}, \quad \frac{1}{\rho} \frac{dp}{dz} = \frac{d\phi}{dz}, \quad \text{or } X, Y, Z \quad (4)$$

are the partial differential coefficients of some function  $\phi = \int dp/\rho$ , of  $x, y, z$ ; so that  $X, Y, Z$  must be the partial differential coefficients of a potential  $-V$ , such that the force in any direction is the downward gradient of  $V$ ; and then

$$\frac{dP}{dx} + \frac{dV}{dz} = 0, \quad \text{or } P+V = \text{constant}, \quad (5)$$

in which  $P$  may be called the hydrostatic head and  $V$  the head of potential.

With variation of temperature, the surfaces of equal pressure and density need not coincide; but, taking the pressure, density and temperature as connected by some relation, such as the gas-equation, the surfaces of equal density and temperature must intersect in lines lying on a surface of equal pressure.

15. As an example of the general equations, take the simplest case of a uniform field of gravity, with  $Oz$  directed vertically downward; employing the gravitation unit of force,

$$\frac{1}{\rho} \frac{dp}{dx} = 0, \quad \frac{1}{\rho} \frac{dp}{dy} = 0, \quad \frac{1}{\rho} \frac{dp}{dz} = 1, \quad (1)$$

$$P = \int dp/\rho = z + \text{constant}. \quad (2)$$

When the density  $\rho$  is uniform, this becomes, as before in (2) § 9

$$p = \rho z + p_0. \quad (3)$$

Suppose the density  $\rho$  varies as some  $n$ th power of the depth below  $O$ , then

$$\frac{d\rho/dz}{\rho} = \rho^{-n} \quad (4)$$

$$p = \frac{\rho^{n+1}}{n+1} = \frac{\rho^n}{n+1} \left( \frac{\rho}{\rho_0} \right)^{1/n}, \quad (5)$$

supposing  $\rho$  and  $\rho_0$  to vanish together.

These equations can be made to represent the state of convective equilibrium of the atmosphere, depending on the gas-equation

$$p = \rho k = R\rho\theta, \quad (6)$$

where  $\theta$  denotes the absolute temperature; and then

$$R \frac{d\theta}{dz} = \frac{d}{dz} \left( \frac{p}{\rho} \right) = \frac{1}{n+1}, \quad (7)$$

so that the temperature-gradient  $d\theta/dz$  is constant, as in convective equilibrium in (11).

From the gas-equation in general, in the atmosphere

$$\frac{1}{\rho} \frac{dp}{dz} = \frac{d\theta}{\theta} \frac{1}{\rho} \frac{d\rho}{dz} = \frac{1}{\theta} \frac{d\theta}{dz} - \frac{1}{\theta} \frac{d\rho}{dz} \frac{1}{\rho}. \quad (8)$$

which is positive, and the density  $\rho$  diminishes with the ascent, provided the temperature-gradient  $d\theta/dz$  does not exceed  $\theta/k$ .

With uniform temperature, taking  $k$  constant in the gas-equation,

$$\frac{d\rho/dz}{\rho} = p/k, \quad p = \rho e^{p/k}, \quad (9)$$

so that in ascending in the atmosphere of thermal equilibrium the pressure and density diminish at compound discount, and for pressures  $p_1$  and  $p_2$  at heights  $z_1$  and  $z_2$

$$(z_1 - z_2)/k = \log_e(p_2/p_1) = 2.3 \log_{10}(p_2/p_1). \quad (10)$$

In the convective equilibrium of the atmosphere, the air is supposed to change in density and pressure without exchange of heat by conduction; and then

$$p/\rho_0 = (\theta/\theta_0)^\gamma, \quad p/\rho = (\theta/\theta_0)^{\gamma+1}, \quad (11)$$

$$\frac{d\theta}{dz} = \frac{1}{\rho} \frac{dp}{dz} = (n+1) \frac{p}{\rho} = (n+1)R, \quad \gamma = 1 + \frac{1}{n},$$

where  $\gamma$  is the ratio of the specific heat at constant pressure and constant volume.

In the more general case of the convective equilibrium of a spherical atmosphere surrounding the earth, of radius  $a$ ,

$$\frac{d^2 p}{dr^2} = (n+1) \frac{p_0}{\rho_0} \frac{d\rho}{dr} = \frac{a^2}{r^2} dr, \quad (12)$$

gravity varying inversely as the square of the distance  $r$  from the centre; so that,  $k = p_0/\rho_0$ , denoting the height of the homogeneous atmosphere at the surface,  $\theta$  is given by

$$(n+1)k(1-\theta/\theta_0) = a(1-a/r), \quad (13)$$

or if  $c$  denotes the distance where  $\theta = 0$ ,

$$\frac{\theta}{\theta_0} = \frac{a}{c} \frac{c-r}{c-a}. \quad (14)$$

When the compressibility of water is taken into account in a deep ocean, an experimental law must be employed, such as

$$p - p_0 = k(p - p_0), \quad \text{or } p/\rho_0 = 1 + (p - p_0)/\lambda, \quad \lambda = k\rho_0, \quad (15)$$

so that  $\lambda$  is the pressure due to a head  $k$  of the liquid at density  $\rho_0$  under atmospheric pressure  $p_0$ ; and it is the gauge pressure required on this law to double the density. Then

$$\frac{d\rho/dz}{\rho} = k d(p - p_0)/dz = p, \quad p = \rho e^{p/\lambda}, \quad p - p_0 = k\rho_0(e^{p/\lambda} - 1); \quad (16)$$

and if the liquid was incompressible, the depth at pressure  $p$  would be  $(p - p_0)/\rho_0$ , so that the lowering of the surface due to compression is

$$k e^{p/\lambda} - k - z = \frac{1}{2} p^2/k, \quad \text{when } k \text{ is large}. \quad (17)$$

For sea water,  $\lambda$  is about 25,000 atmospheres, and  $k$  is then 25,000 times the height of the water barometer, about 250,000 metres, so that in an ocean 10 kilometres deep the level is lowered about 200 metres by the compressibility of the water; and the density at the bottom is increased  $\frac{1}{2}\%$ .

On another physical assumption of constant cubical elasticity  $\lambda$ ,

$$dp = \lambda d\rho/\rho, \quad (p - p_0)/\lambda = \log(\rho/\rho_0), \quad (18)$$

$$\frac{d\rho}{dz} = \lambda \frac{d\rho}{\rho} \frac{dz}{dz} = \lambda \left( \frac{1}{\rho_0} - \frac{1}{\rho} \right) = z, \quad 1 - \frac{\rho_0}{\rho} = \frac{z}{k}, \quad \lambda = k\rho_0, \quad (19)$$

and the lowering of the surface in

$$\frac{\rho - \rho_0}{\rho_0} z = k \log \frac{\rho}{\rho_0} z = -k \log \left( 1 - \frac{z}{k} \right) \quad z \approx \frac{z^2}{2k} \quad (20)$$

as before in 17).

16. *Centre of Pressure.*—A plane area exposed to fluid pressure on one side experiences a single resultant thrust, the integrated pressure over the area, acting through a definite point called the centre of pressure (C.P.) of the area.

Thus if the plane is normal to  $Oz$ , the resultant thrust

$$R = \iint \rho h \, dxdy, \quad (1)$$

and the co-ordinates  $\bar{x}$ ,  $\bar{y}$  of the C.P. are given by

$$\bar{x}R = \iint \rho x h \, dxdy, \quad \bar{y}R = \iint \rho y h \, dxdy. \quad (2)$$

The C.P. is thus the C.G. of a plane lamina bounded by the area, in which the surface density is  $\rho$ .

If  $\rho$  is uniform, the C.P. and C.G. of the area coincide.

For a homogeneous liquid at rest under gravity,  $\rho$  is proportional to the depth below the surface, i.e. to the perpendicular distance from the line of intersection of the plane of the area with the free surface of the liquid.

If the equation of this line, referred to new coordinate axes in the plane area, is written

$$x \cos \alpha + y \sin \alpha - h = 0, \quad (3)$$

$$R = \iint \rho (h - x \cos \alpha - y \sin \alpha) \, dxdy, \quad (4)$$

$$\bar{x}R = \iint \rho x (h - x \cos \alpha - y \sin \alpha) \, dxdy, \quad (5)$$

$$\bar{y}R = \iint \rho y (h - x \cos \alpha - y \sin \alpha) \, dxdy. \quad (6)$$

Placing the new origin at the C.G. of the area  $A$ ,

$$\iint x \, dxdy = 0, \quad \iint y \, dxdy = 0, \quad (7)$$

$$R = \rho h A, \quad (8)$$

$$\bar{x}hA = -\cos \alpha \iint x^2 \, dxdy - \sin \alpha \iint xy \, dxdy, \quad (9)$$

$$\bar{y}hA = -\cos \alpha \iint xy \, dxdy - \sin \alpha \iint y^2 \, dxdy. \quad (10)$$

Turning the axes to make them coincide with the principal axes of the area  $A$ , thus making  $\iint xy \, dxdy = 0$ ,

$$\bar{x}h = -a^2 \cos \alpha, \quad \bar{y}h = -b^2 \sin \alpha, \quad (10)$$

where

$$\iint x^2 \, dA = Aa^2, \quad \iint y^2 \, dA = Ab^2, \quad (11)$$

$a$  and  $b$  denoting the semi-axes of the momental ellipse of the area.

This shows that the C.P. is the antipole of the line of intersection of its plane with the free surface with respect to the momental ellipse at the C.G. of the area.

Thus the C.P. of a rectangle or parallelogram with a side in the surface is at  $\frac{1}{3}$  of the depth of the lower side; of a triangle with a vertex in the surface and base horizontal is  $\frac{1}{3}$  of the depth of the base; but if the base is in the surface, the C.P. is at half the depth of the vertex; as on the faces of a tetrahedron, with one edge in the surface.

The *core* of an area is the name given to the limited area round its C.G. within which the C.P. must lie when the area is immersed completely; the boundary of the core is therefore the locus of the antipodes with respect to the momental ellipse of water lines which touch the boundary of the area. Thus the core of a circle or ellipse is a concentric circle or ellipse of one quarter the size.

The C.P. of water lines passing through a fixed point lies on a straight line, the antipolar of the point; and thus the core of a triangle is a similar triangle of one quarter the size, and the core of a parallelogram is another parallelogram, the diagonals of which are the middle third of the median lines.

In the design of a structure such as a tall reservoir dam it is important that the line of thrust in the material should pass inside the core of a section, so that the material should not be in a state of tension anywhere and so liable to open and admit the water.

17. *Equilibrium and Stability of a Ship or Floating Body.* The *Metacentre.*—The principle of Archimedes in § 12 leads

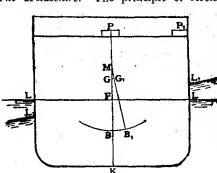

FIG. 3.

immediately to the conditions of equilibrium of a body supported freely in fluid, like a fish in water or a balloon in the air, or like a ship (fig. 3) floating partly immersed in water and the rest in air. The body is in equilibrium under two forces:—(i.) its weight  $W$  acting vertically downward

through  $G$ , the C.G. of the body, and (ii.) the buoyancy of the fluid, equal to the weight of the displaced fluid, and acting vertically upward through  $B$ , the C.G. of the displaced fluid;

for equilibrium these two forces must be equal and opposite in the same line.

The conditions of equilibrium of a body, floating like a ship on the surface of a liquid, are therefore:—

(i.) the weight of the body must be less than the weight of the total volume of liquid it can displace; or else the body will sink to the bottom of the liquid; the difference of the weights is called the "reserve of buoyancy."

(ii.) the weight of liquid which the body displaces in the position of equilibrium is equal to the weight  $W$  of the body; and

(iii.) the C.G.,  $B$ , of the liquid displaced and  $G$  of the body, must lie in the same vertical line  $GB$ .

18. In addition to satisfying these conditions of equilibrium, a ship must fulfil the further condition of stability, so as to keep upright; if displaced slightly from this position, the forces called into play must be such as to restore the ship to the upright again. The stability of a ship is investigated practically by inclining it; a weight is moved across the deck and the angle is observed of the heel produced.

Suppose  $P$  tons is moved  $c$  ft. across the deck of a ship of  $W$  tons displacement; the C.G. will move from  $G$  to  $G_1$  the reduced distance  $GG_1 = c(P/W)$ ; and if  $B$ , called the centre of buoyancy, moves to  $B_1$  along the curve of buoyancy  $BB_1$ , the normal of this curve at  $B_1$  will be the new vertical  $B_1G_1$ , meeting the old vertical in a point  $M$ , the centre of curvature of  $BB_1$ , called the *metacentre*.

If the ship heels through an angle  $\theta$  or a slope of  $T$  in  $m$ ,

$$GM = GG_1 \cot \theta = mc(P/W), \quad (1)$$

and  $GM$  is called the *metacentric height*; and the ship must be ballasted, so that  $G$  lies below  $M$ . If  $G$  was above  $M$ , the tangent drawn from  $G$  to the evolute of  $B_1$ , and normal to the curve of buoyancy, would give the vertical in a new position of equilibrium. Thus in H.M.S. "Achilles" of 9000 tons displacement it was found that moving 20 tons across the deck, a distance of 42 ft., caused the bob of a pendulum 20 ft. long to move through 10 in., so that

$$GM = \frac{240}{10} \times 42 \times \frac{20}{9000} = 2.24 \text{ ft.}; \quad (2)$$

also

$$\cot \theta = 24, \quad \theta = 2^\circ 24'. \quad (3)$$

In a diagram it is conducive to clearness to draw the ship in one position, and to incline the water-line; and the page can be turned if it is desired to bring the new water-line horizontal.

Suppose the ship turns about an axis through  $F$  in the water-line area, perpendicular to the plane of the paper; denoting by  $y$  the distance of an element  $dA$  if the water-line area from the axis of rotation, the change of displacement is  $2y dA \tan \theta$ , so that there is no change of displacement if  $2y dA = 0$ , that is, if the axis passes through the C.G. of the water-line area, which we denote by  $F$  and call the centre of flotation.

The righting couple of the wedges of immersion and emersion will be

$$2y dA \tan \theta \cdot y = w \tan \theta \int y^2 dA = w \tan \theta \cdot A k^2 \text{ ft. tons}, \quad (4)$$

$w$  denoting the density of water in tons/ft.<sup>3</sup>, and  $W = wV$ , for a displacement of  $V$  ft.<sup>3</sup>

This couple, combined with the original buoyancy  $W$  through  $B$ , is equivalent to the new buoyancy through  $\theta$ , so that

$$W \cdot BB_1 = w A k^2 \tan \theta, \quad (5)$$

$$BM = BB_1 \cot \theta = A k^2 / V, \quad (6)$$

giving the radius of curvature  $BM$  of the curve of buoyancy  $B$ , in terms of the displacement  $V$ , and  $A k^2$  the moment of inertia of the water-line area about an axis through  $F$ , perpendicular to the plane of displacement.

An inclining couple due to moving a weight about in a ship will heel the ship about an axis perpendicular to the plane of the couple, only when this axis is a principal axis at  $F$  of the momental ellipse of the water-line area  $A$ . For if the ship turns through a small angle  $\theta$  about the line  $FF'$ , then  $b_1$ ,  $b_2$ , the C.G. of the wedge of immersion and emersion, will be the C.P. with respect to  $FF'$  of the two parts of the water-line area, so that  $b_1 b_2$  will be conjugate to  $FF'$  with respect to the momental ellipse at  $F$ .

The naval architect distinguishes between the *stability of form*, represented by  $W \cdot BM$ , ballasted with  $G$  at  $B$ , the righting couple when the ship is heeled through  $\theta$  given by  $W \cdot BM \cdot \tan \theta$ ; but if weights inside the ship are raised to bring  $G$  above  $B$ , the righting couple is diminished by  $W \cdot BC \cdot \tan \theta$ , so that the resultant righting couple is  $W \cdot GM \cdot \tan \theta$ . Provided the ship is designed to float upright at the smallest draft with no load on board, the stability at any other draft of water can be arranged by the stowage of the weight, high or low.

19. Proceeding as in § 16 for the determination of the C.P. of an area, the same argument will show that an inclining couple due to

the movement of a weight  $P$  through a distance  $\epsilon$  will cause the ship to heel through an angle  $\theta$  about an axis  $FF'$  through  $F$ , which is conjugate to the direction of the movement of  $P$  with respect to an ellipse, not the momental ellipse of the water-line area  $A$ , but a confocal to it, of squared semi-axes

$$a^2 - hV/A, \quad b^2 - hV/A, \quad (1)$$

$A$  denoting the vertical height  $BG$  between C.G. and centre of buoyancy. The varying direction of the inclining couple  $Pe$  may be realized by swinging the weight  $P$  from a crane on the ship, in a circle of radius  $c$ . But if the weight  $P$  was lowered on the ship from a crane on shore, the vessel would sink bodily a distance  $P/wA$  if  $P$  was deposited over  $F$ ; but deposited anywhere else, say over  $Q$  on the water-line area, the ship would turn about a line the antipolar of  $Q$  with respect to the confocal ellipse, parallel to  $FF'$ , at a distance  $FK$  from  $F$

$$FK = (hV - h^2V/A) / PQ \sin QFF' \quad (2)$$

through an angle  $\theta$  or a slope of one in  $m$ , given by

$$\sin \theta = \frac{1}{m} = \frac{P}{wA \cdot FK} = \frac{P}{W \cdot AK^2 - hV} PQ \sin QFF', \quad (3)$$

where  $k$  denotes the radius of gyration about  $FF'$  of the water-line area. Burning the coal on a voyage has the reverse effect on a steamer.

### HYDRODYNAMICS

20. In considering the motion of a fluid we shall suppose it non-viscous, so that whatever the state of motion the stress across any section is normal, and the principle of the normality and thence of the equality of fluid pressure can be employed, as in hydrostatics. The practical problems of fluid motion, which are amenable to mathematical analysis when viscosity is taken into account, are excluded from treatment here, as constituting a separate branch called "hydroaics" (*q.v.*). Two methods are employed in hydrodynamics, called the Eulerian and Lagrangian, although both are due originally to Leonhard Euler. In the Eulerian method the attention is fixed on a particular point of space, and the change is observed there of pressure, density and velocity, which takes place during the motion; but in the Lagrangian method we follow up a particle of fluid and observe how it changes. The first may be called the statistical method, and the second the historical, according to J. C. Maxwell. The Lagrangian method being employed rarely, we shall confine ourselves to the Eulerian method.

#### The Eulerian Form of the Equations of Motion.

21. The first equation to be established is the equation of continuity, which expresses the fact that the increase of matter within a fixed surface is due to the flow of fluid across the surface into its interior.

In a straight uniform current of fluid of density  $\rho$ , flowing with velocity  $q$ , the flow in units of mass per second across a plane area  $A$ , placed in the current with the normal of the plane making an angle  $\theta$  with the velocity, is  $\rho Aq \cos \theta$ , the product of the density  $\rho$ , the area  $A$ , and  $q \cos \theta$  the component velocity normal to the plane.

Generally if  $S$  denotes any closed surface, fixed in the fluid,  $M$  the mass of the fluid inside it at any time  $t$ , and  $\theta$  the angle which the outward-drawn normal makes with the velocity  $q$  at that point,

$$dM/dt = \text{rate of increase of fluid inside the surface,} \quad (1)$$

$$= \text{flux across the surface into the interior}$$

$$= - \iint \rho q \cos \theta dS,$$

the integral equation of continuity.

In the Eulerian notation  $u, v, w$  denote the components of the velocity  $q$  parallel to the coordinate axes at any point  $(x, y, z)$  at the time  $t$ ;  $u, v, w$  are functions of  $x, y, z, t$ , the independent variables; and  $d$  is used here to denote partial differentiation with respect to any one of these four independent variables, all capable of varying one at a time.

To transfer the integral equation into the differential equation of continuity, Green's transformation is required again, namely,

$$\iiint \left( \frac{dx}{dx} + \frac{dy}{dy} + \frac{dz}{dz} \right) dx dy dz = \iint (k + m + n) dS, \quad (2)$$

or individually

$$\iiint \frac{dx}{dx} dx dy dz = \iint k dS, \dots, \quad (3)$$

where the integrations extend throughout the volume and over the surface of a closed space  $S$ ;  $l, m, n$  denoting the direction cosines of the outward-drawn normal at the surface element  $dS$ , and  $\epsilon, \eta, \zeta$  any continuous functions of  $x, y, z$ .

The integral equation of continuity (1) may now be written

$$\iiint \frac{d\rho}{dt} dx dy dz + \iint (\rho u + m\rho v + n\rho w) dS = 0, \quad (4)$$

which becomes by Green's transformation

$$\iiint \left( \frac{d\rho}{dt} + \frac{d(\rho u)}{dx} + \frac{d(\rho v)}{dy} + \frac{d(\rho w)}{dz} \right) dx dy dz = 0, \quad (5)$$

leading to the differential equation of continuity when the integration is removed.

22. The equations of motion can be established in a similar way by considering the rate of increase of momentum in a fixed direction of the fluid inside the surface, and equating it to the momentum generated by the force acting throughout the space  $S$ , and by the pressure acting over the surface  $S$ .

Taking the fixed direction parallel to the axis of  $x$ , the time-rate of increase of momentum, due to the fluid which crosses the surface, is

$$- \iint \rho u q \cos \theta dS = - \iint (\rho u^2 + m\rho uv + n\rho uw) dS, \quad (1)$$

which by Green's transformation is

$$- \iiint \rho \left( \frac{d(u^2)}{dx} + \frac{d(\rho uv)}{dy} + \frac{d(\rho uw)}{dz} \right) dx dy dz. \quad (2)$$

The rate of generation of momentum in the interior of  $S$  by the component of force,  $X$  per unit mass, is

$$\iiint \rho X dx dy dz, \quad (3)$$

and by the pressure at the surface  $S$  is

$$- \iint p dS = - \iint \rho p dx dy dz, \quad (4)$$

by Green's transformation.

The time rate of increase of momentum of the fluid inside  $S$  is

$$\iiint \rho \frac{d(u)}{dt} dx dy dz; \quad (5)$$

and (5) is the sum of (1), (2), (3), (4), so that

$$\iiint \left( \frac{d\rho u}{dt} + \frac{d(\rho u^2)}{dx} + \frac{d(\rho uv)}{dy} + \frac{d(\rho uw)}{dz} - \rho X + \frac{d(p)}{dx} \right) dx dy dz = 0, \quad (6)$$

leading to the differential equation of motion

$$\frac{d\rho u}{dt} + \frac{d(\rho u^2)}{dx} + \frac{d(\rho uv)}{dy} + \frac{d(\rho uw)}{dz} = \rho X - \frac{dp}{dx} \quad (7)$$

with two similar equations.

The absolute unit of force is employed here, and not the gravitation unit of hydrostatics; in a numerical application it is assumed that C.G.S. units are intended.

These equations may be simplified slightly, using the equation of continuity (5) § 21; for

$$\begin{aligned} \frac{d\rho u}{dt} + \frac{d(\rho u^2)}{dx} + \frac{d(\rho uv)}{dy} + \frac{d(\rho uw)}{dz} \\ = \rho \left( \frac{du}{dt} + u \frac{du}{dx} + v \frac{du}{dy} + w \frac{du}{dz} \right) \\ + u \left( \frac{d\rho}{dt} + \frac{d\rho u}{dx} + \frac{d\rho v}{dy} + \frac{d\rho w}{dz} \right), \end{aligned} \quad (8)$$

reducing to the first line, the second line vanishing in consequence of the equation of continuity; and so the equation of motion may be written in the more usual form

$$\frac{du}{dt} + u \frac{du}{dx} + v \frac{du}{dy} + w \frac{du}{dz} = X - \frac{1}{\rho} \frac{dp}{dx}, \quad (9)$$

with the two others

$$\frac{dv}{dt} + u \frac{dv}{dx} + v \frac{dv}{dy} + w \frac{dv}{dz} = Y - \frac{1}{\rho} \frac{dp}{dy}, \quad (10)$$

$$\frac{dw}{dt} + u \frac{dw}{dx} + v \frac{dw}{dy} + w \frac{dw}{dz} = Z - \frac{1}{\rho} \frac{dp}{dz}. \quad (11)$$

23. As a rule these equations are established immediately by determining the component acceleration of the fluid particle which is passing through  $(x, y, z)$  at the instant  $t$  of time considered, and saying that the reversed acceleration or kinetic reaction, combined with the impressed force per unit of mass and pressure-gradient, will according to d'Alembert's principle form a system in equilibrium.

To determine the component acceleration of a particle, suppose  $F$  to denote any function of  $x, y, z, t$ , and investigate the time rate of  $F$  for a moving particle; denoting the change by  $DF/dt$ ,

$$\begin{aligned} \frac{DF}{dt} &= \text{lt. } \frac{F(x+u\delta t, y+v\delta t, z+w\delta t, t+\delta t) - F(x, y, z, t)}{\delta t} \\ &= \frac{dF}{dt} + u \frac{dF}{dx} + v \frac{dF}{dy} + w \frac{dF}{dz}; \end{aligned} \quad (12)$$

and  $D/dt$  is called particle differentiation, because it follows the rate of change of a particle as it leaves the point  $x, y, z$ ; but

$$dF/dt, \quad dF/dx, \quad dF/dy, \quad dF/dz$$

represent the rate of change of  $F$  at the time  $t$ , at the point  $x, y, z$ , fixed in space.

The components of acceleration of a particle of fluid are consequently

$$\frac{Du}{dt} = \frac{du}{dt} + u \frac{du}{dx} + v \frac{du}{dy} + w \frac{du}{dz}, \quad (3)$$

$$\frac{Dv}{dt} = \frac{dv}{dt} + u \frac{dv}{dx} + v \frac{dv}{dy} + w \frac{dv}{dz}, \quad (4)$$

$$\frac{Dw}{dt} = \frac{dw}{dt} + u \frac{dw}{dx} + v \frac{dw}{dy} + w \frac{dw}{dz}, \quad (5)$$

leading to the equations of motion above.

If  $F(x, y, z, t) = 0$  represents the equation of a surface containing always the same particles of fluid,

$$\frac{DF}{dt} = 0, \text{ or } \frac{dF}{dt} + u \frac{dF}{dx} + v \frac{dF}{dy} + w \frac{dF}{dz} = 0, \quad (6)$$

which is called the differential equation of the *bounding surface*. A bounding surface is such that there is no flow of fluid across it, as expressed by equation (6). The surface always contains the same fluid inside it, and condition (6) is satisfied over the complete surface, as well as any part of it.

But turbulence in the motion will vitiate the principle that a bounding surface will always consist of the same fluid particles, as we see on the surface of turbulent water.

24. To integrate the equations of motion, suppose the impressed force is due to a potential  $V$ , such that the force in any direction is the rate of diminution of  $V$ , or its downward gradient; and then

$$X = -dV/dx, Y = -dV/dy, Z = -dV/dz; \quad (1)$$

and putting

$$\frac{dv}{dy} - \frac{dv}{dx} = 2\xi; \quad \frac{du}{dz} - \frac{dv}{dx} = 2\eta; \quad \frac{dv}{dy} - \frac{du}{dz} = 2\zeta, \quad (2)$$

$$\frac{d\xi}{dx} + \frac{d\eta}{dy} + \frac{d\zeta}{dz} = 0, \quad (3)$$

the equations of motion may be written

$$\frac{du}{dt} - 2v\zeta + 2w\eta + \frac{dH}{dx} = 0, \quad (4)$$

$$\frac{dv}{dt} - 2w\xi + 2u\zeta + \frac{dH}{dy} = 0, \quad (5)$$

$$\frac{dw}{dt} - 2u\eta + 2v\xi + \frac{dH}{dz} = 0, \quad (6)$$

where

$$H = \int d\rho/p + V + \frac{1}{2}q^2, \quad (7)$$

$$q^2 = u^2 + v^2 + w^2, \quad (8)$$

and the three terms in  $H$  may be called the pressure head, potential head, and head of velocity, when the gravitation unit is employed and  $\frac{1}{2}q^2$  is replaced by  $\frac{1}{2}q^2/g$ .

Eliminating  $H$  between (5) and (6)

$$\frac{D\xi}{dt} - \frac{du}{dx} + \frac{dv}{dx} - \xi \frac{dv}{dx} + \xi \left( \frac{du}{dx} + \frac{dv}{dy} + \frac{dw}{dz} \right) = 0, \quad (9)$$

and combining this with the equation of continuity

$$\frac{1}{\rho} \frac{D\rho}{dt} + \frac{du}{dx} + \frac{dv}{dy} + \frac{dw}{dz} = 0, \quad (10)$$

we have

$$\frac{D}{dt} \left( \frac{\xi}{\rho} \right) - \frac{\xi}{\rho} \frac{du}{dx} - \frac{\eta}{\rho} \frac{dv}{dx} - \xi \frac{dw}{dx} = 0, \quad (11)$$

with two similar equations.

Putting

$$\omega^2 = \xi^2 + \eta^2 + \zeta^2, \quad (12)$$

a *vortex line* is defined to be such that the tangent is in the direction of  $\omega$ , the resultant of  $\xi, \eta, \zeta$ , called the components of molecular rotation. A small sphere of the fluid, if frozen suddenly, would retain this angular velocity.

If  $\omega$  vanishes throughout the fluid at any instant, equation (11) shows that it will always be zero, and the fluid motion is then called *irrotational*; and a function  $\psi$  exists, called the *velocity function*, such that

$$u dx + v dy + w dz = -d\psi, \quad (13)$$

and then the velocity in any direction is the space-decrease or downward gradient of  $\psi$ .

25. But in the most general case it is possible to have three functions  $\phi, \psi, m$  of  $x, y, z$ , such that

$$u dx + v dy + w dz = -d\phi - m d\psi, \quad (1)$$

as A. Clebsch has shown, from purely analytical considerations (*Crelle*, lvi.); and then

$$\xi = \frac{d(\psi, m)}{d(y, z)}, \quad \eta = \frac{d(\psi, m)}{d(x, z)}, \quad \zeta = \frac{d(\psi, m)}{d(x, y)} \quad (2)$$

and

$$\xi \frac{d\psi}{dx} + \frac{d\psi}{dy} + \frac{d\psi}{dz} = 0, \quad \xi \frac{dm}{dx} + \eta \frac{dm}{dy} + \zeta \frac{dm}{dz} = 0, \quad (3)$$

so that, at any instant, the surfaces over which  $\psi$  and  $m$  are constant intersect in the vortex lines.

Putting

$$H - \frac{d\phi}{dt} - m \frac{d\psi}{dt} = K, \quad (4)$$

the equations of motion (4), (5), (6) § 24 can be written

$$\frac{dK}{dx} - 2u\xi + 2v\eta - \frac{d(\psi, m)}{d(x, t)} = 0, \dots, \dots; \quad (5)$$

and therefore

$$\xi \frac{dK}{dx} + \eta \frac{dK}{dy} + \zeta \frac{dK}{dz} = 0. \quad (6)$$

Equation (5) becomes, by a rearrangement,

$$\frac{dK}{dx} \frac{d\psi}{dx} \left( \frac{dm}{dt} + u \frac{dm}{dx} + \frac{dm}{dy} + v \frac{dm}{dz} \right) + \frac{dm}{dt} \left( \frac{d\psi}{dt} + u \frac{d\psi}{dx} + \frac{d\psi}{dy} + v \frac{d\psi}{dz} \right) = 0, \dots, \dots \quad (7)$$

$$\frac{dK}{dx} \frac{d\psi}{dx} \frac{Dm}{dt} + \frac{dm}{dt} \frac{D\psi}{dt} = 0, \dots, \dots \quad (8)$$

and as we prove subsequently (§ 37) that the vortex lines are composed of the same fluid particles throughout the motion, the surface  $m$  and  $\psi$  satisfies the condition of (6) § 23; so that  $K$  is uniform throughout the fluid at any instant, and changes with the time only, and so may be replaced by  $F(t)$ .

26. When the motion is *steady*, that is, when the velocity at any point of space does not change with the time,

$$\frac{dK}{dx} - 2v\xi + 2w\eta = 0, \dots, \dots \quad (1)$$

$$\xi \frac{dK}{dx} + \eta \frac{dK}{dy} + \zeta \frac{dK}{dz} = 0, \quad u \frac{dK}{dx} + v \frac{dK}{dy} + w \frac{dK}{dz} = 0, \quad (2)$$

and

$$K = \int d\rho/p + V + \frac{1}{2}q^2 = H \quad (3)$$

is constant along a vortex line, and a *stream line*, the path of a fluid particle, so that the fluid is traversed by a series of  $H$  surfaces, each covered by a network of stream lines and vortex lines; and if the motion is irrotational  $H$  is a constant throughout the fluid.

Taking the axis of  $x$  for an instant in the normal lines; with the point on the surface  $H = \text{constant}$ , this makes  $u = 0, \xi = 0$ ; and in steady motion the equations reduce to

$$dH/dv = 2v\xi - 2w\eta = 2q\omega \sin \theta, \quad (4)$$

where  $\theta$  is the angle between the stream line and vortex line; and this holds for their projection on any plane to which  $dv$  is drawn perpendicular.

In plane motion (4) reduces to

$$\frac{dH}{dv} = 2q\xi = q \left( \frac{dq}{dv} + \frac{q}{r} \right), \quad (5)$$

if  $r$  denotes the radius of curvature of the stream line, so that

$$\frac{1}{\rho} \frac{dp}{dv} + \frac{dv}{dv} = \frac{dH}{dv} - \frac{d\frac{1}{2}q^2}{dv} = \frac{q^2}{r}, \quad (6)$$

the normal acceleration.

The osculating plane of a stream line in steady motion contains the resultant acceleration, the direction ratios of which are

$$u \frac{du}{dx} + v \frac{dv}{dy} + w \frac{dw}{dz} = \frac{d\frac{1}{2}q^2}{dx} - 2v\xi + 2w\eta = \frac{d\frac{1}{2}q^2}{dx} \frac{dH}{dx}, \dots, \dots \quad (7)$$

and when  $q$  is stationary, the acceleration is normal to the surface  $H = \text{constant}$ , and the stream line is a geodesic.

Calling the sum of the pressure and potential head the static head, surfaces of constant static and dynamical head intersect in lines on  $H$ , and the three surfaces touch where the velocity is stationary.

Equation (3) is called Bernoulli's equation, and may be interpreted as the balance-sheet of the energy which enters and leaves a given tube of flow.

If homogeneous liquid is drawn off from a vessel so large that the motion at the free surface at a distance may be neglected, then Bernoulli's equation may be written

$$H = p/\rho + z + q^2/2g = P/\rho + h, \quad (8)$$

where  $P$  denotes the atmospheric pressure and  $h$  the height of the free surface, a fundamental equation in hydraulics; a return has been made here to the gravitation unit of hydrostatics, and  $Oz$  is taken vertically upward.

In particular, for a jet issuing into the atmosphere, where  $p = P$ ,

$$q^2/2g = h - z, \quad (9)$$

or the velocity of the jet is due to the head  $h - z$  of the still free surface above the orifice; this is Torricelli's theorem (1643), the foundation of the science of hydrodynamics.

27. *Uniplanar Motion*.—In the uniplanar motion of a homogeneous liquid the equation of continuity reduces to

$$\frac{du}{dx} + \frac{dv}{dy} = 0, \quad (1)$$

so that we can put

$$u = -d\psi/dy, \quad v = d\psi/dx, \quad (2)$$

where  $\psi$  is a function of  $x, y$ , called the stream- or current-function; interpreted physically,  $\psi - \psi_0$ , the difference of the value of  $\psi$  at a fixed point A and a variable point P is the flow, in ft.<sup>3</sup>/second, across any curved line AP from A to P, this being the same for all lines in accordance with the continuity.

Thus if  $d\psi$  is the increase of  $\psi$  due to a displacement from P to P', and  $k$  is the component of velocity normal to PP', the flow across PP' is  $d\psi = k \cdot PP'$ ; and taking PP' parallel to Ox,  $d\psi = v dx$ ; and similarly  $d\psi = -u dy$  with PP' parallel to Oy; and generally  $d\psi/ds$  is the velocity across  $ds$ , in a direction turned through a right angle forward, against the clock.

In the equations of uniplanar motion

$$2\zeta = \frac{dv}{dx} \frac{du}{dy} = \frac{d^2\psi}{dx^2} \frac{d^2\psi}{dy^2} = -v^2\psi, \text{ suppose,} \quad (3)$$

so that in steady motion

$$\frac{dH}{dx} + v^2\psi = 0, \quad \frac{dH}{dy} + u^2\psi = 0, \quad \frac{dH}{dt} + v^2\psi = 0, \quad (4)$$

and  $v^2\psi$  must be a function of  $\psi$ .

If the motion is irrotational,

$$u = -\frac{d\phi}{dx} = -\frac{d\psi}{dy}, \quad v = \frac{d\phi}{dy} = \frac{d\psi}{dx} \quad (5)$$

so that  $\psi$  and  $\phi$  are conjugate functions of  $x$  and  $y$ ,

$$\phi + \psi i = f(x + yi), \quad v^2\psi = 0, \quad v^2\phi = 0; \quad (6)$$

or putting

$$\phi + \psi i = w, \quad x + yi = z, \quad w = f(z).$$

The curves  $\psi = \text{constant}$  and  $\phi = \text{constant}$  form an orthogonal system; and the interchange of  $\phi$  and  $\psi$  will give a new state of uniplanar motion, in which the velocity at every point is turned through a right angle without alteration of magnitude.

For instance, in a uniplanar flow, radially inward towards O, the flow across any circle of radius  $r$  being the same and denoted by  $2\pi m$ , the velocity must be  $m/r$ , and

$$\phi = m \log r, \quad \psi = m\theta, \quad \phi + \psi i = m \log re^{i\theta}, \quad w = m \log z. \quad (7)$$

Interchanging these values

$$\psi = m \log r, \quad \phi = m\theta, \quad \phi + \psi i = m \log re^{i\theta} \quad (8)$$

gives a state of vortex motion, circulating round Oz, called a straight or columnar vortex.

A single vortex will remain at rest, and cause a velocity at any point inversely as the distance from the axis and perpendicular to its direction; analogous to the magnetic field of a straight electric current.

If other vortices are present, any one may be supposed to move with the velocity due to the others, the resultant stream function being

$$\psi = 2\pi m \log r = \log \Pi m r; \quad (9)$$

the path of a vortex is obtained by equating the value of  $\psi$  at the vortex to a constant, omitting the  $m$  of the vortex itself.

When the liquid is bounded by a cylindrical surface, the motion of a vortex inside may be determined as due to a series of vortex-images, so arranged as to make the flow zero across the boundary. For a plane boundary the image is the optical reflection of the vortex. For example, a pair of equal opposite vortices, moving on a line parallel to a plane boundary, will have a corresponding pair of images, forming a rectangle of vortices, and the path of a vortex will be the Cotes' spiral

$$r \sin 2\theta = 2a, \quad \text{or } x^2 + y^2 = a^2; \quad (10)$$

this is therefore the path of a single vortex in a right-angled corner; and generally, if the angle of the corner is  $\pi/n$ , the path is the Cotes' spiral

$$r \sin n\theta = na. \quad (11)$$

A single vortex in a circular cylinder of radius  $a$  at a distance  $c$  from the centre will move with the velocity  $d$  to an equal opposite image at a distance  $a^2/c$ , and so describe a circle with velocity

$$mc/(a^2 - c^2) \text{ in the periodic time } 2\pi(a^2 - c^2)/m. \quad (12)$$

Conjugate functions can be employed also for the motion of liquid in a thin sheet between two concentric spherical surfaces; the components of velocity along the meridian and parallel in colatitude  $\theta$  and longitude  $\lambda$  can be written

$$\frac{d\phi}{d\theta} = \frac{1}{\sin \theta} \frac{d\psi}{d\lambda}, \quad \frac{1}{\sin \theta} \frac{d\phi}{d\lambda} = -\frac{d\psi}{d\theta} \quad (13)$$

and then

$$\phi + \psi i = F(\tan \frac{1}{2}\theta, e^{i\lambda}). \quad (14)$$

28. *Uniplanar Motion of a Liquid due to the Passage of a Cylinder through it.*—A stream-function  $\psi$  must be determined to satisfy the conditions

$$v^2\psi = 0, \text{ throughout the liquid;} \quad (1)$$

$$\psi = \text{constant, over any fixed boundary;} \quad (2)$$

$$d\psi/ds = \text{normal velocity reversed over a solid boundary,} \quad (3)$$

so that, if the solid is moving with velocity  $U$  in the direction Ox,  $d\psi/ds = -U dy/ds$ , or  $\psi + Uy = \text{constant}$  over the moving cylinder;

and  $\psi + Uy = \psi'$  is the stream function of the relative motion of the liquid past the cylinder, and similarly  $\psi - Vx$  for the component velocity  $V$  along Oy; and generally

$$\psi' = \psi + Uy - Vx \quad (4)$$

is the relative stream-function, constant over a solid boundary moving with components  $U$  and  $V$  of velocity.

If the liquid is stirred up by the rotation  $R$  of a cylindrical body,

$$d\psi/ds = \text{normal velocity reversed}$$

$$= -R\alpha \frac{dx}{ds} - R\beta \frac{dy}{ds} \quad (5)$$

$$\psi + \frac{1}{2}R(x^2 + y^2) = \psi', \quad (6)$$

a constant over the boundary; and  $\psi - Vx$  is the current-function of the relative motion past the cylinder, but now

$$V\psi' + 2R = 0, \quad (7)$$

throughout the liquid.

Inside an equilateral triangle, for instance, of height  $h$ ,

$$\psi' = -2R\alpha\beta\gamma/h, \quad (8)$$

where  $\alpha, \beta, \gamma$  are the perpendiculars on the sides of the triangle.

In the general case  $\psi' = \psi + Uy - Vx + R(x^2 + y^2)$  is the relative stream function for velocity components  $U, V, R$ .

29. *Example 1.*—Liquid motion past a circular cylinder.

Consider the motion given by

$$w = U(x + ia^2/z), \quad (1)$$

so that

$$\phi = U \left( x + \frac{a^2}{r} \right) \cos \theta = U \left( 1 + \frac{a^2}{r^2} \right) x, \quad (2)$$

$$\psi = U \left( r - \frac{a^2}{r} \right) \sin \theta = U \left( 1 - \frac{a^2}{r^2} \right) y. \quad (3)$$

Then  $\psi = 0$  over the cylinder  $r = a$ , which may be considered a fixed post; and a stream line past it along which  $\psi = Uc$ , a constant, is the curve

$$\left( r - \frac{a^2}{r} \right) \sin \theta = c, \quad (x^2 + y^2)(y - c) - a^2y = 0, \quad (3)$$

a cubic curve ( $C_3$ ).

Over a concentric cylinder, external or internal, of radius  $r = b$ ,

$$\psi' = \psi + Uy = U \left[ \left( 1 - \frac{a^2}{b^2} \right) + Uy \right], \quad (4)$$

and  $\psi'$  is zero if

$$U_1/U = (a^2 - b^2)/b^2; \quad (5)$$

so that the cylinder may swim for an instant in the liquid without distortion, with this velocity  $U_1$ ; and  $w$  in (1) will give the liquid motion in the interspace between the fixed cylinder  $r = a$  and the concentric cylinder  $r = b$ , moving with velocity  $U_1$ .

When  $b = 0$ ,  $U_1 = \infty$ ; and when  $b = \infty$ ,  $U_1 = -U$ , so that at infinity the liquid is streaming in the direction  $xO$  with velocity  $U$ .

If the liquid is reduced to rest at infinity by the superposition of an opposite stream given by  $w = -Uz$ , we are left with

$$w = Ua^2/z, \quad (6)$$

$$\phi = U(a^2/r) \cos \theta = Ua^2x/(x^2 + y^2), \quad (7)$$

$$\psi = -U(a^2/r) \sin \theta = -Ua^2y/(x^2 + y^2), \quad (8)$$

giving the motion due to the passage of the cylinder  $r = a$  with velocity  $U$  through the origin  $O$  in the direction  $xO$ .

If the direction of motion makes an angle  $\theta'$  with  $Ox$ ,

$$\tan \theta' = \frac{d\phi/d\theta}{d\psi/d\theta} = \frac{2xy}{x^2 - y^2} = \tan 2\theta, \quad \theta = \frac{1}{2}\theta', \quad (9)$$

and the velocity is  $Ua^2/r^2$ .

Along the path of a particle, defined by the  $C_3$  of (3),

$$\sin^2 \frac{1}{2}\theta' = \frac{y^2}{x^2 + y^2} = \frac{y(y-c)}{a^2}, \quad (10)$$

$$\frac{1}{2} \sin \theta' \frac{d\theta'}{ds} = \frac{2y-c}{a^2} \frac{dy}{ds}, \quad (11)$$

on the radius of curvature is  $\frac{1}{2}(y-c)/a^2$ , which shows that the curve is an *Elastica* or *Lintearia. (J. C. Maxwell, *Collected Works*, ii, 208.)*

If  $\phi_1$  denotes the velocity function of the liquid filling the cylinder  $r = b$ , and moving bodily with it with velocity  $U_1$ ,

$$\phi_1 = -U_1x, \quad (12)$$

and over the separating surface  $r = b$

$$\frac{\phi}{\phi_1} = -U \left( 1 + \frac{a^2}{b^2} \right) = \frac{a^2 - b^2}{a^2} \quad (13)$$

and this, by § 36, is also the ratio of the kinetic energy in the annular interspace between the two cylinders to the kinetic energy of the liquid moving bodily inside  $r = b$ .

Consequently the inertia to overcome in moving the cylinder  $r = b$ , solid or liquid, is its own inertia, increased by the inertia of liquid  $(a^2 + b^2)/(a^2 - b^2)$  times the volume of the cylinder  $r = b$ ; this total inertia is called the effective inertia of the cylinder  $r = b$ , at the instant the two cylinders are concentric.

With liquid of density  $\rho$ , this gives rise to a kinetic reaction to acceleration  $dU/dt$ , given by

$$\rho \pi b^2 \frac{a^2 + b^2}{a^2 - b^2} \frac{dU}{dt} = \frac{a^2 + b^2}{a^2 - b^2} M' \frac{dU}{dt}, \quad (14)$$

if  $M'$  denotes the mass of liquid displaced by unit length of the cylinder  $r = b$ . In particular, when  $a = \infty$ , the extra inertia is  $M'$ .

When the cylinder  $r = a$  is moved with velocity  $U$  and  $r = b$  with velocity  $U_1$  along  $Ox$ ,

$$\phi = U \frac{a^2}{b^2 - a^2} \left( \frac{b^2}{r} + r \right) \cos \theta - U_1 \frac{b^2}{b^2 - a^2} \left( r + \frac{a^2}{r} \right) \cos \theta, \quad (15)$$

$$\psi = -U \frac{a^2}{b^2 - a^2} \left( \frac{b^2}{r} - r \right) \sin \theta - U_1 \frac{b^2}{b^2 - a^2} \left( r - \frac{a^2}{r} \right) \sin \theta; \quad (16)$$

and similarly, with velocity components  $V$  and  $V_1$  along  $Oy$

$$\phi = V \frac{a^2}{b^2 - a^2} \left( \frac{b^2}{r} + r \right) \sin \theta - V_1 \frac{b^2}{b^2 - a^2} \left( r + \frac{a^2}{r} \right) \sin \theta, \quad (17)$$

$$\psi = V \frac{a^2}{b^2 - a^2} \left( \frac{b^2}{r} - r \right) \cos \theta + V_1 \frac{b^2}{b^2 - a^2} \left( r - \frac{a^2}{r} \right) \cos \theta; \quad (18)$$

and then for the resultant motion

$$w = (U^2 + V^2) \frac{a^2}{b^2 - a^2} \frac{U + V_1}{U + V_1} + \frac{a^2 b^2}{b^2 - a^2} \frac{U + V_1}{z} - (U^2 + V^2) \frac{b^2}{b^2 - a^2} \frac{U_1 + V_1}{U_1 + V_1} - \frac{a^2 b^2}{b^2 - a^2} \frac{U_1 + V_1}{z}. \quad (19)$$

The resultant impulse of the liquid on the cylinder is given by the component, over  $r = a$  (§ 36),

$$X = \int \rho \phi \cos \theta, \quad d\theta = \rho \pi a^2 \left( U \frac{b^2 + a^2}{b^2 - a^2} + U_1 \frac{2b^2}{b^2 - a^2} \right); \quad (20)$$

and over  $r = b$

$$X_1 = \int \rho \phi \cos \theta, \quad d\theta = \rho \pi b^2 \left( U \frac{2a^2}{b^2 - a^2} + U_1 \frac{b^2 + a^2}{b^2 - a^2} \right), \quad (21)$$

and the difference  $X - X_1$  is the component momentum of the liquid in the interspace;  $Y$  and  $Y_1$  with similar expressions for  $Y$  and  $Y_1$ .

Then, if the outside cylinder is free to move

$$X_1 = 0, \quad \frac{V_1}{U} = \frac{2a^2}{b^2 + a^2}, \quad X = \rho \pi a^2 U \frac{b^2 + a^2}{b^2 - a^2}, \quad (22)$$

But if the outside cylinder is moved with velocity  $U_1$  and the inside cylinder is solid or filled with liquid of density  $\sigma$ ,

$$X = -\pi \sigma a^2 U, \quad \frac{U_1}{U} = \frac{2\rho b^2}{\rho(b^2 + a^2) + \sigma(b^2 - a^2)}, \quad (23)$$

$$\frac{U - U_1}{U_1} = \frac{(\rho - \sigma)(b^2 - a^2)}{\rho(b^2 + a^2) + \sigma(b^2 - a^2)},$$

and the inside cylinder starts forward or backward with respect to the outside cylinder, according as  $\rho >$  or  $<$   $\sigma$ .

30. The expression for  $w$  in (1) § 29 may be increased by the addition of the term

$$im \log z = -m\theta + im \log r, \quad (1)$$

representing vortex motion circulating round the annulus of liquid.

Considered by itself, with the cylinders held fixed, the vortex sets up a circumferential velocity  $m/r$  on a radius  $r$ , so that the angular momentum of a circular filament of annular cross section  $\Delta A$  is  $\rho m \Delta A$ , and of the whole vortex is  $\rho m \pi r^2 (b^2 - a^2)$ .

Any circular filament can be started from rest by the application of a circumferential impulse  $\rho m r dA$  at each end of a diameter; so that a mechanism attached to the cylinders, which can set up a uniform distributed impulse  $\rho m \pi r$  across the two parts of a diameter in the liquid, will generate the vortex motion, and react on the cylinder with an impulse couple  $-\rho m \pi a^2$  and  $\rho m \pi b^2$ , having resultant  $\rho m \pi r (b^2 - a^2)$ , and this couple is infinite when  $b = \infty$ , as the angular momentum of the vortex is infinite. Round the cylinder  $r = a$  held fixed in the  $U$  current the liquid streams past with velocity

$$q' = 2U \sin \theta + m/a; \quad (2)$$

and the loss of head due to this increase of velocity from  $U$  to  $q'$  is

$$\frac{q'^2 - U^2}{2g} = \frac{(2U \sin \theta + m/a)^2 - U^2}{2g}, \quad (3)$$

so that cavitation will take place, unless the head at a great distance exceeds this loss.

The resultant hydrostatic thrust across any diametral plane of the cylinder will be modified, but the only term in the loss of head which exerts a resultant thrust on the whole cylinder is  $2mU \sin \theta/g$ , and its thrust is  $2\rho \pi m U$  absolute units in the direction  $Oy$ , to be counteracted by a support at the centre  $C$ ; the liquid is streaming past  $r = a$  with velocity  $U$  reversed, and the cylinder is surrounded by a vortex. Similarly, the streaming velocity  $V$  reversed will give rise to a thrust  $2\rho \pi m V$  in the direction  $Ox$ .

Now if the cylinder is released, and the components  $U$  and  $V$  are reversed so as to become the velocity of the cylinder with respect

to space filled with liquid, and at rest at infinity, the cylinder will experience components of force per unit length

(i.)  $-2\rho \pi m V$ ,  $2\rho \pi m U$ , due to the vortex motion:

(ii.)  $-\pi \rho a^2 \frac{dU}{dt}$ ,  $-\pi \rho a^2 \frac{dV}{dt}$ , due to the kinetic energy of the liquid;

(iii.) 0,  $-\pi(\sigma - \rho)a^2 g$ , due to gravity,

taking  $Oy$  vertically upward, and denoting the density of the cylinder by  $\sigma$ ; so that the equations of motion are

$$\sigma \pi a^2 \frac{dU}{dt} = -\pi \rho a^2 \frac{dU}{dt} - 2\rho \pi m V, \quad (4)$$

$$\pi \rho a^2 \frac{dV}{dt} = -\pi \rho a^2 \frac{dV}{dt} + 2\rho \pi m U - \pi(\sigma - \rho)a^2 g, \quad (5)$$

or, putting  $m = a^2 \omega$ , so that the vortex velocity is due to an angular velocity  $\omega$  at a radius  $a$ ,

$$(\sigma + \rho) dU/dt + 2\rho a \omega = 0, \quad (6)$$

$$(\sigma + \rho) dV/dt - 2\rho a \omega + (\sigma - \rho)g = 0. \quad (7)$$

Thus with  $g = 0$ , the cylinder will describe a circle with angular velocity  $2\rho a \omega / (\sigma + \rho)$ , so that the radius is  $(\sigma + \rho) \nu / 2\rho a$ , if the velocity is  $\nu$ . With  $\sigma = 0$ , the angular velocity of the cylinder is  $2\omega$ ; in this way the velocity may be calculated of the propagation of ripples and waves on the surface of a vertical whirlpool in a sink.

Restoring  $\sigma$  will make the path of the cylinder a trochoid; and so the swerve can be explained of the ball in tennis, cricket, baseball, or golf.

Another explanation may be given of the sideling force, arising from the velocity of liquid past a cylinder, which is encircled by a vortex. Taking two planes  $x = \pm b$ , and considering the increase of momentum in the liquid between them, due to the entry and exit of liquid momentum, the increase across  $dy$  in the direction  $Oy$ , due to elements at  $P$  and  $P'$  at opposite ends of the diameter  $PP'$ , is

$$\rho dy \left( U - U a^2 r^2 \cos^2 \theta + m r^{-1} \sin \theta \right) (U a^2 r^2 \sin^2 \theta + m r^{-1} \cos \theta) + \rho dy \left( -U + U a^2 r^2 \cos^2 \theta + m r^{-1} \sin \theta \right) (U a^2 r^2 \sin^2 \theta - m r^{-1} \cos \theta) = 2\rho dy m U r^{-1} (\cos \theta - a^2 r^2 \cos^3 \theta), \quad (8)$$

and with  $y = b \tan \theta$ ,  $r = b \sec \theta$ , this is

$$2\rho m U b d\theta (\sin^2 \theta - a^2 b^2 \cos^3 \theta \cos \theta), \quad (9)$$

and integrating between the limits  $\theta = \pm \frac{1}{2}\pi$ , the resultant, as before, is  $2\rho m U$ .

31. Example 2.—Confoal Elliptic Cylinders.—Employ the elliptic coordinates  $\eta, \xi$ , and  $\xi = \eta + \xi$ , such that

$$z = c \operatorname{ch} \xi, \quad x = c \operatorname{ch} \eta \cos \xi, \quad y = c \operatorname{sh} \eta \sin \xi; \quad (1)$$

then the curves for which  $\eta$  and  $\xi$  are constant are confocal ellipses and hyperbolas, and

$$J = \frac{d(x, y)}{d(\eta, \xi)} = c^2 (\operatorname{ch}^2 \eta - \cos^2 \xi) = \frac{1}{2} c^2 (\operatorname{ch} 2\eta - \cos 2\xi) = r_1 r_2 = OD^2, \quad (2)$$

if  $OD$  is the semi-diameter conjugate to  $OP$ , and  $r_1, r_2$  the focal distances,

$$r_1 r_2 = c (\operatorname{ch} \eta \operatorname{sh} \cos \xi); \quad (3)$$

$$r^2 = a^2 + y^2 = c^2 (\operatorname{ch}^2 \eta - \sin^2 \xi) = \frac{1}{2} c^2 (\operatorname{ch} 2\eta + \cos 2\xi). \quad (4)$$

Consider the streaming motion given by

$$w = m \operatorname{ch} (\xi - \gamma), \quad \gamma = a + b\eta, \quad (5)$$

$$\phi = m \operatorname{ch} (\eta - a) \cos (\xi - \gamma), \quad \psi = m \operatorname{sh} (\eta - a) \sin (\xi - \beta). \quad (6)$$

Then  $\psi = 0$  over the ellipse  $\eta = a$ , and the hyperbola  $\xi = \beta$ , so that these may be taken as fixed boundaries; and  $\psi$  is a constant on a  $C$ .

Over any ellipse  $\eta$ , moving with components  $U$  and  $V$  of velocity,

$$\psi' = \psi + U y - V x = [m \operatorname{sh} (\eta - a) \cos \beta + U \operatorname{ch} \eta \sin \xi - [m \operatorname{sh} (\eta - a) \sin \beta + V \operatorname{ch} \eta \cos \xi]; \quad (7)$$

so that  $\psi' = 0$ , if

$$U = \frac{m \operatorname{sh} (\eta - a)}{c \operatorname{sh} \eta} \cos \beta, \quad V = -\frac{m \operatorname{sh} (\eta - a)}{c \operatorname{ch} \eta} \sin \beta, \quad (8)$$

having a resultant in the direction  $PO$ , where  $P$  is the intersection of an ellipse  $\eta$  with the hyperbola  $\beta$ ; and with this velocity the ellipse  $\eta$  can be swimming in the liquid, without distortion for an instant.

At infinity

$$U = -\frac{m}{c} \sigma^{-2} \cos \beta = -\frac{m}{a+b} \cos \beta, \quad (9)$$

$$V = -\frac{m}{c} \sigma^{-2} \sin \beta = -\frac{m}{a+b} \sin \beta, \quad (9)$$

$a$  and  $b$  denoting the semi-axes of the ellipse  $a$ ; so that the liquid is streaming at infinity with velocity  $Q = m/(a+b)$  in the direction of the asymptote of the hyperbola  $\beta$ .

An ellipse interior to  $\eta = a$  will move in a direction opposite to the exterior current; and when  $\eta = U, \sigma = 0$ , but  $V = (m/c) \operatorname{sh} a \sin \beta$ .

Negative values of  $\eta$  must be interpreted by a streaming motion on a parallel plane at a level slightly different, as on a double Riemann sheet, the stream passing from one sheet to the other across a cut  $SS'$  between the foci  $S, S'$ . A diagram has been drawn by Col. R. L. Hippisley.

The components of the liquid velocity  $q$ , in the direction of the normal of the ellipse  $\eta$  and hyperbola  $\xi$ , are

$$-mJ^{-1}sh(\eta-a)\cos(\xi-b), mJ^{-1}ch(\eta-a)\sin(\xi-b). \quad (10)$$

The velocity  $q$  is zero in a corner where the hyperbola  $\beta$  cuts the ellipse  $\alpha$ ; and round the ellipse  $\alpha$  the velocity  $q$  reaches a maximum when the tangent has turned through a right angle, and then

$$q = Qae \sqrt{\frac{ch(2a-\cos 2\beta)}{sh 2a}}; \quad (11)$$

and the condition can be inferred when cavitation begins.

With  $\beta = 0$ , the stream is parallel to  $x_0$ , and

$$\phi = m ch(\eta-a)\cos \xi \\ = -Uc ch(\eta-a)sh \eta \cos \xi / sh(\eta-a) \quad (12)$$

over the cylinder  $\eta$ , and as in (12) § 29,

$$\phi_1 = -Ux = -Uc ch \eta \cos \xi, \quad (13)$$

for liquid filling the cylinder; and

$$\frac{\phi}{\phi_1} = \frac{th \eta}{th(\eta-a)} \quad (14)$$

over the surface of  $\eta$ ; so that parallel to  $Ox$ , the effective inertia of the cylinder  $\eta$  displacing  $M'$  liquid, is increased by  $M'th \eta / th(\eta-a)$ , reducing when  $a \rightarrow 0$  to  $M'th \eta = M'(b/a)$ .

Similarly, parallel to  $Oy$ , the increase of effective inertia is  $M'th \eta / th(\eta-a)$ , reducing to  $M'th \eta = M'(a/b)$ , when  $a \rightarrow \infty$ , and the liquid extends to infinity.

32. Next consider the motion given by

$$\phi = m ch 2(\eta-a)\sin 2\xi, \psi = -m sh 2(\eta-a)\cos 2\xi; \quad (1)$$

in which  $\psi = 0$  over the ellipse  $\alpha$ , and

$$\psi' = \psi + \frac{1}{2}R(x^2 + y^2) \\ = (-m sh 2(\eta-a) + \frac{1}{2}Rc^2) \cos 2\xi + \frac{1}{2}Rc^2 ch 2\eta, \quad (2)$$

which is constant over the ellipse  $\eta$  if

$$\frac{1}{2}Rc^2 = m sh 2(\eta-a);$$

so that this ellipse can be rotating with this angular velocity  $R$  for an instant without distortion, the ellipse  $\alpha$  being fixed.

For the liquid filling the interior of a rotating elliptic cylinder of cross section

$$x^2/a^2 + y^2/b^2 = 1, \quad (4)$$

with

$$\nabla^2 \psi_1 = -2R = -2m_1(1/a^2 + 1/b^2), \\ \psi_1 = m_1(x^2/a^2 + y^2/b^2) - \frac{1}{2}R(x^2 + y^2) \\ = -\frac{1}{2}R(x^2 - a^2)(a^2 - b^2)/(a^2 + b^2), \quad (6) \\ \phi_1 = Rxy(a^2 - b^2)/(a^2 + b^2), \\ w_1 = \phi_1 + \psi_1 i = -\frac{1}{2}iR(x + iy)^2(a^2 - b^2)/(a^2 + b^2).$$

The velocity of a liquid particle is thus  $(a^2 - b^2)/(a^2 + b^2)$  at  $(a^2 + b^2)$  it would be if the liquid was frozen and rotating bodily with  $R$ ; and so the effective angular inertia of the liquid is  $(a^2 - b^2)^2/(a^2 + b^2)^2$  of the solid; and the effective radius of gyration, solid and liquid, is given by

$$k^2 = \frac{1}{2}(a^2 + b^2), \text{ and } \frac{1}{2}(a^2 - b^2)^2/(a^2 + b^2). \quad (7)$$

For the liquid in the interspace between  $\alpha$  and  $\eta$ ,

$$\frac{\phi}{\phi_1} = \frac{m ch 2(\eta-a)\sin 2\xi}{\frac{1}{2}Rc^2 sh 2\eta \sin 2\xi(a^2 - b^2)/(a^2 + b^2)} \\ = 1/2 th 2(\eta-a) th 2\xi; \quad (8)$$

and the effective  $k^2$  of the liquid is reduced to

$$\frac{1}{2}c^2/th 2(\eta-a) sh 2\eta, \quad (9)$$

which becomes  $\frac{1}{2}c^2/sh 2\eta = \frac{1}{2}(a^2 - b^2)/ab$ , when  $a \rightarrow \infty$ , and the liquid surrounds the ellipse  $\eta$  to infinity.

An angular velocity  $R$ , which gives components  $-Ry$ ,  $Rx$  of velocity to a body, can be resolved into two shearing velocities,  $-R$  parallel to  $Ox$ , and  $R$  parallel to  $Oy$ ; and then  $\psi$  is resolved into  $\psi_1 + \psi_2$ , such that  $\psi_1 + \frac{1}{2}R^2x^2$  and  $\psi_2 + \frac{1}{2}R^2y^2$  is constant over the boundary.

Inside a cylinder

$$\phi_1 + \psi_1 i = -\frac{1}{2}iR(x + iy)^2(a^2 + b^2), \quad (10)$$

$$\phi_2 + \psi_2 i = \frac{1}{2}iR(x + iy)^2(b^2 + a^2), \quad (11)$$

and for the interspace, the ellipse  $\alpha$  being fixed, and  $a_1$  revolving with angular velocity  $R$

$$\phi_1 + \psi_1 i = -\frac{1}{2}iR^2 sh 2(\eta - a + \xi) (ch 2a + 1) / sh 2(a_1 - a), \quad (12)$$

$$\phi_2 + \psi_2 i = \frac{1}{2}iR^2 sh 2(\eta - a + \xi) (ch 2a - 1) / sh 2(a_1 - a), \quad (13)$$

satisfying the condition that  $\phi_1$  and  $\psi_2$  are zero over  $\eta = a$ , and  $\eta = a_1$ .

$$\psi_1 + \frac{1}{2}R^2x^2 = \frac{1}{2}R^2c^2(ch 2a + 1), \quad (14)$$

$$\psi_2 + \frac{1}{2}R^2y^2 = \frac{1}{2}R^2c^2(ch 2a - 1), \quad (15)$$

constant values.

In a similar way the more general state of motion may be analysed, given by

$$w = m ch 2(\xi - \gamma), \gamma = a + \beta i, \quad (16)$$

as giving a homogeneous strain velocity to the confocal system; to which may be added a circulation, represented by an additional term  $m_1 i$  in  $w$ .

Similarly, with

$$x + yi = c\sqrt{[\sin(\xi + \eta i)]} \quad (17)$$

the function

$$\psi = Qc sh \frac{1}{2}(\eta - a) \sin \frac{1}{2}(\xi - b) \quad (18)$$

will give motion streaming past the fixed cylinder  $\eta = a$ , and dividing along  $\xi = b$ ; and then

$$x^2 - y^2 = c^2 \sin^2 \xi \operatorname{ch} \eta, \quad 2xy = c^2 \cos^2 \xi \operatorname{sh} \eta. \quad (19)$$

In particular, with  $sh a = 1$ , the cross-section of  $\eta = a$  is

$$x^4 + 6x^2y^2 + y^4 = 2c^4, \text{ or } x^4 + y^4 = c^4 \quad (20)$$

when the axes are turned through  $45^\circ$ .

33. Example 3.—Analysing in this way the rotation of a rectangle filled with liquid into the two components of shear, the stream function  $\psi_1$  is to be made to satisfy the conditions

- (i.)  $\nabla^2 \psi_1 = 0$ ,
- (ii.)  $\psi_1 + \frac{1}{2}R^2x^2 = \frac{1}{2}Ra^2$ , or  $\psi_1 = 0$  when  $x = a$ ,
- (iii.)  $\psi_1 + \frac{1}{2}R^2x^2 = \frac{1}{2}Ra^2$ ,  $\psi_1 = \frac{1}{2}R(a^2 - x^2)$ , when  $y = b$

Expanded in a Fourier series,

$$a^2 - x^2 = \frac{32}{\pi^2} a^2 \sum \frac{\cos(2n+1)\frac{1}{2}\pi x/a}{(2n+1)^2}, \quad (1)$$

so that

$$\psi_1 = R \frac{16}{\pi^2} a^2 \sum \frac{\cos(2n+1)\frac{1}{2}\pi x/a \cdot ch(2n+1)\frac{1}{2}\pi y/a}{(2n+1)^4 \cdot ch(2n+1)\frac{1}{2}\pi b/a}, \\ w_1 = \phi_1 + \psi_1 i = iR \frac{16}{\pi^2} a^2 \sum \frac{\cos(2n+1)\frac{1}{2}\pi x/a}{(2n+1)^4 ch(2n+1)\frac{1}{2}\pi b/a}. \quad (2)$$

an elliptic-function Fourier series; with a similar expansion for  $\psi_2$  with  $x$  and  $y$ ,  $a$  and  $b$  interchanged; and thence  $\psi = \psi_1 + \psi_2$ .

Example 4.—Parabolic cylinder, axial advance, and liquid streaming past.

The polar equation of the cross-section being

$$r \cos \frac{1}{2}\theta = a, \text{ or } r + x = 2a, \quad (3)$$

the conditions are satisfied by

$$\psi' = Ur \sin \theta - 2Ua^2 r \sin \frac{1}{2}\theta = 2Ur \sin \frac{1}{2}\theta (r \cos \frac{1}{2}\theta - a), \quad (4)$$

$$\psi = 2Ua^2 r \sin \frac{1}{2}\theta = -U\sqrt{2a(r-x)}, \quad (5)$$

$$w = -2Ua^2 i, \quad (6)$$

and the resistance of the liquid is  $2\pi a^2 \rho \sqrt{2}g$ .

A relative stream line, along which  $\psi = Uc$ , is the quartic curve

$$y - c = \sqrt{2a(r-x)}, \quad x = \frac{4a^2 r^2 - (y-c)^4}{4a(y-c)^2}, \quad r = \frac{4a^2 r^2 + (y-c)^4}{4a(y-c)^2},$$

and in the absolute space curve given by  $\psi$ ,

$$\frac{dy}{dx} = -\frac{(y-c)^2}{2ay}, \quad x = \frac{2ac}{y-c} - 2a \log(y-c). \quad (8)$$

34. Motion symmetrical about an Axis.—When the motion of a liquid is the same for any plane passing through  $Ox$ , and lies in the plane, a function  $\psi$  can be found analogous to that employed in plane motion, such that the flux across the surface generated by the revolution of any curve  $AP$  from  $A$  to  $P$  is the same, and represented by  $2\pi(\psi - \psi_0)$ ; and, as before, if  $d\psi$  is the increase in  $\psi$  due to a displacement of  $P$  to  $P'$ , then  $k$  the component of velocity normal to the surface swept out by  $PP'$  is such that  $2\pi d\psi = 2\pi y k PP'$ ; and taking  $PP'$  parallel to  $Oy$  and  $Ox$ ,

$$u = -d\psi/dy, \quad v = d\psi/dx, \quad (1)$$

and  $\psi$  is called after the inventor, "Stokes's stream or current function," as it is constant along a stream line (*Trans. Camb. Phil. Soc.*, 1842; "Stokes's Current Function," R. A. Sampson, *Phil. Trans.*, 1892); and  $d\psi/dy$  is the component velocity across  $ds$  in a direction turned through a right angle forward.

In this symmetrical motion

$$\xi = 0, \eta = 0, 2\xi = \frac{d}{dx} \left( \frac{1}{y} \frac{d\psi}{dx} \right) + \frac{d}{dy} \left( \frac{1}{y} \frac{d\psi}{dy} \right) \\ = \frac{1}{y} \frac{d^2 \psi}{dx^2} + \frac{d^2 \psi}{dy^2} - \frac{1}{y} \frac{d\psi}{dy} = -\frac{1}{y} \nabla^2 \psi, \quad (2)$$

suppose; and in steady motion,

$$\frac{dH}{dx} + \frac{1}{y} \frac{d\psi}{dx} \nabla^2 \psi = 0, \quad \frac{dH}{dy} + \frac{1}{y} \frac{d\psi}{dy} \nabla^2 \psi = 0, \quad (3)$$

so that

$$2\xi \gamma = -y^2 \nabla^2 \psi = dH/d\psi$$

is a function of  $\psi$ , say  $f(\psi)$ , and constant along a stream line;

$$dH/dv = 2g\xi, \quad H - f(\psi) = \text{constant}, \quad (5)$$

throughout the liquid.

When the motion is irrotational,

$$\xi = 0, \quad u = -\frac{d\phi}{dx} = -\frac{1}{y} \frac{d\psi}{dy}, \quad v = \frac{d\phi}{dy} = \frac{1}{y} \frac{d\psi}{dx} \quad (6)$$

$$\nabla^2 \psi = 0, \text{ or } \frac{d^2 \psi}{dx^2} + \frac{d^2 \psi}{dy^2} - \frac{1}{y} \frac{d\psi}{dy} = 0. \quad (7)$$



Changing to polar coordinates,  $x = r \cos \theta$ ,  $y = r \sin \theta$ , the equation (2) becomes, with  $\cos \theta = \mu$ ,

$$r^2 \frac{d^2 \psi}{dr^2} + (1 - \mu^2) \frac{d^2 \psi}{d\mu^2} = 2 \zeta r^2 \sin \theta, \quad (8)$$

of which a solution, when  $\zeta = 0$ , is

$$\psi = \left( A r^{\pi+1} + \frac{B}{r} \right) (1 - \mu^2) \frac{dP_n}{d\mu} = \left( A r^{\pi+1} + \frac{B}{r^{\pi+2}} \right) \zeta^2 \frac{d^2 P_n}{d\mu^2}, \quad (9)$$

$$\phi = \{(n+1)A r^\pi - \pi B r^{-\pi-1}\} P_n, \quad (10)$$

where  $P_n$  denotes the zonal harmonic of the  $n$ th order; also, in the exceptional case of

$$\begin{aligned} \psi &= A_0 \cos \theta, \quad \phi = A_0/r; \\ \psi &= B_1 r, \quad \phi = -B_1 \log \tan \frac{1}{2} \theta \\ &= -\frac{1}{2} B_1 \text{sh}^{-1} x/y. \end{aligned} \quad (11)$$

Thus  $\cos \theta$  is the Stokes' function of a point source at  $O$ , and  $PA - PB$  of a line source  $AB$ .

The stream function  $\psi$  of the liquid motion set up by the passage of a solid of revolution, moving with axial velocity  $U$ , is such that

$$\frac{1}{r} \frac{d\psi}{dr} = -U \frac{dy}{dy}, \quad \psi + \frac{1}{2} U y^2 = \text{constant}, \quad (12)$$

over the surface of the solid; and  $\psi$  must be replaced by  $\psi' = \psi + \frac{1}{2} U y^2$  in the general equations of steady motion above to obtain the steady relative motion of the liquid past the solid.

For instance, with  $\pi = 1$  in equation (9), the relative stream function is obtained for a sphere of radius  $a$ , by making it

$$\psi' = \psi + \frac{1}{2} U y^2 = \frac{1}{2} U (r^2 - a^2/r) \sin^2 \theta, \quad \psi = -\frac{1}{2} U a^2 \sin^2 \theta/r, \quad (13)$$

and then

$$\phi' = Ux \left( 1 + \frac{1}{2} a^3/r^3 \right), \quad \phi = \frac{1}{2} U a^2 \cos \theta/r^2, \quad (14)$$

$$-\frac{d\phi}{dr} = U a^2 \cos \theta, \quad -\frac{d\phi}{d\theta} = \frac{1}{2} U \frac{a^3}{r^3} \sin \theta, \quad (15)$$

so that, if the direction of motion makes an angle  $\psi$  with  $Ox$ ,

$$\tan(\psi - \theta) = \frac{1}{2} \tan \theta, \quad \tan \psi = 3 \tan \theta / (2 - \tan^2 \theta). \quad (16)$$

Along the path of a liquid particle  $\psi'$  is constant, and putting it equal to  $\frac{1}{2} U c^2$ ,

$$(r^2 - a^2/r) \sin^2 \theta = c^2, \quad \sin^2 \theta = c^2 r / (r^3 - a^2), \quad (17)$$

the polar equation; or

$$y^2 = c^2 r^3 / (r^3 - a^2), \quad r^3 = a^2 y^2 / (y^2 - c^2), \quad (18)$$

a curve of the 10th degree ( $C_{10}$ ).

In the absolute path in space

$$\cos \psi = (2 - 3 \sin^2 \theta) / \sqrt{4 - 3 \sin^2 \theta}, \quad \text{and } \sin^2 \theta = (y^2 - c^2 y) / a^2, \quad (19)$$

which leads to no simple relation.

The velocity past the surface of the sphere is

$$\frac{1}{r} \frac{d\psi'}{dr} = \frac{1}{2} U \left( 2r + \frac{a^3}{r^3} \right) \frac{\sin^2 \theta}{r} = \frac{3}{2} U \sin \theta, \quad \text{when } r = a; \quad (20)$$

so that the loss of head is

$$\left\{ \frac{1}{2} \sin^2 \theta - 1 \right\} U^2 / 2g, \quad \text{having a maximum } \frac{1}{2} U^2 / 2g, \quad (21)$$

which must be less than the head at infinite distance to avoid cavitation at the surface of the sphere.

With  $\pi = 2$ , a state of motion is given by

$$\psi = -\frac{1}{2} U y^2 a^4 \mu / r^4, \quad \psi' = \frac{1}{2} U y^2 (1 - a^4 \mu / r^4), \quad (22)$$

$$\phi' = Ux + \phi, \quad \phi = -\frac{1}{2} U (a^4 / r^2) P_2, \quad P_2 = \frac{3}{2} \mu^2 - \frac{1}{2}, \quad (23)$$

representing a stream past the surface  $r^4 = a^4 \mu$ .

35. A circular vortex, such as a smoke ring, will set up motion symmetrical about an axis, and provide an illustration; a half vortex ring can be generated in water by drawing a semicircular blade a short distance forward, the tip of a spoon for instance. The vortex advances with a certain velocity; and if an equal circular vortex is generated coaxially with the first, the mutual influence can be observed. The first vortex dilates and moves slower, while the second contracts and shoots through the first; after which the motion is reversed periodically, as if in a game of leap-frog. Projected perpendicularly against a plane boundary, the motion is determined by an equal opposite vortex ring, the optical image; the vortex ring spreads out and moves more slowly as it approaches the wall; at the same time the molecular rotation, inversely as the cross-section of the vortex, is seen to increase. The analytical treatment of such vortex rings is the same as for the electro-magnetic effect of a current circulating in each ring.

36. *Irrational Motion in General.*—Liquid originally at rest in a singly-connected space cannot be set in motion by a field of force due to a single-valued potential function; any motion set up in the liquid must be due to a movement of the boundary, and the motion will be irrotational; for any small spherical element of the liquid may be considered a smooth solid sphere for a moment, and the normal pressure of the surrounding liquid cannot impart to it any rotation.

The kinetic energy of the liquid inside a surface  $S$  due to the velocity function  $\phi$  is given by

$$\begin{aligned} T &= \frac{1}{2} \rho \iiint \left[ \left( \frac{d\phi}{dx} \right)^2 + \left( \frac{d\phi}{dy} \right)^2 + \left( \frac{d\phi}{dz} \right)^2 \right] dx dy dz, \\ &= \frac{1}{2} \rho \iint \phi \frac{d\phi}{ds} dS \end{aligned} \quad (1)$$

by Green's transformation,  $ds$  denoting an elementary step along the normal to the exterior of the surface; so that  $d\phi/ds = 0$  over the surface makes  $T = 0$ , and then

$$\left( \frac{d\phi}{dx} \right)^2 + \left( \frac{d\phi}{dy} \right)^2 + \left( \frac{d\phi}{dz} \right)^2 = 0, \quad \frac{d\phi}{dx} = 0, \quad \frac{d\phi}{dy} = 0, \quad \frac{d\phi}{dz} = 0. \quad (2)$$

If the actual motion at any instant is supposed to be generated instantaneously from rest by the application of pressure impulse over the surface, or suddenly reduced to rest again, then, since no natural forces can act impulsively throughout the liquid, the pressure impulse  $\omega$  satisfies the equations

$$\frac{1}{\rho} \frac{d\omega}{dx} = -u, \quad \frac{1}{\rho} \frac{d\omega}{dy} = -v, \quad \frac{1}{\rho} \frac{d\omega}{dz} = -w, \quad (3)$$

$$\omega = \rho \phi + \text{constant}, \quad (4)$$

and the constant may be ignored; and Green's transformation of the energy  $T$  amounts to the theorem that the work done by an impulse is the product of the impulse and average velocity, or half the velocity from rest.

In a multiply connected space, like a ring, with a multiply valued velocity function  $\phi$ , the liquid can circulate in the circuits independently of any motion of the surface; thus, for example,

$$\phi = m\theta = m \tan^{-1} y/x \quad (5)$$

will give motion to the liquid, circulating in any ring-shaped figure of revolution round  $Oz$ .

To find the kinetic energy of such motion in a multiply connected space, the channels must be supposed barred, and the space made acyclic by a membrane, moving with the velocity of the liquid; and then if  $k$  denotes the cyclic constant of  $\phi$  in any circuit, or the value by which  $\phi$  has increased in completing the circuit, the values of  $\phi$  on the two sides of the membrane are taken as differing by  $k$ , so that the integral over the membrane

$$\iint \phi \frac{d\phi}{ds} dS = k \int \phi \frac{d\phi}{ds} dS, \quad (6)$$

and this term is to be added to the terms in (1) to obtain the additional part in the kinetic energy; the continuity shows that the integral is independent of the shape of the barrier membrane, and its position. Thus, in (5), the cyclic constant  $k = 2\pi m$ .

In plane motion the kinetic energy per unit length parallel to  $Oz$

$$\begin{aligned} T &= \frac{1}{2} \rho \iint \left[ \left( \frac{d\phi}{dx} \right)^2 + \left( \frac{d\phi}{dy} \right)^2 \right] dx dy = \frac{1}{2} \rho \iint \left[ \left( \frac{d\psi}{dx} \right)^2 + \left( \frac{d\psi}{dy} \right)^2 \right] dx dy \\ &= \frac{1}{2} \rho \int \phi \frac{d\phi}{ds} ds = \frac{1}{2} \rho \int \psi \frac{d\psi}{ds} ds. \end{aligned} \quad (7)$$

For example, in the equilateral triangle of (8) § 28, referred to co-ordinate axes made by the base and height,

$$\psi' = -2r\alpha\theta y/h = -\frac{1}{2} R y [(h-y)^2 - 3x^2]/h \quad (8)$$

$$\psi = \psi' - \frac{1}{2} R \left[ \frac{1}{2} (h-y)^2 + x^2 \right]$$

$$= -\frac{1}{2} R \left[ \frac{1}{2} h^2 + \frac{1}{2} h^2 y + h^2 x^2 - y^2 \right] - 3x^2 y + y^3/h \quad (9)$$

and over the base  $y = 0$ ,

$$dx/dv = -dx/dy = +\frac{1}{2} R [(h^2 - 3x^2)/h], \quad \psi = -\frac{1}{2} R (\frac{1}{2} h^2 + x^2). \quad (10)$$

Integrating over the base, to obtain one-third of the kinetic energy  $T$ ,

$$\begin{aligned} \frac{1}{3} T &= \frac{1}{2} \rho \int \frac{h/\sqrt{3}}{-h/\sqrt{3}} \left[ \frac{1}{2} R^3 (3x^4 - 2x^2 h^2) dx/h \right] \\ &= \rho R^3 h^4 / 135 \sqrt{3} \end{aligned} \quad (11)$$

so that the effective  $k^2$  of the liquid filling the triangle is given by

$$k^2 = T / \frac{1}{2} \rho R^2 A = 2h^2 / 45 \quad (12)$$

or two-fifths of the  $k^2$  for the solid triangle.

Again, since

$$d\phi/dv = d\psi/ds, \quad d\phi/ds = -d\psi/dv, \quad (13)$$

$$T = \frac{1}{2} \rho \int \phi d\psi = -\frac{1}{2} \rho \int \psi d\phi. \quad (14)$$

With the Stokes' function  $\psi$  for motion symmetrical about an axis.

$$T = \frac{1}{2} \rho \int \phi \frac{d\psi}{y ds} 2\pi y ds = \pi \rho \int \phi d\psi. \quad (15)$$

37. *Flow, Circulation, and Vortex Motion.*—The line integral of the tangential velocity along a curve from one point to another, defined by

$$\int \left( u \frac{dx}{ds} + v \frac{dy}{ds} + w \frac{dz}{ds} \right) ds = f(u dx + v dy + w dz), \quad (1)$$

is called the "flux" along the curve from the first to the second point; and if the curve closes in on itself the line integral round the curve is called the "circulation" in the curve.

With a velocity function  $\phi$ , the flow

$$-f d\phi = \phi_1 - \phi_2, \quad (2)$$

so that the flow is independent of the curve for all curves mutually reconcilable; and the circulation round a closed curve is zero, if the curve can be reduced to a point without leaving a region for which  $\phi$  is single valued.

If through every point of a small closed curve the vortex lines are drawn, a tube is obtained, and the fluid contained is called a *vortex filament*.

By analogy with the spin of a rigid body, the component spin of the fluid in any plane at a point is defined as the circulation round a small area in the plane enclosing the point, divided by twice the area. For in a rigid body, rotating about  $Ox$  with angular velocity  $\omega$ , the circulation round a curve in the plane  $xy$  is

$$\int \zeta \left( x \frac{dy}{ds} - y \frac{dx}{ds} \right) ds = \zeta \text{ times twice the area.} \quad (3)$$

In a fluid, the circulation round an elementary area  $dxdy$  is equal to

$$u dx + \left( v + \frac{dv}{dx} dx \right) dy - \left( u + \frac{du}{dy} dy \right) dx - v dy = \left( \frac{dv}{dx} \frac{du}{dy} \right) dxdy, \quad (4)$$

so that the component spin is

$$\frac{1}{2} \left( \frac{dv}{dx} \frac{du}{dy} \right) = \zeta, \quad (5)$$

in the previous notation of § 24; so also for the other two components  $\xi$  and  $\eta$ .

Since the circulation round any triangular area of given aspect is the sum of the circulation round the projections of the area on the coordinate planes, the composition of the components of spin,  $\xi, \eta, \zeta$ , is according to the vector law. Hence in any infinitesimal part of the fluid the circulation is zero round every small plane curve passing through the vortex line; and consequently the circulation round any curve drawn on the surface of a vortex filament is zero.

If at any two points of a vortex line the cross-section  $ABC, A'B'C'$  is drawn of the vortex filament, joined by the vortex line  $AA'$ , then, since the flow in  $AA'$  is taken in opposite directions in the complete circuit  $ABC A'A' B'C' A A'$ , the resultant flow in  $AA'$  cancels, and the circulation in  $ABC, A'B'C'$  is the same; this is expressed by saying that at all points of a vortex filament  $\omega$  is constant where  $a$  is the cross-section of the filament and  $\omega$  the resultant spin (W. K. Clifford, *Kinematics*, book iii.).

So far these theorems on vortex motion are kinematical; but introducing the equations of motion of the  $Du, Dv, D\omega$

$$\frac{Du}{dt} + \frac{dQ}{dx} = 0, \quad \frac{Dv}{dt} + \frac{dQ}{dy} = 0, \quad \frac{D\omega}{dt} + \frac{dQ}{ds} = 0, \quad (6)$$

$$Q = f(\rho) + v\omega, \quad (7)$$

and taking  $dx, dy, ds$  in the direction of  $u, v, \omega$ , and  $dx:dy:ds = u:v:\omega$ ,

$$\frac{D}{dt} (u dx + v dy + \omega ds) = \frac{Du}{dt} dx + u \frac{Ddx}{dt} + \dots = -dQ + \frac{1}{2} d\omega^2, \quad (8)$$

and integrating round a closed curve

$$\frac{D}{dt} \int (u dx + v dy + \omega ds) = 0, \quad (9)$$

and the circulation in any circuit composed of the same fluid particles is constant; and if the motion is differential irrotational and due to a velocity function, the circulation is zero round all reconcilable paths. Interpreted dynamically the normal pressure of the surrounding fluid on a tube cannot create any circulation in the tube.

The circulation being always zero round a small plane curve passing through the axis of spin in vortical motion, it follows conversely that a vortex filament is composed always of the same fluid particles; and since the circulation round a cross-section of a vortex filament is constant, not changing with the time, it follows from the previous kinematical theorem that  $\omega$  is constant for all time, and the same for every cross-section of the vortex filament.

A vortex filament must close on itself, or end on a bounding surface, as when the tip of a spoon is drawn through the surface of water.

Denoting the cross-section  $a$  of a filament by  $dS$  and its mass by  $dm$ , the quantity  $\omega dS/dm$  is called the *vorticity*; and this is the same at all points of a filament, and it does not change during the motion; and the vorticity is given by  $\omega$  as  $\omega dS/dm$ , if  $dS$  is the oblique section of which the normal makes an angle  $\epsilon$  with the filament, while the aggregate vorticity of a mass  $M$  inside a surface  $S$  is

$$M^{-1} \int \omega \cos \epsilon dS.$$

Employing the equation of continuity when the liquid is homogeneous,

$$z \left( \frac{d\zeta}{dy} - \frac{d\eta}{dx} \right) = \zeta^2 u, \dots, \zeta^2 = -\frac{d^2}{dx^2} - \frac{d^2}{dy^2} - \frac{d^2}{dz^2}, \quad (10)$$

which is expressed by

$$\nabla^2(u, v, \omega) = 2 \text{ curl } (\xi, \eta, \zeta), \quad (11)$$

38. *Moving Axes in Hydrodynamics.*—In many problems, such as the motion of a solid in liquid, it is convenient to take coordinate axes fixed to the solid and moving with it as the movable trihedron frame of reference. The components of velocity of the moving

origin are denoted by  $U, V, W$ , and the components of angular velocity of the frame of reference by  $P, Q, R$ ; and then if  $u, v, w$  we denote the components of fluid velocity in space, and  $u', v', w'$  the components relative to the axes at a point  $(x, y, z)$  fixed to the frame of reference, we have

$$\begin{aligned} u &= U + u' - yR + zQ, \\ v &= V + v' - zP + xR, \\ w &= W + w' - xQ + yP. \end{aligned} \quad (1)$$

Now if  $k$  denotes the component of absolute velocity in a direction fixed in space whose direction cosines are  $l, m, n$ ,

$$k = lu + mv + nw, \quad (2)$$

and in the infinitesimal element of time  $dt$ , the coordinates of the fluid particle at  $(x, y, z)$  will have changed by  $(u', v', w')dt$ ; so that

$$\begin{aligned} \frac{Dk}{dt} &= \frac{dk}{dt} + \frac{dm}{dt} + \frac{dn}{dt} + \frac{dl}{dt} + \frac{dm}{dt} + \frac{dn}{dt} + \frac{dl}{dt} + \frac{dm}{dt} + \frac{dn}{dt} \\ &+ \left( \frac{du}{dt} + u' \frac{dx}{dx} + v' \frac{dy}{dy} + w' \frac{dz}{dz} \right) \\ &+ m \left( \frac{dv}{dt} + u' \frac{dv}{dx} + v' \frac{dv}{dy} + w' \frac{dv}{dz} \right) \\ &+ n \left( \frac{dw}{dt} + u' \frac{dw}{dx} + v' \frac{dw}{dy} + w' \frac{dw}{dz} \right). \end{aligned} \quad (3)$$

But as  $l, m, n$  are the direction cosines of a line fixed in space,

$$\frac{dl}{dt} = mR - nQ, \quad \frac{dm}{dt} = nP - lR, \quad \frac{dn}{dt} = lQ - mP; \quad (4)$$

so that

$$\begin{aligned} \frac{Dk}{dt} &= l \left( \frac{du}{dt} - vR + wQ + u' \frac{dx}{dx} + v' \frac{dy}{dy} + w' \frac{dz}{dz} \right) + m(\dots) + n(\dots) \\ &= l \left( X - \frac{1}{\rho} \frac{dp}{dx} \right) + m \left( Y - \frac{1}{\rho} \frac{dp}{dy} \right) + n \left( Z - \frac{1}{\rho} \frac{dp}{dz} \right), \end{aligned} \quad (5)$$

for all values of  $l, m, n$ , leading to the equations of motion with moving axes.

When the motion is such that

$$u = \frac{d\phi}{dx} - m \frac{d\psi}{dx}, \quad v = -\frac{d\phi}{dy} - m \frac{d\psi}{dy}, \quad w = \frac{d\phi}{dz} - m \frac{d\psi}{dz}, \quad (6)$$

as in § 25 (1), a first integral of the equations in (5) may be written

$$\begin{aligned} \int \left( \frac{d\phi}{\rho} + V + \frac{1}{2} q^2 - \frac{d\phi}{dt} - m \frac{d\psi}{dt} + (u-u') \left( \frac{d\phi}{dx} + m \frac{d\psi}{dx} \right) \right. \\ \left. + (v-v') \left( \frac{d\phi}{dy} + m \frac{d\psi}{dy} \right) + (w-w') \left( \frac{d\phi}{dz} + m \frac{d\psi}{dz} \right) \right) = F(t), \end{aligned} \quad (7)$$

in which

$$\begin{aligned} \frac{d\phi}{dt} - (u-u') \frac{d\phi}{dx} - (v-v') \frac{d\phi}{dy} - (w-w') \frac{d\phi}{dz} \\ = -\frac{d\phi}{dt} - (U - yR + zQ) \frac{d\phi}{dx} - (V - zP + xR) \frac{d\phi}{dy} - (W - xQ + yP) \frac{d\phi}{dz} \end{aligned} \quad (8)$$

is the time-rate of change of  $\phi$  at a point fixed in space, which is left behind with velocity components  $u-u', v-v', w-w'$ .

In the case of a steady motion of homogeneous liquid symmetrical about  $Ox$ , where  $O$  is advancing with velocity  $U$ , the equation (5) of § 34

$$\rho \left( \frac{d\phi}{dt} + V + \frac{1}{2} q^2 \right) - f(\psi) = \text{constant} \quad (9)$$

becomes transformed into

$$\frac{\rho}{\rho} + V + \frac{1}{2} q^2 - \frac{U d\psi}{y dy} + \frac{1}{2} U^2 - f(\psi) + \frac{1}{2} U y^2 = \text{constant}, \quad (10)$$

$$\psi' = \psi + \frac{1}{2} U y^2, \quad (11)$$

subject to the condition, from (4) § 34,

$$y^2 \nabla^2 \psi' = -f'(\psi'), \quad r^2 \nabla^2 \psi' = -f'(\psi' + \frac{1}{2} U y^2). \quad (12)$$

Thus, for example, with

$$\psi' = \frac{1}{2} U y^2 (r^2 a^2 - 1), \quad r^2 = x^2 + y^2, \quad (13)$$

for the space inside the sphere  $r=a$ , compared with the value of  $\psi'$  in § 34 (13) for the space outside, there is no discontinuity of the velocity in crossing the surface.

Inside the sphere

$$2f' = \frac{d}{dx} \left( \frac{1}{y} \frac{d\psi'}{dx} \right) + \frac{d}{dy} \left( \frac{1}{y} \frac{d\psi'}{dy} \right) = \frac{15}{2} U \frac{y}{a^2}, \quad (14)$$

so that § 34 (4) is satisfied, with

$$f'(\psi') = \frac{15}{2} U a^2, \quad f(\psi') = \frac{15}{2} U \psi' a^2; \quad (15)$$

and (10) reduces to

$$\frac{\rho}{\rho} + \frac{V}{\rho} - \frac{U}{\rho} \left\{ \left( \frac{x^2}{a^2} - 1 \right)^2 - \left( \frac{y^2}{a^2} - 1 \right)^2 \right\} = \text{constant}; \quad (16)$$

this gives the state of motion in M. J. M. Hill's spherical vortex, advancing through the surrounding liquid with uniform velocity.

39. As an application of moving axes, consider the motion of liquid filling the ellipsoidal case

$$\frac{x^2}{a^2} + \frac{y^2}{b^2} + \frac{z^2}{c^2} = 1; \quad (1)$$

and first suppose the liquid to be frozen, and the ellipsoid to be

rotating about the centre with components of angular velocity  $\xi, \eta, \zeta$ ; then

$$u = -y\zeta + \eta z, v = -z\xi + x\zeta, w = -x\eta + y\xi. \quad (2)$$

Now suppose the liquid to be melted, and additional components of angular velocity  $\Omega_x, \Omega_y, \Omega_z$  communicated to the ellipsoidal case; the additional velocity communicated to the liquid will be due to a velocity-function

$$\phi = -\Omega_x \frac{b^2 - c^2}{b^2 + c^2} x - \Omega_y \frac{c^2 - a^2}{c^2 + a^2} y - \Omega_z \frac{a^2 - b^2}{a^2 + b^2} z, \quad (3)$$

as may be verified by considering one term at a time.

If  $u', v', w'$  denote the components of the velocity of the liquid relative to the axes,

$$u' = u + yR - zQ = \frac{2a^2}{a^2 + b^2} \Omega_y y - \frac{2a^2}{c^2 + a^2} \Omega_z z, \quad (4)$$

$$v' = v + zP - xR = \frac{2b^2}{b^2 + c^2} \Omega_z z - \frac{2b^2}{a^2 + b^2} \Omega_x x, \quad (5)$$

$$w' = w + xQ - yP = \frac{2c^2}{c^2 + a^2} \Omega_x x - \frac{2c^2}{b^2 + c^2} \Omega_y y, \quad (6)$$

$$P = \Omega_x + \xi, Q = \Omega_y + \eta, R = \Omega_z + \zeta. \quad (7)$$

Thus

$$u \frac{dx}{dt} + v \frac{dy}{dt} + w \frac{dz}{dt} = 0, \quad (8)$$

so that a liquid particle remains always on a similar ellipsoid.

The hydrodynamical equations with moving axes, taking into account the mutual gravitation of the liquid, become

$$\frac{1}{\rho} \frac{dP}{dx} + 4\pi\rho Ax + \frac{d^2u}{dt^2} - vR + wQ + u \frac{d^2u}{dx^2} + v \frac{d^2v}{dy^2} + w \frac{d^2w}{dz^2} = 0, \dots, \dots, \quad (9)$$

where

$$A, B, C, = \int_0^{\pi} \frac{abcd\lambda}{(a^2 + \lambda)(b^2 + \lambda)(c^2 + \lambda)} P \\ P^2 = 4(a^2 + \lambda)(b^2 + \lambda)(c^2 + \lambda). \quad (10)$$

With the values above of  $u, v, w, u', v', w'$ , the equations become of the form

$$\frac{1}{\rho} \frac{dP}{dx} + 4\pi\rho Ax + ax + by + gz = 0, \quad (11)$$

$$\frac{1}{\rho} \frac{dP}{dy} + 4\pi\rho By + hx + by + fz = 0, \quad (12)$$

$$\frac{1}{\rho} \frac{dP}{dz} + 4\pi\rho Cz + gx + fy + \gamma z = 0, \quad (13)$$

and integrating

$$\rho\rho^{-1} + 2\pi\rho(Ax^2 + By^2 + Cz^2) \\ + (ax^2 + by^2 + \gamma z^2 + 2fyz + 2gax + 2hxy) = \text{const.}, \quad (14)$$

so that the surfaces of equal pressure are similar quadric surfaces, which, symmetry and dynamical considerations show, must be coaxial surfaces; and  $f, g, h$  vanish, as follows also by algebraical reduction; and

$$a = \frac{4c^2(c^2 - a^2)}{(c^2 + a^2)^2} \Omega_z^2 - \left( \frac{c^2 - a^2}{c^2 + a^2} \Omega_z - \eta \right)^2 \\ - \frac{4b^2(b^2 - b^2)}{(a^2 + b^2)^2} \Omega_x^2 - \left( \frac{a^2 - b^2}{a^2 + b^2} \Omega_x - \xi \right)^2, \quad (15)$$

with similar equations for  $\beta$  and  $\gamma$ .

If we can make

$$(4\pi\rho A + a)x^2 = (4\pi\rho B + b)y^2 = (4\pi\rho C + \gamma)z^2, \quad (16)$$

the surfaces of equal pressure are similar to the external case, which can then be removed without affecting the motion, provided  $a, \beta, \gamma$  remain constant.

This is so when the axis of revolution is a principal axis, say  $Oz$ ; when

$$\Omega_x = 0, \Omega_y = 0, \xi = 0, \eta = 0. \quad (17)$$

If  $\Omega_z = 0$  or  $\Omega_x = \Omega_y = \Omega_z = 0$  in addition, we obtain the solution of Jacobi's ellipsoid of liquid of three unequal axes, rotating bodily about the least axis; and putting  $a = b$ , Maclaurin's solution is obtained of the rotating spheroid.

In the general motion again of the liquid filling a case, when  $a = b$ ,  $\Omega_x$  may be replaced by zero and the equations, hydrodynamical and dynamical, reduce to

$$\frac{d\xi}{dt} = -\frac{2c^2}{a^2 + c^2} \Omega_z \xi, \frac{d\eta}{dt} = \frac{2a^2}{a^2 + c^2} \Omega_z \eta, \frac{d\zeta}{dt} = \frac{2c^2}{a^2 + c^2} (\Omega_z \xi - \Omega_x \eta) \quad (18)$$

$$\frac{d\Omega_x}{dt} = \Omega_x + \frac{a^2 + c^2}{a^2 - c^2} \eta \xi, \frac{d\Omega_y}{dt} = -\Omega_y + \frac{a^2 + c^2}{a^2 - c^2} \xi \eta; \quad (19)$$

of which three integrals are

$$\xi^2 + \eta^2 = L - \frac{a^2}{c^2} \zeta^2, \quad (20)$$

$$\Omega_x^2 + \Omega_y^2 = M + \frac{(a^2 + c^2)^2}{2c^2(a^2 - c^2)^2} \zeta^2, \quad (21)$$

$$\Omega_x \xi + \Omega_y \eta = N + \frac{a^2 + c^2}{4c^2} \zeta^2; \quad (22)$$

and then

$$\left( \frac{d\zeta}{dt} \right)^2 = \frac{4c^2}{(a^2 + c^2)^2} (\Omega_z \xi - \Omega_x \eta)^2 \\ = \frac{4c^2}{(a^2 + c^2)^2} (\xi^2 + \eta^2) (\Omega_x^2 + \Omega_y^2) - (\Omega_x \xi + \Omega_y \eta)^2 \\ = \frac{4c^2}{(a^2 + c^2)^2} \left[ L M - N^2 + \left\{ L \frac{(a^2 + c^2)^2}{2c^2(a^2 - c^2)^2} - M \frac{a^2}{c^2} - N \frac{a^2 + c^2}{2c^2} \right\} \zeta^2 \right. \\ \left. - \frac{(a^2 + c^2)(a^2 - c^2)}{16c^2(a^2 - c^2)^2} \zeta^4 \right] = Z, \quad (23)$$

where  $Z$  is a quadratic in  $\zeta^2$ , so that  $\zeta$  is an elliptic function of  $t$ , except when  $c = a$ , or  $3a$ .

Put  $\Omega_x = \Omega \cos \phi, \Omega_y = -\Omega \sin \phi,$

$$\Omega \frac{d\phi}{dt} = \frac{d\Omega_x}{dt} - \Omega_z \frac{d\Omega_y}{dt} = \Omega \xi^2 - \frac{a^2 + c^2}{a^2 - c^2} (\Omega_x \xi + \Omega_y \eta), \quad (24)$$

$$\frac{d\phi}{dt} = \xi - \frac{a^2 + c^2}{a^2 - c^2} \frac{N + \frac{a^2 + c^2}{4c^2} \zeta^2}{M + 2c^2 \frac{(a^2 - c^2)^2}{c^2} \zeta^2}, \quad (25)$$

$$\phi = \int \left( \frac{d\zeta}{\sqrt{Z}} \frac{a^2 + c^2}{a^2 - c^2} \right) \frac{N + \frac{a^2 + c^2}{4c^2} \zeta^2}{M + 2c^2 \frac{(a^2 - c^2)^2}{c^2} \zeta^2} \frac{d\zeta}{\sqrt{Z}}, \quad (26)$$

which, as  $Z$  is a quadratic function of  $\zeta^2$ , are non-elliptic integrals; so also for  $\psi$ , where  $\xi = \omega \cos \psi, \eta = -\omega \sin \psi$ .

In a state of steady motion

$$\frac{d\xi}{dt} = 0, \xi = \frac{\Omega_x}{\eta}, \quad (27)$$

$$\phi = \psi = \pi t, \text{ suppose,} \quad (28)$$

$$\Omega_x \xi + \Omega_y \eta = \Omega \omega, \quad (29)$$

$$\frac{d\phi}{dt} = \xi - \frac{a^2 + c^2}{a^2 - c^2} \frac{\Omega}{\omega}, \quad (30)$$

$$\frac{d\psi}{dt} = \xi - \frac{2a^2}{a^2 + c^2} \frac{\Omega}{\omega}, \quad (31)$$

$$1 - \frac{a^2 + c^2}{a^2 - c^2} \frac{\omega}{\Omega} = -\frac{2a^2}{a^2 + c^2} \frac{\Omega}{\omega}, \quad (32)$$

$$\left( \frac{\omega}{\Omega} - \frac{a^2 - c^2}{a^2 + c^2} \right)^2 = \frac{(a^2 - c^2)(9a^2 - c^2)}{4(a^2 + c^2)^2}, \quad (33)$$

and a state of steady motion is impossible when  $3a > c > a$ .

An experiment was devised by Lord Kelvin for demonstrating this, in which the difference of steadiness was shown of a copper shell filled with liquid and spun gyroscopically, according as the shell was slightly oblate or prolate. According to the theory above the stability is regained when the length is more than three diameters, so that a modern projectile with a cavity more than three diameters long should fly steadily when filled with water; while the old-fashioned type, not so elongated, would be highly unsteady; and for the same reason the gas bags of a dirigible balloon should be over rather than under three diameters long.

40. *A Liquid Jet.*—By the use of the complex variable and its conjugate functions, an attempt can be made to give a mathematical interpretation of problems such as the efflux of water in a jet or of smoke from a chimney, the discharge through a weir, the flow of water through the piers of a bridge, or past the side of a ship, the wind blowing on a sail or aeroplane, or against a wall, or impinging jets of gas or water; cases where a surface of discontinuity is observable, more or less distinct, which separates the running stream from the dead water or air.

Uniplanar motion alone is so far amenable to analysis; the velocity function  $\phi$  and stream function  $\psi$  are given as conjugate functions of the coordinates  $x, y$  by

$$w = f(z), \text{ where } z = x + yi, w = \phi + \psi i, \quad (1)$$

and then

$$\frac{dw}{dz} = \frac{d\phi}{dx} + i \frac{d\psi}{dx} = -u + \psi i; \quad (2)$$

so that, with  $u = q \cos \theta, v = q \sin \theta$ , the function

$$\zeta = -Q \frac{dw}{w} = \frac{Q}{u - vi} = \frac{Q}{q} (\cos \theta + i \sin \theta) = \frac{Q}{q} (\cos \theta + i \sin \theta), \quad (3)$$

gives  $\zeta$  as a vector representing the reciprocal of the velocity  $Q$  in direction and magnitude, in terms of some standard velocity  $Q$ .

To determine the motion of a jet which issues from a vessel with plane walls, the vector  $\zeta$  must be constructed so as to have a constant

direction  $\theta$  along a plane boundary, and to give a constant skin velocity over the surface of a jet, where the pressure is constant.

It is convenient to introduce the function

$$\Omega = \log \xi = \log(Q/q) + \theta i \quad (4)$$

so that the polygon representing  $\Omega$  normally has a boundary given by straight lines parallel to the coordinate axes; and then to determine  $\Omega$  and  $w$  as functions of a variable  $u$  (not to be confused with the velocity component of  $q$ ), such that in the conformal representation the boundary of the  $\Omega$  and  $w$  polygon is made to coincide with the real axis of  $u$ .

It will be sufficient to give a few illustrations.

Consider the motion where the liquid is coming from an infinite distance between two parallel walls at a distance  $xx'$  (fig. 4), and issues in a jet between two edges  $A$  and  $A'$ ; the wall  $x'A$  being bent at a corner  $B$ , with the external angle  $\beta = \frac{1}{2}\pi/n$ .

The theory of conformal representation shows that the motion is given by

$$\xi = \left[ \frac{\sqrt{(b-a')u-a} + \sqrt{(b-a'u-a')}}{\sqrt{(a-a')u-b}} \right]^{1/n}, \quad u = ae^{m\phi/n}; \quad (5)$$

where  $u = a, a'$  at the edge  $A, A'$ ;  $u = b$  at a corner  $B$ ;  $u = \infty$  across  $xx'$  where  $\phi = \infty$ ; and  $u = 0$ ,  $\phi = 0$  across the end  $JJ'$  of the jet, bounded by the curved lines  $APJ, A'P'J'$ , over which the skin velocity is  $Q$ . The stream lines  $xBAJ, x'A'J'$  are given by  $\psi = 0, m$ ; so that if  $c$  denotes the ultimate breadth  $JJ'$  of the jet, where the velocity may be supposed uniform and equal to the skin velocity  $Q$ ,

$$m = Qc, \quad c = m/Q.$$

If there are more  $B$  corners than one, either on  $x'A$  or  $x'A'$ , the expression for  $\xi$  is the product of corresponding factors, such as in (5).

Restricting the attention to a single corner  $B$ ,

$$\zeta^n = \left(\frac{Q}{q}\right)^n (\cos n\theta + i \sin n\theta) = \frac{\sqrt{(b-a')u-a} + \sqrt{(b-a'u-a')}}{\sqrt{(a-a')u-b}}, \quad (6)$$

$$\begin{aligned} \text{ch } n\Omega &= \text{ch } \log \left(\frac{Q}{q}\right)^n \cos n\theta + i \text{sh } \log \left(\frac{Q}{q}\right)^n \sin n\theta \\ &= \frac{1}{2}(\zeta^n + \zeta^{-n}) = \sqrt{\frac{b-a'}{a-a'}} \sqrt{\frac{u-a'}{u-b}}, \end{aligned} \quad (7)$$

$$\begin{aligned} \text{sh } n\Omega &= \text{sh } \log \left(\frac{Q}{q}\right)^n \cos n\theta + i \text{ch } \log \left(\frac{Q}{q}\right)^n \sin n\theta \\ &= \frac{1}{2}(\zeta^n - \zeta^{-n}) = \sqrt{\frac{b-a'}{a-a'}} \sqrt{\frac{u-a'}{u-b}}, \end{aligned} \quad (8)$$

$$\infty > a > b > a' > 0; \quad (9)$$

and then

$$\frac{d\Omega}{du} = -\frac{1}{2n} \frac{\sqrt{(b-a).b-a'}}{\sqrt{(u-a).u-a'}} \frac{du}{du} = -\frac{m}{\pi u} \quad (10)$$

the formulas by which the conformal representation is obtained.

For the wall  $x'A$  has a right angle at  $u = a, a'$ , and a zero angle at  $u = b$ , where  $\theta$  changes from 0 to  $\frac{1}{2}\pi/n$  and  $\Omega$  increases by  $\frac{1}{2}\pi/n$ ; so that

$$\frac{d\Omega}{du} = \frac{A}{(u-b)\sqrt{(u-a).u-a'}}; \quad \text{where } A = -\frac{\sqrt{(b-a).b-a'}}{2n}. \quad (11)$$

And the wall  $w$  polygon has a zero angle at  $u = 0, \infty$ , where  $\psi$  changes from 0 to  $m$  and back again, so that  $w$  changes by  $im$ , and

$$\frac{dw}{du} = \frac{B}{u}, \quad \text{where } B = -\frac{m}{\pi}. \quad (12)$$

Along the stream line  $xBAJ$ ,

$$\psi = 0, \quad u = ae^{m\phi/n}; \quad (13)$$

and over the jet surface  $JPA$ , where the skin velocity is  $Q$ ,

$$\frac{d\phi}{ds} = -q = -Q, \quad u = ae^{m\phi/n} = ae^{m\phi/c}, \quad (14)$$

denoting the arc  $AP$  by  $s$ , starting at  $u = a$ ;

$$\text{ch } n\Omega = \cos n\theta = \sqrt{\frac{b-a'}{a-a'}} \sqrt{\frac{u-a'}{u-b}}, \quad (15)$$

$$\text{sh } n\Omega = i \sin n\theta = i \sqrt{\frac{a-b}{a-a'}} \sqrt{\frac{u-a'}{u-b}}, \quad (16)$$

$$\infty > u = ae^{m\phi/c} > a, \quad (17)$$

and this gives the intrinsic equation of the jet, and then the radius of curvature

$$\begin{aligned} \rho &= -\frac{ds}{d\theta} = \frac{1}{Q} \frac{d\phi}{d\theta} = \frac{1}{Q} \frac{du}{d\theta} = \frac{1}{Q} \frac{du}{du} \frac{d\Omega}{d\theta} \\ &= \frac{c}{\pi} \frac{2n}{2n} \frac{u-b}{u} \sqrt{\frac{a-b}{a-a'}} \sqrt{\frac{u-a'}{u-b}}, \end{aligned} \quad (18)$$

not requiring the integration of (11) and (12)

If  $\theta = a$  across the end  $JJ'$  of the jet, where  $u = \infty, q = Q$ ,

$$\text{ch } n\Omega = \cos n\theta = \sqrt{\frac{b-a'}{a-a'}}, \quad \text{sh } n\Omega = i \sin n\theta = i \sqrt{\frac{a-b}{a-a'}} \quad (19)$$

Then

$$\begin{aligned} \cos 2n\theta &= \cos 2n\theta = 2 \frac{b-a'}{a-a'} \frac{u-a'}{u-b} = \frac{1}{2} \sin^2 2n\theta \frac{a-a'}{u-b} \\ \sin 2n\theta &= 2 \frac{\sqrt{(a-b).b-a'}}{a-a'} \sqrt{\frac{u-a'.u-b'}{u-b}} \\ &= \sin 2n\theta \frac{\sqrt{(u-a).u-a'}}{u-b}; \end{aligned} \quad (20)$$

$$\frac{2n}{\pi} c = \left(1 + \frac{b}{u-b}\right) \sqrt{\frac{(a-b).b-a'}{(u-a).u-a'}} \quad (21)$$

$$= \frac{a-a' + (a+a') \cos 2n\theta - [a+a' + (a-a') \cos 2n\theta] \cos 2n\theta}{(a-a') \sin^2 2n\theta} \times \frac{\cos 2n\theta - \cos 2n\theta}{\sin 2n\theta}.$$

$$\text{Along the wall } AB, \cos n\theta = 0, \sin n\theta = 1, \quad a > u > b, \quad (22)$$

$$\text{ch } n\Omega = i \text{sh } \log \left(\frac{Q}{q}\right)^n = i \sqrt{\frac{b-a'}{a-a'}} \sqrt{\frac{a-u}{u-b}}, \quad (23)$$

$$\text{sh } n\Omega = i \text{ch } \log \left(\frac{Q}{q}\right)^n = i \sqrt{\frac{a-b}{a-a'}} \sqrt{\frac{u-a'}{u-b}}, \quad (24)$$

$$\frac{ds}{du} = \frac{ds}{d\phi} \frac{d\phi}{du} = \frac{m}{\pi u} = \frac{c}{\pi u} \quad (25)$$

$$\frac{AB}{c} = \int_0^{\infty} \frac{Q du}{b \sqrt{q}} = \int \left[ \frac{\sqrt{(a-b)\sqrt{(u-a')} + \sqrt{(b-a')\sqrt{(a-u)'}}}{\sqrt{(a-a')\sqrt{(u-b)'}}} \right]^{1/n} du. \quad (26)$$

$$\text{Along the wall } Bx, \cos n\theta = 1, \sin n\theta = 0, \quad b > u > a \quad (27)$$

$$\text{ch } n\Omega = \text{ch } \log \left(\frac{Q}{q}\right)^n = \sqrt{\frac{b-a'}{a-a'}} \sqrt{\frac{a-u}{u-b}}, \quad (28)$$

$$\text{sh } n\Omega = \text{sh } \log \left(\frac{Q}{q}\right)^n = \sqrt{\frac{a-b}{a-a'}} \sqrt{\frac{u-a'}{b-u}}. \quad (29)$$

At  $x$  where  $\phi = \infty, u = 0$ , and  $q = q_0$ ,

$$\left(\frac{Q}{q}\right)^n = \sqrt{\frac{b-a'}{a-a'}} \sqrt{\frac{a}{b}} + \sqrt{\frac{a-b}{a-a'}} \sqrt{\frac{-a'}{q}}. \quad (30)$$

In crossing to the line of flow  $x'A'P'J'$ ,  $\psi$  changes from 0 to  $m$ , so that with  $q = Q$  across  $JJ'$ , while across  $xx'$  the velocity is  $q_0$ , so that

$$m = q_0, \quad xx' = QJJ' \quad (31)$$

$$\frac{JJ'}{xx'} = \frac{q_0}{Q} = \left[ \sqrt{\frac{b-a'}{a-a'}} \sqrt{\frac{a}{b}} + \sqrt{\frac{a-b}{a-a'}} \sqrt{\frac{-a'}{q}} \right]^{1/n}, \quad (32)$$

giving the contraction of the jet compared with the initial breadth of the stream.

Along the line of flow  $x'A'P'J'$ ,  $\psi = m, u = a'e^{-m\phi/n}$ , and from  $x'$  to  $A'$ ,  $\cos n\theta = 1, \sin n\theta = 0$ ,

$$\text{ch } n\Omega = \text{ch } \log \left(\frac{Q}{q}\right)^n = \sqrt{\frac{b-a'}{a-a'}} \sqrt{\frac{a-u}{u-b}}, \quad (33)$$

$$\text{sh } n\Omega = \text{sh } \log \left(\frac{Q}{q}\right)^n = \sqrt{\frac{a-b}{a-a'}} \sqrt{\frac{u-a'}{b-u}}, \quad (34)$$

$$a' > u > a'. \quad (35)$$

Along the jet surface  $A'J'$ ,

$$\text{ch } n\Omega = \cos n\theta = \sqrt{\frac{b-a'}{a-a'}} \sqrt{\frac{a-u}{u-b}}, \quad (36)$$

$$\text{sh } n\Omega = i \sin n\theta = i \sqrt{\frac{a-b}{a-a'}} \sqrt{\frac{a'-u}{b-u}}, \quad (37)$$

$$a' > u = a'e^{m\phi/n} > -\infty, \quad (38)$$

giving the intrinsic equation.

41. The first problem of this kind, worked out by H. v. Helmholtz, of the efflux of a jet between two edges  $A$  and  $A_1$  in an infinite wall, is obtained by the symmetrical duplication of the above, with  $n = 1, b = 0, a' = -\infty$ , as in fig. 5,

$$\text{ch } \Omega = \sqrt{\frac{u-a}{u}}, \quad \text{sh } \Omega = \sqrt{\frac{-a}{u}}; \quad (1)$$

and along the jet  $APJ$ ,  $\infty > u = ae^{m\phi/c} > a$ ,

$$\text{sh } \Omega = i \sin \theta = i \sqrt{\frac{a}{u}} = ie^{-1/n\phi/c}, \quad (2)$$

$$PM = \int_0^{\infty} \sin \theta ds = \int_0^{\infty} e^{-1/n\phi/c} ds = \frac{c}{\pi} \int_0^{\infty} e^{-1/n\phi/c} ds = \frac{c}{\pi} \sin \theta. \quad (3)$$

so that  $PT = c/\lambda x$ , and the curve  $AP'$  is the tractrix; and the coefficient of contraction, or

$$\frac{\text{breadth of the jet}}{\text{breadth of the orifice}} = \frac{\pi}{\pi+2} \quad (4)$$

A change of  $\Omega$  and  $\theta$  into  $n\Omega$  and  $n\theta$  will give the solution for two walls converging symmetrically to the orifice  $AA_1$  at an angle  $\pi/n$ . With  $n=1/2$ , the re-entrant walls are given of Borda's mouthpiece, and the coefficient of contraction becomes  $1/2$ . Generally, by making  $a' = -\infty$ , the line  $x'A'$  may be taken as a straight stream line of infinite length, forming an axis of symmetry; and then by duplication the result can be obtained, with assigned  $n$ ,  $a$ , and  $b$ , of the efflux from a symmetrical converging

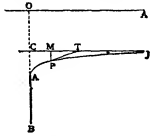

FIG. 5.



FIG. 6.

mouthpiece, or of the flow of water through the arches of a bridge, with wedge-shaped piers to divide the stream.

42 Other arrangements of the constants  $n$ ,  $a$ ,  $b$ ,  $a'$  will give the results of special problems considered by J. M. Michell, *Phil. Trans.* 1890.

Thus with  $a' = 0$ , a stream is split symmetrically by a wedge of angle  $\pi/n$  as in Bolyeff's problem; and, by making  $a = \infty$ , the wedge extends to infinity; then

$$\text{ch } n\Omega = \sqrt{\frac{b}{b-u}}, \text{ sh } n\Omega = \sqrt{\frac{u}{b-u}} \quad (1)$$

Over the jet surface  $\psi = m$ ,  $q = Q$ ,  
 $u = -c^{2n}/m = -be^{2n\Omega/c}$ ,

$$\text{ch } \Omega = \cos n\theta = \sqrt{\frac{1}{e^{2n\Omega/c} + 1}}, \text{ sh } \Omega = i \sin n\theta = i \sqrt{\frac{e^{2n\Omega/c}}{e^{2n\Omega/c} + 1}}, \quad (2)$$

$$e^{2n\Omega/c} = \tan n\theta, \frac{1}{2} \pi \frac{ds}{c} = \frac{2n}{\sin 2n\theta} \quad (3)$$

For a jet impinging normally on an infinite plane, as in fig. 6,  $n = 1$ ,

$$e^{2\Omega/c} = \tan \theta, \text{ ch } (\frac{1}{2}\pi/c) \sin 2\theta = 1, \quad (4)$$

$$\text{sh } \frac{1}{2}\pi x/c = \cot \theta, \text{ sh } \frac{1}{2}\pi y/c = \tan \theta, \quad (5)$$

$$\text{sh } \frac{1}{2}\pi x/c \text{ sh } \frac{1}{2}\pi y/c = 1, \text{ e}^{i\pi(x+iy)/c} = e^{i\pi x/c} + e^{i\pi y/c} + 1. \quad (5)$$

With  $n=1/2$ , the jet is, reversed in direction, and the profile is the catenary of equal strength.

In Bolyeff's problem of the wedge of finite breadth,

$$\text{ch } n\Omega = \sqrt{\frac{b}{a}} \sqrt{\frac{u-a}{u-b}}, \text{ sh } n\Omega = \sqrt{\frac{b-a}{a}} \sqrt{\frac{u}{u-b}}, \quad (6)$$

$$\cos n\alpha = \sqrt{\frac{b}{a}}, \sin n\alpha = \sqrt{\frac{a-b}{a}}, \quad (7)$$

and along the free surface  $APJ$ ,  $q = Q$ ,  $\psi = 0$ ,  $u = -c^{2n}/m = ae^{2n\Omega/c}$ ,

$$\cos n\theta = \cos n\alpha \sqrt{\frac{e^{2n\Omega/c} - 1}{e^{2n\Omega/c} - \cos^2 n\alpha}}, \quad (8)$$

$$e^{2n\Omega/c} = \frac{\cos^2 n\alpha \sin^2 n\theta}{\sin^2 n\theta - \sin^2 n\alpha} \quad (8)$$

the intrinsic equation, the other free surface  $A'P'J'$  being given by

$$e^{2n\Omega/c} = \frac{\cos^2 n\alpha \sin^2 n\theta}{\sin^2 n\theta - \sin^2 n\alpha} \quad (9)$$

Putting  $n=1$  gives the case of a stream of finite breadth disturbed by a transverse plane, a particular case of Fig. 7.

When  $a=b$ ,  $a=0$ , and the stream is very broad compared with the wedge or lamina; so, putting  $w = w'(a-b)/a$  in the penultimate case, and

$$u = ae^{2\Omega/c} \approx a - (a-b)w', \quad (10)$$

$$\text{ch } n\Omega = \sqrt{\frac{w'+1}{w'}}, \text{ sh } n\Omega = \sqrt{\frac{1}{w'}} \quad (11)$$

in which we may write

$$w' = \phi + \psi, \quad (12)$$

Along the stream line  $xABP$ ,  $\psi = 0$ ; and along the jet surface  $APJ$ ,  $-1 < \phi < -\infty$ ; and putting  $\phi = -\pi x/c - 1$ , the intrinsic equation is

$$\pi x/c = \cot^2 n\theta, \quad (13)$$

which for  $n=1$  is the evolute of a catenary.

43. When the barrier  $AA'$  is held oblique to the current, the stream line  $xB$  is curved to the branch point  $B$  on  $AA'$  (fig. 7), and so must be excluded from the boundary of  $u$ ; the conformal representation is made now with

$$\frac{d\Omega}{d\omega} = \frac{\sqrt{(b-a)(b-a')}}{(u-b)\sqrt{(u-a)(u-a')}} \quad (1)$$

$$\frac{d\psi}{d\omega} = \frac{-m}{\pi u - j} = \frac{-m'}{\pi u - j'}$$

$$= \frac{m+m'}{\pi} \frac{u-b}{u-j, u-j'}$$

$$b = \frac{m'j+m'j'}{m+m'}, \quad (2)$$

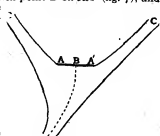

FIG. 7.

taking  $u = \infty$  at the source where  $B = u=j, j'$  at the end of the two diverging streams where  $\phi = -\infty$ ; while  $\psi = 0$  along the stream  $\psi = 0$  along the stream through  $A, A'$ ; and  $\psi = m - m'$  along the outside boundaries, so that  $m/Q, m'/Q$  is the final breadth of the jets, and  $(m+m')/Q$  is the initial breadth,  $c$ , of the impinging stream. Then

$$\text{ch } \frac{1}{2}\Omega = \sqrt{\frac{b-a'}{a-a'}} \sqrt{\frac{u-a}{u-b}}, \text{ sh } \frac{1}{2}\Omega = \sqrt{\frac{b-a}{a-a'}} \sqrt{\frac{u-a'}{u-b}}, \quad (3)$$

$$\text{ch } \Omega = \frac{2b-a-a'}{a-a'}, \frac{N}{u-b},$$

$$\text{sh } \Omega = \sqrt{N} \sqrt{\frac{2-a-u, u-a'}{u-b}},$$

$$N = 2 \frac{a-b, b-a'}{a-a'}, \quad (4)$$

Along a jet surface,  $q = Q$ , and

$$\text{ch } \Omega \cos \theta = \cos a - \frac{1}{2} \sin^2 a (a-a')/(u-b), \quad (5)$$

if  $\theta = a$  at the source  $x$  of the jet  $xB$ , where  $u = \infty$ ; and supposing  $\theta = \beta, \beta'$  at the end of the streams where  $u = j, j'$ ,

$$\frac{a-a'}{a-a} = \frac{\frac{1}{2} \sin^2 a}{\cos a - \cos \theta'} = \frac{u-j}{\cos a - \cos \theta'} = \frac{1}{2} \sin^2 a \frac{\cos \theta - \cos \beta}{(\cos a - \cos \beta)(\cos a - \cos \theta')}$$

$$\frac{u-j'}{a-a} = \frac{1}{2} \sin^2 a \frac{\cos \theta - \cos \beta'}{(\cos a - \cos \beta')(\cos a - \cos \theta')}$$

and  $\psi$  being constant along a stream line

$$\frac{d\phi}{d\omega} = \frac{d\psi}{d\omega} = \frac{d\phi}{d\omega} = \frac{d\psi}{d\omega} = \frac{d\phi}{d\omega} = \frac{d\psi}{d\omega}$$

$$= \frac{\pi Q}{m+m'} \frac{ds}{d\omega} = \frac{\pi ds}{c} \frac{d\Omega}{d\omega} = \frac{\pi ds}{c} \frac{d\Omega}{d\omega} = \frac{\pi ds}{c} \frac{d\Omega}{d\omega} = \frac{\pi ds}{c} \frac{d\Omega}{d\omega}$$

$$= \frac{\sin \theta}{\cos a - \cos \theta} + \frac{\cos a - \cos \beta'}{\cos \beta - \cos \beta'} \cdot \frac{\sin \theta}{\cos \theta - \cos \beta}$$

$$= \frac{\cos a - \cos \beta}{\cos \beta - \cos \beta'} \cdot \frac{\sin \theta}{\cos \theta - \cos \beta}$$

giving the intrinsic equation of the surface of a jet, with proper attention to the sign.

From  $A$  to  $B$ ,  $a > u > b, \theta = 0$ ,

$$\text{ch } \Omega = \text{ch } \log \frac{Q}{m} = \cos a - \frac{1}{2} \sin^2 a \frac{a-a'}{a-b}$$

$$\text{sh } \Omega = \text{sh } \log \frac{Q}{m} = \frac{\sqrt{(a-u)(u-a')}}{u-b} \sin a$$

$$\frac{Q}{m} = \frac{Q}{m} \cos a - \frac{1}{2} (a-a') \frac{\sin^2 a + \sqrt{(a-u)(u-a')}}{u-b} \sin a \quad (8)$$

$$Q \frac{ds}{d\omega} = Q \frac{ds}{d\omega} \frac{d\phi}{d\omega} = \frac{Q}{q} \frac{d\psi}{d\omega}$$

$$= \frac{m+m'}{\pi} \frac{(u-b) \cos a - \frac{1}{2} (a-a') \sin^2 a + \sqrt{(a-u)(u-a')}}{j-u, u-j'} \sin a \quad (9)$$

$$\frac{AB}{c} = \int_b^a \frac{(2b-a-a')(u-b) - 2(a-b)(b-a') + 2\sqrt{(a-b)(b-a')(a-u)(u-a')}}{a-a'} du, \quad (10)$$

with a similar expression for  $BA'$ .

The motion of a jet impinging on an infinite barrier is obtained by putting  $j = a, j' = a'$ ; duplicated on the other side of the barrier, the motion reversed will represent the direct collision of two jets of unequal breadth and equal velocity. When the barrier is small compared with the jet,  $a = \beta = \beta'$ , and G. Kirchhoff's solution is obtained of a barrier placed obliquely in an infinite stream.

Two corners  $B_1$  and  $B_2$  in the wall  $xA$ , with  $a' = -\infty$ , and  $n=1$ , will give the solution, by duplication, of a jet issuing by a reentrant mouthpiece placed symmetrically in the end wall of the channel; or else of the channel blocked partially by a diaphragm across the middle, with edges turned back symmetrically, problems discussed by J. H. Michell, A. E. H. Love and M. Réthy.

When the polygon is closed by the walls joining, instead of reaching back to infinity at  $xx'$ , the liquid motion must be due to a source, and this modification has been worked out by B. Hopkinson in the *Proc. Lond. Math. Soc.*, 1898.

Miceli has discussed also the hollow vortex stationary inside a polygon (*Phil. Trans.*, 1890); the solution is given by

$$\text{ch } n\Omega = \text{sn } w, \text{ sh } n\Omega = \text{cn } w \quad (11)$$

so that, round the boundary of the polygon,  $\psi = K', \sin n\theta = 0$ ; and on the surface of the vortex  $\psi = 0, q = Q$ , and

$$\cos n\theta = \text{sn } \phi, n\theta = \frac{1}{2}\pi - \text{am } z/c, \quad (12)$$

the intrinsic equation of the curve.

This is a closed Sumner line for  $n=1$ , when the boundary consists of two parallel walls; and  $n=\frac{1}{2}$  gives an Elastic.

44. *The Motion of a Solid through a Liquid.*—An important problem in the motion of a liquid is the determination of the state of velocity set up by the passage of a solid through it; and hence of the pressure and reaction of the liquid on the surface of the solid, by which its motion is influenced when it is free.

Beginning with a single body in liquid extending to infinity; and denoting by  $U, V, W, P, Q, R$  the components of linear and angular velocity with respect to axes fixed in the body, the velocity function takes the form

$$\phi = U\phi_1 + V\phi_2 + W\phi_3 + P\chi_1 + Q\chi_2 + R\chi_3, \quad (1)$$

where the  $\phi$ 's and  $\chi$ 's are functions of  $x, y, z$ , depending on the shape of the body; interpreted dynamically,  $C - \rho\phi$  represents the impulsive pressure required to stop the motion, or  $C + \rho\phi$  to start it again from rest.

The terms of  $\phi$  may be determined one at a time, and this problem is purely kinematical; thus to determine  $\phi_1$ , the component  $U$  alone is taken to exist, and then  $l, m, n$ , denoting the direction cosines of the normal of the surface drawn into the exterior liquid, the function  $\phi_1$  must be determined to satisfy the conditions

(i.)  $\nabla^2\phi_1 = 0$ , throughout the liquid;

(ii.)  $\frac{d\phi_1}{dn} = -l$ , the gradient of  $\phi_1$  down the normal at the surface of the moving solid;

(iii.)  $\frac{d\phi_1}{dn} = 0$ , over a fixed boundary, or at infinity; similarly for  $\phi_2$  and  $\phi_3$ .

To determine  $\chi_1$  the angular velocity  $P$  alone is introduced, and the conditions to be satisfied are

(i.)  $\nabla^2\chi_1 = 0$ , throughout the liquid;

(ii.)  $\frac{d\chi_1}{dn} = mz - ny$ , at the surface of the moving body, but zero over a fixed surface, and at infinity; the same for  $\chi_2$  and  $\chi_3$ .

For a cavity filled with liquid in the interior of the body, since the liquid inside moves bodily for a motion of translation only,

$$\phi_1 = -x, \phi_2 = -y, \phi_3 = -z; \quad (2)$$

but a rotation will stir up the liquid in the cavity, so that the  $\chi$ 's depend on the shape of the surface.

The ellipsoid was the shape first worked out, by George Green, in his *Research on the Vibration of a Pendulum in a Fluid Medium* (1833); the extension to any other surface will form an important step in this subject.

A system of confocal ellipsoids is taken

$$\frac{x^2}{a^2+\lambda} + \frac{y^2}{b^2+\lambda} + \frac{z^2}{c^2+\lambda} = 1, \quad (3)$$

and a velocity function of the form

$$\phi = \psi\lambda, \quad (4)$$

where  $\psi$  is a function of  $\lambda$  only; so that  $\psi$  is constant over an ellipsoid; and we seek to determine the motion set up, and the form of  $\psi$  which will satisfy the equation of continuity.

Over the ellipsoid,  $\beta$  denoting the length of the perpendicular from the centre on a tangent plane,

$$l = \frac{\beta x}{a^2+\lambda}, \quad m = \frac{\beta y}{b^2+\lambda}, \quad n = \frac{\beta z}{c^2+\lambda} \quad (5)$$

$$1 = \frac{\beta^2 x^2}{(a^2+\lambda)^2} + \frac{\beta^2 y^2}{(b^2+\lambda)^2} + \frac{\beta^2 z^2}{(c^2+\lambda)^2} \quad (6)$$

$$\beta^2 = (a^2+\lambda)^2 P + (b^2+\lambda)^2 m^2 + (c^2+\lambda)^2 n^2, \quad (7)$$

$$= a^2 P^2 + b^2 m^2 + c^2 n^2 + \lambda,$$

$$2\beta \frac{d\beta}{d\lambda} = \frac{d\lambda}{d\lambda}; \quad (8)$$

Thence

$$\frac{d\phi}{d\lambda} = \frac{dx}{d\lambda}\psi + \frac{d\psi}{d\lambda}$$

$$= \frac{dx}{d\lambda}\psi + 2(a^2+\lambda)\frac{d\psi}{d\lambda}\frac{\beta}{\beta} \quad (9)$$

so that the velocity of the liquid may be resolved into a component  $-\psi$  parallel to  $Ox$ , and  $-2(a^2+\lambda)d\psi/d\lambda$  along the normal of the

ellipsoid; and the liquid flows over an ellipsoid along a line of slope with respect to  $Ox$ , treated as the vertical.

Along the normal itself

$$\frac{d\phi}{d\lambda} = \left\{ \psi + 2(a^2+\lambda)\frac{d\psi}{d\lambda} \right\} l, \quad (10)$$

so that over the surface of an ellipsoid where  $\lambda$  and  $\psi$  are constant, the normal velocity is the same as that of the ellipsoid itself, moving as a solid with velocity parallel to  $Ox$

$$U = -\psi - 2(a^2+\lambda)\frac{d\psi}{d\lambda}, \quad (11)$$

and so the boundary condition is satisfied; moreover, any ellipsoidal surface  $\lambda$  may be supposed moving as if rigid with the velocity in (11), without disturbing the liquid motion for the moment.

The continuity is secured if the liquid between two ellipsoids  $\lambda$  and  $\lambda_1$ , moving with the velocity  $U$  and  $U_1$  of equation (11), is squeezed out or sucked in across the plane  $x=0$  at a rate equal to the integral flow of the velocity  $\psi$  across the annular area  $a_1 - a$  of the two ellipsoids made by  $x=0$ ; or if

$$aU - a_1U_1 = \int_{\lambda}^{\lambda_1} \psi \frac{da}{d\lambda}, \quad (12)$$

$$a = \pi\sqrt{(b^2+\lambda)(c^2+\lambda)}. \quad (13)$$

Expressed as a differential relation, with the value of  $U$  from (11).

$$\frac{d}{d\lambda} \left[ a\psi + 2(a^2+\lambda) \frac{d\psi}{d\lambda} \right] - \frac{da}{d\lambda} = 0, \quad (14)$$

$$3a \frac{d\psi}{d\lambda} + 2(a^2+\lambda) \frac{d^2\psi}{d\lambda^2} = 0, \quad (15)$$

and integrating

$$(a^2+\lambda)^2 n \frac{d\psi}{d\lambda} = \text{a constant}, \quad (16)$$

so that we may put

$$\psi = \int \frac{M d\lambda}{(a^2+\lambda)^2}, \quad (17)$$

$$P^2 = 4(a^2+\lambda)(b^2+\lambda)(c^2+\lambda), \quad (18)$$

where  $M$  denotes a constant; so that  $\psi$  is an elliptic integral of the second kind.

The quiescent ellipsoidal surface, over which the motion is entirely tangential; is the one for which

$$2(a^2+\lambda)\frac{d\psi}{d\lambda} + \psi = 0, \quad (19)$$

and this is the infinite boundary ellipsoid if we make the upper limit  $\lambda = \infty$ .

The velocity of the ellipsoid defined by  $\lambda = 0$  is then

$$U = -2a^2 \frac{d\psi}{d\lambda} - \psi_0$$

$$= \frac{M}{abc} - \int_0^{\infty} \frac{M d\lambda}{(a^2+\lambda)^2}$$

$$= \frac{M}{abc} (1 - A_0), \quad (20)$$

with the notation

$$A \text{ or } A_\lambda = \int_{\lambda}^{\infty} \frac{abc d\lambda}{(a^2+\lambda)^2}$$

$$= -2abc \frac{d}{d\lambda} \int_{\lambda}^{\infty} \frac{d\lambda}{\lambda^2}, \quad (21)$$

so that in (4)

$$\phi = \frac{M}{abc} xA = \frac{Ux}{1-A_0}, \quad \phi_1 = \frac{x A_1}{1-A_0}, \quad (22)$$

in (1) for an ellipsoid.

The impulse required to set up the motion in liquid of density  $\rho$  is the resultant of an impulsive pressure  $\rho\phi$  over the surface  $S$  of the ellipsoid, and is therefore

$$\iint \rho\phi dS = \rho\psi_0 \iint \psi dS$$

$$= \rho\psi_0 (\text{volume of the ellipsoid}) = \psi_0 W', \quad (23)$$

where  $W'$  denotes the weight of liquid displaced.

Denoting the effective inertia of the liquid parallel to  $Ox$  by  $aW'$ , the momentum

$$aW'U = \psi_0 W' \quad (24)$$

$$a = \frac{\psi_0}{U} = \frac{A_0}{1-A_0}; \quad (25)$$

in this way the air drag was calculated by Green for an ellipsoidal pendulum.

Similarly, the inertia parallel to  $Oy$  and  $Oz$  is

$$\beta W' = \frac{B_0}{1-B_0} W', \quad \gamma W' = \frac{C_0}{1-C_0} W', \quad (26)$$

$$B_\lambda, C_\lambda = \int_{\lambda}^{\infty} \frac{abc d\lambda}{(b^2+\lambda)(c^2+\lambda)}; \quad (27)$$

and

$$A+B+C = abc \frac{1}{2} P, \quad A_0+B_0+C_0 = 1. \quad (28)$$

For a sphere

$$a = b = c, \quad A_0 = B_0 = C_0 = \frac{1}{2}, \quad a = \beta = \gamma = \frac{1}{2}. \quad (29)$$

so that the effective inertia of a sphere is increased by half the weight of liquid displaced; and in frictionless air or liquid the sphere, of weight  $W$ , will describe a parabola with vertical acceleration

$$\frac{W - W'}{W + \frac{1}{2}W'} \quad (30)$$

Thus a spherical air bubble, in which  $W/W'$  is insensible, will begin to rise in water with acceleration  $2g$ .

45. When the liquid is bounded externally by the fixed ellipsoid  $\lambda = \lambda_1$ , a slight extension will give the velocity function  $\phi$  of the liquid in the interspace as the ellipsoid  $\lambda = 0$  is passing with velocity  $U$  through the confocal position;  $\phi$  must now take the form  $\lambda(\psi + N)$ , and will satisfy the conditions in the shape

$$\phi = Ux \frac{A + B_1 + C_1}{B_0 + C_0 - B_1 - C_1} = Ux \frac{abc}{a_1 b_1 c_1} + \int_{\lambda_1}^{\lambda} \frac{abcd\lambda}{a^2(\lambda^2 + \lambda)} P \quad (1)$$

and any confocal ellipsoid defined by  $\lambda_1$  internal or external to  $\lambda = \lambda_1$ , may be supposed to swim with the liquid for an instant, without distortion or rotation, with velocity along  $Ox$

$$U \frac{B_1 + C_1 - B_1 - C_1}{B_0 + C_0 - B_1 - C_1}$$

Since  $-Ux$  is the velocity function for the liquid  $W'$  filling the ellipsoid  $\lambda = 0$ , and moving bodily with it, the effective inertia of the liquid in the interspace is

$$\frac{A_0 + B_1 + C_1}{B_0 + C_0 - B_1 - C_1} W' \quad (2)$$

If the ellipsoid is of revolution, with  $b = c$ ,

$$\phi = \frac{1}{2} Ux \frac{A + 2B_1}{B_0 - B_1} \quad (3)$$

and the Stokes' current function  $\psi$  can be written down

$$\psi = -\frac{1}{2} U y^2 \frac{B - B_1}{B_0 - B_1} \quad (4)$$

reducing, when the liquid extends to infinity and  $B_1 = 0$ , to

$$\phi = \frac{1}{2} Ux \frac{A}{B_0}, \quad \psi = -\frac{1}{2} U y \frac{B}{B_0} \quad (5)$$

so that in the relative motion past the body, as when fixed in the current  $U$  parallel to  $Ox$ ,

$$\phi' = \frac{1}{2} Ux \left(1 + \frac{A}{B_0}\right), \quad \psi' = \frac{1}{2} U y^2 \left(1 - \frac{B}{B_0}\right) \quad (6)$$

Changing the origin from the centre to the focus of a prolate spheroid, then putting  $b^2 = pa$ ,  $\lambda = \lambda'a$ , and proceeding to the limit where  $a = \infty$ , we find for a paraboloid of revolution

$$B = \frac{1}{2} \frac{p}{p + \lambda'}, \quad B_0 = \frac{p}{p + \lambda'} \quad (7)$$

$$\frac{y^2}{p + \lambda'} = p + \lambda' - 2x, \quad (8)$$

with  $\lambda' = 0$  over the surface of the paraboloid; and then

$$\phi' = \frac{1}{2} U [y^2 - p \sqrt{(x^2 + y^2)} + px]; \quad (9)$$

$$\psi' = -\frac{1}{2} U p \sqrt{(x^2 + y^2)} - x; \quad (10)$$

$$\phi = -\frac{1}{2} U p \log \sqrt{(x^2 + y^2)} + x. \quad (11)$$

The relative path of a liquid particle is along a stream line

$$\psi' = \frac{1}{2} U c^2, \text{ a constant,} \quad (12)$$

$$x = \frac{b^2 y^2 - (y^2 - c^2)^2}{2p(y^2 - c^2)}, \quad \sqrt{(x^2 + y^2)} = \frac{b^2 y^2 + (y^2 - c^2)^2}{2p(y^2 - c^2)} \quad (13)$$

a  $C_4$ ; while the absolute path of a particle in space will be given by

$$\frac{dy}{dx} = \frac{r - x}{y} = \frac{y^2 - c^2}{2py}, \quad (14)$$

$$y^2 - c^2 = a^2 e^{-2p}, \quad (15)$$

46. Between two concentric spheres, with

$$a^2 + \lambda = r^2, \quad a^2 + \lambda_1 = a_1^2, \quad (1)$$

$$A = B = C = a^2/3a^2, \quad (1)$$

$$\phi = \frac{1}{2} Ux \frac{a^2}{1 - a^2/a_1^2}, \quad \psi = \frac{1}{2} U y \frac{a^2}{1 - a^2/a_1^2} \quad (2)$$

and the effective inertia of the liquid in the interspace is

$$\frac{A_0 + 2A_1}{2A_0 - 2A_1} W' = \frac{1}{2} \frac{a_1^3 + 2a^3}{a_1^3 - a^3} W' \quad (3)$$

When the spheres are not concentric, an expression for the effective inertia can be found by the method of images (W. M. Hicks, *Phil. Trans.*, 1880).

The image of a source of strength  $\mu$  at  $S$  outside a sphere of radius  $a$  is a source of strength  $\mu a/f$  at  $H$ , where  $OS = f$ ,  $OH = a^2/f$ , and a line sink reaching from the image  $H$  to the centre  $O$  of line strength  $-\mu/a$ ; this combination will be found to produce no flow across the surface of the sphere.

Taking  $Ox$  along  $OS$ , the Stokes' function at  $P$  for the source  $S$

is  $\mu \cos PSx$ , and of the source  $H$  and line sink  $OH$  is  $\mu(a/f) \cos PHx$  and  $-(\mu/a)(PO - PH)$ ; so that

$$\psi = \mu \left( \cos PSx + \frac{a}{f} \cos PHx - \frac{PO - PH}{a} \right), \quad (4)$$

and  $\psi = -\mu$ , a constant, over the surface of the sphere, so that there is no flow across.

When the source  $S$  is inside the sphere and  $H$  outside, the line sink must extend from  $H$  to infinity in the image system; to realize physically the condition of zero flow across the sphere, an equal sink must be introduced at some other internal point  $S'$ .

When  $S$  and  $S'$  lie on the same radius, taken along  $Ox$ , the Stokes' function can be written down; and when  $S$  and  $S'$  coalesce a doublet is produced, with a doublet image at  $H$ .

For a doublet at  $S$ , of moment  $m$ , the Stokes' function is

$$m \frac{d}{df} \cos PSx = -m \frac{a^2}{f^2} \psi; \quad (5)$$

and for its image at  $H$  the Stokes' function is

$$m \frac{d}{df} \cos PHx = m \frac{a^2}{f^2} \psi; \quad (6)$$

so that for the combination

$$\psi = m y^2 \left( \frac{a^2}{f^2} \frac{1}{PH^2} - \frac{1}{PS^2} \right) = m y^2 \left( \frac{a^2}{PH^2} - \frac{f^2}{PS^2} \right), \quad (7)$$

and this vanishes over the surface of the sphere.

There is no Stokes' function when the axis of the doublet at  $S$  does not pass through  $O$ ; the image system will consist of an inclined doublet at  $H$ , making an equal angle with  $OS$  as the doublet  $S$ , and of a parallel negative line doublet, extending from  $H$  to  $O$ , of moment varying as the distance from  $O$ .

A distribution of sources and doublets over a moving surface will enable an expression to be obtained for the velocity function of a body moving in the presence of a fixed sphere, or inside it.

The method of electrical images will enable the stream function  $\psi'$  to be inferred from a distribution of doublets, finite in number when the surface is composed of two spheres intersecting at an angle  $\pi/m$ , where  $m$  is an integer (R. A. Herman, *Quart. Jour. of Math.* xxii.).

Thus for  $m = 2$ , the spheres are orthogonal, and it can be verified that

$$\psi' = \frac{1}{2} U y^2 \left( 1 - \frac{a_1^2}{r_1^2} - \frac{a_2^2}{r_2^2} + \frac{a^2}{r^2} \right), \quad (8)$$

where  $a_1, a_2, a = a_1 a_2 / \sqrt{(a_1^2 + a_2^2)}$  is the radius of the spheres and their circle of intersection, and  $r_1, r_2, r$  the distances of a point from their centres.

The corresponding expression for two orthogonal cylinders will be

$$\psi' = U y \left( 1 - \frac{a_1^2}{r_1^2} - \frac{a_2^2}{r_2^2} + \frac{a^2}{r^2} \right). \quad (9)$$

With  $a_2 = \infty$ , these reduce to

$$\psi' = \frac{1}{2} U y^2 \left( 1 - \frac{a^2}{r^2} \right) \frac{x}{a}, \quad \text{or } U y \left( 1 - \frac{a^2}{r^2} \right) \frac{x}{a}, \quad (10)$$

for a sphere or cylinder, and a diametral plane.

Two equal spheres, intersecting at  $120^\circ$  will require

$$\psi' = \frac{1}{2} U y^2 \left[ \frac{x}{a} - \frac{a^2}{2r_1^2} + \frac{a^2(a - 2x)}{2r_1^2} + \frac{a^2}{2r_2^2} - \frac{a^2(a + 2x)}{2r_2^2} \right]. \quad (11)$$

with a similar expression for cylinders; so that the plane  $x = 0$  may be introduced as a boundary, cutting the surface at  $60^\circ$ . The motion of these cylinders across the line of centres is the equivalent of a line doublet along each axis.

47. The extension of Green's solution to a rotation of the ellipsoid was made by A. Clebsch, by taking a velocity function

$$\phi = xyx \quad (1)$$

for a rotation  $R$  about  $Oz$ ; and a similar procedure shows that an ellipsoidal surface  $\lambda$  may be in rotation about  $Oz$  without disturbing the motion if

$$R = \frac{\left( \frac{1}{a^2 + \lambda} + \frac{1}{b^2 + \lambda} \right) x^2 + 2 \frac{d^2 x}{d\lambda}}{1/(b^2 + \lambda) - 1/(a^2 + \lambda)}, \quad (2)$$

and that the continuity of the liquid is secured if

$$(a^2 + \lambda)^2 (b^2 + \lambda)^2 (c^2 + \lambda) \frac{d^2 x}{d\lambda} = \text{constant,} \quad (3)$$

$$x = \int_{\lambda}^{\infty} \frac{N d\lambda}{(a^2 + \lambda)(b^2 + \lambda)P} = \frac{N}{a^2 b^2} \frac{Bx - A\lambda}{a^2 - \lambda^2}; \quad (4)$$

and at the surface  $\lambda = 0$ ,

$$R = - \left( \frac{1}{a^2} + \frac{1}{b^2} \right) \frac{N}{abc} \frac{B_0 - A_0}{a^2 - b^2} - \frac{N}{abc} \frac{1}{1/b^2 - 1/a^2} \quad (5)$$

$$\frac{N}{abc} = R = \frac{1/b^2 - 1/a^2}{a^2 b^2} \frac{B_0 - A_0}{a^2 - b^2} \quad (6)$$

$$= R \frac{(a^2 - b^2)^2 / (a^2 + b^2)}{(a^2 - b^2)^2 / (a^2 + b^2) - (B_0 - A_0)}$$

The velocity function of the liquid inside the ellipsoid  $\lambda=0$  due to the same angular velocity will be

$$\phi_1 = Rxy(a^2 - b^2)/(a^2 + b^2), \quad (7)$$

and on the surface outside

$$\phi_2 = xy\lambda_0 = xy \frac{N(B_2 - A_2)}{a^2 - b^2}, \quad (8)$$

so that the ratio of the exterior and interior value of  $\phi$  at the surface is

$$\frac{\phi_2}{\phi_1} = \frac{B_2 - A_2}{(a^2 - b^2)/(a^2 + b^2) - (B_2 - A_2)}, \quad (9)$$

and this is the ratio of the effective angular inertia of the liquid, outside and inside the ellipsoid  $\lambda=0$ .

The extension to the case where the liquid is bounded externally by a fixed ellipsoid  $\lambda=\lambda_1$  is made in a similar manner, by putting

$$\phi = xy(x+M), \quad (10)$$

and the ratio of the effective angular inertia in (9) is changed to

$$\frac{(B_2 - A_2) - (B_1 - A_1) + \frac{a_1^2 - b_1^2}{a_1^2 + b_1^2} \frac{abc}{a_1 b_1 c_1}}{\frac{a^2 - b^2}{a^2 + b^2} \frac{a_1^2 - b_1^2}{a_1^2 + b_1^2} \frac{abc}{a_1 b_1 c_1} - (B_2 - A_2) + (B_1 - A_1)}. \quad (11)$$

Make  $\epsilon = \infty$  for confocal elliptic cylinders; and then

$$A_\lambda = \int_0^\infty \frac{ab}{(a^2 + \lambda)\sqrt{(4a^2 + \lambda)(b^2 + \lambda)}} = \frac{ab}{a^2 - b^2} \left(1 - \sqrt{\frac{b^2 + \lambda}{a^2 + \lambda}}\right), \quad (12)$$

$$B_\lambda = \frac{ab}{a^2 - b^2} \left(\sqrt{\frac{a^2 + \lambda}{b^2 + \lambda}} - 1\right), \quad C_\lambda = 0;$$

and then as above in § 31, with

$$a = c \operatorname{ch} a, \quad b = c \operatorname{sh} a, \quad a_1 = \sqrt{(a^2 + \lambda)} = c \operatorname{ch} a, \quad b_1 = c \operatorname{sh} a \quad (13)$$

the ratio in (11) agrees with § 31 (6).

As before in § 31, the rotation may be resolved into a shear-pair, in planes perpendicular to  $Ox$  and  $Oy$ .

A torsion of the ellipsoidal surface will give rise to a velocity function of the form  $\phi = xy\Omega$ , where  $\Omega$  can be expressed by the elliptic integrals  $A_\lambda, B_\lambda, C_\lambda$ , in a similar manner, since

$$\Omega = L \int_\lambda^\infty d\lambda/P^2,$$

48. The determination of the  $\phi$ 's and  $\chi$ 's is a kinematical problem, solved as yet only for a few cases, such as those discussed above.

But supposing them determined for the motion of a body through a liquid, the kinetic energy  $T$  of the system, liquid and body, is expressible as a quadratic function of the components  $U, V, W, P, Q, R$ . The partial differential coefficient of  $T$  with respect to a component of velocity, linear or angular, will be the component of momentum, linear or angular, which corresponds.

Conversely, if the kinetic energy  $T$  is expressed as a quadratic function of  $x_1, x_2, y_1, y_2, z_1, z_2$ , the components of momentum, the partial differential coefficient with respect to a momentum component will give the component of velocity to correspond.

These theorems, which hold for the motion of a single rigid body, are true generally for a flexible system, such as considered here for a liquid, with one or more rigid bodies swimming in it; and they express the statement that the work done by an impulse is the product of the impulse and the arithmetic mean of the initial and final velocity; so that the kinetic energy is the work done by the impulse in starting the motion from rest.

Thus if  $T$  is expressed as a quadratic function of  $U, V, W, P, Q, R$ , the components of momentum corresponding are

$$x_1 = \frac{dT}{dU}, \quad x_2 = \frac{dT}{dV}, \quad x_3 = \frac{dT}{dW}, \quad (1)$$

$$y_1 = \frac{dT}{dP}, \quad y_2 = \frac{dT}{dQ}, \quad y_3 = \frac{dT}{dR},$$

but when it is expressed, as a quadratic function of  $x_1, x_2, y_1, y_2, z_1, z_2$ ,

$$U = \frac{dT}{dx_1}, \quad V = \frac{dT}{dx_2}, \quad W = \frac{dT}{dx_3}, \quad (2)$$

$$P = \frac{dT}{dy_1}, \quad Q = \frac{dT}{dy_2}, \quad R = \frac{dT}{dy_3}.$$

The second system of expression was chosen by Clebsch and adopted by Halphen in his *Fonctions elliptiques*; and thence the dynamical equations follow

$$X = \frac{dx_1}{dt} - x_2 \frac{dT}{dy_1} + x_3 \frac{dT}{dy_2}, \quad Y = \dots, \quad Z = \dots, \quad (3)$$

$$L = \frac{dy_1}{dt} - \frac{dT}{dx_1} + y_2 \frac{dT}{dx_2} - \frac{dT}{dx_3} + y_3 \frac{dT}{dx_3}, \quad M = \dots, \quad N = \dots, \quad (4)$$

where  $X, Y, Z, L, M, N$  denote components of external applied force on the body.

These equations are proved by taking a line fixed in space, whose direction cosines are  $l, m, n$ , then

$$\frac{dl}{dt} = mR - nQ, \quad \frac{dm}{dt} = nP - lR, \quad \frac{dn}{dt} = lQ - mP. \quad (5)$$

If  $P$  denotes the resultant linear impulse or momentum in this direction

$$P = lx_1 + mx_2 + nx_3, \quad (6)$$

$$\frac{dP}{dt} = \frac{dl}{dt}x_1 + l \frac{dx_1}{dt} + \frac{dm}{dt}x_2 + m \frac{dx_2}{dt} + \frac{dn}{dt}x_3 + n \frac{dx_3}{dt}$$

$$= l \left( \frac{dx_1}{dt} - x_2 R + x_3 Q \right)$$

$$+ m \left( \frac{dx_2}{dt} - x_3 P + x_1 R \right)$$

$$+ n \left( \frac{dx_3}{dt} - x_1 Q + x_2 P \right)$$

$$= lX + mY + nZ, \quad (7)$$

for all values of  $l, m, n$ .

Next, taking a fixed origin  $\Omega$  and axes parallel to  $Ox, Oy, Oz$  through  $O$ , and denoting by  $x, y, z$  the coordinates of  $O$ , and by  $G$  the component angular momentum about  $\Omega$  in the direction  $(l, m, n)$

$$G = l(y_2 - x_2 z_2 + x_2 y_2) + m(y_3 - x_3 z_3 + x_3 y_3) + n(y_1 - x_1 z_1 + x_1 y_1). \quad (8)$$

Differentiating with respect to  $t$ , and afterwards moving the fixed origin up to the moving origin  $O$ , so that

$$x = y = z = 0, \quad \text{but} \quad \frac{dx}{dt} = U, \quad \frac{dy}{dt} = V, \quad \frac{dz}{dt} = W,$$

$$\frac{dG}{dt} = l \left( \frac{dy_2}{dt} - y_2 R + y_2 Q - x_2 W + x_2 V \right)$$

$$+ m \left( \frac{dy_3}{dt} - y_3 P + y_3 R - x_3 U + x_3 W \right)$$

$$+ n \left( \frac{dy_1}{dt} - y_1 Q + y_1 P - x_1 V + x_1 U \right)$$

$$= lL + mM + nN, \quad (9)$$

for all values of  $l, m, n$ .

When no external force acts, the case which we shall consider, there are three integrals of the equations of motion

- (i)  $T = \text{constant}$
- (ii)  $x_1^2 + x_2^2 + x_3^2 = F^2$ , a constant,
- (iii)  $x_1 y_1 + x_2 y_2 + x_3 y_3 = \eta = GF$ , a constant;

and the dynamical equations in (3) express the fact that  $x_1, x_2, x_3$  are the components of a constant vector having a fixed direction; while (4) shows that the vector resultant of  $y_1, y_2, y_3$  moves as if subject to a couple of components

$$x_3 W - x_2 V, \quad x_2 U - x_1 W, \quad x_1 V - x_3 U, \quad (10)$$

and the resultant couple is therefore perpendicular to  $F$ , the resultant of  $x_1, x_2, x_3$ , so that the component along  $OF$  is constant, as expressed by (iii).

If a fourth integral is obtainable, the solution is reducible to a quadrature, but this is not possible except in a limited series of cases, investigated by H. Weber, F. Kötter, R. Liouville, Caspari, Jukovskii, Liapounoff, Kolossoff and others, chiefly Russian mathematicians; and the general solution requires the double-theta hyperelliptic function.

49. In the motion which can be solved by the elliptic function, the most general expression of the kinetic energy was shown by A. Clebsch to take the form

$$T = \frac{1}{2} p(x_1^2 + x_2^2) + \frac{1}{2} q x_3^2 + q(x_1 y_1 + x_2 y_2) + q' x_3 y_3 + \frac{1}{2} r(y_1^2 + y_2^2) + \frac{1}{2} r' y_3^2, \quad (1)$$

so that a fourth integral is given by

$$dy_1/dt = 0, \quad y_2 = \text{constant}; \quad (2)$$

$$\frac{dx_3}{dt} = x_1(gx_2 + ry_2) - x_2(gx_1 + ry_1) = r(x_1 y_2 - x_2 y_1), \quad (3)$$

$$\frac{1}{r^2} \left( \frac{dx_3}{dt} \right)^2 = (x_1^2 + x_2^2)(y_1^2 + y_2^2) - (x_1 y_1 + x_2 y_2)^2$$

$$= (x_1^2 + x_2^2)(y_1^2 + y_2^2) - (FG - x_3 y_3)^2 = (x_1^2 + x_2^2)(y_1^2 + y_2^2 + y_3^2 - G^2) - (Gx_3 - Fy_3)^2, \quad (4)$$

in which

$$x_1^2 + x_2^2 = F^2 - x_3^2, \quad x_1 y_1 + x_2 y_2 = FG - x_3 y_3, \quad (5)$$

$$r(y_1^2 + y_2^2) = 2T - p(x_1^2 + x_2^2) - p' x_3^2 - 2q(x_1 y_1 + x_2 y_2) - 2q' x_3 y_3 - r' y_3^2$$

$$= (q - p') x_1^2 + 2(q - q') x_1 x_2 + m_1, \quad (6)$$

so that

$$m_1 = 2T - pF^2 - 2qFG - r' y_3^2 \quad (7)$$

$$\frac{1}{r^2} \left( \frac{dx_3}{dt} \right)^2 = X_2, \quad (8)$$

where  $X_2$  is a quartic function of  $x_3$ , and thus  $t$  is given by an elliptic



integral of the first kind; and by inversion  $x_2$  is in elliptic function of the time  $t$ . Now

$$(x_1 - x_2i)(y_1 + y_2i) = \frac{x_1y_1 + x_2y_2 + i(x_1y_2 - x_2y_1)}{FG - x_1y_2 + i\sqrt{X_2}} \quad (9)$$

$$\frac{y_1 + y_2i}{x_1 + x_2i} = \frac{FG - x_1y_2 + i\sqrt{X_2}}{x_1^2 + x_2^2} \quad (10)$$

$$\frac{d}{dt}(x_1 + x_2i) = -i[(q' - g)x_1 + r'y_2] + irx_2(y_1 + y_2i), \quad (11)$$

$$\frac{d}{dt} \log(x_1 + x_2i) = -(q' - g)x_1 - r'y_2 + rx_2 \frac{FG - x_1y_2 + i\sqrt{X_2}}{F^2 - x_1^2} \quad (12)$$

$$\frac{d}{dt} \log \sqrt{\frac{x_1 + x_2i}{x_1 - x_2i}} = -(q' - g)x_1 - (r' - r)y_2 - rF \frac{Fy_2 - Gx_2}{F^2 - x_2^2} \quad (13)$$

requiring the elliptic integral of the third kind; thence the expression of  $x_1 - x_2i$  and  $y_1 + y_2i$ .

Introducing Euler's angles  $\theta, \phi, \psi,$

$$x_1 = F \sin \theta \sin \phi, \quad x_2 = F \sin \theta \cos \phi, \\ x_1 + x_2i = iF \sin \theta e^{-i\psi}, \quad x_1 - x_2i = F \cos \theta; \quad (14)$$

$$\sin \theta \frac{d\psi}{dt} = P \sin \phi + Q \cos \phi, \quad (15)$$

$$F \sin^2 \theta \frac{d\psi}{dt} = \frac{dT}{dy_1} x_1 + \frac{dT}{dy_2} x_2$$

$$= (gx_1 + ry_1)x_1 + (gx_2 + ry_2)x_2 \\ = g(x_1^2 + x_2^2) + r(x_1y_1 + x_2y_2) \\ = gF^2 \sin^2 \theta + r(FG - x_1y_2), \quad (16)$$

$$\psi - gFt = \int \frac{FG - x_1y_2 + rdx_2}{\sqrt{F^2 - x_1^2} \sqrt{X_2}} \quad (17)$$

elliptic integrals of the third kind.

Employing G. Kirchhoff's expressions for X, Y, Z, the coordinates of the centre of the body,

$$FX = y_1 \cos \overline{XX} + y_2 \cos \overline{YY} + y_3 \cos \overline{ZZ}, \quad (18)$$

$$FY = -y_1 \cos \overline{XY} + y_2 \cos \overline{YX} + y_3 \cos \overline{XZ}, \quad (19)$$

$$G = y_1 \cos \overline{XZ} + y_2 \cos \overline{YZ} + y_3 \cos \overline{ZZ}, \quad (20)$$

$$F^2(X^2 + Y^2) = y_1^2 + y_2^2 + y_3^2 - G^2, \quad (21)$$

$$F(X + Yi) = \frac{Fy_2 - Gx_2 + i\sqrt{X_2}}{\sqrt{F^2 - x_1^2}} e^{i\psi}. \quad (22)$$

Suppose  $x_1 - F$  is a repeated factor of  $X_2$ , then  $y_2 = G$ , and

$$X_2 = (x_1 - F)^2 \left[ \frac{b'}{r} - \frac{b}{r}(x_1 + F) + 2 \frac{g'}{r} - gG(x_1 + F) - G^2 \right], \quad (23)$$

and putting  $x_1 - F = y$ ,

$$\left(\frac{dy}{dt}\right)^2 = r^2 y^6 \left[ 4 \frac{b'}{r} - \frac{b}{r} F^2 + 4 \frac{g'}{r} - gFG - G^2 \right. \\ \left. + 2 \left( 2 \frac{b'}{r} - \frac{b}{r} F + \frac{g'}{r} - gG \right) y + \frac{b'}{r} - \frac{b}{r} y \right], \quad (24)$$

so that the stability of this axial movement is secured if

$$A = 4 \frac{b'}{r} - \frac{b}{r} F^2 + 4 \frac{g'}{r} - gFG - G^2 \quad (25)$$

is negative, and then the axis makes  $r\sqrt{-A}$  nutations per second. Otherwise, if A is positive

$$r = \int \frac{dy}{\sqrt{y(A + 2By + Cy^2)}} \\ = \frac{1}{\sqrt{A}} \operatorname{sh}^{-1} \frac{\sqrt{A(A + 2By + Cy^2)}}{y\sqrt{B^2 - AC}} = \frac{1}{\sqrt{A}} \operatorname{ch}^{-1} \frac{A + By}{y\sqrt{B^2 - AC}}. \quad (26)$$

and the axis falls away ultimately from its original direction.

A number of cases are worked out in the *American Journal of Mathematics* (1907), in which the motion is made algebraic by the use of the pseudo-elliptic integral. To give a simple instance, changing to the stereographic projection by putting  $\tan \frac{1}{2}\theta = x$ ,

$$(Nxe^{i\psi})^2 n = (x + 1)\sqrt{X_1} + i(x - 1)\sqrt{X_2}, \quad (27)$$

$$X_1 = ax^4 + 2ax^2 + 3(a + b)x^2 + 2bx + b, \quad (28)$$

$$N^2 = -8(a + b), \quad (29)$$

will give a possible state of motion of the axis of the body; and the motion of the centre may then be inferred from (22).

50. The theory preceding is of practical application in the investigation of the stability of the axial motion of a submarine boat, of the elongated gas bag of an airship, or of a spinning rifled projectile. In the steady motion under no force of such a body in a medium, the centre of gravity describes a helix, while the axis describes a cone round the direction of motion of the centre of gravity, and the couple causing precession is due to the displacement of the medium.

In the absence of a medium the inertia of the body to translation is the same in all directions, and is measured by the

weight W, and under no force the C.G. proceeds in a straight line, and the axis of rotation through the C.G. preserves its original direction, if a principal axis of the body; otherwise the axis describes a cone, right circular if the body has uniaxial symmetry, and a Poinsot cone in the general case.

But the presence of the medium makes the effective inertia depend on the direction of motion with respect to the external shape of the body, and on W' the weight of fluid medium displaced.

Consider, for example, a submarine boat under water; the inertia is different for axial and broadside motion, and may be represented by

$$c_1 = W + W'a, \quad c_2 = W + W'\beta, \quad (1)$$

where  $a, \beta$  are numerical factors depending on the external shape; and if the C.G. is moving with velocity V at an angle  $\phi$  with the axis, so that the axial and broadside component of velocity is  $u = V \cos \phi, v = V \sin \phi$ , the total momentum F of the medium, represented by the vector OF at an angle  $\theta$  with the axis, will have components, expressed in sec. lb,

$$F \cos \theta = c_1 \frac{u}{g} = (W + W'a) \frac{V \cos \phi}{g}, \quad F \sin \theta = c_2 \frac{v}{g} = (W + W'\beta) \frac{V \sin \phi}{g}. \quad (2)$$

Suppose the body is kept from turning as it advances; after  $t$  seconds the C.G. will have moved from O to O', where OO' = Vt; and at O' the momentum is the same in magnitude as before, but its vector is displaced from OF to O'F'.

For the body alone the resultant of the components of momentum

$$\frac{W}{g} V \cos \phi \text{ and } \frac{W'}{g} V \sin \phi \text{ is } W \frac{V}{g} \sec. \text{ lb.} \quad (3)$$

acting along OO', and so is unaltered.

But the change of the resultant momentum F of the medium as well as of the body from the vector OF to O'F' requires an impulse couple, tending to increase the angle FOO', of magnitude, in sec. foot-pounds

$$F \cdot OO' \cdot \sin FOO' = FVt \sin(\theta - \phi), \quad (4)$$

equivalent to an incessant couple

$$N = FV \sin(\theta - \phi) \\ = (F \sin \theta \cos \phi - F \cos \theta \sin \phi) V \\ = (c_2 - c_1) \frac{V^2}{g} \sin \phi \cos \phi \\ = W(\beta - a) \frac{V^2}{g} \sin \phi \cos \phi. \quad (5)$$

This N is the couple in foot-pounds changing the momentum of the medium, the momentum of the body alone remaining the same; the medium reacts on the body with the same couple N in the opposite direction, tending when  $c_1 - c_2$  is positive to set the body broadside to the advance.

An oblate flattened body, like a disk or plate, has  $c_1 - c_2$  negative, so that the medium steers the body axially; this may be verified by a plate dropped in water, and a leaf or disk or rocket-stick or piece of paper falling in air. A card will show the influence of the couple N if projected with a spin in its plane, when it will be found to change its aspect in the air.

An elongated body like a ship has  $c_1 - c_2$  positive, and the couple N tends to disturb the axial movement and makes it unstable, so that a steamer requires to be steered by constant attention at the helm.

Consider a submarine boat or airship moving freely with the direction of the resultant momentum horizontal, and the axis at a slight inclination  $\theta$ . With no reserve of buoyancy  $W = W'$ , and the couple N, tending to increase  $\theta$ , has the effect of diminishing the metacentric height by  $h$  ft. vertical, where

$$Wb \tan \theta = N = (c_2 - c_1) \frac{c_1}{c_2} \frac{u^2}{g} \tan \theta, \quad (6)$$

$$h = \frac{c_2 - c_1}{W} \frac{c_1}{c_2} \frac{u^2}{g} = (\beta - a) \frac{1 + \alpha}{1 + \beta} \frac{u^2}{g}. \quad (7)$$

51. An elongated shot is made to preserve its axial flight through the air by giving it the spin sufficient for stability, without which it would turn broadside to its advance; a top in the same way it is made to stand upright on the point in the position of equilibrium, unstable statically but dynamically stable if the spin is sufficient; and the investigation proceeds in the same way for the two problems (see GYROSCOPE).

The effective angular inertia of the body in the medium is now required; denote it by C<sub>1</sub> about the axis of the figure, and by C<sub>2</sub> about a diameter of the mean section. A rotation about the axis of a figure of revolution does not set the medium in motion, so that C<sub>1</sub> is the moment of inertia of the body about the axis, denoted by Wk<sub>1</sub><sup>2</sup>. But if Wk<sub>2</sub><sup>2</sup> is the moment of inertia of the body about a mean diameter, and  $\omega$  the angular velocity about it generated by an impulse couple M, and M' is the couple required to set the surrounding medium in motion, supposed of effective radius of gyration k',

$$Wk_1^2 \omega = M - M', \quad Wk_2^2 \omega = M', \quad (1)$$

$$(Wk_1^2 + Wk_2^2) \omega = M, \quad (2)$$

$$C_1 = Wk_1^2 + Wk_2^2 = (W + W')k_2^2, \quad (3)$$

in which we have put  $k'^2 = \epsilon k_2^2$ , where  $\epsilon$  is a numerical factor depending on the shape.

If the shot is spinning about its axis with angular velocity  $\rho$ , and is precessing steadily at a rate  $\mu$  about a line parallel to the resultant momentum  $F$  at an angle  $\theta$ , the velocity of the vector of angular momentum, as in the case of a top, is

$$C_1 \rho \sin \theta - C_2 \mu^2 \sin \theta \cos \theta; \quad (4)$$

and equating this to the impressed couple (multiplied by  $g$ ), that is, to

$$gN = (c_1 - c_2) \frac{C_1}{C_2} \mu^2 \tan \theta, \quad (5)$$

and dividing out  $\sin \theta$ , which equated to zero would imply perfect centring, we obtain

$$C_2 \mu^2 \cos \theta - C_1 \rho \mu + (c_2 - c_1) \frac{C_1}{C_2} \mu^2 \sec \theta = 0. \quad (6)$$

The least admissible value of  $\rho$  is that which makes the roots equal of this quadratic in  $\mu$ , and then

$$\mu = \frac{1}{2} \frac{C_1}{C_2} \rho \sec \theta, \quad (7)$$

the roots would be imaginary for a value of  $\rho$  smaller than given by

$$C_1^2 \rho^2 - 4(c_2 - c_1) \frac{C_1}{C_2} C_2 \mu^2 = 0, \quad (8)$$

$$\rho^2 = 4(c_2 - c_1) \frac{C_1}{C_2} \frac{C_2}{C_1^2} \mu^2 \quad (9)$$

If the shot is moving as if fired from a gun of calibre  $d$  inches, in which the rifling makes one turn in a pitch of  $n$  calibres or  $nd$  inches, so that the angle  $\delta$  of the rifling is given by

$$\tan \delta = \pi d / nd = \frac{1}{n} \frac{d}{\rho}, \quad (10)$$

Table of Rifling for Stability of an Elongated Projectile,  $x$  Calibres long, giving  $\delta$  the Angle of Rifling in Calibres.

$x$	$\beta - \alpha$	Cast-iron Common Shell $f = \frac{1}{2}$ , S.G. 7.2.		Palliser Shell $f = \frac{1}{2}$ , S.G. 8.		Solid Steel Bullet $f = 0$ , S.G. 8.		Solid Lead Bullet $f = 0$ , S.G. 10.9.		
		$\delta$	$o'$	$n$	$\delta$	$o'$	$n$	$\delta$	$o'$	$n$
1.0	0.0000	0°	0'	Infinity	0°	0'	Infinity	0°	0'	Infinity
2.0	0.4942	2	46	63.87	2	32	71.08	2	19	84.29
2.5	0.6056	3	49	47.91	3	23	53.32	3	19	54.17
3.0	0.6819	4	41	38.45	4	13	42.79	4	09	43.47
3.5	0.7370	5	35	32.13	5	02	35.75	4	58	36.33
4.0	0.7782	6	30	27.60	5	51	30.72	5	45	31.21
4.5	0.8100	7	24	24.20	6	40	26.93	6	32	27.36
5.0	0.8351	8	16	21.56	7	23	23.98	7	21	24.36
6.0	0.8721	10	05	17.57	9	04	19.67	8	56	19.98
10.0	0.9395	16	57	10.31	15	19	11.47	15	05	11.65
Infinity	1.0000	90	00	0.00	90	00	0.00	90	00	0.00

which is the ratio of the linear velocity of rotation  $\frac{1}{2} d \rho$  to  $\mu$ , the velocity of advance,

$$\tan^2 \delta = \frac{\pi^2}{W^2} = \frac{d^2 \rho^2}{4 \mu^2} = (c_2 - c_1) \frac{C_1}{C_2} \frac{C_2 d^2}{C_1^2} \frac{1}{W^2} \\ = \frac{W'}{W} (\beta - \alpha) \frac{1 + \frac{W'}{W} \alpha}{1 + \frac{W'}{W} \beta} \left( \frac{h_2}{d} \right)^2 \quad (11)$$

For a shot in air the ratio  $W'/W$  is so small that the square may be neglected, and formula (11) can be replaced for practical purpose in artillery by

$$\tan^2 \delta = \frac{\pi^2}{W^2} = \frac{W'}{W} (\beta - \alpha) \left( \frac{h_2}{d} \right)^2 \quad (12)$$

if then we can calculate  $\beta$ ,  $\alpha$ , or  $\beta - \alpha$  for the external shape of the shot; this equation will give the value of  $\delta$  and  $n$  required for stability of flight in the air.

The ellipsoid is the only shape for which  $\alpha$  and  $\beta$  have so far been determined analytically, as shown already in § 44, so we must restrict our calculation to an egg-shaped bullet, bounded by a prolate ellipsoid of revolution, in which, with  $b = c$ ,

$$A_0 = \int_0^\infty \frac{a^2 d\lambda}{(a^2 + \lambda) \sqrt{(a^2 + \lambda)(b^2 + \lambda)}} = \int_0^\infty \frac{a^2 d\lambda}{2(a^2 + \lambda)^{3/2} (b^2 + \lambda)} \quad (13)$$

$$A_0 + 2B_0 = 1, \quad (14)$$

$$a = \frac{A_0}{1 - A_0}, \quad \beta = \frac{B_0}{1 - B_0} = \frac{1 - A_0}{1 + 2A_0} \quad (15)$$

The length of the shot being denoted by  $l$  and the calibre by  $d$ , and the length in calibres by  $x$

$$l/d = 2a/2b = x, \quad (16)$$

$$A_0 = \frac{x}{(x^2 - 1)^{3/2}} \operatorname{ch}^{-1} x - \frac{1}{x^2 - 1} \quad (17)$$

$$2B_0 = \frac{-x}{(x^2 - 1)^{3/2}} \operatorname{ch}^{-1} x + \frac{x^2}{x^2 - 1} \quad (18)$$

$$x^2 A_0 + 2B_0 = \frac{x \operatorname{sh}^{-1} \sqrt{(x^2 - 1)}}{\sqrt{(x^2 - 1)}} = \frac{x}{\sqrt{(x^2 - 1)}} \log [x + \sqrt{(x^2 - 1)}] \quad (19)$$

If  $\sigma$  denotes the density of the metal, and if the shell has a cavity homothetic with the external ellipsoidal shape, a fraction  $f$  of the linear scale; then the volume of a round shot being  $\frac{1}{6} \pi r^3$ , and  $\frac{1}{6} \pi d^3 x$  of a shot  $x$  calibres long

$$W = \frac{1}{6} \pi d^3 x (1 - f^3) \sigma, \quad (20)$$

$$W h_2^2 = \frac{1}{6} \pi d^3 x \frac{d^2}{10} (1 - f^3) \sigma, \quad (21)$$

$$W h_2^2 = \frac{1}{6} \pi d^3 x \frac{\beta^2 + d^2}{20} (1 - f^3) \sigma. \quad (22)$$

If  $\rho$  denotes the density of the air or medium

$$W' = \frac{1}{6} \pi d^3 x \rho, \quad (23)$$

$$\frac{W'}{W} = \frac{1}{1 - f^3} \frac{\rho}{\sigma} \quad (24)$$

$$\frac{h_2^2}{d^2} = \frac{1 - f^3}{10} \frac{k_2^2}{k_1^2} = \frac{x^2 + 1}{2}, \quad (25)$$

$$\tan^2 \delta = \frac{\rho}{\sigma} (\beta - \alpha) \frac{x^2 + 1}{2(1 - f^3)}, \quad (26)$$

in which  $\sigma/\rho$  may be replaced by 800 times the S.G. of the metal, taking water as 800 times denser than air on the average, in round numbers, and formula (10) may be written  $n \tan \delta = \pi$ , or  $n\delta = 180$ , when  $\delta$  is a small angle, and given in degrees.

From this formula (26) the table following has been calculated by A. C. Haddock, and the results are in agreement with practical experience.

52. In the steady motion the centre of the shot describes a helix, with axial velocity

$$\mu \cos \theta + v \sin \theta = \left(1 + \frac{C_1}{C_2} \tan^2 \theta\right) \mu \cos \theta \approx \mu \sec \theta, \quad (1)$$

and reverse velocity

$$\mu \sin \theta - v \cos \theta = \left(1 - \frac{C_1}{C_2}\right) \mu \sin \theta \approx (\beta - \alpha) \mu \sin \theta; \quad (2)$$

and the time of completing a turn of the spiral is  $2\pi/\mu$ .

When  $\mu$  has the critical value in (7),

$$\frac{2\pi}{\mu} = \frac{4\pi C_2}{\rho C_1} \cos \theta = \frac{2\pi}{\rho} (x^2 + 1) \cos \theta, \quad (3)$$

which makes the circumference of the cylinder on which the helix is wrapped

$$\frac{2\pi \rho}{\mu} (\mu \sin \theta - v \cos \theta) = \frac{2\pi \rho}{\rho} (\beta - \alpha) (x^2 + 1) \sin^2 \theta \cos \theta \\ = nd(\beta - \alpha)(x^2 + 1) \sin \theta \cos \theta, \quad (4)$$

and the length of one turn of the helix

$$\frac{2\pi x}{\mu} (\mu \cos \theta + v \sin \theta) = nd(x^2 + 1); \quad (5)$$

thus for  $x = 3$ , the length is 10 times the pitch of the rifling.

53. *The Motion of a Perforated Solid in Liquid.*—In the preceding investigation, the liquid stops dead when the body is brought to rest; and when the body is in motion the surrounding liquid moves in a uniform manner with respect to axes fixed in the body, and the force experienced by the body from the pressure of the liquid on its surface is the opposite of that required to change the motion of the liquid; this has been expressed by the dynamical equations given above. But if the body is perforated, the liquid can circulate through a hole, in reentrant stream lines linked with the body, even while the body is at rest; and no reaction from the surface can influence this circulation, which may be supposed started in the ideal manner described in § 29, by the application of impulsive pressure across an ideal membrane closing the hole, by means of ideal mechanism connected with the body. The body is held fixed, and the reaction of the mechanism and the resultant of the impulsive pressure on the surface are a measure of the impulse, linear  $\xi$ ,  $\eta$ ,  $\zeta$ , and angular  $\lambda$ ,  $\mu$ ,  $\nu$ , required to start the circulation.

This impulse will remain of constant magnitude, and fixed relatively to the body, which thus experiences an additional reaction from the circulation which is the opposite of the force required to change the position in space of the circulation impulse; and these extra forces must be taken into account in the dynamical equations.

An article may be consulted in the *Phil. Mag.*, April 1893, by G. H. Bryan, in which the analytical equations of motion are deduced of a perforated solid in liquid, from considerations purely hydrodynamical.

The effect of an external circulation of vortex motion on the motion of a cylinder has been investigated in § 29; a similar procedure will show the influence of circulation through a hole in a solid, taking as the simplest illustration a ring-shaped figure, with uniplanar motion, and denoting by  $\xi$  the resultant axial linear momentum of the circulation.

As the ring is moved from O to O' in time  $t$ , with velocity Q, and angular velocity R, the components of liquid momentum change from

$$\begin{aligned} & \alpha M'U + \xi \text{ and } \beta M'V \text{ along } Ox \text{ and } Oy \\ \text{to} & \alpha M'U' + \xi \text{ and } \beta M'V' \text{ along } O'x' \text{ and } O'y', \end{aligned} \quad (1)$$

the axis of the ring changing from  $Ox$  to  $O'x'$ ; and

$$\begin{aligned} U &= Q \cos \theta, \quad V = Q \sin \theta, \\ U' &= Q \cos (\theta - Rt), \quad V' = Q \sin (\theta - Rt), \end{aligned} \quad (2)$$

so that the increase of the components of momentum,  $X_1, Y_1$ , and  $N_1$ , linear and angular, are

$$\begin{aligned} X_1 &= (\alpha M'U' + \xi) \cos Rt - \alpha M'U - \xi - \beta M'V' \sin Rt \\ &= (\alpha - \beta) M'Q \sin (\theta - Rt) \sin Rt - \xi \text{ ver } Rt \end{aligned} \quad (3)$$

$$\begin{aligned} Y_1 &= (\alpha M'U' + \xi) \sin Rt + \beta M'V' \cos Rt - \beta M'V \\ &= (\alpha - \beta) M'Q \cos (\theta - Rt) \sin Rt + \xi \sin Rt, \end{aligned} \quad (4)$$

$$\begin{aligned} N_1 &= [-(\alpha M'U' + \xi) \sin (\theta - Rt) + \beta M'V' \cos (\theta - Rt)]OO' \\ &= [-(\alpha - \beta) M'Q \cos (\theta - Rt) \sin (\theta - Rt) - \xi \sin (\theta - Rt)]Ql. \end{aligned} \quad (5)$$

The components of force,  $X, Y$ , and  $N$ , acting on the liquid at O, and reacting on the body, are then

$$X = -lt, \quad X_1/l = (\alpha - \beta) M'QR \sin \theta = (\alpha - \beta) M'VR, \quad (6)$$

$$Y = lt, \quad Y_1/l = (\alpha - \beta) M'QR \cos \theta + \xi R = (\alpha - \beta) M'UR + \xi R, \quad (7)$$

$$\begin{aligned} Z &= lt, \quad Z_1/l = (\alpha - \beta) M'Q^2 \sin \theta \cos \theta - \xi Q \sin \theta \\ &= [-(\alpha - \beta) M'U + \xi]V. \end{aligned} \quad (8)$$

Now suppose the cylinder is free; the additional forces acting on the body are the components of kinetic reaction of the liquid

$$-\alpha M' \left( \frac{dU}{dt} - VR \right), \quad -\beta M' \left( \frac{dV}{dt} + UR \right), \quad -c \frac{dR}{dt}, \quad (9)$$

so that its equations of motion are

$$M \left( \frac{dU}{dt} - VR \right) = -\alpha M' \left( \frac{dU}{dt} - VR \right) - (\alpha - \beta) M'VR, \quad (10)$$

$$M \left( \frac{dV}{dt} + UR \right) = -\beta M' \left( \frac{dV}{dt} + UR \right) - (\alpha - \beta) M'UR - \xi R, \quad (11)$$

$$C \frac{dR}{dt} = -c \frac{dR}{dt} + (\alpha - \beta) M'UV + \xi V; \quad (12)$$

and putting as before

$$M + \alpha M' = c_1, \quad M + \beta M' = c_2, \quad C + cC' = C_2, \quad (13)$$

$$\frac{c_1 dU}{c_2} - c_2 VR = c_1, \quad (14)$$

$$\frac{c_2 dV}{c_1} + (c_1 U + \xi) R = c_1, \quad (15)$$

$$\frac{c_2 dR}{c_1} - (c_1 U + \xi - c_2 U) V = c_1, \quad (16)$$

showing the modification of the equations of plane motion, due to the component  $\xi$  of the circulation.

The integral of (14) and (15) may be written

$$c_1 U + \xi = F \cos \theta, \quad c_2 V = -F \sin \theta, \quad (17)$$

$$\frac{dx}{dt} = U \cos \theta - V \sin \theta = \frac{F \cos^2 \theta}{c_1} + \frac{F \sin^2 \theta}{c_2} - \frac{\xi}{c_1} \cos \theta, \quad (18)$$

$$\frac{dy}{dt} = U \sin \theta + V \cos \theta = \frac{F}{c_1} - \frac{F}{c_2} \sin \theta \cos \theta - \frac{\xi}{c_1} \sin \theta, \quad (19)$$

$$C \frac{d\theta}{dt} = \left( \frac{F^2}{c_1} - \frac{F^2}{c_2} \right) \sin \theta \cos \theta - \frac{F\xi}{c_1} \sin \theta = F \frac{d\mu}{dt}, \quad (20)$$

$$C_2 \frac{d\theta}{dt} = F \sqrt{ \left[ -\frac{F^2 \cos^2 \theta}{c_1} - \frac{F^2 \sin^2 \theta}{c_2} + 2 \frac{F\xi}{c_1} \cos \theta + H \right] }; \quad (21)$$

so that  $\cos \theta$  and  $y$  is an elliptic function of the time.

When  $\xi$  is absent,  $dx/dt$  is always positive, and the centre of the body cannot describe loops; but with  $\xi$  the influence may be great enough to make  $dx/dt$  change sign, and so loops occur, as shown in A. B. Bassett's *Hydrodynamics*, i. 192, resembling the trochoidal curves, which can be looped, investigated in § 29 for the motion of a cylinder under gravity, when surrounded by a vortex.

The branch of hydrodynamics which discusses wave motion in a liquid or gas is given now in the articles SOUND and WAVE; while the influence of viscosity is considered under HYDRAULICS.

REFERENCES.—For the history and references to the original memoirs see *Report to the British Association*, by G. G. Stokes (1846), and W. M. Hicks (1882). See also the *Fortschritte der Mathematik*, and A. E. H. Love, "Hydrodynamik" in the *Encyclopädie der mathematischen Wissenschaften* (1901). (A. G. G.)

**HYDROMEDUSAE**, a group of marine animals, recognized as belonging to the Hydrozoa (*g.s.*) by the following characters.

(1) The polyp (hydropolyp) is of simple structure, typically much longer than broad, without ectodermal oesophagus or mesenteries, such as are seen in the anthopolyp (see article ANTHOZOA); the mouth is usually raised above the peristome on a short conical elevation or hypostome; the ectoderm is without cilia. (2) With very few exceptions, the polyp is not the only type of individual that occurs, but alternates in the life-cycle of a given species, with a distinct type, the medusa (*g.s.*), while in other cases the polyp-stage may be absent altogether, so that only medusa-individuals occur in the life-cycle.

The Hydromedusae represent, therefore, a sub-class of the Hydrozoa. The only other sub-class is the Scyphomedusae (*g.s.*). The Hydromedusae contrast with the Scyphomedusae in the following points. (1) The polyp, when present, is without the strongly developed longitudinal retractor muscles, forming ridges (*taeniolae*) projecting into the digestive cavity, seen in the scyphistoma or scyphopolyp. (2) The medusa, when present, has a velum and is hence said to be *craspedote*; the nervous system forms two continuous rings running above and below the velum; the margin of the umbrella is not lobed (except in Narcomedusae) but entire; there are characteristic differences in the sense-organs (see below, and SCYPHOMEDUSAE); and gastral filaments (phacellae), subgenital pits, &c., are absent. (3) The gonads, whether formed in the polyp or the medusa, are developed in the ectoderm.

The Hydromedusae form a widespread, dominant and highly differentiated group of animals, typically marine, and found in all seas and in all zones of marine life. Fresh-water forms, however, are also known, very few as regards species or genera, but often extremely abundant as individuals. In the British fresh-water fauna only two genera, *Hydra* and *Cordylophora*, are found; in America occurs an additional genus, *Microhydra*. The paucity of fresh-water forms contrasts sharply with the great abundance of marine genera common in all seas and on every shore. The species of *Hydra*, however, are extremely common and familiar inhabitants of ponds and ditches.

In fresh-water Hydromedusae the life-cycle is usually secondarily simplified, but in marine forms the life-cycle may be extremely complicated, and a given species often passes in the course of its history through widely different forms adapted to different habitats and modes of life. Apart from larval or embryonic forms there are found typically two types of person, as already stated, the polyp and the medusa, each of which may vary independently of the other, since their environment and life-conditions are usually quite different. Hence both polyp and medusa present characters for classification, and a given species, genus or other taxonomic category may be defined by polyp-characters or medusa-characters or by both combined. If our knowledge of the life-histories of these organisms were perfect, their polymorphism would present no difficulties to classification; but unfortunately this is far from being the case. In the majority of cases we do not know the polyp corresponding to a given medusa, or the medusa that arises from a given polyp.<sup>1</sup> Even when a medusa is seen to be budded from a polyp under observation in an aquarium, the difficulty is not always solved; since the freshly-liberated, immature medusa may differ greatly from the full-grown, sexually-mature medusa after several months of life on the high seas (see figs. 11, B, C, and 59, a, b, c). To establish the exact relationship it is necessary not only to breed but to rear the medusa, which cannot always be done in

<sup>1</sup> In some cases hydroids have been reared in aquaria from ova of medusae, but these hydroids have not yet been found in the sea (Browne [10 d]).

confinement. The alternative is to fish all stages of the medusa in its growth in the open sea, a slow and laborious method in which the chance of error is very great, unless the series of stages is very complete.

At present, therefore, classifications of the Hydromedusae have a more or less tentative character, and are liable to revision with increased knowledge of the life-histories of these organisms. Many groups bear at present two names, the one representing the group as defined by polytypic characters, the other as defined by medusa-characters. It is not even possible in all cases to be certain that the polytypic group corresponds exactly to the medusa-group, especially in minor systematic categories, such as families.

The following is the main outline of the classification that is adopted in the present article. Groups founded on polytypic characters are printed in ordinary type, those founded on medusa-characters in italics. For definitions of the groups see below.

Sub-class Hydromedusae (*Hydrozoa Craspedota*).

Order I. Eleutherozoa.

" II. Hydroidea (*Leptolinae*).

" Sub-order 1. Gymnoblastera (*Anthomedusae*).

" 2. Calyptoblastera (*Leptomedusae*).

Order III. Hydrocorallinae.

" IV. Graptolitoidea.

" V. Trachylinae.

" Sub-order 1. Trachomedusae.

" 2. Narcomedusae.

Order VI. Siphonophora.

Sub-order 1. Chondrophorida.

" 2. Calycophorida.

" 3. Physophorida.

" 4. Cystophorida.

*Organization and Morphology of the Hydromedusae.*

As already stated, there occur in the Hydromedusae two distinct types of person, the polyp and the medusa; and either of them is capable of non-sexual reproduction by budding, a process which may lead to the formation of colonies, composed of more or fewer individuals combined and connected together. The morphology of the group thus falls naturally into four sections—(1) the hydrotypy, (2) the polyp-colony, (3) the hydromedusa, (4) the medusa-colonies. Since, however, medusa-colonies occur only in one group, the Siphonophora, and divergent views are held with regard to the morphological interpretation of the members of a siphonophore, only the first three of the above sub-divisions of hydromedusa morphology will be dealt with here in a general way, and the morphology of the Siphonophora will be considered under the heading of the group itself.

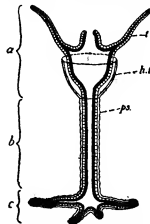

FIG. 1.—Diagram of a typical Hydrotypy.

a, Hydranth;

b, Hydrocaulus;

c, Hydrorhiza;

h.t., Tentacle;

ps, Perisarc, forming in the region of the hydranth a cup or hydrotheca (h, t),—which, however, is only found in polyps of the order Calyptoblastera.

*rhiza* (c). The column (b) is generally long, slender and stalk-like (*hydrocaulus*). Just below the crown of tentacles, however, the body widens out to form a "head," termed the *hydranth* (a), containing a stomach-like dilatation of the digestive cavity. On the upper face of the hydranth the crown of tentacles (t) surrounds the peristome, from which rises the conical hypostome, bearing the mouth at its extremity. The general ectoderm covering the surface of the body has entirely lost the cilia present in the earlier larval stages (planula), and may be naked, or clothed in a cuticle or exoskeleton, the perisarc (ps), which in its simplest condition is a chitinous membrane secreted by the ectoderm. The perisarc when present invests the hydrorhiza and hydrocaulus; it may stop short

below the hydranth, or it may extend farther. In general there are two types of exoskeleton, characteristic of the two principal divisions of the Hydroidea. In the Gymnoblastera the perisarc either stops below the hydranth, or, if continued on to it, forms a closely-fitting investment extending as a thin cuticle as far as the bases of the tentacles (e.g. *Bimeria*, see G. J. Allman [1], pl. xii. figs. 1 and 3). In the Calyptoblastera the perisarc is always continued above the

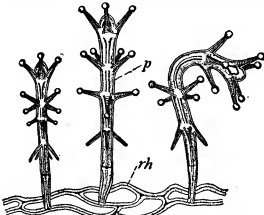

From Allman's *Gymnoblasteric Hydroids*, by permission of the Council of the Ray Society.

FIG. 2.—*Stauridium productum*, portion of the colony magnified; p, polyp; rh, hydrorhiza.

hydrocaulus, and forms a cup, the hydrorhiza or hydrotheca (h, t), standing off from the body, into which the hydranth can be retracted for shelter and protection.

The architecture of the hydrotypy, simple though it be, furnishes a long series of variations affecting each part of the body. The greatest variation, however, is seen in the tentacles. As regards number, we find in the aberrant forms *Protolydra* and *Microhydra* tentacles entirely absent. In the curious hydroid *Monobranchium* a single tentacle is present, and the same is the case in *Clathroozon*; in *Amphibranchium* and in *Lar* (fig. 11, A) the polyp bears two tentacles only. The reduction of the tentacles in all these forms may be correlated with their mode of life, and especially with living in a constant current of water, which brings food-particles always from one direction and renders a complete whorl or circle of tentacles unnecessary. Thus *Microhydra* lives amongst Bryozoa, and appears to utilize the currents produced by these animals. *Protolydra* occurs in oyster-banks and *Monobranchium* also grows on the shells of bivalves, and both these hydroids probably fish in the currents produced by the lamelibranchs. *Amphibranchium* grows in the tissues of a sponge, *Euplectella*, and protrudes its hydranth into the canal-system of the sponge; and *Lar* grows on the tubes of the worm *Sabella*. With the exception of these forms, reduced for the most part in correlation with a semi-parasitic mode of life, the tentacles are usually numerous. It is rare to find in the polyp a regular, symmetrical disposition of the tentacles as in the medusa. The primitive number of four in a whorl is seen, however, in *Stauridium* (fig. 2) and in *Cladonema* (Allman [1], pl. xvii.), and in *Clavatella* each whorl consists regularly of eight (Allman, *loc. cit.* pl. xviii.). As a rule, however, the number in a whorl is irregular. The tentacles may form a single whorl, or more than one; thus in *Corymorpha* (fig. 3) and *Tubularia* (fig. 4) there are two circlets; in *Stauridium* (fig. 2) several; in *Coryne* and *Cordylophora* the tentacles are scattered irregularly over the elongated hydranth.

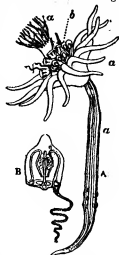

FIG. 3.—Diagram of *Corymorpha*. A, A hydriform person giving rise to medusiform persons by budding from the margin of the disk; B, free swimming medusa (*Stenstrupia* of Forbes) detached from the same, with manubrial genitalia (*Anthomedusae*) and only one tentacle. (After Allman.)

As regards form, the tentacles show a number of types, of which the most important are (1) filiform, i.e. cylindrical or tapering from

<sup>1</sup> The numbers in square brackets [ ] refer to the bibliography at the end of this article; but when the number is preceded by the word *HYDROZOA*, it refers to the bibliography at the end of the article *HYDROZOA*.

base to extremity, as in *Clava* (fig. 5); (2) capitate, *i.e.* knobbed at the extremity, as in *Coryne* (see Allman, *loc. cit.* pl. iv.); (3) branched, a rare form in the polyp, but seen in *Cladocoryne* (see Allman, *loc. cit.* pl. 380, fig. 82). Sometimes more than one type of form is found in the same polyp; in *Pensaria* and *Stauridium* (fig. 2) the upper whorls are capitate, the lower filiform. Finally, as regards structure, the tentacles may retain their primitive hollow nature, or become solid by obliteration of the axial cavity.

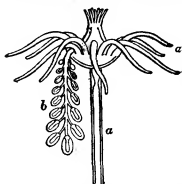

FIG. 4.—Diagram of *Tubularia indivisa*. A single hydriform person *a* bearing a stalk carrying numerous degenerate medusiform persons or sporosacs *b*. (After Allman.)

It may also be glandular in places. It consists of two regions, an external epithelial layer, and a more internal sub-epithelial layer.

The epithelial layer consists of (1) so-called "indifferent" cells secreting the perisarc or cuticle and modified to form glandular cells in places; for example, the adhesive cells in the foot. (2) Sensory cells, which may be fairly numerous in places, especially on the tentacles, but which occur always scattered and isolated, never aggregated to form sense-organs as in the medusa. (3) Contractile

The hypostome of the hydropolyp may be small, or, on the other hand, as in *Eudendrium* (Allman, *loc. cit.* pls. xiii., xiv.), large and trumpet-shaped. In the curious polyp *Myriothela* the body of the polyp is differentiated into nutritive and reproductive portions.

**Histology.**—The ectoderm of the hydropolyp is chiefly sensory, contractile and protective in function. It may

stitial cells, lodged between the narrowed basal portions of the epithelial cells. From them are developed two distinct types of histological elements; the genital cells and the cnidoblasts or mother-cells of the nematocysts. The sub-epithelial layer thus primarily constituted may be recruited by immigration from without of other

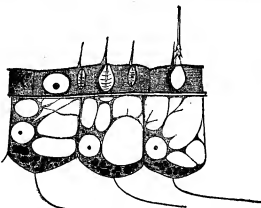

FIG. 6 A.—Portion of the body-wall of *Hydra*, showing ectoderm cells above, separated by "structureless lamella" from three flagellate endoderm cells below. The latter are vacuolated, and contain each a nucleus and several dark granules. In the middle ectoderm cell are seen a nucleus and three nematocysts, with trigger hairs projecting beyond the cuticle. A large nematocyst, with everted thread, is seen in the right-hand ectodermal cell. (After F. E. Schulze.)

elements, more especially by nervous (ganglion) cells and muscle-cells derived from the epithelial layer. In its fullest development, therefore, the sub-epithelial layer consists of four classes of cell-elements.

The genital cells are simple wandering cells (archaeocytes), at first minute and without any specially distinctive features, until they begin to develop into germ-cells. According to Wulferff [60] the primitive germ-cells of *Gonothyrea* can be distinguished soon after the fixation of the planula, appearing amongst the interstitial cells of the ectoderm. The germ-cells are capable of extensive migrations, not only in the body of the same polyp, but also from parent to bud through many non-sexual generations of polyps in a colony (A. Weismann [58]).

The cnidoblasts are the mother-cells of the nematocysts, each cell producing one nematocyst in its interior. The complete nematocyst (fig. 7) is a spherical or oval capsule containing a hollow thread, usually barbed, coiled in its interior. The capsule has a double wall, an outer one (*e.c.*), tough and rigid in nature, and an inner one (*i.c.*) of more flexible consistence. The outer wall of the capsule is incomplete at one pole, leaving an aperture through which the thread is discharged. The inner membrane is continuous with the wall of the hollow thread at a spot immediately below the aperture in the outer wall, so that the thread itself



FIG. 6 B.—Epi-dermo-muscular cells of *Hydra*, *m*, muscular-fibre processes. (After Kleinenberg, from Gegenbaur.)

(*f*) is simply a hollow prolongation of the wall of the inner capsule inverted and pushed into its cavity. The entire nematocyst is enclosed in the cnidoblast which formed it.

When the nematocyst is completely developed, the cnidoblast passes outwards so as to occupy a superficial position in the ectoderm, and a delicate protoplasmic process of sensory nature, termed the *cnidocil* (*cn*) projects from the cnidoblast like a fine hair or cilium. Many points in the development and mechanism of the nematocyst are disputed, but it is tolerably certain (1) that the *cnidocil* is of sensory nature, and that stimulation, by contact with prey or in other ways, causes a reflex discharge of the nematocyst; (2) that the discharge is an explosive change whereby the in-turned thread is suddenly everted and turned inside out, being thus shot through the opening in the outer wall of the capsule, and forced violently into the tissues of the prey, or, it may be, of an enemy; (3) that the thread inflicts not merely a mechanical wound, but instils an irritant poison, numbing and paralyzing in its action. The points most in dispute are, first, how the explosive discharge is brought about, whether by pressure exerted external to the capsule (*i.e.* by contraction of the cnidoblast) or by internal pressure. N. Iwanow [27] has brought forward strong grounds for the latter view, pointing out that the cnidoblast has no contractile mechanism and that measurements show discharged capsules to be on the average slightly larger than undischarged ones. He believes that the capsule contains a substance which swells very rapidly when brought into contact with water, and that in the undischarged condition the capsule has its opening closed by a plug of protoplasm (*x*, fig. 7) which prevents

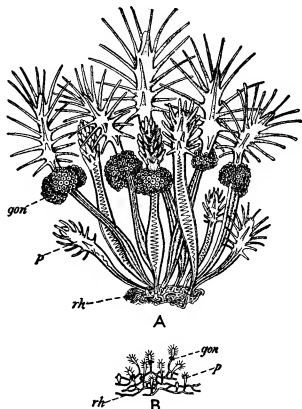

From Allman's *Gymnastic Hydroids*, by permission of the Council of the Ray Society.

FIG. 5.—Colonies of *Clava*. A, *Clava squamata*, magnified. B, *C. multicornis*, natural size; *p*, polyp; *gon*, gonophores; *rh*, rhizoids.

or myo-epithelial cells, with the cell prolonged at the base into a contractile muscle-fibre (fig. 6, B). In the hydropolyp the ectodermal muscle-fibres are always directed longitudinally. Belonging primarily to the epithelial layer, the muscular cells may become secondarily sub-epithelial.

The sub-epithelial layer consists primarily of the so-called inter-



function of circulating and distributing nutriment through the colony.

The hydroid colony shows many variations in form and architecture which depend simply upon differences in the methods in which polyps are budded.

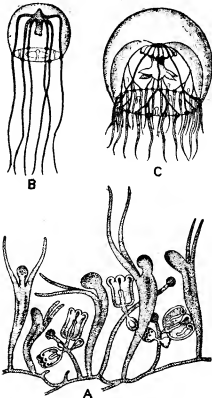

After Hincks, Forbes, and Browne. A and B modified from Hincks; C modified from Forbes's Brit. Nubecynid Medusae.

FIG. 11.—*Lar sabellarum* and two stages of its Medusa, *Willia stellata*. A, colony of Lar; B and C, young and adult medusa.

colony, such as is seen in the so-called Hydrocorallines (fig. 6c), where the interspaces between the coenosaral tubes are filled up with calcareous matter, or coenosteum, replacing the chitinous perisarc. The result is a stony, solid mass, which contributes to the building up of coral reefs. In massive colonies of this kind no sharp distinction can be drawn between hydrothiza and hydrocaulus in the coenosarc; it is practically all hydrothiza. Massive colonies may assume various forms and are often branching or tree-like. A further peculiarity of this type of colony is that the entire coenosaral complex is covered externally by a common layer of ectoderm; it is not clear how this covering layer is developed.

In the second place, the buds may be produced from the hydrocaulus, growing out laterally from it; the result is an arborescent, tree-like colony (figs. 12, 13). Budding from the hydrocaulus may be combined with budding from the hydrothiza, so that numerous branching colonies arise from a common basal stolon. In the formation of arborescent colonies, two sharply distinct types of budding are found, which are best described in botanical terminology as the monopodial or racemose, and the sympodial or cymose types respectively; each is characteristic of one of the two sub-orders of the Hydrozoidea, the Gymnoblastera and Calyploblastea.

In the monopodial method (figs. 12, 14) the founder-polyp is, theoretically, of unlimited growth in a vertical direction, and as it grows up it throws out buds right and left alternately, so that the first bud produced by it is the lowest down, the second bud is above the first, the third above this again, and so on. Each bud produced

theoretically, of unlimited growth in a vertical direction, and as it grows up it throws out buds right and left alternately, so that the first bud produced by it is the lowest down, the second bud is above the first, the third above this again, and so on. Each bud produced



FIG. 13.—Portion of colony of *Bougainvillea frutescens* (Anthomedusae-Gymnoblastera) more magnified. (From Lubbock, after Allman.)

by the founder proceeds to grow and to bud in the same way as the founder did, producing a side branch of the main stem. Hence, in a colony of gymnoblastic hydroids, the oldest polyp of each system, that is to say, of the main stem or of a branch, is the topmost polyp;

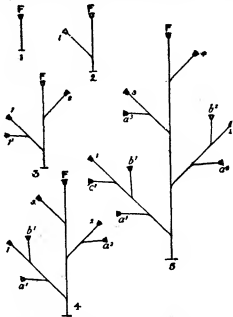

FIG. 14.—Diagrams of the monopodial method of budding, shown in five stages (1-5). F, the founder-polyp; 1, 2, 3, 4, the succession of polyps budded from the founder-polyp; a', b', c', the succession of polyps budded from 1; a'', b'', polyps budded from 2; a''', polyp budded from 3.

the youngest polyp of the system is the one nearest to the topmost polyp; and the axis of the system is a true axis.

In the sympodial method of budding, on the other hand, the founder-polyp is of limited growth, and forms a bud from its side, which is also of limited growth, and forms a bud in its turn, and so on (figs. 15, 16). Hence, in a colony of calyploblastic hydroids, the oldest polyp of a system is the lowest; the youngest polyp is the top-

most one; and the axis of the system is a false axis composed of portions of each of the consecutive polyps.

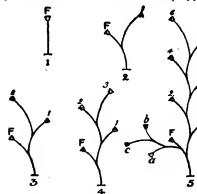

FIG. 15.—Diagram of sympodial budding, uniserial type, shown in five stages (1-5). F, founder-polyp; 1, 2, 3, 4, 5, 6, succession of polyps budded from the founder; a, b, c, second series of polyps budded from the founder; a', b', series budded from 3.

ment becomes masked later by secondary torsions of the hydranths.

In a colony formed by sympodial budding, a polyp always produces first a bud, which contributes to the system to which it belongs, i.e. continues the stem or branch of which its parent forms a part.

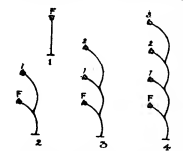

FIG. 16.—Diagram of sympodial budding, uniserial type, shown in four stages (1-4). F, founder-polyp; 1, 2, 3, succession of polyps budded from the founder.

way are formed the familiar feathery colonies of *Plumularia*, in which the pinnules are all in one plane, while in the allied *Antennularia* the pinnules are arranged in whorls round the main biserial stem. The pinnules never branch again, since in the uniserial mode

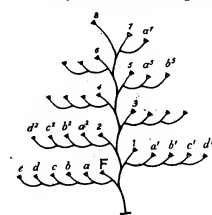

FIG. 17.—Diagram of sympodial budding, simple unbranched *Plumularia*-type. F, founder; 1-8, main axis formed by biserial budding from founder; a-e, pinnule formed by uniserial budding from founder; a'-d', branch formed by similar budding from 1; a'-d' from 2, and so forth.

manner by H. Driesch [13], to whose memoirs the reader must be referred for further details.

**Individualization of Polyp-Colonies.**—As in other cases where animal colonies are formed by organic union of separate individuals, there is ever a tendency for the polyp-colony as a whole to act as a

single individual, and for the members to become subordinated to the needs of the colony and to undergo specialization for particular functions, with the result that they simulate organs and their individuality becomes masked to a greater or less degree. Perhaps the earliest of such specializations is connected with the reproductive function. Whereas primitively any polyp in a colony may produce medusa-buds, in many hydroid colonies medusae are budded only by certain polyps termed *blastostyles* (fig. 10, b). At first not differing in any way from other polyps (fig. 5), the blastostyles gradually lose their nutritive function and the organs connected with it; the mouth and tentacles disappear, and the blastostyle obtains the nutriment necessary for its activity by way of the coenosarcs. In the *Calyptoblastea*, where the polyps are protected by special capsules of the perisarc, the *gonothecae* enclosing the blastostyles differ from the hydrothecae protecting the hydranths (fig. 54).

In other colonies the two functions of the nutritive polyp, namely, capture and digestion of food, may be shared between different polyps (fig. 10). One class of polyps, the *dactylozooids* (dz), lose their mouth and stomach, and become elongated and tentacle-like, showing great activity of movement. Another class, the *gastrozooids* (gz), have the tentacles reduced or absent, but have the mouth and stomach enlarged. The dactylozooids capture food and pass it on to the gastrozooids, which swallow and digest it.

Besides the three types of individual above mentioned, there are other appendages of hydroid colonies, of which the individuality is doubtful. Such are the "guard-polyps" (machopolyps) of *Plumularidae*, which are often regarded as individuals of the nature of dactylozooids, but from a study of the mode of budding in this hydroid family, Driesch concluded that the guard-polyps were not true polyps—individuals, although each is enclosed in a small protecting cup of the perisarc, known as a nematophore. Again, the spines

of *Podocoryne* have been interpreted by some authors as reduced polyps.

**3. The Medusa.**—In the Hydromedusae, the medusa-individual occurs, as already stated, in one of two conditions, either as an independent organism leading a true life in the open seas, or as a subordinate individuality in the hydroid colony, from which it is never set free; it then becomes a mere reproductive appendage or *gonophore*, losing successively its organs of sense, locomotion and nutrition, until its medusoid nature that repeats the structure of the main stem and organization gives off pinnules. The main stem is indicated become scarcely by ———, the new stem by ·····.

Hence it is convenient to consider the morphology of the medusa from these two aspects.

(a) *The Medusa as an Independent Organism.*—The general structural characteristics of the medusa are described elsewhere (see articles HYDROZOA and MEDUSA), and it is only necessary here to deal with the peculiarities of the Hydromedusae.

As regards habit of life the vast majority of Hydromedusae are



FIG. 18.—Diagram showing method of branching in the *Plumularia*-type; compare with fig. 17. Polyps 3 and 6, instead of producing uniserial pinnules, have produced biserial branches (3', 3'', 3''', 3''', 6'-6'', 6'-6'''), which give off uniserial branches in their turn.

Another class, the *gastrozooids* (gz), have the tentacles reduced or absent, but have the mouth and stomach enlarged. The dactylozooids capture food and pass it on to the gastrozooids, which swallow and digest it.

Besides the three types of individual above mentioned, there are other appendages of hydroid colonies, of which the individuality is doubtful. Such are the "guard-polyps" (machopolyps) of *Plumularidae*, which are often regarded as individuals of the nature of dactylozooids, but from a study of the mode of budding in this hydroid family, Driesch concluded that the guard-polyps were not true polyps—individuals, although each is enclosed in a small protecting cup of the perisarc, known as a nematophore. Again, the spines



FIG. 19.—Diagram showing method of branching in the *Aglaophenia*-type. Polyp 7 has produced as its first bud, 8; as its second bud, a', motion and nutrition, until its medusoid nature that repeats the structure of the main stem and organization gives off pinnules. The main stem is indicated become scarcely by ———, the new stem by ·····.

Hence it is convenient to consider the morphology of the medusa from these two aspects.

(a) *The Medusa as an Independent Organism.*—The general structural characteristics of the medusa are described elsewhere (see articles HYDROZOA and MEDUSA), and it is only necessary here to deal with the peculiarities of the Hydromedusae.

As regards habit of life the vast majority of Hydromedusae are



pelagic organisms, floating on the surface of the open sea, propelling themselves feebly by the pumping movements of the umbrella produced by contraction of the sub-umbrellar musculature, and capturing their prey with their tentacles. The genera *Cladonema* (fig. 20) and *Clavatella* (fig. 21), however, are ambulatory, creeping forms, living in rock-pools, and walking, as it were, on the tips of the proximal branches of each of the tentacles, while the remaining branches serve for capture of food. *Cladonema* still has the typical medusan structure, and is able to swim about, but in *Clavatella*, the umbrella is so much reduced that swimming is no longer possible. The remarkable medusa *Mnestra parasitico-parasitic* throughout life on the pelagic mollusc *Phyllirrhoe*, attached to the tips of the sub-umbrellar surface, and its tentacles have become rudimentary or absent. It is interesting to note that *Mnestra* has been shown by J. W. Fewkes [15] and R. T. Günther [19] to belong to the same family (*Cladonemidae*) as *Cladonema* and *Clavatella*, and it is reasonable to suppose that the non-parasitic ancestor of *Mnestra* was, like the other two genera, an ambulatory medusa which acquired a louse-like habit.

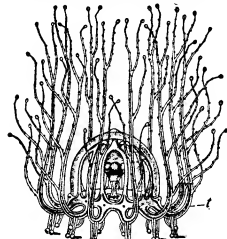

From Allman's *Gymnolastic Hydroids*, by permission of the Council of the Ray Society.

FIG. 20.—*Cladonema radiatum*, the medusa walking on the basal branches of its tentacles (*t*), which are turned up over the body.

est to note that *Mnestra* has been shown by J. W. Fewkes [15] and R. T. Günther [19] to belong to the same family (*Cladonemidae*) as *Cladonema* and *Clavatella*, and it is reasonable to suppose that the non-parasitic ancestor of *Mnestra* was, like the other two genera, an ambulatory medusa which acquired a louse-like habit. In some species of the genus *Cunina* (Narcomedusae) the youngest individuals (actinulae) are parasitic on other medusae (see below), but in later life the parasitic habit is abandoned. No other instances are known of sessile habit in Hydromedusae.



From Allman's *Gymnolastic Hydroids*, by permission of the Council of the Ray Society.

FIG. 21.—*Clavatella prolifera*, ambulatory medusa. *t*, tentacles; *oc*, ocelli.

The external form of the Hydromedusae varies from that of a deep bell or thimble, characteristic of the Anthomedusae, to the shallow saucer-like form characteristic of the Leptomedusae. It is usual for the umbrella to have an even, circular, uninterrupted margin; but in the order Narcomedusae secondary down-growths between the tentacles produce a lobed, indented margin to the umbrella. The marginal tentacles are rarely absent in non-parasitic forms, and are typically four in number, corresponding to the four perradii marked by the radial canals. Interradii tentacles may be also developed, so that the total number present may be increased to eight or to an indefinitely large number. In *Willisia*, *Geryonia*, &c., however, the tentacles and radial canals are on the plan of six instead of four (figs. 11 and 26). On the other hand, in some cases the tentacles are less in number than the perradii; in *Corymorpha* (figs. 3 and 22) there is but a single tentacle, while two are found in *Amphinema* and *Gemmaria* (Anthomedusae), and in *Solmundella bisentaculata* (fig. 67) and *Aeginopsis henseni* (fig. 23) (Narcomedusae). The tentacles also vary considerably in other ways than in number; first, in form, being usually simple, with a basal bulb, but in *Cladonema* they are branched, often in complicated fashion; secondly, in grouping, being usually given off singly, and at regular intervals from the margin of the umbrella, but in *Margelidae* and in some Trachomedusae they are given off in tufts or bunches (fig. 24);

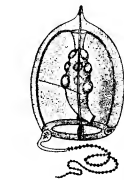

After E. T. Browne, from *Proc. Zool. Soc. of London*.

FIG. 22.—*Corymorpha nutans*, adult female Medusa. Magnified 10 diameters.

thirdly, in position and origin, being usually implanted on the extreme edge of the umbrella, but in Narcomedusae they become secondarily shifted and are given off high up on the ex-umbrella (figs. 23 and 25); and, fourthly, in structure, being hollow or solid, as in the polyp. In some medusae, for instance, the remarkable deep-sea family *Pecyliidae*, the tentacles may bear suckers, by which the animal may attach itself temporarily. It should be mentioned finally that the tentacles are very contractile and extensible, and may therefore present themselves, in one and the same individual, as long, drawn-out threads, or in the form of short, corkscrew-like ringlets; they may stream downwards from the sub-umbrella, or be held out horizontally, or be directed upwards over the ex-umbrella (fig. 23). Each species of



After O. Maas, *Die Craspedoten Medusen der Plankton Expedition*, by permission of Lipsius and Tischer.

FIG. 23.—*Aeginopsis henseni*, slightly magnified, showing the manner in which the tentacles are carried in life.

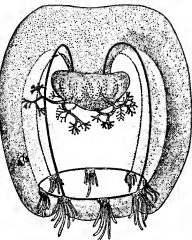

After O. Maas, *Craspedoten Medusen der Siboga-Expedition*, by permission of E. S. Brill & Co.

FIG. 24.—*Rathkea octonemalis*.

medusa usually has a characteristic method of carrying its tentacles.

The sub-umbrella invariably shows a velum as an inwardly projecting ridge or rim at its margin, within the circle of tentacles; hence the medusae of this sub-class are termed *craspedote*. The manubrium is absent altogether in the fresh-water medusa *Limnocnida*, in which the diameter of the mouth exceeds half that of the umbrella; on the other hand, the manubrium may attain a great length, owing to the centre of the sub-umbrella with the stomach being drawn into it, as it were, to form a long proboscis, as in *Geryonia*. The mouth may be a simple, circular pore at the extremity of the manubrium, or by folding of the edges it may become square or shaped like a Maltese cross, with four corners and four lips. The corners of the mouth may then be drawn out into lobes or lappets, which may have a branched or fringed outline (fig. 27); and in *Margelidae* the subdivisions of the fringe simulate tentacles (fig. 24).

The internal anatomy of the Hydromedusae shows numerous variations. The stomach may be altogether lodged in the manubrium, from which the radial canals then take origin directly as in *Geryonia* (Trachomedusae); it may be wide or without gastric pouches. The radial canals may be simple or branched, primarily four, rarely six in number. The ring-canal is drawn out in Narcomedusae into festoons corresponding with the lobes of the margin, and may be obliterated altogether (*Solmaris*). In this order the radial canals are represented only by wide gastric pouches, and in the family *Solmaridae* are suppressed altogether, so that the tentacles and festoons of the ring-canal arise directly from the stomach. In *Geryonia*, centripetal canals, ending blindly, arise from the ring-canal and run in a radial direction towards the centre of the umbrella (fig. 26).

*Histology of the Hydromedusae*.—The histology described above for the polyp may be taken as the primitive type, from which that

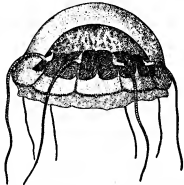

After O. Maas, *Medusae*, in *Prinze von Monaco's series*.

FIG. 25.—*Aeginura grimaldii*,

of the medusa differs only in greater elaboration and differentiation of the cell-elements, which are also more concentrated to form distinct tissues.

The ectoderm furnishes the general epithelial covering of the body, and the muscular tissue, nervous system and sense-organs. The

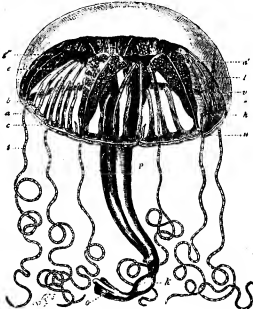

FIG. 26.—*Carmarina (Geryonia) hastata*, one of the *Trachomedusae*. (After Haeckel.)

- |    |                  |    |   |
|----|------------------|----|---|
| a. | Nerve ring.      | g. | Peronia or cartilaginous process ascending from the cartilaginous margin of the disk centripetally in the outer surface of the jelly-like disk; six of these are periradial, six interradial, corresponding to the twelve |
| a' | Radial nerve.    | h. | solid larval tentacles, resembling those of <i>Cunina</i> .   |
| b. | Tentaculocyst.   | i. | Jelly of the disk.  |
| c. | Circular canal.  | p. | Manubrium.  |
| e. | Radiating canal. | l. | Tentacle (hollow and tertiary, i.e. preceded by six periradial and six interradial solid larval tentacles).   |
| g. | Ovary.           | u. | Cartilaginous margin of the disk, covered by thread-  |
| h. |                  | v. | Velum.  |

external epithelium is flat on the ex-umbrellar surface, more columnar on the sub-umbrellar surface, where it forms the muscular tissue of the sub-umbrella and the velum. The nematocysts of the ectoderm may be grouped to form batteries on the tentacles, umbrellar margin and oral lappets. In places the nematocysts may be crowded so thickly as to form a tough, supporting, "chondral" tissue, resembling cartilage, chiefly developed at the margin of the umbrella and forming streaks or bars supporting the tentacles ("Tentakelspangen," *peronia*) or the tentaculocysts ("Cehorspangen," *otoporpa*).

The muscular tissue of the Hydromedusae is entirely ectodermal. The muscle-fibres arise as processes from the bases of the epithelial cells; such cells may individually become sub-epithelial in position, as in the polyp; or, in places where muscular tissue is greatly developed, as in the velum or sub-umbrella, the entire muscular epithelium may be thrown into folds in order to increase its surface, so that a deeper sub-epithelial muscular layer becomes separated completely from a more superficial body-epithelium.

In its arrangement the muscular tissue forms two systems: the one composed of striated fibres arranged circularly, that is to say, concentrically round the central axis of the umbrella; the other of non-striated fibres running longitudinally, that is to say, in a radial direction from, or (in the manubrium) parallel to, the same ideal axis. The circular system is developed continuously over the entire sub-umbrellar surface, and the velum represents a special local development of this system, at a region where it is able to act at the greatest mechanical advantage in producing the contractions of the umbrella

by which the animal progresses. The longitudinal system is discontinuous, and is subdivided into proximal, medial and distal portions. The proximal portion forms the retractor muscles of the manubrium, or proboscis, well developed, for example, in *Geryonia*. The medial portion forms radiating tracts of fibres, the so-called "bell-muscles" running underneath, and parallel to, the radial canals; when greatly developed, as in *Tiaridae*, they form ridges, so-called mesenteries, projecting into the sub-umbrellar cavity. The distal portions form the muscles of the tentacles. In contrast with the polyp, the longitudinal muscle-system is entirely ectodermal, there being no endodermal muscles in *Aspaspodote medusae*.

The nervous system of the medusa consists of sub-epithelial ganglion-cells, which form, in the first place, a diffuse plexus of nervous tissue, as in the polyp, but developed chiefly on the sub-umbrellar surface; and which are concentrated, in the second place, to form a definite central nervous system, never found in the polyp. In Hydromedusae the central nervous system forms two concentric nerve-rings at the margin of the umbrella, near the base of the velum. One, the "upper" or ex-umbrellar nerve-ring, is derived from the ectoderm on the ex-umbrellar side of the velum; it is the larger of the two rings, containing more numerous but smaller ganglion-cells, and innervates the tentacles. The other, the "lower" or sub-umbrellar nerve-ring, is derived from the ectoderm on the sub-umbrellar side of the velum; it contains fewer but larger ganglion-cells and innervates the muscles of the velum (see diagram in article *MEDUSAE*).

The two nerve-rings are connected by fibres passing from one to the other. The sensory cells are slender epithelial cells, often with a cilium or stiff process, and should perhaps be regarded as the only ectoderm-cells which retain the primitive ciliation of the larval ectoderm, otherwise lost in all Hydrozoa. The sense-cells form, in the first place, a diffuse system of scattered sensory cells, as in the polyp, developed chiefly on the manubrium, the tentacles and the margin of the umbrella, where they form a sensory ciliated epithelium covering the nerve-centres; in the second place, the sense-cells are concentrated to form definite sense-organs, situated always at the margin of the umbrella, hence often termed "marginal bodies." The possession of definite sense-organs at once distinguishes the medusa from the polyp, in which they are never found.

The sense-organs of medusae are of two kinds—first, organs sensitive to light, usually termed *ocelli* (fig. 29); secondly, organs commonly termed *statocysts*, on account of their resemblance to the auditory vesicles of higher animals, but serving for the sense of balance and orientation, and therefore given the special name

of *statocyst* (fig. 30). The sense-organs may be *tentaculocysts*, i.e. modified tentacles, as in *Trachylinae*; or developed from the margin of the umbrella, in no connexion with a tentacle (or, if so connected, not producing any modification in the tentacle), as in *Leptolinae*. In Hydromedusae the sense-organs are always exposed at the umbrellar margin (hence *Gymnophthalmata*), while in Scyphomedusae they are covered over by flaps of the umbrellar margin (hence *Steganophthalmata*).

The *statocyst* present in general the structure of either a knob or a closed vesicle, composed of (1) indifferent supporting epithelium; (2) sensory, so-called auditory epithelium of slender cells, each



FIG. 28.—Muscular Cells of *Medusae (Lisasia)*. The uppermost is a purely muscular cell from the sub-umbrella; the two lower are epidermo-muscular cells from the base of a tentacle; the upstanding nucleated portion forms part of the epidermal mosaic on the free surface of the body. (After Hertwig.)

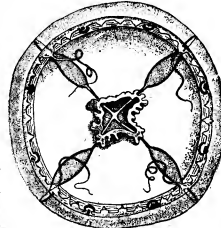

After O. Maas, *Crossipolites Malum der Siboga Expedition*, by permission of E. S. Brill & Co.

FIG. 29.—*Tiaropsis rosea* (Ag. and Mayer) showing the eight radial Statocysts, each close to an Ocellus. Cf. fig. 30.

The sense-organs may be *tentaculocysts*, i.e. modified tentacles, as in *Trachylinae*; or developed from the margin of the umbrella, in no connexion with a tentacle (or, if so connected, not producing any modification in the tentacle), as in *Leptolinae*. In Hydromedusae the sense-organs are always exposed at the umbrellar margin (hence *Gymnophthalmata*), while in Scyphomedusae they are covered over by flaps of the umbrellar margin (hence *Steganophthalmata*).

The *statocyst* present in general the structure of either a knob or a closed vesicle, composed of (1) indifferent supporting epithelium; (2) sensory, so-called auditory epithelium of slender cells, each

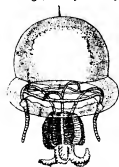

After O. Maas in *Remis of the Albatross Expedition*, Museum of Comparative Zoology, Cambridge, Mass., U.S.A.

FIG. 27.—*Stomatocysta divisa*, one of the *Tiaridae* (Anthomedusae).

bearing at its free upper end a stiff bristle and running out at its base into a nerve-fibre; (3) concrement-cells, which produce intercellular concretions, so-called otoliths. By means of vibrations or shocks transmitted through the water, or by displacements in the balance or position of the animal, the otoliths are caused to impinge against the bristles of the sensory cells, now on one side, now on the other, causing shocks or stimuli which are transmitted by the basal nerve-fibre to the central nervous system.

Two stages in the development of the otocyst can be recognized, the first that of an open pit on a freely projecting knob, which the otoliths are exposed, the second that of a closed vesicle, in which the otoliths are covered over.

Further, two distinct types of otocyst can be recognized in the Hydromedusae; that of the Leptolineae, in which the entire organ is ectodermal, concrement-cells and all, and the organ is not a tentaculocyst; and that of the Trachylinae, in which the organ is a tentaculocyst, and the concrement-cells are endodermal, derived from the endoderm of the modified tentacle, while the rest of the organ is ectodermal.

In the Leptolineae the otocysts are seen in their first stage in *Mitrocoma aenae* (fig. 31) and *Tiaropsis* (figs. 29, 30) as an open pit at the base of the velum, on its sub-umbrellal side. The pit has its opening turned towards the sub-umbrellal cavity, while its base or fundus forms a bulge, more or less pronounced, on the ex-umbrellal side of the velum. At the fundus are placed the concrement-cells with their conspicuous otoliths (con) and the inconspicuous auditory cells, which are connected with the sub-umbrellal nerve-ring. From the open condition arises the closed condition very simply by closing up of the aperture of the pit. We then find the typical otocyst of the Leptomedusae, a vesicle bulging on the ex-umbrellal side of the velum (figs. 32, 33). The otocysts are placed on the outer wall of the

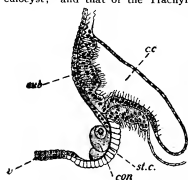

Modified after O. and R. Hertwig, *Nervensystem und Sinnesorgane der Medusen*, by permission of F. C. W. Vogel.

FIG. 31.—Section of a Statocyst of *Mitrocoma aenae*.

sub, Sub-umbrellal ectoderm  
c.c., Circular canal.  
r., Velum.  
st.c., Cavity of statocyst.  
con, Concrement-cell with otolith.

aperture of the pit. We then find the typical otocyst of the Leptomedusae, a vesicle bulging on the ex-umbrellal side of the velum (figs. 32, 33). The otocysts are placed on the outer wall of the

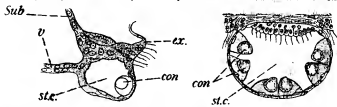

Modified after O. and R. Hertwig, *Nervensystem und Sinnesorgane der Medusen*, by permission of F. C. W. Vogel.

FIG. 32.—Section of a Statocyst of *Phialidium*.

ex, Ex-umbrellal ectoderm.  
sub, Sub-umbrellal ectoderm.  
r., Velum.  
st.c., Cavity of statocyst.  
con, Concrement-cell with otolith.

vesicle (the fundus of the original pit) or on its sides; by their arrangement and number vary greatly and furnish useful characters for distinguishing genera. The sense-cells are innervated, as before, from the sub-umbrellal nerve-ring. The inner wall of the vesicle

(region of closure) is frequently thickened to form a so-called "sense cushion," apparently a ganglionic offshoot from the sub-umbrellal nerve-ring. In many Leptomedusae the otocysts are very small, inconspicuous and embedded completely in the tissues; hence they may be easily overlooked in badly-preserved material, and perhaps are present in many cases where they have been said to have been wanting.

In the Trachylinae the simplest condition of the otocyst is a freely projecting club, a so-called *statorhabd* (figs. 34, 35), representing a tentacle greatly reduced in size, covered with sensory ectodermal epithelium (*ect.*), and containing an endodermal core (*end.*), which is at first continuous with the endoderm of the ring-canal, but later becomes separated from it. In the endoderm large cilia are formed (*con.*), cilia cover a sort of cushion (*n.c.*) at the base of the club; the club may be long and the cushion small, or the cushion large and the club small. The whole structure is innervated, like the tentacles, from the ex-umbrellal nerve-ring.

An advance towards the second stage is seen in such a form as *Rhopalomena* (fig. 36), where the ectoderm of the cushion rises up in a double fold to enclose the club in a protective covering forming a cup or vesicle, at first open distally; finally the opening closes and the closed vesicle may sink inwards and be found far removed from the surface, as in *Geryonia* (fig. 37).

The ocelli are seen in their simplest form as a pigmented patch of ectoderm, which consists of two kinds of cells—(1) pigment-cells, which are ordinary indifferent cells of the epithelium containing pigment-granules, and (2) visual cells, slender sensory epithelial cells of the usual type, which may develop visual cones or rods at their free extremity. The ocelli occur usually either on the inner or outer sides of the tentacles; if on the inner side, the tentacle is turned upwards, and carried over the ex-umbrella, so as to expose the ocellus to the light; if the ocellus be on the outer side of a or concretion *hk*, formed by endoderm cells, is enclosed by an upgrowth forming the "vesicle," the base of the tentacle to the top. (After Hertwig.)

FIG. 33.—Optical Section of a Statocyst of *Octorchis*.  
con, Concrement-cell with otolith.  
st.c., Cavity of statocyst.

FIG. 34.—Tentaculocyst (*statorhabd*) of *Cunina solmaris*. *n.c.*, Nerve-cushion; *end.*, endodermal concrement-cells; *con.*, otolith.

FIG. 35.—Tentaculocyst of *Cunina lativentris*.  
*ect.*, Ectoderm.  
*n.c.*, Nerve-cushion.  
*end.*, Endodermal concrement-cells.  
*con.*, Otolith.

FIG. 36.—Simple tentaculocyst of *Rhopalomena velatum*. The process carrying the otolith outer side of a or concretion *hk*, formed by endoderm cells, is enclosed by an upgrowth forming the "vesicle," the base of the tentacle to the top. (After Hertwig.)

In other cases ocelli may occur between tentacles, as in *Tiaropsis* (fig. 29). The simple form of ocellus described in the foregoing paragraph may become folded into a pit or cup, the interior of which becomes filled with a clear gelatinous secretion forming a sort of vitreous

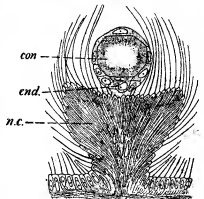

After O. and R. Hertwig, *Nervensystem und Sinnesorgane der Medusen*, by permission of F. C. W. Vogel.

FIG. 34.—Tentaculocyst (*statorhabd*) of *Cunina solmaris*. *n.c.*, Nerve-cushion; *end.*, endodermal concrement-cells; *con.*, otolith.

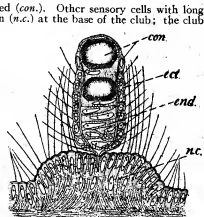

After O. and R. Hertwig, *Nervensystem und Sinnesorgane der Medusen*, by permission of F. C. W. Vogel.

FIG. 35.—Tentaculocyst of *Cunina lativentris*.

*ect.*, Ectoderm.  
*n.c.*, Nerve-cushion.  
*end.*, Endodermal concrement-cells.  
*con.*, Otolith.

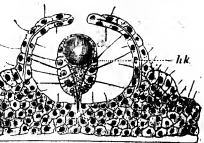

FIG. 36.—Simple tentaculocyst of *Rhopalomena velatum*. The process carrying the otolith outer side of a or concretion *hk*, formed by endoderm cells, is enclosed by an upgrowth forming the "vesicle," the base of the tentacle to the top. (After Hertwig.)

body. The distal portion of the vitreous body may project from the cavity of the cup, forming a non-cellular lens as in *Lizzia* (fig. 28). Beyond this simple condition the visual organs of the Hydromedusae do not advance, and are far from reaching the wonderful development of the eyes of Scyphomedusae (*Charybdeae*).

Besides the ordinary type of ocellus just described, there is found in one genus (*Tiaropsis*) a type of ocellus in which the visual elements are inverted, and have their cones turned away from the light, as in the human retina (fig. 30). In this case the pigment-cells are endodermal, forming a cup of pigment in which the visual cones are embedded. A similar ocellus is formed in *Aurelia* among the Scyphomedusae (*q.v.*).

After O. and R. Hertwig, *Nemostylosium Sinnesorgane der Medusen*, by permission of F. C. W. V. Viebig. FIG. 37.—Section of statocyst of *Geryonia* (*Carmarina hastata*).

*st.c.*, Statocyst containing the minute tentaculo-cyst.  
*n.r.*, Ex-umbra-nerve-ring.  
*nr.*, Sub-umbra-nerve-ring.  
*ex.*, Ex-umbra-ectoderm.  
*sub.*, Sub-umbra-ectoderm.  
*c.c.*, Circular canal.  
*v.*, Velum.

tle-like structure with an endodermal axis containing an axial cavity which may be continuous with the ring-canal, or may be partially occluded. Externally the cordylus is covered by very flattened ectoderm, and bears no otoliths or sense-cells, but the base of the club rests upon the ex-umbra-nerve-ring. Brooks regards these organs as sensory, serving for the sense of balance, and representing a primitive stage of the tentaculo-cysts of Trachylinae; Linko, on the other hand, finding no nerve-elements connected with them, regards them as digestive (?) in function.

The sense-organs of the two fresh-water medusae *Limnocodium* and *Limnocida* are peculiar and of rather doubtful nature (see E. T. Browne [10]).

The endoderm of the medusa shows the same general types of structure as in the polyp, described above. We can distinguish (1) digestive endoderm, in the stomach, often with special glandular elements; (2) circulatory endoderm, in the radial and ring-canal; (3) supporting endoderm in the axes of the tentacles and in the endodermella; the latter is primitively a double layer of cells, produced by concrescence of the ex-umbra- and sub-umbra- layers of the coelenteron, but it is usually found as a single layer of flattened cells (fig. 40); in *Geryonia*, however, it remains double, and the centripetal canals arise by parting of the two layers; (4) excretory endoderm, lining pores at the margin of the umbrella, occurring in certain Leptomedusae as so-called "marginal tubercles," opening, on the one hand, into the ring-canal and, on the other hand, to the exterior by "marginal funnels," which debouch into the sub-umbra cavity above the velum. As has been described above, the endoderm may also contribute to the sense-organs, but such contributions are always of an accessory nature, for instance, concrement-cells in the otocysts, pigment in the ocelli, and never of sensory nature, sense-cells being

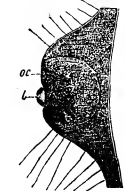

FIG. 38.—Ocellus of *Lizzia koellikeri*. *oc*, Pigmented ectodermal cells; *l*, lens. (After Hertwig.)

in all cases ectodermal.

The reproductive cells may be regarded as belonging primarily to neither ectoderm nor endoderm, though lodged in the ectoderm in all Hydromedusae. As described for the polyp, they are wandering cells capable of extensive migrations before reaching the particular spot at which they ripen. In the Hydromedusae they usually, if not invariably, ripen in the ectoderm, but in the neighbourhood of the main sources of nutriment, that is to say, not far from the stomach. Hence the gonads are found on the manubrium in Anthomedusae generally; on the base of the manubrium, or under the gasteral pouches, or in both these situations (*Octorchidae*), or under the radial canals, in Trachylinae; under the gasteral pouches or radial canals, in Narcomedusae. When ripe, the germ-cells are dehiscid directly to the exterior.

Hydromedusae are of separate sexes, the only known exception being *Amphogona apsteinii*, one of the Trachomedusae (Browne [9]). Moreover, all the medusae budded from a given hydroid colony are either male or female, so that even the non-sexual polyp must be considered to have a latent sex. (In *Hydra*, on the other hand, the individual is usually hermaphrodite.) The medusa always reproduces itself sexually, and in some cases non-sexually also. The non-sexual reproduction is taken in the form of fission, budding or sporogony, the details of which are described below. Buds may be produced from the manubrium, radial canals, ring-canal, or tentacle-bases, or from an aboral stolon (Narcomedusae). In all cases only medusa-buds are produced, never polyp-buds.

The mesogloea of the medusa is largely developed and of great thickness in the umbrella. The sub-epithelial tissues, i.e. the nervous and muscular cells, are lodged in the mesogloea, but in Hydromedusae it never contains tissue-cells or mesogloial corpuscles.

(b) *The Medusae as a Subordinate Individually.*

It has been shown above that polyps are budded only from polyps and that the medusae may be budded either from polyps or from medusae. In any case the daughter-individuals produced from the buds may be imagined as remaining attached to the parent and forming a colony of individuals in organic connection with one another, and thus three possible cases arise. The first case gives a colony entirely composed of polyps, as in many Hydroids. The second case gives a colony partly composed of polyp-individuals, partly of medusa-individuals, a possibility also realized in many colonies of Hydroidea. The third case gives a colony entirely composed of medusa-individuals, a possibility perhaps realized in the Siphonophora, which will be discussed in dealing with this group.

The first step towards the formation of a mixed hydroid colony is undoubtedly a hastening of the sexual maturity of the medusa-individual. Normally the medusae are liberated in quite an immature state; they swim away, feed, grow and become adult mature individuals. From the biological point of view, the medusa is to be considered as a means of spreading the species, supplementing the deficiency of the sessile polyp. It may be, however, that increased reproductive-ness becomes of greater importance to the species than wide diffusion; such a condition will be brought about if the medusae mature quickly and are either Herwig.)

set free in a mature condition or remain in the shelter of the polyp-colony, protected from risks of a free life in the open sea. In this way *e*, the medusa sinks from an independent personality to an organ of the polyp-colony, becoming a so-called *medusoid gonophore*, or bearer of the reproductive organs, and losing gradually all organs necessary for an independent existence, namely those of sense, locomotion and nutrition.

In some cases both free medusae and gonophores may be produced from the same hydroid colony. This is the case in *Syncoryne mirabilis* (Allman [1], p. 278) and in *Campansularia visabilis*; in the latter, free medusae are produced in summer, gonophores in winter (Duplessis [14]). Again in *Pennaria*, the male medusae are set free

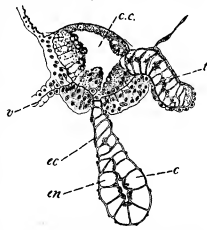

After W. K. Brooks, *Journal of Morphology*, 2, by permission of Gian & Co.

FIG. 39.—Section of a Cordylus of *Laodice*.

*c.c.*, Circular canal.  
*v.*, Velum.  
*l.*, Tentacle.  
*cc*, Cordylus, composed of flattened ectoderm *cc* covering a large-celled endodermal axis *en*.

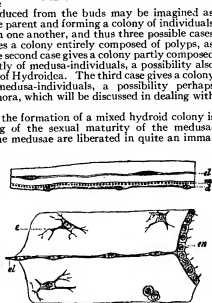

FIG. 40.—Portions of Sections through the Disk of Medusae—the upper one of *Lizzia*, the lower of *Aurelia*. (After Herwig.)

*el*, Endoderm lamella.  
*m*, Muscular processes of the ectoderm-cells in cross section.  
*d*, Ectoderm.  
*en*, Endoderm lining the enteric cavity.

*e*, Wandering endoderm cells of the gelatinous substance.

in a state of maturity, and have ocelli; the female medusae remain attached and have no sense organs.

The gonophores of different hydroids differ greatly in structure from one another, and form a series showing degeneration of the medusa-individual, which is gradually stripped, as it were, of its characteristic features of medusan organization and finally reduced to the simplest structure. A very early stage in the degeneration is well exemplified by the so-called "meconidium" of *Gonothyraea* (fig. 41, A). Here the medusoid, attached by the centre of its ex-umbrellar surface, has lost its velum and sub-umbrellar muscles, its sense organs and mouth, though still retaining rudimentary tentacles. The gonads (g) are produced on the manubrium, which has a hollow endodermal axis, termed the spadix (sp.), in open communication with the coenosarc of the polyp-colony and serving for the nutrition of the generative cells. A very similar condition is seen in *Tubularia* (fig. 41, B), where, however, the tentacles have quite disappeared, and the circular rim formed by the margin of the umbrella has nearly closed over the manubrium leaving only a small aperture through which the embryos emerge. The next step is illustrated by the female gonophores of *Cladocoryne*, where the radial and ring-canal

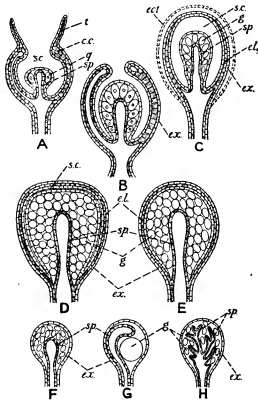

Modified from Weismann, *Entstehung der Sexualzellen bei den Hydromedusen*.

FIG. 41.—Diagrams of the Structure of the Gonophores of various Hydromedusae, based on the figures of G. J. Allman and A. Weismann.

- A, "Meconidium" of *Gonothyraea*. H, With spadix branched (*Cordylolophora*).  
 B, Type of *Tubularia*.  
 C, Type of *Garceia*, &c. [&c. s.c., Sub-umbrellar cavity.  
 D, Type of *Plumularia*, *Agalma*, t, Tentacles.  
 E, Type of *Coryne*, *Forskalia*, &c. c.c., Circular canal.  
 F, G, H, Sporosacs, g, Gonads.  
 F, G, With simple spadix, sp, Spadix.  
 G, With spadix prolonged c.l., Endoderm-lamella.  
 H, With spadix prolonged c.x., Ex-umbrellar ectoderm.  
 c.c.t., Ectotheca.

have become obliterated by coalescence of their walls, so that the entire endoderm of the umbrella is in the condition of the endoderm-lamella. Next the opening of the umbrella closes up completely and disappears, so that the sub-umbrellar cavity forms a closed space surrounding the manubrium, on which the gonads are developed; such a condition is seen in the male gonophore of *Cladocoryne* and in *Garceia* (fig. 41, C), where, however, there is a further complication in the form of an adventitious envelope or ectotheca (ect.) split off from the gonophore as a protective covering, and not present in *Cladocoryne*. The sub-umbrellar cavity (s.c.) functions as a brood-space for the developing embryos, which are set free by rupture of the wall. It is evident that the outer envelope of the gonophore represents the ex-umbrellar ectoderm (ex.), and that the inner ectoderm lining the cavity represents the sub-umbrellar ectoderm of the free medusa. The next step is the gradual obliteration of the sub-umbrellar cavity

(s.c.) by disappearance of which the sub-umbrellar ectoderm comes into contact with the ectoderm of the manubrium. Such a type is found in *Plumularia* and also in *Agalma* (fig. 41, D); centrally is seen the spadix (sp.), bearing the generative cells (g), and external to these (1) a layer of ectoderm representing the epithelium of the manubrium; (2) the layer of sub-umbrellar ectoderm; (3) the endoderm-lamella (e.l.); (4) the ex-umbrellar ectoderm (ex.); and (5) there may or may not be present also an ectotheca. Thus the gonads are covered over not by at least four layers of epithelium, and since these are unnecessary, presenting merely obstacles to the dehiscence of the gonads, they gradually undergo reduction. The sub-umbrellar ectoderm and that covering the manubrium undergo conrescence to form a single layer (fig. 41, E), which finally disappears altogether, and the endoderm-lamella disappears. The gonophore is now reduced to its simplest condition, known as the *sporosac* (fig. 41, F, G, H), and consists of the spadix bearing the gonads covered by a single layer of ectoderm (ex.), with or without the addition of an ectotheca. It cannot be too strongly emphasized, however, that the sporosac should not be compared simply with the manubrium of the medusa, as is sometimes done. The endodermal spadix (sp.) of the sporosac represents the endoderm of the manubrium; the ectodermal lining of the sporosac (ex.) represents the ex-umbrellar ectoderm of the medusa; and the intervening layers, together with the sub-umbrellar cavity, have disappeared. The spadix, as the organ of nutrition for the gonads, may be developed in various ways, being simple (fig. 41, F) or branched (fig. 41, H); in *Eudendrium* (fig. 41, G) it curls round the single large ovum.

The hydroid *Dicoryne* is remarkable for the possession of gonophores, which are ciliate and become detached and swim away by means of their cilia. Each such sporosac has two long tentacle-like processes thickly ciliated.

It has been maintained that the gonads of *Hydra* represent sporosacs or gonophores greatly reduced, with the last traces of medusoid structure completely obliterated. There is, however, no evidence whatever for this, the gonads of *Hydra* being purely ectodermal structures, while all medusoid gonophores have an endodermal portion. *Hydra* is, moreover, bisexual, in contrast with what is known of hydroid colonies.

In some Leptomedusae the gonads are formed on the radial canals and form protruding masses resembling sporosacs superficially, but not in structure. Allman, however, regarded this type of gonad as equivalent to a sporosac, and considered the medusa bearing them as a non-sexual organism, a "blastocheme" as he termed it, producing by budding medusoid gonophores. As medusae are known to bud medusae from the radial canals there is nothing impossible in Allman's theory, but it cannot be said to have received satisfactory proof.

After Allman, *Gymnoblastic Hydroids*, by permission of the Council of the Ray Society.

FIG. 42.—Gonophores of *Dicoryne conferta*. A, A male gonophore still enclosed in its ectotheca. B and C, Two views of a female gonophore after liberation. O, Ova, two carried on each female gonophore. sp, Testis.

Reproduction and Ontogeny of the Hydromedusae.

Nearly every possible method of reproduction occurs amongst the Hydromedusae. In classifying methods of generation it is usual to make use of the sexual or non-sexual nature of the reproduction as a primary difference, but a more scientific classification is afforded by the distinction between tissue-cells

(bistocytes) and germinal cells, actual or potential (archaeocytes), amongst the constituent cells of the animal body. In this way we may distinguish, first, *vegetative* reproduction, the result of discontinuous growth of the tissues and cell-layers of the body as a whole, leading to (1) *fission*, (2) *autotomy*, or (3) *vegetative budding*; secondly, *germinal* reproduction, the result of the reproductive activity of the archaeocytes or germinal tissue. In germinal reproduction the proliferating cells may be *undifferentiated*, so-called primitive germ-cells, or they may be *differentiated* as sexual cells, male or female, i.e. spermatozoa and ova. If the germ-cells are *undifferentiated*, the offspring may arise from many cells or from a single cell; the first type is (4) *germinal budding*, the second is (5) *syngamy*. If the germ-cells are *differentiated*, the offspring arises by *syngamy* or sexual union of the ordinary type between an ovum and spermatozoon, so-called fertilization of the ovum, or by *parthenogenesis*, i.e. development of an ovum without fertilization. The only one of these possible modes of reproduction not known to occur in Hydromedusae is parthenogenesis.

(1) True *fission* or longitudinal division of an individual into two equal and similar daughter-individuals is not common but occurs in *Gastroblasta*, where it has been described in detail by Arnold Lang [30].

(2) *Autotomy*, sometimes termed transverse fission, is the name given to a process of unequal fission in which a portion of the body separates off with subsequent regeneration. In *Tubularia* by a process of decapitation the hydranths may separate off and give rise to a separate individual, while the remainder of the body grows a new hydranth. Similarly in *Schizocladium* portions of the hydrocaulus are cut off to form so-called "spores," which grow into new individuals (see Allman [1]).

(3) *Vegetative budding* is almost universal in the Hydromedusae. By budding is understood the formation of a new individual from a fresh growth of undifferentiated material. It is convenient to distinguish buds that give rise to polyps from those that form medusae.

(a) *The Polyp*.—The buds that form polyps are very simple in mode of formation. Four stages may be distinguished; the first is a simple outgrowth of both layers, ectoderm and endoderm, containing a prolongation of the calenteric cavity; in the second stage the tentacles grow out as secondary diverticula from the side of the first outgrowth; in the third stage the mouth is formed as a perforation of the two layers; and, lastly, if the bud is to be separated, it becomes nipped off from the parent polyp and begins a free existence.

(b) *The Medusae*.—Two types of budding must be distinguished—the *direct*, so-called palinogenetic type, and the *indirect*, so-called coenogenetic type.

The direct type of budding is rare, but is seen in *Cunina* and *Millepora*. In *Cunina* there arises, first, a simple outgrowth of both layers, as in a poly-pud (fig. 43, A); in this the mouth is formed distally as a perforation (B); next the sides of the tube so formed

bulge out laterally near the attachment to form the umbrella, while the distal undilated portion of the tube represents the manubrium (C); the umbrella now grows out into a number of lobes or lappets, and the tentacles and tentaculocysts grow out, the former in a notch between two lappets, the latter on the apex of each lappet (D, E); finally, the velum arises as a growth of the ectoderm alone, the whole bud shapes itself, so to speak, and the little medusa is separated off by rupture of the thin stalk connecting it with the parent (F). The direct method of medusa-budding only differs from the poly-pud by its greater complexity of parts and organs.

The indirect mode of budding (figs. 44, 45) is the commonest method by which medusae are formed. It is marked by the formation in the bud of a characteristic structure termed the *entocodon* (*Knospenkern*, *Glockenkern*).

The first stage is a simple hollow outgrowth of both body-layers (fig. 44, A); at the tip of this is formed a thickening of the ectoderm, arising primitively as a hollow ingrowth (fig. 44, B), but more usually as a solid mass of ectoderm-cells (fig. 45, A). The ectodermal ingrowth is the entocodon (Gc.); it bulges into, and pushes down, the endoderm at the apex of the bud, and if solid it soon acquires a cavity (fig. 44, C, s.c.). The cavity of the entocodon increases continually in size, while the endoderm pushes up at the sides of it to form a cup with hollow walls, enclosing but not quite surrounding the entocodon, which remains in contact at its outer side with the ectoderm covering the bud (fig. 44, D, E). The next changes that take place are chiefly in the endoderm-cup (fig. 44, D, E); the cavity between the two walls of the cup becomes reduced by concrescence to form a radial canal (r.c.), and endoderm lamella (e.l.), at the same time the base of the cup is thrust upwards to form the manubrium (m), converting the cavity of the entocodon into a

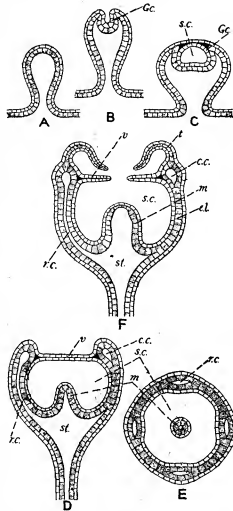

FIG. 44.—Diagrams of Medusa budding with the formation of an entocodon. The endoderm is shaded, the ectoderm left clear.

A, B, C, D, F, Successive stages in vertical section.  
E, Transverse section of a stage similar to D.  
Gc., Entocodon.  
s.c., Cavity of entocodon, forming the future sub-umbra l cavity.  
st., Stomach.  
r.c., Radial canal.  
e.l., Endoderm lamella.  
m., Manubrium.  
v., Velum.  
t., Tentacle.

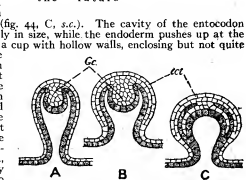

FIG. 45.—Modifications of the method of budding shown in figure 44, with solid Entocodon (Gc.) and formation of an ectotheca (ect.).

space which is crescentic or horse-shoe-like in section. Next tentacles of ectoderm on the distal side of the entocodon becomes perforated, leaving a circular rim composed of two layers of ectoderm, the velum (*v*) of the medusa. Finally, a mouth is formed by breaking through at the apex of the manubrium, and the now fully-formed medusa becomes separated by the rupture of the stalk of the bud and swims away.

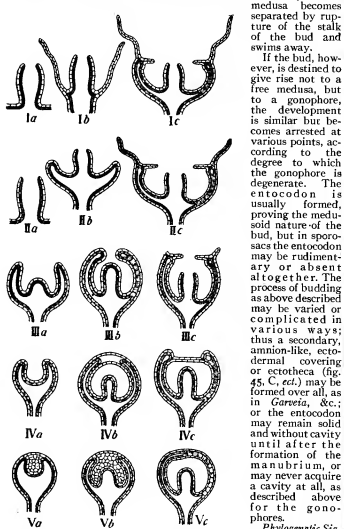

FIG. 46.—Diagrams to show the significance of the entocodon in Medusa-buds. (Modified from a diagram given by A. Weismann.)

- I, Ideally primitive method of budding in which the mouth is formed first (Ia), next the tentacles (Ib), and lastly the umbrella.
- II, Method of *Cunina*; (a) the mouth arises, next the umbrella (b), and lastly the tentacles (c).
- III, Hypothetical transition from II to the indirect method with an entocodon; the formation of the manubrium is retarded, that of the umbrella hastened (IIIa, b, c).
- IV, a, b, c, budding with an entocodon (cf. fig. 44).
- V, Budding with a solid entocodon (cf. fig. 45).

and of the sub-umbrellar cavity as far as the edge of the velum. Hence the entocodon represents a precocious formation of the sub-umbrellar surface, equivalent to the peristome of the polyp, differentiated in the bud prior to other portions of the organism which must be regarded as antecedent to it in phylogeny.

If the three principal organ-systems of the medusa, namely mouth, tentacles and umbrella, be considered in the light of phylogeny, it is evident that the manubrium bearing the mouth must be the oldest, as representing a common property of all the Coelentera, even of the gastrula embryo of all Enterzoa. Next in order come the tentacles, common to all Cnidaria. The special property of the medusa is the umbrella, distinguishing the medusa at once from other morphological types among the Coelentera. If, therefore, the formation of these three systems of organs took place according to

a strictly phylogenetic sequence, we should expect them to appear in the order set forth above (fig. 46, Ia, b, c). The nearest approach to the phylogenetic sequence is seen in the budding of *Cunina*, where the manubrium and mouth appear first, but the umbrella is formed before the tentacles (fig. 46, IIa, b, c). In the indirect or coenogenetic method of budding, the first two members of the sequence exhibited by *Cunina* change places, and the umbrella is formed first, the manubrium next, and then the tentacles; the actual mouth-perforation being delayed to the very last (fig. 46, IVa, b, c). Hence the budding of medusae exemplifies very clearly a common phenomenon in development, a phylogenetic series of events completely dissociated in the ontogenetic time-sequence.

The entocodon is to be regarded, therefore, not as primarily an ingrowth of ectoderm, but rather as an upgrowth of both body-layers, in the form of a circular rim (IVa), representing the umbrellar margin; it is comparable to the bulging that forms the umbrella in the direct method of budding, but takes place before a manubrium is formed, and is greatly reduced in size, so as to become a little pit. By a simple modification, the open pit becomes a solid ectodermal ingrowth, just as in Teleostean fishes the hollow medullary tube, or the auditory pit of other vertebrate embryos, is formed at first as a solid cord of cells, which acquires a cavity secondarily. Moreover, the entocodon, however developed, gives rise at first to a closed cavity, representing a closing over of the umbrella, temporary in the bud destined to be a free medusa, but usually permanent in the sessile gonophore. As has been shown above, the closing up of the sub-umbrellar cavity is one of the earliest degenerative changes in the evolution of the gonophore, and we may regard it as the umbrellar fold taking on a protective function, either temporarily for the bud or permanently for the gonophore.

To sum up, the entocodon is a precocious formation of the umbrella, closing over to protect the organs in the umbrellar cavity. The possession of an entocodon proves the medusa-nature of the bud, and can only be explained on the theory that gonophores are degenerate medusae, and is inexplicable on the opposed view that medusae are derived from gonophores secondarily set free. In the sporosacs, however, the medusa-individual has become so degenerate that even the documentary proof, so to speak, of its medusoid nature may have been destroyed, and only circumstantial evidence of its nature can be produced.

4. *Germinal Budding*.—This method of budding is commonly described as budding from a single body-layer, instead of from both layers. The layer that produces the bud is invariably the ectoderm, i.e. the layer in which, in Hydromedusae, the generative cells are lodged; and in some cases the buds are produced in the exact spot in which later the gonads appear. From these facts, and from those of the sporogony, to be described below, we may regard budding to this type as taking place from the germinal epithelium rather than from ordinary ectoderm.

(a) *The Polyp*.—Budding from the ectoderm alone has been described by A. Lang [29] in *Hydra* and other polyps. The tissues of the bud become differentiated into ectoderm and endoderm, and the endoderm of the bud becomes secondarily continuous with that of the parent, but no part of the parental endoderm contributes to the building up of the daughter-polyp. Lang regarded this method of budding as universal in polyps, a notion disproved by O. Seeliger [52] who went to the opposite extreme and regarded the type of budding described by Lang as non-existent. In view, however, both of the arguments and figures of Lang and of the facts to be described presently for medusae (*Margellium*), it is at least theoretically possible that both germinal and vegetative budding may occur in polyps as well as in medusae.

(b) *The Medusa*.—The clearest instance of germinal budding is furnished by *Margellium (Rathkea) octopunctatum*, one of the *Margelidae*. The budding of this medusa has been worked out in detail by Chun (HYDROZOA, [1]), to whom the reader must be referred for the interesting laws of budding regulating the sequence and order of formation of the buds.

The buds of *Margellium* are produced on the manubrium in each of the four interradial, and they arise from the ectoderm, that is to say, the germinal epithelium, which later gives rise to the gonads. The buds do not appear simultaneously but successively on each of the

four sides of the manubrium, thus:  $\begin{matrix} 1 & & 4 \\ & 2 & \\ & & 3 \end{matrix}$  and secondary buds

may be produced on the medusa-buds before the latter are set free as medusae. Each bud arises as a thickening of the epithelium, which first forms two or three layers (fig. 47, A), and becomes separated into a superficial layer, future ectoderm, surrounding a central mass, future endoderm (fig. 47, B). The ectodermal epithelium on the distal side of the bud becomes thickened, grows inward, and forms a typical entocodon (fig. 37, D, E, F). The remaining development of the bud is just as described above for the indirect method of medusa-budding (fig. 47, G, H). When the bud is nearly complete, the body-wall of the parent immediately below it becomes perforated, placing the coelenteric cavity of the parent in secondary communication with that of the bud (H), doubtless for the better nutrition of the latter.

Especially noteworthy in the germinal budding of *Margellium* is the formation of the ectocodon, as in the vegetative budding of the indirect type.

5. *Sporogony*.—This method of reproduction has been described by E. Metchnikoff in *Cunina* and allied genera. In individuals either of the male or female sex, germ-cells which are quite undifferentiated and neutral in character, become amoeboid, and wander into the endoderm. They divide each into two sister-cells, one of which—the spore—becomes enveloped by the other. The spore-cell multiplies by division, while the enveloping cell is nutrient and protective. The spore cell gives rise to a "spore-larva," which is set free in the coelenteron and grows into a medusa. Whether sporogony occurs also in the polyp or not remains to be proved.

6. *Sexual Reproduction and Embryology*.—The ovum of Hydromedusae is usually one of a large number of oögonia, and grows at the expense of its sister-cells. No regular follicle is formed, but the oöcyte absorbs nutriment from the remaining oögonia. In *Hydra* the oöcyte is a large amoeboid cell, which sends out pseudopodia amongst the oögonia and absorbs nutriment from them. When the oöcyte is full grown, the residual oögonia die off and disintegrate.

The spermatogenesis and maturation and fertilization of the germ-cells present nothing out of the common and need not be

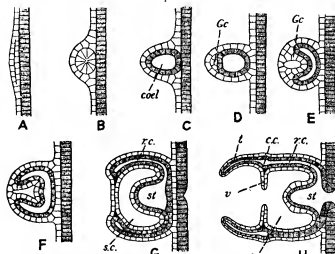

FIG. 47.—Budding from the Ectoderm (germinal epithelium) in *Margellium*. (After C. Chun.)

- A, The epithelium becomes two-layered.  
 B, The lower layer forms a solid mass of cells, which (C) becomes a vesicle, the future endoderm, containing the coelenteric cavity (coel), while the outer layer furnishes the future ectoderm.  
 D, E, F, a thickening of the ectoderm on the distal side of the bud forms an ectocodon (Gc.).  
 G, H, Formation of the medusae.  
 s.c., Sub-umbra cavity.  
 r.c., Radial canal.  
 st, Stomach, which in H acquires a secondary communication with the digestive cavity of the mother.  
 c.c., Circular canal.  
 v, Velum.  
 t, Tentacle.

described here. These processes have been studied in detail by A. Brauer [2] for *Hydra*.

The general course of the development is described in the article HYDROZOA. We may distinguish the following series of stages: (1) ovum; (2) cleavage, leading to formation of a blastula; (3) formation of an inner mass or parenchyma, the future endoderm, by immigration or delamination, leading to the so-called parenchymula-stage; (4) formation of an archenteric cavity, the future coelenteron, by a splitting of the internal parenchyma, and of a blastopore, the future mouth, by perforation at one pole, leading to the gastrula-stage; (5) the outgrowth of tentacles round the mouth (blastopore), leading to the actinula-stage; and (6) the actinula becomes the polyp or medusa in the manner described elsewhere (see articles HYDROZOA, POLYP and MEDUSA). This is the full, ideal development, which is always contracted or shortened to a greater or less extent. If the embryo is set free as a free-swimming, so-called planula-larva, in the blastula, parenchymula, or gastrula stage, then a free actinula stage is not found; if, on the other hand, a free actinula occurs, then there is no free planula stage.

The cleavage of the ovum follows two types, both seen in *Tubularia* (Brauer [3]). In the first, a cleavage follows each nuclear division; in the second, the nuclei multiply by division a number of times, and then the ovum divides into as many blastomeres as there are nuclei present. The result of cleavage in all cases is a typical blastula, which when set free becomes oval and develops a flagellum to each cell, but when not set free, it remains spherical in form and has no flagella.

The germ-layer formation is always by immigration or delamination, never by invagination. When the blastula is oval and free-swimming the inner mass is formed by unipolar immigration from the hinder pole. When the blastula is spherical and not set free, the germ-layer formation is always multipolar, either by immigration or by delamination, i.e. by tangential division of the cells of the blastoderm, as in *Geryonia*, or by a mixture of immigration and delamination, as in *Hydra*, *Tubularia*, etc. The blastopore is formed as a secondary perforation at one spot, in free-swimming forms at the hinder pole. Formation of archenteron and blastopore may, however, be deferred till a later stage (actinula or after).

The actinula stage is usually suppressed or not set free, but it is seen in *Tubularia* (fig. 48), where it is ambulatory, in *Gonionemus* (Trachomedusae), and in *Cunina* (Narcomedusae), where it is parasitic.

In Leptolinae the embryonic development culminates in a polyp, which is usually formed by fixation of a planula (parenchymula), rarely by fixation of an actinula. The planula may fix itself (1) by one end, and then becomes the hydrocaulus and hydranth, while the hydrothiza grows out from the base; or (2) partly by one side and then gives rise to the hydrothiza as well as to the other parts of the polyp; or (3) entirely by its side, and then forms a recumbent hydro-floccus from which a polyp appears to be budded as an upgrowth.

In Trachylinae the development produces directly a medusa, and there is no polyp-stage. The medusa arises direct from the actinula-stage and there is no ectocodon formed, as in the budding described above.

*Life-cycles of the Hydromedusae*.—The life-cycle of the Leptolinae consists of an alternation of generations in which non-sexual individuals, polyps, produce by budding sexual individuals, medusae, which give rise by the sexual process to the non-sexual polyps again, so completing the cycle. Hence the alternation is the type termed metagenesis. The Leptolinae are chiefly forms belonging to the inshore fauna. The Trachylinae, on the other hand, are above all oceanic forms, and have no polyp-stage, and hence there is typically no alternation in their life-cycle. It is commonly assumed that the Trachylinae are forms which have lost the alternation of generations possessed by them ancestrally, through secondary simplification of the life-cycle. Hence the Trachylinae are termed "hypogenetic" medusae to contrast them with the metagenetic Leptolinae. The whole question has, however, been argued at length by W. K. Brooks [4], who adduces strong evidence for a contrary view, that is to say, for regarding the direct type of development seen in Trachylinae as more primitive, and the metagenesis seen in Leptolinae as a secondary complication introduced into the life-cycle by the acquisition of larval budding. The polyp is regarded, on this view, as a form phylogenetically older than the medusa, in short, as nothing more than a sessile actinula. In Trachylinae the polyp-stage is passed over, and is represented only by the actinula as a transitory embryonic stage. In Leptolinae the actinula becomes the sessile polyp which has acquired the power of budding and producing individuals either of its own or of a higher rank; it represents a persistent larval stage and remains in a sexually immature condition as a neutral individual, sex being an attribute only of the final stage in the development, namely the medusa. The polyp of the Leptolinae has reached the limit of its individual development and is incapable of becoming itself a medusa, but only produces medusa-buds; hence a true alternation of generations is produced. In Trachylinae also the beginnings of this similar metagenesis can be found. Thus in *Cunina octoria* the ovum develops into an actinula which buds daughter-actinulae, all of them, both parent and offspring, develop into medusae, so that there is no alternation of generations, but only larval multiplication. In *Cunina parasitica*, however, the ovum develops into an actinula, which buds actinulae as before, but only the daughter-actinulae develop into medusae, while the original, parent-actinula dies off; here, therefore, larval budding has led to a true alternation of generations. In *Gonionemus* the actinula becomes fixed and polyp-like, and reproduces by budding, so that here also an alternation of generations may occur. In the Leptolinae we must first substitute polyp for actinula, and then a condition is found which can be compared to the case of *Cunina parasitica* or *Gonionemus*, if we suppose that neither the parent-actinula (i.e. founder-polyp) nor its offspring by budding (polyps of the colony) have the power of becoming medusae, but only of producing medusae by budding. For further arguments and illustrations the reader must be referred to Brooks's most interesting memoir. The whole theory is one most



Modified from a plate by L. Agassiz, Contributions to Nat. Hist. U.S., iv.

FIG. 48.—Free Actinula of *Tubularia*.



intimately connected with the question of the relation between polyp and medusa, to be discussed presently. It will be seen elsewhere, however, that whatever view may be held as to the origin of metagenesis in Hydromedusae, in the case of Scyphomedusae (*q.v.*) no other view is possible than that the alternation of generations is the direct result of larval proliferation.

To complete our survey of life-cycles in the Hydromedusae it is necessary to add a few words about the position of *Hydra* and its allies. If we accept the view that *Hydra* is a true sexual polyp, and that its gonads are not gonophores (*i.e.* medusa-buds) in the extreme of degeneration, then it follows from Brooks's theory that *Hydra* must be descended from an archaic form in which the medusan type of organization had not yet been evolved. *Hydra* must, in short, be a living representative of the ancestor of which the actinula-stage is a transient reminiscence in the development of higher forms. It may be pointed out in this connexion that the fixation of *Hydra* is only temporary, and that the animal is able at all times to detach itself, to move to a new situation, and to fix itself again. There is no difficulty whatever in regarding *Hydra* as bearing the same relation to the actinula-stage of other Hydromedusae that a Rotifer bears to a trochophore-larva or a fish to a tadpole.

*The Relation of Polyp and Medusa.*—Many views have been put forward as to the morphological relationship between the two types of person in the Hydromedusae. For the most part, polyp and medusa have been regarded as modifications of a common type, a view supported by the existence, among Scyphomedusae (*q.v.*), of sessile polyp-like medusae (*Lucernaria*, &c.). R. Leuckart in 1848 compared medusae in general terms to flattened polyps. G. J. Allman [1] put forward a more detailed view, which was as follows. In some polyps the tentacles are webbed at the base, and it was supposed that a medusa was a polyp of this kind set free, the umbrella being a greatly developed web or membrane extending between the tentacles. A very different theory was enunciated by E. Metchnikoff. In some hydroids the founder-polyp, developed from a planula after fixation, throws out numerous outgrowths from the base to form the hydrorhiza; these outgrowths may be radially arranged so as to form by contact or coalescence a flat plate. Metchnikoff considered the plate thus formed at the base of the polyp as equivalent to the umbrella, and the body of the polyp as equivalent to the manubrium, of the medusa; on this view the marginal tentacles almost invariably present in medusae are new formations, and the tentacles of the polyp are represented in the medusa by the oral arms which may occur round the mouth, and which sometimes, *e.g.* in *Margelidae*, have the appearance and structure of tentacles. Apart from the weighty arguments which the development furnishes against the theories of Allman and Metchnikoff, it may be pointed out that neither hypothesis gives a satisfactory explanation of a structure universally present in medusae of whatever class, namely the endoderm-lamella, discovered by the brothers O. and R. Hertwig. It would be necessary to regard this structure as a secondary extension of the endoderm in the tentacle-web, on Allman's theory, or between the outgrowths of the hydrorhiza, on Metchnikoff's hypothesis. The development, on the contrary, shows unequivocally that the endoderm-lamella arises as a local coalescence of the endodermal linings of a primitively extensive gastral space.

The question is one intimately connected with the view taken as to the nature and individuality of polyp, medusa and gonophore respectively. On this point the following theories have been put forward.

1. The theory that the medusa is simply an *organ*, which has become detached and has acquired a certain degree of independence, like the well-known instance of the hectocotyle of the cuttle-fish. On this view, put forward by E. van Beneden and T. H. Huxley, the sporosac is the starting-point of an evolution leading up through the various types of gonophores to the free medusa as the culminating point of a phyletic series. The evidence against this view may be classed under two heads: first, comparative evidence; hydroids very different in their structural characters and widely separate in the systematic classification of these organisms may produce medusae very similar, at least so far as the essential features of medusan organization are concerned; on the other hydroids closely allied, perhaps almost indistinguishable, may produce gonophores in the one case medusae, in the other for example *Hydractinia* (gonophores) and *Podocoryne* (medusae), *Tubularia* (gonophores) and *Ectopleura* (medusae), *Coryne* (gonophores) and *Synonymyne* (medusae), and so on. If it is assumed that all these genera bore gonophores ancestrally, then medusa of similar type must have been evolved quite inde-

pendently in a great number of cases. Secondly, there is the evidence from the development, namely, the presence of the entocodon in the medusa-bud, a structure which, as explained above, can only be accounted for satisfactorily by derivation from a medusan type of organization. Hence it may be concluded that the gonophores are degenerate medusae, and not that the medusae are highly elaborated gonophores, as the organ-theory requires.

2. The theory that the medusa is an independent individual, fully equivalent to the polyp in this respect, is now universally accepted as being supported by all the facts of comparative morphology and development. The question still remains open, however, which of the two types of person may be regarded as the most primitive, the most ancient in the race-history of the Hydromedusae. F. M. Balfour put forward the view that the polyp was the more primitive type, and that the medusa is a special modification of the polyp for reproductive purposes, the result of division of labour in a polyp-colony, whereby special reproductive persons become detached and acquire organs of locomotion for spreading the species. W. K. Brooks, or the other hand, as stated above, regards the medusa as the older type and looks upon both polyp and medusa, in the Hydromedusae, as derived from a free-swimming or floating actinula, the polyp being thus merely a fixed nutritive stage, possessing secondarily acquired powers of multiplication by budding.

The Hertwigs when they discovered the endoderm-lamella showed on morphological grounds that polyp and medusa are independent types, each produced by modification in different directions of a more primitive type represented in development by the actinula-stage. Polyp, such as *Hydra*, be regarded simply as a sessile actinula, we must certainly consider the polyp to be the older type, and it may be pointed out that in the Anthozoa only polyp-individuals occur. This must not be taken to mean, however, that the medusa is derived from a sessile polyp; it must be regarded as a direct modification of the more ancient free actinula form, without primitively any intervening polyp-stage, such as has been introduced secondarily into the development of the Leptolinae and represents a revival, so to speak, of an ancestral form or larval stage, which has taken on a special role in the economy of the species.

#### SYSTEMATIC REVIEW OF THE HYDROMEDUSAE

**ORDER I. Eleutheroblastea.**—Simple polyps which become sexually mature and which also reproduce non-sexually, but without any medusoid stage in the life-cycle.

The sub-order includes the family *Hydridae*, containing the common fresh-water polyps of the genus *Hydra*. Certain other forms of doubtful affinities have also been referred provisionally to this section.

*Hydra.*—This genus comprises fresh-water polyps of simple structure. The body bears tentacles, but shows no division into hydrorhiza, hydrocaulus or hydranth; it is temporarily fixed and has no perisarc. The polyp is usually hermaphrodite, developing both ovaries and testes in the same individual. There is no free-swimming planula larva, but the stage corresponding to it is passed over in an enveloping cyst, which is secreted round the embryo by its own ectodermal layer, shortly after the germ-layer formation is complete, *i.e.* in the parenchymula-stage. The envelope is double, consisting of an external chitinous stratified shell, and an internal thin elastic membrane. Protected by the double envelope, the embryo is set free as a so-called "egg," and in Europe it passes the winter in this condition. In the spring the embryo bursts its shell and is set free as a minute actinula which becomes a *Hydra*.

Many species are known, of which three are common in European waters. It has been shown by C. F. Jickell (28) that the species are distinguishable by their characters when their nematocysts are absent. They also show characteristic differences in the egg (Brauer [2]). In *Hydra viridis* the polyp is of a green colour and produces a spherical egg with a smooth shell which is dropped into the mud. *H. grisea* is greyish in tint and produces a spherical egg with a spiky shell, which also is dropped into the mud. *H. fusca* (= *H. vulgaris*) is brown in colour, and produces a bun-shaped egg, spiky on the convex surface, and attached to a water-weed or some object by its flattened side. Brauer found a fourth species, similar in appearance to *H. fusca*, but differing from the three other species in being of separate sexes, and producing a spherical egg with a knobly shell, which is attached like that of *H. fusca*.

The fact already noted that the species of *Hydra* can be distinguished by the characters of their nematocysts is a point of great interest. In each species, two or three kinds of nematocysts occur, some large, some small, and for specific identification the nematocysts must be studied collectively in each species. It is very remarkable that this method of characterizing and diagnosing species has never been extended to the marine hydroids. It is quite possible that the characters of the nematocysts might afford data as useful to the systematist in this group as do the spicules of sponges, for instance. It would be particularly interesting to ascertain how the nematocysts of a polyp are related to those possessed by the medusa bud from it, and it is possible that in this manner obscure questions of relationship might be cleared up.

*Protohydra* is a marine genus characterized by the absence of tentacles, by a great similarity to *Hydra* in histological structure, and by reproduction by transverse fission. It was found originally in an oyster-farm at Ostend. The sexual reproduction is unknown. For further information see C. Chun (HYDROZOA [1], Pl. 1).

*Polypodium hydriforme* Ussow is a fresh-water form parasitic on the eggs of the sterlet. A "stolon" of unknown origin produces thirty-two buds, which become as many *Polypodia*; each has twenty-four tentacles and divides by fission repeated twice into four individuals, each with six tentacles. The daughter-individuals grow, form the full number of twenty-four tentacles and divide again. The polyps are free and walk on their tentacles. See Ussow [54].

*Tetraplata volitans* Viguier is a remarkable floating marine form. See C. Viguier [56] and Delage and Hérouard (HYDROZOA [2]).

*Halereimia* Schaudinn. See F. Schaudinn [50] and Delage and Hérouard (HYDROZOA [2]).

In all the above-mentioned genera, with the exception of *Hydra*, the life-cycle is so imperfectly known that their true position cannot be determined in the present state of our knowledge. They may prove eventually to belong to other orders. Hence only the genus *Hydra* can be considered as truly representing the order Eleutheroblastea. The phylogenetic position of this genus has been discussed above.

FIG. 49.—Diagram showing possible modifications of persons of a gymnoblastic *Hydromedusa*. (After Allman.)

- a, Hydrocaulus (stem).
- b, Hydorrhiza (root).
- c, Enteric cavity.
- d, Endoderm.
- e, Ectoderm.
- f, Perisarc, (horny case).
- g, Hydranth (hydriform person) expanded.
- g', Hydranth (hydriform person) contracted.
- h, Hypostome, bearing mouth at its extremity.
- k, Spososac springing from the hydrocaulus.
- k', Spososac springing from m, a modified hydriform person (blastostyle): the genitalia are seen surrounding the spadix or manubrium.
- l, Medusiform person or medusa.
- m, Blastostyle.

a polyp-colony. The polyp usually has the body distinctly divisible into hydranth, hydrocaulus and hydorrhiza, and is usually clothed in a perisarc. The medusae may be set free or may remain attached to the polyp-colony and degenerate into a gonophore. When fully developed the medusa is characterized by the sense organs being composed entirely of ectoderm, developed independently of the tentacles, and innervated from the sub-umbrellar nerve-ring.

The two kinds of persons present in the typical Hydrozoa make the classification of the group extremely difficult, for reasons explained above. Hence the systematic arrangement that follows must be considered purely provisional. A natural classification of the Hydrozoa has yet to be put forward. Many genera and families are separated by purely artificial characters, mere shelf-and-bottle groupings devised for the convenience of the museum curator and the collector. Thus many subdivisions are diagnosed by setting free medusae in one case, or producing gonophores in another, although it is very obvious, as pointed out above, that a genus producing medusae may be far more closely allied to one producing gonophores than to another producing medusae, or vice versa, and

that in some cases the production of medusae or gonophores varies with the season or the sex. Moreover, P. Hallez [22] has recently shown that hydroids hitherto regarded as distinct species are only forms of the same species grown under different conditions.

**SUB-ORDER I. HYDROZOA GYMNOBLASTEA (ANTHOMEDUSAE).**  
—Trophosome without hydrotheca or gonotheca, with monopodial type of budding. Gonosome with free medusae or gonophores; medusae usually with ocelli, never with otocysts. The gymnoblastic polyp usually has a distinct perisarc investing the hydorrhiza and the hydrocaulus, sometimes also the hydranth as far as the bases of the tentacles (*Bimeria*); but in such cases the perisarc forms a closely-fitting investment or cuticle on the hydranth, never a hydrotheca standing off from it, as in the next sub-order. The polyps may be solitary, or form colonies, which may be of the spreading or encrusting type, or arborescent, and then always of monopodial growth and budding. In some cases, any polyp of the colony may bud medusae; in other cases, only certain polyps, the blastostyles, have this power. When blastostyles are present, however, they are never enclosed



FIG. 50.—*Sarsia* (*Dipurena*) *gemmifera*. b, The long manubrium, bearing medusiform buds; a, mouth.

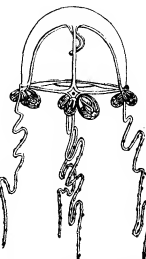

FIG. 51.—*Sarsia prolifera*. Ocelli are seen at the base of the tentacles, and also (as an exception) groups of medusiform buds.

in special gonothecae as in the next sub-order. In this sub-order the characters of the hydranth are very variable, probably owing to the fact that it is exposed and not protected by a hydrotheca, as in Calypoblastea.

Speaking generally, three principal types of hydranth can be distinguished, each with subordinate varieties of form.

1. Club-shaped hydranths with numerous tentacles, generally scattered irregularly; sometimes with a spiral arrangement, or in whorls ("verticillate").
  - (a) Tentacles filiform; type of *Clava* (fig. 5), *Cordylophora*, &c.
  - (b) Tentacles capitate, simple; type of *Coryne* and *Syncoryne*; *Myriothela* is an aberrant form with some of the tentacles modified as "claspers" to hold the ova.
  - (c) Tentacles capitate, branched, wholly or in part; type of *Cladocoryne*.
  - (d) Tentacles filiform or capitate, tending to be arranged in definite whorls; type of *Stauridium* (fig. 2), *Cladonema* and *Pennaria*.
2. Hydranth more shortened, daisy-like in form, with two whorls of tentacles, oral and aboral.
  - (a) Tentacles filiform, simple, radially arranged or scattered irregularly; type of *Tubularia* (fig. 4), *Corymorpha* (fig. 3), *Nemopsis*, *Polagohydra*, &c.
  - (b) Tentacles with a bilateral arrangement, branched tentacles in addition to simple filiform ones; type of *Branchioceranthus*.
3. Hydranth with a single circle of tentacles.
  - (a) With filiform tentacles; the commonest type, seen in *Bougainvillea* (fig. 13), *Eudendrium*, &c.
  - (b) With capitate tentacles; type of *Clavella*.
4. Hydranth with tentacles reduced below four; type of *Lar* (fig. 11), *Monobranchium*, &c.

The *Anthomedusa* in form is generally deep, bell-shaped. The sense organs are typically ocelli, never otocysts. The gonads are borne on the manubrium, either forming a continuous ring (Codonid type), or four masses or pairs of masses (Oceanid type). The tentacles may be scattered singly round the margin of the umbrella ("monerenematous") or arranged in tufts ("lophonematous"); in form they may be simple or branched (Cladonemid type); in structure they may be hollow ("coelomerinthous"); or solid ("pyncomerinthous"). When sessile gonophores are produced, they may show all stages of degeneration.

**Classification.**—Until quite recently the hydroids (Gymnoblastera) and the medusae (Anthomedusae) have been classified separately, since the connexion between them was insufficiently known. Delage and Hérouard (HYDROZOA [2]) were the first to make an heroic attempt to unite the two classifications into one, to which Hieckens (HYDROZOA [4]) has made some additions and slight modifications. The classification given here is for the most part that of Delage and Hérouard. It is certain, however, that no such classification can be considered final at present, but must undergo continual revision in the future. With this reservation we may recognize fifteen well-characterized families and others of more doubtful nature. Certain discrepancies must also be noted.

1. *Margelidae*.—Medusa-family *Margelidae*+hydroid families *Bougainvilleidae*, *Dicorynidae*, *Bimeridae* and *Eudendriidae*. Trophosome arboreo-erect, with hydranths of *Bougainvillea*-type; gonosome free medusae or gonophores, the medusae with solid tentacles in tufts (lophonematous). Common genera are the hydroid *Bougainvillea* (figs. 12, 13), and the medusae *Hippocrene* (budded from *Bougainvillea*), *Margelis*, *Rathkea* (fig. 24), and *Margelium*. Other hydroids are *Garveia*, *Bimeria*, *Eudendrium* and *Heterocordyle*, with gonophores, and *Dicoryne* with peculiar sporosacs.

2. *Podocoryniidae*.—(Medusa-families *Thamnosomiidae* and *Cytaeidae*+hydroid families *Podocoryniidae* and *Hydractiniidae*). Trophosome encrusting with hydranths of *Bougainvillea*-type; polyps differentiated into blastostyles, gastrozooids and dactylozooids; gonosome free medusae or gonophores. The typical genus is the well-known hydroid *Podocoryne*, budding the medusa known as *Dysmorphosa*; *Thamnosyllus*, *Cytaea*, &c. other medusae with unknown hydroids. *Hydractinia* (figs. 9, 10) is a familiar hydroid genus, bearing gonophores.

3. *Cladonemidae*.—Trophosome; polyps with two whorls of tentacles, the lower filiform, the upper capitate; gonosome, free medusae, with tentacles solid and branched. The type-genus *Cladonema* (fig. 20) is a common British form.

4. *Clavatiellidae*.—Trophosome; polyps with a single whorl of capitate tentacles; gonosome, free medusae, with tentacles branched, solid. *Clavatiella* (fig. 21), with a peculiar ambulatory medusa is a British form.

5. *Pennariidae*.—Trophosome; polyps with an upper circle of numerous capitate tentacles, and a lower circle of filiform tentacles. *Pennaria*, with a free medusa known as *Globleps*, is a common Mediterranean form. *Nauridium* (fig. 2) is a British hydroid.

6. *Tubulariidae*.—Trophosome; polyps with two whorls of tentacles, both filiform. *Tubularia* (fig. 4), a well-known British hydroid, bears gonophores.

7. *Corymorphidae* (including the medusa-family *Hybocodonidae*).—Trophosome solitary polyps, with two whorls of tentacles; gonosome, free medusae or gonophores. *Corymorpha* (fig. 3), a well-known British genus, sets free a medusa known as *Steenstrupia* (fig. 22): Here belong the deep-sea genera *Monocaulus* and *Branchioceranthus*, including the largest hydroid polyps known, both genera producing sessile gonophores.

8. *Dendrocloniidae*.—Trophosome, polyp with filiform tentacles in three or four whorls. *Dendroclonia*, a hydroid, produces the medusa known as *Turritopsis*.

9. *Clavidae* (including the medusa-family *Tiaridae* (figs. 27 and 51)). Trophosome, polyps with scattered filiform tentacles; gonosome, medusae or gonophores, the medusae with hollow tentacles. *Clava* (fig. 5), a common British hydroid, produces gonophores; so also does *Cordylophora*, a form inhabiting fresh or brackish water. *Turris* produces free medusae. *Amphimeris* is a medusan genus of unknown hydroid.

10. *Bythotiariidae*.—Trophosome unknown; gonosome, free medusae, with deep, bell-shaped umbrella, with interradial gonads on the base of the stomach, with branched radial canals, and correspondingly numerous hollow tentacles. *Bythotaria*, *Sibogita*.

11. *Corynidae*.—Hydroid families *Coryniidae*, *Syncoryniidae* and *Cladocoryniidae*+medusan family *Sarsiidae*.—Trophosome polyps with capitate tentacles, simple or branched, scattered or verticillate; gonosome, free medusae or gonophores. *Coryne*, a common British hydroid, produces gonosomes; *Syncoryne*, indistinguishable from it, produces medusae known as *Sarsia* (fig. 51). *Cladocoryne* is another hydroid genus; *Codonium* and *Dipirena* (fig. 50) are medusan genera.

12. *Myriothelidae*.—The genus *Myriothela* is a solitary polyp with scattered capitate tentacles, producing sporosacs.

13. *Hydractariidae*.—Trophosome (only known in one genus), polyps with two tentacles forming a creeping colony; gonosome, free medusae with four or more radial canals giving off one or more lateral branches which run to the margin of the umbrella, with the stomach produced into four, six or more lobes, upon which the gonads are developed; the mouth with four lips or with a folded margin; the tentacles simple, arranged evenly round the margin of the umbrella. The remarkable hydroid *Las* (fig. 11) grows upon the tubes of the worm *Sabella* and produces a medusa known as *Willia*. Another medusan genus is *Proboosciactyla*.

14. *Monobrachiidae*.—The genus *Monobrachium* is a colony-forming hydroid which grows upon the shells of bivalve molluscs, each polyp having but a single tentacle. It buds medusae, which, however, are as yet only known in an immature condition (C. Merschowsky [41]).

15. *Ceratiellidae*.—Trophosome polyps forming branching colonies of which the stem and main branches are thick and composed of a network of anastomosing coenosarcial tubes covered by a common ectoderm and supported by a thick chitinous perisarc; hydranths similar to those of *Coryne*; gonosome, sessile gonophores. *Ceratiella*, an exotic genus from the coast of East Africa, New South Wales and Japan. The genera *Dehtella* Gray and *Dendrocoryne* Taba should perhaps be referred to this family; the last-named is regarded by S. Goto [16] as the type of a distinct family, *Dendrocoryniidae*.

Doubtful families, or forms difficult to classify, are: *Pteronemidae*, Medusae of Cladonemid type, with hydroids for the most part unknown. The British genus *Gemmaria*, however, is budded from a hydroid referable to the family *Coryniidae*. *Pteronema* (fig. 53).

*Nemopsidae*, for the floating polyp *Nemopsis*, very similar to *Tubularia* in character. The medusa, on the other hand, is very similar to *Hippocrene* (*Marquetia*). See C. Chun (HYDROZOA [1]).

*Pelagohydridae*, for the floating polyp *Pelagohydra*. Dendy, from New Zealand. The animal is a solitary polyp bearing a great number of medusa-buds. The body, representing the hydranth of an ordinary hydroid, has the aboral portion modified into a float, from which hangs down a proboscis bearing the mouth. The float is covered with long tentacles and bears the medusa-buds. The proboscis bears at its extremity a circle of smaller oral tentacles. Thus the affinities of the hydranth are clearly, as Dendy points out,



After Haeckel, *System der Medusen*, by permission of Gustav Fischer.

FIG. 53.—*Pteronema darwini*. The apex of the stomach is prolonged into a brood pouch containing embryos.

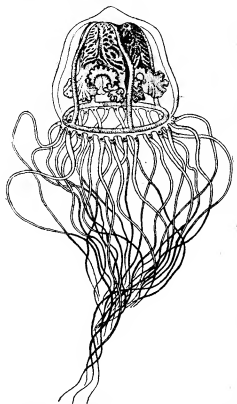

After Haeckel, *System der Medusen*, by permission of Gustav Fischer.

FIG. 52.—*Tiara pileata*, L. Agassiz.

with a form such as *Corymorpha*, which also is not fixed but only rooted in the mud. The medusae, on the other hand, have the tentacles in four tufts of (in the buds) five each, and thus resemble the medusae of the family *Margelidae*.

See A. Dendy [12].

*Perigonium*.—This common British hydroid belongs by its characters to the family *Bougainvillidae*; it produces, however, a medusa of the genus *Tiara* (fig. 52), referable to the family *Clavidae*; a fact sufficient to indicate the tentative character of even the most modern classifications of this order.

**SUB-ORDER II. HYDROIDEA CALYPTOBLASTEAE (LEPTOMEDUSAE).**—Trophosome with polyps always differentiated into nutritive and reproductive individuals (blastostyles) enclosed in hydrothecae and gonothecae respectively; with sympodial type of budding. Gonosome with free medusae or gonophores; the medusae typically with otcysts, sometimes with cordyl or ocelli (figs. 54, 55).

The calyptoblastic polyp of the nutritive type is very uniform in character, its tendency to variation being limited, as it were, by the enclosing hydrotheca. The hydranth almost always has a single circle of tentacles, like the *Bougainvillea*-type in the preceding sub-order; an exception is the curious genus *Clathrocoon*, in which the hydranth has a single tentacle. The characteristic hydrotheca is formed by the bud at an early stage (fig. 56); when complete it is an open cup, in which the hydranth develops and can be protruded from the opening for the capture of food, or is withdrawn into it for protection. Solitary polyps are unknown in this sub-order; the colony may be creeping or arborescent in form; if the latter, the budding of the polyps, as already stated, is of the sympodial type, and either biserial, forming stems capable of further branching, or uniserial, forming

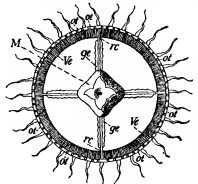

FIG. 55.—View of the Oral Surface of one of the *Leptomedusa* (*Irene pellucida*, Hackel), to show the numerous tentacles and the otcysts. *gc*, Genital glands. *rc*, The four radial *M*, Manubrium. *ot*, Otcysts. *Ve*, The velum.

pinnae not capable of further branching. In the biserial type the polyps on the two sides of the stem have primitively an alternating, zigzag arrangement; but, by a process of differential growth, quickened in the 1st, 3rd, 5th, &c., members of the stem, and retarded in the 2nd, 4th, 6th, &c., members, the polyps

may assume secondarily positions opposite to one another on the two sides of the stem. Other variations in the mode of growth or budding bring about further differences in the building up of the colony, which are not in all cases properly understood and cannot be described in detail here. The stem may contain a single coenosarcal tube ("monosiphonic") or several united in a common perisarc ("polysiphonic"). An important variation is seen, in the form of the hydrotheca itself, which may come off from the main stem by a stalk, as in *Obeia*, or may be sessile, without a stalk, as in *Sertularia*.

In many Calyptoblastea there occur also reduced defensive polyps or dactyloids, which in this sub-order have received the special name of *sarcostyles*. Such are the "snake-like zoids" of *Ophiodes* and other genera, and as such are generally interpreted the "machopolyps" of the *Plumularidae*. These organs are supported by cup-like structures of the perisarc, termed nematophores, regarded as modified hydrothecae supporting the specialized polyp-individuals. They are specially characteristic of the family *Plumularidae*.

The medusa-buds, as already stated, are always produced from blastostyles, reduced non-nutritive polyps without mouth or tentacles. An apparent, but not real, exception is *Halectium halectinum*, in which the blastostyle is produced from the side of a nutritive polyp, and both are enclosed in a common theca without a partition between them (Allman [1] p. 50, fig. 24). The gonotheca is formed in its early stage in the same way as the hydrotheca, but the remains of the hydranth persists as an operculum closing the capsule, to be withdrawn when the medusae or genital products are set free (fig. 56).

The blastostyles, gonophores and gonothecae furnish a series of variations which can best be considered as so many stages of evolution.

Stage 1, seen in *Obeia*. Numerous medusae are budded successively within the gonotheca and set free; they swim off and mature in the open sea (Allman [1], p. 48, figs. 18, 19).

Stage 2, seen in *Gonothyrax*. Medusae, so-called "meconidia," are budded but not liberated; each in turn, when it reaches sexual maturity, is protruded from the gonotheca by elongation of the stalk, and sets free the embryos, after which it withers and is replaced by another (Allman [1], p. 57, fig. 28).

Stage 3, seen in *Sertularia*.—The gonophores are reduced in varying degree, it may be to sporosacs; they are budded successively from the blastostyle, and each in turn, when ripe, protrudes the spadix through the gonotheca (fig. 57, A, B). The spadix forms a gelatinous cyst, the so-called acrocyst (*ac*), external to the gonotheca (*gth*), enclosing and protecting the embryos. Then the spadix withers, leaving the embryos in the acrocyst, which may be further protected by a so-called marsupium, a structure formed by tentacle-like processes growing out from the blastostyle to enclose the acrocyst, each such process being covered by perisarc like a glove-finger secreted by it (fig. 57, C). (Allman [1], pp. 50, 51, figs. 21-24; Weismann [58], p. 170, pl. ix., figs. 7, 8.)

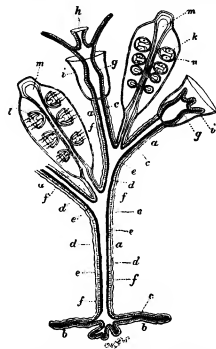
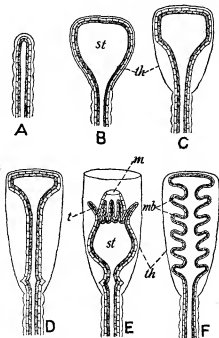

FIG. 54.—Diagram showing possible modifications of the persons of a Calyptoblastic Hydromedusa. Letters *a* to *h* same as in fig. 49. *i*, The horny cup or hydrotheca of the hydriform persons; *l*, medusiform person springing from *m*, a modified hydriform person (blastostyle); *n*, the horny case or gonangium enclosing the blastostyle and its buds. This and the hydrotheca *i* give origin to the name *Calyptoblastea*. (After 54, 55). Allman.)



After Allman, *Gymnoblactic Hydroids*, by permission of the Council of the Ray Society.

FIG. 56.—Diagrams to show the mode of formation of the Hydrotheca and Gonotheca in Calyptoblastic Hydroids. A-D are stages common to both; from D arises the hydrotheca (E) or the gonotheca (F); *th*, theca; *st*, stomach; *l*, tentacles; *m*, mouth; *mb*, medusa-buds.

Stage 4, seen in *Plumularidae*.—The generative elements are produced in structures termed corbulae, formed by reduction and modification of branches of the colony. Each corbula contains a central row of blastostyles enclosed and protected by lateral rows of branches representing stunted buds (Allman [1], p. 60, fig. 30).

The *Leptomedusa* in form is generally shallow, more or less saucer-like, with velum less developed than in Anthomedusae (fig. 55). The characteristic sense-organs are ectodermal otocysts, absent, however, in some genera, in which case cordyls may replace them. When otocysts are present, they are at least eight in number, situated adradially, but are often very numerous. The cordyls are scattered on the ring-canal. Ocelli, if present, are borne on the tentacle-bulbs. The tentacles are usually hollow, rarely solid (*Obelia*). In number they are rarely less than four, but in *Dissonema* there are only two. Primitively there are four perradial tentacles, to which may be added four interradial, or they may become very numerous and are then scattered evenly round the margin, never arranged in tufts or clusters.

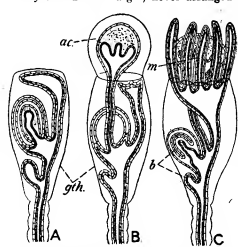

After Allman, *Gymnoblaster Hydroids*, by permission of the council of the Ray Society.

FIG. 57.—Diagrams to show the mode of formation of an Acrocyt and a Marsupium. In A two medusa-buds are seen within the gonotheca (*gth*), the upper more advanced than the lower one. In B the spadix of the upper bud has protruded itself through the top of the gonotheca and the acrocyt (*ac*) is secreted round it. In C the marsupium (*m*) is formed as finger-like process from the summit of the blastostyle, enclosing the acrocyt; *b*, medusa-buds on the blastostyle.

*Classification*.—As in the Gymnoblaster, the difficulty of uniting the hydroid and medusan systems into one scheme of classification is very great in the present state of our knowledge. In a great many Leptomedusae the hydroid stages is yet unknown, and it is by no means certain even that they possess one. It is quite possible that some of these medusae will be found to be truly hypogenetic, that is to say, with a life-cycle secondarily simplified by suppression of metagenesis. At present, ten recent and one extinct family of Calyptriblastae (Leptomedusae) may be recognized provisionally: 1. *Eucypidae* (fig. 55, 59).—Trophosome with stalked hydrothecae; gonosome, free medusae with otocysts and four, rarely six or eight, unbranched radial canals. Two of the commonest British hydroids belong to this family, *Obelia* and *Clytia*. *Obelia* forms numerous polyserial stems of the characteristic zigzag pattern growing up from a creeping basal stolon, and buds the medusa of the same name. In *Clytia* the polyps arise singly from the stolon, and the medusa is known as *Phialidium* (fig. 59).

2. *Aequorea*.—Trophosome only known in one genus (*Polycanna*), and similar to the preceding; gonosome, free medusae with otocysts and with at least eight radial canals, often a hundred or more, simple or branched. *Aequorea* is a common medusa.

3. *Thaumantidae*.—Trophosome only known in one genus (*Thaumantia*), similar to that of the *Eucypidae*; gonosome, free medusae with otocysts inconspicuous or absent, with usually four, sometimes eight, rarely more than eight, radial canals, simple and unbranched, along which the gonads are developed, with numerous tentacles

bearing ocelli and with marginal sense-clubs. *Loodice* and *Thaumantia* are representative genera.

4. *Berenicidae*.—Trophosome unknown; gonosome, free medusae, with four or six radial canals, bearing the gonads, with numerous tentacles, between which occur sense-clubs, without otocysts. *Berenice*, *Staurodiscus*, &c.

5. *Polyorchidae*.—Trophosome unknown; gonosome, free medusae of deep form, with radial canals branched in a feathery manner, and

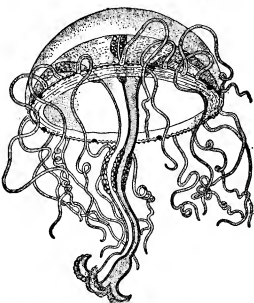

After Haeckel, *System der Medusen*, by permission of Gustav Fischer.

FIG. 58.—*Octorchandra canariensis*, from life.

bearing gonads on the main canal, but not on the branches, with numerous hollow tentacles bearing ocelli, and without otocysts. *Polyorchis*, *Spirocodon*.

6. *Campanularidae*.—Trophosome as in *Eucypidae*; gonosome, sessile gonophores. Many common or well-known genera belong here, such as *Halecium*, *Campanularia*, *Gonothyrax*, &c.

7. *Lafosiidae*.—Trophosome as in the preceding; gonosome, free medusae or gonophores, the medusae with large open otocysts. The hydroid genus *Lafosia* is remarkable for producing gonothecae on the hydrotheca, each containing a blastostyle which bears a single gonophore; this portion of the colony was formerly regarded as an independent parasitic hydroid, and was named *Coppinia*. Medusan genera are *Mitrocoma*, *Halopsis*, *Tiaropsis* (fig. 29, &c.). (So far as the characters of the trophosome are concerned, the seven preceding families are scarcely distinguishable, and they form



After E. T. Brown, *Proc. Zool. Soc. of London*, 1896.

FIG. 59.—Three stages in the development of *Phialidium temporarium*. *a*, The youngest stage, is magnified about 22 diam.; *b*, older, is magnified about 8 diam.; *c*, the adult medusa, is magnified.

a section apart, contrasting sharply with the families next to be mentioned, in none of which are free medusae liberated from the colony, so that only the characters of the trophosome need be considered.)

8. *Sertularidae*.—Hydrothecae sessile, biserial, alternating or opposite on the stem. *Sertularia* and *Sertularella* are two very common genera of this family.

9. *Plumularidae*.—Hydrothecae sessile, biserial on the main stem, uniserial on the lateral branches or pinnules, which give the colony its characteristic feathery form; with nematophores. A very abundant and prolific family; well-known British genera are *Plumularia*, *Antennularia* and *Aglyptaria*.

10. *Hydroceratimidae*.—This family contains the single Australian species *Clathrozoan wilsoni* Spencer, in which a massive hydrotheca

bears sessile hydrothecae, containing hydranths each with a single tentacle, and numerous nematophores. See W. B. Spencer [53].

11. *Dendrograptidae*, containing fossil (Silurian) genera, such as *Dendrograptus* and *Thamnograptus*, of doubtful affinities.

Order III. **Hydrocorallinae**.—Metagenetic colony-forming Hydromedusae, in which the poly-colony forms a massive, calcareous corallum into which the polyps can be retracted; poly-individuals always of two kinds, gastrozooids and dactylozooids; gonosome either free medusae or sessile gonophores.



FIG. 60.—Portion of the calcareous corallum of *Millepora nodosa*, showing the cyclical arrangement of the pores occupied by the "persons" or hydranths. About twice the natural size. (From Moseley.)

in size by new growth at the surface; and in the deeper, older portions of massive forms the tissues die off after a certain time, only the superficial lining retaining its vitality down to a certain depth. The living tissues at the surface are cut off from the underlying dead portions by horizontal partitions termed *tabulae*, which are formed successively as the coenosteum increases in age and size. If the coenosteum of *Millepora* be broken across, each pore-canal (perhaps better termed a polyp-canal) is seen to be interrupted by a series of transverse partitions, representing successive periods of growth with separation from the underlying dead portions.

Besides the wider vertical pore-canals and the narrower,

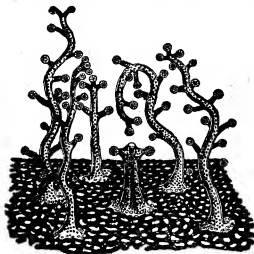

FIG. 61.—Enlarged view of the surface of a living *Millepora*, showing five dactylozooids surrounding a central gastrozooid. (From Moseley.)

irregular coenosarcinal canals, the coenosteum may contain, in its superficial portion, chambers or *ampullae*, in which the reproductive zooids (medusae or gonophores) are budded from the coenosarc.

The gastrozooids and dactylozooids are arranged in various ways at the surface, a common pattern being the formation of a **cyclusystem** (fig. 60), in which a central gastrozooid is surrounded

by a ring of dactylozooids (fig. 61). In such a system the dactylozooids may be confluent with the gastrozooid, so that the entire cyclusystem presents itself as a single aperture subdivided by radiating partitions, (thus having a superficial resemblance to a madreporarian coral with its radiating septa (figs. 62 and 63).

The gastrozooids usually bear short capitate tentacles, four, six or twelve in number; but in *Astylus* (fig. 63) they have no tentacles. The dactylozooids have no mouth; in *Milleporidae* they have short capitate tentacles, but lack tentacles in *Stylasteridae*.

The gonosome consists of free medusae in *Milleporidae*, which are budded from the apex of a dactylozooid in *Millepora murrayi*, but in other species from the coenosarcinal canals. The medusae

are produced by direct budding, without an entocodon in the bud. They are liberated in a mature condition, and probably live but a short time, merely sufficient to spread the species. The manubrium bearing the gonads is mouthless, and the umbrella is without tentacles, sense-organs, velum or radial canals. In the *Stylasteridae* sessile gonophores are formed, always by budding from the coenosarc. In *Distichopora* the gonophores have radial canals, but in other genera they are sporozooids with no trace of medusoid structure.

*Classification*.—Two families are known:—

1. *Milleporidae*.—Coenosteum massive, irregular in form; pores scattered irregularly or in cyclusystems, without styles, with transverse tabulae; free medusae. A single genus, *Millepora* (figs. 60, 61).

2. *Stylasteridae*.—Coenosteum arborescent, sometimes fanlike, with pores only on one face, or on the lateral margins of the branches; gastrozooids with tabulae only in two genera, but with (except in *Astylus*) a style, i.e. a conical, thorn-like projection from the base of the pore, sometimes found also in dactylozooids; sessile gonophores. *Sporadopora* has the pores scattered irregularly. *Distichopora* has the pores arranged in rows. *Stylaster* has cyclusystems. In *Allopora* the cyclusystems resemble the calyces of Anthozoan corals. In *Cryptohela* the cyclusystem is covered by a cap or operculum. In *Astylus* (fig. 63) styles are absent.

*Affinities of the Hydrocorallinae*.—There can be no doubt that the forms comprised in this order bear a close relationship to the Hydroidea, especially the sub-order Gymnobiastea, with which they should perhaps be classed in a natural classification. A hydrocoralline may be regarded as a form of hydroid colony in which the coenosarc forms a felt-work ramifying in all planes, and in which the chitinous perisarc is replaced by a massive calcareous skeleton. So far as the trophosome is concerned, the step from an encrusting

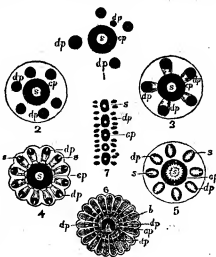

FIG. 62.—Diagrams illustrating the successive stages in the development of the cyclusystems of the *Stylasteridae*. (After Moseley.)

1. *Sporadopora dichotoma*.
2. *Allopora nobilis*.
3. *Allopora profunda*.
4. *Allopora miniata*.
5. *Astylus subviridis*.
6. *Distichopora coccinea*.
7. *Stylaster*.
8. *Stylaster*.
9. *Stylaster*.
10. *Stylaster*.
11. *Stylaster*.
12. *Stylaster*.
13. *Stylaster*.
14. *Stylaster*.
15. *Stylaster*.
16. *Stylaster*.
17. *Stylaster*.
18. *Stylaster*.
19. *Stylaster*.
20. *Stylaster*.
21. *Stylaster*.
22. *Stylaster*.
23. *Stylaster*.
24. *Stylaster*.
25. *Stylaster*.
26. *Stylaster*.
27. *Stylaster*.
28. *Stylaster*.
29. *Stylaster*.
30. *Stylaster*.
31. *Stylaster*.
32. *Stylaster*.
33. *Stylaster*.
34. *Stylaster*.
35. *Stylaster*.
36. *Stylaster*.
37. *Stylaster*.
38. *Stylaster*.
39. *Stylaster*.
40. *Stylaster*.
41. *Stylaster*.
42. *Stylaster*.
43. *Stylaster*.
44. *Stylaster*.
45. *Stylaster*.
46. *Stylaster*.
47. *Stylaster*.
48. *Stylaster*.
49. *Stylaster*.
50. *Stylaster*.
51. *Stylaster*.
52. *Stylaster*.
53. *Stylaster*.
54. *Stylaster*.
55. *Stylaster*.
56. *Stylaster*.
57. *Stylaster*.
58. *Stylaster*.
59. *Stylaster*.
60. *Stylaster*.
61. *Stylaster*.
62. *Stylaster*.
63. *Stylaster*.
64. *Stylaster*.
65. *Stylaster*.
66. *Stylaster*.
67. *Stylaster*.
68. *Stylaster*.
69. *Stylaster*.
70. *Stylaster*.
71. *Stylaster*.
72. *Stylaster*.
73. *Stylaster*.
74. *Stylaster*.
75. *Stylaster*.
76. *Stylaster*.
77. *Stylaster*.
78. *Stylaster*.
79. *Stylaster*.
80. *Stylaster*.
81. *Stylaster*.
82. *Stylaster*.
83. *Stylaster*.
84. *Stylaster*.
85. *Stylaster*.
86. *Stylaster*.
87. *Stylaster*.
88. *Stylaster*.
89. *Stylaster*.
90. *Stylaster*.
91. *Stylaster*.
92. *Stylaster*.
93. *Stylaster*.
94. *Stylaster*.
95. *Stylaster*.
96. *Stylaster*.
97. *Stylaster*.
98. *Stylaster*.
99. *Stylaster*.
100. *Stylaster*.



FIG. 63.—Portion of the corallum of *Astylus subviridis* (one of the *Stylasteridae*), showing cyclusystems placed at intervals on the branches, each with a central gastrozooid and zone of slit-like dactylozooids. (After Moseley.)

hydroid such as *Hydractinia* to the hydrocoralline *Millepora* is not great.

Hickson considers that the families *Milleporidae* and *Stylasteridae* should stand quite apart from one another and should not be united in one order. The nearest approach to the *Stylasteridae* is perhaps to be found in *Cerataella*, with its arborescent trophosome formed of anastomosing coenosarc tubes supported by a thick perisarc and covered by a common ectoderm. *Cerataella* stands in much the same relation to the *Stylasteridae* that *Hydractinia* does to the *Milleporidae*, in both cases the chitinous perisarc being replaced by the solid coenostome to which the hydrocorallines owe the second half of their name.

ORDER IV. **Graptolitoidea** (Rhabdophora, Allman).—This order has been constituted for a peculiar group of palaeozoic fossils, which have been interpreted as the remains of the skeletons of Hydrozoa of an extinct type.

A typical graptolite consists of an axis bearing a series of tooth-like projections, like a saw. Each such projection is regarded as representing a cup or hydrotheca, similar to those borne by a calyptoblastic hydroid, such as *Sertularia*. The supposed hydrothecae may be present on one side of the axis only (monopronid) or on both sides (dipronid); the first case may be conjectured to be the result of uniserial (helicoid) budding, the second to be produced by biserial (scorpioid) budding. In one division (*Retiolitidae*) the axis is reticulate. In addition to the stems bearing cups, there are found vesicles associated with them, which have been interpreted as gonothecae or as floats, that is to say, air-bladders, acting as hydrostatic organs for a floating polyp-colony.

Since no graptolites are known living, or, indeed, since palaeozoic times, the interpretation of their structure and affinities must of necessity be extremely conjectural, and it is by no means certain that they are Hydrozoa at all. It can only be said that their organization, so far as the state of their preservation permits it to be ascertained, offers closer analogies with the Hydrozoa, especially the Calyptoblastea, than with any other existing group of the animal kingdom.

See the treatise of Delage and Hérouard (HYDROZOA, [4]), and the article GRAPTOLITES.

ORDER V. **Trachylinae**.—Hydromedusae without alternation of generations, i.e. without a hydroid phase; the medusa develops directly from the actinula larva, which may, however, multiply by budding. Medusae with sense-organs represented by otocysts derived from modified tentacles (tentaculocysts), containing otoliths of endodermal origin, and innervated from the ex-umbrellar nerve-ring.

This order, containing the typical oceanic medusae, is divided into two sub-orders.

SUB-ORDER 1. **TRACHOMEDUSAE**.—Tentacles given off from the margin of the umbrella, which is entire, i.e. not lobed or indented; tentaculocysts usually enclosed in vesicles; gonads on the radial canals. The medusae of this order are characterized by the tough, rigid consistence of the umbrella, due partly to the dense nature of the mesogloia, partly to the presence of a marginal rim of chondral tissue, consisting of thickened ectoderm containing great numbers of nematocysts, and forming, as it were, a cushion-type supporting the edge of the umbrella. Prolongations from the rim of chondral tissue may form clasps or *peronia* supporting the tentacles. The tentacles are primarily four in number, periradial, alternating with four interradial tentaculocysts, but both tentacles and sense-organs may be multiplied and the primary periradial may be six instead of four (fig. 26). The tentacles are always solid, containing an axis of endoderm-cells resembling notochordal tissue or plant-parenchyma, and are but moderately flexible. The sense-organs are tentaculocysts which are usually enclosed in vesicles and may be sunk far below the surface. The gonads are on the radial canals or on the stomach (*Psychogastridae*), and each gonad may be divided into two by a longitudinal sub-umbrellar muscle-tract. The radial canals are four, six, eight or more, and in some genera blindly-ending centripetal canals are present (fig. 26). The stomach may be drawn out into the manubrium, forming a proboscis ("Magenstiel") of considerable length.

The development of the Trachomedusae, so far as it is known,

shows an actinula-stage which is either free (larval) or passed over in the egg (foetal) as in *Geryonia*; in no case does there appear to be a free planula-stage. The actinula, when free, may multiply by larval budding, but in all cases both the original actinula and all its descendants become converted into medusae, so that there is no alternation of generations. In *Gonionemus* the actinula becomes attached and polyp-like and reproduces by budding.

The Trachomedusae are divided into the following families:

1. *Petasiidae* (*Petachniidae*).—Four radial canals, four gonads; stomach not prolonged into the manubrium, which is relatively short; tentaculocysts free. *Petasia* and other genera make up this family, founded by Haeckel, but no other naturalist has ever seen them, and it is probable that they are simply immature forms of other genera.
2. *Olindiadae*, with four radial canals and four gonads; manubrium short; ring-canals giving off bilobed centripetal canals; tentaculocysts enclosed. *Olindias mulleri* (fig. 64) is a common Mediterranean species. Other genera are *Aglauropsis*, *Gossea* and *Gonionemus*; the last named bears adhesive suckers on the tentacles. Some doubt attaches to the position of this family. It has been asserted that the tentaculocysts are entirely ectodermal and that either the family should be placed amongst the Leptomedusae, or should form, together with certain Leptomedusae, an entirely distinct order. In *Gonionemus*, however, the concrement-cells are endodermal.
3. *Trachymenidae*.—Eight radial canals, eight gonads, stomach not prolonged into manubrium; tentaculocysts enclosed. *Rhopalonema*, *Trachymena*, &c.
4. *Psychogastridae* (*Pectyllidae*).—As in the preceding, but with suckers on the tentacles. *Psychogastria* Allman (= *Pectyllis*), a deep-sea form.
5. *Aglauridae*.—Eight radial canals, two, four or eight gonads; tentacles numerous; tentaculocysts free; stomach prolonged into manubrium. *Aglaura*, *Aglantha* (fig. 65), &c., with eight gonads; *Stauraglaura* with four; *Persa* with two. *Amphogona*, hermaphrodite, with male and female gonads on alternating radial canals.
6. *Geryoniidae*.—Four or six radial canals; gonads band-like; stomach prolonged into a manubrium of great length; tentaculocysts enclosed. *Liriope*, &c., with four radial canals; *Geryonia*, *Carmarina* (fig. 26), &c., with six.
7. *Halicreidae*.—Eight very broad radial canals; ex-umbrella often provided with lateral outgrowths; tentacles differing in size, but in a single row. *Halicreas*.

SUB-ORDER 2. **NARCOMEDUSAE**.—Margin of the umbrella lobed, tentacles arising from the ex-umbrella at some distance from the margin; tentaculocysts exposed, not enclosed in vesicles; gonads on the sub-umbrellar floor of the stomach or of the gastric pouches.

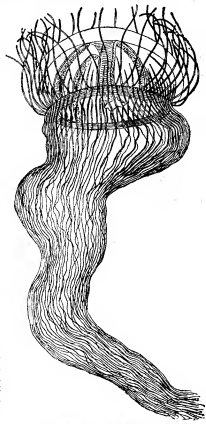

After Haeckel, *System der Medusen*, by permission of Gustav Fischer.

FIG. 64.—*Olindias mulleri*.

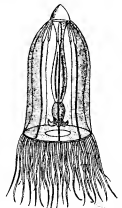

After E. T. Brown, *Proc. Zool. Soc. of London*.

FIG. 65.—*Aglantha rosea* (Forbes), a British medusa.

The Narcomedusae exhibit peculiarities of form and structure which distinguish them at once from all other Hydromedusae. The umbrella is shallow and has the margin supported by a rim of thickened ectoderm, as in the Trachomedusae, but not so strongly developed. The tentacles are not inserted on the margin of the umbrella, but arise high up on the ex-umbrellar surface, and the umbrella is prolonged into lobes corresponding to the interspaces between the tentacles. The condition of things can be imagined by supposing that in a medusa primitively of normal build, with tentacles at the margin, the umbrella has grown down past the insertion of the tentacles. As a result of this extension of the umbrellar margin, all structures belonging to this region, namely, the ring-canal, the nerve-rings, and the

rim of thickened ectoderm, do not run an even course, but are thrown into festoons, caught up during the insertion of each tentacle in such a way that the ring-canal and its accompaniments form in each notch of the umbrellar margin an inverted V, the apex of which corresponds to the insertion of the tentacle; in some cases the limbs of the V may run for some distance parallel to one another, and may be fused into one, giving a figure better compared to an inverted Y. Thus the ectodermal rim runs round the edge of each passes upwards towards the base of the tentacle from the re-entering angle between two adjacent lobes, to form with its fellow of the next lobe a tentacle-clasp or *peronium*, i.e. a streak of thickened ectoderm supporting the tentacle. Similarly the ring-canal runs round the edge of the lobe as the so-called festoon-canal, and then runs upwards under the peronium to the base of the tentacle as one of a pair of peronial canals, the limbs of the V-like figure already mentioned. The nerve-rings have a similar course. The tentaculocysts are implanted round the margins of the lobes of the umbrella and may be supported by prolongations of the ectodermal rim termed *otoporaes* (*Gehörspangen*). The radial canals are represented by wide gastric pouches, and may be absent, so that the tentacles arise directly from the stomach (*Solmaridae*). The tentacles are always solid, as in Trachomedusae.

The development of the Narcomedusae is in the main similar to that of the Trachomedusae, but shows some remarkable features. In *Aeginopsis* a planula is formed by multipolar immigration. The two ends of the planula become greatly lengthened and give rise to the two primary tentacles of the actinula, of which the mouth arises from one side of the planula. Hence the principal axis of the future medusa corresponds, not to the longitudinal axis of the planula, but to a transverse axis. This is in some degree parallel to the cases described above, in which a planula gives rise to the hydrorhiza, and buds a polyp laterally.

In *Cunina* and allied genera the actinula, formed in the manner described, has a hypostome of great length, quite disproportionate to the size of the body, and is further endowed with the power of producing buds from a stolon arising from the aboral side of the body. In these species the actinula is parasitic upon another medusa; for instance, *Cunocantilla oclonaria* upon *Turritopsis*, *C. proboscidea* upon *Liriope* or *Geryonia*. The parasite effects a lodgment in the host either by invading it as a free-swimming planula, or, apparently, in other cases, as a spore-embryo which is captured and swallowed as food by the host. The parasitic actinula is found attached to the proboscis of the medusa; it thrusts its

greatly elongated hypostome into the mouth of the medusa and nourishes itself upon the food in the digestive cavity of its host. At the same time it produces buds from an aboral stolon. The buds become medusae by the direct method of budding described above. In some cases the buds do not become detached at once, but the stolon continues to grow and to produce more buds, forming a "bud-spike" (*Knospenhäure*), which consists of the axial stolon bearing medusa-buds in all stages of development. In such cases the original parent-actinula does not itself become a medusa, but remains arrested in development and ultimately dies off, so that a true alternation of generations is brought about. It is in these parasitic forms that we meet with the method of reproduction by sporogony described above.

In other Narcomedusae, e.g. *Cunocantilla fowleri* Browne, buds are formed from the sub-umbrella on the under side of the stomach pouches, where later the gonads are developed.

**Classification.**—Three families of Narcomedusae are recognized (see O. Maas [40]):

1. *Cunanthidae*.—With broad gastric pouches which are simple, i.e. uninvaginated, and "pernemal", i.e. correspond in position with the tentacles. *Cunina* (fig. 66) with more than eight tentacles; *Cunocantilla* with eight tentacles, four peritradial, four intratradial.

2. *Aeginidae*.—Radii a multiple of four, with radial gastric pouches bifurcated or subdivided; the tentacles are implanted in the notch between the two subdivisions of each (primary) gastric pouch, hence the (secondary) gastric pouches appear to be "internemal" in position, i.e. to alternate in position with the tentacles. *Aegina*, with four tentacles and eight pouches; *Aeginura* (fig. 25), with eight tentacles and sixteen pouches; *Solmundella* (fig. 67), with two tentacles and eight pouches; *Aeginopsis* (fig. 23), with two or four tentacles and sixteen pouches.

3. *Solmaridae*.—No gastric pouches; the numerous tentacles arise direct from the stomach, into which also the peronial canals open, so that the ring-canal is cut up into separate festoons. *Solmaris*, *Pegantha*, *Polyzonia*, &c. To this family should be referred, probably, the genus *Hydractena*, described by C. Dawydov [11a] and regarded by him as intermediate between Hydromedusae and Ctenophora. See O. Maas [35].

#### Appendix to the Trachylinae.

Of doubtful position, but commonly referred to the Trachylinae, are the two genera of fresh-water medusae, *Limnocodium* and *Limnocoidea*.

*Limnocodium sewerbyi* was first discovered in the *Victoria regia* tank in the Botanic Gardens, Regent's Park, London. Since then it has been discovered in other botanic gardens in various parts of Europe, its two most recent appearances being at Lyons (1901) and Munich (1905), occurring always in tanks in which the *Victoria regia* is cultivated, a fact which indicates that tropical South America is its original habitat. In the same tanks a small hydroid, very similar to *Microhydra*, has been found, which bears medusa-buds and is probably the stock from which the medusa is budded. It is a remarkable fact that all specimens of *Limnocoidea* hitherto seen have been males; it may be inferred from this either that only one polyp-stock has been introduced into Europe, from which all the medusae seen hitherto have been budded, or perhaps that the female medusae is a sessile gonophore, as in *Pennaria*. The male gonads are carried on the radial canals.

*Limnocoidea tanganyikae* was discovered first in Lake Tanganyika, but has since been discovered also in Lake Victoria and in the river Niger. It differs from *Limnocoidea* in having practically no manubrium but a wide mouth two-thirds the diameter of the umbrella across. It buds medusae from the margin of the mouth in May and June, and in August and September the gonads are formed in the place where the buds arose. The hydroid phase, if any, is not known.

Both these medusae have sense-organs of a peculiar type, which are said to contain an endodermal axis like the sense-organs of Trachylinae, but the fact has recently been called in question for



FIG. 66.—*Cunina rhododactyla*, one of the Narcomedusae. (After Haeckel.)

- l, Circular canal.  
k, "Otoporaes" or centripetal process of the marginal cartilaginous ring connected with tentaculocyst.  
r, Stomach.  
l, Jelly of the disk.  
c, Radial canal (pouch of stomach).  
tt, Tentacles.  
tt, Tentacle root.

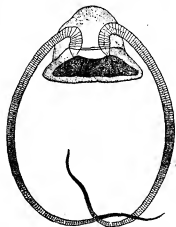

After O. Maas, *Craspedotes Malusen* der Siboga Expedition, by permission of E. S. Brill & Co.

FIG. 67.—*Solmundella bitentaculata* (Quoy and Gaimard).



*Limnocoelium* by S. Goto, who considers the genus to be allied to *Leptodius*. Allman, on the other hand, referred *Limnocoelium* to the *Limnocoelidae*.

In this connexion must be mentioned, finally, the medusae budded from the fresh-water polyp *Microhydra*. The poly-stages of *Limnocoelium* and *Microhydra* are extremely similar in character. In both cases the hydranth is extremely reduced and has no tentacles, and the polyp forms a colony by budding from the base. In *Limnocoelium* the body secretes a gelatinous mucus to which adhere particles of mud, &c., forming a protective covering. In *Microhydra* no such protecting case is formed. In view of the great resemblance between *Microhydra* and the polyp of *Limnocoelium*, it might be expected that the medusae to which they give origin would also be similar. As yet, however, the medusa of *Microhydra* has only been seen in an immature condition, but it shows some well-marked differences from *Limnocoelium*, especially in the structure of the tentacles, which furnish useful characters for distinguishing species amongst medusae. The possession of a poly-stage by *Limnocoelium* and *Microhydra* furnishes an argument against placing them in the Trachylinae. Their sense-organs require renewed investigations. (Browne [10] and [10a].)

ORDER VI. **Siphonophora**.—Pelagic floating Hydrozoa with great differentiation of parts, each performing a special function; generally regarded as colonies showing differentiation of individuals in correspondence with a physiological division of labour.

A typical Siphonophore is a stock or *corium* consisting of a number of appendages placed in organic connexion with one another by means of a *coenosarc*. The coenosarc does not differ in structure from that already described in colonial Hydrozoa. It consists of a hollow tube, or tubes, of which the wall is made up of the two body-layers, ectoderm and endoderm, and the cavity is a continuation of the digestive cavities of the nutritive and other appendages, *i.e.* of the coelenteron. The coenosarc may consist of a single elongated tube or stolon, forming the stem or axis of the corium on which, usually, the appendages are arranged in groups termed *cordia*; or it may take the form of a compact mass of ramifying, anastomosing tubes, in which case the corium as a whole has a compact form and *cordia* are not distinguishable. In the Dissectae the coenosarc forms a spongy mass, the "*centradenia*," which is partly hepatic in function, forming the so-called liver, and partly excretory.

The appendages show various types of form and structure corresponding to different functions. The corium is always differentiated into two parts; an upper portion termed the *nectosome*, in which the appendages are locomotor or hydrostatic in function, that is to say, serve for swimming or floating; and a lower portion termed the *siphosome*, bearing appendages which are nutritive, reproductive or simply protective in function.

Divergent views have been held by different authors both as regards the nature of the corium as a whole, and as regards the homologies of the different types of appendages borne by it.

The general theories of Siphonophoran morphology are discussed

below, but in enumerating the various types of appendages it is convenient to discuss their morphological interpretation at the same time.

In the nectosome one or more of the following types of appendage occur:—

1. Swimming-bells, termed *nectocalyces* or *nectophores* (fig. 68, k), absent in *Chondrophorida* and *Cystophorida*; they are contractile and resemble, both in appearance, structure and function, the umbrella of a medusa, with radial canals, ring-canal and velum; but they are without manubrium, tentacles or sense-organs, and are always bilaterally symmetrical, a peculiarity of form related with the fact that they are attached on one side to the stem. A given corium may bear one or several nectocalyces, and by their contractions they propel the colony slowly along, like so many medusae harnessed together. In cases where the corium has no pneumatophore or the top-most swimming bell may contain an oil-reservoir or *oleocyst*.

2. The pneumatophore or air-bell (fig. 68, n), for passive locomotion, forming a float which keeps the corium at or showing the pneumatophore and expands the surface of the panderd palpons.

The pneumatophore arises from the ectoderm as a pit or invagination, part of which forms a gas-secreting gland, while the rest gives rise to an air-sack lined by a chitinous cuticle. The orifice of invagination forms a pore which may be closed up or may form a protruding duct or funnel. As in the analogous swim-bladder of fishes, the gas in the pneumatophore can be secreted or absorbed, whereby the specific gravity of the body can be diminished or increased, so as to cause it to float nearer the surface or at a deeper level. Never more than one pneumatophore is found in a corium, and when present it is always situated at the highest point above the swimming bells, if these are present also. In *Velolla* the pneumatophore becomes of complex structure and sends air-tubes, lined by a chitin and resembling tracheae, down into the compact coenosarc, thus evidently serving a respiratory as well as a hydrostatic function.

Divergent views have been held as to the morphological significance of the pneumatophore. E. Haeckel regarded the whole structure as a glandular ectodermal pit formed on the ex-umbrellar surface of a medusa-person. C. Chun and, more recently, R. Woltereck [59], on the other hand, have shown that the ectodermal pit which gives rise to the pneumatophore represents an antocodon. Hence the cavity of the air-sack is equivalent to a sub-umbrellar cavity in which no manubrium is formed, and the pore or orifice of invagination would represent the margin of the umbrella. In the wall of the sack is a double layer of endoderm, the space between which is a continuation of the coelenteron. By coalescence of the endoderm-layers, the coelenteron may be reduced to vessels, usually eight in number, opening into a ring-sinus surrounding the pore. Thus the disposition of the endoderm-cavities is roughly comparable to the gastrovascular system of a medusa.

The difference between the theories of Haeckel and Chun is connected with a further divergence in the interpretation of the stem or axis of the corium. Haeckel regards it as the equivalent of the manubrium, and as it is implanted on the blind end of the pneumatophore, such a view leads necessarily to the air-sack and gland being a development on the ex-umbrellar surface of the medusa-person. Chun and Woltereck, on the other hand, regard the stem as a *stolo prolifer* arising from the aboral pole, that is to say, from the ex-umbrella, similar to that which grows out from the ex-umbrellar surface of the embryo of the Narcomedusae and produces buds, a view which is certainly supported by the embryological evidence to be adduced shortly.

In the siphosome the following types of appendages occur:—

1. *Siphons* or nutritive appendages, from which the order takes its name; never absent and usually present in great numbers (fig. 68, e). Each is a tube dilated at or towards the base and containing a mouth at its extremity, leading into a stomach placed in the dilatation already mentioned. The siphons have been compared to the manubrium of a medusa-individual, or to polyps, and hence are sometimes termed *gastrozooids*.

2. *Palpons* (fig. 68, g), present in some genera, especially in Physonectae; similar to the siphons but without a mouth, and purely tactile in function, hence sometimes termed *dactylozooids*. If a distal pore or aperture is present, it is excretory in function; such varieties have been termed "*cystons*" by Haeckel.

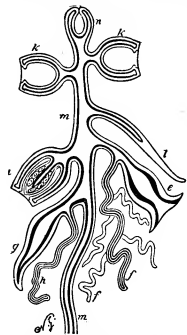

FIG. 68.—Diagram showing possible modifications of medusiform and hydriform persons of a colony of Siphonophora. The thick black line represents endoderm, the thinner line ectoderm. (After Allman.)  
n, Pneumatocyst.  
k, Nectocalyces (swimming bells).  
l, Hydrophyllium (covering-piece).  
i, Generative medusiform person.  
g, Palpon with attached palpa. h, e, Siphon with branched grappling tentacle, f.  
m, Stem.

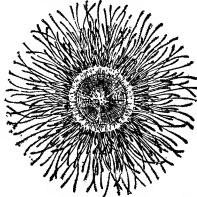

FIG. 69.—*Porpita*, seen from above, keeps the corium at or showing the pneumatophore and expands the surface of the panderd palpons.

3. *Tentacles* ("Fangfäden"), always present, and implanted one at the base of each siphon (fig. 68, f). The tentacles of siphonophores may reach a great length and have a complex structure. They may bear accessory filaments or *tenilla* (f'), covered thickly with batteries of nematocysts, to which these organisms owe their great powers of offence and defence.

4. *Palpae* ("Tastfäden"), occurring together with palpons, one implanted at the base of each palpon (fig. 68, h). Each palpae is a tactile filament, very extensible, without accessory filaments or nematocysts.

5. *Bracts* ("hydrophyllia"), occur in *Calycophorida* and some *Physophorida* as scale-like appendages protecting other parts (fig. 68, l). The mesogloea is greatly developed in them and they are often of very tough consistency. By haecelated they are considered homologous with the umbrella of a medusa.

6. *Gonostyles*, appendages which produce by budding medusae or gonophores, like the blastostyles of a hydroid colony. In their most primitive form they are seen in *Verella* as "gonosiphons," which possess mouths like the ordinary sterile siphons and bud free medusae. In other forms they have no mouths. They may be branched, so-called "gonodendra," and amongst them may occur special forms of palpons, "gonopalpons." The gonostyles have been compared to the blastostyles of a hydroid colony, or to the manubrium of a medusa which produces free or sessile medusa-buds.

7. *Gonophores*, produced either on the gonostyles already mentioned or budded, as in hydrocorallines, from the coenosarc, i.e. the stem (fig. 68, i). They show every transition between free medusae and sporosacs, as already described for hydroid colonies. Thus in *Verella* free medusae are produced, which have been described as an independent genus of medusae, *Chrysomitra*. In other types the medusae may be set

the appendages are arranged as regularly recurrent cornidia along it, and the cornidia are then said to be "ordinate." In such cases the oldest cornidia, that is to say, those furthest from the metosome, may become detached (like the segments or proglottides of a tapeworm), and swim off, each such detached cornidium then becoming a small free cornus which, in many cases, has been given an independent generic name. A cornidium may contain a single nutritive siphon ("monogastric") or several siphons ("polygastric").

The following are some of the forms of cornidia that occur:—

1. The *Eudosome* (*Calycophorida*), consisting of a bract, siphon, tentacle and face of *Verella*, showing gonophore; when free it is known as *Eudoxia*.

2. The *ersaeome* (*Calycophorida*), made up of the same appendages as the preceding type but with the addition of a nectocalyx; when free termed *Ersaea*.

3. The *Rhodolome* of some *Rhodaliidae*, consisting of siphon, tentacle and one or more gonophores.

4. The *Athrome* of *Physophora*, &c., consisting of siphon, tentacle, one or more palpons with palpae, and one or more gonophores.

5. The *crystalome* of *Anthemodes*, &c., similar to the athrome but with the addition of a group of bracts.

*Embryology of the Siphonophora*.—The fertilized ovum gives rise to a parenchymula, with solid endoderm, which is set free as a free-swimming planula larva, in the manner already described (see HYDROZOA). The planula has its two extremities dissimilar (Bipolaria-larva). The subsequent development is slightly different according as the future cornus is headed by a pneumatophore (*Physophorida*, *Cystophorida*) or by a nectocalyx (*Calycophorida*).

(i.) *Physophorida*, for example *Halistenma* (*C. Chun*, HYDROZOA (i)). The planula becomes elongated and broadens towards one pole, at which a pit or invagination of the ectoderm arises. Next the pit closes up to form a vesicle with a pore, and so gives rise to the pneumatophore. From the broader portion of the planula an outgrowth arises which becomes the first tentacle of the cornus. The endoderm of the planula now acquires a cavity, and at the narrower pole a mouth is formed, giving rise to the primary siphon.

Thus from the original planula three appendages arise, as it were, budded off, while the planula itself mostly gives rise to coenosarc, just as in some hydroids the planula is converted chiefly into hydrhiza.

(ii.) *Calycophorida*, for example, *Muggiaca*. The planula develops, on the whole, in a similar manner, but the ectodermal invagination arises, not at the pole of the planula, but on the side of its broader portion, and gives rise, not to a pneumatophore, but to a nectocalyx, the primary swimming bell or *proctodon* ("Fallschirm") which is later thrown off and replaced by secondary swimming bells, *metacodons*, budded from the coenosarc.



From G. H. Fowler, after G. Cuvier, Lankester's *Treatise on Zoology*.

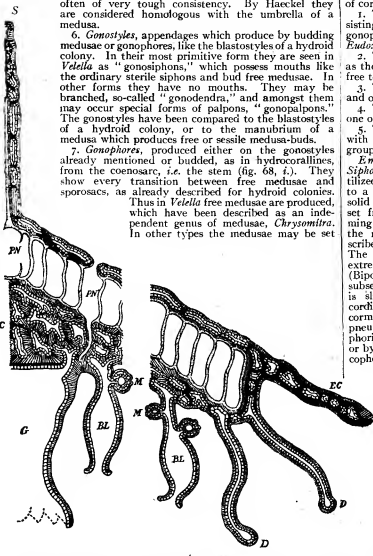

From G. H. Fowler, after A. Agassiz, Lankester's *Treatise on Zoology*.

FIG. 70.—Diagram of the structure of *Verella*, showing the central and peripheral thirds of a half-section of the colony, the middle third being omitted. The ectoderm is indicated by close hatching, the endoderm by light hatching, the mesogloea by thick black lines, the horny skeleton of the pneumatophore and sail by dotting.

BL, Blastostyle. M, Medusoid gonophores.  
C, Centradenia. PN, Primary central chamber, and  
G, Cavity of the large central siphon. EC, Edge of colony prolonged beyond the pneumatophore.  
S, Sail.

free in a mature condition as the so-called "genital swimming bells," comparable to the *Globiceps* of *Pennaria*. The most usual condition, however, is that in which sessile medusoid gonophores or sporosacs are produced.

The various types of appendages described in the foregoing may be arranged in groups termed *cornidia*. In forms with a compact coenosarc such as *Verella*, *Physalia*, &c., the separate cornidia cannot be sharply distinguished, and such a condition is described technically as one with "scattered" cornidia. In forms in which, on the other hand, the coenosarc forms an elongated, tubular axis or stem,

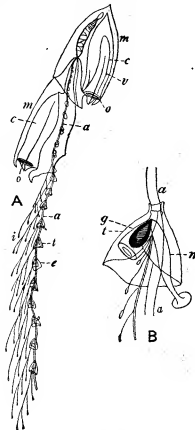

FIG. 72.—A, *Diphyes campanulata*; B, a group of appendages (cornidium) of the same *Diphyes*. (After C. Gegenbaur.)

a, Axis of the colony. o, Orifice of nectocalyx. m, Nectocalyx. c, Sub-umbrellar cavity. t, Bract. n, Siphon. p, Radial canals of gonophore. i, Tentacle.

From a comparison of the two embryological types there can be no doubt on two points; first, that the pneumatophore and the protocon are strictly homologous, and, therefore if the nectocalyx is comparable to the umbrella of a medusa, as seems obvious, the pneumatophore must be so too; secondly, that the coenosarcal axis arises from the ex-umbrella of the medusa and cannot be compared to a manubrium, but is strictly comparable to the "bud-spike" of a Narcomedusae.

**Theories of Siphonophore Morphology.**—The many theories that have been put forward as to the interpretation of the cornus and the various parts are set forth and discussed in the treatise of Y. Delage and E. Hérouard (HYDROZOA [4]) and more recently by R. Woltereck [59], and only a brief analysis can be given here.

In the first place the cornus has been regarded as a single individual and its appendages as *organs*. This is the so-called "polyorgan" theory, especially connected with the name of Huxley; but it must be borne in mind that Huxley regarded all the forms produced, in any animal, between one egg-generation and the next, as constituting in the lump one single individual. Huxley, therefore, considered a hydroid colony, for example, as a single individual, and each separate polyp or medusa budded from it as having the value of an organ and not of an individual. Hence Huxley's view is not so different from those held by other authors as it seems to be at first sight.

In more recent years Woltereck [59] has supported Huxley's view of individuality, at the same time drawing a fine distinction between "individual" and "person." The individual is the product of sexual reproduction; a person is an individual of lower rank, which may be produced asexually. A Siphonophore is regarded as a single individual composed of numerous zooids, budded from the primary zooid (siphon) produced from the planula. Any given zooid is a person-zooid if equivalent to the primary zooid, an organ-zooid if equivalent only to a part of it. Woltereck considers the siphonophores most nearly allied to the Narcomedusae, producing like the buds from an aboral stolon, the first bud being represented by the pneumatophore or protocon, in different cases.

Contrasting, in the second place, with the polyorgan theory are the various "polyperson" theories which interpret the Siphonophore cornus as a colony composed of more or fewer individuals in organic union with one another. On this interpretation there is still room for considerable divergence of opinion as regards details. To begin with, it is not necessary on the polyperson theory to regard each appendage as a distinct individual; it is still possible to compare appendages with parts

of an individual which have become separated from one another by a process of "dislocation of organs." Thus a bract may be regarded, with Haeckel, as a modified umbrella of a medusa, a siphon as its manubrium, and a tentacle as representing a medusan tentacle shifted in attachment from the margin to the sub-umbrella; or a siphon may be compared with a polyp, of which the single tentacle has become shifted so as to be attached to the coenosarcal axis and so on. Some authors prefer, on the other hand, to regard every appendage as a separate individual, or at least as a portion of an individual, of which other portions have been lost or obliterated.

A further divergence of opinion arises from differences in the interpretation of the persons composing the colony. It is possible to regard the cornus (1) as a colony of medusa-persons, (2) as a colony of polyp-persons, (3) as composed partly of one and partly of the other. It is sufficient here to mention briefly the views put forward on this point by C. Chun and E. Haeckel.

Chun (HYDROZOA [1]) maintains the older views of Leuckart and

Claus, according to which the cornus is to be compared to a floating hydroid colony. It may be regarded as derived from floating polyps similar to *Nemopsis* or *Pelagohydra*, which by budding produce a colony of polyps and also form medusa-buds. The polyp-individuals form the nutritive siphosome or trophosome. The medusa-buds are either fertile or sterile. If fertile they become free medusae or sessile gonophores. If sterile they remain attached and locomotor in function, forming the nectosome, the pneumatophore and swimming-bells.

Haeckel, on the other hand, is in accordance with Balfour in regarding a Siphonophore as a medusome, that is to say, as a colony composed of medusoid persons or organs entirely. Haeckel considers that the Siphonophores have two distinct ancestral lines of evolution:

1. In the *Disconanthae*, i.e. in such forms as *Veleva*, *Porpita*, &c., the ancestor was an eight-rayed medusa (*Disconula*) which acquired a pneumatophore as an ectodermal pit on the ex-umbrella, and in which the organs (manubrium, tentacles, &c.) became secondarily multiplied, just as they do in *Gastrotrichia* as the result of incomplete fission. The nearest living allies of the ancestral *Disconula* are to be sought in the *Pectyllidae*.

2. In the *Siphonanthae*, i.e. in all other Siphonophores, the ancestral form was a *Siphonula*, a bilaterally symmetrical Anthomedusa

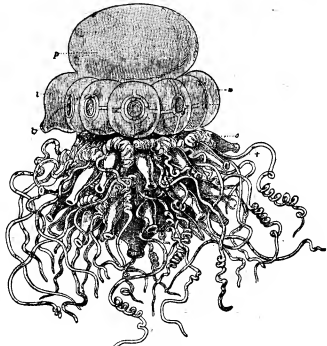

After Haeckel, from Lankester's *Treatise on Zoology*.

FIG. 74.—*Stephanlia corona*, a young colony.

p, Pneumatocyst. l, Aurophore. s, Siphon.  
m, Nectocalyx. lo, Orifice of the aurophore. t, Tentacle.

with a single long tentacle (cf. *Corymorpha*), which became displaced from the margin to the sub-umbrella. The *Siphonula* produced buds on the manubrium, as many Anthomedusae are known to do, and these by reduction or dislocation of parts gave rise to the various appendages of the colony. Thus the umbrella of the *Siphonula* became the protocon, and its manubrium, the axis or stolon, which, by a process of dislocation of organs, escaped, as it were, from the sub-umbrella through a cleft and became secondarily attached to the ex-umbrella. It must be pointed out that, however probable Haeckel's theory may be in other respects, there is not the slightest evidence for any such cleft in the umbrella having been present at any time, and that the embryological evidence, as already pointed out, is all against any homology between the stem and a manubrium, since the primary siphon does not become the stem, which arises from the ex-umbrel side of the protocon and is strictly comparable to a stolon.

**Classification.**—The Siphonophora may be divided, following Delage and Hérouard, into four sub-orders:

I. CHONDROPHORIDA (*Disconaeae* Haeckel, *Tracheophysae* Chun). With an apical chambered pneumatophore, from which tracheal tubes may take origin (fig. 70); no nectocalyces or bracts; appendages all on the lower side of the pneumatophore arising from a compact coenosarcal, and consisting of a central

principal siphon, surrounded by gonosiphons, and these again by tentacles.

Three families: (1) *Discalidae*, for *Discalia* and allied genera, deep-sea forms not well known; (2) *Porpididae* for the familiar genus *Porpita* (fig. 69) and its allies; and (3) *Veleididae*, represented by the well-known genus *Veleva* (figs. 70, 71), common in the Mediterranean and other seas.

II. CALYPOPHORIDA (*Calyconectae*, Haeckel). Without pneumatophore, with one, two, rarely more nectocalyses.

Three families: (1) *Monophyidae*, with a single nectocalyx; examples *Mugginea*, sometimes found in British seas, *Sphaeronecles*, &c.; (2) *Diphyidae*, with two nectocalyses; examples *Diphyes* (fig. 72), *Praya*, *Abyla*, &c.; and (3) *Polyphyidae*, with numerous nectocalyses; example *Hippopodius*, *Stephanophyes* and other genera.

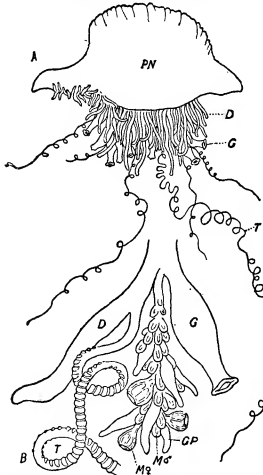

From G. H. Fowler, modified after C. Cuvier and E. Haeckel, *Lankester's Treatise on Zoology*.

FIG. 75.—A. *Physalia*, general view, diagrammatic; B, ceratium of *Physalia*; D, palpon; T, palpaec; G, siphon; GP, gonopodium; M♂, male gonophore; M♀, female gonophore, ultimately set free.

III. PHYSPHORIDA (*Physonectae* + *Auronectae*, Haeckel). With an apical pneumatophore, not divided into chambers, followed by a series of nectocalyses or bracts.

A great number of families and genera are referred to this group, amongst which may be mentioned specially—(1) *Agalmidae*, containing the genera *Stephanomia*, *Agalma*, *Anthemodes*, *Haliestemma*, &c.; (2) *Apoemidae*, with the genus *Apoemia* and its allies; (3) *Forskaliidae*, with *Forskalia* and allied forms; (4) *Physophoridae*, for *Physophora* (fig. 73) and other genera, (5) *Anthophysiidae*, for *Anthophysia*, *Athorphyia*, &c.; and lastly the two families (6) *Rhodaliidae* and (7) *Stephalidae* (fig. 74), constituting the group *Auronectae* of Haeckel. The *Auronectae* are peculiar deep-sea forms, little known except from Haeckel's descriptions, in which the large pneumatophore has a peculiar duct, termed the aurophore, placed on its lower side in the midst of a circle of swimming-bells.

IV. CYSTOPHORIDA (*Cystonectae*, Haeckel). With a very large pneumatophore not divided into chambers, but without nectocalyses or bracts. Two sections can be distinguished, the

Rhizophysina, with long tubular coenosarc-bearing ordinate cornidia, and Physalina, with compact coenosarc-bearing scattered cornidia.

A type of the Rhizophysina is the genus *Rhizophysa*. The Physalina comprise the families *Physaliidae* and *Epiubidae*, of which the types are *Physalia* (figs. 74, 75) and *Epiubia*, respectively. *Physalia*, known commonly as the Portuguese man-of-war, is remarkable for its great size, its brilliant colours, and its terrible stinging powers.

BIBLIOGRAPHY.—In addition to the works cited below, see the general works cited in the article HYDROZOA, in some of which very full bibliographies will be found.

1. G. J. Allman, "A Monograph of the Gymnoblaster or Tubularian Hydroids," Ray Society (1871-1872); 2. A. Brauer, "Über die Entwicklung von Hydra," *Zeitschr. f. wiss. Zool.* lii. (1891), pp. 169-216, pls. ix-xii; 3. "Über die Entstehung der Geschlechtsprodukte und die Entwicklung von Tubularia mesembriae nachthem Allm.," *l.c.* pp. 551-579, pls. xxxiii-xxxv; 4. W. K. Brooks, "The Life-History of the Hydromedusae: a discussion of the Origin of the Medusae, and of the significance of Metagenesis," *Mem. Boston Soc. Nat. Hist.* iii. (1886), pp. 259-430, pls. xxxvii-xiv; 5. "The Segsory Clubs of Cordyli of *Laodice*," *Journ. Morphology*, x. (1895), pp. 287-304, pl. xvii; 6. E. T. Browne, "On British Hydroids and Medusae," *Proc. Zool. Soc.* (1896), pp. 459-500, pls. xvi, xvii, (1897), pp. 816-835, pls. xviii, xix, 12 text-figs.; 7. "Biscayan Medusae," *Trans. Linn. Soc. x.* (1906), pp. 163-187, pl. xliii; 8. "Medusae," in Herdman, *Rep. Pearl Oyster Fisheries, Gulf of Manar, iv.* (1905), pp. 131-166, 4 pls.; 9. "Hydromedusae with a Revision of the *Williidae* and *Petasidae*," *Fauna and Geogr. Maldive and Laccadive Archipelago*, ii. (1904), pp. 722-749, pls. liv-lviii; 10. "On the Freshwater Medusa liberated by *Microhydra ryderi*, Potts, and a Comparison with *Limnocodium*," *Quart. Journ. Micr. Sci.* i. (1906), pp. 635-645, pl. xxviii; 10a. "On the Freshwater Medusa *Limnocodium longicauda*," *Budget Memorial Volume* (Cambridge, 1908), pp. 471-482, pl. xxviii; 11. C. Claus, "Über die Struktur der Muskelzellen und über den Körperbau von *Mnestra parasites* Krohn," *Verhandl. zool. bot. Ges. Wien*, xxv. (1876), pp. 9-12, pl. i; 11a. C. Dawydov, "Hydroctena salenskii," *Mém. Acad. Imp. St. Pétersbourg* (viii.) xiv. No. 9 (1903), 17 pp., 1 pl.; 12. A. Dendy, "On a Free-swimming Hydroid, *Pelagohydra mirabilis*," n. gen. et sp., *Quart. Journ. Micr. Sci.* vi. (1903), pp. 1-24, pls. i, ii; 13. H. Driesch, "Tektonische Studien an Hydrokopolyper," *1. Jahrb. Zeitschr.*, xxiv. (1890), pp. 189-226, 12 figs.; (2) *l.c.* pp. 657-688, 6 figs.; (3) *ibid.* xxv. (1891), pp. 467-479, 3 figs.; 14. C. Duplessis, "On *Campanularia volubilis*," *Soc. Vaud. Bull.* 13 (Lausanne, 1874-1875); 15. J. W. Fewkes, "On *Mnestra*," *Amer. Natural.*, xviii. (1884), pp. 197-198, 3 figs.; 16. S. Goto, "Dendrocorone Inaba, Vertreterin einer neuen Familie der Hydromedusen," *Annot. Zool. Tokyo*, i. (1897), pp. 93-104, pl. vi., figs. 106-113; 17. "The Craspedote Medusa *Gimnadia* and some of its Natural Allies," *Mar. Anniversary Volume* (New York, 1903), pp. 1-22, 3 pls.; 18. H. Grenacher, "Über die Nesselkapseln von Hydra," *Zool. Anz.* xviii. (1895), pp. 310-321, 7 figs.; 19. R. T. Günther, "On the Structure and Affinities of *Mnestra parasites* Krohn; with a revision of the Classification of the *Cladonemidae*," *Mitt. Stat. Neapel*, xvi. (1903), pp. 35-62, pls. ii, iii; 20. E. Haeckel, "Das System der Medusen," *Denkschr. med.-nat.-wiss. Ges. (Jena, 1879-1881)*; 21. "Deep Sea Medusae," in *Report of the Challenger Expedition*, Zool. iv. pt. 2 (London, 1882); 22. P. Hallez, "Bougainvillia frutescens, une des espèces de la facies d'ou agitée du Bougainvillia ramosa Van Ben.," *C.-R. Acad. Sci. Paris*, exc. (1905), pp. 457-459; 23. O. & R. Hertwig, *Der Organismus der Medusen* (Jena, 1878), 70 pp., 3 pls.; 24. *Das Nervensystem und die Sinnesorgane der Medusen* (Leipzig, 1878), 186 pp., 10 pls.; 25. S. J. Hickson, "The Medusae of *Millepora*," *Proc. Roy. Soc. Lxvii.* (1899), pp. 6-10, 10 figs.; 26. T. Hincks, *A History of British Medusae* (2 vols., London, 1868); 27. N. Iwanzow, "Über den Bau, die Wirkungsweise und die Fortpflanzung der Nesselkapseln von Coelenteraten," *Bull. Soc. Imp. Natural. Moscou* (1896), pp. 323-355, 4 pls.; 28. C. F. Jickell, "Der Bau der Hydroid-polypern," (1) *Morph. Jahrbuch*, xlv. (1883), pp. 373-416, pls. xvi-xviii; (2) *l.c.*, pp. 580-680, pls. xxv-xxviii; 29. Albert Lang, "Über die Knospung bei Hydra und einigen Hydroidpolypern," *Zeitschr. f. wiss. Zool.* lv. (1892), pp. 365-384, pl. xvii; 30. Arnold Lang, *Gastroblasta Raffaelei*. Eine durch eine Art unvollständiger Teilung entstehende Meduse und Kolonie; *Jena Zeitschr.* xix. (1886), pp. 73-762, pls. xx, xxi; 31. A. Linko, "Observations sur les méduses de la mer Blanche," *Trav. Soc. Imp. Nat. St. Pétersbourg*, xxix. (1899); 32. "Über den Bau der Augen bei den Hydromedusen," *Zapiski Imp. Akad. Nauk (Mém. Acad. Imp. Sci. St. Pétersbourg)* (8) x. 3 (1900), 23 pp., 2 pls.; 33. O. Maas, "Die Craspedote Medusen," in *Eregebn. Plankton Expedition*, ii. (Kiel and Leipzig, 1893), 107 pp., 8 pls., 3 figs.; 34. "Die Medusen," *Mem. Mus. Comp. Zool. Harvard*, xxiii. (1897), 1; 35. "On *Hydroctena*," *Zool. Centralbl.* xi. (1892), pp. 240-242, 3 pls.; 36. "Revision der méduses appartenant aux familles des *Cunanthidae* et des *Aeginidae*, et groupement nouveau des genres," *Bull. Mus. Monaco*, v. (1904), 8 pp.; 37. "Revision der *Cunanthidae* Haeckels," *SB. K. Bayer. Akad.* xxv. (1904), pp. 421-445; 38. "Medusen," *Result. Camp.*

Sci. Monaco, xxviii, (1904), 71 pp., 6 pls.; 39. "Die Craspedoten Medusen der Siboga-Expedition." *Uitkomst. Siboga-Exp.-s.* (1905), 84 pp., 14 pls.; 40. "Die arktischen Medusen (ausschliesslich der Polymedusen)." *Fauna arctica*, iv, (1906), pp. 479-526; 41. C. Mereschkowsky, "On a new Genus of Hydroids (*Monobrachium*) from the White Sea, with a short description of other new Hydroids," *Ann. Mag. Nat. Hist.* (4) xx, (1877), pp. 220-229, pls. v, vi.; 42. E. Metchnikoff, "Studien über die Entwicklung der Medusen und Siphonophoren," *Zeitschr. f. wiss. Zool.* xxiv, (1874), pp. 15-83, pls. i-vii.; 43. "Vergleichend-embryologische Studien" (*Geryoniden, Cumina*), *Abd.* xxxvii, (1882), pp. 437-458, pl. xxviii.; 44. *Embryologische Studien an Medusen* (Vienna, 1886), 150 pp., 12 pls., 10 figs.; 45. "Medusologische Mittheilungen." *Arch. zool. Inst. Wien*, vi, (1886), pp. 237-266, pls. xxii, xxiii.; 46. L. Murbach, "Beiträge zur Kenntniss der Anatomie und Entwicklung der Nesseltorgane der Hydroiden," *Arch. f. Naturgesch.* lx. i, (1894), pp. 217-254, pl. xii.; 47. "Preliminary Note on the Life-History of *Goniomemus*," *Journ. Morph.* xi, (1895), pp. 493-496; 48. L. Murbach and C. Shearer, "On Medusae from the Coast of British Columbia and Alaska," *Proc. Zool. Soc.* (1903), ii, pp. 164-191, pls. xvii-xxii.; 49. H. F. Perkins, "The Development of *Goniomema murbachii*," *Proc. Acad. Nat. Sci. Philadelphia* (1902), pp. 750-790, pls. xxxi-xxxv.; 50. F. Schaudinn, "Über *Halermitta cumulans*, n. g. n. sp., einen marinen Hydroidpolypen," *SB. Ges. naturforsch. Freunde Berlin* (1894), pp. 226-234, 8 figs.; 51. F. E. Schulze, "On the Structure and Arrangement of the Soft Parts in *Euplectella aspergillum*," (*Amphibrachium*), *Tr. R. Soc. Edinburgh*, xxix, (1880), pp. 661-673, pl. xvii.; 52. O. Seeliger, "Über das Verhalten der Keimblätter bei der Knospung der Cölenteraten," *Zeitschr. f. wiss. Zool.* lviii, (1894), pp. 152-188, pls. vii-ix.; 53. W. B. Spencer, "A new Family of Hydroids (*Clathrozoön*), together with a description of the Structure of a new Species of *Plumularia*," *Trans. Roy. Soc. Victoria* (1890), pp. 121-140, 7 pls.; 54. M. Ussow, "A new Form of Fresh-water Coelenterate" (*Polypodium*), *Ann. Mag. Nat. Hist.* (5) xviii, (1886), pp. 110-124, pl. iv.; 55. E. Vanhöffen, "Versuch einer natürlichen Gruppierung der Anthomedusen," *Zool. Anzeiger*, xiv, (1891), pp. 439-446; 56. C. Viguier, "Études sur les animaux inférieurs de la baie d'Alger" (*Tetraplatia*), *Arch. Zool. Exp. Gen. viv.* (1890), pp. 101-142, pls. vii-ix.; 57. J. Wagner, "Recherches sur l'organisation de *Monobrachium parasiticum* Méréjék," *Arch. biol.* x, (1890), pp. 273-309, pls. viii, ix.; 58. A. Weismann, *Die Entstehung der Sexualzellen bei den Hydromedusen*, (Jena, 1883); 59. R. Woltereck, "Beiträge zur Ontogenie und Ableitung des Siphonophorenstocks," *Zeitschr. f. wiss. Zool.* lxxiii, (1905), pp. 611-637, 21 text-figs.; 60. J. Wulfer, "Die Embryonalentwicklung von *Gonothyrea loveni* Allm.," *Zeitschr. f. wiss. Zool.* lxxi, (1902), pp. 296-326, pls. xvi-xviii.

**HYDROMETER** (Gr. ὑδωρ, water, and μέτρον, a measure), an instrument for determining the density of bodies, generally of fluids, but in some cases of solids. When a body floats in a fluid under the action of gravity, the weight of the body is equal to that of the fluid which it displaces (see HYDROMECHANICS). It is upon this principle that the hydrometer is constructed, and it obviously admits of two modes of application in the case of fluids: either we may compare the weights of floating bodies which are capable of displacing the same volume of different fluids, or we may compare the volumes of the different fluids which are displaced by the same weight. In the latter case, the densities of the fluids will be inversely proportional to the volumes thus displaced.

The hydrometer is said by Synesius Cyrenese in his fifth letter to have been invented by Hypatia at Alexandria,<sup>1</sup> but appears to have been neglected until it was reinvented by Robert Boyle, whose "New Essay Instrument," as described in the *Phil. Trans.* for June 1675, differs in no essential particular from Nicholson's hydrometer. This instrument was devised for the purpose of detecting counterfeit coin, especially guineas and half-guineas. In the first section of the paper (*Phil. Trans.* No. 115, p. 329) the author refers to a glass instrument exhibited by himself many years before, and "consisting of a bubble furnished with a long and slender stem, which was to be put into several liquors, to compare and estimate their specific gravities." This seems to be the first reference to the hydrometer in modern times.

In fig. 1 C represents the instrument used for guineas, the circular plates A representing plates of lead, which are used as ballast when lighter coins than guineas are examined. B

<sup>1</sup>In *Nicholson's Journal*, iii, 80, Citizen Eusebe Salverte calls attention to the poem "De Ponderibus et Mensuris" generally ascribed to Rhemnius Fannius Palaemon, and consequently 300 years older than Hypatia, in which the hydrometer is described and attributed to Archimedes.

represents "a small glass instrument for estimating the specific gravities of liquors," an account of which was promised by Boyle in the following number of the *Phil. Trans.*, but did not appear.

The instrument represented at B (fig. 1), which is copied from Robert Boyle's sketch in the *Phil. Trans.* for 1675, is generally known as the common hydrometer.

It is usually made of glass, the lower bulb being loaded with mercury or small shot which serves as ballast, causing the instrument to float with the stem vertical. The quantity of mercury or shot inserted depends upon the density of the liquids for which the hydrometer is to be employed, it being essential that the whole of the bulb should be immersed in the heaviest liquid for which the instrument is used, while the length and diameter of the stem must be such that the hydrometer will float in the lightest liquid for which it is required. The stem is usually divided into a number of equal parts, the divisions of the scale being varied in different instruments, according to the purposes for which they are employed.

Let  $V$  denote the volume of the instrument immersed (i.e. of liquid displaced) when the surface of the liquid in which the hydrometer floats coincides with the lowest division of the scale,  $A$  the area of the transverse section of the stem,  $l$  the length of a scale division,  $n$  the number of divisions on the stem, and  $W$  the weight of the instrument. Suppose the successive divisions of the scale to be numbered 0, 1, 2, . . .  $n$  starting with the lowest, and let  $w_0, w_1, w_2, \dots, w_n$  be the weights of unit volume of the liquids in which the hydrometer sinks to the divisions 0, 1, 2, . . .  $n$  respectively. Then, by the principle of Archimedes,

$$\begin{aligned} W &= Vw_0; \text{ or } w_0 = W/V. \text{ Also} \\ W &= (V+IA)w_1; \text{ or } w_1 = W/(V+IA), \\ w_p &= W/(V+pIA), \text{ and} \\ w_n &= W/(V+nIA), \end{aligned}$$

or the densities of the several liquids vary inversely as the respective volumes of the instrument immersed in them; and, since the divisions of the scale correspond to equal increments of volume immersed, it follows that the densities of the several liquids in which the instrument sinks to the successive divisions form a harmonic series.

If  $V = NIA$  then  $N$  expresses the ratio of the volume of the instrument up to the zero of the scale to that of one of the scale-divisions. If we suppose the lower part of the instrument replaced by a uniform bar of the same sectional area as the stem and of volume  $V$ , the indications of the instrument will be in no respect altered, and the bottom of the bar will be at a distance of  $N$  scale-divisions below the zero of the scale.

In this case we have  $w_p = W/(N+p)IA$ , or the density of the liquid varies inversely as  $N+p$ , that is, as the whole number of scale-divisions between the bottom of the tube and the plane of flotation.

If we wish the successive divisions of the scale to correspond to equal increments in the density of the corresponding liquids, then the volumes of the instrument, measured up to the successive divisions of the scale, must form a series in harmonic progression, the lengths of the divisions increasing as we go up the stem.

The greatest density of the liquid for which the instrument described above can be employed is  $W/V$ , while the least density is  $W/(V+nIA)$ , or  $W/(V+n)$ , where  $n$  represents the volume of the stem between the extreme divisions of the scale. Now, by increasing  $n$ , leaving  $V$  and  $W$  unchanged, we may increase the range of the instrument indefinitely. But it is clear that if we increase  $A$ , the sectional area of the stem, we shall diminish  $l$ , the length of a scale-division corresponding to a given variation of density, and thereby proportionately diminish the sensibility of the instrument, while diminishing the section  $A$  will increase  $l$  and proportionately increase the sensibility, but will diminish the range over which the instrument can be employed, unless we increase the length of the stem in the inverse ratio of the sectional area. Hence, to obtain great sensibility along with a considerable range, we require very long slender stems, and to these two objections apply in addition to the question of portability; for, in the first place, an instrument with a very long stem requires a very deep vessel of liquid for its complete immersion, and, in the second place, when most of the stem is above

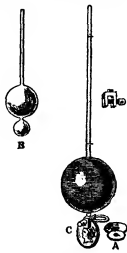

FIG. 1.—Boyle's New Essay Instrument.

the plane of flotation, the stability of the instrument when floating will be diminished or destroyed. The various devices which have been adopted to overcome this difficulty will be described in the account given of the several hydrometers which have been hitherto generally employed.

The plan commonly adopted to obviate the necessity of inconveniently long stems is to construct a number of hydrometers as nearly alike as may be, but to load them differently, so that the scale-divisions at the bottom of the stem of one hydrometer just overlap those at the top of the stem of the preceding. By this means a set of six hydrometers, each having a stem rather more than 5 in. long, will be equivalent to a single hydrometer with a stem of 30 in. But, instead of employing a number of instruments differing only in the weights with which they are loaded, we may employ the same instrument, and alter its weight either by adding mercury or shot to the interior (if it can be opened) or by attaching weights to the exterior. These two operations are not quite equivalent, since a weight added to the interior does not affect the volume of liquid displaced when the instrument is immersed up to a given division of the scale, while the addition of weights to the exterior increases the displacement. This difficulty may be met, as in Keene's hydrometer, by having all the weights of precisely the same volume but of different masses, and never using the instrument except with one of these weights attached.

The first hydrometer intended for the determination of the densities of liquids, and furnished with a set of weights to be attached when necessary, was that constructed by Mr Clarke (instrument-maker) and described by J. T. Desaguliers in the *Philosophical Transactions* for March and April 1730, No. 413, p. 278. The following is Desaguliers's account of the instrument (fig. 2):—

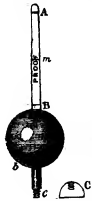

FIG. 2.—Clarke's Hydrometer.

After having made several fruitless trials with ivory, because it imbibes spirituous liquors, and thereby alters its gravity, he (Mr Clarke) at last made a copper hydrometer, represented in fig. 2, having a brass wire of about 1 in. thick going through, and soldered into the copper ball Bb. The upper part of this wire is filed flat on one side, for the stem of the hydrometer, with a mark at m, to which it sinks exactly in proof spirits. There are two other marks, A and B, at top and bottom of the stem, to show whether the liquid be  $\frac{1}{2}$ th above proof (as when it sinks to A), or  $\frac{1}{2}$ th under proof (as when it emerges to B), when a brass weight such as C has been screwed on to the bottom at c. There are a great many such weights, of different sizes, and marked to be screwed on instead of C, for liquors that differ more than  $\frac{1}{2}$ th from proof, so as to serve for the specific gravities in all such proportions as relate to the mixture of spirituous liquors, in all the variety made use of in trade. There are also other balls for showing the specific gravities quite to common water, which make the instrument perfect in its kind."

Clarke's hydrometer, as afterwards constructed for the purposes of the excise, was provided with thirty-two weights to adapt it to spirits of different specific gravities, and eleven smaller weights, or "weather weights" as they were called, which were attached to the instrument in order to correct for variations of temperature. The weights were adjusted for successive intervals of 5° F., but for degrees intermediate between these no additional correction was applied. The correction for temperature thus afforded was not sufficiently accurate for excise purposes, and William Speer in his essay on the hydrometer (Tilloch's *Phil. Mag.*, 1802, vol. xiv.) mentions cases in which this imperfect compensation led to the extra duty payable upon spirits which were more than 10% over proof being demanded on spirits which were purposely diluted to below 10% over proof in order to avoid the charge. Clarke's hydrometer, however, remained the standard instrument for excise purposes from 1787 until it was displaced by that of Sikes.

Desaguliers himself constructed a hydrometer of the ordinary type for comparing the specific gravities of different kinds of water (Desaguliers's *Experimental Philosophy*, ii. 234). In order to give great sensibility to the instrument, the large glass ball was made nearly 3 in. in diameter, while the stem consisted of a wire 10 in. in length and only  $\frac{1}{16}$  in. in diameter. The instrument weighed 4000 grains, and the addition of a grain caused it to sink through an inch. By altering the quantity of shot in the

small balls the instrument could be adapted for liquids other than water.

To an instrument constructed for the same purpose, but on a still larger scale than that of Desaguliers, A. Deparcieux added a small dish on the top of the stem for the reception of the weights necessary to sink the instrument to a convenient depth. The effect of weights placed in such a dish or pan is of course the same as if they were placed within the bulb of the instrument, since they do not alter the volume of that part which is immersed.

The first important improvement in the hydrometer after its reinvention by Boyle was introduced by G. D. Fahrenheit, who adopted the second mode of construction above referred to, arranging his instrument so as always to displace the same volume of liquid, its weight being varied accordingly. Instead of a scale, only a single mark is placed upon the stem, which is very slender, and bears at the top a small scale pan into which weights are placed until the instrument sinks to the mark upon its stem. The volume of the displaced liquid being then always the same, its density will be proportional to the whole weight supported, that is, to the weight of the instrument together with the weights required to be placed in the scale pan.

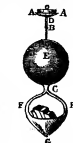

FIG. 3.—Nicholson's Hydrometer.

Nicholson's hydrometer (fig. 3) combines the characteristics of Fahrenheit's hydrometer and of Boyle's essay in instrument.<sup>1</sup> The following is the description given of it by W. Nicholson in the *Manchester Memoirs*, ii. 374:—

- "AA represents a small scale. It may be taken off at D. Diameter  $\frac{1}{8}$  in., weight 44 grains.
- "B is a stem of hardened steel wire. Diameter  $\frac{1}{16}$  in.
- "E a hollow copper globe. Diameter  $2\frac{1}{2}$  in. Weight with stem 360 grains.
- "FF stirrup of wire screwed to the globe at C.
- "G a small scale, serving likewise as a counterpoise. Diameter  $\frac{1}{16}$  in. Weight with stirrup 1634 grains.
- "The other dimensions may be had from the drawing, which is one-sixth of the linear magnitude of the instrument itself.
- "In the construction it is assumed that the upper scale shall constantly carry 1000 grains when the lower scale is empty, and the instrument sunk in distilled water at the temperature of 60° Fahr. to the middle of the wire or stem. The length of the stem is arbitrary, as is likewise the distance of the lower scale from the surface of the globe. But, the length of the stem being settled, the lower scale may be made lighter, and, consequently, the globe less, the greater its distance is taken from the surface of the globe; and the contrary."

In comparing the densities of different liquids, it is clear that this instrument is precisely equivalent to that of Fahrenheit, and must be employed in the same manner, weights being placed in the top scale only until the hydrometer sinks to the mark on the wire, when the specific gravity of the liquid will be proportional to the weight of the instrument together with the weights in the scale.

In the subsequent portion of the paper above referred to, Nicholson explains how the instrument may be employed as a thermometer, since, fluids generally expanding more than the solids of which the instrument is constructed, the instrument will sink as the temperature rises.

To determine the density of solids heavier than water with this instrument, let the solid be placed in the upper scale pan, and let the weight now required to cause the instrument to sink in distilled water at standard temperature to the mark B be denoted by w, while W denotes the weight required when the solid is not present. Then W-w is the weight of the solid. Now let the solid be placed in the lower pan, care being taken that no bubbles of air remain attached to it, and let w<sub>1</sub> be the weight now required in the scale pan. This weight will exceed w in consequence of the water displaced by the solid, and the weight of the water thus displaced will be w<sub>1</sub>-w, which is therefore the weight of a volume of water equal to that of the solid. Hence, since the weight of the solid itself is W-w, its density must be (W-w)/(w<sub>1</sub>-w).

The above example illustrates how Nicholson's or Fahrenheit's hydrometer may be employed as a weighing machine for small weights.

In all hydrometers in which a part only of the instrument

<sup>1</sup> Nicholson's *Journal*, vol. i. p. 111, footnote.

is immersed, there is a liability to error in consequence of the surface tension, or capillary action, as it is frequently called, along the line of contact of the instrument and the surface of the liquid (see CAPILLARY ACTION). This error diminishes as the diameter of the stem is reduced, but is sensible in the case of the thinnest stem which can be employed, and is the chief source of error in the employment of Nicholson's hydrometer, which otherwise would be an instrument of extreme delicacy and precision. The following is Nicholson's statement on this point:—

"One of the greatest difficulties which attends hydropstatical experiments arises from the attraction or repulsion that obtains at the surface of the water. After trying many experiments to obviate the irregularities arising from this cause, I find reason to prefer the simple one of carefully wiping the whole instrument, and especially the stem, with a clean cloth. The weights in the dish must not be esteemed accurate while there is either a cumulus or a cavity in the water round the stem."

It is possible by applying a little oil to the upper part of the bulb of a common or of a Sikes's hydrometer, and carefully placing it in pure water, to cause it to float with the upper part of the bulb and the whole of the stem emerging as indicated in fig. 4, when it ought properly to sink almost to the top of the stem, the surface tension of the water around the circumference of the circle of contact, AA', providing the additional support required.

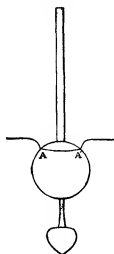

FIG. 4.

The universal hydrometer of C. Atkins, described in the *Phil. Mag.*, for 1808, xxxi. 254, is merely Nicholson's hydrometer with the screw at C projecting through the collar into which it is screwed, and terminating in a sharp point above the cup G. To this point soft bodies lighter than water (which would float if placed in the cup) could be attached, and thus completely immersed. Atkins's instrument was constructed so as to weigh 700 grains, and when immersed to the mark on the stem in distilled water at 60° F. it carried 300 grains in the upper dish. The hydrometer therefore displaced 1000 grains of distilled water at 60° F. and hence the specific gravity of any other liquid was at once indicated by adding 700 to the number of grains in the pan required to make the instrument sink to

the mark on the stem. The small divisions on the scale corresponded to differences of 1/10th of a grain in the weight of the instrument. The "Gravimeter," constructed by Citizen Guyton and described in *Nicholson's Journal*, 4to, i. 110, differs from Nicholson's instrument in being constructed of glass, and having a cylindrical bulb about 21 centimetres in length and 22 millimetres in diameter. Its weight is so adjusted that an additional weight of 5 grammes must be placed in the upper pan to cause the instrument to sink to the mark on the stem in distilled water at the standard temperature. The instrument is provided with an additional piece, or "plongeur," the weight of which exceeds 5 grammes by the weight of water which it displaces; that is to say, it is so constructed that its weight in water, and consists of a glass envelope filled with mercury. It is clear that the effect of this "plongeur," when placed in the lower pan, is exactly the same as that of the 5 gramme weight in the upper pan. Without the extra 5 grammes the instrument weighs about 20 grammes, and therefore floats in a liquid of specific gravity .8. Thus deprived of its additional weight it may be used for spirits. To use the instrument for liquids of much greater density than water additional weights must be placed in the upper pan, and the "plongeur" is then placed in the lower pan for the purpose of giving to the instrument the requisite buoyancy.

Charles's balance areometer is similar to Nicholson's hydrometer, except that the lower basin admits of inversion, thus enabling the instrument to be employed for solids lighter than water, the inverted basin serving the same purpose as the pointed screw in Atkins's modification of the instrument.

Adie's sliding hydrometer is of the ordinary form, but can be adjusted for liquids of widely differing specific gravities by drawing out a sliding tube, thus changing the volume of the hydrometer while its weight remains constant.

The hydrometer of A. Baumé, which has been extensively used in France, consists of a common hydrometer graduated in the following manner. Certain fixed points were first determined upon the stem of the instrument. The first of these was found by immersing the hydrometer in pure water, and marking the stem at the level of the surface. This formed the zero of the scale. Fifteen standard solutions of pure common salt in water were then prepared, contain-

ing respectively 1, 2, 3, . . . 15% (by weight) of dry salt. The hydrometer was plunged in these solutions in order, and the stem having been marked at the several surfaces, the degrees so obtained were numbered 1, 2, 3, . . . 15. These degrees were, when necessary, repeated along the stem by the employment of a pair of compasses till 80 degrees were marked off. The instrument thus adapted to the determination of densities exceeding that of water was called the hydrometer for salts.

The hydrometer intended for densities less than that of water, or the hydrometer for spirits, is constructed on a similar principle. The instrument is so arranged that it floats in pure water with most of the stem above the surface. A solution containing 10% of pure salt is used to indicate the zero of the scale, and the point at which the instrument floats when immersed in distilled water at 10° R. (54 1/2° F.) is numbered 10. Equal divisions are then marked off upwards along the stem as far as the 50th degree.

The densities corresponding to the several degrees of Baumé's hydrometer are given by Nicholson (*Journal of Philosophy*, i. 89) as follows:—

## Baumé's Hydrometer for Spirits. Temperature 10° R.

Degrees.	Density.	Degrees.	Density.	Degrees.	Density.
10	1.000	21	.922	31	.861
11	.990	22	.915	32	.856
12	.985	23	.909	33	.852
13	.980	24	.903	34	.847
14	.970	25	.897	35	.842
15	.963	26	.892	36	.837
16	.955	27	.886	37	.832
17	.949	28	.880	38	.827
18	.943	29	.874	39	.822
19	.935	30	.867	40	.817
20	.928				

## Baumé's Hydrometer for Salts.

Degrees.	Density.	Degrees.	Density.	Degrees.	Density.
0	1.000	27	1.230	51	1.547
3	1.020	30	1.261	54	1.594
6	1.040	33	1.295	57	1.659
9	1.064	36	1.333	60	1.717
12	1.089	39	1.373	63	1.779
15	1.114	42	1.414	66	1.848
18	1.140	45	1.455	69	1.920
21	1.170	48	1.500	72	2.000
24	1.200				

Cartier's hydrometer was very similar to that of Baumé, Cartier having been employed by the latter to construct his instruments for the French revenue. The point at which the instrument floated in distilled water was marked 10° by Cartier, and 30° on Cartier's scale corresponded to 32° on Baumé's.

Perhaps the main object for which hydrometers have been constructed is the determination of the value of spirituous liquors, chiefly for revenue purposes. To this end an immense variety of hydrometers have been devised, differing mainly in the character of their scales.

In the Spenser's hydrometer the stem has the form of an octagonal prism, and upon each of the eight faces a scale is engraved, indicating the percentage strength of the spirit corresponding to the several divisions of the scale, the eight scales being adapted respectively to the temperature 35°, 40°, 45°, 50°, 55°, 60°, 65° and 70° F. Four small pins, which can be inserted into the counterpoise of the instrument, serve to adapt the instrument to the temperatures intermediate between those for which the scales are constructed. William Spenser was supervisor and chief assayer of spirits in the port of Dublin. For a more complete account of this instrument see *Tilloch's Phil. Mag.*, xiv. 151.

The hydrometer constructed by Jones, of Holborn, consists of a spheroidal bulb with a rectangular stem (fig. 5). Between the bulb and counterpoise is placed a thermometer, which serves to indicate the temperature of the liquid, and the instrument is provided with three weights which can be attached to the top of the stem. On the four sides of the stem AD are engraved four scales corresponding respectively to the unloaded instrument, and to the instrument loaded with the respective weights. The instrument when unloaded serves for the range from 74 to 47 over proof; when loaded with the first weight it indicates from 46 to 13 over proof, with the second weight from 13 over proof to 29 under proof, and with the third



FIG. 5.—Jones's

Hydrometer.

from 29 under proof to pure water, the graduation corresponding to is marked W at the bottom of the fourth scale. One side of the stem AD is shown in fig. 5, the other three in fig. 6. The thermometer is also provided with four scales corresponding to the scales above mentioned. Each scale has its zero in the middle corresponding to 60° F. If the mercury in the thermometer stand above this zero the spirit must be reckoned weaker than the hydrometer indicates by the number on the thermometer scale level with the top of the mercury, while if the thermometer indicate a temperature lower than the zero of the scale (60° F.) the spirit must be reckoned stronger by the scale reading. At the side of each of the four scales on the stem of the hydrometer is engraved a set of small numbers indicating the contraction in volume which would be experienced if the requisite amount of water (or spirit) were added to bring the sample tested to the proof strength.



FIG. 6.

incident on bringing the spirit to proof strength. It is provided with thirty-six different weights which, with the ten divisions on the stem, form a scale from 1 to 370. The employment of so many weights renders the instrument ill-adapted for practical work where speed is an object.

This instrument was adopted by the United States in 1790, but was subsequently discarded by the Internal Revenue Service for another type. In this latter form the observations have to be made at the standard temperature of 60° F., at which the graduation 100 corresponds to proof spirit and 200 to absolute alcohol. The need of adjustable weights is avoided by employing a set of five instruments, graduated respectively 0-100, 80-120, 100-140, 130-170, 160-200. The reading gives the volume of proof spirit equivalent to the volume of liquor; thus the readings 80° and 120° mean that 100 volumes of the test liquors contain the same amount of absolute alcohol as 80 and 120 volumes of proof spirit respectively. Proof spirit is defined in the United States as a mixture of alcohol and water which contains equal volumes of alcohol and water at 60° F., the alcohol having a specific gravity of 0.7939 at 60° as compared with water at its maximum density. The specific gravity of proof spirit is 0.93353 at 60°; and 100 volumes of the mixture is made from 50 volumes of absolute alcohol and 53.71 volumes of water.

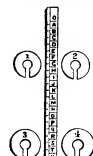

Quin's universal hydrometer is described in the *Transactions of the Society of Arts*, viii. 98. It is provided with a sliding rule to adapt it to different temperatures, and has four scales, one of which is graduated for spirits and the other three serve to show the strengths of worts. The peculiarity of the instrument consists in the pyramidal form given to the stem, which renders the scale-divisions more nearly equal in length than they would be on a prismatic stem.

Atkins's hydrometer, as originally constructed, is described in *Nicholson's Journal*, 8vo, ii. 276. It is made of brass, and is provided with a spheroidal bulb the axis of which is 2 in. in length, the conjugate diameter being  $\frac{1}{4}$  in. The whole length of the instrument is 8 in., the stem square of about  $\frac{1}{4}$ -in. side, and the weight about 40 grains. It is provided with four weights, marked 1, 2, 3, 4, and weighing respectively 20, 40, 61 and 82 grains, which can be attached to the Shank of the instrument at C (fig. 7) and retained there by the fixed weight B. The scale engraved upon one face of the stem contains fifty-five divisions, the top and bottom being marked 0 or zero and the alternate intermediate divisions (of which there are

FIG. 7.—Atkins's Hydrometer.

twenty-six) being marked with the letters of the alphabet in order. The four weights are so adjusted that, if the instrument floats with the stem emerging as far as the lower division 0 with one of the weights attached, then replacing the weight by the next heavier causes the instrument to sink through the whole length of the scale to the upper division 0, and the first weight produces the same effect when applied to the naked instrument. The stem is thus virtually extended to five times its length, and the number of divisions increased practically to 272. When no weight is attached the instrument indicates densities from .806 to .843; with No. 1 it registers from .843 to .880, with No. 2 from .880 to .918, with No. 3 from .918 to .958, and with No. 4 from .958 to 1.000, the temperature being

55° F. It will thus be seen that the whole length of the stem corresponds to a difference of density of about .04, and one division to about .00074, indicating a difference of little more than  $\frac{1}{4}$  in the strength of any sample of spirits.

The instrument is provided with a sliding rule, with scales corresponding to the several weights, which indicate the specific gravity corresponding to the several divisions of the hydrometer scale compared with water at 55° F. The slider upon the rule serves to adjust the scale for different temperatures, and then indicates the strength of the spirit in percentages over or under proof. The slider is also provided with scales, marked respectively Ducas and Clarke, which serve to show the readings which would have been obtained had the instruments of those makers been employed. The line on the scale marked "concentration" indicates the diminution in volume consequent upon reducing the sample to proof strength (if it is over proof, O.P.) or upon reducing proof spirit to the strength of the sample (if it is under proof, U.P.). By applying the several weights in succession in addition to No. 4 the instrument can be employed for liquids heavier than water; and graduations on the other three sides of the stem, together with an additional slide rule, adapt the instrument for the determination of the strength of worts.

Atkins subsequently modified the instrument (*Nicholson's Journal*, 8vo, iii. 50) by constructing the different weights of different shapes, viz. circular, square, triangular and pentagonal, instead of numbering them 1, 2, 3 and 4 respectively, a figure of the weight being stamped on the sliding rule opposite to every letter in the series to which it belongs, thus diminishing the probability of mistakes. He also replaced the letters on the stem by the corresponding specific gravities referred to water as unity. Further information concerning these instruments and the state of hydrometry in 1803 will be found in Atkins's pamphlet *On the Relation between the Specific Gravities and the Strength of Spirituous Liquors* (1803); or *Phil. Mag.* xvi. 26-33, 205-212, 305-312; xvii. 204-210 and 329-341.

In Gay-Lussac's alcoholometer the scale is divided into 100 parts corresponding to the presence of 1, 2, ..., % by volume of alcohol at 15° C., the highest division of the scale corresponding to the purest alcohol he could obtain (density .7947) and the lowest division corresponding to pure water. A table provides the necessary corrections for other temperatures.

Tralles's hydrometer differs from Gay-Lussac's only in being graduated at 4° C. instead of 15° C., and taking alcohol of density .7939 at 15° C. for pure alcohol instead of .7947 as taken by Gay-Lussac (Keene's *Handbook of Hydrometry*).

In Beck's hydrometer the zero of the scale corresponds to density 1.000 and the division 30 to density .850, and equal divisions on the scale are continued as far as is required in both directions.

In the centesimal hydrometer of Franœeur the volume of the stem between successive divisions of the scale always  $\frac{1}{100}$ th of the whole volume immersed when the instrument floats in water at 4° C. In order to graduate the stem the instrument is first weighed, then immersed in distilled water at 4° C., and the line of flotation marked zero. The first degree is then found by placing on the top of the stem a weight equal to  $\frac{1}{100}$ th of the weight of the instrument, which increases the volume immersed by  $\frac{1}{100}$ th of the original volume. The addition to the top of the stem of successive weights, each  $\frac{1}{100}$ th of the weight of the instrument itself, serves to determine the successive degrees. The length of 100 divisions of the scale, or the length of the uniform stem the volume of which would be equal to that of the hydrometer up to the zero graduation, Franœeur called the "modulus" of the hydrometer. He constructed his instruments of glass, using different instruments for different portions of the scale (Franœeur, *Traité d'ariométrie*, Paris, 1842).

Dr Borriès of Montpellier constructed a hydrometer which was based upon the results of his experiments on mixtures of alcohol and water. The interval between the points corresponding to pure alcohol and to pure water Borriès divided into 100 equal parts, though the stem was prolonged so as to contain only 10 of these divisions, Hydrometer.

The instrument which has now been exclusively used for revenue purposes for nearly a century is that associated with the name of Bartholomew Sikes, who was correspondent to the Board of Excise from 1774 to 1783, and for some time collector of excise for Hertfordshire.

Sikes's hydrometer, on account of its similarity to that of Borriès, appears to have been borrowed from that instrument. It is made of gilded brass or silver, and consists of a spheroidal ball A (fig. 8), 1.5 in. in diameter, below which is a weight B connected with the ball by a short conical stem C. The stem D is rectangular in section and about  $\frac{3}{4}$  in. in length. This is divided into ten equal parts, each of which is subdivided into five. As in Borriès's instrument, a series of 9 weights, each of the form shown at E, serves to extend the scale

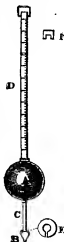

FIG. 8.—Sikes's Hydrometer.



to 100 principal divisions. In the centre of each weight is a hole capable of admitting the lowest and thickest end of the conical stem C, and a slot is cut into it just wide enough to allow the upper part of the cone to pass. Each weight can thus be dropped on to the lower stem so as to rest on the counterpoise B. The weights are marked 10, 20, . . . 90; and by using the instrument that weight must be selected which will allow it to float with a liquid with a portion only of the stem submerged. Then the reading of the scale at the line of flotation, added to the number on the weight, gives the reading required. A small superannuated weight F is added, which can be placed upon the top of the stem. F is so adjusted that when the 60 weight is placed on the lower stem the instrument sinks to the same point in distilled water when F is attached as in proof spirit when F is removed. The best instruments are now constructed for revenue purposes of silver, heavily gilded, because it was found that saccharic acid contained in some spirits attacked brass behind the gilding.

The following table gives the specific gravities corresponding to the principal graduations on Sikes's hydrometer at 60° F. and 62° F., together with the corresponding strengths of spirits. The latter are based upon the tables of Charles Gilpin, clerk to the Royal Society, for which the reader is referred to the *Phil. Trans.* for 1794. Gilpin's work is a model for its accuracy and thoroughness of detail, and his results have scarcely been improved upon by more recent workers. The merit of Sikes's system lies not so much in the hydrometer as in the complete system of tables by which the readings of the instrument are at once converted into percentage of proof-spirit.

Table showing the Densities corresponding to the Indications of Sikes's Hydrometer.

Sikes's Indications.	60° F.		62° F.		Sikes's Indications.	60° F.		62° F.	
	Density.	Proof Spirit per cent.	Density.	Proof Spirit per cent.		Density.	Proof Spirit per cent.	Density.	Proof Spirit per cent.
0	813297	105.0	813400	106.5	51	905829	110.0	906383	110.0
1	813656	105.1	813759	106.6	52	906222	110.1	906837	110.7
2	814015	105.2	814118	106.7	53	907072	110.6	908877	109.9
3	814374	105.3	814477	106.8	54	910162	107.1	914097	109.5
4	814733	105.4	814836	106.9	55	913252	103.6	919317	109.1
5	815092	105.5	815195	107.0	56	916342	100.1	924537	108.7
6	815451	105.6	815554	107.1	57	919432	102.7	929757	108.3
7	815810	105.7	815913	107.2	58	922522	99.2	934977	107.9
8	816169	105.8	816272	107.3	59	925612	96.7	940197	107.5
9	816528	105.9	816631	107.4	60	928702	94.2	945417	107.1
10	816887	106.0	816990	107.5	61	931792	91.7	950637	106.7
11	817246	106.1	817349	107.6	62	934882	89.2	955857	106.3
12	817605	106.2	817708	107.7	63	937972	86.7	961077	105.9
13	817964	106.3	818067	107.8	64	941062	84.2	966297	105.5
14	818323	106.4	818426	107.9	65	944152	81.7	971517	105.1
15	818682	106.5	818785	108.0	66	947242	79.2	976737	104.7
16	819041	106.6	819144	108.1	67	950332	76.7	981957	104.3
17	819400	106.7	819503	108.2	68	953422	74.2	987177	103.9
18	819759	106.8	819862	108.3	69	956512	71.7	992397	103.5
19	820118	106.9	820221	108.4	70	959602	69.2	997617	103.1
20	820477	107.0	820580	108.5	71	962692	66.7	1002837	102.7
21	820836	107.1	820939	108.6	72	965782	64.2	1008057	102.3
22	821195	107.2	821298	108.7	73	968872	61.7	1013277	101.9
23	821554	107.3	821657	108.8	74	971962	59.2	1018497	101.5
24	821913	107.4	822016	108.9	75	975052	56.7	1023717	101.1
25	822272	107.5	822375	109.0	76	978142	54.2	1028937	100.7
26	822631	107.6	822734	109.1	77	981232	51.7	1034157	100.3
27	822990	107.7	823093	109.2	78	984322	49.2	1039377	100.0
28	823349	107.8	823452	109.3	79	987412	46.7	1044597	99.6
29	823708	107.9	823811	109.4	80	990502	44.2	1049817	99.2
30	824067	108.0	824170	109.5	81	993592	41.7	1055037	98.8
31	824426	108.1	824529	109.6	82	996682	39.2	1060257	98.4
32	824785	108.2	824888	109.7	83	999772	36.7	1065477	98.0
33	825144	108.3	825247	109.8	84	1002862	34.2	1070697	97.6
34	825503	108.4	825606	109.9	85	1005952	31.7	1075917	97.2
35	825862	108.5	825965	110.0	86	1009042	29.2	1081137	96.8
36	826221	108.6	826324	110.1	87	1012132	26.7	1086357	96.4
37	826580	108.7	826683	110.2	88	1015222	24.2	1091577	96.0
38	826939	108.8	827042	110.3	89	1018312	21.7	1096797	95.6
39	827298	108.9	827401	110.4	90	1021402	19.2	1102017	95.2
40	827657	109.0	827754	110.5	91	1024492	16.7	1107237	94.8
41	828016	109.1	828113	110.6	92	1027582	14.2	1112457	94.4
42	828375	109.2	828416	110.7	93	1030672	11.7	1117677	94.0
43	828734	109.3	828775	110.8	94	1033762	9.2	1122897	93.6
44	829093	109.4	829124	110.9	95	1036852	6.7	1128117	93.2
45	829452	109.5	829463	111.0	96	1039942	4.2	1133337	92.8
46	829811	109.6	829812	111.1	97	1043032	1.7	1138557	92.4
47	830170	109.7	830211	111.2	98	1046122	0.0	1143777	92.0
48	830529	109.8	830552	111.3	99	1049212	0.0	1148997	91.6
49	830888	109.9	830881	111.4	100	1052302	0.0	1154217	91.2
50	831247	110.0	831240	111.5				1159437	90.8

In the above table for Sikes's hydrometer two densities are given corresponding to each of the degrees 20, 30, 40, 50, 60, 70, 80 and 90, indicating that the successive weights belonging to the particular instrument for which the table has been calculated do not quite agree. The discrepancy, however, does not produce any sensible error in the strength of the corresponding spirit.

A table which indicates the weight per gallon of spirituous liquors for every degree of Sikes's hydrometer is printed in 23 and 24 Viet. C. 114, schedule B. This table differs slightly from that given above, which has been abridged from the table given in Keene's *Handbook of Hydrometry*, apparently on account of the equal divisions on

Sikes's scale having been taken as corresponding to equal increments of density.

Sikes's hydrometer was established for the purpose of collecting the revenue of the United Kingdom by Act of Parliament, 56 Geo. III. c. 140, by which it was enacted that "all spirits shall be deemed and taken to be of the degree of strength which the said hydrometers called Sikes's hydrometers shall upon trial by any officer or officers of the customs or excise, denote such spirits to be." This act came into force on January 5, 1817, and was to have remained in force until August 1, 1818, but was repealed by 58 Geo. III. c. 28, which established Sikes's hydrometer on a permanent footing. By 3 and 4 Will. IV. c. 52, § 123, it was further enacted that the same instruments and methods should be employed in determining the duty upon imported spirits as should in virtue of any Act of Parliament be employed in the determination of the duty upon spirits distilled at home. It is the practice of the officers of the inland revenue to adjust Sikes's hydrometer at 62° F., that being the temperature at which the imperial gallon is defined as containing 10 lb avoirdupois of distilled water. The specific gravity of any sample of spirits thus determined, when multiplied by ten, gives the weight in pounds per imperial gallon, and the weight of any bulk of spirits divided by this number gives its volume in all imperial gallons.

Mr (afterwards Colonel) J. B. Keene, of the Hydrometer Office, London, has constructed an instrument after the model of Sikes's, but provided with twelve weights of different masses but equal volumes, and the instrument is never used without having one of these attached to it. When so loaded with the proper weight the instrument is specifically lighter than Sikes's hydrometer when unloaded, and it may thus be used for specific gravities as low as that of absolute alcohol. The volume of each weight being the same, the whole volume immersed is always the same when it floats at the same mark whatever weight may be attached.

Besides the above, many hydrometers have been employed for special purposes. Waddell's hydrometer is adapted for densities greater than that of water. The scale is so arranged that the reading multiplied by 5 and added to 1000 gives the specific gravity with reference to water as 1000. To avoid an inconveniently long stem, different instruments are employed for different parts of the scale as mentioned above.

The lactometer constructed by Dicus of Liverpool is adapted for the determination of the quality of milk. It resembles Sikes's hydrometer in other respects, but is provided with eight weights. It is also provided with a thermometer and slide rule, to reduce the readings to the standard temperature of 55° F. Any determination of density can be taken only as affording prima facie evidence of the quality of milk, as the removal of cream and the addition of water are operations which are liable to come into their influence on the density of the liquid, so that the lactometer cannot be regarded as a reliable instrument.

The marine hydrometers, as supplied by the British government to the royal navy and the merchant marine, are glass instruments with slender stems, and generally serve to indicate specific gravities from 1.000 to 1.040. Before being issued they are compared with a standard instrument, and their errors determined. They are employed for taking observations of the density of sea-water.

The salinometer is a hydrometer originally intended to indicate the strength of the brine in marine boilers in which sea-water is employed. Saunders's salinometer consists of a hydrometer which floats in a chamber through which the water from the boiler is allowed to flow in a gentle stream, at a temperature of 200° F. The peculiarity of the instrument consists in the stream of water, as it enters the hydrometer chamber, being made to impinge against a disk of metal, by which it is broken into drops, thus liberating the steam, which would otherwise disturb the instrument.

The use of Sikes's hydrometer necessitates the employment of a considerable quantity of spirit for the testing of spirits in bulk no more convenient instrument has been devised, but where very small quantities are available more suitable laboratory methods must be adopted.

In England, the Finance Act 1907 (7 Ed. VII. c. 13), section 4, provides as follows: (1) The Commissioners of Customs and the Commissioners of Inland Revenue may jointly make regulations authorizing the use of any means described in the regulations for ascertaining for any purpose the strength or weight of spirits. (2) Where under any enactment Sykes's (*sic*) Hydrometer is directed to be used or may be used for the purpose of ascertaining the strength or weight of spirits, any means so authorized by regulations may be used instead of Sykes's Hydrometer and reference to Sykes's Hydrometer in any enactment shall be construed accordingly. (3) Any regulations made under this section shall be published in the London, Edinburgh and Dublin Gazette, and shall take effect from the date of publication, or such later date as may be mentioned in the regulations for the purpose. (4) The expression "spirits" in this section has the same meaning as in the Spirits Act 1880. (W. G.)

**HYDROPATHY**, the name given, from the Greek, to the "water-cure," or the treatment of disease by water, used outwardly and inwardly. Like many descriptive names, the word "hydrophaty" is defective and even misleading, the active agents in the treatment being heat and cold, of which water

is little more than the vehicle, and not the only one. Thermo-therapeutics (or thermotherapy) is a term less open to objection.

Hydropathy, as a formal system, dates from about 1829, when Vincenz Priessnitz (1801-1851), a farmer of Gräfenberg in Silesia, Austria, began his public career in the paternal homestead, extended so as to accommodate the increasing numbers attracted by the fame of his cures. Two English works, however, on the medical uses of water had been translated into German in the century preceding the rise of the movement under Priessnitz. One of these was by Sir John Floyer (1649-1734), a physician of Lichfield, who, struck by the remedial use of certain springs by the neighbouring peasantry, investigated the history of cold bathing, and published in 1702 his "Ψυχρονομοία, or the History of Cold Bathing, both Ancient and Modern." The book ran through six editions within a few years, and the translation was largely drawn upon by Dr J. S. Hahn of Silesia, in a work published in 1738, *On the Healing Virtues of Cold Water, Inwardly and Outwardly applied, as proved by Experience.* The other work was that of Dr James Currie (1756-1805) of Liverpool, entitled *Medical Reports on the Effects of Water, Cold and Warm, as a Remedy in Fevers and other Diseases*, published in 1797, and soon after translated into German by Michaelis (1801) and Hegewisch (1807). It was highly popular, and first placed the subject on a scientific basis. Hahn's writings had meanwhile created much enthusiasm among his countrymen, societies having been everywhere formed to promote the medicinal and dietetic use of water; and in 1804 Professor Örtel of Ansbach republished them and quickened the popular movement by unqualified commendation of water drinking as a remedy for all diseases. In him the rising Priessnitz found a zealous advocate, and doubtless an instructor also.

At Gräfenberg, to which the fame of Priessnitz drew people of every rank and many countries, medical men were conspicuous by their numbers, some being attracted by curiosity, others by the desire of knowledge, but the majority by the hope of cure for ailments which had as yet proved incurable. Many records of experiences at Gräfenberg were published, all more or less favourable to the claims of Priessnitz, and some enthusiastic in their estimate of his genius and penetration; Captain Claridge introduced hydropathy into England in 1840, his writings and lectures, and later those of Sir W. Erasmus Wilson (1809-1884), James Manby Gully (1808-1883) and Edward Johnson, making numerous converts, and filling the establishments opened soon after at Malvern and elsewhere. In Germany, France and America hydropathic establishments multiplied with great rapidity. Antagonism ran high between the old practice and the new. Unsparring condemnation was heaped by each on the other; and a legal prosecution, leading to a royal commission of inquiry, served but to make Priessnitz and his system stand higher in public estimation.

Increasing popularity diminished before long that timidity which had in great measure prevented trial of the new method from being made on the weaker and more serious class of cases, and had caused hydropathists to occupy themselves mainly with a sturdy order of chronic invalids well able to bear a rigorous regimen and the severities of unrestricted crisis. The need of a radical adaptation to the former class was first adequately recognized by John Smedley, a manufacturer of Derbyshire, who, impressed in his own person with the severities as well as the benefits of "the cold water cure," practised among his work-people a milder form of hydropathy, and began about 1852 a new era in its history, founding at Matlock a counterpart of the establishment at Gräfenberg.

Ernst Brand (1826-1807) of Berlin, Räljen and Theodor von Jürgensen of Kiel, and Karl Liebermeister (1833-1901) of Basel, between 1860 and 1870, employed the cooling bath in abdominal typhus with striking results, and led to its introduction to England by Dr Wilson Fox. In the Franco-German war the cooling bath was largely employed, in conjunction frequently with quinine; and it now holds a recognized position in the treatment of hyperpyrexia. The wet sheet pack has become part of medical practice; the Turkish bath, introduced

by David Urquhart (1805-1877) into England on his return from the East, and ardently adopted by Dr Richard Barter (1802-1870) of Cork, has become a public institution, and, with the "morning tub" and the general practice of water drinking, is the most noteworthy of the many contributions by hydropathy to public health (see BATHS, *ad fin.*).

The appliances and arrangements by means of which heat and cold are brought to bear on the economy are—(a) Packings, hot and cold, general and local, sweating and cooling; (b) hot air and steam baths; (c) general baths, of hot water and cold; (d) sitz, spinal, head and foot baths; (e) bandages (or compresses), wet and dry; also (f) fomentations and poultices, hot and cold, sinapisms, stupes, rubbings and water potations, hot and cold.

(a) Packings.—The full pack consists of a wet sheet enveloping the body, with a number of dry blankets packed tightly over it, including a macintosh covering or not. In an hour or less these are removed and a general bath administered. The pack is a derivative, sedative, sudorific and stimulator of cutaneous excretion. There are numerous modifications of it, notably the cooling pack, where the wrappings are loose and scanty, permitting evaporation, and the application of indefinite duration, the sheet being rewetted as it dries; this is of great value in protracted febrile conditions. There are also local packs, to trunk, limbs or head separately, which are derivative, soothing or stimulating, according to circumstance and detail.

(b) Hot air baths, the chief of which is the Turkish (properly, the Roman) bath, consisting of two or more chambers ranging in temperature from 120° to 212° or higher, but mainly used at 150° for curative purposes. Exposure is from twenty minutes up to two hours according to the effect sought, and is followed by a general bath, and occasionally by soaping and shampooing. It is stimulating, derivative, depurative, sudorific and alterative, powerfully promoting tissue change by increase of the natural waste and repair. It determines the blood to the surface, reducing internal congestions, is a potent diaphoretic, and, through the extraction of heat and cold, is an effective nervine and vascular stimulant and tonic. Morbid growths and secretions, as also the uræmic, gouty and rheumatic diathesis, are beneficially influenced by it. The full pack and Turkish bath have between them usurped the place and bettered the function of the once familiar hot bath. The Russian or steam bath and the lamp bath are primitive and inferior varieties of the modern Turkish bath, the atmosphere of which cannot be too dry and pure.

(c) General baths comprise the rain (or needle), spray (or rose), shower, shallow, plunge, douche, wave and common morning sponge baths, with the dripping sheet, and hot and cold spongings, and the combinations, as a rule, of hot and cold water. They are stimulating, tonic, derivative and detergent.

(d) Local baths comprise the sitz (or sitting), douche (or spouting), spinal, foot and head baths, of hot or cold water, singly or in combination, successive or alternate. The sitz, head and foot baths are used "flowing" on occasion. The application of cold by "Leiter's tubes" is effective for reducing inflammation (e.g. in meningitis and in sunstroke); in these a network of metal or indiarubber tubing is fitted to the part affected, and cold water kept continuously flowing through them. Rapid alternations of hot and cold water have a powerful effect in vasomotor stasis and laryngitis; the nervous system and absorbents, yielding valuable results in local congestions and chronic inflammations.

(e) Bandages (or compresses) are of two kinds,—cooling, of wet material left exposed for evaporation, used in local inflammations and fevers; and heating, of the same, covered with waterproof material, used in congestion, external or internal, for short or long periods. Poultices, warm, of bread, linseed, bran, &c., changed but twice in twenty-four hours, are identical in action with the heating bandage, and superior only in the greater warmth and consequent vital activity their closer application to the skin ensures.

(f) Fomentations and poultices, hot or cold, sinapisms, stupes, rubefacients, irritants, frictions, kneadings, calisthenics, gymnastics, electricity, &c., are adjuncts largely employed.

BIBLIOGRAPHY.—Among the numerous earlier works on hydropathy, the following are worth mention: Balbircie, *Water Cure in Consumption* (1847); *Hydropathic Aphorisms* (1856); *A Plea for the Turkish Bath* (1862); Ben-Barde, *Traité d'hydrothérapie* (1874); Claridge, *Cold Water Cure, or Hydropathy* (1841); *Facts and Evidence in Support of Hydropathy* (1843) and *Cold Water, Tepid Water and Friction Cure* (1849); Dunlop, *Hydrophobia of the Bath* (1873); Floyer, *Psychronomia, or the History of Cold-Bathing* (1702); J. S. Hahn (Schweidnitz), *Observations on the Healing Virtues of Cold Water* (1738); Hunter, *Hydrophaty for Home Use* (1879); E. W. Lane, *Hydrophaty, or the Natural System of Medical Treatment* (1857); R. J. Lane, *Life at the Water Cure* (1851); Shew, *Hydrophaty Family Physician* (1857); Smedley, *Practical Hydrophaty* (1879); Smethurst, *Hydrothérapie, or the Water Cure* (1843); Wainwright, *Inquiry into the Nature and Use of Baths* (1737); Weiss, *Handbook of Hydrophaty* (1844); Wilson *Principles and Practice of the Cold Water Cure* (1854) and *The Water Cure* (1859). A useful recent work dealing comprehensively with the subject is Richard Metcalfe's *Rise and Progress of Hydrophaty* (1906).

**HYDROPHOBIA** (Gr. ὕδωρ, water, and φόβος, fear; so called from the symptom of dread of water), or **RABIES** (Lat. for "madness"), an acute disease, occurring chiefly in certain of the lower animals, particularly the canine species, and liable to be communicated by them to other animals and to man.

*In Dogs, &c.*—The occurrence of rabies in the fox, wolf, hyaena, jackal, raccoon, badger and skunk has been asserted; but there is every probability that it is originally a disease of the dog. It is communicated by inoculation to nearly all, if not all, warm-blooded creatures. The transmission from one animal to another only certainly takes place through inoculation with viruliferous matters. The malady is generally characterized at a certain stage by an irrepresible desire in the animal to act offensively with its natural weapons—dogs and other carnivora attacking with their teeth, herbivora with their hoofs or horns, and birds with their beaks, when excited ever so slightly. In the absence of excitement the malady may run its course without any fit of fury or madness.

*Symptoms.*—The disease has been divided into three stages or periods, and has also been described as appearing in at least two forms, according to the peculiarities of its symptoms. It usually runs the period of the disease does not pass suddenly into another, the transition being almost imperceptible; and the forms do not differ essentially from each other, but appear merely to constitute varieties of the same disease, due to the natural disposition of the animal, or other modifying circumstances. These forms have been designated *true or furious rabies* (Fr. *rage vraie*; Ger. *rasende Wuth*) and *dumb rabies* (Fr. *rage muet*; Ger. *stille Wuth*).

The malady does not commence with fury and madness, but in a strange and anomalous change in the habits of the dog; it becomes dull, gloomy, and taciturn, and seeks to isolate itself in out-of-the-way places, retiring beneath chairs and to odd corners. But in its retirement it cannot rest; it is uneasy and fidgety, and no sooner has it lain down than suddenly it jumps up in an agitated manner, walks backwards and forwards several times, again lies down and assumes a sleeping attitude, but has only maintained it for a few minutes when it is once more moving about. Again it retires to its corner, to the farthest recess it can find, and huddles itself up into a cap, with its head concealed beneath its chest and fore-paws. This state of continual agitation and inquietude is in striking contrast with its ordinary habits, and should therefore receive attention. Not unfrequently there are a few moments when the creature appears more lively than usual, and displays an extraordinary amount of affection. Sometimes there is a disposition to gather up straw, thread, bits of wood, &c., which are industriously carried away; a tendency to lick anything cold, as iron, stones, &c., is also observed in many instances; and there is also a desire evincing to lick other animals.

Sexual excitement also frequently an early symptom. At this period no disposition to bite is observed; the animal is docile with its master and obeys his voice, though not so readily as before, nor with the same pleased countenance. There is something strange in the expression of its face, and the voice of its owner is scarcely able to make it change from a sudden gloominess to its usual animated aspect. These symptoms gradually become more marked; the restlessness and agitation increase. If on straw the dog scatters and pulls it about with its paws, and if in a room it scratches and tumbles the cushions or rugs on which it usually lies. It is constantly on the move, rambling about, scratching the ground, sniffing in corners and in the corners, as if on the scent or seeking for something. It indulges in strange movements, as if affected by some mental influences or a prey to hallucinations. When not excited by any external influence it will remain for a brief period perfectly still and attentive, as if watching something, or following the movements of some creature on the wall; then it will suddenly dart forward and snap at the vacant air, as if pursuing an annoying object, or endeavouring to seize a fly. At another time it throws itself, yelling and furious, against the wall, as if he heard threatening voices on the other side, or was bent on attacking an enemy. Nevertheless, the animal is still docile and submissive, for its master's voice will bring it out of its frenzy. But the saliva is already virulent, and the excessive affection which it evinces at intervals, by licking the hands or face of those it loves, renders the danger very great should there be a wound or abrasion. Until a late period in the disease the master's voice has a powerful influence over the animal. When it has escaped from all control and wanders erratically abroad, ferocious and restless, and haunted by horrid phantasms, the familiar voice yet exerts its influence, and it is rare indeed that it attacks its master.

There is no dread of water in the rabid dog; the animal is generally thirsty, and if water be offered will lap it with avidity, and swallow it at the commencement of the disease. And when, at a later period, the constriction about the throat—symptomatic of the disease—renders swallowing difficult, the dog will none the less endeavour to drink, and the lappings are so frequent and prolonged when deglutition becomes impossible. So little dread has the rabid dog of water

that it will ford streams and swim rivers; and when in the ferocious stage it will even do this in order to attack other creatures on the opposite side.

At the commencement of the disease the dog does not usually refuse to eat, and some animals are voracious to an unusual degree. But in a short time it becomes fastidious, and eating what it usually has a special predilection for. Soon, however, this gives place to a most characteristic symptom—either the taste becomes extremely depraved or the dog has a fatal and imperious desire to bite and ingest everything. The litter of its kennel, wool from cushions, carpets, stockings, slippers, wood, grass, earth, stones, glass, horse-dung, even its own faeces and urine, or whatever else may come in its way, are devoured. On examination of the body of a dog which has died of rabies it is so common to find in the stomach a quantity of dissimilar and strange matters on which the teeth have been exercised that, if there was nothing known of the animal's history, there would be strong evidence of its having been affected with the disease. When a dog, then, is observed to gnaw and eat suchlike matters, though it exhibits no tendency to bite, it should be suspected.

The mad dog does not usually foam at the mouth to any great extent at first. The mucus of the mouth is not much increased in quantity, but it soon becomes thicker, viscid, and glutinous, and adheres to the angles of the mouth, fauces and teeth. It is at this period that the thirst is most ardent, and the dog sometimes furiously attempts to detach the saliva with its paws; and if after a while it loses its balance in these attempts and tumbles over, there can no longer be any doubt as to the nature of the malady. There is another symptom connected with the mouth in that form of the disease named "dumb madness" which has frequently proved deceptive. The lower jaw drops in consequence of paralysis of its muscles, and the mouth remains open. The interior is dry from the air passing continually over it, and assumes a deep red tint, somewhat masked by patches of dust or earth, which more especially adhere to the upper surface of the tongue and to the lips. The strange alteration introduced in the dog's physiognomy by its constantly open mouth and the dark colour of the interior is rendered still more characteristic by the dull, sad, or dead expression of the animal's eyes. In this condition the creature is not very dangerous, because generally it could not bite if it tried—indeed there does not appear to be much desire to bite in dumb madness; but the saliva is none the less virulent, and accidental inoculations with it, through imprudent handling, will prove as fatal as in the furious form. The mouth should not be touched, —muzzles being thus having occurred, though people thinking the dog had some foreign substance lodged in its throat, thrust their fingers down to remove it. The sensation of tightness which seems to exist at the throat causes the dog to act as if a bone were fixed between its teeth or towards the back of its mouth, and to employ its fore-paws as if to dislodge it. This is a very deceptive symptom, and may prove equally dangerous if caution be not observed. Vomiting of blood or a chocolate-coloured fluid is witnessed in some cases, and has been supposed to be due to the foreign substances in the stomach, which abrade the lining membrane; this, however, is not correct, as it has been observed many times.

The voice of the rabid dog is very peculiar, and so characteristic that those acquainted with it nothing more is needed to prove the presence of the disease. Those who have heard it once or twice never forget its signification. Owing to the alterations taking place in the larynx the voice becomes hoarse, cracked and stridulous, like that of a child affected with croup—the "voix du coq," as the French have it. A preliminary bark is made in a somewhat elevated tone and with open mouth; this is immediately succeeded by five, six or eight deepening howls, emitted when the animal is standing, and always with the nose elevated, which seem to come from the depths of the throat, the jaws not coming together and closing the mouth during such emission, as in the healthy bark. This alteration in the voice is frequently the first observable indication of the malady, and should at once attract attention. In dumb madness the voice is frequently lost from the very commencement—hence the designation.

The sensibility of the mad dog appears to be considerably diminished, and the animal appears to have lost the faculty of expressing the sensations it experiences; it is mute under the infliction of pain, though there can be no doubt that it still has peripheral sensation to some extent. Burning, beating and wounding produce much less effect than in health, and the animal will even mutilate itself with its teeth. Suspicion, therefore, should always strongly attach to a dog which does not manifest a certain susceptibility to painful impressions and receives punishment without any cry or complaint. There is also reason for apprehension when a dog bites a human being in any part of its body. A rabid dog is usually stirred to fury at the sight of one of its fellows, and this has been referred to by Henrie Marie Bouley (1814–1885) as dissuade doubts as to the existence of the disease when the diagnosis is otherwise uncertain. As soon as the suspected animal, if it is really rabid, finds itself in the presence of another of its species it at once assumes the aggressive, and, if allowed, will bite furiously. All rabid animals indeed become excited, exasperated, and furious at the sight of a dog, and attack it with their natural weapons, even the timid sheep, when rabid huts furiously at the enemy before which its health it would have fled in terror. This inversion of sentiment is sometimes

valuable in diagnosing the malady; it is so common that it may be said to be present in every case of rabies. When, therefore, a dog, contrary to its habits and natural inclination, becomes suddenly aggressive to other dogs, it is time to take precautions.

In the large majority of instances the dog is inoffensive in the early period of the disease to those to whom it is familiar. It then flies from its home and either dies, is killed as "mad," or returns in a miserable plight, and in an advanced stage of the malady, when the desire to bite is irresistible. It is in the early stage that sequestration and suppressive measures are most valuable. The dogs which propagate the disease are usually those that have escaped from their owners. After two or three days, frequently in about twelve hours, more serious and alarming symptoms appear, ferocious instincts are developed, and the desire to do injury is irrepresible. The animal has an indefinable expression of sombre melancholy and cruelty. The eyes have their pupils dilated, and emit flashes of light when they are not dull and heavy; they always appear so fierce as to produce terror in the beholder; they are red, and their sensibility to light is increased; and wrinkles, which sometimes appear on the forehead, add to the repulsive aspect of the animal. If caged it flies at the spectator, emitting its characteristic howl or bark, and seizing the iron bars with its teeth, and if a stick be thrust before it this is grasped and gnawed. This fury is soon succeeded by lassitude, when the animal remains insensible to every excitement. Then all at once it rouses up again, and another paroxysm of fury commences. The first paroxysm is usually the most intense, and the fits vary in duration from some hours to a day, and even longer; they are ordinarily briefer in trained and pet dogs than in those which are less domesticated, but in all the remission is so complete after the last paroxysm that the animal appears to be almost well, if not in perfect health. During the paroxysms respiration is hurried and laboured, but tranquil during the remissions. There is an increase of temperature, and the pulse is quick and hard. When the animal is kept in a dark place and not excited, the fits of fury are not observed. Sometimes it is agitated and restless in the manner already described. It never becomes really furious or aggressive unless excited by external objects—the most potent of these, as has been said, being another dog, which, however, if it be admitted to its cage, it may not at once attack. The attacked animal rarely retaliates, but usually responds to the bites by a cry or yell, which contrast strangely with the anger of the aggressor, and tries to hide its head with its paws or beneath the straw. These repeated paroxysms hurry the course of the disease. The secretion and flowing of a large quantity of saliva from the mouth are usually only witnessed in cases in which swallowing has become impossible, the mouth being generally dry. At times the tongue, nose and whole head appear swollen. Other dogs frequently shun one which is rabid, as if aware of their danger.

The rabid dog, if lodged in a room or kept in a house, is continually endeavouring to escape; and when it makes its escape it goes freely forward, as if impelled by some irresistible force. It travels considerable distances in a short time, perhaps attacking every living creature it meets—preferring dogs, however, to other animals, and these to mankind; cats, sheep, cattle and horses are particularly liable to be injured. It attacks in silence, and never utters a snarl or a cry of anger; should it chance to be hurt in return it emits no cry or howl of pain. The degree of ferocity appears to be related to natural disposition and training. Some dogs, for instance, will only snap or give a slight bite in passing, while others will bite furiously, tearing the objects presented to them, or which they meet in their way, and sometimes with such violence as to injure their mouth and break their teeth, or even their jaws. If chained, they will in some cases gnaw the chain until their teeth are worn away, and the poor wretched animal will not continue its progress very long. Exhausted by fatigue and the paroxysms of madness excited by it by the objects it meets, as well as by hunger, thirst, and also, no doubt, by the malady, its limbs soon become feeble; the rate of travelling is lessened and the walk is unsteady, while its drooping tail, head inclined towards the ground, open mouth, and protruded tongue (of a leaden colour or covered with dust) give the distressed creature a very striking and characteristic physiognomy. In this condition, however, it is no longer capable of danger than in its early fits of fury, since it is so much less capable or desirous of altering its course or going out of its way to attack any animal or man, and its senses are so far from being remarkable that its fast-fading vision, deadened scent, and generally diminished perception prevent its being so readily impressed or excited by surrounding objects as it previously was. To each paroxysm, which is always of short duration, there succeeds a degree of exhaustion as great as the fits have been violent and oft repeated. This compels the animal to stop; then it shelters itself in obscure places—frequently in ditches by the roadside—and lies there in a somnolent state for perhaps hours. There is great danger, nevertheless, in disturbing the dog at this period; for when roused from its torpor it will frequently be so much strengthened to inflict a bite. This period, which may be termed the second stage, is paroxysms in its duration as the first, but it rarely exceeds three or four days. The above-described phenomena gradually merge into those of the third or last period, when symptoms of paralysis appear, which are

speedily followed by death. During the remission in the paroxysms these paralytic symptoms are more particularly manifested in the hind limbs, which appear as if unable to support the animal's weight, and cause it to stagger about; or the lower jaw becomes more or less drooping, leaving the parched mouth partially open. Emaciation rapidly sets in, and the paroxysms diminish in intensity, while the remissions become less marked. The physiognomy assumes a still more sinister and repulsive aspect; the hair is dull and erect; the flanks are retracted; the eyes lose their lustre and are buried in the orbits, the pupil being dilated, and the cornea dull and semi-opaque; very often, even at an early period, the eyes squint, and this adds still more to the terrifying appearance of the poor dog. The voice, if at all heard, is husky, the breathing laborious, and the pulse hurried and irregular. Gradually the paralysis increases, and the posterior extremities are dragged as if the animal's back were broken, until at length it becomes general; it is then the prelude to death. Or the dog remains lying in a state of stupor, and can only raise itself with difficulty on the fore-limbs when greatly excited. In this condition it may yet endeavour to bite at objects within its reach. At times convulsions of a tetanic character appear in certain muscles; at other times these are general. A comatose condition ensues, and the rabid dog, if permitted to die naturally, perishes, in the great majority of cases, from paralysis and asphyxia.

In dumb madness there is paralysis of the lower jaw, which imparts a curious and very characteristic physiognomy to the dog; the voice is also lost, and the animal can neither eat nor drink. In this condition the creature remains with its jaw pendent and the mouth consequently wide open, showing the flaccid or swollen tongue covered with brownish matter, and a stringy gelatinous-looking substance, as well as the lower lip and the coating of the fauces, which sometimes appear to be inflamed. Though the animal is unable to swallow fluids, the desire to drink is nevertheless intense; for the creature will thrust its face into the vessel of water in futile attempts to obtain relief, even until the approach of death. Water may be poured down its throat without inducing a paroxysm. The general physiognomy and demeanour of the poor creature inspire the beholder with pity rather than fear. The symptoms due to cerebral excitement are less marked than in the furious form of the disease; the agitation is not so considerable, and the consciousness, tendency to run away, and desire to bite are nearly absent. Usually the animal will quiver and shiver, and frequently one or both eyes squint, and it is only when very much excited that the dog may contrive to close its mouth. Sometimes there is swelling about the pharynx and the neck; when the tongue shares in this complication it hangs out of the mouth. In certain cases there is a catarrhal condition of the membrane lining the nasal cavities, larynx, and bronchi; sometimes the animal testifies to the existence of abdominal pain, and the faeces are then soft or fluid. The other symptoms—such as the rapid exhaustion and emaciation, paralysis of the posterior limbs towards the termination of the disease, as well as the rapidity with which it runs its course—are the same as in the furious form.

The simultaneous occurrence of furious and dumb madness has frequently been observed in packs of fox-hounds. Dumb madness differs, then, from the furious type in the paralysis of the lower jaw, which hinders the dog from biting, save in very exceptional circumstances; the ferocious instincts are also in abeyance; and there is no tendency to aggression. It has been calculated that from 15 to 20% of rabid dogs have this particular form of the disease. Puppies and young dogs chiefly have furious rabies.

These are the symptoms of rabies in the dog; but it is not likely, nor is it necessary, that they will all be present in every case. In other species the symptoms differ more or less from those manifested by the dog, but they are generally marked by a change in the manner and habits of the creatures affected, with strong indications of nervous disturbance, in the majority of species amounting to ferociousness and a desire to injure, timid creatures becoming bold and aggressive.

*In Human Beings.*—The disease of hydrophobia has been known from early times, and is alluded to in the works of Aristotle, Xenophon, Plutarch, Virgil, Horace, Ovid and many others, as well as in those of the early writers on medicine. Celsus gives detailed instructions respecting the treatment of men who have been bitten by rabid dogs, and dwells on the dangers attending such wounds. After recommending suction of the bitten part by means of a dry cupping glass, and thereafter the application of the actual cautery or of strong caustics, and the employment of baths and various internal remedies, he says: "Idque cum ita per triduum factum est, tutus esse homo a periculo videtur. Solet autem ex eo evulnere, ubi parum occursum est, aquae timor nasci, ὕδροφοβία Graeci appellant. Miserrimum genus morbi; in quo simul aeger et siti et aquae metu cruciatur; quo oppressus in aquam spes est." Subsequently Galen described minutely the phenomena of hydrophobia, and recommended the excision of the wounded part as a protection against

the disease. Throughout many succeeding centuries little or nothing was added to the facts which the early physicians had made known upon the subject. The malady was regarded with universal horror and dread, and the unfortunate sufferers were generally abandoned by all around them and left to their terrible fate. In later times the investigations of Boerhaave, Gerard van Swieten (1700-1772), John Hunter, François Magendie (1783-1855), Gilbert Breschet (1784-1845), Virchow, Albert Reber, as also of William Youatt (1776-1847), George Fleming, Meynell, Karl Hertwig (1798-1881), and others, have furnished important information; but all these were put into the shade by the researches of Pasteur.

The disease is communicated by the secretions of the mouth of the affected animal entering a wound or abrasion of the human skin or mucous membrane. In the great majority of cases (90%) this is due to the bite of a rabid dog, but bites of rabid cats, wolves, foxes, jackals, &c., are occasionally the means of conveying the disease. Numerous popular fallacies still prevail on the subject of hydrophobia. Thus it is supposed that the bite of an angry dog may produce the disease, and all the more if the animal should subsequently develop symptoms of rabies. The ground for this erroneous notion is the fact, which is unquestionable, that animals in whom rabies is in the stage of incubation, during which there are few if any symptoms, may by their bites convey the disease, though fortunately during this early stage they are little disposed to bite. The bite of a non-rabid animal, however enraged, cannot give rise to hydrophobia.

The period of incubation of the disease, or that time which elapses between the introduction of the virus and the development of the symptoms, appears to vary in a remarkable degree, being in some cases as short as a fortnight, and in others as long as several months or even years. On an average it seems to be from about six weeks to three months, but it mainly depends on the part bitten; bites on the head are the most dangerous. The incubation period is also said to be shorter in children. The rare instances of the appearance of hydrophobia many years after the introduction of the poison are always more or less open to question as to subsequent inoculation.

When the disease is about to declare itself it not unfrequently happens that the wound, which had quickly and entirely healed after the bite, begins to exhibit evidence of irritation or inflammatory action, or at least to be the seat of morbid sensations such as numbness, tingling or itching. The symptoms characterizing the premonitory stage are great mental depression and disquietude, together with restlessness and a kind of indefinite fear. There is an unusual tendency to talk, and the articulation is abrupt and rapid. Although in some instances the patients will not acknowledge that they have been previously bitten, and deny it with great obstinacy, yet generally they are well aware of the nature of their malady, and speak despairingly of its consequences. There is in this early stage a certain amount of constitutional disturbance showing itself by feverishness, loss of appetite, sleeplessness, headache, great nervous excitability, respiration of a peculiar sighing or sobbing character, and even occasionally a noticeable aversion to liquids. These symptoms—constituting what is termed the melancholic stage—continue in general for one or two days, when they are succeeded by the stage of excitement in which all the characteristic phenomena of the malady are fully developed. Sometimes the disease first shows itself in this stage, without antecedent symptoms.

The agitation of the sufferer now becomes greatly increased, and the countenance exhibits anxiety and terror. There is noticed a marked embarrassment of the breathing, but the most striking and terrible features of this stage are the effects produced by attempts to swallow fluids. The patient suffers from thirst and desires eagerly to drink, but on making the effort is seized with a most violent suffocative paroxysm produced by spasm of the muscles of swallowing and breathing, which continues for several seconds, and is succeeded by a feeling of intense alarm and distress. With great caution and determination the attempt is renewed, but only to be followed with a repetition of the seizure, until the unhappy sufferer ceases from

sheer dread to try to quench the thirst which torments him. Indeed the very thought of doing so suffices to bring on a choking paroxysm, as does also the sound of the running of water. The patient is extremely sensitive to any kind of external impression; a bright light, a loud noise, a breath of cool air, contact with any one, are all apt to bring on one of these seizures. But besides these suffocative attacks there also occur general convulsions affecting the whole muscular system of the body, and occasionally a condition of tetanic spasm. These various paroxysms increase in frequency and severity with the advance of the disease, but alternate with intervals of comparative quiet, in which, however, there is intense anxiety and more or less constant difficulty of breathing, accompanied with a peculiar sonorous expiration, which has suggested the notion that the patient barks like a dog. In many instances there is great mental disturbance, with fits of maniacal excitement, in which he strikes at every one about him, and accuses them of being the cause of his sufferings—these attacks being succeeded by calm intervals in which he expresses great regret for his violent behaviour. During all this stage of the disease the patient is tormented with a viscid secretion accumulating in his mouth, which from dread of swallowing he is constantly spitting about him. There may also be noticed snapping movements of the jaws as if he were attempting to bite, but these are in reality a manifestation of the spasmodic action which affects the muscles generally. There is no great amount of fever, but there is constipation, diminished flow of urine, and often sexual excitement.

After two or three days of suffering of the most terrible description the patient succumbs, death taking place either in a paroxysm of choking, or on the other hand in a tranquil manner from exhaustion, all the symptoms having abated, and the power of swallowing returned before the end. The duration of the disease from the first declaration of the symptoms is generally from three to five days.

Apart from the inoculation method (see below), the treatment of most avail is that which is directed towards preventing the absorption of the poison into the system. This may be accomplished by excision of the part involved in the bite of the rabid animal, or, where this from its locality is impracticable, in the application to the wound of some chemical agent which will destroy the activity of the virus, such as potassa fusa, lunar caustic (nitrate of silver), or the actual cautery in the form of a red-hot wire. The part should be thoroughly acted on by these agents, no matter what amount of temporary suffering this may occasion. Such applications should be resorted to immediately after the bite has been inflicted, or as soon thereafter as possible. Further, even though many hours or days should elapse, these local remedies should still be applied; for if, as appears probable, some at least of the virus remains for long at the injured part, the removal or effectual destruction of this may prevent the dread consequences of its absorption. Every effort should be made to tranquillize and reassure the patient.

Two special points of interest have arisen in recent years in connexion with this disease. One is the Pasteur treatment by inoculation with rabic virus (see also PARASITIC DISEASES), and the other was the attempt of the government to exterminate rabies in the British Isles by muzzling dogs.

The Pasteur treatment was first applied to human beings in 1885 after prolonged investigation and experimental trial on animals. It is based on the fact that a virus, capable of giving rabies by inoculation, can be extracted from the tissues of a rabid animal and then intensified or attenuated at pleasure. It appears that the strength of the rabic virus, as determined by inoculation, is constant in the same species of animal, but is modified by passing through another species. For instance, the natural virus of dogs is always of the same strength, but when inoculated into monkeys it becomes weakened, and the process of attenuation can be carried on by passing the virus through a succession of monkeys, until it loses the power of causing death. If this weakened virus is then passed back through guinea-pigs, dogs or rabbits, it regains

Pasteur  
treatment.

its former strength. Again, if it be passed through a succession of dogs it becomes intensified up to a maximum of strength which is called the *virus fixe*. Pasteur further discovered that the strength can be modified by temperature and by keeping the dried tissues of a rabid animal containing the virus. Thus, if the spinal cord of a rabid dog be preserved in a dry state, the virus loses strength day by day. The system of treatment consists in making an emulsion of the cord and graduating the strength of the dose by using a succession of cords, which have been kept for a progressively diminishing length of time. Those which have been kept for fourteen days are used as a starting-point, yielding virus of a minimum strength. They are followed by preparations of diminishing age and increasing strength, day by day, up to the maximum, which is three days old. These are successively injected into the circulatory system. The principle is the artificial acquisition by the patient of resistance to the rabic virus, which is presumed to be already in the system but has not yet become active, by accustoming him gradually to its toxic effect, beginning with a weak form and progressively increasing the dose. It is not exactly treatment of the disease, because it is useless or nearly so when the disease has commenced, nor is it exactly preventive, for the patient has already been bitten. It must be regarded as a kind of anticipatory cure. The cords are cut into sections and preserved dry in sterilized flasks plugged with cotton-wool. Another method of preparing the inoculatory virus, which has been devised by Guido Tizzoni and Eugenio Centanni, consists in subjecting the *virus fixe* to peptic digestion by diluted gastric juice for varying periods of time.

The first patient was treated by Pasteur's system in July 1885. He was successively inoculated with emulsions made from cords that had been kept fourteen and ten days, then eleven and eight days, then eight, seven, six days, and so on. Two forms of treatment are now used—(1) the "simple," in which the course from weak to strong virus is extended over nine days; (2) the "intensive," in which the maximum is reached in seven days. The latter is used in cases of very bad bites and those of some standing, in which it is desirable to lose no time. Two days are compressed into one at the commencement by making injections morning and evening instead of once a day, so that the fifth-day cord is reached in four days instead of six, as in the "simple" treatment. When the maximum—the third-day cord—is reached the injections are continued with fifth-, fourth-, and third-day cords. The whole course is fifteen days in the simple treatment and twenty-one in the intensive. The doses injected range from 1 to 3 cubic centimetres. Injections are made alternately into the right and left flanks. The following table shows the number treated from 1886 to 1905, with the mortality.

Year.	Patients Treated.	Deaths.	Mortality per cent.
1886	2671	25	.94
1887	1770	14	.79
1888	1622	9	.55
1889	1830	7	.38
1890	1540	5	.32
1891	1559	4	.25
1892	1790	4	.22
1893	1648	6	.36
1894	1387	7	.50
1895	1520	5	.33
1896	1308	4	.30
1897	1521	6	.39
1898	1465	3	.20
1899	1614	4	.25
1900	1419	10	.70
1901	1318	5	.37
1902	1105	2	.18
1903	630	4	.65
1904	757	5	.66
1905	727	4	.54

pleted, for it is held that persons who die within that period have their nervous centres invaded by virus before the cure has time to act. The true mortality should therefore be considerably higher. For instance, in 1808 three deaths came within this category, which just doubles the mortality; and in 1899 the additional deaths were six, bringing the mortality up to two-and-a-half times that indicated in the table. When, however, the additional deaths are included the results remain sufficiently striking, if two assumptions are granted—(1) that all the persons treated have been bitten by rabid animals; (2) that a large proportion of persons so bitten usually have hydrophobia. Unfortunately, both these assumptions lack proof, and therefore the evidence of the efficacy of the treatment cannot be said to satisfy a strictly scientific standard. With regard to the first point, the patients are divided into three categories—(1) those bitten by an animal the rabidity of which is proved by the development of rabies in other animals bitten by it or inoculated from its spinal cord; (2) those bitten by an animal pronounced rabid on a veterinary examination; (3) those bitten by an animal suspected of being rabid. The number of patients in each category in 1898 was (1) 141, (2) 855, (3) 469; and in 1899 it was (1) 152, (2) 1099, (3) 363. As might be expected, the vast majority came under the second and third heads, in which the evidence of rabidity is doubtful or altogether lacking. With regard to the second point, the proportion of persons bitten by rabid animals who ordinarily develop hydrophobia has only been "estimated" from very inadequate data. Otto Bollinger from a series of collected statistics states that before the introduction of the Pasteur treatment, of patients bitten by dogs undoubtedly rabid 47% died, the rate being 33% in those whose wounds had been cauterized and 83% when there had been no local treatment. If the number of rabid dogs be compared with the deaths from hydrophobia in any year or series of years, it can hardly be very high. For instance, in 1895, 668 dogs, besides other animals, were killed and certified to be rabid in England, and the deaths from hydrophobia were twenty. Of course this proves nothing, as the number of persons bitten is not known, but the difference between the amount of rabies and of hydrophobia is suggestively great in view of the marked propensity of rabid dogs to bite, nor is it accounted for by the fact that some of the persons bitten were treated at the Institut Pasteur. A comparison of the annual mortality from hydrophobia in France before and after the introduction of the treatment would afford decisive evidence as to its efficacy; but unfortunately no such comparison can be made for lack of vital statistics in that country. The experience of the Paris hospitals, however, points to a decided diminution of mortality. On the whole it must be said, in the absence of further data, that the Pasteur treatment certainly diminishes the danger of hydrophobia from the bites of rabid animals.

More recently treatment with an anti-rabic serum has been suggested (see PARASITIC DISEASES). Victor Babes and Lepp and later Guido Tizzoni and Eugenio Centanni have worked out a method of serum treatment curative and protective. In this method not the rabic poison itself, as in the Pasteur treatment, but the protective substance formed is injected into the tissues. The serum of a vaccinated animal is capable of neutralizing the power of the virus of rabies not only when mixed with the virus before injection but even when injected simultaneously or within twenty-four hours after the introduction of the virus. These authors showed that the serum of a rabbit protects a rabbit better than does the serum of a dog, and vice versa. At the end of twenty days' injections they found they could obtain such a large quantity of anti-rabic substance in the serum of an animal, that even 1 part of serum to 25,000 of the body weight would protect an animal. This process differs from that of Pasteur in so far as that in place of promoting the formation of the antidote within the body of the patient, by a process of vaccination with progressively stronger and stronger virus, this part of the process is carried on in an animal, Babes using the dog and Centanni the sheep, the blood serum of which is injected. This method of vaccination is useful as a protective to those in charge of kennels.

These figures do not include cases which develop hydrophobia during treatment or within fifteen days after treatment is com-

The attempt to stamp out rabies in Great Britain was an experiment undertaken by the government in the public interest.

The principal means adopted were the muzzling of dogs in infected areas, and prolonged quarantine for imported animals. The efficacy of dog-muzzling in checking the spread of rabies and diminishing its prevalence has been repeatedly proved in various countries. Liable as other animals may be to the disease, in England at least the dog is pre-eminently the vehicle of contagion and the great source of danger to human beings. There is a difference of opinion on the way in which muzzling acts, though there can be none as to the effect it produces in reducing rabies. Probably it acts rather by securing the destruction of ownerless and stray—which generally includes rabid—dogs than by preventing biting; for though it may prevent snapping, even the wire-cage muzzle does not prevent furious dogs from biting, and it is healthy, not rabid, dogs that wear the muzzle. It has therefore been suggested that a collar would have the same effect, if all collarless dogs were seized; but the evidence goes to show that it has not, perhaps because rabid dogs are more likely to stray from home with their collars, which are constantly worn, than with muzzles which are not, and so escape seizure. Moreover, it is much easier for the police to see whether a dog is wearing a muzzle or not than it is to make sure about the collar. However this may be, the muzzle has proved more efficacious, but it was not applied systematically in England until a late date. Sometimes the regulations were in the hands of the government, and sometimes they were left to local authorities; in either case they were allowed to lapse as soon as rabies had died down. In April 1897 the Board of Agriculture entered on a systematic attempt to exterminate rabies by the means indicated. The plan was to enforce muzzling over large areas in which the disease existed, and to maintain it for six months after the occurrence of the last case. In spite of much opposition and criticism, this was resolutely carried out under Mr Walter Long, the responsible minister, and met with great success. By the spring of 1899—that is, in two years—the disease had disappeared in Great Britain, except for one area in Wales; and, with this exception, muzzling was everywhere relaxed in October 1899. It was taken off in Wales also in the following May, no case having occurred since November 1899. Rabies was then pronounced extinct. During the summer of 1900, however, it reappeared in Wales, and several counties were again placed under the order. The year 1901 was the third in succession in which no death from hydrophobia was registered in the United Kingdom. In the ten years preceding 1899, 104 deaths were registered, the death-rate reaching 30 in 1880 and averaging 29 annually. In 1902 two deaths from hydrophobia were registered. From that date to June 1909 (the latest available for the purpose of this article) no death from hydrophobia was notified in the United Kingdom.

See *Annales de l'Institut Pasteur*, from 1886; *Journal of the Board of Agriculture*, 1899; Makins, "Hydrophobia," in Treves's *System of Surgery*; Woodhead, "Rabies," in Allbutt's *System of Medicine*.

**HYDROSPHERE** (Gr. *ὕδωρ*, water, and *σφαῖρα*, sphere), in physical geography, a name given to the whole mass of the water of the oceans, which fills the depressions in the earth's crust, and covers nearly three-quarters of its surface. The name is used in distinction from the atmosphere, the earth's envelope of air, the lithosphere (Gr. *λίθος*, rock) or solid crust of the earth, and the centrosphere or interior mass within the crust. To these "spheres" some writers add, by figurative usage, the terms "biosphere," or life-sphere, to cover all living things, both animals and plants, and "psychosphere," or mind-sphere, covering all the products of human intelligence.

**HYDROSTATICS** (Gr. *ὕδωρ*, water, and the root *στα-*, to cause to stand), the branch of hydromechanics which discusses the equilibrium of fluids (see **HYDROMECHANICS**).

**HYDROXYLAMINE**,  $\text{NH}_2\text{OH}$ , or hydroxy-ammonia, a compound prepared in 1865 by W. C. Lossen by the reduction of ethyl nitrate with tin and hydrochloric acid. In 1870 E. Ludwig and T. H. Hein (*Chem. Centralblatt*, 1870, 1, p. 340) obtained it by passing nitric oxide through a series of bottles containing tin

and hydrochloric acid, to which a small quantity of platinum tetrachloride has been added; the acid liquid is poured off when the operation is completed, and sulphuretted hydrogen is passed in; the tin sulphide is filtered off and the filtrate evaporated. The residue is extracted by absolute alcohol, which dissolves the hydroxylamine hydrochloride and a little ammonium chloride; this last substance is removed as ammonium platinochloride, and the residual hydroxylamine hydrochloride is recrystallized. E. Divers obtains it by mixing cold saturated solutions containing one molecular proportion of sodium nitrate, and two molecular proportions of acid sodium sulphite, and then adding a saturated solution of potassium chloride to the mixture. After standing for twenty-four hours, hydroxylamine potassium disulphonate crystallizes out. This is boiled for some hours with water and the solution cooled, when potassium sulphate separates first, and then hydroxylamine sulphate. E. Tafel (*Zeit. anorg. Chem.*, 1902, 31, p. 289) patented an electrolytic process, wherein 50% sulphuric acid is treated in a divided cell provided with a cathode of amalgamated lead, 50% nitric acid being gradually run into the cathode compartment. Pure anhydrous hydroxylamine has been obtained by C. A. Lobry de Bruyn from the hydrochloride, by dissolving it in absolute methyl alcohol and then adding sodium methylate. The precipitated sodium chloride is filtered, and the solution of hydroxylamine distilled in order to remove methyl alcohol, and finally fractionated under reduced pressure. The free base is a colourless, odourless, crystalline solid, melting at about 30° C., and boiling at 58° C. (under a pressure of 22 mm.). It deliquesces and oxidizes on exposure, inflames in dry chlorine and is reduced to ammonia by zinc dust. Its aqueous solution is strongly alkaline, and with acids it forms well-defined stable salts. E. Ebler and E. Schott (*J. pr. Chem.*, 1908, 78, p. 289) regard it as acting with the formula  $\text{NH}_2\text{-OH}$  towards bases, and as  $\text{NH}_2\text{O}$  towards acids, the salts in the latter case being of the oxonium type. It is a strong reducing agent, giving a precipitate of cuprous oxide from alkaline copper solutions at ordinary temperature, converting mercuric chloride to mercurous chloride, and precipitating metallic silver from solutions of silver salts. With aldehydes and ketones it forms oximes (q.v.). W. R. Dunstan (*Jour. Chem. Soc.*, 1899, 75, p. 792) found that the addition of methyl iodide to a methyl alcohol solution of hydroxylamine resulted in the formation of trimethylamine,  $\text{N}(\text{CH}_3)_3\text{O}$ .

Many substituted hydroxylamines are known, substitution taking place either in the  $\alpha$  or  $\beta$  position ( $\text{NH}_2\text{-OH}^\alpha$ ).  $\beta$ -phenylhydroxylamine,  $\text{C}_6\text{H}_5\text{NH}_2\text{OH}$ , is obtained in the reduction of nitrobenzene in neutral solution (e.g. by the action of the aluminium-mercury couple and water), but better, according to C. Goldschmidt (*Ber.*, 1896, 29, p. 2307) by dissolving nitrobenzene in ten times its weight of ether containing a few cubic centimetres of water, and heating with excess of zinc dust and anhydrous calcium chloride for three hours on a water bath. It also appears as an intermediate product in the electrolytic reduction of nitrobenzene in sulphuric acid solution. By gentle oxidation it yields nitrosobenzene. Derivatives of the type  $\text{R}_2\text{N-OH}$  result in the action of the Grignard reagent on amyl nitrite. Dihydroxy-ammonia or nitrotyl,  $\text{NH}(\text{OH})_2$ , a very unstable and highly reactive substance, has been especially studied by A. Angeli (see A. W. Stewart, *Recent Advances in Physical and Inorganic Chemistry*, 1909).

**HYDROZOA**, one of the most widely spread and prolific groups of aquatic animals. They are for the most part marine in habitat, but a familiar fresh-water form is the common *Hydra* of ponds and ditches, which gives origin to the name of the class. The Hydrozoa comprise the hydroids, so abundant on all shores, most of which resemble vegetable organisms to the unassisted eye; the hydrocorallines, which, as their name implies, have a massive stony skeleton and resemble corals; the jelly-fishes so called; and the Siphonophora, of which the species best known by repute is the so-called "Portuguese man-of-war" (*Physalia*), dreaded by sailors on account of its terrible stinging powers.

In external form and appearance the Hydrozoa exhibit such striking differences that there would seem at first sight to be little in common between the more divergent members of the group. Nevertheless there is no other class in the animal kingdom with better marked characteristics, or with more uniform

morphological peculiarities underlying the utmost diversity of superficial characters.

All Hydrozoa, in the first place, exhibit the three structural features distinctive of the Coelentera (*q.v.*) (1) The body is built up of two layers only, an external protective and sensory layer, the ectoderm, and an internal digestive layer, the endoderm. (2) The body contains but a single internal cavity, the coelenteron or gastrovascular space, which may be greatly ramified, but is not shut off into cavities distinct from the central digestive space. (3) The generative cells are produced in either the ectoderm or endoderm, and not in a third layer arising in the embryo, distinct from the two primary layers; in other words, there is no mesoderm or coelom.

To these three characters the Hydrozoa add a fourth which is distinctive of the subdivision of the Coelenterata termed the Cnidaria; that is to say, they always possess peculiar stinging organs known as nettle-cells, or *cnematocysts* (*Cnidæ*), each produced in a cell forming an integral part of the animal's tissues. The Hydrozoa are thus shown to belong to the group of Coelenterata Cnidaria, and it remains to consider more fully their distinctive features, and in particular those which mark them off from the other main division of the Cnidaria, the Anthozoa (*q.v.*), comprising the corals and sea-anemones.

The great diversity, to which reference has already been made, in the form and structure of the Hydrozoa is due to two principal causes. In the first place, we find in this group two distinct types of person or individual, the polyp and the medusa (*q.v.*), each capable of a wide range of variations; and when both polyp and medusa occur in the life-cycle of the same species, as is frequently the case, the result is an alternation of generations of a type peculiarly characteristic of the class. In the second place, the power of non-sexual reproduction by budding is practically of universal occurrence among the Hydrozoa, and by the buds failing to separate from the parent stock, colonies are produced, more or less complicated in structure and often of great size. We find that polyps may either bud other polyps or may produce medusae, and that medusae may bud medusae, though never, apparently, polyps. Hence we have a primary subdivision of the colonies of Hydrozoa into those produced by budding of polyps and those produced by budding of medusae. The former may contain polyp-persons and medusa-persons, either one kind alone or both kinds combined; the latter will contain only medusa-persons variously modified.

The morphology of the Hydrozoa reduces itself, therefore, to a consideration of the morphology of the polyp, of the medusa and of the colony. Putting aside the last-named, for a detailed account of which see HYDROMEDUSAE, we can best deal with the peculiarities of the polyp and medusa from a developmental point of view.

In the development of the Hydrozoa, and indeed of the Cnidaria generally, the egg usually gives rise to an oval larva which swims about by means of a coating of cilia on the surface of the body. This very characteristic larva is termed a *planula*, but though very uniform externally, the planulae of different species, or of the same species at different periods, do not always represent the same stage of embryonic development internally. On examining more minutely the course of the development, it is found that the ovum goes through the usual process of cleavage, always total and regular in this group, and so gives rise to a hollow sphere or ovoid with the wall composed of a single layer of cells, and containing a spacious cavity, the blastocoel or segmentation-cavity. This is the *blastula* stage occurring universally in all Metazoa, probably representing an ancestral Protozoan colony in phylogeny. Next the blastula gives rise to an internal mass of cells (fig. 1, *hy*) which come from the wall either by immigration (fig. 1, *A*) or by splitting off (delamination). The formation of an inner cell-mass converts the single-layered blastula (monoblastula) into a double-layered embryo (diblastula) which may be termed a parenchymula, since at first the inner cell-mass forms an irregular parenchyma which may entirely fill up and obliterate the segmentation cavity (fig. 1, *B*). At a later stage, however, the cells of the inner mass arrange themselves in a definite layer surrounding an internal cavity (fig. 1, *C*, *al*), which soon acquires an opening to the exterior at one pole, and so forms the characteristic embryonic stage of all Enterozoa known as the *gastrula* (fig. 2). In this stage the body is composed of two layers, ectoderm (*d*) external, and endoderm (*c*) internally, surrounding a central cavity, the *archenteron* (*b*), which communicates with the exterior by a pore (*a*), the *blastopore*.

Thus a planula larva may be a blastula, or but slightly advanced beyond this stage, or it may be (and most usually is) a parenchymula; or in some cases (Scyphomedusae) it may be a gastrula. It should be added that the process of development, the gastrulation as it is termed, may be shortened by the immigration of cells taking place

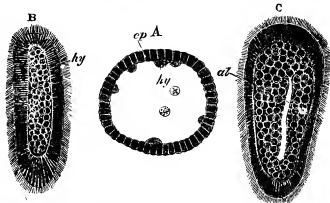

From Balfour, after Kowalewsky.

FIG. 1.—Formation of the Diblastula of *Entope* (one of the Calyptoblastic *Hydromedusae*) by immigration. A, B, C, three successive stages. *ep*, Ectoderm; *hy*, endoderm; *al*, enteric cavity.

at one pole only, and in a connected layer with orderly arrangement, so that the gastrula stage is reached at once from the blastula without any intervening parenchymula stage. This is a process of gastrulation by invagination which is found in all animals above the Coelenterata, but which is very rare in the Cnidaria, and is known only in the Scyphomedusae amongst the Hydrozoa.

After the gastrula stage, which is found as a developmental stage in all Enterozoa, the embryo of the Hydrozoa proceeds to develop characters which are peculiar to the Coelenterata only. Round the blastopore hollow outgrowths, variable in number, arise by the evagination of the entire body-wall, both ectoderm and endoderm. Each outgrowth contains a prolongation of the archenteric cavity (compare figs. 2 and 3, *A*). In this way is formed a ring of tentacles, the most characteristic organs of the Cnidaria. They surround a region which is termed the peristome, and which contains in the centre the blastopore, which becomes the adult mouth. The archenteron becomes the gastrovascular system or coelenteron. Between the ectoderm and endoderm a gelatinous supporting layer, termed the mesoglea, makes its appearance.

The gastrula has now become an *actinula*, which may be termed the distinctive larva of the Cnidaria, and doubtless represents in a transitory manner the common ancestor of the group. In no case known, however, does the actinula become the adult, sexually mature individual, but always undergoes further modifications, whereby it develops into either a polyp or a medusa. To become a polyp, the actinula (fig. 3, *A*) becomes attached to some firm object by the pole farthest from the mouth, and its growth preponderates in the direction of the principal axis, that is to say, the axis passing through the mouth (fig. 3, *a-b*). As a result the body becomes columnar in form (fig. 3, *B*), and without further change passes into the characteristic polyp-form (see POLYPS).

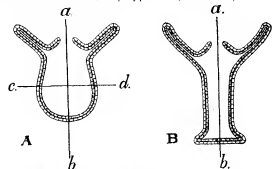

FIG. 3.—Diagram showing the change of the Actinula (*A*) into a Polyp (*B*); *a-b*, principal (vertical) axis; *c-d*, horizontal axis. The endoderm is shaded, the ectoderm is left clear.

It is convenient to distinguish two types of polyp by the names hydro polyp and anthopolyp, characteristic of the Hydrozoa and

From Gegenbaur's *Elements of Comparative Anatomy*.

FIG. 2.—Diagram of a Diblastula.

*a*, Blastopore.  
*b*, Archenteric cavity.  
*c*, Endoderm.  
*d*, Ectoderm.



Anthozoa respectively. In the hydropolyp the body is typically elongated, the height of the column being far greater than the diameter. The peristome is relatively small and the mouth is generally raised on a projecting spout or *hypostome*. The ectoderm loses entirely the ciliation which it had in the planula and actinula stages and commonly secretes on its external surface a protective or supporting investment, the perisarc. Contrasting with this, the anthopolyp is generally of squat form, the diameter often exceeding the height; the peristome is wide, a hypostome is lacking, and the ectoderm, or so much of it as is exposed, i.e. not covered by secretion of skeletal or other investment, retains its ciliation throughout life. The internal structural differences are even more characteristic. In the hydropolyp the blastopore of the embryo forms the adult mouth situated at the extremity of the hypostome, and the ectoderm and

simple type of organization than the anthopolyp, and is in most respects less modified from the actinula type of structure.

Returning now to the actinula, this form may, as already stated, develop into a medusa, a type of individual found only in the Hydrozoa, as here understood. To become a medusa, the actinula grows scarcely at all in the direction of the principal axis, but greatly along a plane at right angles to it. Thus the body becomes umbrella-shaped, the concave side representing the peristome, and the convex side the column, of the polyp. Hence the tentacles are found at the edge of the umbrella, and the hypostome forms usually a projecting tube, with the mouth at the extremity, forming the *manubrium* or handle of the umbrella. The medusa has a pronounced radial symmetry, and the positions of the primary tentacles, usually four in number, mark out the so-called *radii*, alternating with which are four *interradii*. The ectoderm retains its ciliation only in the sensory organs. The mesogloea becomes enormously increased in quantity (hence the popular name "jelly-fish"), and in correlation with this the endoderm-layer lining the coelenteron becomes pressed together in the interradial areas and undergoes concrescence, forming a more or less complicated gastrovascular system (see MEDUSA). It is sufficient to state here that the medusa is usually a free-swimming animal, floating mouth downwards on the open seas, but in some cases it may be attached by its aboral pole, like a polyp, to some firm base, either temporarily or permanently.

Thus the development of the two types of individual seen in the Hydrozoa may be summarized as follows:—

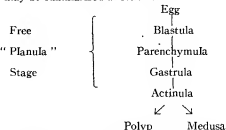

This development, though probably representing the primitive sequence of events, is never actually found in its full extent, but is always abbreviated by omission or elimination of one or more of the stages. We have already seen that the parenchymula stage is passed over when the gastrulation is of the invaginate type. On the other hand, the parenchymula may develop directly into the actinula or even into the polyp, with suppression of the intervening steps. Great apparent differences may also be brought about by variations in the period at which the embryo is set free as a larva, and since two free-swimming stages, planula and actinula, are unnecessary, one or other of them is always suppressed. A good example of this is seen in two common genera of British hydrozoids, *Cordylophora* and *Tabularia*. In *Cordylophora* the embryo is set free at the parenchymula stage as a planula which fixes itself and develops into a polyp, both gastrula and actinula stages being suppressed. In *Tabularia*, on the other hand, the parenchymula develops into an actinula within the maternal tissues, and is then set free, creeps about for a time, and after fixing itself, changes into a polyp; hence in this case the planula-stage, as a free larva, is entirely suppressed.

The Hydrozoa may be defined, therefore, as Cnidaria in which two types of individual, the polyp and the medusa, may be present, each type developed along divergent lines from the primitive actinula form. The polyp (hydropolyp) is of simple structure and never has an ectodermal oesophagus or mesenteries.<sup>1</sup> The general ectoderm loses its cilia, which persist only in the sensory cells, and it frequently secretes external protective or supporting structures. An internal mesogloea skeleton is not found.

The class is divisible into two main divisions or sub-classes, Hydro-medusae and Scyphomedusae, of which definitions and detailed systematic accounts will be found under these headings.

GENERAL WORKS ON HYDROZOA.—C. Chun, "Coelenterata (Hohlthiere)," *Bronn's Klassen und Ordnungen des Thier-Reichs* ii. 2 (1889 et seq.); Y. Delage, and E. Hérouard, *Traité de zoologie concrète*, ii. part 2, *Les Coelentérés* (1901); G. H. Fowler, "The Hydromedusae and Scyphomedusae" in E. R. Lankester's *Treatise on Zoology*, ii. chapters iv. and v. (1900); S. J. Hixson, "Coelenterata and Ttenophora," *Cambridge Natural History*, i. chapters x.-xv. (1906). (E. A. M.)

FIG. 4.—Diagram showing the change of the Actinula into a Medusa. A, Vertical section of the actinula; *a-b* and *c-d* as in fig. 3, B, transitional stage, showing preponderating growth in the horizontal plane. C, C', D, D', two types of medusa organization; C and D are composite sections, showing a radius (R) on one side, an interradial (IR) on the other; C' and D' are plans; the mouth and manubrium are indicated at the centre, leading into the gastric cavity subdivided by the four areas of concrescence in each interradial (IR). *t*, *g.p.*, gastric pouch; *r.c.*, radial canal; *cc*, endoderm-present in C and C'; *c.p.*, circular or ring-canal; *el.*, endoderm-lamina formed by concrescence. For a more detailed diagram of medusa-structure see article MEDUSA.

endoderm meet at this point. In the anthopolyp the blastopore is carried inwards by an in-pushing of the body-wall of the region of the peristome, so that the adult mouth is an opening leading into a short ectodermal oesophagus or stomodaeum, at the bottom of which is the blastopore. Further, in the hydropolyp the digestive cavity either remains simple and undivided and circular in transverse section, or may show ridges projecting internally, which in this case are formed of endoderm alone, without any participation of the mesogloea. In the anthopolyp, on the other hand, the digestive cavity is always subdivided by so-called mesenteries, in-growths of the endoderm containing vertical lamellae of mesogloea (see ANTHOZOA). In short, the hydropolyp is characterized by a more

HYENA, a name applicable to all the representatives of the mammalian family *Hyaenidae*, a group of Carnivora (*g.s.*) allied to the civets. From all other large Carnivora except the African hunting-dog, hyenas are distinguished by having only four toes on each foot, and are further characterized by the length of the fore-legs as compared with the hind pair, the non-retractile claws, and the enormous strength of the jaws and teeth, which enables them to break the hardest bones and to retain what they have seized with unrelaxing grip.

<sup>1</sup> See further under SCYPHOMEDUSAE.

The striped hyena (*Hyaena striata*) is the most widely distributed species, being found throughout India, Persia, Asia Minor, and North and East Africa, the East African form constituting a distinct race, *H. striata schillingsi*; while there are also several distinct Asiatic races. The species resembles a wolf in size, and is greyish-brown in colour, marked with indistinct longitudinal stripes of a darker hue, while the legs are transversely striped. The hairs on the body are long, especially on the ridge of the neck and back, where they form a distinct mane, which is continued along the tail. Nocturnal in habits,

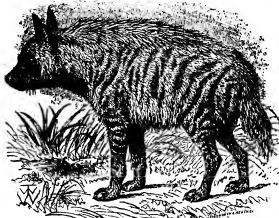

FIG. 1.—The Striped Hyena (*Hyaena striata*).

it prefers by day the gloom of caves and ruins, or of the burrows which it occasionally forms, and issues forth at sunset, when it commences its unearthly howling. When the animal is excited, the howl changes into what has been compared to demoniac laughter, whence the name of "laughing-hyena." These creatures feed chiefly on carrion, and thus perform useful service by devouring remains which might otherwise pollute the air. Even human dead are not safe from their attacks, their powerful claws enabling them to gain access to newly interred bodies in cemeteries. Occasionally (writes Dr W. T. Blanford) sheep or

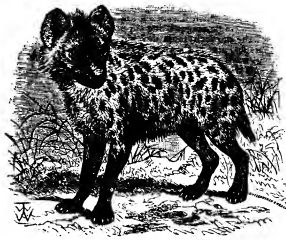

FIG. 2.—The Spotted Hyena (*Hyaena crocuta*).

goats, and more often dogs, are carried off, and the latter, at all events, are often taken alive to the animal's den. This species appears to be solitary in habits, and it is rare to meet with more than two together. The cowardice of this hyena is proverbial; despite its powerful teeth, it rarely attempts to defend itself. A very different animal is the spotted hyena, *Hyaena (Crocuta) crocuta*, which has the sectorial teeth of a more cat-like type, and is marked by dark-brown spots on a yellowish ground, while the mane is much less distinct. At the Cape it was formerly common, and occasionally committed great havoc among the cattle, while it did not hesitate to enter the Kafir dwellings at

night and carry off children sleeping by their mothers. By persistent trapping and shooting, its numbers have now been considerably reduced, with the result, however, of making it exceedingly wary, so that it is not readily caught in any trap with which it has had an opportunity of becoming acquainted. Its range extends from Abyssinia to the Cape. The Abyssinian form has been regarded as a distinct species, under the name of *H. lionievici*, but this, like various more southern forms, is but regarded as a local race. The brown hyena (*H. brunnea*) is South African, ranging to Angola on the west and Kilimanjaro on the east. In size it resembles the striped hyena, but differs in appearance, owing to the fringe of long hair covering the neck and forepart of the back. The general hue is ashy-brown, with the hair lighter on the neck (forming a collar), chest and belly; while the legs are banded with dark brown. This species is not often seen, as it remains concealed during the day. Those frequenting the coast feed on dead fish, crabs and an occasional stranded whale, though they are also a danger to the sheep and cattle kraal. Strand-wolf is the local name at the Cape.

Although hyenas are now confined to the warmer regions of the Old World, fossil remains show that they had a more northerly range during Tertiary times; the European cave-hyena being a form of the spotted species, known as *H. crocuta spelæa*. Fossil hyenas occur in the Lower Pliocene of Greece, China, India, &c.; while remains indistinguishable from those of the striped species have been found in the Upper Pliocene of England and Italy.

**HYÈRES**, a town in the department of the Var in S.E. France, 11 m. by rail E. of Toulon. In 1906 the population of the commune was 17,790, of the town 10,464; the population of the former was more than doubled in the last decade of the 19th century. Hyères is celebrated (as is also its fashionable suburb, Costebelle, nearer the seashore) as a winter health resort. The town proper is situated about 2½ m. from the seashore, and on the south-western slope of a steep hill (669 ft., belonging to the Maurettes chain, 961 ft.), which is one of the westernmost spurs of the thickly wooded Montagnes des Maures. It is sheltered from the north-east and east winds, but is exposed to the cold north-west wind or *mistral*. Towards the south and south-east a fertile plain, once famous for its orange groves, but now mainly covered by vineyards and farms, stretches to the sea, while to the south-west, across a narrow valley, rises a cluster of low hills, on which is the suburb of Costebelle. The older portion of the town is still surrounded, on the north and east, by its ancient, though dilapidated medieval walls, and is a labyrinth of steep and dirty streets. The more modern quarter which has grown up at the southern foot of the hill has handsome broad boulevards and villas, many of them with beautiful gardens, filled with semi-tropical plants. Among the objects of interest in the old town are: the house (Rue Rabaton, 7) where J. B. Massillon (1663-1742), the famous pulpit orator, was born; the parish church of St Louis, built originally in the 13th century by the Cordelier or Franciscan friars, but completely restored in the earlier part of the 19th century; and the site of the old château, on the summit of the hill, now occupied by a villa. The plain between the new town and the sea is occupied by large nurseries, an excellent *jardin d'acclimatation*, and many market gardens, which supply Paris and London with early fruits and vegetables, especially artichokes, as well as with roses in winter. There are extensive salt beds (*salines*) both on the peninsula of Giens, S. of the town, and also E. of the town. To the east of the Giens peninsula is the fine natural harbour of Hyères, as well as three thinly populated islands (the Stochades of the ancients), Porquerolles, Port Cros and Le Levant, which are grouped together under the common name of Iles d'Hyères.

The town of Hyères seems to have been founded in the 10th century, as a place of defence against pirates, and takes its name from the *aires* (*hierbo* in the Provençal dialect), or threshing-floors for corn, which then occupied its site. It passed from the possession of the viscounts of Marseilles to Charles of Anjou, count of Provence, and brother of St Louis (the latter landed here in 1254, on his return from Egypt). The château was

dismantled by Henri IV., but thanks to its walls, the town resisted in 1707 an attack made by the duke of Savoy.

See Ch. Lenthéric, *La Provence Maritime ancienne et moderne* (chap. 5) (Paris, 1880). (W. A. B. C.)

**HYGIEIA**, in Greek mythology, the goddess of health. It seems probable that she was originally an abstraction, subsequently personified, rather than an independent divinity of very ancient date. The question of the original home of her worship has been much discussed. The oldest traces of it, so far as is known at present, are to be found at Titane in the territory of Sicyon, where she was worshipped together with Asclepius, to whom she appears completely assimilated, not an independent personality. Her cult was not introduced at Epidaurus till a late date, and therefore, when in 420 B.C. the worship of Asclepius was introduced at Athens coupled with that of Hygieia, it is not to be inferred that she accompanied him from Epidaurus, or that she is a Peloponnesian importation at all. It is most probable that she was invented at the time of the introduction of Asclepius, after the sufferings caused by the plague had directed special attention to sanitary matters. The already existing worship of Athena Hygieia had nothing to do with Hygieia the goddess of health, but merely denoted the recognition of the power of healing as one of the attributes of Athena, which gradually became crystallized into a concrete personality. At first no special relationship existed between Asclepius and Hygieia, but gradually she came to be regarded as his daughter, the place of his wife being already secured by Epione. Later Orphic hymns, however, and Herodas iv. 1-9, make her the wife of Asclepius. The cult of Hygieia then spread concurrently with that of Asclepius, and was introduced at Rome from Epidaurus in 293, by which time she may have been admitted (which was not the case before) into the Epidaurian family of the god. Her proper name as a Romanized Greek importation was Valetudo, but she was gradually identified with Salus, an older genuine Italian divinity, to whom a temple had already been erected in 302. While in classical times Asclepius and Hygieia are simply the god and goddess of health, in the declining years of paganism they are protecting divinities generally, who preserve mankind not only from sickness but from all dangers on land and sea. In works of art Hygieia is represented, together with Asclepius, as a maiden of benevolent appearance, wearing the chiton and giving food or drink to a serpent out of a dish.

See the article by H. Lechat in Daremberg and Saglio's *Dictionnaire des antiquités*, with full references to authorities; and E. Thraemer in Roscher's *Lexikon der Mythologie*, with a special section on the modern theories of Hygieia.

**HYGIENE** (Fr. *hygiène*, from Gr. *ὑγιεινός*, to be healthy), the science of preserving health, its practical aim being to render "growth more perfect, decay less rapid, life more vigorous, death more remote." The subject is thus a very wide one, embracing all the agencies which affect the physical and mental well-being of man, and it requires acquaintance with such diverse sciences as physics, chemistry, geology, engineering, architecture, meteorology, epidemiology, bacteriology and statistics. On the personal or individual side it involves consideration of the character and quality of food and of water and other beverages; of clothing; of work, exercise and sleep; of personal cleanliness, of special habits, such as the use of tobacco, narcotics, &c.; and of control of sexual and other passions. In its more general and public aspects it must take cognizance of meteorological conditions, roughly included under the term climate; of the site or soil on which dwellings are placed; of the character, materials and arrangement of dwellings, whether regarded individually or in relation to other houses among which they stand; of their heating and ventilation; of the removal of excreta and other effete matters; of medical knowledge relating to the incidence and prevention of disease; and of the disposal of the dead.

These topics will be found treated in such articles as DIETETICS, FOOD, FOOD-PRESERVATION, ADULTERATION, WATER, HEATING, VENTILATION, SEWERAGE, BACTERIOLOGY, HOUSING, CREMATION, &c. For legal enactments which concern the sanitary well-being of the community, see PUBLIC HEALTH.

**HYGINUS**, eighth pope. It was during his pontificate (c. 137-140) that the gnostic heresies began to manifest themselves at Rome.

**HYGINUS** (surnamed GROMATICUS, from *gruma*, a surveyor's measuring-rod), Latin writer on land-surveying, flourished in the reign of Trajan (A.D. 98-117). Fragments of a work on legal boundaries attributed to him will be found in C. F. Lachmann, *Gromatici Veteres*, i. (1848).

A treatise on Castrametation (*De Munitionibus Castrorum*), also attributed to him, is probably of later date, about the 3rd century A.D. (ed. W. Gemoll, 1879; A. von Domaszewski, 1887).

**HYGINUS, GAIVS JULIVS**, Latin author, a native of Spain (or Alexandria), was a pupil of the famous Cornelius Alexander Polyhistor and a freedman of Augustus, by whom he was made superintendent of the Palatine library (Suetonius, *De Grammaticis*, 20). He is said to have fallen into great poverty in his old age, and to have been supported by the historian Clodius Licinus. He was a voluminous author, and his works included topographical and biographical treatises, commentaries on Helvius Cinna and the poems of Virgil, and disquisitions on agriculture and bee-keeping. All these are lost.

Under the name of Hyginus two school treatises on mythology are extant: (1) *Fabularum Liber*, some 300 mythological legends and celestial genealogies, valuable for the use made by the author of the works of Greek tragedians now lost; (2) *De Astronomia*, usually called *Poetica Astronomia*, containing an elementary treatise on astronomy and the myths connected with the stars, chiefly based on the *Kalendarium* of Eratosthenes. Both are abridgments and both are by the same hand; but the style and Latinity and the elementary mistakes (especially in the rendering of the Greek originals) are held to prove that they cannot have been the work of so distinguished a scholar as C. Julius Hyginus. It is suggested that these treatises are an abridgment (made in the latter half of the 2nd century) of the *Genealogie* of Hyginus by an unknown grammarian, who added a complete treatise on mythology.

EDITIONS.—*Fabulae*, by M. Schmidt (1872); *De Astronomia*, by B. Bunte (1875); see also Bunte, *De C. Julii Hygini, Augusti Liberti, Vita et Scriptis* (1846).

**HYGROMETER** (Gr. *ὑγρός*, moist, *μέτρον*, a measure), an instrument for measuring the absolute or relative amount of moisture in the atmosphere; an instrument which only qualitatively determines changes in the humidity is termed a "hygroscope." The earlier instruments generally depended for their action on the contraction or extension of substances when exposed to varying degrees of moisture; catgut, hair, twisted cords and wooden laths, all of which contract with an increase in the humidity and vice versa, being the most favoured materials. The familiar "weather house" exemplifies this property. This toy consists of a house provided with two doors, through which either a man or woman appears according as the weather is about to be wet or fine. This action is effected by fixing a catgut thread to the base on which the figures are mounted, in such a manner that contraction of the thread rotates the figures so that the man appears and extension so that the woman appears.

Many of the early forms are described in C. Hutton, *Math. and Phil. Dictionary* (1815). The modern instruments, which utilize other principles, are described in METEOROLOGY: II. *Methods and Apparatus*.

**HYKSOS**, or "SHEPHERD KINGS," the name of the earliest invaders of Egypt of whom we have definite evidence in tradition. Josephus (*c. Apion*, i. 14), who identifies the Hyksos with the Israelites, preserves a passage from the second book of Manetho giving an account of them. (It may be that Josephus had it, not direct from Manetho's writings, but through the garbled version of some Alexandrine compiler.) In outline it is as follows. In the days of a king of Egypt named Timaueus the land was suddenly invaded from the east by men of ignoble race, who conquered it without a struggle, destroyed cities and temples, and slew or enslaved the inhabitants. At length they elected a king named Salatis, who, residing at Memphis, made all Egypt tributary, and established garrisons in different parts, especially eastwards, fearing the Assyrians. He built also a great fortress at Avaris, in the Sethroite nome, east of the Bubastite branch of the Nile. Salatis was followed in succession by Beon, Apachnas, Apophis, Jannas and Asses. These six kings reigned 198 years and 10 months, and all aimed at extirpating the Egyptians. Their whole race was named Hyksos, *i.e.* "shepherd kings," and

some say they were Arabs (another explanation found by Josephus is "captive shepherds"). When they and their successors had held Egypt for 511 years, the kings of the Thebais and other parts of Egypt rebelled, and a long and mighty war began. Misphragmuthosis worsted the "Shepherds" and shut them up in Avaris; and his son Thumthosis, failing to capture the stronghold, allowed them to depart; whereupon they went forth, 240,000 in number, established themselves in Judea and built Jerusalem.

In Manetho's list of kings, the six above named (with many variations in detail) form the XVth dynasty, and are called "six foreign Phoenician kings." The XVIth dynasty is of thirty-two "Hellenic (*sic*) shepherd kings," the seventeenth is of "shepherds and Theban kings" (reigning simultaneously). The lists vary greatly in different versions, but the above seems the most reasonable selection of readings to be made. For "Hellenic" see below. The supposed connexion with the Israelites has made the problem of the Hyksos attractive, but light is coming upon it very slowly. In 1847 E. de Rougé proved from a fragment of a story in the papyri of the British Museum, that Apopi was one of the latest of the Hyksos kings, corresponding to Aphobis; he was king of the "pest" and suppressed the worship of the Egyptian gods, and endeavoured to make the Egyptians worship his god Setekh or Seti; at the same time an Egyptian named Seqenerré reigned in Thebes, more or less subject to Aphobis. The city of Hawari (Avaris) was also mentioned in the fragment.

In 1850 a record of the capture of this city from the Hyksos by Ahmose, the founder of the eighteenth dynasty, was discovered by the same scholar. A large class of monuments was afterwards attributed to the Hyksos, probably in error. Some statues and sphinxes, found in 1861 by Mariette at Tanis (in the north-east of the Delta), which had been usurped by later kings, had peculiar "un-Egyptian" features. One of these bore the name of Apopi engraved lightly on the shoulder; this was evidently a usurper's mark, but from the whole circumstances it was concluded that these, and others of the same type of features found elsewhere, must have belonged to the Hyksos. This view held the field until 1893, when Golénischeff produced an inferior example bearing its original name, which showed that in this case it represented Amenemhe III. In consequence it is now generally believed that they all belong to the twelfth dynasty. Meanwhile a headless statue of a king named Khyan, found at Bubastis, was attributed on various grounds to the Hyksos, the soundest arguments being his foreign name and the boastful un-Egyptian epithet "beloved of his *ka*," where "beloved of Ptah" or some other god was to be expected. His name was immediately afterwards recognized on a lion found as far away from Egypt as Bagdad. Flinders Petrie then pointed out a group of kings named on scarabs of peculiar type, which, including Khyan, he attributed to the period between the Old Kingdom and the New, while others were in favour of assigning them all to the Hyksos, whose appellation seemed to be recognizable in the title Hck-khos, "ruler of the barbarians," borne by Khyan. The extraordinary importance of Khyan was further shown by the discovery of his name on a jar-lid at Cnossus in Crete. Semitic features were pointed out in the supposed Hyksos names, and Petrie was convinced of their date by his excavations of 1905-1906 in the eastern Delta. Avaris is generally assigned to the region towards Pelusium on the strength of its being located in the Sethroite nome by Josephus, but Petrie thinks it was at Tell el-Yahudiyyeh (Yehudia), where Hyksos scarabs are common. From the remains of fortifications there he argues that the Hyksos were uncivilized desert people, skilled in the use of the bow, and must thus have destroyed by their archery the Egyptian armies trained to fight hand-to-hand; further, that their hordes were centered in Syria, but were driven thence by a superior force in the East to take refuge in the islands and became a sea-power—whence the strange description "Hellenic" in Manetho, which most editors have corrected to  $\delta\lambda\lambda\alpha\iota$ , "others." Besides the statue of Khyan, blocks of granite with the name of Apopi have been found in

Upper Egypt at Gebelen and in Lower Egypt at Bubastis. The celebrated Rhind mathematical papyrus was copied in the reign of an Apopi from an original of the time of Amenemhe III. Large numbers of Hyksos scarabs are found in Upper and Lower Egypt, and they are not unknown in Palestine. Khyan's monuments, inconspicuous as they are, actually extend over a wider area—from Bagdad to Cnossus—than those of any other Egyptian king.

It is certain that this mysterious people were Asiatic, for they are called so by the Egyptians. Though Seth was an Egyptian god, as god of the Hyksos he represents some Asiatic deity. The possibility of a connexion between the Hyksos and the Israelites is still admitted in some quarters. Hatred of these impious foreigners, of which there is some trace in more than one text, aroused amongst the Egyptians (as nothing ever did before or since) that martial spirit which carried the armies of Tethmosis to the Euphrates.

Besides the histories of Egypt, see J. H. Breasted, *Ancient Records of Egypt*; Historical Documents ii. 4, 125; G. Maspero, *Contes populaires*, 3me éd. p. 236; W. M. F. Petrie, *Hyksos and Israelite Cities*, p. 67; Golénischeff in *Recueil de travaux*, xv. p. 131. (F. L. G.)

**HYLAS**, in Greek legend, son of Theiodamas, king of the Dryopians in Thessaly, the favourite of Heracles and his companion on the Argonautic expedition. Having gone ashore at Kios in Mysia to fetch water, he was carried off by the nymphs of the spring in which he dipped his pitcher. Heracles sought him in vain, and the answer of Hylas to his thrice-repeated cry was lost in the depths of the water. Ever afterwards, in memory of the threat of Heracles to ravage the land if Hylas were not found, the inhabitants of Kios every year on a stated day roamed the mountains, shouting aloud for Hylas (Apollonius Rhodius i. 1207; Theocritus xiii.; Strabo xii. 564; Propertius i. 20; Virgil, *Ecl.* vi. 43). But, although the legend is first told in Alexandrian times, the "cry of Hylas" occurs long before as the "Mysian cry" in Aeschylus (*Persae*, 1054), and in Aristophanes (*Plutus*, 1127) "to cry Hylas" is used proverbially of seeking something in vain. Hylas, like Adonis and Hyacinthus, represents the fresh vegetation of spring, or the water of a fountain, which dries up under the heat of summer. It is suggested that Hylas was a harvest deity and that the ceremony gone through by the Kians was a harvest festival, at which the figure of a boy was thrown into the water, signifying the dying vegetation-spirit of the year.

See G. Türk in *Breslauer Philologische Abhandlungen*, vii. (1895); W. Mannhardt, *Mythologische Forschungen* (1884).

**HYLOZOISM** (Gr.  $\delta\lambda\lambda\alpha$ , matter.  $\zeta\omega\eta$ , life), in philosophy, a term applied to any system which explains all life, whether physical or mental, as ultimately derived from matter ("cosmic matter," *Weltstoff*). Such a view of existence has been common throughout the history of thought, and especially among physical scientists. Thus the Ionian school of philosophy, which began with Thales, sought for the beginning of all things in various material substances, water, air, fire (see IONIAN SCHOOL). These substances were regarded as being in some sense alive, and taking some active part in the development of being. This primitive hylozoism reappeared in modified forms in medieval and Renaissance thought, and in modern times the doctrine of materialistic monism is its representative. Between modern materialism and hylozoism proper there is, however, the distinction that the ancients, however vaguely, conceived the elemental matter as being in some sense animate if not actually conscious and conative.

**HYMEN**, or HYMENAEUS, originally the name of the song sung at marriages among the Greeks. As usual the name gradually produced the idea of an actual person whose adventures gave rise to the custom of this song. He occurs often in association with Linus and Ialemus, who represent similar personifications, and is generally called a son of Apollo and a Musc. As the son of Dionysus and Aphrodite, he was regarded as a god of fruitfulness. In Attic legend he was a beautiful youth who, being in love with a girl, followed her in a procession to Eleusis disguised as a woman, and saved the whole band from pirates. As reward

he obtained the girl in marriage, and his happy married life caused him ever afterwards to be invoked in marriage songs (Servius on Virgil, *Aen. i.* 651). According to another story, he was a youth who was killed by the fall of his house on his wedding day; hence he was invoked to propitiate him and avert a similar fate from others (Servius, *loc. cit.*). He is represented in works of art as an effeminate-looking, winged youth, carrying a bridal torch and wearing a nuptial veil. The marriage song was sung, with musical accompaniment, during the procession of the bride from her parents' house to that of the bridegroom, Hymenaeus being invoked at the end of each portion.

See R. Schmidt, *De Hyemnaeo et Talasio* (1886), and J. A. Hild in Darnenberg and Saglis's *Dictionnaire des antiquités*.

**HYMENOPTERA** (Gr. *ὕμην*, a membrane, and *πτερόν*, a wing), a term used in zoological classification for one of the most important orders of the class *Hexapoda* (q.v.). The order was founded by Linnaeus (*Systema Naturae*, 1735), and is still recognized by

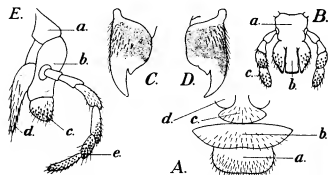

After C. L. Marlatt, *Bur. Ent. Bull.* 3, N.S., U.S. Dept. Agric.

FIG. 1.—A, Front of head of Sawfly (*Pachynematus*); a, labrum; b, clypeus; c, vertex; d, d, antennal cavities; e, g and h, Mandibles; E, First maxilla; a, cardo; b, stipes; c, galea; d, lacinia; e, palp. B, Second maxilla (Labium); a, mentum; b, ligula (between the two galeae); c, e, palps. Magnified.

all naturalists in the sense proposed by him, to include the sawflies, gall-flies, ichneumon-flies and their allies, ants, wasps and bees. The relationship of the Hymenoptera to other orders of insects is discussed in the article HEXAPODA,

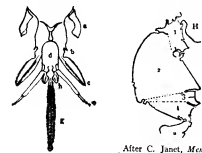

FIG. 2.—Jaws of Honey-bee (*Apis mellifica*). Magnified about 64 times. A, mandible; b, c, palp and lacinia of first maxilla; d, e, g, h, mentum, palp, fused laciniae ('ligula' or 'tongue'); i, being the pro- and galea of 2nd maxillae.

After C. Janet, *Mem. Soc. Zool. France* (1898).

FIG. 3.—Median section through middle of female Red Ant (*Myrmica rubra*). H, Head; 1, 2, 3, the thoracic segments; i, ii, the first and second abdominal segments; a, b, c, being the pro- and galea of 2nd maxillae.

structure becomes elongated (fig. 2, g) so as to form an elaborate sucking-organ or "tongue." These insects are able, therefore, to bite as well as to suck, whereas most insects which have acquired the power of suction have lost that of biting. Both fore- and hind-wings are usually present, both pairs being membranous, the hind-wings small and not folded when at rest, each provided along the

costa with a row of curved hooks which catch on to a fold along the dorsum of the adjacent fore-wing during flight. A large number of Hymenoptera are, however, entirely wingless—at least as regards one sex or form of the species. One of the most remarkable features is the close union of the foremost abdominal segment (fig. 3, i) with the metathorax, of which it often seems to form a part, the apparent first abdominal segment being, in such case, really the second (fig. 3, ii). The true first segment, which undergoes a more or less complete fusion with the thorax is known as the "median segment" or *propodeum*. In female Hymenoptera the typical insectan ovipositor with its three pairs of processes is well developed, and in the higher families this organ becomes functional as a sting (fig. 5)—used for offence and defence. As regards their life history, all Hymenoptera undergo a "complete" metamorphosis. The larva is soft-skinned (eruciform), being either a caterpillar (fig. 6, b) or a legless grub (fig. 7, a), and the pupa is free (fig. 7, c), i.e. with the appendages not fixed to the body, as is the case in the pupa of most moths.

**Structure**.—The head of a hymenopterous insect bears three simple eyes (ocelli) on the front and vertex in addition to the large compound

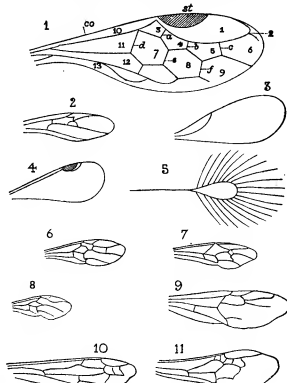

FIG. 4.—Fore-Wings of Hymenoptera.

1. Tenthredinidae (*Hylotoma*)—1, marginal; 2, appendicular; 3, 4, 5, 6, radial or submarginal; 7, 8, 9, median or discoidal; 10, sub-costal; 11, 12, cubital or branchial; and 13, anal or lancolate cells; a, b, c, submarginal nerves; d, basal nerves; e, f, recurrent nerves; st, stigma; co, costa.
2. Cynipidae (*Cynips*).
3. Chalcididae (*Perilampus*).
4. Proctotrypidae (*Codrus*).
5. Myrmecidae (*Myrmex*).
6. Braconidae (*Bracon*).
7. Ichneumonidae (*Trogus*).
8. Chrysididae (*Clypeus*).
9. Formicidae (*Formica*).
10. Vespididae (*Vespa*).
11. Apidae (*Apothys*).

eyes. The feelers are generally simple in type, rarely showing serrations or prominent appendages; but one or two basal segments are frequently differentiated to form an elongate "scape," the remaining segments—carried at an elbowed angle to the scape—making up the "flagellum"; the segments of the flagellum often bear complex sensory organs. The general characters of the jaws have been mentioned above, and in detail there is great variation in these organs among the different families. The sucking tongue of the Hymenoptera has often been compared with the hypopharynx of other insects. According to D. Sharp, however, the hypopharynx is present in all Hymenoptera as a distinct structure at the base of the "tongue," which must be regarded as representing the fused laciniae of the second maxillae. In the thorax the pronotum and prosternum are closely associated with the mesothorax, but the pleura of the prothorax are usually shifted far forwards, so that the forelegs are inserted just behind the head. A pair of small plates—the tegulae—are very generally present at the bases of the fore-wings. The union of the first abdominal segment with the metathorax has been

already mentioned. The second (so-called "first") abdominal segment is often very constricted, forming the "waist" so characteristic of wasps and ants for example. The constriction of this segment and its very perfect articulation with the propodeum give great mobility to the abdomen, so that the ovipositor or sting can be used with the greatest possible accuracy and effect.

Mention has already been made of the series of curved hooks along the costa of the hind-wing; by means of this arrangement the two wings of a side are firmly joined together during flight, which thus becomes particularly accurate. The wings in the Hymenoptera show a marked reduction in the number of nervures as compared with more primitive insects. The main median nervure, and usually also the sub-costal become united with the radial, while the branches of radial, median and cubital nervures pursuing a transverse or recurrent course across the wing, divide its area into a number of areolet or "cells," that are of importance in classification. Among many of the smaller Hymenoptera we find that the wings are almost destitute of nervures. In the hind-wings—on account of their reduced size—the nervures are even more reduced than in the fore-wings.

The legs of Hymenoptera are of the typical insectan form, and the foot is usually composed of five segments. In many families the trochanter appears to be represented by two small segments, there being thus an extra joint in the leg. It is almost certain that the distal of these two segments really belongs to the thigh, but the ordinary nomenclature will be used in the present article, as this character is of great importance in discriminating families, and the two segments in question are referred to the trochanter by most systematic writers.

The typical insectan ovipositor, so well developed among the Hymenoptera, consists of three pairs of processes (gonapophyses) two of which belong to the ninth abdominal segment and one to

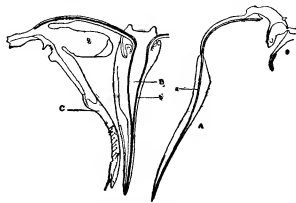

After C. Janet, *Aiguillon de la Myrmica rubra* (Paris, 1868).

FIG. 5.—Ovipositor or Sting of Red Ant (*Myrmica rubra*) Queen. Magnified. The right sheath C (outer process of the ninth abdominal segment—9) is shown in connexion with the guide B formed by the inner processes of the 9th segment. The stylate A (process of the 8th abdominal segment—8) is turned over to show its groove *a*, which works along the tongue or rail *b*.

the eighth. The latter are the cutting or piercing stylates (fig. 5, A) of the ovipositor, while the two outer processes of the ninth segment are modified into sheaths or feelers (fig. 5, C) and the two inner processes form a guide (fig. 5, B) on which the stylates work, tongues or rails on the "guide" fitting accurately into longitudinal grooves on the stylate. In the different families of the Hymenoptera, there are various modifications of the ovipositor, in accord with the habits of the insects and the purposes to which the organ is put. The sting of wasps, ants and bees is a modified ovipositor and is used for egg-laying by the fertile females, as well as for defence. Most male Hymenoptera have processes which form claspers or genital armature. These processes are not altogether homologous with those of the ovipositor, being formed by inner and outer lobes of a pair of structures on the ninth abdominal segment.

Many points of interest are to be noted in the internal structure of the Hymenoptera. The gutlet leads into a moderate-sized crop, and several pairs of salivary glands open into the mouth. The crop is followed by a proventriculus which, in the higher Hymenoptera, forms the so-called "honey stomach," by the contraction of whose walls the solid and liquid food can be separated, passed on into the digestive stomach, or held in the crop ready for regurgitation into the mouth. Behind the digestive stomach are situated, as usual, intestine and rectum, and the number of kidney (Malpighian) tubes varies from only six to over a hundred, being usually great.

In the female, each ovary consists of a large number of ovarian tubes, in which swollen chambers containing the egg-cells alternate with smaller chambers enclosing nutrient material. In connexion with the ovipositor are two poison-glands, one acid and the other alkaline in its secretion. The acid gland consists of one, two or more tubes, with a cellular coat of several layers, opening into a

reservoir whence the duct leads to the exterior. The alkaline gland is an irregular tube with a single cellular layer, its duct opening alongside that of the acid reservoir. These glands are most strongly developed when the ovipositor is modified into a sting.

**Development.**—Parthenogenesis is of normal occurrence in the life-cycle of many Hymenoptera. There are species of gall-fly in which males are unknown, the unfertilized eggs always developing into females. On the other hand, in certain saw-flies and among the higher families, the unfertilized eggs, capable of development, usually give rise to male insects (see BEE). The larvae of most saw-flies feeding on the leaves of plants are caterpillars (fig. 6, *b*) with numerous abdominal pro-legs, but in most families of Hymenoptera the egg is laid in such a situation that an abundant food-supply is assured without exertion on the part of the larva, which is consequently a legless grub, usually white in colour, and with soft flexible cuticle (fig. 7, *d*). The organs and instincts for egg-laying and food-providing are perhaps the most remarkable features in the economy of the Hymenoptera. Gall-fly grubs are provided with vegetable food through the eggs being laid by the mother insect within plant tissues. The ichneumon pierces the body of a caterpillar and lays her eggs where the grubs will find abundant animal food. A digging-wasp hunts for insect prey and buries it with the egg, while a true wasp feeds her brood with captured insects, as a bird her fledglings. Bees store honey and pollen to serve as food for their young. Thus we find throughout the order a degree of care for offspring un-reached by other insects, and this family-life has, in the best known of the Hymenoptera—ants, wasps and bees—developed into an elaborate social organization.

**Social Life.**—The development of a true insect society among the Hymenoptera is dependent on a differentiation among the females between individuals with well-developed ovaries ("queens") whose special function is reproduction; and individuals with reduced or aborted ovaries ("workers") whose duty is to build the nest, to gather food and to tend and feed the larvae. Among the wasps the workers may only differ from the queens in size, and individuals intermediate between the two forms of female may be met with. Further, the queen wasp, and also the queen humble-bee, commences unaided the work of building and founding a new nest, being afterwards helped by her daughters (the workers) when these have been developed. In the hive-bee and among ants, on the other hand, there are constant structural distinctions between queen and worker, and the function of the queen bee in a hive is confined to egg-laying, the labour of the community being entirely done by the workers. Many ants possess several different forms of worker, adapted for special duties. Details of this fascinating subject are given in the special articles ANT, BEE and WASP (*q.v.*).

**Habits and Distribution.**—Reference has already been made to the various methods of feeding practised by Hymenoptera in the larval stage, and the care taken of or for the young throughout the order leads in many cases to the gathering of such food by the mother or nurse. Thus, wasps catch flies; worker ants make raids and carry off weak insects of many kinds; bees gather nectar from flowers and transform it into honey within their stomachs—largely for the sake of feeding the larvae in the nest. The feeding habits of the adult may agree with that of the larva, or differ, as in the case of wasps which feed their grubs on flies, but eat principally vegetable food themselves. The nest-building habit is similarly variable. Digging wasps make simple holes in the ground; many burrowing bees form branching tunnels; other bees excavate timber or make their brood-chambers in hollow plant-stems; wasps work up with their saliva vegetable fibres bitten off tree-bark to make paper; social bees produce from glands in their own bodies the wax which their nest-chambers are built. The inquiline habit ("cuckoo-parasitism"), when one species makes use of the labour of another by invading the nest and laying her eggs there, is of frequent occurrence among Hymenoptera; and in some cases the larva of the intruder is not content with taking the store of food provided, but attacks and devours the larva of the host.

Most Hymenoptera are of moderate or small size, the giants of the order—certain saw-flies and tropical digging-wasps—never reach the bulk attained by the largest beetles, while the wing-spread is narrow compared with that of many dragonflies and moths. On the other hand, there are thousands of very small species, and the tiny "fairy-flies" (*Myiariidae*), whose larvae live as parasites in the eggs of various insects, are

excessively minute for creatures of such complex organization. Hymenoptera are probably less widely distributed than Aptera, Coleoptera or Diptera, but they are to be found in all except the most inhospitable regions of the globe. The order is, with few exceptions, terrestrial or aerial in habit. Comparatively only a few species are, for part of their lives, denizens of fresh water; these, as larvae, are parasitic on the eggs or larvae of other aquatic insects, the little hymenopteron, *Polynema natans*, one of the "fairy-flies"—swims through the water by strokes of her delicate wings in search of a dragon-fly's egg in which to lay her own egg, while the rare *Agriotypus* dives after the case of a caddis-worm. It is of interest that the waters have been invaded by the parasitic group of the Hymenoptera, since in number of species this is by far the largest of the order. No group of terrestrial insects escapes their attacks—even larvae boring in wood are detected by ichneumon flies with excessively long ovipositors. Not a few cases are known in which a parasitic larva is itself pierced by the ovipositor of a "hyperparasite," and even the offspring of the latter may itself fall a victim to the attack of a "tertiary parasite."

**Fossil History.**—Very little is known of the history of the Hymenoptera previous to the Tertiary epoch, early in which, as we know from the evidence of many Cretaceous and Miocene fossils, all the more important families had been differentiated. Fragments of wings from the Lias and Oolitic beds have been referred to ants and bees, but the true nature of these remains is doubtful.

**Classification.**—Linnaeus divided the Hymenoptera into two sections—the Terebrantia, whose females possess a cutting or piercing ovipositor, and the Aculeata, in which the female organ is modified into a sting. This nomenclature was adopted by P. A. Latreille and has been in general use until the present day. A closely similar division of the order results from T. Hartig's character drawn from the trochanter—whether of two segments or undivided—the groups being termed respectively Ditrocha and Monotrocha. But the most natural division is obtained by the separation of the saw-flies as a primitive sub-order, characterized by the imperfect union of the first abdominal segment with the thorax, and by the broad base of the abdomen, so that there is no median constriction or "waist," and by the presence of thoracic legs—usually also of abdominal pro-legs—in the larva. All the other families of Hymenoptera, including the gall-flies, ichneumons and aculeates, have the first abdominal segment closely united with the thorax, the second abdominal segment constricted so as to form a narrow stalk or "waist," and legless larvae without a hinder outlet to the food-canal. These two sub-orders are usually known as the *Sessiliventra* and *Petioliventra* respectively, but the names *Symphyla* and *Apoecita* proposed in 1867 by C. Gerstaecker have priority, and should not be replaced.

#### *Symphyla.*

This sub-order, characterized by the "sessile," broad-based abdomen, whose first segment is imperfectly united with the thorax, and by the usually caterpillar-like larvae with legs, includes the various groups of saw-flies. Three leading families may be mentioned. The *Cephiidae*, or stem saw-flies, have an elongate pronotum, a compressed abdomen, and a single spine on the shin of the fore-leg. The soft, white larvae have the thoracic legs very small and feed in the stems of various plants. *Cephus pygmaeus* is a well-known enemy of corn crops. The *Stricidae* ("wood-wasps") are large elongate insects also with one spine on each fore-shin, but with the pronotum closely joined to the mesothorax. The ovipositor is long and prominent, enabling the female insect to lay her eggs in the wood of trees, where the white larvae, whose legs are excessively short, tunnel and feed. These insects are adorned with bands of black and yellow, or with bright metallic colours, and on account of their large size and formidable ovipositors they often cause needless alarm to persons unfamiliar with their habits. The *Tenthredinidae*, or true saw-flies, are distinguished by two spines on each fore-shin, while the larvae are usually caterpillars, with three pairs of thoracic legs, and from six to eight pairs of abdominal pro-legs, the latter not possessing the hooks found on the pro-legs of lepidopterous caterpillars. Most saw-fly larvae devour leaves, and the beautifully serrate processes of the ovipositor are well adapted for egg-laying in plant tissues. Some saw-fly larvae are protected by a slimy secretion (fig. 6, c) and a few live concealed in galls. In the form of the feelers, the wing-venuration and minor structural details, there is much diversity among the saw-flies. They have been usually regarded as a single family; but W. H. Ashmead has lately differentiated eleven families of them.

#### *Apoecita.*

This sub-order includes the vast majority of the Hymenoptera, characterized by the narrowly constricted waist in the adult and by the legless condition of the larva. The trochanter is simple in some genera and divided in others. With regard to the minor divisions of this group, great difference of opinion has prevailed among students. In his recent classification Ashmead (1901) recognizes seventy-nine families arranged under eight "super-families." The number of species included in this division is enormous, and the multiplication of families is, to some extent, a natural result of increasingly close study. But the distinctions between many of these rest on comparatively slight characters, and it is likely that

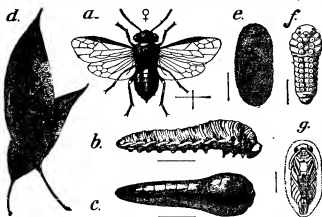

FIG. 6.—*a*, Pear Saw-fly (*Eriocampoides limacina*); *b*, larva with-out, and *c*, with its slimy protective coat; *e*, cocoon; *f*, larva before pupation; *g*, pupa, magnified; *d*, leaves with larvae.

the future discovery of new genera may abolish many among such distinctions as may now be drawn. It seems advisable, therefore, in the present article to retain the wider conception of the family that has hitherto contented most writers on the Hymenoptera. Ashmead's "super-families" have, however, been adopted as—founded on definite structural characters—they probably indicate relationship more nearly than the older divisions founded mostly on habit. The Cynipoidea include the gall-flies and their parasitic relations. In the Chalcidoidea, Ichneumoidea and Proctero-podea will be found nearly all the "parasitic Hymenoptera" of older classifications. The Formicoidea are the ants. The group of Possore, or "digging-wasps," is divided by Ashmead, one section forming the Sphecoidea, while the other, together with the Chrysidea

the future discovery of new genera may abolish many among such distinctions as may now be drawn. It seems advisable, therefore, in the present article to retain the wider conception of the family that has hitherto contented most writers on the Hymenoptera. Ashmead's "super-families" have, however, been adopted as—founded on definite structural characters—they probably indicate relationship more nearly than the older divisions founded mostly on habit. The Cynipoidea include the gall-flies and their parasitic relations. In the Chalcidoidea, Ichneumoidea and Proctero-podea will be found nearly all the "parasitic Hymenoptera" of older classifications. The Formicoidea are the ants. The group of Possore, or "digging-wasps," is divided by Ashmead, one section forming the Sphecoidea, while the other, together with the Chrysidea

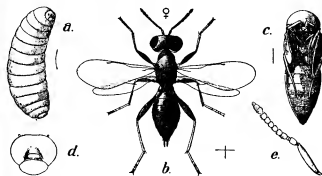

FIG. 7.—Chalcid (*Dibrachys borchae*), a hyper-parasite.

*a*, Larva. *b*, Female fly. *c*, Pupa of male. *d*, its head more highly magnified. *e*, Feeler.

and the true wasps, make up the Vespoidea. The Apoecita consists of the bees only.

**Cynipoidea.**—In this division the ovipositor issues from the ventral surface of the abdomen; the pronotum reaches back to the tegulae; the trochanter has two segments; the fore-wing (fig. 4, 2) has no stigma, but one or two areolet. The feelers with twelve to fifteen segments are thread-like and straight. All the insects included in this group are small and form two families—the Cynipidae and the Figitidae. They are the "gall-flies," many of the species laying eggs in various plant-tissues where the presence of the larva causes the formation of a pathological growth or gall, always of a definite form and characteristic of the species; the "oak-apple" and the

bedebugar of the rose are familiar examples. Other flies of this group have the inquiline habit, laying their eggs in the galls of other species, while others again pierce the cuticle of maggots or aphids, in whose bodies their larvae live as parasites.

**Chalcidoidea.**—This division resembles the Cynipoidea in the position of the ovipositor, and in the two segmented trochanters. The fore-wing also has no stigma, and the hind wing is almost destitute of nervures and areolets, while the pronotum does not reach back to the tegulae, and the feelers are elbowed (fig. 7). The vast majority of this group, including nearly 5000 known species, are usually reckoned as a single family, the *Chalcididae*, comprising small insects, often of bright metallic colours, whose larvae are parasitic in insects of various orders. The "fig-insects," whose presence in ripening figs is believed essential to the proper development of the fruit, belong to *Blastophaga* and other genera of this family. They are remarkable in having wingless males and winged females. The "polyembryony" development of an *Encyrtus*, as studied by P. Marchal, is highly remarkable. The female lays her egg in the egg of a small ermine moth (*Hyponomeuta*) and the egg gives rise not to a single embryo but to a hundred, which develop as the host-caterpillar develops, being found at a later stage within the latter enveloped in a flexible tube.

The *Mymaridae* or "fairy-flies" are distinguished from the *Chalcididae* by their narrow fringed wings (figs. 4, 5) and by the situation of the ovipositor just in front of the tip of the abdomen. They are among the most minute of all insects and their larvae are probably all parasitic in insects' eggs.

**Ichneumonoida.**—The ten thousand known species included in this group agree with the Cynipoidea and Chalcidoidea in the position of the ovipositor and in the jointed trochanters, but are distinguished by the fore-wing possessing a distinct stigma and usually a typical series of nervures and areolets (figs. 4, 8). Many of the species are of fair size. They lay their eggs (fig. 8) in the bodies of insects and their larvae belonging to various orders. A few small families such as the *Eurytomidae* and the *Stenomacridae* are included here, but the vast majority of the group fall into two large families, the *Ichneumonidae* and the *Braconidae*, the former distinguished by the presence of two median (or discoidal) cells in the fore-wing (figs. 4, 7), while the latter has only one (figs. 4, 6). Not a few of these insects, however, are entirely wingless. On account of their work in destroying plant-eating insects, the ichneumonflies are of great economic importance.



After Riley and Howard, *Insect Life*, vol. i.

FIG. 8.—Ichneumon Fly (*Rhyssa persatoraria*) ovipositing.

of the ovipositor at the extreme apex of the abdomen, and from the groups that follow (with very few exceptions) by the jointed trochanters of the legs. The pronotum reaches back to the tegulae. The *Plectinidae*—included here by Ashmead—are large insects with remarkably elongate abdomens and undivided trochanters. All the other members of the group may be regarded as forming a single family—the *Proctotrupidae*, including an immense number of small parasitic Hymenoptera, or a few of which are wingless. Of special interest are the transformations of *Platygaster*, belonging to this family, discovered by M. Guin, and familiarized to English readers through the writings of Sir J. Lubbock (Lord Avebury). The first larva is broad in front and tapers behind to a "tail" provided with two divergent processes, so that it resembles a small crustacean. It lives in the grub of a gall-nidge and it ultimately becomes changed into the usual white and fleshy hymenopterous larva. The four succeeding sections, in which the ovipositor is modified into a sting (always exerted from the tip of the abdomen) and the trochanters are with few exceptions simple, form the *Aculeata* of Linnaeus.

**Formicoidea.**—The ants which form this group are readily distinguished by the differentiation of the females into winged "queens" and wingless "workers." The pronotum extends back to the wing-bases, and the "waist" is greatly constricted and marked by one or two "nodes." The differentiation of the females leads to a complex social life, the nesting habits of ants and the various industries that they pursue being of surpassing interest (see ART. 187).

**Vespoidea.**—This section includes a number of families characterized by the backward extension of the prothorax to the tegulae and distinguished from the ants by the absence of "nodes" at the base of the abdomen. The true wasps have the fore-wings folded lengthwise when at rest and the fore-legs of normal build—not specialized for digging. The *Vespididae* or social wasps have "queens" and "workers" like the ants, but both these forms of female are winged; the claws on their feet are simple. In the *Exemnodidae* or solitary wasps the female sex is undifferentiated, and the foot claws

are toothed. (For the habits of these insects see Wasp.) The *Chrysididae* or ruby wasps are small insects with a very hard cuticle exhibiting brilliant metallic colours—blue, green and crimson. Only three or four abdominal segments are visible, the hinder segments being slender and retracted to form a telescope-like tube in which the ovipositor lies. When the ovipositor is brought into use this tube is thrust out. The eggs are laid in the nests of various bees and wasps, the chrysid larva living as a "cuckoo" parasite. The *Trigonidae*, a small family whose larvae are parasitic in wasps' nests, also probably belong here.

The other families of the *Vespoidea* belong to the series of "Fossors" or digging-wasps. In two of the families—the *Mutillidae* and *Thynnidae*—the females are wingless and the larvae live as parasites in the larvae of other insects; the female *Mutilla* enters humble-bees' nests and lays her eggs in the bee-grubs. In the other families both sexes are winged, and the instinctive industry of the females are among the most wonderful in the Hymenoptera. They make burrows wherein they place insects or spiders which they have caught and stung, laying their eggs beside the victim so that the young larvae find themselves in presence of an abundant and appropriate food-supply. Valuable observations on the habits of these insects are due to J. H. Fabre and G. W. and E. Peckham. The prey is sometimes stung in the neighbourhood of the nerve ganglia, so that it is paralysed but not killed, the grub of the fossorial wasp entering its victim alive. This instinct varies in perfection, and in many cases the larva flourishes equally whether its prey be killed or not. The females have a wonderful power of finding their burrows on returning from their hunting expeditions. Among the Vespid families of fossorial wasps, the *Pompilidae* are the most important. They are recognizable by their slender and elongate hind-legs; many of them provision their burrows with spiders. The *Sapygidae* are parasitic on bees, while the *Scelididae* are large, robust and hairy insects, many of which prey upon the grubs of chafers.

**Spheroidea.**—In this division are included the rest of the "digging-wasps," distinguished from the *Vespoidea* by the short pronotum not reaching backward to the tegulae. They have usually been reckoned as forming a single, very large family—the *Sphégiidae*—but ten or twelve subdivisions of the group are regarded as distinct families by Ashmead and others. Great diversity is shown in the details of structure, habits and nature of the prey. Species of *Sphex*, studied by Fabre, provisioned their brood-chambers with crickets. *Proctopus* hunts spiders, while *Ammophila* catches caterpillars for the benefit of her young. Fabre states that the first-named insect uses a stone for the temporary closing of her burrow, and the Peckhams have seen a female *Ammophila* take a stone between her mandibles and use it as a hammer for pounding down the earth over her finished nest. The habits of *Bembex* are of especial interest. The female, instead of provisioning her burrow with a supply of food that will suffice the larva for its whole life, brings fresh flies with which she regularly feeds her young. In this instinct we have a correspondence with the habits of social wasps and bees. Yet it may be thought that the usual instinct of the "digging-wasps" to capture and store up food in an underground burrow for the benefit of offspring which they will never see is even more surprising. The habit of some genera is to catch the prey before making their tunnel, but more frequently the insect digs her nest, and then hunts for prey to put into it.

**Apoidea.**—The bees which make up this group agree with the Spheroidea in the short pronotum, but may be distinguished from all other Hymenoptera by the widened first tarsal segment and the plumose hairs on head and body. They are usually regarded as forming a single family—the *Apidae*—but there is very great diversity in structural details, and Ashmead divides them into fourteen families. The "tongue," for example, is short and obtuse or emarginate in *Colletes* and *Prosopeis*, while in all other bees it is pointed at the tip. But in *Andrena* and its allies it is comparatively short, while in the higher genera, such as *Apis* and *Bombus*, it is elongate and flexible, forming a most elaborate and perfect organ for taking liquid food. Bees feed on honey and pollen. Most of the genera are solitary in habit, the female sex being undifferentiated, but among the humble-bees and hive-bees we find, as in social wasps and ants, the occurrence of workers, and the consequent elaboration of a wonderful insect-society. (See BEE.)

**BIBLIOGRAPHY.**—The literature of several special families of the Hymenoptera will be found under the articles ANT, BEE, ICHNEUMON-FLY, WASP, &c., referred to above. Among earlier students on structure may be mentioned P. A. Latreille, *Familles naturelles du règne animal* (Paris, 1825), who recognized the nature of the "median segment." In Gerstaecker (*Arch. f. Naturg.*, vii., 1867) and in Stüb. K. *Abhandl. f. Naturg.*, lxxvii., 1883, should also be consulted on this subject. For internal anatomy, specially the digestive organs, see L. Dufour, *Mém. savants étrangers*, vii. (1841), and *Ann. Sci. Nat. Zool.* (4), i. 1854. For nervous system H. Viallanes, *Ann. Sci. Nat. Zool.* (7), ii. iv. 1886-1887, and F. C. Kenyon, *Journ. Comp. Neurol.*, vi., 1896. For poison and other glands, see L. Bordas, *Ann. Sci. Nat. Zool.* (7) xix., 1895. For the sting and ovipositor H. Dewitz, *Zeits. wiss. Zool.* xxv., 1874, xxviii., 1877, and F. Zander, *ib.* lxxv., 1890. For male genital armature S. A. Peyroureau, *Morphologie de l'armure génitale des*



*insectes* (Bordeaux, 1895), and E. Zander, *Zeits. wiss. Zool.* lxxvii, 1900. The systematic student of Hymenoptera is greatly helped by C. G. de Dalla Torre's *Catalogus Hymenopterorum* (10 vols., Leipzig, 1893-1902). For general classifications see F. W. Konow, *Entom. Nachtr.* (1897), and W. H. Ashmead, *Proc. U.S. Nat. Mus.* xxiii, 1901; the latter paper deals also especially with the Ichneumonidae of the globe. For habits and life histories of Hymenoptera see J. Lubbock (Lord Avebury), *Ants, Bees and Wasps* (5th ed., London, 1899); C. Janet, *Études sur les fourmis, les pucerons et les abeilles* (Paris, &c., 1893 and onwards); and G. W. and E. G. Peckham, *Instincts and Habits of Solitary Wasps* (Madison, Wis. U.S.A., 1898). Monographs of most of the families of British Hymenoptera have now been published. For saw-flies and gall-flies, see P. Cameron's *British Phytophagous Hymenoptera* (4 vols., London, Roy. Soc., 1882-1893). For Ichneumonidae, C. Morley's *Ichneumonids of Great Britain* (Plymouth, 1903, &c.), and T. A. Marshall's "British Braconidae," *Trans. Entom. Soc.*, 1885-1899. The smaller parasitic Hymenoptera have been neglected in this country since A. H. Halday's classical paper *Entom. Mag.* i, v, 1833-1838) but Ashmead's "North American Proctotrypidae," (*Bull. U.S. Nat. Mus.* xlv, 1893) is valuable for the European student. For the Fossors, wasps, ants and bees see E. Saunders, *Hymenoptera Aculeata of the British Islands* (London, 1896). Exhaustive references to general systematic works will be found in de Dalla Torre's *Catalogue* mentioned above. Of special value to English students are C. T. Bingham's *Fauna of British India*, "Hymenoptera" (London, 1897 and onwards), and P. Cameron's volumes on Hymenoptera in the *Biologia Centrali-Americana*. F. Smith's *Catalogues of Hymenoptera in the British Museum* (London, 1853-1859) are well worthy of study. (G. H. C.)

**HYMETTUS** (Ital. Monte Matto, hence the modern name Trello Vouini), a mountain in Attica, bounding the Athenian plain on the S.E. Height, 3370 ft. It was famous in ancient times for its bees, which gathered honey of peculiar flavour from its aromatic herbs; their fame still persists. The spring mentioned by Ovid (*Art. Amat.* iii. 687) is probably to be recognized near the monastery of Syriani or Kaesariani on the western slope. This may be identical with that known as Κόλλων Πηρα, said to be a remedy for barrenness in women. The marble of Hymettus, which often has a bluish tinge, was used extensively for building in ancient Athens, and also, in early times, for sculpture; but the white marble of Pentelicus was preferred for both purposes.

See E. Dodwell, *Classical and Topographical Tour* (1819), i. 483.

**HYMNS.**— 1. *Classical Hymnody.*— The word "hymn" (ὕμνος) was employed by the ancient Greeks<sup>1</sup> to signify a song or poem composed in honour of gods, heroes or famous men, or to be recited on some joyful, mournful or solemn occasion. Polymnia was the name of their lyric muse. Homer makes Alcinoos entertain Odysseus with a "hymn" of the minstrel Demodocus, on the capture of Troy by the wooden horse. The *Works and Days* of Hesiod begins with an invocation to the Muses to address hymns to Zeus, and in his *Theogonia* he speaks of them as singing or inspiring "hymns" to all the divinities, and of the bard as "their servant, hymning the glories of men of old, and of the gods of Olympus." Pindar calls by this name odes, like his own, in praise of conquerors at the public games of Greece. The Athenian dramatists (Euripides most frequently) use the word and its cognate verbs in a similar manner; they also describe by their metrical oracles and apophthegms, martial, festival and hymeneal songs, dirges and lamentations or incantations of woe.

Hellenic hymns, according to this conception of them, have come down to us, some from a very early and others from a late period of Greek classical literature. Those which passed by the name of Homer<sup>2</sup> were already old in the time of Thucydides. They are mythological poems (several of them long), in hexameter verse—some very interesting. That to Apollo contains a traditional history of the origin and progress of the Delphic worship; those on Hermes and on Dionysus are marked by most liveliness and poetical fancy. Hymns of a like general character, but of less interest (though these also embody some fine poetical traditions of the Greek mythology, such as the story

of Teiresias, and that of the wanderings of Leto), were written in the 3rd century before Christ, by Callimachus of Cyrene. Cleanthes, the successor of Zeno, composed (also in hexameters) an "excellent and devout hymn" (as it is justly called) by Cudworth, in his *Intellectual System*) to Zeus, which is preserved in the *Ecolage* of Stobaeus, and from which Aratus borrowed the words, "For we are also His offspring," quoted by St Paul at Athens. The so-called Orphic hymns, in hexameter verse, styled *reæra*, or hymns of initiation into the "mysteries" of the Hellenic religion, are productions of the Alexandrian school,—as to which learned men are not agreed whether they are earlier or later than the Christian era.

The Romans did not adopt the word "hymn"; nor have we many Latin poems of the classical age to which it can properly be applied. There are, however, a few—such as the simple and graceful "Dianæ sumus in fide" ("Dian's votaries are we") of Catullus, and "Dianam teneræ dicite virgines" ("Sing to Dian, gentle maidens") of Horace—which approach much more nearly than anything Hellenic to the form and character of modern hymnody.

2. *Hebrew Hymnody.*—For the origin and idea of Christian hymnody we must look, not to Gentile, but to Hebrew sources. St Augustine's definition of a hymn, generally accepted by Christian antiquity, may be summed up in the words, "praise to God with song" ("cum cantico"); Bede understood the "canticum" as properly requiring metre; though he thought that what in its original language was a true hymn might retain that character in an unmetrical translation. Modern use has enlarged the definition; Roman Catholic writers extend it to the praises of saints; and the word now comprehends rhythmical prose as well as verse, and prayer and spiritual meditation as well as praise.

The modern distinction between psalms and hymns is arbitrary (see PSALMS). The former word was used by the LXX. as a generic designation, probably because it implied an accompaniment by the psaltery (said by Eusebius to have been of very ancient use in the East) or other instruments. The cognate verb "psallere" has been constantly applied to hymns, both in the Eastern and in the Western Church; and the same compositions which they described generically as "psalms" were also called by the LXX. "odes" (i.e. songs) and "hymns." The latter word occurs, e.g. in Ps. lxxii. 20 ("the hymns of David the son of Jesse"), in Ps. lxxv. 1, and also in the Greek titles of the 6th, 54th, 55th, 67th and 76th (this numbering of the psalms being that of the English version, not of the LXX.). The 44th chapter of Ecclesiasticus, "Let us now praise famous men," &c., is entitled in the Greek *πατέρων ὕμνος*, "The Fathers' Hymn." Bede speaks of the whole book of Psalms as called "liber hymnorum," by the universal consent of Hebrews, Greeks and Latins.

In the New Testament we find our Lord and His apostles singing a hymn (*ὕμνησαντες ἐξήθον*), after the institution of the Lord's Supper; St Paul and Silas doing the same (*ὑμνοῦν τὸν θεόν*) in their prison at Philippi; St James recommending psalm-singing (*ψαλλέτω*), and St Paul "psalms and hymns and spiritual songs" (*ψαλλοῖς καὶ ὕμνοις καὶ ᾠδαῖς πνευματικαῖς*) St Paul also, in the 14th chapter of the first epistle to the Corinthians, speaks of singing (*ψαλλῶ*) and of every man's psalm (*ἕκαστος ὑμῶν ψαλλῶν ἑξει*), in a context which plainly has reference to the assemblies of the Corinthian Christians for common worship. All the words thus used were applied by the LXX. to the Davidical psalms; it is therefore possible that these only may be intended, in the different places to which we have referred. But there are in St Paul's epistles several passages (Eph. v. 14; 1 Tim. iii. 16; 1 Tim. vi. 15, 16; 2 Tim. ii. 11, 12) which have so much of the form and character of later Oriental hymnody as to have been supposed by Michaelis and others to be extracts from original hymns of the Apostolic age. Two of them are apparently introduced as quotations, though not found elsewhere in the Scriptures. A third has not only rhythm, but rhyme. The thanksgiving prayer of the assembled disciples, recorded in Acts iv., is both in substance and in manner poetical;

<sup>1</sup> The history of the "hymn" naturally begins with Greece, but it may be found in some form much earlier; Assyria and Egypt have left specimens, while India has the Vedic hymns, and Confucius collected "praise songs" in China.

<sup>2</sup> See GREEK LITERATURE.

and in the canticles, "Magnificat," "Benedictus," &c., which manifestly followed the form and style of Hebrew poetry, hymns or songs, proper for liturgical use, have always been recognized by the church.

3. *Eastern Church Hymnody.*—The hymn of our Lord, the precepts of the apostles, the angelic song at the nativity, and "Benedicite omnia opera" are referred to in a curious metrical prologue to the hymnary of the Mozarabic Breviary as precedents for the practice of the Western Church. In this respect, however, the Western Church followed the Eastern, in which hymnody prevailed from the earliest times.

Philo describes the Therapeutae (*q.v.*) of the neighbourhood of Alexandria as composers of original hymns, which (as well as old) were sung at their great religious festivals—the people listening in silence till they came to the closing strains, or refrains, at the end of a hymn or stanza (the "acrotelutia" and "epymnia"), in which all, women as well as men, heartily joined. These songs, he says, were in various metres (for which he uses a number of technical terms); some were choral, some not; and they were divided into variously constructed strophes or stanzas. Eusebius, who thought that the Therapeutae were communities of Christians, says that the Christian practice of his own day was in exact accordance with this description.

The practice, not only of singing hymns, but of singing them antiphonally, appears, from the well-known letter of Pliny to Trajan, to have been established in the Bithynian churches at the beginning of the 2nd century. They were accustomed "stato die ante lucem convenire, carmenque Christo, quasi Deo, dicere *secum invicem*."

This agrees well, in point of time, with the tradition recorded by the historian Socrates, that Ignatius (who suffered martyrdom about A.D. 107) was led by a vision or dream of angels singing hymns in that manner to the Holy Trinity to introduce antiphonal singing into the church of Antioch, from which it quickly spread to other churches. There seems to be an allusion to choral singing in the epistle of Ignatius himself to the Romans, where he exhorts them, "*χοροῖς γεινόμενοι*" ("having formed themselves into a choir"), to "sing praise to the Father in Christ Jesus." A statement of Theodoret has sometimes been supposed to refer the origin of antiphonal singing to a much later date; but this seems to relate only to the singing of Old Testament Psalms (*τῆν Δαυιδικῶν μελοδία*), the alternate chanting of which, by a choir divided into two parts, was (according to that statement) first introduced into the church of Antioch by two monks famous in the history of their time, Flavianus and Diodorus, under the emperor Constantius II.

Other evidence of the use of hymns in the 2nd century is contained in a fragment of Caius, preserved by Eusebius, which refers to "all the psalms and odes written by faithful brethren from the beginning," as "hymning Christ, the Word of God, as God." Tertullian also, in his description of the "Agapae," or love-feasts, of his day, says that, after washing hands and bringing in lights, each man was invited to come forward and sing to God's praise something either taken from the Scriptures or of his own composition ("ut quisque de Sacris Scripturis vel proprio ingenio potest"). George Bull, bishop of St David's, believed one of those primitive compositions to be the hymn appended by Clement of Alexandria to his *Paedagogus*; and Archbishop Ussher considered the ancient morning and evening hymns, of which the use was enjoined by the *Apostolical Constitutions*, and which are also mentioned in the "Tract on Virginity" printed with the works of St Athanasius, and in St Basil's treatise upon the Holy Spirit, to belong to the same family. Clement's hymn, in a short anapaestic metre, beginning *στῆμιον πόλων ἀδάων* (or, according to some editions, *βασιλεῦ ἁγίων, λόγε παρθαμάτωρ*—translated by the Rev. A. Chatfield, "O Thou, the King of Saints, all-conquering Word"), is rapid, spirited and well-adapted for singing. The Greek "Morning Hymn" (which, as divided into verses by Archbishop Ussher in his treatise *De Symbolis*, has a majestic rhythm, resembling a choric or dithyrambic strophe) is the

original form of "Gloria in Excelsis," still said or sung, with some variations, in all branches of the church which have not relinquished the use of liturgies. The Latin form of this hymn (of which that in the English communion office is an exact translation) is said, by Bede and other ancient writers, to have been brought into use at Rome by Pope Telesphorus, as early as the time of the emperor Hadrian. A third, the Vesper or "Lamp-lighting" hymn ("*φῶς Παρόν ἁγίας ὁδῶν*"—translated by Canon Bright "Light of Gladness, Beam Divine"), holds its place to this day in the services of the Greek rite. In the 3rd century Origen seems to have had in his mind the words of some other hymns or hymn of like character, when he says (in his treatise *Against Celsus*): "We glorify in hymns God and His only begotten Son; as do also the Sun, the Moon, the Stars and all the host of heaven. All these, in one Divine chorus, with the just among men, glorify in hymns God who is over all, and His only begotten Son." So highly were these compositions esteemed in the Syrian churches that the council which deposed Paul of Samosata from the see of Antioch in the time of Aurelian justified that act, in its synodical letter to the bishops of Rome and Alexandria, on this ground (among others) that he had prohibited the use of hymns of that kind, by uninspired writers, addressed to Christ.

After the conversion of Constantine, the progress of hymnody became closely connected with church controversies. There had been in Edessa, at the end of the 2nd or early in the 3rd century, a Gnostic writer of conspicuous ability, named Bardesanes, who was succeeded, as the head of his sect or school, by his son Harmonius. Both father and son wrote hymns, and set them to agreeable melodies, which acquired, and in the 4th century still retained, much local popularity. Ephraem Syrus, the first voluminous hymn-writer whose works remain to us, thinking that the same melodies might be made useful to the faith, if adapted to more orthodox words, composed to them a large number of hymns in the Syriac language, principally in tetrasyllabic, pentasyllabic and heptasyllabic metres, divided into strophes of from 4 to 12, 16 and even 20 lines each. When a strophe contained five lines, the fifth was generally an "epymnium," detached in sense, and consisting of a prayer, invocation, doxology or the like, to be sung antiphonally, either in full chorus or by a separate part of the choir. The *Syriac Chrestomathy* of August Hahn (Leipzig, 1825), and the third volume of H. A. Daniel's *Thesaurus Hymnologicus* (Leipzig, 1841-1856), contain specimens of these hymns. Some of them have been translated into (unmetrical) English by the Rev. Henry Burgess (*Select Metrical Hymns of Ephrem Syrus, &c.*, 1853). A considerable number of those so translated are on subjects connected with death, resurrection, judgment, &c., and display not only Christian faith and hope, but much simplicity and tenderness of natural feeling. Theodoret speaks of the spiritual songs of Ephraem as very sweet and profitable, and as adding much, in his (Theodoret's) time, to the brightness of the commemorations of martyrs in the Syrian Church.

The Greek hymnody contemporary with Ephraem followed, with some licence, classical models. One of its favourite metres was the Anacreontic; but it also made use of the short anapaestic, Ionic, iambic and other lyrical measures, as well as the hexameter and pentameter. Its principal authors were Methodius, bishop of Olympus, who died about A.D. 311, Synesius, who became bishop of Ptolemais in Cyrenaica in 410, and Gregory Nazianzen, for a short time (380-381) patriarch of Constantinople. The merits of these writers have been perhaps, too much depreciated by the admirers of the later Greek "Melodists." They have found an able English translator in the Rev. Allen Chatfield (*Songs and Hymns of Earliest Greek Christian Poets*, London, 1876). Among the most striking of their works are *μυθεῖο Χριστέ* ("Lord Jesus, think of me"), by Synesius; *εἰ τὸν ἄβιθον μονάρχην* ("O Thou, the One Supreme") and *εἰ σοὶ θέλω γενέσθαι* ("O soul of mine, repining"), by Gregory; also *ἄνωθεν παρθένου* ("The Bridgroom cometh"), by Methodius. There continued to be Greek metrical hymn-writers, in a similar style, till a much later date. Sophronius, patriarch of Jerusalem

in the 7th century, wrote seven Anacreontic hymns; and St John Damascene, one of the most copious of the second school of "Melodists," was also the author of some long compositions in trimeter iambs.

An important development of hymnody at Constantinople arose out of the Arian controversy. Early in the 4th century

**Period of Arian controversy.** Athanasius had rebuked, not only the doctrine of Arius, but the light character of certain hymns by which he endeavored to make that doctrine popular. When, towards the close of that century (398), St John Chrysostom was raised to the metropolitan see, the Arians, who were still numerous at Constantinople, had no places of worship within the walls; but they were in the habit of coming into the city at sunset on Saturdays, Sundays and the greater festivals, and congregating in the porticoes and other places of public resort, where they sung, all night through, antiphonal songs, with "acroteleutia" (closing strains, or refrains), expressive of Arian doctrine, often accompanied by taunts and insults to the orthodox. Chrysostom was apprehensive that this music might draw some of the simpler church people to the Arian side; he therefore organized, in opposition to it, under the patronage and at the cost of Eudoxia, the empress of Arcadius (then his friend), a system of nightly professional hymn-singing, with silver crosses, wax-lights and other circumstances of ceremonial pomp. Riots followed, with bloodshed on both sides, and with some personal injury to the empress's chief eunuch, who seems to have officiated as conductor or director of the church musicians. This led to the suppression, by an imperial edict, of all public Arian singing; while in the church the practice of nocturnal hymn-singing on certain solemn occasions, thus first introduced, remained an established institution.

It is not improbable that some rudiments of the peculiar system of hymnody which now prevails throughout the Greek

**Greek system of hymnody.** communion, and whose affinities are rather to the Hebrew and Syriac than to the classical forms, may have existed in the church of Constantinople, even at that time. Anatolius, patriarch of Constantinople

in the middle of the 5th century, was the precursor of that system; but the reputation of being its proper founder belongs to Romanos, of whom little more is known than that he wrote hymns still extant, and lived towards the end of that century. The importance of that system in the services of the Greek church may be understood from the fact that Dr J. M. Neale computed four-fifths of the whole space (about 5000 pages) contained in the different service-books of that church to be occupied by hymnody, all in a language or dialect which has ceased to be anywhere spoken.

The system has a peculiar technical terminology, in which the words "troparion," "ode," "canon" and "hirmus" (*ἱρμους*) chiefly require explanation.

The *troparion* is the unit of the system, being a strophe or stanza, seen, when analysed, to be divisible into verses or clauses, with regulated caesuras, but printed in the books as a single prose sentence, without marking any divisions. The following (turned into English, from a "canon" by John Mauropous) may be taken as an example: "The never-sleeping Guardian, | the patron of my soul, | the guide of my life, | allotted me by God, | | hymn thee, Divine Angel | of Almighty God." Dr Neale and most other writers regard all these "troparia" as rhythmical or modulated prose. Cardinal J. B. Pitra, on the other hand, who in 1867 and 1876 published two learned works on this subject, maintains that they are really metrical, and governed by definite rules of prosody, of which he lays down sixteen. According to him, each "troparion" contains from three to thirty-three verses; each verse varies from two to thirteen syllables, often in a continuous series, uniform, alternate or reciprocal, the metre being always syllabic, and depending, not on the quantity of vowels or the position of consonants, but on an harmonic series of accents.

In various parts of the services solitary troparia are sung, under various names, "contaction," "oecos," "cathisma," &c., which mark distinctions either in their character or in their use.

An *ode* is a song or hymn compounded of several similar "troparia,"—usually three, four or five. To these is always prefixed a typical or standard "troparion," called the *hirmus*, by which the syllabic measure, the periodic series of accents, and in fact the whole structure and rhythm of the stanzas which follow it are regulated. Each succeeding "troparion" in the same "ode" contains the same number of verses, and of syllables in each verse, and similar accents

on the same or equivalent syllables. The "hirmus" may either form the first stanza of the "ode" itself, or (as is more frequently the case) may be taken from some other piece; and, when so taken, it is often indicated by initial words only, without being printed at length. It is generally printed within commas, after the proper rubric of the "ode." A hymn in irregular "stichera" or stanzas, without a "hirmus," is called "idiomelon." A system of three or four odes is "tridion" or "tetradion."

A *canon* is a system of eight (theoretically nine) connected odes, the second being always suppressed. Various pauses, relieved by the interposition of other short chants or readings, occur during the singing of a whole "canon." The final "troparion" in each ode of the series is not unfrequently detached in sense (like the "epiphymia" of Ephraem Syrus), particularly when it is of the very common form of a "theotokion," or ascription of praise to the mother of our Lord, and when it is a recurring refrain or burden.

There were two principal periods of Greek hymnography constructed on these principles—the first that of Romanos and his followers, extending over the 6th and 7th centuries, the second that of the schools which arose during the Iconoclastic controversy in the 8th century, and which continued for some centuries afterwards, until the art itself died out.

The works of the writers of the former period were collected in *Tropologia*, or church hymn-books, which were held in high esteem till the 10th century, when they ceased to be regarded as church-books, and so fell into neglect. **School of Romanos.** They are now preserved only in a very small number

of manuscripts. From three of these, belonging to public libraries at Moscow, Turin and Rome, Cardinal Pitra has printed, in his *Analecta*, a number of interesting examples, the existence of which appears to have been unknown to Dr Neale, and which, in the cardinal's estimation, are in many respects superior to the "canons," &c., of the modern Greek service-books, from which all Neale's translations (except some from Anatolius) are taken. Cardinal Pitra's selections include twenty-nine works by Romanos, and some by Sergius, and nine other known, as well as some unknown, authors. He describes them as having generally a more dramatic character than the "melodies" of the later period, and a much more animated style; and he supposes that they may have been originally sung with dramatic accompaniments, by way of substitution for the theatrical performances of Pagan times. As an instance of their peculiar character, he mentions a Christmas or Epiphany hymn by Romanos, in twenty-five long strophes, in which there is, first, an account of the Nativity and its accompanying wonders, and then a dialogue between the wise men, the Virgin mother and Joseph. The magi arrive, are admitted, describe the moral and religious condition of Persia and the East, and the cause and adventures of their journey, and then offer their gifts. The Virgin intercedes for them with her Son, instructs them in some parts of Jewish history, and ends with a prayer for the salvation of the world.

The controversies and persecutions of the 8th and succeeding centuries turned the thoughts of the "melodists" of the great monasteries of the Studium at Constantinople and St Saba in Palestine and their followers, and those of the adherents of the Greek rite in Sicily and South Italy (who suffered much from the Saracens and the Normans), into a less picturesque but more strictly theological course; and the influence of those controversies, in which the final success of the cause of "Icons" was largely due to the hymns, as well as to the courage and sufferings, of these confessors, was probably the cause of their supplanting, as they did, the works of the older school. Cardinal Pitra gives them the praise of having discovered a graver and more solemn style of chant, and of having done much to fix the dogmatic theology of their church upon its present lines of near approach to the Roman.

Among the "melodists" of this latter Greek school there were many saints of the Greek church, several patriarchs and two emperors—Leo the Philosopher, and Constantine Porphyrogenitus, his son. Their greatest poets were Theodore and Joseph of the Studium, and Cosmas and John (called Damascene) of St Saba. Neale translated into English verse several selected portions, or centos, from the works of these and others, together with four selections from earlier works by

Anatolius. Some of his translations—particularly "The day is past and over," from Anatolius, and "Christian, dost thou see them," from Andrew of Crete—have been adopted into hymn-books used in many English churches; and the hymn "Art thou weary," which is rather founded upon than translated from one by Stephen the Sabaita, has obtained still more general popularity.

4. *Western Church Hymnody*.—It was not till the 4th century that Greek hymnody was imitated in the West, where its introduction was due to two great lights of the Latin Church—St Hilary of Poitiers and St Ambrose of Milan.

Hilary was banished from his see of Poitiers in 356, and was absent from it for about four years, which he spent in Asia Minor, taking part during that time in one of the councils of the Eastern Church. He thus had full opportunity of becoming acquainted with the Greek church music of that day; and he wrote (as St Jerome, who was thirty years old when Hilary died, and who was well acquainted with his acts and writings, and spent some time in or near his diocese, informs us) a "book of hymns," to one of which Jerome particularly refers, in the preface to the second book of his own commentary on the epistle to the Galatians. Isidore, archbishop of Seville, who presided over the fourth council of Toledo, in his book on the offices of the church, speaks of Hilary as the first Latin hymn-writer; that council itself, in its 13th canon, and the prologue to the Mozarabic hymnary (which is little more than a versification of the canon), associate his name, in this respect, with that of Ambrose. A tradition, ancient and widely spread, ascribed to him the authorship of the remarkable "Hymnum dicat turba fratrum, hymnum cantus personet" ("Band of brethren, raise the hymn, let your song the hymn resound"), which is a succinct narrative, in hymnal form, of the whole gospel history; and is perhaps the earliest example of a strictly didactic hymn. Both Bede and Hincmar much admired this composition, though the former does not mention, in connexion with it, the name of Hilary. The private use of hymns of such a character by Christians in the West may probably have preceded their ecclesiastical use; for Jerome says that in his day those who went into the fields might hear "the ploughman at his hallelujahs, the mower at his hymns, and the vine-dresser singing David's psalms." Besides this, seven shorter metrical hymns attributed to Hilary are still extant.

Of the part taken by Ambrose, not long after Hilary's death, in bringing the use of hymns into the church of Milan, we have a contemporary account from his convert, St Augustine.

**Ambrose.** Justina, mother of the emperor Valentinian, favoured the Arians, and desired to remove Ambrose from his see. The "devout people," of whom Augustine's mother, Monica, was one, combined to protect him, and kept guard in the church. "Then," says Augustine, "it was first appointed that, after the manner of the Eastern churches, hymns and psalms should be sung, lest the people should grow weary and faint through sorrow; which custom has ever since been retained, and has been followed by almost all congregations in other parts of the world." He describes himself as moved to tears by the sweetness of these "hymns and canticles":—"The voices flowed into my ears; the truth distilled into my heart; I overflowed with devout affections, and was happy." To this time, according to an uncertain but not improbable tradition which ascribed the composition of the "Te Deum" to Ambrose, and connected it with the conversion of Augustine, is to be referred the commencement of the use in the church of that sublime unmetrical hymn.

It is not, however, to be assumed that the hymnody thus introduced by Ambrose was from the first used according to the precise order and method of the later Western ritual. To bring it into (substantially) that order and method appears to have been the work of St Benedict. Walafrid Strabo, the earliest ecclesiastical writer on this subject (who lived at the beginning of the 9th century), says that Benedict, on the constitution of the religious order known by his name (about 530), appointed the Ambrosian hymns to be regularly sung in his offices for the

canonical hours. Hence probably originated the practice of the Italian churches, and of others which followed their example, to sing certain hymns (Ambrosian, or by the early successors of the Ambrosian school) daily throughout the week, at "Vespers," "Lauds" and "Nocturns," and on some days at "Compline" also—varying them with the different ecclesiastical seasons and festivals, commemorations of saints and martyrs and other special offices. Different dioceses and religious houses had their own peculiarities of ritual, including such hymns as were approved by their several bishops or ecclesiastical superiors, varying in detail, but all following the same general method. The national rituals, which were first reduced into a form substantially like that which has since prevailed, were probably those of Lombardy and of Spain, now known as the "Ambrosian" and the "Mozarabic." The age and origin of the Spanish ritual are uncertain, but it is mentioned in the 7th century by Isidore, bishop of Seville. It contained a copious hymnary, the original form of which may be regarded as canonically approved by the fourth council of Toledo (633). By the 13th canon of that council, an opinion (which even then found advocates) against the use in churches of any hymns not taken from the Scriptures—apparently the same opinion which had been held by Paul of Samosata—was censured; and it was ordered that such hymns should be used in the Spanish as well as in the Gallican churches, the penalty of excommunication being denounced against all who might presume to reject them.

The hymns of which the use was thus established and authorized were those which entered into the daily and other offices of the church, afterwards collected in the "Breviaries"; in which the hymns "proper" for "the week," and for "the season," continued for many centuries, with very few exceptions, to be derived from the earliest epoch of Latin Church poetry—reckoning that epoch as extending from Hilary and Ambrose to the end of the pontificate of Gregory the Great. The "Ambrosian" music, to which those hymns were generally sung down to the time of Gregory, was more popular and congregational than the "Gregorian," which then came into use, and afterwards prevailed. In the service of the mass it was not the general practice, before the invention of sequences in the 6th century, to sing any hymns, except some from the Scriptures esteemed canonical, such as the "Song of the Three Children" ("Benedicite omnia opera"). But to this rule there were, according to Walafrid Strabo, some occasional exceptions; particularly in the case of Paulinus, patriarch of Aquileia under Charlemagne, himself a hymn-writer, who frequently used hymns, composed by himself or others, in the eucharistic office, especially in private masses.

Some of the hymns called "Ambrosian" (nearly 100 in number) are beyond all question by Ambrose himself, and the rest probably belong to his time or to the following century. Four, those beginning "Aeternae rerum conditor" ("Dread Framer of the earth and sky"), "Deus Creator omnium" ("Maker of all things, glorious God"), "Veni Redemptor Gentium" ("Redeemer of the nations, come") and "Jam surgit hora tertia" ("Christ at this hour was crucified"), are quoted as works of Ambrose by Augustine. These, and others by the hand of the same master, have the qualities most valuable in hymns intended for congregational use. They are short and complete in themselves; easy, and at the same time elevated in their expression and rhythm; terse and masculine in thought and language; and (though sometimes criticized as deficient in theological precision) simple, pure and not technical in their rendering of the great facts and doctrines of Christianity, which they present in an objective and not a subjective manner. They have exercised a powerful influence, direct or indirect, upon many of the best works of the same kind in all succeeding generations. With the Ambrosian hymns are properly classed those of Hilary, and the contemporary works of Pope Damasus I. (who wrote two hymns in commemoration of saints), and of Prudentius, from whose *Cathemerina* ("Daily Devotions") and *Peristephana* ("Crown-songs for Martyrs"), all poems of considerable, some of great length—about twenty-eight hymns,

found in various Breviaries, were derived. Prudentius was a layman, a native of Saragossa, and it was in the Spanish ritual that his hymns were most largely used. In the Mozarabic Breviary almost the whole of one of his finest poems (from which most churches took one part only, beginning "Corde natus ex parentis") was appointed to be sung between Easter and Ascension-Day, being divided into eight or nine hymns; and on some of the commemorations of Spanish saints long poems from his *Peristephana* were recited or sung at large. He is entitled "to a high rank among Christian poets, many of the hymns taken from his works being full of fervour and sweetness, and by no means deficient in dignity or strength.

These writers were followed in the 5th and early in the 6th century by the priest Sedulius, whose reputation perhaps exceeded his merit; Elpis, a noble Roman lady (considered, by an erroneous tradition, to have been the wife of the philosophic statesman Boetius); Pope Gelasius I.; and Ennodius, bishop of Pavia.

Sedulius and Elpis wrote very little from which hymns could be extracted; but the small number taken from their compositions obtained wide popularity, and have since held their ground. Gelasius was of no great account as a hymn-writer; and the works of Ennodius appear to have been known only in Italy and Spain. The latter part of the 6th century produced Pope Gregory the Great and Venantius Fortunatus, an Italian poet, the friend of Gregory, and the favourite of Radegunda, queen of the Franks, who died (609) bishop of Poitiers. Eleven hymns of Gregory, and twelve or thirteen (mostly taken from longer poems) by Fortunatus, came into general use in the Italian, Gallican and British churches. Those of Gregory are in a style hardly distinguishable from the Ambrosian; those of Fortunatus are graceful, and sometimes vigorous. He does not, however, deserve the praise given to him by Dr Neale, of having struck out a new path in Latin hymnody. On the contrary, he may more justly be described as a disciple of the school of Prudentius, and as having affected the classical style, at least as much as any of his predecessors.

The poets of this primitive epoch, which closed with the 6th century, wrote in the old classical metres, and made use of a considerable variety of them—anaapaestic, anaeronic, hendecasyllabic, asclepiad, hexameters and pentameters and others. Gregory and some of the Ambrosian authors occasionally wrote in sapphics; but the most frequent measure was the iambic dimeter, and next to that, the trochaic. The full alcaic stanza does not appear to have been used for church purposes before the 16th century; though some of its elements were. In the greater number of these works, a general intention to conform to the rules of Roman prosody is manifest; but even those writers (like Prudentius) in whom that conformity was most decided allowed themselves much liberty of deviation from it. Other works, including some of the very earliest, and some of conspicuous merit, were of the kind described by Bede as "not metrical, nor rhythmical, &c., (as he explains the term "rhythm"), "modulated to the ear in imitation of different metres." It would be more correct to call them metrical—(e.g. still trochaic or iambic, &c.), but, according to new laws of syllabic quantity, depending entirely on accent, and not on the power of vowels or the position of consonants)—laws by which the future prosody of all modern European nations was to be governed. There are also, in the hymns of the primitive period (even in those of Ambrose), anticipations—regular, frequent and inconstant, but certainly not accidental—of another great innovation, destined to receive important developments, that of assonance or rhyme, in the final letters or syllables of verses. Archbishop Trench, in the introduction to his *Sacred Latin Poetry*, has traced the whole course of the transition from the ancient to the modern forms of versification, ascribing it to natural and necessary causes, which made such changes needful for the due development of the new forms of spiritual and intellectual life, consequent upon the conversion of the Latin-speaking nations to Christianity.

From the 6th century downwards we see this transformation making continual progress, each nation of Western Christendom adding, from time to time, to the earlier hymns in its service-books others of more recent and frequently of local origin. For these additions, the commemorations of saints, &c., as to which the devotion of one place often differed from that of another, offered especial opportunities. This process, while it promoted the development of a mediæval as distinct from the primitive style, led also to much

deterioration in the quality of hymns, of which, perhaps, some of the strongest examples may be found in a volume published in 1865 by the Irish Archaeological Society from a manuscript in the library of Trinity College, Dublin. It contains a number of hymns by Irish saints of the 6th, 7th and 8th centuries—in several instances fully rhymed, and in one mixing Erse and Latin barbarously together, as was not uncommon, at a much later date, in semi-vernacular hymns of other countries. The Mozarabic Breviary, and the collection of hymns used in the Anglo-Saxon churches, published in 1851 by the Surtees Society (chiefly from a Benedictine MS. in the college library of Durham, supplemented by other MSS. in the British Museum), supply many further illustrations of the same decline of taste—such sapphics, e.g., as the "Festum insigne prodiit coruscum" of Isidore, and the "O veneranda Trinitas laudanda" of the Anglo-Saxon books.

The early mediæval period, however, from the time of Gregory the Great to that of Hildebrand, was far from deficient in the production of good hymns, wherever learning flourished. Bede in England, and Paul "the Deacon"—the author of a fairly classical sapphic ode on St John the Baptist—in Italy, were successful followers of the Ambrosian and Gregorian styles. Eleven metrical hymns are attributed to Bede by Cassander; and there are also in one of Bede's works (*Collectanea et flores*) two rhythmical hymns of considerable length on the Day of Judgment, with the refrains "In tremendo die" and "Attende homo," both irregularly rhymed, and, in parts, not unworthy of comparison with the "Dies Irae." Paulinus, patriarch of Aquileia, contemporary with Paul, wrote rhythmical trimeter iambics in a manner peculiar to himself. Theodolph, bishop of Orleans (793-835), author of the famous processional hymn for Palm Sunday in hexameters and pentameters, "Gloria, laus, et honor tibi sit, Rex Christe Redemptor" ("Glory and honour and laud be to Thee, King Christ the Redeemer"), and Hrabanus Maurus, archbishop of Mainz, the pupil of Alcuin, and the most learned theologian of his day, enriched the church with some excellent works. Among the anonymous hymns of the same period there are three of great beauty, of which the influence may be traced in most, if not all, of the "New Jerusalem" hymns of later generations, including those of Germany and Great Britain:—"Urbs beata Hierusalem" ("Blessed city, heavenly Salem"); "Alleluia piis edite laudibus" ("Alleluias sound ye in strains of holy praise"—called, from its burden, "Alleluia perenne"); and "Alleluia dulce carmen" ("Alleluia, song of sweetness"), which, being found in Anglo-Saxon hymnaries certainly older than the Conquest, cannot be of the late date assigned to it, in his *Mediæval Hymns and Sequences*, by Neale. These were followed by the "Chorus novae Hierusalem" ("Ye Choirs of New Jerusalem") of Fulbert, bishop of Chartres. This group of hymns is remarkable for an attractive union of melody, imagination, poetical colouring and faith. It represents, perhaps, the best and highest type of the middle school, between the severe Ambrosian simplicity and the florid luxuriance of later times.

Another celebrated hymn, which belongs to the first mediæval period, is the "Veni Creator Spiritus" ("Come, Holy Ghost, our souls inspire"). The earliest recorded occasion of its use is that of a translation (898) of the relics of St **Veni Creator.** Marcellus, mentioned in the *Annals* of the Benedictine order. It has since been constantly sung throughout Western Christendom (as versions of it still are in the Church of England), as part of the appointed offices for the coronation of kings, the consecration and ordination of bishops and priests, the assembling of synods and other great ecclesiastical solemnities. It has been attributed—probably in consequence of certain corruptions in the text of Ekkehard's *Life of Notker* (a work of the 13th century)—to Charlemagne. Ekkehard wrote in the Benedictine monastery of St Gall, to which Notker belonged, with full access **Notker.** to its records; and an ignorant interpolator, regardless of chronology, added, at some later date, the word "Great" to the name of "the emperor Charles," wherever it was mentioned in that work. The biographer relates that Notker—a man of a gentle, contemplative nature, observant of all around him, and accustomed to find spiritual and poetical suggestions in common

5th and  
6th  
centuries.

6th  
century  
down-  
wards.

sights and sounds—was moved by the sound of a mill-wheel to compose his "sequence" on the Holy Spirit, "Sancti Spiritus adsit nobis gratia" ("Present with us ever be the Holy Spirit's grace"); and that, when finished, he sent it as a present to "the emperor Charles," who in return sent him back, "as the same messenger," the hymn "Veni Creator," which (says Ekkehard) the same "Spirit had inspired him to write" ("Sibi idem, spiritus inspiraverat"). If this story is to be credited—and, from its circumstantial and almost dramatic character, it has an air of truth—the author of "Veni Creator" was not Charlemagne, but his grandson the emperor Charles the Bald. Notker himself long survived that emperor, and died in 912.

The invention of "sequences" by Notker may be regarded as the beginning of the later medieval epoch of Latin hymnody.

In the eucharistic service, in which (as has been stated) **Sequences** hymns were not generally used, it had been the practice, except at certain seasons, to sing "laud," or "Alleluia," between the epistle and the gospel, and to fill up what would otherwise have been a long pause, by extending the cadence upon the two final vowels of the "Alleluia" into a protracted strain of music. It occurred to Notker that, while preserving the spirit of that part of the service, the monotony of the interval might be relieved by introducing at that point a chant of praise specially composed for the purpose. With that view he produced the peculiar species of rhythmical composition which obtained the name of "sequentia" (probably from following after the close of the "Alleluia"), and also that of "prosa," because its structure was originally irregular and unmetrical, resembling in this respect the Greek "troparia," and the "Te Deum," "Benedicite" and canticles. That it was in some measure suggested by the forms of the later Greek hymnody seems probable, both from the intercourse (at that time frequent) between the Eastern and Western churches, and from the application by Ekkehard, in his biography and elsewhere (e.g. in Lyndwood's *Provinciale*), of some technical terms, borrowed from the Greek terminology, to works of Notker and his school and to books containing them.

Dr Neale, in a learned dissertation prefixed to his collection of sequences from medieval Missals, and enlarged in a Latin letter to H. A. Daniel (printed in the fifth volume of Daniel's *Thesaurus hymnologicus*), investigated the laws of caesura and modulation which are discoverable in these works. Those first brought into use were sent by their author to Pope Nicholas I., who authorized their use, and that of others composed after the same model by other brethren of St Gall, in all churches of the West.

Although the sequences of Notker and his school, which then rapidly passed into most German, French and British Missals, were not metrical, the art of "assonance" was much practised in them. Many of those in the Sarum and French Missals have every verse, and even every clause or division of a verse, ending with the same vowel "a"—perhaps with some reference to the terminal letter of "Alleluia." Artifices such as these naturally led the way to the adaptation of the same kind of composition to regular metre and fully developed rhyme. Neale's full and large collection, and the second volume of Daniel's *Thesaurus*, contain numerous examples, both of the "proses," properly so called, of the Notkerian type, and of those of the later school, which (from the religious house to which its chief writer belonged) has been called "Victorine." Most Missals appear to have contained some of both kinds. In the majority of those from which Neale's specimens are taken, the metrical kind largely prevailed; but in some (e.g. those of Sarum and Liège) the greater number were Notkerian.

Of the sequence on the Holy Ghost, sent by Notker (according to Ekkehard) to Charles the Bald, Neale says that it "was in use all over Europe, even in those countries, like Italy and Spain, which usually rejected sequences"; and that, "in the Missal of Palencia, the priest was ordered to hold a white dove in his hands, while intoning the first syllables, and then to let it go." Another of the most remarkable of Notker's sequences, beginning "Media in vita" ("In the midst of life we are in death"), is said to have been suggested to him while observing some workmen engaged in the construction of a bridge over a torrent near his monastery. Catherine Winkworth (*Christian Singers of Germany*, 1860) states that this was long used as a battle-song, until the custom was forbidden, on account of its being supposed to exercise a magical influence. A translation of it ("Mitten wir im Leben sind") is one of Luther's funeral hymns; and all but the opening sentence of that part of the burial service

of the Church of England which is directed to be "said or sung" at the grave, "while the corpse is made ready to be laid into the earth," is taken from it.

The "Golden Sequence," "Veni, sancte Spiritus" ("Holy Spirit, Lord of Light"), is an early example of the transition of sequences from a simply rhythmical to a metrical form. Archbishop Trench, who esteemed it "the loveliest of all the hymns in the whole circle of Latin sacred poetry," inclined to give credit to a tradition which ascribes its authorship to Robert II., king of France, son of Hugh Capet. Others have assigned to it a later date—some attributing it to Pope Innocent III., and some to Stephen Langton, archbishop of Canterbury. Many translations, in German, English and other languages, attest its merit. Berengarius of Tours, St Bernard of Clairvaux and Abelard, in the 11th century and early in the 12th, followed in the same track; and the art of the Victorine school was carried to its greatest perfection by Adam of St Victor (who died between 1173 and 1194)—"the most fertile, and" (in the concurrent judgment of Archbishop Trench and Neale) "the greatest of the Latin hymnographers of the Middle Ages." The archbishop's selection contains many excellent specimens of his works.

But the two most widely celebrated of all this class of compositions—works which have exercised the talents of the greatest musical composers, and of innumerable **Dies Irae** translators in almost all languages—are the "Dies Irae" ("That day of wrath, that dreadful day"), by Thomas of Celano, the companion and biographer of St Francis of Assisi, and the "Stabat Mater dolorosa" ("By the cross sad vigil keeping") of Jacopone, or Jacobus de **Stabat Mater** Benedictis, a Franciscan humorist and reformer, who was persecuted by Pope Boniface VIII. for his satires on the prelate of the time, and died in 1306. Besides these, the 13th century produced the famous sequence "Lauda Sion salvatorem" ("Sion, lift thy voice and sing"), and the four other well-known sacramental hymns of St Thomas Aquinas, viz. "Pange lingua gloriosi corporis mysterium" ("Sing, my tongue, the Saviour's glory"), "Verbum supernum prodiens" ("The Word, descending from above"—not to be confounded with the Ambrosian hymn from which it borrowed the first line), "Sacris solemniis juncta sint gaudia" ("Let us with hearts renewed our grateful homage pay"), and "Adoro Te devote, latens Deitas" ("O Godhead hid, devoutly I adore Thee")—a group of remarkable compositions, written by him for the then new festival of Corpus Christi, of which he induced Pope Urban IV. (1261-1265) to decree the observance. In these (of which all but "Adoro Te devote" passed rapidly into breviaries and missals) the doctrine of transubstantiation is set forth with a wonderful degree of scholastic precision; and they exercised, probably, a not unimportant influence upon the general reception of that dogma. They are undoubtedly works of genius, powerful in thought, feeling and expression.

These and other medieval hymn-writers of the 12th and 13th centuries may be described, generally, as poet-schoolmen. Their tone is contemplative, didactic, theological; they are especially fertile and ingenious in the field **Medieval Hymns** of mystical interpretation. Two great monasteries in the East had, in the 8th and 9th centuries, been the principal centres of Greek hymnology; and, in the West, three monasteries—St Gall, near Constance (which was long the especial seat of German religious literature), Cluny in Burgundy and St Victor, near Paris—obtained a similar distinction. St Gall produced, besides Notker, several distinguished sequence writers, probably his pupils—Hartmann, Hermann and Gottschalk—to the last of whom Neale ascribes the "Alleluistic Sequence" ("Cantemus uncti melodum nunc Alleluia"), well known in England through his translation, "The strain upraise of joy and praise." The chief poets of Cluny were two of its abbots, Odo and Peter the Venerable (1122-1156), and one of Peter's monks, Bernard of Morlaix, who wrote the remarkable poem on "Contempt of the World" in about 3000 long rolling "leonine-dactylic" verses, from parts of which Neale's popular hymns, "Jerusalem



Belgium, and pastor in Holstein, have been thought worthy of a place in Archbishop Trench's selection. Two by W. Petersen (printed at the end of Haberkorn's supplement to Jacobi's *Psalmodia Germanica*), are good in different ways—one, "Jesu dulcis amor meus" ("Jesus, Thy my soul doth love"), being a gentle melody of spiritual devotion, and the other, entitled *Spes Sionis*, violently controversial against Rome. An English hymn of the 17th century, in the Ambrosian style, "Te Deum Patrem colimus" ("Almighty Father, just and good"), is sung on every May-Day morning by the choristers of Magdalen College, Oxford, from the top of the tower of their chapel; and another in the style of the Renaissance, of about the same date, "Te de profundis, summe Rex" ("Thee from the depths, Almighty King), long formed part of a grace formerly sung by the scholars of Winchester College.

5. *German Hymnody.*—Luther was a proficient in and a lover of music. He said in the preface to his hymn-book of 1543 that this "beautiful ornament" might "in a right manner serve the great Creator and His Christian people." The persecuted Bohemian or Hussite Church, then settled on the borders of Moravia under the name of "United Brethren," had sent to him, on a mission in 1522, Michael Weiss, who not long afterwards published a number of German translations from old Bohemian hymns (known as those of the "Bohemian Brethren"), with some of his own. These Luther highly approved and recommended. He himself, in 1522, published a small volume of eight hymns, which was enlarged to 63 in 1527, and to 125 in 1545. He had formed what he called a "house choir" of musical friends, to select such old and popular tunes (whether secular or ecclesiastical) as might be found suitable, and to compose new melodies, for church use. His fellow labourers in this field (besides Weiss) were Justus Jonas, his own especial colleague; Paul Eber, the disciple and friend of Melancthon; John Walther, choirmaster successively to several German princes, and professor of arts, &c., at Wittenberg; Nicholas Decius, who from a monk became a Protestant teacher in Brunswick, and translated the "Gloria in Excelsis," &c.; and Paul Speratus, chaplain to Duke Albert of Prussia in 1525. Some of their works are still popular in Germany. Weiss's "Funeral Hymn," "Nun lasst uns den Leib begraben" ("Now lay we calmly in the grave"); Eber's "Herr Jesu Christ, wahr Mensch und Gott" ("Lord Jesus Christ, true Man and God"), and "Wenn wir in höchsten Nöthen sein" ("When in the hour of utmost need"); Walther's "New Heavens and new Earth" ("Now fain my joyous heart would sing"); Decius's "To God on high be thanks and praise"; and Speratus's "Salvation now has come for all," are among those which at the time produced the greatest effect, and are still best remembered.

Luther's own hymns, thirty-seven in number (of which about twelve are translations or adaptations from Latin originals), are for the principal Christian seasons; on the sacraments, the church, grace, death, &c.; and paraphrases of seven psalms, of a passage in Isaiah, and of the Lord's Prayer, Ten Commandments, Creed, Litany and "Te Deum." There is also a very touching and stirring song on the martyrdom of two youths by fire at Brussels, in 1523-1524. Homely and sometimes rugged in form, and for the most part objective in tone, they are full of fire, mainly simplicity and strong faith. Three rise above the rest. One for Christmas, "Vom Himmel hoch da komm ich her" ("From Heaven above to earth I come"), has a reverent tenderness, the influence of which may be traced in many later productions on the same subject. That on salvation through Christ, of a didactic character, "Nun freuet euch, lieben Christen g'mein" ("Dear Christian people, now rejoice"), is said to have made many conversions, and to have been once taken up by a large congregation to silence a Roman Catholic preacher in the cathedral of Frankfurt. Pre-eminent above all is the celebrated paraphrase of the 46th Psalm: "Ein' feste Burg ist unser Gott" ("A sure stronghold our God is He")—"the production" (as Ranke says) "of the moment in which Luther, engaged in a conflict with a world of foes, sought strength in the consciousness that he was defending a divine cause which could never perish." Carlyle compares it to "a sound of Alpine avalanches, or the first murmur of earthquakes." Heine called it "the Marseillaise of the Reformation."

Luther spent several years in teaching his people at Wittenberg to sing these hymns, which soon spread over Germany. Without adopting the hyperbolic saying of Coleridge, that "Luther did as much for the Reformation by his hymns as by his translation of the Bible," it may truly be affirmed that, among the secondary means by which the success of the Reformation was promoted, none was more powerful. They were sung everywhere—in the streets and fields as well as the churches, in the workshop and the palace, "by children in the cottage and by martyrs on the scaffold." It was by them that a congregational character was given to the new Protestant worship. This success they owed partly to their metrical structure, which, though sometimes complex, was recommended to the people by its ease and variety; and partly to the tunes and melodies (many of them already well known and popular) to which they were set. They were used as direct instruments of teaching, and were therefore, in a large measure, didactic and theological; and it may be partly owing to this cause that German hymnody came to deviate, so soon and so generally as it did, from the simple idea expressed in the ancient Augustinian definition, and to comprehend large classes of compositions which, in most other countries, would be thought hardly suitable for church use.

The principal hymn-writers of the Lutheran school, in the latter part of the 16th century, were Nikolaus Selnecker, Herman and Hans Sachs, the shoemaker of Nuremberg, also known in other branches of literature. Followers of Luther. They wrote some good hymns. They were succeeded by men of another sort, to whom F. A. Cunz gives the name of "master-singers," as having raised both the poetical and the musical standard of German hymnody.—Bartholomäus Ringwaldt, Ludwig Helmbold, Johannes Pappus, Martin Schalling, Rutilius and Sigismund Weingartner. The principal topics of their hymns (as if with some foretaste of the calamities which were soon to follow) were the vanity of earthly things, resignation to the Divine will, and preparation for death and judgment. The well-known English hymn, "Great God, what do I see and hear," is founded upon one by Ringwaldt. Of a quite different character were two of great beauty and universal popularity, composed by Philip Nicolai, a Westphalian pastor, during a pestilence in 1597, and published by him, with fine chorales, two years afterwards. One of these (the "Sleepers wake! a voice is calling," of Mendelssohn's oratorio, *St Paul*) belongs to the family of Advent or New Jerusalem hymns. The other, a "Song of the believing soul concerning the Heavenly Bridegroom" ("Wie schön leucht' uns der Morgenstern"—"O morning Star, how fair and bright"), became the favourite marriage hymn of Germany.

The hymns produced during the Thirty Years' War are characteristic of that unhappy time, which (as Miss Winkworth says) "caused religious men to look away from this world," Period of Thirty Years' War. and made their songs more and more expressive of personal feelings. In point of refinement and graces of style, the hymn-writers of this period excelled their predecessors. Their taste was chiefly formed by the influence of Martin Opitz, the founder of what has been called the "first Silesian school" of German poetry, who died comparatively young in 1639, and who, though not of any great original genius, exercised much power as a critic. Some of the best of these works were by men who wrote little. In the famous battle-song of Gustavus Adolphus, published (1631) after the victory of Breitenfeld, for the use of his army, "Verzage nicht du Häuflein klein" ("Fear not, O little flock, the foe"), we have almost certainly a composition of the hero-king himself, the versification corrected by his chaplain Jakob Fabricius (1593-1654) and the music composed by Michael Altenburg, whose name has been given to the hymn. This, with Luther's paraphrase of the 67th Psalm, was sung by Gustavus and his soldiers before the battle of Lützen in 1632. Two very fine hymns, one of prayer for deliverance and peace, the other of trust in God under calamities, were written about the same time by Matthäus Löwenstern, a saddler's son, poet, musician and statesman, who was ennobled after the peace by the emperor



Ferdinand III. Martin Rinckhart, in 1636, wrote the "Chorus of God's faithful children" ("Nun danket alle Gott"—"Now thank we all our God"), introduced by Mendelssohn in his "Lobgesang," which has been called the "Te Deum" of Germany, being usually sung on occasions of public thanksgiving. Weissel, in 1635, composed a beautiful Advent hymn ("Lift up your heads, ye mighty gates"), and J. M. Meyfahrt, professor of theology at Erfurt, in 1642, a fine adaptation of the ancient "Urbs beata Hierusalem." The hymn of trust in Providence by George Neumark, librarian to that duke of Weimar ("Wer nur den lieben Gott lässt walten"—"Leave God to order all thy ways"), is scarcely, if at all, inferior to that of Paul Gerhardt on the same theme. Paul Flemming, a great traveller and lover of nature, who died in 1639, also wrote excellent compositions, coloured by the same tone of feeling; and some, of great merit, were composed, soon after the close of the war, by Louisa Henrietta, electress of Brandenburg, granddaughter of the famous admiral Coligny, and mother of the first king of Prussia. With these may be classed (though of later date) a few striking hymns of faith and prayer under mental anxiety, by Anton Ulrich, duke of Brunswick.

The most copious, and in their day most esteemed, hymn-writers of the first half of the 17th century, were Johann Heermann and Johann Rist. Heermann, a pastor in Silesia, the theatre (in a peculiar degree) of war and persecution, experienced in his own person a very large share of the miseries of the time, and several times narrowly escaped a violent death. His *Devoti musica cordis*, published in 1630, reflects the feelings natural under such circumstances. With a correct style and good versification, his tone is subjective, and the burden of his hymns is not praise, but prayer. Among his works (which enter largely into most German hymn-books), two of the best are the "Song of Tears" and the "Song of Comfort," translated by Miss Winkworth in her *Christian Singers of Germany*. Rist published about 600 hymns, "pressed out of him," as he said, "by the cross." He was a pastor, and son of a pastor, in Holstein, and lived after the peace to enjoy many years of prosperity, being appointed poet-laureate to the emperor and finally ennobled. The bulk of his hymns, like those of other copious writers, are of inferior quality; but some, particularly those for Advent, Epiphany, Easter Eve and on Angels, are very good. They are more objective than those of Heermann, and written, upon the whole, in a more manly spirit.

**Dach.** Next to Heermann and Rist in fertility of production, and above them in poetical genius, was Simon Dach, professor of poetry at Königsberg, who died in 1659. Miss Winkworth ranks him high among German poets, "for the sweetness of form and depth of tender contemplative emotion to be found in his verses."

The fame of all these writers was eclipsed in the latter part of the same century by three of the greatest hymnographers whom

**Gerhardt.** Germany has produced—Paul Gerhardt (1604-1676), Johann Franck (1618-1677) and Johann Scheffler (1624-1677), the founder of the "second Silesian school," who assumed the name of "Angelus Silesius." Gerhardt is by universal consent the prince of Lutheran poets. His compositions, which may be compared, in many respects, to those of the *Christian Year*, are lyric poems, of considerable length, rather than hymns, though many hymns have been taken from them. They are, with few exceptions, subjective, and speak the language of individual experience. They occupy a middle ground between the masculine simplicity of the old Lutheran style and the highly wrought religious emotion of the later pietists, towards whom they on the whole incline. Being nearly all excellent, it is not easy to distinguish among the 123 those which are entitled to the highest praise. Two, which were written one during the war and the other after the conclusion of peace, "Zeuch ein zu deinen Thoren" ("Come to Thy temple here on earth"), and "Gottlob, nun ist erschollen" ("Thank God, it hath resounded"), are historically interesting. Of the rest, one is well known and highly appreciated in English through Wesley's translation, "Commit thou all thy ways"; and the evening

and spring-tide hymns ("Now all the woods are sleeping" and "Go forth, my heart, and seek delight") show an exquisite feeling for nature; while nothing can be more tender and pathetic than "Du bist zwar mein und bleibest mein" ("Thou'rt mine, yes, still thou art mine own"), on the death of Franck's son. Franck, who was burgomaster of Guben in Lusatia, has been considered by some second only to Gerhardt. If so, it is with a great distance between them. His approach to the later pietists is closer than that of Gerhardt. His hymns were published, under the title of *Geistliche und weltliche Gedichte*, in 1674, some of them being founded on Ambrosian and other Latin originals. Miss Winkworth gives them the praise of a condensed and polished style and fervid and impassioned thought. It was after his conversion to Roman Catholicism that Scheffler adopted the name of "Angelus Silesius," and published in 1657 his hymns, under a fantastic title, and with a still more fantastic preface. Their keynote is divine love; they are enthusiastic, intense, exuberant in their sweetness, like those of St Bernard among medieval poets. An adaptation of one of them, by Wesley, "Thee will I love, my Strength, my Tower," is familiar to English readers. Those for the first Sunday after Epiphany, for Sexagesima Sunday and for Trinity Sunday, in *Lyra Germanica*, are good examples of his excellences, with few of his defects. His hymns are generally so free from the expression, or even the indirect suggestion, of Roman Catholic doctrine, that it has been supposed they were written before his conversion, though published afterwards. The evangelical churches of Germany found no difficulty in admitting them to that prominent place in their services which they have ever since retained.

Towards the end of the 17th century, a new religious school arose, to which the name of "Pietists" was given, and of which Philipp Jakob Spener was esteemed the founder. He and his pupils and successors, August Hermann **Pietists.** Francke and Anastasius Freylinghausen, all wrote hymns. Spener's hymns are not remarkable, and Francke's are not numerous. Freylinghausen was their chief singer; his rhythm is lively, his music florid; but, though his book attained extraordinary popularity, he was surpassed in solid merit by other less fertile writers of the same school. The "Auf hinauf zu deiner Freude" ("Up, yes, upward to thy gladness") of Schade may recall to an English reader a hymn by Seagrave, and more than one by Lyte; the "Malabarian hymn" (as it was called by Jacobi) of Johann Schütz, "All glory to the Sovereign Good," has been popular in England as well as Germany; and one of the most exquisite strains of pious resignation ever written is "Whate'er my God ordains is right," by Samuel Rodigast.

Joachim Neander, a schoolmaster at Düsseldorf, and a friend of Spener and Schütz (who died before the full development of the "Pietistic" school), was the first man of eminence in the "Reformed" or Calvinistic Church who imitated **Neander.** Lutheran hymnody. This he did, while suffering persecution from the elders of his own church for some other religious practices, which he had also learnt from Spener's example. As a poet, he is sometimes deficient in art; but there is feeling, warmth and sweetness in many of his "Bundeslieder" or "Songs of the Covenant," and they obtained general favour, both in the Reformed and in Lutheran congregations. The Summer Hymn ("O Thou true God alone") and that on the glory of God in creation ("Lo, heaven and earth and sea and air") are instances of his best style.

With the "Pietists" may be classed Benjamin Schmolke and Dessler, representatives of the "Orthodox" division of Spener's school; Philipp Friedrich Hiller, their leading poet in **Schmolke.** South Germany; Gottfried Arnold and Gerhard Tersteegen, who were practically independent of ecclesiastical organization, though connected, one with the "Orthodox" and the other with the "Reformed" churches; and Nikolaus Ludwig, Graf von Zinzendorf. Schmolke, a pastor in Silesia, called the Silesian Rist (1672-1737), was perhaps the most voluminous of all German hymn-writers. He wrote 1188 religious poems and hymns, a large proportion of which do not

rise above mediocrity. His style, if less refined, is also less subjective and more simple than that of most of his contemporaries. Among his best and most attractive works, which indeed, it would be difficult to praise too highly, are the "Hosianna David's Sohn," for Palm Sunday—much resembling a shorter hymn by Jeremy Taylor; and the Ascension, Whitsuntide and Sabbath hymns—"Heavenward doth our journey tend," "Come deck our feast-to-day," and "Light of light, enlighten me." Dessler was a greater poet than

**Dessler.** Schmolke. Few hymns, of the subjective kind, are better than his "I will not let Thee go, Thou Help in time of need," "O Friend of souls, how well is me," and "Now, the pearly gates unfold." Hiller (1699-1769), was a pastor in Württemberg who, falling into ill-health during the latter part of his ministry, published a *Geistliche Liederhülsen* in a didactic vein, with more taste than power, but (as Miss Winkworth says) in a tone of "deep, thoughtful, practical piety." They were so well adapted to the wants of his people that to this day Hiller's *Casket* is prized, next to their Bibles, by the peasantry of Württemberg; and the numerous emigrants from that part of Germany to America and other foreign countries generally take it with them wherever they go. Arnold, a professor at Giessen, and afterwards a pastor in Brandenburg, was a man of strong will, uncompromising character and austere views of life, intolerant and controversial towards those whose doctrine or practice he disapproved, and more indifferent to separatism and sectarianism than the "orthodox" generally thought right. His hymns, like those of Augustus M. Toplady, whom in these respects he resembled, unite with considerable strength more gentleness and breadth of sympathy than might be expected from a man of such a character. Tersteegen (1697-1769), who never formally separated himself from the "Reformed" communion, in which he was brought up, but whose sympathies were with the Moravians and with Zinzendorf, was, of all the more copious German hymn-writers after Luther, perhaps the most remarkable man. Pietist, mystic and missionary, he was also a great religious poet. His 111 hymns were published in 1731, in a volume called *Geistlicher Blumenkranzlein inniger Seelen*. They are intensely individual, meditative and subjective. Wesley's adaptations of two—"Lo! God is here; let us adore," and "Thou hidden Love of God, whose source"—are well known. Among those translated by Miss Winkworth, "O God, O Spirit, Light of all that live," and "Come, brethren, let us go," are specimens which exhibit favourably his manner and power. Miss Cox speaks of him as "a gentle heaven-inspired soul, whose hymns are the reflection of a heavenly, happy life, his mind being full of a child-like simplicity"; and his own poem on the child-character, which Miss Winkworth has appropriately connected with Innocents' day ("Dear Soul, couldst thou become a child")—one of his best compositions, exquisitely conceived and expressed—shows that this was in truth the ideal which he sought to realize. The hymns of Zinzendorf are often disfigured by excess in the application of the language and imagery of human affections to divine objects; and this blemish is also found in many later Moravian hymns. But one hymn, at least, of Zinzendorf may be mentioned with unqualified praise, as uniting the merits of force, simplicity and brevity—"Jesus, geh voran" ("Jesus, lead the way"), which is taught to most children of religious parents in Germany. Wesley's "Jesus, Thy blood and righteousness" is a translation from Zinzendorf.

The transition from Tersteegen and Zinzendorf to Gellert and Klopstock marks strongly the reaction against Pietism which took place towards the middle of the 18th century. The *Geistlichen Oden und Lieder* of Christian F. Gellert were published in 1757, and are said to have been received with an enthusiasm almost like that which "greeted Luther's hymns on their first appearance." It is a proof of the moderation both of the author and of his times that they were largely used, not only by Protestant congregations, but in those German Roman Catholic churches in which vernacular

services had been established through the influence of the emperor Joseph II. They became the model which was followed by most succeeding hymn-writers, and exceeded all others in popularity till the close of the century, when a new wave of thought was generated by the movement which produced the French Revolution. Since that time they have been, perhaps, too much depreciated. They are, indeed, cold and didactic, as compared with Scheffler or Tersteegen; but there is nevertheless in them a spirit of genuine practical piety; and, if not marked by genius, they are pure in taste, and often terse, vigorous and graceful.

Klopstock, the author of the *Messiah*, cannot be considered great as a hymn-writer, though his "Sabbath Hymn" (of which there is a version in *Hymns from the Land Klopstock of Luther*) is simple and good. Generally his hymns (ten of which are translated in Sheppard's *Foreign Sacred Lyre*) are artificial and much too elaborate.

Of the "romantic" school, which came in with the French Revolution, the two leading writers are Friedrich Leopold von Hardenberg, called "Novalis," and Friedrich de la Motte Fouqué, the celebrated author of *Undine* and *Sintram*—both romance-writers, as well as poets. The genius of Novalis was early lost to the world; he died in 1801, not thirty years old. Some of his hymns are very beautiful; but even in such works as "Though all to Thee were faithless," and "If only He is mine," there is a feeling of insulation and of despondency as to good in the actual world, which was perhaps inseparable from his ecclesiastical idealism. Fouqué survived till 1843. In his hymns there is the same deep flow of feeling, richness of imagery and charm of expression which distinguishes his prose works. The two missionary hymns—"Thou, solemn Ocean, rollst to the strand," and "In our sails all soft and sweetly"—and the exquisite composition which finds its motive in the gospel narrative of blind Bartimeus, "Was du vor tausend Jahren" (finely translated both by Miss Winkworth and by Miss Cox), are among the best examples.

The later German hymn-writers of the 19th century belong, generally, to the revived "Pietistic" school. Some of the best, Johann Baptist von Albertini, Friedrich Adolf Krummacher, and especially Karl Johann Philipp Spitta (1801-1859) have produced works not unworthy of the fame of their nation. Mr Massie, the able translator of Spitta's *Psalter und Harfe* (Leipzig, 1833), speaks of it as having "obtained for him in Germany a popularity only second to that of Paul Gerhardt." In Spitta's poems (for such they generally are, rather than hymns) the subjective and meditative tone is tempered, not ungracefully, with a didactic element; and they are not disfigured by exaggerated sentiment, or by a too florid and rhetorical style.

6. *British Hymnody*.—After the Reformation, the development of hymnody was retarded, in both parts of Great Britain, by the example and influence of Geneva. Archbishop Cranmer appears at one time to have been disposed to follow Luther's course, and to present to the people, in an English dress, some at least of the hymns of the ancient church. In a letter to King Henry VIII. (October 7, 1544), among some new "processions" which he had himself translated into English, he mentions the Easter hymn, "Salve, festa dies, toto memorabilis aevo" ("Hail, glad day, to be joyfully kept through all generations"), of Fortunatus. In the "Primer" of 1535 (by Marshall) and the one of 1539 (by Bishop Hilsey of Rochester, published by order of the vicar-general Cromwell) there had been several rude English hymns, none of them taken from ancient sources. King Henry's "Primer" of 1545 (commanded by his injunction of the 6th of May 1545 to be used throughout his dominions) was formed on the model of the daily offices of the Breviary; and it contains English metrical translations from some of the best-known Ambrosian and other early hymns. But in the succeeding reign different views prevailed. A new direction had been given to the taste of the "Reformed" congregations in France and Switzerland by the French metrical translation of the Old Testament Psalms, which appeared about 1540. This was the joint work of Clement

Marot, valet or groom of the chamber to Francis I., and Theodore Beza, then a mere youth, fresh from his studies at Orleans.

Marot's psalms were dedicated to the French king and the ladies of France, and, being set to popular airs, became fashionable. They were sung by Francis himself, the queen, the princesses and the courtiers, upon all sorts of secular occasions, and also, more seriously and religiously, by the citizens and the common people. They were soon perceived to be a power on the side of the Reformation. Calvin, who had settled at Geneva in the year of Marot's return to Paris, was then organizing his ecclesiastical system. He rejected the hymnody of the breviaries and missals, and fell back upon the idea, anciently held by Paul of Samosata, and condemned by the fourth council of Toledo, that whatever was sung in churches ought to be taken out of the Scriptures. Marot's Psalter, appearing thus opportunely, was introduced into his new system of worship, and appended to his catechism. On the other hand, it was interdicted by the Roman Catholic priesthood. Thus it became a badge to the one party of the "reformed" profession, and to the other of heresy.

The example thus set produced in England the translation commonly known as the "Old Version" of the Psalms. It was begun by Thomas Sternhold, whose position in the household of Henry VIII., and afterwards of Edward VI., was similar to that of Marot with Francis I., and whose services to the former of those kings were rewarded by a substantial legacy under his will. Sternhold published versions of nineteen Psalms, with a dedication to King Edward, and died soon afterwards. A second edition appeared in 1551, with eighteen more Psalms added, of Sternhold's translating, and seven others by John Hopkins, a Suffolk clergyman. The work was continued during Queen Mary's reign by British refugees at Geneva, the chief of whom were William Whittingham, afterwards dean of Durham, who succeeded John Knox as minister of the English congregation there, and William Kethe or Keith, said by Strype to have been a Scotsman. They published at Geneva in 1556 a service-book, containing fifty-one English metrical psalms, which number was increased, in later editions, to eighty-seven. On the accession of Queen Elizabeth, this Genevan Psalmody was at once brought into use in England—first (according to a letter of Bishop Jewel to Peter Martyr, dated 5th March 1560) in one London church, from which it quickly spread to others both in London and in other cities. Jewel describes the effect produced by large congregations, of as many as 6000 persons, young and old, women and children, singing it after the sermons at St Paul's Cross—adding, "Id sacrificios et diabolum aegre habet; vident enim sacras conciones hoc pacto profundius descendere in hominum animos." The first edition of the completed "Old Version" (containing forty Psalms by Sternhold, sixty-seven by Hopkins, fifteen by Whittingham, six by Kethe and the rest by Thomas Norton the dramatist, Robert Wisdom, John Marckant and Thomas Churchyard) appeared in 1562.

In the meantime, the Books of Common Prayer, of 1549, 1552 and 1559, had been successively established as law by the acts of uniformity of Edward VI. and Queen Elizabeth. In these no provision was made for the use of any metrical psalm or hymn on any occasion whatever, except at the consecration of bishops and the ordination of priests, in which offices (first added in 1552) an English version of "Veni Creator" (the longer of the two now in use) was appointed to be "said or sung." The canticles, "Te Deum," "Benedicite," the Nicene and Athanasian Creeds, the "Gloria in Excelsis," and some other parts of the communion and other special offices were also directed to be "said or sung"; and, by general rubrics, the chanting of the whole service was allowed.

The silence, however, of the rubrics in these books as to any other singing was not meant to exclude the use of psalms not expressly appointed, when they could be used without interfering with the prescribed order of any service. It was expressly provided by King Edward's first act of uniformity (by later acts made applicable to the later books) that it should be lawful "for all men, as well in churches, chapels, oratories or other places, to use openly any psalms or prayers taken out of the Bible, at any due time, not letting or omitting thereby the service, or any part thereof, mentioned in the book." And Queen Elizabeth, by one of the injunctions issued in the first year of her reign, declared her desire that the provision

made, "in divers collegiate and also some parish churches, for singing in the church, so as to promote the laudable service of music," should continue. After allowing the use of "a modest and distinct song in all parts of the common prayers of the church, so that the same may be as plainly understood as if it were read without singing," the injunction proceeded thus—"And yet, nevertheless, for the comforting of such that delight in music, it may be permitted that in the beginning or in the end of the Common Prayer, either at morning or evening, there may be sung a hymn, or such like song to the praise of Almighty God, in the best sort of melody and music that may be conveniently devised, having respect that the sentence" (*i.e.* sense) "of hymn may be understood and perceived."

The "Old Version," when published (by John Day, for the Stationers' Company, "cum gratia et privilegio Regiæ Majestatis"), bore upon the face of it that it was "newly set forth, and allowed to be sung of the people in churches, before and after morning and evening prayer, as also before and after the sermon." The question of its authority has been at different times much debated, chiefly by Peter Heylyn and Thomas Warton on one side (both of whom disliked and disparaged it), and by William Beveridge, bishop of St. Asaph, and the Rev. H. J. Todd on the other. Heylyn says, it was "permitted rather than allowed," which seems to be a distinction without much difference. "Allowance," which is all that the book claimed for itself, is authorization by way of permission, not of commandment. Its publication in that form could hardly have been licensed, nor could it have passed into use as it did without question, throughout the churches of England, unless it had been "allowed" by some authority then esteemed to be sufficient. Whether that authority was the royal or ecclesiastical does not appear, nor (considering the proviso in King Edward's act of uniformity, and Queen Elizabeth's injunctions) is it very important. No inference can justly be drawn from the inability of inquirers, in Heylyn's time or since, to discover any public record bearing upon this subject, many public documents of that period having been lost.

In this book, as published in 1562, and for many years afterwards, there were (besides the versified Psalms) eleven metrical versions of the "Te Deum," canticles, Lord's Prayer (the best of which is that of the "Benedicite"); and also "Da pacem, Domine," a hymn suitable to the times, rendered into English from Luther; two original hymns of praise, to be sung before morning and evening prayer; two penitential hymns (one of them the "humble lamentation of a sinner"); and a hymn of faith, beginning, "Lord, in Thee is all my trust." In these respects, and also in the tunes which accompanied the words (stated by Dr Charles Burney, in his *History of Music*, to be German, and not French), there was a departure from the Genevan platform. Some of these hymns, and some of the psalms also (*e.g.* those by Robert Wisdom, being alternative versions), were omitted at a later period; and many alterations and supposed amendments were from time to time made by unknown hands in the psalms which remained, so that the text, as now printed, is in many places different from that of 1562.

In Scotland, the General Assembly of the kirk caused to be printed at Edinburgh in 1564, and enjoined the use of, a book entitled *The Form of Prayers and Ministry of the Sacraments used in the English Church at Geneva, Scotch Psalms, approved and received by the Church of Scotland; whereof, besides that was in the former books, are also added sundry other prayers, with the whole Psalms of David in English metre.* This contained, from the "Old Version," translations of forty Psalms by Sternhold, fifteen by Whittingham, twenty-six by Kethe and thirty-five by Hopkins. Of the remainder two were by John Puleyn (one of the Genevan refugees, who became archdeacon of Colchester); six by Robert Pont, Knox's son-in-law, who was a minister of the kirk, and also a lord of session; and fourteen signed with the initials I. C., supposed to be John Craig; one was anonymous, eight were attributed to N., two to M., and one to T. N. respectively.

So matters continued in both churches until the Civil War. During the interval, King James I. conceived the project of himself making a new version of the Psalms, and appears to have translated thirty-one of them—the correction of which, together with the translation of the rest, he entrusted to Sir William Alexander, afterwards earl of Stirling. Sir William having completed his task, King Charles I. had it examined and approved by several archbishops and bishops of England, Scotland and Ireland, and caused it to be printed in 1631 at the Oxford University Press, as the work of King James; and, by an order

under the royal sign manual, recommended its use in all churches of his dominions. In 1634 he enjoined the Privy Council of Scotland not to suffer any other psalms, "of any edition whatever," to be printed in or imported into that kingdom. In 1636 it was republished, and was attached to the famous Scottish service-book, with which the troubles began in 1637. It need hardly be added that the king did not succeed in bringing this Psalter into use in either kingdom.

When the Long Parliament undertook, in 1642, the task of altering the liturgy, its attention was at the same time directed to psalmody. It had to judge between two rival translations of the Psalms—one by Francis Rouse, a member of the House of Commons, afterwards one of Cromwell's councillors and finally provost of Eton; the other by William Barton, a clergyman of Leicester. The House of Lords favoured Barton, the House of Commons Rouse, who had made much use of the labours of Sir William Alexander. Both versions were printed by order of parliament, and were referred for consideration to the Westminster Assembly. They decided in favour of Rouse. His version, as finally amended, was published in 1645, under an order of the House of Commons dated 14th November 1645. In the following year it was recommended by the parliament to the General Assembly at Edinburgh, who appointed a committee, with large powers, to prepare a revised Psalter, recommending to their consideration not only Rouse's book but that of 1564, and two other versions (by Zachary Boyd and Sir William Mure of Rowallan), then lately executed in Scotland. The result of the labours of this committee was the "Paraphrase" of the Psalms, which, in 1649-1650, by the concurrent authority of the General Assembly and the committee of estates, was ordered to be exclusively used throughout the church of Scotland. Some use was made in the preparation of this book of the versions to which the attention of the revisers had been directed, and also of Barton's; but its basis was that of Rouse. It was received in Scotland with great favour, which it has ever since retained; and it is fairly entitled to the praise of striking a tolerable medium between the rude homeliness of the "Old," and the artificial modernism of the "New" English versions—perhaps as great a success as was possible for such an undertaking. Sir Walter Scott is said to have dissuaded any attempt to alter it, and to have pronounced it, "with all its acknowledged occasional harshness, so beautiful, that any alterations must eventually prove only so many blemishes." No further step towards any authorized hymnody was taken by the kirk of Scotland till the following century.

In England, two changes bearing on church hymnody were made upon the revision of the prayer-book after the Restoration, in 1661-1662. One was the addition, in the offices for consecrating bishops and ordaining priests, of the shorter version of "Veni Creator" ("Come, Holy Ghost, our souls inspire"), as an alternative form. The other, and more important, was the insertion of the rubric after the third collect, at morning and evening prayer: "In quires and places where they sing, here followeth the anthem." By this rubric synodical and parliamentary authority was given for the interruption, at that point, of the prescribed order of the service by singing an anthem, the choice of which was left to the discretion of the minister. Those actually used, under this authority, were for some time only unmetrical passages of scripture, set to music by Blow, Purcell and other composers, of the same kind with the anthems still generally sung in cathedral and collegiate churches. But the word "anthem" had no technical significance which could be an obstacle to the use under this rubric of metrical hymns.

The "New Version" of the Psalms, by Dr Nicholas Brady and the poet-laureate Nahum Tate (both Irishmen), appeared in 1696, under the sanction of an order in council of William III., "allowing and permitting" its use "in all such churches, chapels and congregations as should think fit to receive it." Dr Compton, bishop of London, recommended it to his diocese. No hymns were then appended to it; but the authors added a "supplement" in 1703, which received an

exactly similar sanction from an order in council of Queen Anne. In that supplement there were several new versions of the canticles, and of the "Veni Creator"; a variation of the old "humble lamentation of a sinner"; six hymns for Christmas, Easter and Holy Communion (all versions or paraphrases of scripture), which are still usually printed at the end of the prayer-books containing the new version; and a hymn "on the divine use of music"—all accompanied by tunes. The authors also reprinted, with very good taste, the excellent version of the "Benedicite" which appeared in the book of 1562. Of the hymns in this "supplement," one ("While shepherds watched their flocks by night") greatly exceeded the rest in merit. It has been ascribed to Tate, but it has a character of simplicity unlike the rest of his works.

The relative merits of the "Old" and "New" versions have been very variously estimated. Competent judges have given the old the praise, which certainly cannot be accorded to the new, of fidelity to the Hebrew. In both, it must be admitted, that those parts which have poetical merit are few and far between; but a reverent taste is likely to be more offended by the frequent sacrifice, in the new, of depth of tone and accuracy of sense to a fluent commonplace correctness of versification and diction, than by any excessive homeliness in the old. In both, however, some psalms, or portions of psalms, are well enough rendered to entitle them to a permanent place in the hymn-books—especially the 8th, and parts of the 18th Psalm, by Sternhold; the 57th, 84th and 100th, by Hopkins; the 23rd, 34th and 36th, and part of the 148th, by Tate and Brady.

The judgment which a fastidious critic might be disposed to pass upon both these books may perhaps be considerably mitigated by comparing them with the works of other labourers in the same field, of whom Holland, in his interesting volumes entitled *Psalmists of Great Britain*, enumerates above 150. Some of them have been real poets—the celebrated earl of Surrey, Sir Philip Sidney and his sister the countess of Pembroke, George Sandys, George Wither, John Milton and John Keble. In their versions, as might be expected, there are occasional gleams of power and beauty, exceeding anything to be found in Sternhold and Hopkins, or Tate and Brady; but even in the best these are rare, and chiefly occur where the strict idea of translation has been most widely departed from. In all of them, as a rule, the life and spirit, which in prose versions of the psalms are so wonderfully preserved, have disappeared. The conclusion practically suggested by so many failures is that the difficulties of metrical translation, always great, are in this case insuperable; and that, while the psalms like other parts of scripture are abundantly suggestive of motive and material for hymnographers, it is by assimilation and adaptation, and not by any attempt to transform their exact sense into modern poetry, that they may be best used for this purpose.

The order in council of 1703 is the latest act of any public authority by which an express sanction has been given to the use of psalms or hymns in the Church of England. At the end, indeed, of many Prayer-books, till about the middle of the 19th century, there were commonly found, besides some of the hymns sanctioned by that order in council, or of those contained in the book of 1562, a sacramental and a Christmas hymn by Doddridge; a Christmas hymn (varied by Martin Madan) from Charles Wesley; an Easter hymn of the 18th century, beginning "Jesus Christ has risen to-day"; and abridgments of Bishop Ken's Morning and Evening Hymns. These additions first began to be made in or about 1791, in London editions of the Prayer-book and Psalter, at the mere will and pleasure (so far as appears) of the printers. They had no sort of authority.

In the state of authority, opinion and practice disclosed by the preceding narrative may be found the true explanation of the fact that, in the country of Chaucer, Spenser, English Shakespeare and Milton, and notwithstanding the notable example of Germany, no native congregational hymnody worthy of the name arose till after the commencement of the 18th century. Yet there was no want of

Old and  
new  
versions  
compared.

Tate and  
Brady.

III., "allowing and permitting" its use "in all such churches, chapels and congregations as should think fit to receive it." Dr Compton, bishop of London, recommended it to his diocese. No hymns were then appended to it; but the authors added a "supplement" in 1703, which received an

English  
congregational  
hymnody.

appreciation of the power and value of congregational church music. Milton could write, before 1645—

"There let the pealing organ blow  
To the full-voiced quire below  
In service high, and anthems clear,  
As may with sweetness through mine ear  
Dissolve me into ecstasies,  
And bring all Heaven before mine eyes."

Thomas Mace, in his *Musical Monument* (1676), thus described the effect of psalm-singing before sermons by the congregation in York Minster on Sundays, during the siege of 1644: "When that vast concordant unity of the whole congregational chorus came thundering in, even so as it made the very ground shake under us, oh, the unutterable ravishing soul's delight! in the which I was so transported and wrapt up in high contemplations that there was no room left in my whole man, body, soul and spirit, for anything below divine and heavenly raptures; nor could there possibly be anything to which that very singing might be truly compared, except the right apprehension or conceiving of that glorious and miraculous quire, recorded in the scriptures at the dedication of the temple." Nor was there any want of men well qualified, and by the turn of their minds predisposed, to shine in this branch of literature. Some (like Sandys, Boyd and Barton) devoted themselves altogether to paraphrases of other scriptures as well as the psalms. Others (like George Herbert, and Francis and John Quarles) moralized, meditated, soliloquized and allegorized in verse. Without reckoning these, there were a few, even before the Restoration, who came very near to the ideal of hymnody.

First in time is the Scottish poet John Wedderburn, who translated several of Luther's hymns, and in his *Compendious*

*Book of Godly and Spiritual Songs* added others of his own (or his brothers') composition. Some of these poems, published before 1560, are of uncommon excellence, uniting ease and melody of rhythm, and structural skill, with grace of expression, and simplicity, warmth and reality of religious feeling. Those entitled "Give me thy heart," "Go, heart," and "Leave me not," which will be found in a collection of 1860 called *Sacred Songs of Scotland*, require little, beyond the change of some archaisms of language, to adapt them for church or domestic use at the present day.

Next come the two hymns of "The New Jerusalem," by an English Roman Catholic priest signing himself F. B. P. (supposed to be Francis Baker, Presbyter?), and by another

Dickson. Scottish poet, David Dickson, of which the history is given by Dr Bonar in his edition of Dickson's work. This (Dickson's), which begins "O mother dear, Jerusalem," and has long been popular in Scotland, is a variation and amplification by the addition of a large number of new stanzas of the English original, beginning "Jerusalem, my happy home," written in Queen Elizabeth's time, and printed (as appears by a copy in the British Museum) about 1616, when Dickson was still young. Both have an easy natural flow, and a simple happy rendering of the beautiful scriptural imagery upon the subject, with a spirit of primitive devotion uncorrupted by medieval peculiarities. The English hymn of which some stanzas are now often sung in churches is the true parent of the several shorter forms,—all of more than common merit,—which, in modern hymn-books, begin with the same first line, but afterwards deviate from the original. Kindred to these is the very fine and faithful translation, by Dickson's contemporary Drummond of Hawthornden of the ancient "Urbs aëta Hierusalem" ("Jerusalem, that place divine"). Other ancient hymns (two of Thomas Aquinas, and the "Dies Irae") were also well translated, in 1646, by Richard Crashaw, after he had become a Roman Catholic and had been deprived by the parliament of his fellowship at Cambridge.

Conspicuous among the sacred poets of the first two Stuart reigns in England was George Wither. His *Hymnes and Songs of the Church* appeared in 1622-1623, under a patent of King James I., by which they were declared "worthy and profitable to be inserted, in convenient manner and due place, into every English Psalm-book to metre." His *Hallelujah*

(in which some of the former *Hymnes and Songs* were repeated) followed in 1641. Some of the *Hymnes and Songs* were set to music by Orlando Gibbons, and those in both books were written to be sung, though there is no evidence that the author contemplated the use of any of them in churches. They included hymns for every day in the week (founded, as those contributed nearly a century afterwards by Charles Coffin to the Parisian Breviary also were, upon the successive works of the days of creation); hymns for all the church seasons and festivals, including saints' days; hymns for various public occasions; and hymns of prayer, meditation and instruction, for all sorts and conditions of men, under a great variety of circumstances — being at once a "Christian Year" and a manual of practical piety. Many of them rise to a very high point of excellence,—particularly the "general invitation to praise God" ("Come, O come, in pious lays"), with which *Hallelujah* opens; the thanksgivings for peace and for victory, the 'Coronation Hymn, a Christmas, an Epiphany, and an Easter Hymn, and one for St Bartholomew's day (Hymns 1, 74, 75, and 84 in part i., and 26, 29, 36 and 54 in part ii. of *Hallelujah*).

John Cosin, afterwards Bishop of Durham, published in 1627 a volume of "Private Devotions," for the canonical hours and other occasions. In this there are seven or eight hymns of considerable merit,—among them a very good version of the Ambrosian "Jam lucis orto sidere," and the shorter version of the "Veni Creator," which was introduced after the Restoration into the consecration and ordination services of the Church of England.

The hymns of Milton (on the Nativity, Passion, Circumcision and "a Solemn Music"), written about 1629, in his early manhood, were probably not intended for singing; but they are odes full of characteristic beauty and power.

During the Commonwealth, in 1654, Jeremy Taylor published at the end of his *Golden Grove*, twenty-one hymns, described by himself as "celebrating the mysteries and chief festivals of the year, according to the manner of the ancient church, fitted to the fancy and devotion of the younger and pious persons, apt for memory, and to be joined to their other prayers." Of these, his accomplished editor, Bishop Heber, justly says:—

"They are in themselves, and on their own account, very interesting compositions. Their metre, indeed, which is that species of spurious Pindaric which was fashionable with his contemporaries, is an obstacle, and must always have been one, to their introduction into public or private psalmody; and the mixture of that alloy of conceits and quibbles which was an equally frequent and still greater detriment of some of the finest poetry of the 17th century will materially diminish their effect as devotional or descriptive odes. Yet, with all these faults, they are powerful, affecting and often harmonious; there are many passages of which Cowley need not have been ashamed, and some which remind us, not disadvantageously, of the corresponding productions of Milton."

He mentions particularly the advent hymn ("Lord, come away"), part of the hymn "On heaven," and (as "more regular in metre, and in words more applicable to public devotion") the "Prayer for Charity" ("Full of mercy, full of love").

The epoch of the Restoration produced in 1664 Samuel Crossman's *Young Man's Calling*, with a few "Divine Meditations" in verse attached to it; in 1668 John Austin's *Devotions in the ancient way of offices, with psalms, hymns and prayers for every day in the week and every holyday in the year*; and in 1681 Richard Baxter's *Poetical Fragments*. In these books there are altogether seven or eight hymns, the whole or parts of which are extremely good: Crossman's "New Jerusalem" ("Sweet place, sweet place alone"), one of the best of that class, and "My life's a shade, my days"; Austin's "Hark, my soul, how everything," "Fain would my thoughts fly up to Thee," "Lord, now the time returns," "Wake all my hopes, lift up your eyes"; and Baxter's "My whole, though broken heart, O Lord," and "Ye holy angels bright." Austin's *Offices* (he was a Roman Catholic) seem to have attracted much attention. Theophilus Dorrington, in 1686, published variations of them under the title of *Reformed*

*Devotions*; George Hickes, the non-juror, wrote one of his numerous recommendatory prefaces to S. Hopton's edition; and the Wesleys, in their earliest hymn-book, adopted hymns from them, with little alteration. These writers were followed by John Mason in 1683, and Thomas Shepherd in 1692,—the former, a country clergyman, much esteemed by Baxter and other Nonconformists; the latter himself a Nonconformist, who finally emigrated to America. Between these two men there was a close alliance, Shepherd's *Penitential Cries* being published as an addition to the *Spiritual Songs* of Mason. Their hymns came into early use in several Nonconformist congregations; but, with the exception of one by Mason ("There is a stream which issues forth"), they are not suitable for public singing. In those of Mason there is often a very fine vein of poetry; and later authors have, by extracts or centos from different parts of his works (where they were not disfigured by his general quaintness), constructed several hymns of more than average excellence.

Three other eminent names of the 17th century remain to be mentioned, John Dryden, Bishop Ken and Bishop Simon Patrick; with which may be associated that of Addison, though he wrote in the 18th century.

Dryden's translation of "Veni Creator" a cold and laboured performance, is to be met with in many hymn-books. Abridgments of Ken's morning and evening hymns are in all. **Dryden, Ken.** These, with the midnight hymn, which is not inferior to them, first appeared in 1697, appended to the third edition of the author's *Manual of Prayers for Winchester Scholars*. Between these and a large number of other hymns (on the attributes of God, and for the festivals of the church) published by Bishop Ken after 1703 the contrast is remarkable. The universal acceptance of the morning and evening hymns is due to their transparent simplicity, warm but not overstrained devotion, and extremely popular style. Those afterwards published have no such qualities. They are mystical, florid, stiff, didactic and seldom poetical, and deserve the neglect into which they have fallen. Bishop Patrick's hymns were chiefly translations from the Latin, most of them from Prudentius. The best is a version of "Alleluia dulce carmen."

**Patrick.** Of the five attributed to Addison, not more than three are adapted to public singing; one ("The spacious firmament on high") is a very perfect and finished composition, taking rank among the best hymns in the English language.<sup>1</sup>

From the preface to Simon Browne's hymns, published in 1720, we learn that down to the time of Dr Watts the only hymns known to be "in common use, either in private families or in Christian assemblies," were those of Barton, Mason and Shepherd, together with "an attempt to turn some of George Herbert's poems into common metre," and a few sacramental hymns by authors now forgotten, named Joseph Boyse (1660-1728) and Joseph Stennett. Of the 1410 authors of original British hymns enumerated in Daniel Sedgwick's catalogue, published in 1863, 1213 are of later date than 1707; and, if any correct enumeration could be made of the total number of hymns of all kinds published in Great Britain before and after that date, the proportion subsequent to 1707 would be very much larger.

<sup>1</sup> The authorship of this and of one other, "When all thy mercies, O my God," has been made a subject of controversy,—being claimed for Andrew Marvell (who died in 1678), in the preface to Captain E. Thompson's edition (1776) of Marvell's *Works*. But this claim does not appear to be substantiated. The editor did not give his readers the means of judging as to the real age, character or value of a manuscript to which he referred; he did not say that these portions of it were in Marvell's handwriting; he did not even himself include them among Marvell's poems, as published in the body of his edition; and he advanced a like claim on like grounds to two other poems, in very different styles, which had been published as their own by Tickell and Mallet. It is certain that all the five hymns were first made public in 1712, in papers contributed by Addison to the *Spectator* (Nos. 441, 453, 465, 489, 513), in which they were introduced in a way which might have been expected if they were by the hand which wrote those papers, but which would have been improbable, and unworthy of Addison, if they were unpublished works of a writer of so much genius, and such note in his day, as Marvell. They are all printed as Addison's in Dr Johnson's *British Poets*.

The English Independents, as represented by Dr Isaac Watts, have a just claim to be considered the real founders of modern English hymnody. Watts was the first to understand the nature of the want, and, by the publication of his *Hymns* in 1707-1709, and *Psalms* (not translations, but hymns founded on psalms) in 1709, he led the way in providing for it. His immediate followers were Simon Browne and Philip Doddridge. Later in the 18th century, Joseph Hart, Thomas Gibbons, Miss Anne Steele, Samuel Medley, Samuel Stennett, John Ryland, Benjamin Beddome and Joseph Swain succeeded to them.

Among these writers, most of whom produced some hymns of merit, and several are extremely voluminous, Isaac Watts and Philip Doddridge are pre-eminent. It has been the fashion with some to disparage Watts, as if he had never risen above the level of his *Hymns for Little Children*. No doubt his taste is often faulty, and his style very unequal, but, looking to the good, and disregarding the large quantity of inferior matter, it is probable that more hymns which approach to a very high standard of excellence, and are at the same time suitable for congregational use, may be found in his works than in those of any other English writer. Such are "When I survey the wondrous cross," "Jesus shall reign where'er the sun" (and also another adaptation of the same 72nd Psalm), "Before Jehovah's awful throne" (first line of which, however, is not his, but Wesley's), "Joy to the world, the Lord is come," "My soul, repeat His praise," "Why do we mourn departing friends," "There is a land of pure delight," "Our God, our help in ages past," "Up to the hills I lift mine eyes," and many more. It is true that in some of these cases dross is found in the original poems mixed with gold; but the process of separation, by selection without change, is not difficult. As long as pure nervous English, unaffected fervour, strong simplicity and liquid yet manly sweetness are admitted to be characteristics of a good hymn, works such as these must command admiration.

Doddridge is, generally, much more laboured and artificial; but his place also as a hymn-writer ought to be determined, not by his failures, but by his successes, of which the number is not inconsiderable. In his better works he is distinguished by a graceful and pointed, sometimes even a noble style. His "Hark, the glad sound, the Saviour comes" (which is, indeed, his masterpiece), is as sweet, vigorous and perfect a composition as can anywhere be found. Two other hymns, "How gentle God's commands," and that which, in a form slightly varied, became the "O God of Bethel, by whose hand," of the Scottish "Paraphrases," well represent his softer manner.

Of the other followers in the school of Watts, Miss Anne Steele (1717-1778) is the most popular and perhaps the best. Her hymn beginning "Far from these narrow scenes of night" deserves high praise, even by the side of other good performances on the same subject.

The influence of Watts was felt in Scotland, and among the first whom it reached there was Ralph Erskine. This seems to have been after the publication of Erskine's *Gospel Sonnets*, which appeared in 1732, five years before he joined his brother Ebenezer in the Secession Church. The *Gospel Sonnets* became, as some have said, a "people's classic"; but there is in them very little which belongs to the category of hymnody. More than nineteen-twentieths of this very curious book are occupied with what are, in fact, theological treatises and catechisms, mystical meditations on Christ as a bridegroom or husband, and spiritual enigmas, paradoxes, and antithetical conceits, versified, it is true, but of a quality of which such lines as—

"Faith's certain by fiducial acts,  
Sense by its evidential facts,"

may be taken as a sample. The grains of poetry scattered through this large mass of Calvinistic divinity are very few; yet in one short passage of seven stanzas ("O send me down a draught of love"), the fire burns with a brightness so remarkable as to justify a strong feeling of regret that the gift which this writer evidently had in him was not more often cultivated. Another passage, not so well sustained, but of considerable

beauty (part of the last piece under the title "The believer's soliloquy"), became afterwards, in the hands of John Berridge, the foundation of a very striking hymn ("O happy saints, who walk in light").

After his secession, Ralph Erskine published two paraphrases of the "Song of Solomon," and a number of other "Scripture songs," paraphrased, in like manner, from the Old and New Testaments. In these the influence of Watts became very apparent, not only by a change in the writer's general style, but by the direct appropriation of no small quantity of matter from Dr Watts's hymns, with variations which were not always improvements. His paraphrases of 1 Cor. i. 24; Gal. vi. 14; Heb. vi. 17-19; Rev. v. 11, 12, vii. 10-17, and xii. 7-12 are little else than Watts transformed. One of these (Rev. vii. 10-17) is interesting as a variation and improvement, intermediate between the original and the form which it ultimately assumed as the 66th "Paraphrase" of the Church of Scotland, of Watts's "What happy men or angels these," and "These glorious minds, how bright they shine." No one can compare it with its ultimate product, "How bright these glorious spirits shine," without perceiving that William Cameron followed Erskine, and only added finish and grace to his work,—both excelling Watts, in this instance, in simplicity as well as in conciseness.

Of the contributions to the authorized "Paraphrases" (with the settlement of which committees of the General Assembly of the Church of Scotland were occupied from 1745, or earlier, till 1781), the most noteworthy, besides the two already mentioned, were those of John Morrison and those claimed for Michael Bruce. The obligations of these "Paraphrases" to English hymnody, already traced in some instances (to which may be added the adoption from Addison of three out of the five "hymns" appended to them), are perceptible in the vividness and force with which these writers, while adhering with a severe simplicity to the sense of the passages of Scripture which they undertook to render, fulfilled the conception of a good original hymn. Morrison's "The race that long in darkness pined" and "Come, let us to the Lord our God," and Bruce's "Where high the heavenly temple stands" (if this was really his), are well entitled to that praise. The advocates of Bruce in the controversy, not yet closed, as to the poems said to have been entrusted by him to John Logan, and published by Logan in his own name, also claim for him the credit of having varied the paraphrase "Behold, the mountain of the Lord," from its original form, as printed by the committee of the General Assembly in 1745, by some excellent touches.

Attention must now be directed to the hymns produced by the "Methodist" movement, which began about 1738, and which afterwards became divided, between those esteemed Arminian, under John Wesley, those who adhered to the Moravians, when the original alliance between that body and the founders of Methodism was dissolved, and the Calvinists, of whom Whitfield was the leader, and Selina, countess of Huntingdon, the patroness. Each of these sections had its own hymn-writers, some of whom did, and others did not, secede from the Church of England. The Wesleyans had Charles Wesley, Robert Seagrave and Thomas Olivers; the Moravians, John Cennick, with whom, perhaps, may be classed John Byrom, who imbibed the mystical ideas of some of the German schools; the Calvinists, Augustus Montague Toplady, John Berridge, William Williams, Martin Madan, Thomas Haweis, Rowland Hill, John Newton and William Cowper.

Among all these writers, the palm undoubtedly belongs to Charles Wesley. In the first volume of hymns published by the two brothers are several good translations from the German, believed to be by John Wesley, who, although he translated and adapted, is not supposed to have written any original hymns; and the influence of German hymnody, particularly of the works of Paul Gerhardt, Scheffler, Tersteegen and Zinzendorf, may be traced in a large proportion of Charles Wesley's works. He is more subjective and meditative than Watts and his school; there is a didactic turn, even in his

most objective pieces, as, for example, in his Christmas and Easter hymns; most of his works are supplicatory, and his faults are connected with the same habit of mind. He is apt to repeat the same thoughts, and to lose force by redundancy—he runs sometimes even to a tedious length; his hymns are not always symmetrically constructed, or well balanced and finished off. But he has great truth, depth and variety of feeling; his diction is manly and always to the point; never florid, though sometimes passionate and not free from exaggeration; often vivid and picturesque. Of his spirited style there are few better examples than "O for a thousand tongues to sing," "Blow ye the trumpet, blow," "Rejoice, the Lord is King" and "Come, let us join our friends above"; of his more tender vein, "Happy soul, thy days are ended"; and of his fervid contemplative style (without going beyond hymns fit for general use), "O Thou who camest from above," "Forth in Thy name, O Lord, I go" and "Eternal beam of light divine." With those whose taste is for hymns in which warm religious feelings are warmly and demonstratively expressed, "Jesus, lover of my soul," is as popular as any of these.

Of the other Wesleyan hymn-writers, Olivers, originally a Welsh shoemaker and afterwards a preacher, is the most remarkable. He is the author of only two works, both odes, in a stately metre, and from their length unfit for congregational singing, but of one them, "The God of Abraham praise," an ode of singular power and beauty.

The Moravian Methodists produced few hymns now available for general use. The best are Cennick's "Children of the heavenly King" and Hammond's "Awake and sing the song of Moses and the Lamb," the former of which (abridged), and the latter as varied by Madan, are found in many hymn-books, and are deservedly esteemed. John Byrom, whose name we have thought it convenient to connect with these, though he did not belong to the Moravian community, was the author of a Christmas hymn ("Christians awake, salute the happy morn") which enjoys great popularity; and also of a short subjective hymn, very fine both in feeling and in expression, "My spirit longeth for Thee within my troubled breast."

The contributions of the Calvinistic Methodists to English hymnody are of greater extent and value. Few writers of hymns had higher gifts than Toplady, author of "Rock of Ages," by some esteemed the finest in the English language. He was a man of ardent temperament, enthusiastic zeal, strong convictions and great energy of character. "He had," says one of his biographers, "the courage of a lion, but his frame was brittle as glass." Between him and John Wesley there was a violent opposition of opinion, and much acrimonious controversy; but the same fervour and zeal which made him an intemperate theologian gave warmth, richness and spirituality to his hymns. In some of them, particularly those which, like "Deathless principle, arise," are meditations after the German manner, and not without direct obligation to German originals, the setting is somewhat too artificial; but his art is never inconsistent with a genuine flow of real feeling. Others (e.g. "When languor and disease invade" and "Your harps, ye trembling saints") fail to sustain to the end the beauty with which they began, and would have been better for abridgment. But in all these, and in most of his other works, there is great force and sweetness, both of thought and language, and an easy and harmonious versification.

Berridge, William Williams (1717-1791) and Rowland Hill, all men remarkable for eccentricity, activity and the devotion of their lives to the special work of missionary preaching, though not the authors of many good hymns, composed, or adapted from earlier compositions, some of great merit. One of Berridge, adapted from Erskine, has been already mentioned; another, adapted from Watts, is "Jesus, cast a look on me." Williams, a Welshman, who wrote "Guide me, O Thou great Jehovah," was especially an apostle of Calvinistic Methodism in his own country, and his hymns are still much used in the principality. Rowland Hill wrote the popular hymn beginning "Exalted high at God's right hand."

Scottish  
para-  
phrases.

Cennick,  
Hammond,  
Byrom.

Toplady.

Methodist  
hymns.

Berridge,  
Williams  
and  
R. Hill.

If, however, the number as well as the quality of good hymns available for general use is to be regarded, the authors of the *Olney Hymns* are entitled to be placed at the head of all the writers of this Calvinistic school. The greater number of the *Olney Hymns* are, no doubt, homely and didactic; but to the best of them, and they are no inconsiderable proportion, the tenderness of Cowper and the manliness of John Newton (1725-1807) give the interest of contrast, as well as that of sustained reality. If Newton carried to some excess the sound principle laid down by him, that "perspicuity, simplicity and ease should be chiefly attended to, and the imagery and colouring of poetry, if admitted at all, should be indulged very sparingly and with great judgment," if he is often dry and colloquial, he rises at other times into "soul-animating strains," such as "Glorious things of thee are spoken, Zion, city of our God"; and sometimes (as in "Approach, my soul, the mercy seat") rivals Cowper himself in depth of feeling. Cowper's hymns in this book are, almost without exception, worthy of his name. Among them are "Hark, my soul, it is the Lord," "There is a fountain filled with blood," "Far from the world, O Lord, I flee," "God moves in a mysterious way" and "Sometimes a light surprises." Some, perhaps, even of these, and others of equal excellence (such as "O for a closer walk with God"), speak the language of a special experience, which, in Cowper's case, was only too real, but which could not, without a degree of unreality not desirable in exercises of public worship, be applied to themselves by all ordinary Christians.

During the first quarter of the 19th century there were not many indications of the tendency, which afterwards became manifest, to enlarge the boundaries of British hymnody. The *Remains of Henry Kirke White*, published by Southey in 1807, contained a series of hymns, some of which are still in use; and a few of Bishop Heber's hymns and those of Sir Robert Grant, which, though offending rather too much against John Newton's canon, are well known and popular, appeared between 1811 and 1816, in the *Christian Observer*. In John Bowdler's *Remains*, published soon after his death in 1815, there are a few more of the same, perhaps too scholastic, character. But the chief hymn-writers of that period were two clergymen of the established Church—one in Ireland, Thomas Kelly, and the other in England, William Hurn—who both became Non-conformists, and the Moravian poet, James Montgomery (1771-1854), a native of Scotland.

Kelly was the son of an Irish judge, and in 1804 published a small volume of ninety-six hymns, which grew in successive editions till, in the last before his death in 1854, they amounted to 765. There is, as might be expected, in this great number a large preponderance of the didactic and commonplace. But not a few very excellent hymns may be gathered from them. Simple and natural, without the vivacity and terseness of Watts or the severity of Newton, Kelly has some points in common with both those writers, and he is less subjective than most of the "Methodist" school. His hymns beginning "Lo! He comes, let all adore Him," and "Through the day Thy love hath spared us," have a rich, melodious movement; and another, "We sing the praise of Him who died," is distinguished by a calm, subdued power, rising gradually from a rather low to a very high key.

Hurn published in 1813 a volume of 370 hymns, which were afterwards increased to 420. There is little in them which deserves to be saved from oblivion; but one at least, "There is a river deep and broad," may bear comparison with the best of those which have been produced upon the same, and it is rather a favourite, theme.

The *Psalms and Hymns* of James Montgomery were published in 1822 and 1825, though written earlier. More cultivated and artistic than Kelly, he is less simple and natural. His "Hail to the Lord's Anointed," "Songs of praise the angels sang" and "Mercy alone can meet my case" are among his most successful efforts.

During this period, the collections of miscellaneous hymns for congregational use, of which the example was set by the Wesleys, Whitfield, Toplady and Lady Huntingdon, had greatly multiplied; and with them the practice (for which, indeed, too many precedents existed in the history of Latin and German hymnody) of every collector altering the compositions of other men without scruple, to suit his own doctrine or taste; with the effect, too generally, of patching and disfiguring, spoiling and emasculating the works so altered, substituting neutral tints for natural colouring, and a dead for a living sense. In the Church of England the use of these collections had become frequent in churches and chapels, principally in cities and towns, where the sentiments of the clergy approximated to those of the Nonconformists. In rural parishes, when the clergy were not of the "Evangelical" school, they were generally held in disfavour; for which, even if doctrinal prepossessions had not entered into the question, the great want of taste and judgment often manifested in their compilation, and perhaps also the prevailing mediocrity of the bulk of the original compositions from which most of them were derived, would be enough to account. In addition to this, the idea that no hymns ought to be used in any services of the Church of England, except prose anthems after the third collect, without express royal or ecclesiastical authority, continued down to that time largely to prevail among high churchmen.

Two publications, which appeared almost simultaneously in 1827—Bishop Heber's *Hymns*, with a few added by Dean Milman, and John Keble's *Christian Year* (not a hymn-book, but one from which several admirable hymns have been taken, and the well-spring of many streams of thought and feeling by which good hymns have since been produced)—introduced a new epoch, breaking down the barrier as to hymnody which had till then existed between the different theological schools of the Church of England. In this movement Richard Mant, bishop of Down, was also one of the first to co-operate. It soon received a great additional impulse from the increased attention which, about the same time, began to be paid to ancient hymnody, and from the publication in 1833 of Bunsen's *Gesangbuch*. Among its earliest fruits was the *Lyra apostolica*, containing hymns, sonnets and other devotional poems, most of them originally contributed by some of the leading authors of the *Tracts for the Times* to the *British Magazine*; the finest of which is the pathetic "Lead, kindly Light, amid th' encircling gloom," by Cardinal Newman—well known, and universally admired. From that time hymns and hymn-writers rapidly multiplied in the Church of England, and in Scotland also. Nearly 600 authors whose publications were later than 1827 are enumerated in Sedgwick's catalogue of 1863, and about half a million hymns are now in existence. Works, critical and historical, upon the subject of hymns, have also multiplied; and collections for church use have become innumerable—several of the various religious denominations, and many of the leading ecclesiastical and religious societies, having issued hymn-books of their own, in addition to those compiled for particular dioceses, churches and chapels, and to books (like *Hymns Ancient and Modern*, published 1861, supplemented 1889, revised edition, 1905) which have become popular without any sanction from authority. To mention all the authors of good hymns since the commencement of this new epoch would be impossible; but probably no names could be chosen more fairly representative of its characteristic merits, and perhaps also of some of its defects, than those of Josiah Conder and James Edmeston among English Nonconformists; Henry Francis Lyte and Charlotte Elliott among evangelicals in the Church of England; John Mason Neale and Christopher Wordsworth, bishop of Lincoln, among English churchmen of the higher school; Arthur Penrhyn Stanley, Edward H. Plumptre, Frances Ridley Havergal; and in Scotland, Dr Horatius Bonar, Dr Norman Macleod and Dr George Matheson. American hymn-writers belong to the same schools, and have been affected by the same influences. Some of them have

Collec-  
tions of  
hymns-

Heber,  
Milman,  
Keble.

Mant.

Newman.

Hurn.

Mont-  
gomery.



enjoyed a just reputation on both sides of the Atlantic. Among those best known are John Greenleaf Whittier, Bishop Doane, Dr W. A. Muhlenberg and Thomas Hastings; and it is difficult to praise too highly such works as the Christmas hymn, "It came upon the midnight clear," by Edmund H. Sears; the Ascension hymn, "Thou, who didst stoop below," by Mrs S. E. Miles; two by Dr Ray Palmer, "My faith looks up to Thee, Thou Lamb of Calvary," and "Jesus, Thou joy of loving hearts," the latter of which is the best among several good English versions of "Jesu, dulcedo, cordium"; and "Lord of all being, throned afar," by Oliver Wendell Holmes.

The more modern "Moody and Sankey" hymns (see MOODY, D. L.) popularized a new Evangelical type, and the Salvation Army has carried this still farther.

7. *Conclusion.*—The object aimed at in this article has been to trace the general history of the principal schools of ancient and modern hymnody, and especially the history of its use in the Christian church. For this purpose it has not been thought necessary to give any account of the hymns of Racine, Madame Guyon and others, who can hardly be classed with any school, nor of the works of Caspar Malan of Geneva (1787-1864) and other quite modern hymn-writers of the Reformed churches in Switzerland and France.

On a general view of the whole subject, hymnody is seen to have been a not inconsiderable factor in religious worship. It has been sometimes employed to disseminate and popularize particular views, but its spirit and influence has been, on the whole, catholic. It has embodied the faith, trust and hope, and no small part of the inward experience, of generation after generation of men, in many different countries and climates, of many different nations, and in many varieties of circumstances and condition. Coloured, indeed, by these differences, and also by the various modes in which the same truths have been apprehended by different minds and sometimes reflecting partial and imperfect conceptions of them, and errors with which they have been associated in particular churches, times and places, its testimony is, nevertheless, generally the same. It has upon it a stamp of genuineness which cannot be mistaken. It bears witness to the force of a central attraction more powerful than all causes of difference, which binds together times ancient and modern, nations of various race and language, churches and nonconformists, churches reformed and unreformed; to a true fundamental unity among good Christians; and to a substantial identity in their moral and spiritual experience. (S.)

The regular practice of hymnody in English musical history dates from the beginning of the 16th century. Luther's verses were adapted sometimes to and sometimes church melodies, sometimes to tunes of secular songs, and a hundred hymns composed for them by himself and others. Many rhyming Latin hymns are of earlier date whose tunes are identified with them, some of which tunes, with the subject of their Latin text, are among the Reformer's appropriations; but it was he who put the words of praise and prayer into the popular mouth, associated with rhythmical music which aided to imprint the words upon the memory and to enforce their enunciation. In conjunction with his friend Johann Walther, Luther issued a collection of poems for choral singing in 1524, which was followed by many others in North Germany. The English versions of the Psalms by Sternhold and Hopkins and their predecessors, and the French version by Clement Marot and Theodore Beza, were written with the same purpose of fitting sacred minstrelsy to the voice of the multitude. Goudimel in 1566 and Claudin le Jeune in 1607 printed harmonizations of tunes that had then become standard for the Psalms, and in England several such publications appeared, culminating in Thomas Ravenscroft's famous collection, *The Whole Book of Psalms* (1621); in all of these the arrangements of the tunes were by various masters. The English practice of hymn-singing was much strengthened when the return of the exiled reformers from Frankfurt and Geneva, when it became so general that, according to Bishop Jewell, thousands of the populace who assembled at Paul's Cross to hear the preaching would join in the singing of psalms before and after the sermon.

The placing of the choral song of the church within the lips of the people had great religious and moral influence; it has had also its great effect upon art, shown in the productions of the North German musicians ever since the first days of the Reformation, which abound in exercises of scholarship and imagination wrought upon the tunes of established acceptance. Some of these are arrangements to the tunes with interludes between the several strains,

and some are compositions for the organ or for orchestral instruments that consist of such elaboration of the themes as is displayed in accompaniments to voices, but of far more complicated and extended character. A special art-form that was developed to a very high degree, but has passed into comparative disuse, was the structure of all varieties of counterpoint extemporaneously upon the known hymn-tunes (chorals), and several masters acquired great fame by success in its practice, of whom J. A. Reinken (1623-1722), Johann Pachelbel (1656-1706), Georg Böhm and the North great J. S. Bach are specially memorable. The musical culture of Germany has for artistic treatment a strong advantage which is unpossessed by that of England, in that for the most part the same verses are associated with the same tunes, so that, whenever the text or the music is heard, either prompts recollection of the other, whereas in England tunes were always and are now often composed to metres and not to poems; any tune in a given metre is available for every poem in the same, and hence there are various tunes to one poem, and various poems to one tune. In England a tune is used generally after some place—as, "York," "Windsor," "Dundee,"—or by some other unifying word; in North Germany a tune is mostly named by the initial words of the verses to which it is allied, and consequently, whenever it is heard, whether with words or without, it necessarily suggests to the hearer the whole subject of that hymn of which it is the musical motto undivorceable from the literary half. manifold as they are, knowledge of the choral tunes is included in the earliest schooling of every Lutheran and every Calvinist in Germany, which thus enables all to take part in performance of the tunes, and hence expressly the definition of "choral." Compositions grounded on the standard tune are then not merely school exercises, but works of art which link the sympathies of the writer and the listener, and aim at expressing the feeling prompted by the hymn under treatment.

**BIBLIOGRAPHY:** I. Ancient.—George Cassander, *Hymni ecclesiastici* (Cologne, 1556); Georgius Fabricius, *Poëtarum veterum ecclesiasticorum* (Frankfort, 1578); Cardinal J. M. Thomasius, *Hymnarium in Opera*, ii. 351 seq. (Rome, 1747); A. J. Rambach, *Anthologie christlicher Gesänge* (Altona, 1817); H. A. Daniel, *Thesaurus hymnologicus* (Leipzig, 5 vols., 1841-1856); J. M. Neale, *Hymni ecclesie et sæculæ* (London, 1851-1852); and *Hymns of the Eastern Church* (1863). The dissertation prefixed to the second volume of the *Acta sanctorum* of the Bollandists; Cardinal J. B. Pitra, *Hymni veteris ætatis grecæ* (1867); *Analecæ sacra* (1876); W. Christ and M. Parantini, *Anthologia sacra carminum Christianorum* (Leipzig, 1871); F. A. March, *Latin Hymns with English Notes* (New York, 1875); K. C. Treuch, *Sacred Latin Poetry* (London, 4th ed., 1874); J. Pauly, *Hymni brevissimi Romani* (Aix-la-Chapelle, 3 vols., 1868-1870); Pimont, *Les Hymnes du bréviaire romain* (vols. 1-3, 1874-1884, unfinished); A. W. F. Fischer, *Kirchenlieder-Lexicon* (Gotha, 1878-1879); J. Kayser, *Beiträge zur Geschichte der ältesten Kirchenhymnen* (1881); M. Manitius, *Geschichte der christlichen lateinischen Poesie* (Stuttgart, 1891); John Julian, *Dictionary of Hymnology* (1892, new ed. 1907). For criticisms of metre, see also: Huemer, *Über die Geschichte der ältesten christlichen Kirchenlieder* (1879); E. Bouvy, *Poëtes et mélodes* (Nîmes, 1886); C. Krumbacher, *Geschichte der byzantinischen Literatur* (Munich, 1897, p. 700 seq.); J. M. Neale, *Latin dissertation* prefixed to Daniel's *Thesaurus*, vol. 5; and D. J. Donahoe, *Early Christian Hymns* (London, 1909).

II. Medieval.—Walafrid Strabo's treatise, ch. 25, *De hymnis*. &c.; Rudolph of Tongres, *De psalterio observando* (14th century); Clichtvaens, *Elucidarium ecclesiasticum* (Paris, 1556); Faustinus Arellus, *Hymnodia Hispanica* (Rome, 1786); E. du Ménil, *Poëtes populaires latins métriques des XII<sup>e</sup> siècles* (Paris, 1843); J. Stevenson, *Latin Hymns of the Anglo-Saxon Church* (Surrey, 1850); Norman, *Hymnarium Sarisburiense* (London, 1851); F. D. Chambers, *Psalter*, &c., according to the Sarum use (1852); J. J. Mone, *Latinsche Hymnen des Mittelalters* (Freiburg, 3 vols., 1853-1855); Ph. Wackernagel, *Das deutsche Kirchenlied von der ältesten Zeit bis zum Anfang des 17. Jahrhunderts*, vol. i. (Leipzig, 1864); E. Dümmler, *Poëtae latini ævi Carolini* (1881-1890); the *Hymnologische Beiträge: Quellen und Forschungen zur Geschichte der lateinischen Hymnendichtung*, edited by C. Blume and G. M. Dreyes (Leipzig, 1897); G. C. F. Mohrnick, *Hymnologische Forschungen*; Klemm, *Die Hymnologie in ihrer ältesten Geschichte* (Strasbourg, 4 vols., 1885-1887); Das katholische deutsche Kirchenlied (vol. i. by K. Severin Meister, 1862, vol. ii. by W. Baumker, 1883); the "Hymnodia Iberica," *Spanische Hymnen des Mittelalters*, vol. xvi. (1894); the "Hymnodia Gotica," *Mozarabische Hymnen des altspanischen Ritus*, vol. xxvii. (1897); J. Dankó, *Vetus hymnarium ecclesiasticum Hungaricum* (Budapest, 1893); J. H. Bernard and R. Atkinson, *The Irish Liber Hymnorum* (2 vols., London, 1898); C. A. J. Chevalier, *Poësie liturgique du moyen âge* (Paris, 1893).

III. Modern.—J. C. Jacoby, *Salmodie Germanica* (1723-1725 and 1728, with supplement added by J. Herberich, 1763); F. A. Cunz, *Geschichte des deutschen Kirchenliedes* (Leipzig, 1855); Baron von Bunsen, *Versuch eines allgemeinen Gesang- und Gebetbuchs*.

The old tune for the 100th Psalm and Croft's tune for the 104th are almost the only exceptions, unless "God save the King" may be classed under "hymnody." In Scotland also the tune for the 124th Psalm is associated with its proper text.

(1833) and *Allgemeines evangelisches Gesang- und Gebetbuch* (1846); Catherine Winkworth, *Christian Singers of Germany* (1869) and *Lyra Germanica* (1855); Catherine H. Dunn, *Hymns from the German* (1857); Frances E. Cox, *Sacred Hymns from the German* (London, 1841); Massie, *Lyra domestica* (1860); *Appendix on Scottish Psalmody* in D. Laing's edition of Baillie's *Letters and Journals* (1841-1842); J. and C. Wesley, *Collection of Psalms and Hymns* (1741); Josiah Miller, *Our Hymns, their Authors and Origin* (1866); John Gadsby, *Memoirs of the Principal Hymn-writers* (3rd ed., 1861); L. C. Biggs, *Annotations to Hymns Ancient and Modern* (1867); Daniel Sedgwick, *Comprehensive Index of Names of Original Authors of Hymns* (2nd ed., 1863); R. E. Prothero, *The Psalms in Human Life* (1907); C. J. Brandt and L. Helweg, *Den danske Psalmeidning* (Copenhagen, 1846-1847); J. N. Skaar, *Norsk Salmehistorie* (Bergen, 1879-1880); H. Schück, *Svensk Litteraturhistoria* (Stockholm, 1890); Rudolf Wolkau, *Geschichte der deutschen Literatur in Böhmen, 249-256*, and *Das deutsche Kirchenlied der böhm. Brüder* (Prague, 1891); Zahn, *Die geistlichen Lieder der Brüder in Böhmen, Mähren u. Polen* (Nuremberg, 1875); and J. Müller, "Bohemian Brethren's Hymnody," in J. Julian's *Dictionary of Hymnology*.

For account of hymn-tunes, &c., see W. Cowan and James Love, *Music of the Church Hymnody and the Psalter in Metre* (London, 1901); and Dickinson, *Music in the History of the Western Church* (New York, 1902); S. Krumpholtz, *Encyclopædie der Kirchenmusik* (4 vols., 1888-1892); Chr. Palmer, *Evangelische Hymnologie* (Stuttgart, 1865); and P. Utto Kornmüller, *Lexikon der kirchlichen Tonkunst* (1891).

**HYPAETHROS** (Gr. ὑπαῖθος, beneath the sky, in the open air, ὑῶ, beneath, and αἶθρ, air), the Greek term quoted by Vitruvius (iii. 2) for the opening in the middle of the roof of decastyle temples, of which "there was no example in Rome, but one in Athens in the temple of Jupiter Olympius, which is octastyle." But at the time he wrote (c. 25 B.C.) the cella of this temple was unroofed, because the columns which had been provided to carry, at all events, part of the ceiling and roof had been taken away by Sulla in 80 B.C. The decastyle temple of Apollo Didymæus near Miletus was, according to Strabo (c. 50 B.C.), unroofed, on account of the vastness of its cella, in which precious groves of laurel bushes were planted. Apart from these two examples, the references in various writers to an opening of some kind in the roofs of temples dedicated to particular deities, and the statement of Vitruvius, which was doubtless based on the writings of Greek authors, that in decastyle or large temples the temple was open to the sky and without a roof (*medium autem sub divo esse sine tecto*), render the existence of the hypaethros probable in some cases; and therefore C. R. Cockerell's discovery in the temple at Aegina of two fragments of a coping-stone, in which there were sinkings on one side to receive the tiles and covering tiles, has been of great importance in the discussion of this subject. In the conjectural restoration of the opiaion or opening in the roof shown in Cockerell's drawing, it has been made needlessly large, having an area of about one quarter of the superficial area of the cella between the columns, and since in the Pantheon at Rome the relative proportions of the central opening in the dome and the area of the Rotunda are 1: 22, and the light there is ample, in the clearer atmosphere of Greece it might have been less. The larger the opening the more conspicuous would be the notch in the roof which is so greatly objected to; in this respect T. J. Hittorff would seem to be nearer the truth when, in his conjectural restoration of Temple R. at Selinus, he shows an opiaion about half the relative size shown in Cockerell's of that at Aegina, the coping on the side elevation being much less noticeable. The problem was apparently solved in another way at Bassae, where, in the excavations of the temple of Apollo by Cockerell and Baron Haller von Hallerstein, three marble tiles were found with pierced openings in them about 18 in. by 10 in.; five of these pierced tiles on either side would have amply lighted the interior of the cella, and the amount of rain passing through (a serious element to be considered in a country where torrential rains occasionally fall) would not be very great or more than could be retained to dry up in the cella sunk pavement. In favour of both these methods of lighting the interior of the cella, the sarcophagus tomb at Cyrene, about 20 ft. long, carved in imitation of a temple, has been adduced, because, on the top of the roof and in its centre, there is a raised coping, and a similar feature is found on a tomb found near Delos; an example from

Crete now in the British Museum shows a pierced tile on each side of the roof, and a large number of pierced tiles have been found in Pompeii, some of them surrounded with a rim identical with that of the marble tiles at Bassae. On the other hand, there are many authorities, among them Dr W. Dörpfeld, who have adhered to their original opinion that it was only through the open doorway that light was ever admitted into the cella, and with the clear atmosphere of Greece and the reflections from the marble pavement such lighting would be quite sufficient. There remains still another source of light to be considered, that passing through the Parian marble tiles of the roof; the superior translucency of Parian to any other marble may have suggested its employment for the roofs of temples, and if, in the framed ceilings carried over the cella, openings were left, some light from the Parian tile roof might have been obtained. It is possibly to this that Plutarch refers when describing the ceiling and roof of the temple of Demeter at Eleusis, where the columns in the interior of the temple carried a ceiling, probably constructed of timbers crossing one another at right angles, and one or more of the spaces was left open, which Xenodes surmounted by a roof formed of tiles.

James Fergusson put forward many years ago a conjectural restoration in which he adopted a clerestory above the superimposed columns inside the cella; in order to provide the light for these windows he indicated two trenches in the roof, one on each side, and pointed out that the great Hall of Columns at Karnak was lighted in this way with clerestory windows; but in the first place the light in the latter was obtained over the flat roofs covering lower portions of the hall, and in the second place, as it rarely rains in Thebes, there could be no difficulty about the drainage, while in Greece, with the torrential rains and snow, these trenches would be deluged with water, and with all the appliances of the present day it would be impossible to keep such clerestory windows watertight. There is, however, still another objection to Fergusson's theory; the water collecting in these trenches on the roof would have to be discharged, for which Fergusson's suggestions are quite inadequate, and the gargoyles shown in the cella wall would make the peristyle insupportable just at the time when it was required for shelter. No drainage otherwise of any kind has ever been found in any Greek temple, which is fatal to Fergusson's view. Nor is it in accordance with the definition of the word 'sky'—English cathedrals and churches are all lighted by clerestory windows, but no one has described them as open to the sky, and although Vitruvius's statements are sometimes confusing, his description is far too clear to leave any misunderstanding as to the lighting of temples (where it was necessary on account of great length) through an opening in the roof.

There is one other theory which has been put forward, but which can only apply to non-peristylar temples,—that light and air was admitted through the metopes, the apertures between the beams crossing the cella,—and it has been assumed that because Orestes was advised in one of the Greek plays to climb up and look through the metopes of the temple, these were left open; but if Orestes could look in, so could the birds, and the statue of the god would be defiled. The metopes were probably filled in with shutters of some kind which Orestes knew how to open. (R.P.S.)

**HYPLLAGE** (Gr. ὑπάλλαγή, interchange or exchange), a rhetorical figure, in which the proper relation between two words according to the rules of syntax are inverted. The stock instance is that in Virgil, *Aen.* iii. 61, where *dare classibus aurois*, to give winds to the fleet, is put for *dare classes aurois*, to give the fleet to the winds. The term is also loosely applied to figures of speech properly known as "metonymy" and, generally, to any striking turn of expression.

**HYPATIA** (*Ἥπαρια*) (c. A.D. 370-415) mathematician and philosopher, born in Alexandria, was the daughter of Theon, also a mathematician and philosopher, author of scholia on Euclid and a commentary on the *Almagest*, in which it is suggested, that he was assisted by Hypatia (on the 3rd book). After lecturing in her native city, Hypatia ultimately became the recognized head of the Neoplatonic school there (c. 400). Her great eloquence and rare modesty and beauty, combined with her remarkable intellectual gifts, attracted to her class-room a large number of pupils. Among these was Synesius, afterwards (c. 410) bishop of Ptolemais, several of whose letters to her, full of chivalrous admiration and reverence, are still extant. Suidas, misled by an incomplete excerpt in Photius from the life of Isidorus (the Neoplatonist) by Damascius, states that Hypatia

was the wife of Isidorus; but this is chronologically impossible, since Isidorus could not have been born before 434 (see Hoche in *Philologus*). Shortly after the accession of Cyril to the patriarchate of Alexandria in 412, owing to her intimacy with Orestes, the pagan prefect of the city, Hypatia was barbarously murdered by the Nitrian monks and the fanatical Christian mob (March 415). Socrates has related how she was torn from her chariot, dragged to the Caesareum (then a Christian church), stripped naked, done to death with oyster-shells (*ὀστράκους ἀνέκρουσεν*, perhaps "cut her throat") and finally burnt piecemeal. Most prominent among the actual perpetrators of the crime was one Peter, a reader; but there seems little reason to doubt Cyril's complicity (see CYRIL OF ALEXANDRIA).

Hypatia, according to Suidas, was the author of commentaries on the *Arithmetica* of Diophantus of Alexandria, on the *Conics* of Apollonius of Perga and on the astronomical canon (of Ptolemy). These works are lost; but their titles, combined with expressions in the letters of Synesius, who consulted her about the construction of an astrolabe and a hydroscope, indicate that she devoted herself specially to astronomy and mathematics. Little is known of her philosophical opinions, but she appears to have embraced the intellectual rather than the mystical side of Neoplatonism, and to have been a follower of Plotinus rather than of Porphyry and Iamblichus. Zeller, however, in his *Outlines of Greek Philosophy* (1886, Eng. trans. p. 347), states that "she appears to have taught the Neoplatonic doctrine in the form in which Iamblichus had stated it." A Latin letter to Cyril on behalf of Nestorius, printed in the *Collectio nova conciliorum*, i. (1623), by Stephanus Baluzius (Étienne Baluze, q.v.), and sometimes attributed to her, is undoubtedly spurious. The story of Hypatia appears in a considerably disguised yet still recognizable form in the legend of St Catherine as recorded in the Roman *Breviary* (November 25), and still more fully in the *Martyrologies* (see A.B. Jameson, *Sacred and Legendary Art* (1867) ii. 467.

The chief source for the little we know about Hypatia is the account given by Socrates (*Hist. ecclesiastica*, viii. 15). She is the subject of an epigram by Palladas in the *Greek Anthology* (ix. 100). See Fabricius *Bibliotheca Graeca* (ed. Harles), ix. 187; John Toland, *Tetradymus* (1720); R. Hoche in *Philologus* (1860), xv. 435; monographs by Stephan Wolf (Czernowitz, 1879), H. Ligier (Dijon, 1880) and W. A. Meyer (Heidelberg, 1885), who devotes attention to the relation of Hypatia to the chief representatives of Neoplatonism; J. B. Bury, *Hist. of the Later Roman Empire* (1889), i. 208, 317; A. Gildenpenning, *Geschichte des oströmischen Reiches unter Arcadius und Theodosius II.* (Halle, 1885), p. 230; Wetzler and Welte, *Kirchenlexikon*, vi. (1889), from a Catholic standpoint. The story of Hypatia also forms the basis of the well-known historical romance by Charles Kingsley (1853).

**HYPERBATON** (Gr. ὑπερβάτων, a stepping over), the name of a figure of speech, consisting of a transposition of words from their natural order, such as the placing of the object before instead of after the verb. It is a common method of securing emphasis.

**HYPERBOLA**, a conic section, consisting of two open branches, each extending to infinity. It may be defined in several ways. The *in solido* definition as the section of a cone by a plane at a less inclination to the axis than the generator brings out the existence of the two infinite branches if we imagine the cone to be double and to extend to infinity. The *in plano* definition, i.e. as the conic having an eccentricity greater than unity, is a convenient starting-point for the Euclidian investigation. In projective geometry it may be defined as the conic which intersects the line at infinity in two real points, or to which it is possible to draw two real tangents from the centre. Analytically, it is defined by an equation of the second degree, of which the highest terms have real roots (see CONIC SECTION).

While resembling the parabola in extending to infinity, the curve has closest affinities to the ellipse. Thus it has a real centre, two foci, two directrices and two vertices; the transverse axis, joining the vertices, corresponds to the major axis of the ellipse, and the line through the centre and perpendicular to this axis is called the conjugate axis, and corresponds to the minor axis of the ellipse; about these axes the curve is symmetrical. The curve does not appear to intersect the conjugate axis, but the introduction of imaginaries permits us to regard it as cutting this axis in two unreal points. Calling the foci S, S', the real vertices A, A', the extremities

of the conjugate axis B, B', and the centre C, the positions of B, B' are given by  $AB=AB'=CS$ . If a rectangle be constructed about AA' and BB', the diagonals of this figure are the "asymptotes" of the curve; they are the tangents from the centre, and hence touch the curve at infinity. These two lines may be pictured in the *in solido* definition as the section of a cone by a plane through its vertex and parallel to the plane generating the hyperbola. If the asymptotes be perpendicular, or, in other words, the principal axes be equal, the curve is called the rectangular hyperbola. The hyperbola which has for its transverse and conjugate axes the transverse and conjugate axes of another hyperbola is said to be the conjugate hyperbola.

Some properties of the curve will be briefly stated; if PN be the ordinate of the point P on the curve, AA' the vertices, X the meet of the directrix and axis and C the centre, then  $PN^2=AN.NA'$ ;  $SX^2=AX.AX'$ , i.e.  $PN^2$  is to  $AN.NA'$  in a constant ratio. The circle on AA' as diameter is called the auxiliary circle; obviously  $AN.NA'$  equals the square of the tangent to this circle from N, and hence the ratio of PN to the tangent to the auxiliary circle from N equals the ratio of the conjugate axis to the transverse. We may observe that the asymptotes intersect this circle in the same points as the directrices. An important property is: the difference of the focal distances of any point on the curve equals the transverse axis. The tangent at any point bisects the angle between the focal distances of the point, and the normal is equally inclined to the focal distances. Also the auxiliary circle is the locus of the feet of the perpendiculars from the foci on any tangent. Two tangents from any point are equally inclined to the focal distance of the point. If the tangent at P meet the conjugate axis in t, and the transverse in N, then  $CP.NN=BC^2$ ; similarly if g and G be the corresponding intersections of the normal,  $PG.Pg=BC^2.AC^2$ . A diameter is a line through the centre and terminated by the curve; it bisects all chords parallel to the tangents at its extremities; the diameter parallel to these chords is its conjugate diameter. Any diameter is a mean proportional between the transverse axis and the focal chord parallel to the diameter. Any line cuts off equal distances between the curve and the asymptotes. If the tangent at P meet the asymptotes in R, V, then  $CR.CR'=CS^2$ . The geometry of the rectangular hyperbola is simplified by the fact that its principal axes are equal.

Analytically the hyperbola is given by  $ax^2+2hxy+by^2+2gx+2fy+c=0$  wherein  $ab>h^2$ . Referred to the centre this becomes  $Ax^2+2Hxy+By^2+C=0$ ; and if the axes of coordinates be the principal axes of the curve, the equation is further simplified to  $Ax^2-By^2=C$ , or if the semi-transverse axis be  $a$ , and the semi-conjugate  $b$ ,  $x^2/a^2-y^2/b^2=1$ . This is the most commonly used form. In the rectangular hyperbola  $a=b$ ; hence its equation is  $x^2-y^2=0$ . The equations to the asymptotes are  $x/a=+y/b$  and  $x=-y/b$  respectively. Referred to the asymptotes as axes the general equation becomes  $xy=k^2$ ; obviously the axes are oblique in the general hyperbola and rectangular in the rectangular hyperbola. The values of the constant  $k^2$  are  $\frac{1}{2}(a^2+b^2)$  and  $\frac{1}{2}a^2$  respectively. (See GEOMETRY: Analytical; and Projective.)

**HYPERBOLE** (from Gr. ὑπερβάλλειν, to throw beyond), a figure of rhetoric whereby the speaker expresses more than the truth, in order to produce a vivid impression; hence, an exaggeration.

**HYPERBOREANS** (ἑπέρβοροι, ἑπέρβοριοι), a mythical people intimately connected with the worship of Apollo. Their name does not occur in the *Iliad* or the *Odyssey*, but Herodotus (iv. 32) states that they were mentioned in Hesiod and in the *Epigoni*, an epic of the Theban cycle. According to Herodotus, two maidens, Opis and Arge, and later two others, Hyperoche and Laodice, escorted by five men, called by the Delians Perpherees, were sent by the Hyperboreans with certain offerings to Delos. Finding that their messengers did not return, the Hyperboreans adopted the plan of wrapping the offerings in wheat-straw and requested their neighbours to hand them on to the next nation, and so on, till they finally reached Delos. The theory of H. L. Ahrens, that Hyperboreans and Perpherees are identical, is now widely accepted. In some of the dialects of northern Greece (especially Macedonia and Delphi) φ had a tendency to become β. The original form of *Περφερέες* was ἑπέρφερέται or ἑπέρφοροι ("those who carry over"), which becoming ἑπέρβοροι gave rise to the popular derivation from βόρσας ("dwellers beyond the north wind"). The Hyperboreans were thus the bearers of the sacrificial gifts to Apollo over land and sea, irrespective of their home, the name being given to Delphians, Thessalians, Athenians and Delians. It is objected by O. Schröder that the form *Περφερέες* requires a passive meaning, "those who are carried round the altar," perhaps dancers like the whirling dervishes; distinguishing them from the Hyperboreans, he explains the latter as those who live "above

the mountains," that is, in heaven. Under the influence of the derivation from *Bopias*, the home of the Hyperboreans was placed in a region beyond the north wind, a paradise like the Elysian plains, inaccessible by land or sea, whither Apollo could remove those mortals who had lived a life of piety. It was a land of perpetual sunshine and great fertility; its inhabitants were free from disease and war. The duration of their life was 1000 years, but if any desired to shorten it, he decked himself with garlands and threw himself from a rock into the sea. The close connexion of the Hyperboreans with the cult of Apollo may be seen by comparing the Hyperborean myths, the characters of which by their names mostly recall Apollo or Artemis (Agvyeus, Opis, Hecaergos, Loxo), with the ceremonial of the Apolline worship. No meat was eaten at the Pyanepsia; the Hyperboreans were vegetarians. At the festival of Apollo at Leucas a victim flung himself from a rock into the sea, like the Hyperborean who was tired of life. According to an Athenian decree (380 B.C.) asses were sacrificed to Apollo at Delphi, and Pindar (*Pythia*, x. 33) speaks of "hecatombs of asses" being offered to him by the Hyperboreans. As the latter conveyed sacrificial gifts to Delos hidden in wheat-straw, so at the Thargelia a sheaf of corn was carried round in procession, concealing a symbol of the god (for other resemblances see Crusius's article). Although the Hyperborean legends are mainly connected with Delphi and Delos, traces of them are found in Argos (the stories of Heracles, Perseus, Ios), Attica, Macedonia, Thrace, Sicily and Italy (which Niebuhr indeed considers their original home). In modern times the name has been applied to a group of races, which includes the Chukchis, Koryaks, Yukaghirs, Ainus, Gilyaks and Kamchadals, inhabiting the arctic regions of Asia and America. But if ever ethnically one, the Asiatic and American branches are now as far apart from each other as they both are from the Mongolo-Tatar stock.

See O. Crusius in Roscher's *Lexikon der Mythologie*; O. Schröder in *Archiv für Religionswissenschaft* (1904), viii. 69; W. Mannhardt, *Wald- und Feldkulte* (1905); L. R. Farnell, *Cults of the Greek States* (1907), iv. 100.

**HYPEREIDES** (c. 390-322 B.C.), one of the ten Attic orators, was the son of Glaucippus, of the deme of Collytus. Having studied under Isocrates, he began life as a writer of speeches for the courts, and in 360 he prosecuted Autocles, a general charged with treason in Thrace (frags. 55-65, Blass). At the time of the so-called "Social War" (358-355) he accused Aristophon, then one of the most influential men at Athens, of malpractices (frags. 40-44, Blass), and impeached Philocrates (343) for high treason. From the peace of 346 to 324 Hyperides supported Demosthenes in the struggle against Macedon; but in the affair of Harpalus he was one of the ten public prosecutors of Demosthenes, and on the exile of his former leader he became the head of the patriotic party (324). After the death of Alexander, he was the chief promoter of the Lamian war against Antipater and Craterus. After the decisive defeat at Crannon (322), Hyperides and the other orators, whose surrender was demanded by Antipater, were condemned to death by the Athenian partisans of Macedonia. Hyperides fled to Aegina, but Antipater's emissaries dragged him from the temple of Aecus, where he had taken refuge, and put him to death; according to others, he was taken before Antipater at Athens or Cleonae. His body was afterwards removed to Athens for burial.

Hyperides was an ardent pursuer of "the beautiful," which in his time generally meant pleasure and luxury. His temper was easy-going and humorous; and hence, though in his development of the periodic sentence he followed Isocrates, the essential tendencies of his style are those of Lysias, whom he surpassed, however, in the richness of his vocabulary and in the variety of his powers. His diction was plain and forcible, though he occasionally indulged in long compound words probably borrowed from the Middle Comedy, with which, and with the everyday life of his time, he was in full sympathy. His composition was simple. He was specially distinguished for subtlety of expression, grace and wit, as well as for tact in approaching his case and

handling his subject matter. Sir R. C. Jebb sums up the criticism of pseudo-Longinus (*De sublimitate*, 34) in the phrase—"Hyperides was the Sheridan of Athens."

Seventy-seven speeches were attributed to Hyperides, of which twenty-five were regarded as spurious even by ancient critics. It is said that a MS. of most of the speeches was in existence in the 16th century in the library of Matthias Corvinus, king of Hungary, at Ofen, but was destroyed at the capture of the city by the Turks in 1526. Only a few fragments were known until comparatively recent times. In 1847 large fragments of his speeches *Against Demosthenes* (see above) and *For Lycophon* (incidentally interesting as elucidating the order of marriage processions and other details of Athenian life, and the Athenian government of Lemnos), and the whole of the *For Eusebippus* (c. 330, a *locus classicus* on *destruction of state prosecutions*), were found in a tomb at Thebes in Egypt, and in 1856 a considerable portion of a *λόγος περίφωτος*, a *Funeral Oration* over Leosthenes and his comrades who had fallen in the Lamian war, the best extant specimen of epideictic oratory (see BABINGTON, CHURCHILL). Towards the end of the century further discoveries were made of the conclusion of the speech *Against Philippides* (dealing with a *γραφὴ πικρῶν ὁμῶν*, or indictment for the proposal of an unconstitutional measure, arising out of the disputes of the Macedonian and anti-Macedonian parties at Athens), and of the whole of the *Against Athenogenes* (a performer accused of fraud in the sale of his business). These have been edited by F. G. Kenyon (1893). An important speech that is lost is the *Deliacus* (frags. 67-75, Blass) on the presidency of the Delian temple claimed by both Athens and Delos, which was adjudged by the Amphictyons to Athens.

On Hyperides generally see pseudo-Plutarch, *Decem oratorum vitæ*; F. Blass, *Attische Beredsamkeit*, iii.; R. C. Jebb, *Attic Orators*, i. 381. A full list of editions and articles is given in F. Blass, *Hyperides orationes sex cum ceterarum fragmentis* (1894, Teubner series), to which may be added L. Blass, *Le Quattro Orazioni di Iperide* (introduction and notes, 1888), and J. E. Sandys in *Classical Review* (January 1895) (a review of the editions of Kenyon and Blass). For the discourse against Athenogenes see H. Weil, *Études sur l'antiquité grecque* (1900).

**HYPERION**, in Greek mythology, one of the Titans, son of Uranus and Gaia and father of Helios, the sun-god (Hesiod, *Theog.* 134, 371; Apollodorus i. 1. 2). In the well-known passage in Shakespeare (*Hamlet*, i. 2: "Hyperion to a satyr,") where as in other poets the vowel *i*- though really long, is shortened for metrical reasons) Hyperion is used for Apollo as expressive of the idea of beauty. The name is often used as an epithet of Helios, who is himself sometimes called simply Hyperion. It is explained as (1) he who moves above (*ὑπερ-ἄνω*), but the quantity of the vowel is against this; (2) he who is above (*ὑπερι-ἄνω*). Others take it to be a patronymic in form, like *Ἐκρονίωρ*, *Μολίων*.

**HYPERSTHENE**, a rock-forming mineral belonging to the group of orthorhombic pyroxenes. It differs from the other members (enstatite [g.p.] and bronzite) of this group in containing a considerable amount of iron replacing magnesium: the chemical formula is (Mg,Fe)SiO<sub>3</sub>. Distinctly developed crystals are rare, the mineral being usually found as foliated masses embedded in those igneous rocks—norite, hypersthene-andesite, &c.—of which it forms an essential constituent. The coarsely grained labradorite-hypersthene-rock (norite) of the island of St Paul off the coast of Labrador has furnished the most typical material; and for this reason the mineral has been known as "Labrador hornblende" or paultite. The colour is brownish-black, and the pleochroism strong; the hardness is 6, and the specific gravity 3.4-3.5. On certain surfaces it displays a brilliant copper-red metallic sheen or schiller, which has the same origin as the bronzy sheen of bronzite (g.p.), but is even more pronounced. Like bronzite, it is sometimes cut and polished for ornamental purposes. (L. J. S.)

**HYPERTROPHY** (Gr. *ὑπέρ*, over, and *τροφή*, nourishment), a term in medicine employed to designate an abnormal increase in bulk of one or more of the organs or component tissues of the body (see PATHOLOGY). In its strict sense this term can only be applied where the increase affects the natural textures of a part, and is not applicable where the enlargement is due to the presence of some extraneous morbid formation. Hypertrophy of a part may manifest itself either by simply an increase in the size of its constituents, or by this combined with an increase in their number (hyperplasia). In many instances both are associated.

The conditions giving rise to hypertrophy are the reverse of those described as producing ATROPHY (*q.v.*). They are concisely stated by Sir James Paget as being chiefly or only three, namely: (1) the increased exercise of a part in its healthy functions; (2) an increased accumulation in the blood of the particular materials which a part appropriates to its nutrition or in secretion; and (3) an increased afflux of healthy blood.

Illustrations are furnished of the first of these conditions by the high development of muscular tissue under habitual active exercise; of the second in the case of obesity, which is an hypertrophy of the fatty tissues, the elements of which are furnished by the blood; and of the third in the occasional overgrowth of hair in the neighbourhood of parts which are the seat of inflammation. Obviously therefore, in many instances, hypertrophy cannot be regarded as a deviation from health, but rather on the contrary as indicative of a high degree of nutrition and physical power. Even in those cases where it is found associated with disease, it is often produced as a salutary effort of nature to compensate for obstructions or other difficulties which have arisen in the system, and thus to ward off evil consequences. No better example of this can be seen than in the case of certain forms of heart disease, where from defect at some of the natural orifices of that organ the onward flow of the blood is interfered with, and would soon give rise to serious embarrassment to the circulation, were it not that behind the seat of obstruction the heart gradually becomes hypertrophied, and thus acquires greater propelling power to overcome the resistance in front. Again, it has been noticed, in the case of certain double organs such as the kidneys, that when one has been destroyed by disease the other has become hypertrophied to such a degree as enables it to discharge the functions of both.

Hypertrophy may, however, in certain circumstances constitute a disease, as in goitre and elephantiasis (*q.v.*), and also in the case of certain tumours and growths (such as cutaneous excrescences, fatty tumours, mucous polypi, &c.), which are simply enlargements of normal textures. Hypertrophy does not in all cases involve an increase in bulk; for, just as in atrophy there may be no diminution in the size of the affected organ, so in hypertrophy there may be no increase. This is apt to be the case where certain only of the elements of an organ undergo increase, while the others remain unaffected or are actually atrophied by the pressure of the hypertrophied tissue, as is seen in the disease known as cirrhosis of the liver.

A spurious hypertrophy is observed in the rare disease to which G. B. Duchenne applied the name of *pseudo-hypertrophic paralysis*. This ailment, which appears to be confined to children, consists essentially of a progressive loss of power accompanied with a remarkable enlargement of certain muscles or groups of muscles, more rarely of the whole muscular system. This increase of bulk is, however, not a true hypertrophy, but rather an excessive development of connective tissue in the substance of the muscles, the proper texture of which tends in consequence to undergo atrophy or degeneration. The appearance presented by a child suffering from this disease is striking. The attitude and gait are remarkably altered, the child standing with shoulders thrown back, small of the back deeply curved inwards, and legs wide apart, while walking is accompanied with a peculiar swinging or rocking movement. The calves of the legs, the buttocks, the muscles of the back, and occasionally other muscles, are seen to be unduly enlarged, and contrast strangely with the general feebleness. The progress of the disease is marked by increasing failure of locomotory power, and ultimately by complete paralysis of the limbs. The malady is little amenable to treatment, and, although often prolonged for years, generally proves fatal before the period of maturity.

**HYPNOTISM**, a term now in general use as covering all that pertains to the art of inducing the hypnotic state, or hypnosis, and to the study of that state, its conditions, peculiarities and effects. Hypnosis is a condition, allied to normal sleep (*Gr. ὕπνος*), which can be induced in a large majority of normal persons. Its most characteristic and constant symptom is the increased suggestibility of the subject (see SUGGESTION).

Other symptoms are very varied and differ widely in different subjects and in the same subject at different times. There can be no doubt that the increased suggestibility and all the other symptoms of hypnosis imply some abnormal condition of the brain of a temporary and harmless nature. It would seem that in all ages and in almost all countries individuals have occasionally fallen into abnormal states of mind more or less closely resembling the hypnotic state, and have thereby excited the superstitious wonder of their fellows. In some cases the state has been deliberately induced, in others it has appeared spontaneously, generally under the influence of some emotional excitement. The most familiar of these allied states is the somnambulism or sleep-walking to which some persons seem to be hereditarily disposed. Of a rather different type are the states of ecstasy into which religious enthusiasts have occasionally fallen and which were especially frequent among the peoples of Europe during the middle ages. While in this condition individuals have appeared to be insensitive to all impressions made on their sense-organs, even to such as would excite acute pain in normal persons, have been capable of maintaining rigid postures for long periods of time, have experienced vivid hallucinations, and have produced, through the power of the imagination, extraordinary organic changes in the body, such as the bloody stigmata on the hands and feet in several well-attested instances. It has been proved in recent years that effects of all these kinds may be produced by hypnotic suggestion. Different again, but closely paralleled by some subjects in hypnosis, is the state of *latah* into which a certain proportion of persons of the Malay race are liable to fall. These persons, if their attention is suddenly and forcibly drawn to any other person, will begin to imitate his every action and attitude, and may do so in spite of their best efforts to restrain their imitative movements. Among the half-bred French-Canadians of the forest regions of Canada occur individuals, known as "jumpers," who are liable to fall suddenly into a similar state of abject imitativeness, and the same peculiar behaviour has been observed among some of the remote tribes of Siberia.

The deliberate induction of states identical with, or closely allied to, hypnosis is practised by many barbarous and savage peoples, generally for ceremonial purposes. Thus, certain dervishes of Algiers are said to induce in themselves, by the aid of the sound of drums, monotonous songs and movements, a state in which they are insensitive to pain, and a similar practice of religious devotees is reported from Tibet. Perhaps the most marvellous achievement among well-attested cases of this sort is that of certain *yogis* of Hindustan; by long training and practice they seem to acquire the power of arresting almost completely all their vital functions. An intense effort of abstraction from the impressions of the outer world, a prolonged fixation of the eyes upon the nose or in some other strained position and a power of greatly slowing the respiration, these seem to be important features of their procedure for the attainment of their abnormal states.

In spite of the wide distribution in time and space, and the not very infrequent occurrence, of these instances of states identical with or allied to hypnosis, some three centuries of enthusiastic investigation and of bitter controversy were required to establish the occurrence of the hypnotic state among the facts accepted by the world of European science. Scientific interest in them may be traced back at least as far as the end of the 16th century. Paracelsus had founded the "sympathetic system" of medicine, according to which the stars and other bodies, especially magnets, influence men by means of a subtle emanation or fluid that pervades all space. J. B. van Helmont, a distinguished man of science of the latter part of the 16th century, extended this doctrine by teaching that a similar magnetic fluid radiates from men, and that it can be guided by their wills to influence directly the minds and bodies of others. In the middle of the 17th century there appeared in England several persons who claimed to have the power of curing diseases by stroking with the hand. Notable amongst these was Valentine Greatrakes, of Affane, in the county of Waterford, Ireland, who was born in

February 1628, and who attracted great attention in England by his supposed power of curing the king's evil, or scrofula. Many of the most distinguished scientific and theological men of the day, such as Robert Boyle and R. Cudworth, witnessed and attested the cures supposed to be effected by Greatrakes, and thousands of sufferers crowded to him from all parts of the kingdom. About the middle of the 18th century John Joseph Gassner, a Roman Catholic priest in Swabia, took up the notion that the majority of diseases arose from demoniacal possession, and could only be cured by exorcism. His method was undoubtedly similar to that afterwards followed by Mesmer and others, and he had an extraordinary influence over the nervous systems of his patients. Gassner, however, believed his power to be altogether supernatural.

But it was not until the latter part of the 18th century that the doctrine of a magnetic fluid excited great popular interest and became the subject of fierce controversy in the scientific world. F. A. Mesmer (*q.v.*), a physician of Vienna, was largely instrumental in bringing the doctrine into prominence. He developed it by postulating a specialized variety of magnetic fluid which he called *animal magnetism*; and he claimed to be able to cure many diseases by means of this animal magnetism, teaching, also, that it may be imparted to and stored up in inert objects, which are thereby rendered potent to cure disease.

It would seem that Mesmer himself was not acquainted with the artificial somnambulism which for nearly a century was called mesmeric or magnetic sleep, and which is now familiar as hypnosis of a well-marked degree. It was observed and described about the year 1780 by the marquis de Puységur, a disciple of Mesmer, who showed that, while subjects were in this state, not only could some of their diseases be cured, but also their movements could be controlled by the "magnetizer," and that they usually remembered nothing of the events of the period of sleep when restored to normal consciousness. These are three of the most important features of hypnosis, and the modern study of hypnotism may therefore be said to have been initiated at this date by Puységur. For, though it is probable that this state had often been induced by the earlier magnetists, they had not recognized that the peculiar behaviour of their patients resulted from their being plunged into this artificial sleep, but had attributed all the symptoms they observed to the direct physical action of external agents upon the patients.

The success of Mesmer and his disciples, especially great in the fashionable world, led to the appointment in Paris of a royal commission for the investigation of their claims. The commission, which included men of great eminence, notably A. L. Lavoisier and Benjamin Franklin, reported in the year 1784 that it could not accept the evidence for the existence of the magnetic fluid; but it did not express an opinion as to the reality of the cures said to be effected by its means, nor as to the nature of the magnetic sleep. This report and the social upheavals of the following years seem to have abolished the public interest in "animal magnetism" for the space of one generation; after which Alexandre Bertrand, a Parisian physician, revived it by his acute investigations and interpretations of the phenomena. Bertrand was the first to give an explanation of the facts of the kind that is now generally accepted. He exhibited the affinity of the "magnetic sleep" to ordinary somnambulism, and he taught that the peculiar effects are to be regarded as due to the suggestions of the operator working themselves out in the mind and body of the "magnetized" subject, *i.e.* he regarded the influence of the magnetizer as exerted in the first instance on the mind of the subject and only indirectly through the mind upon the body. Shortly after this revival of public interest, namely in the year 1831, a committee of the Academy of Medicine of Paris reported favourably upon "magnetism" as a therapeutic agency, and before many years had elapsed it was extensively practised by the physicians of all European countries, with few exceptions, of which England was the most notable. Most of the practitioners of this period adhered to the doctrine of the magnetic fluid emanating from the operator to his patient, and the acceptance of this doctrine was commonly combined

with belief in phrenology, astrology and the influence of metals and magnets, externally applied, in curing disease and in producing a variety of strange sensations and other affections of the mind. These beliefs, claiming to rest upon carefully observed facts, were given a new elaboration and a more imposing claim to be scientifically established by the doctrine of *oddylic force* propounded by Baron Karl von Reichenbach. In this mass of ill-based assertion and belief the valuable truths of "animal magnetism" and the psychological explanations of them given by Bertrand were swamped and well-nigh lost sight of. For it was this seemingly inseparable association between the facts of hypnotism and these bizarre practices and baseless beliefs that blinded the larger and more sober part of the scientific world, and led them persistently to assert that all this group of alleged phenomena was a mass of quackery, fraud and superstition. And the fact that magnetism was practised for pecuniary gain, often in a shameless manner, by exponents who claimed to cure by its means every conceivable ill, rendered this attitude on the part of the medical profession inevitable and perhaps excusable, though not justifiable. It was owing to this baleful association that John Elliotson, one of the leading London physicians of that time, who became an ardent advocate of "magnetism" and who founded and edited the *Zoist* in the interests of the subject, was driven out of the profession. This association may perhaps be held, also, to excuse the hostile attitude of the medical profession towards James Esdaile, a surgeon, who, practising in a government hospital in Calcutta among the natives of India, performed many major operations, such as the amputation of limbs, painlessly and with the most excellent results by aid of the "magnetic" sleep. For both Elliotson and Esdaile, though honourable practitioners, accepted the doctrine of the "magnetic" fluid and many of the erroneous beliefs that commonly were bound up with it.

In 1841 James Braid, a surgeon of Manchester, rediscovered independently Bertrand's physiological and psychological explanations of the facts, carried them further, and placed "hypnotism," as he named the study, on a sound basis. Braid showed that subjects in "magnetic" sleep, far from being in a profoundly insensitive condition, are often abnormally susceptible to impressions on the senses, and showed that many of the peculiarities of their behaviour were due to suggestions, made verbally or otherwise, but unintentionally, by the operator or by onlookers.

It seems, on looking back on the history of hypnotism, that at this time it was in a fair way to secure general recognition as a most interesting subject of psychological study and a valuable addition to the resources of the physician. But it was destined once more to be denied its rights by official science and to fall back into disrepute. This was due to the coincidence about the year 1848 of two events of some importance, namely—the discovery of the anaesthetic properties of chloroform and the sudden rise of modern spiritualism. The former afforded a very convenient substitute for the most obvious practical application of hypnotism, the production of anaesthesia during surgical operations; the latter involved it once more in a mass of fraud and superstition, and, for the popular mind, drove it back to the region of the marvellous, the supernatural and the dangerous, made it, in fact, once more a branch of the black art.

From this time onward there took place a gradual differentiation of the "animal magnetism" of the 18th century into two diverging branches, hypnotism and spiritualism, two branches which, however, are not yet entirely separated and, perhaps, never will be. At the same time the original system of "animal magnetism" has lived on in an enfeebled condition and is now very nearly, though not quite, extinct.

In the development of hypnotism since the time of Braid we may distinguish three lines, the physiological, the psychological and the pathological. The last may be dismissed in a few words. Its principal representative was J. M. Charcot, who taught at the Salpêtrière in Paris that hypnosis is essentially a symptom of a morbid condition of hysteria or hystero-epilepsy. This doctrine, which, owing to the great repute enjoyed by Charcot,

has done much to retard the application of hypnotism, is now completely discredited. The workers of the physiological party attached special importance to the fixation of the eyes, or to other forms of long continued and monotonous, or violent, sensory stimulation in the induction of hypnosis. They believed that by acting on the senses in these ways they induced a peculiar condition of the nervous system, which consisted in the temporary abolition of the cerebral functions and the consequent reduction of the subject to machine-like unconscious automatism. The leading exponent of this view was R. Heidenhain, professor of physiology at Breslau, whose experimental investigations played a large part in convincing the scientific world of the genuineness of the leading symptoms of hypnosis. The purely psychological doctrine of hypnosis puts aside all physical and physiological influences and effects as of but little or no importance, and seeks a psychological explanation of the induction of hypnosis and of all the phenomena. This dates from 1884, when H. Bernheim, professor of medicine at Nancy, published his work *De la Suggestion* (republished in 1887 with a second part on the therapeutics of hypnotism). Bernheim was led to the study of hypnotism by A. A. Liébeault, who for twenty years had used it very largely and successfully in his general practice among the poor of Nancy. Liébeault rediscovered independently, and Bernheim made known to the world the truths, twice previously discovered and twice lost sight of, that expectation is a most important factor in the induction of hypnosis, that increased suggestibility is its essential symptom, and that in general the operator works upon his patient by mental influences. Although they went too far in the direction of ignoring the peculiarity of the state of the brain in hypnosis and the predisposing effect of monotonous sensory stimulation, and in seeking to identify hypnosis with normal sleep, the views of the Nancy investigators have prevailed, and are now in the main generally accepted. Their methods of verbal suggestion have been adopted by leading physicians in almost all civilized countries and have been proved to be efficacious in the relief of many disorders; and as a method of psychological investigation hypnotism has proved, especially in the hands of the late Ed. Gurney, of Dr Pierre Janet and of other investigators, capable of throwing much light on the constitution of the mind, has opened up a number of problems of the deepest interest, and has done more than any other of the many branches of modern psychology to show the limitations and comparative barrenness of the old psychology that relied on introspection alone and figured as a department of general philosophy. In England, "always the last to enter into the general movement of the European mind," the prejudice, incredulity and ignorant misrepresentation with which hypnotism has everywhere been received have resisted its progress more stubbornly than elsewhere; but even in England its reality and its value as a therapeutic agent have at last been officially recognized. In 1892, just fifty years after Braid clearly demonstrated the facts and published explanations of them almost identical with those now accepted, a committee of the British Medical Association reported favourably upon hypnotism after a searching investigation; it is now regularly employed by a number of physicians of high standing, and the formation in 1907 of "The Medical Society for the Study of Suggestive Therapeutics" shows that the footing it has gained is likely to be made good.

*Induction of Hypnosis.*—It has now been abundantly proved that hypnosis can be induced in the great majority of normal persons, provided that they willingly submit themselves to the process. Several of the most experienced operators have succeeded in hypnotizing more than 90% of the cases they have attempted, and most of them are agreed that failure to induce hypnosis in any case is due either to lack of skill and tact on the part of the operator, or to some unfavourable mental condition of the subject. It has often been said that some races or peoples are by nature more readily hypnotizable than others; of the French people especially this has been maintained. But there is no sufficient ground for this statement. The differences that undoubtedly obtain between populations of different regions in respect to the ease or difficulty with which a large

proportion of all persons can be hypnotized are sufficiently explained by the differences of the attitude of the public towards hypnotism; in France, e.g., and especially in Nancy, hypnotism has been made known to the public chiefly as a recognized auxiliary to the better known methods of medical treatment, whereas in England the medical profession has allowed the public to make acquaintance with hypnotism through the medium of disgusting stage-performances whose only object was to raise a laugh, and has, with few exceptions, joined in the general chorus of condemnation and mistrust. Hence in France patients submit themselves with confidence and goodwill to hypnotic treatment, whereas in England it is still necessary in most cases to remove an ill-based prejudice before the treatment can be undertaken with hope of success. For the confidence and goodwill of the patient are almost essential to success, and even after hypnosis has been induced on several occasions a patient may be so influenced by injudicious friends that he cannot again be hypnotized or, if hypnotized, is much less amenable to the power of suggestion. Various methods of hypnotization are current, but most practitioners combine the methods of Braid and of Bernheim. After asking the patient to resign himself passively into their hands, and after seating him in a comfortable arm-chair, they direct him to fix his eyes upon some small object held generally in such a position that some slight muscular strain is involved in maintaining the fixation; they then suggest to him verbally the idea or expectation of sleep and the sensations that normally accompany the oncoming of sleep, the heaviness of the eyes, the slackness of the limbs and so forth; and when the eyes show signs of fatigue, they either close them by gentle pressure or tell the subject to close them. Many also pass their hands slowly and regularly over the face, with or without contact. The old magnetizers attached great importance to such "passes," believing that by them the "magnetic fluid" was imparted to the patient; but it seems clear that, in so far as they contribute to induce hypnosis, it is in their character merely of gentle, monotonous, sensory stimulations. A well-disposed subject soon falls into a drowsy state and tends to pass into natural sleep; but by speech, by passes, or by manipulating his limbs the operator keeps in touch with him, keeps his waning attention open to the impressions he himself makes. Most subjects then find it difficult or impossible to open their eyes or to make any other movement which is forbidden or said to be impossible by the operator, although they may be fully conscious of all that goes on about them and may have the conviction that if they did but make an effort they could break the spell. This is a light stage of hypnosis beyond which some subjects can hardly be induced to pass and beyond which few pass at the first attempt. But on successive occasions, or even on the first occasion, a favourable subject passes into deeper stages of hypnosis. Many attempts have been made to distinguish clearly marked and constantly occurring stages. But it seems now clear that the complex of symptoms displayed varies in all cases with the idiosyncrasies of the subject and with the methods adopted by the operator. In many subjects a waxy rigidity of the limbs appears spontaneously or can be induced by suggestion; the limbs then retain for long periods without fatigue any position given them by the operator. The most susceptible subjects pass into the stage known as artificial somnambulism. In this condition they continue to respond to all suggestions made by the operator, but seem as insensitive to all other impressions as a person in profound sleep or in coma; and on awaking from this condition they are usually oblivious of all that they have heard, said or done during the somnambulistic period. When in this last condition patients are usually more profoundly influenced by suggestions, especially post-hypnotic suggestions, than when in the lighter stages; but the lighter stages suffice for the production of many therapeutic effects. When a patient is completely hypnotized, his movements, his senses, his ideas and, to some extent, even the organic processes over which he has no voluntary control become more or less completely subject to the suggestions of the operator; and usually he is responsive to the operator alone (*rapport*) unless he is instructed by the

later to respond also to the suggestions of other persons. If left to himself the hypnotized subject will usually awake to his normal state after a period which is longer in proportion to the depth of hypnosis; and the deeper stages seem to pass over into normal sleep. The subject can in almost every case be brought quickly back to the normal state by the verbal command of the operator.

*The Principal Effects produced by Suggestion during Hypnosis.*—The subject may not only be rendered incapable of contracting any of the muscles of the voluntary system, but may also be made to use them with extraordinarily great or sustained force (though by no means in all cases). He can with difficulty refrain from performing any action commanded by the operator, and usually carries out any simple command without hesitation. Any one of the sense-organs, or any sensory region such as the skin or deep tissues of one limb may be rendered anaesthetic by verbal suggestion, aided perhaps by some gentle manipulation of the part. On this fact depends the surgical application of hypnosis. Sceptical observers are always inclined to doubt the genuineness of the anaesthesia produced by a mere word of command, but the number of surgical operations performed under hypnotic anaesthesia suffices to put its reality beyond all question. A convincing experiment may, however, be made on almost any good subject. Anaesthesia of one eye may be suggested and its reality tested in the following way. Anaesthesia of the left eye may be suggested, and the subject be instructed to fix his gaze on a distant point and to give some signal as soon as he sees the operator's finger in the peripheral field of view. The operator then brings his finger slowly from behind and to the right forwards towards the subject's line of sight. The subject signals as soon as it crosses the normal temporal boundary of the field of view of the right eye. The operator then brings his finger forward from a point behind and to the left of the subject's head. The subject allows it to cross the monocular field of the left eye and signals only when the finger enters the field of vision of the right eye across its nasal boundary. Since few persons, other than physiologists or medical men, are aware of the relations of the boundaries of the monocular and binocular fields of vision, the success of this experiment affords proof that the finger remains invisible to the subject during its passage across the monocular field of the left eye. The abolition of pain, especially of neuralgias, the pain of rheumatic and other inflammations, which is one of the most valuable applications of hypnosis, is an effect closely allied to the production of such anaesthesia.

It has often been stated that in hypnosis the senses may be rendered extraordinarily acute or hyperaesthetic, so that impressions too faint to affect the senses of the normal person may be perceived by the hypnotized subject; but in view of the fact that most observers are ignorant of the normal limits of sensitivity and discrimination, all such statements must be received with caution, until we have more convincing evidence than has yet been brought forward.

*Positive and Negative Hallucinations* are among the most striking effects of hypnotic suggestion. A good subject may be made to experience an hallucinatory perception of almost any object, the more easily the less unusual and out of harmony with the surroundings is the suggested object. He may, e.g., be given a blank card and asked if he thinks it a good photograph of himself. He may then assent and describe the photograph in some detail, and, what is more astonishing, he may pick out the card as the one bearing the photograph, after it has been mixed with other similar blank cards. This seems to be due to the part played by *points de repère*, insignificant details of surface or texture, which serve as an objective basis around which the hallucinatory image is constructed by the pictorial imagination of the subject. A negative hallucination may be induced by telling the subject that a certain object or person is no longer present, when he ignores in every way that object or person. This is more puzzling than the positive hallucination and will be referred to again in discussing the theory of hypnosis. Both kinds of hallucination tend to be systematically and logically

developed; if, e.g., the subject is told that a certain person is no longer visible, he may become insensitive to impressions made on any sense by that person.

*Delusions, or false beliefs* as to their present situation or past experiences may be induced in many subjects. On being assured that he is some other person, or that he is in some strange situation, the subject may accept the suggestion and adapt his behaviour with great histrionic skill to the induced delusion. It is probable that many, perhaps all, subjects are vaguely aware, as we sometimes are in dreams, that the delusions and hallucinations they experience are of an unreal nature. In the lighter stages of hypnosis a subject usually remembers the events of his waking life, but in the deeper stages he is apt, while remembering the events of previous hypnotic periods, to be incapable of recalling his normal life; but in this respect, as also in respect to the extent to which on awaking he remembers the events of the hypnotic period, the suggestions of the operator usually play a determining part.

Among the organic changes that have been produced by hypnotic suggestion are slowing or acceleration of the cardiac and respiratory rhythms; rise and fall of body-temperature through two or three degrees; local erythema and even inflammation of the skin with vesication or exudation of small drops of blood; evacuation of the bowel and vomiting; modifications of the secretory activity of glands, especially of the sweat-glands.

*Post-hypnotic Effects.*—Most subjects in whom any appreciable degree of hypnosis can be induced show some susceptibility to post-hypnotic suggestion, i.e. they may continue to be influenced, when restored to the fully waking state, by suggestions made during hypnosis, more especially if the operator suggests that this shall be the case; as a rule, the deeper the stage of hypnosis reached, the more effective are post-hypnotic suggestions. The therapeutic applications of hypnosis depend in the main upon this post-hypnotic continuance of the working of suggestions. If a subject is told that on awaking, or on a certain signal, or after the lapse of a given interval of time from the moment of awaking, he will perform a certain action, he usually feels some inclination to carry out the suggestion at the appropriate moment. If he remembers that the action has been suggested to him he may refuse to perform it, and if it is one repugnant to his moral nature, or merely one that would make him appear ridiculous, he may persist in his refusal. But if the action is of a simple and ordinary nature he will usually perform it, remarking that he cannot be comfortable till it is done. If the subject was deeply hypnotized and remembers nothing of the hypnotic period, he will carry out the post-hypnotic suggestion in almost every case, no matter how complicated or absurd it may be, so long as it is not one from which his normal self would be extremely averse; and he will respond appropriately to the suggested signals, although he is not conscious of their having been named; he will often perform the action in a very natural way, and will, if questioned, give some more or less adequate reason for it. Such actions, determined by post-hypnotic suggestions of which no conscious memory remains, may be carried out even after the lapse of many weeks or even months. Inhibitions of movement, anaesthesia, positive and negative hallucinations, and delusions may also be made to persist for brief periods after the termination of hypnosis; and organic effects, such as the action of the bowels, the oncoming of sleep and the cessation of pain, may be determined by post-hypnotic suggestion. In short, it may be said that in a good subject all the kinds of suggestion which will take effect during hypnosis will also be effective if given as post-hypnotic suggestions.

*Theory of the Hypnotic State.*—Very many so called theories of hypnosis have been propounded, but few of them demand serious consideration. One author ascribes all the symptoms to cerebral anaemia, another to cerebral congestion, a third to temporary suppression of the functions of the cerebrum, a fourth to abnormal cerebral excitability, a fifth to the independent functioning of one hemisphere. Another seeks to explain all the facts by saying that in hypnosis our normal consciousness disappears and is replaced by a dream-consciousness; and yet



another by the assumption that every human organism comprises two mental selves or personalities, a normal one and one which only comes into activity during sleep and hypnosis. Most of these "theories" would, even if true, carry us but a little way towards a complete understanding of the facts. There is, however, one theory or principle of explanation which is now gradually taking shape under the hands of a number of the more penetrating workers in this field, and which does seem to render intelligible many of the principle facts. This is the theory of *mental dissociation*.

It is clear that a theory of hypnosis must attempt to give some account of the peculiar condition of the brain which is undoubtedly present as an essential feature of the state. It is therefore not enough to say with Bernheim that hypnosis is a state of abnormally increased suggestibility produced by suggestion; nor is it enough, though it is partially true, to say that it is a state of mono-idealism or one of abnormally great concentration of attention. Any theory must be stated in terms of physiological psychology, it must take account of both the psychical and the nervous peculiarities of the hypnotic state; it must exhibit the physiological condition as in some degree similar to that obtaining in normal sleep; but principally it must account for that abnormally great receptivity for ideas, and that abnormally intense and effective operation of ideas so received, which constitute abnormally great suggestibility.

The theory of mental dissociation may be stated in purely mental terms, or primarily in terms of nervous structure and function, and the latter mode of statement is probably the more profitable at the present time. The increased effectiveness of ideas might be due to one of two conditions: (1) it might be that certain tracts of the brain or the whole brain were in a condition of abnormally great excitability; or (2) an idea might operate more effectively in the mind and on the body, not because it, or the underlying brain-process was more intense than normally, but because it worked out its effects free from the interference of contrary or irrelevant ideas that might weaken its force. It is along this second line that the theory of mental dissociation attempts to explain the increased suggestibility of hypnosis. To understand the theory we must bear in mind the nature of mental process in general and of its nervous concomitants. Mental process consists in the interplay, not merely of ideas, but rather of complex dispositions which are the more or less enduring conditions of the rise of ideas to consciousness. Each such disposition seems capable of remaining inactive or quiescent for long periods, and of being excited in various degrees, either by impressions made upon the sense-organs or by the spread of excitement from other dispositions. When its excitement rises above a certain pitch of intensity, the corresponding idea rises to the focus of consciousness. These dispositions are essential factors of all mental process, the essential conditions of all mental retention. They may be called simply mental dispositions, their nature being left undefined; but for our present purpose it is advantageous to regard them as neural dispositions, complex functional groups of nervous elements or neurones. The neurones of each such group must be conceived as being so intimately connected with one another that the excitement of any part of the group at once spreads through the whole group or disposition, so that it always functions as a unit. The whole cerebrum must be conceived as consisting of a great number of such dispositions, inextricably interwoven, but interconnected in orderly fashion with very various degrees of intimacy; groups of dispositions are very intimately connected to form neural systems, so that the excitement of any one member of such a system tends to spread in succession to all the other members. On the other hand, it is a peculiarity of the reciprocal relations of all such dispositions and systems that the excitement of any one to such a degree that the corresponding idea rises to consciousness prevents or inhibits the excitement of others, *i.e.* all of them are in relations of reciprocal inhibition with one another (see *MUSCLE AND NERVE*). The excitement of dispositions associated together to form a system tends towards some end which, either immediately or remotely, is an action,

a bodily movement, in many cases a movement of the organs of speech only. Now we know from many exact experiments that the neural dispositions act and react upon one another to some extent, even when they are excited only in so feeble a degree that the corresponding ideas do not rise to consciousness. In the normal state of the brain, then, when any idea is present to consciousness, the corresponding neural disposition is in a state of dominant excitement, but the intensity of that excitement is moderated, depressed or partially inhibited by the sub-excitement of many rival or competing dispositions of other systems with which it is connected. Suppose now that all the nervous connexions between the multitudinous dispositions of the cerebrum are by some means rendered less effective, that the association-paths are partially blocked or functionally depressed; the result will be that, while the most intimate connexions, those between dispositions of any one system remain functional or permeable, the weaker less intimate connexions, those between dispositions belonging to different systems will be practically abolished for the time being; each system of dispositions will then function more or less as an isolated system, and its activity will no longer be subject to the depressing or inhibiting influence of other systems; therefore each system, on being excited in any way, will tend to its end with more than normal force, being freed from all interferences; that is to say, each idea or system of ideas will tend to work itself out and to realize itself in action immediately, without suffering the opposition of antagonistic ideas which, in the normal state of the brain, might altogether prevent its realization in action.

The theory of mental dissociation assumes that the abnormal state of the brain that obtains during hypnosis is of this kind, a temporary functional depression of all, or of many of the associations or nervous links between the neural dispositions; that is, it regards hypnosis as a state of *relative dissociation*. The lighter the stage of hypnosis the slighter is the degree of dissociation, the deeper the stage the more nearly complete is the dissociation.

It is not essential that the theory should explain in what change this stage of dissociation consists, but a view compatible with all that we know of the functions of the central nervous system may be suggested. The connexions between neural dispositions involve synapses or cell-junctions, and these seem to be the places of variable resistance which demarcate the dispositions and systems; and there is good reason to think that their resistances vary with the state of the neurones which they connect, being lowered when these are excited and raised when their excitement ebbs. Now, in the waking state, the varied stimuli, which constantly rain upon all the sense-organs, maintain the whole cerebrum in a state of sub-excitement, keep all the cerebral neurones partially charged with free nervous energy. When the subject lies down to sleep or submits himself to the hypnotizer he arrests as far as possible the flow of his thoughts, and the sensory stimuli are diminished in number and intensity. Under these conditions the general cerebral activity tends to subside, the free energy with which the cerebral neurones are charged ebbs away, and the synaptic resistances rise proportionally; then the effect of sensory impressions tends to be confined to the lower nervous level, and the brain tends to come to rest. If this takes place the condition of normal sleep is realized. But in inducing hypnosis the operator, by means of his words and manipulations, keeps one system of ideas and the corresponding neural system in activity, namely, the ideas connected with himself; thus he keeps open one channel of entry to the brain and mind, and through this one open channel he can introduce whatever ideas he pleases; and the ideas so introduced then operate with abnormally great effect because they work in a free field, unchecked by rival ideas and tendencies.

This theory of relative dissociation has two great merits: in the first place it goes far towards enabling us to understand in some degree most of the phenomena of hypnosis; secondly, we have good evidence that dissociation really occurs in deep

hypnosis and in some allied states. Any one may readily work up for himself the application of the theory to the explanation of the power of the operator's suggestions to control movement, to induce anaesthesia, hallucinations and delusions, and to exert on the organic processes an influence greater than can be exerted by mental processes in the normal state of the brain. But the positive evidence of the occurrence of dissociation is a matter of great psychological interest and its nature must be briefly indicated. The phenomena of automatic speech and writing afford the best evidence of cerebral dissociation. Many persons can, while in an apparently normal or but very slightly abnormal condition, produce automatic writing, *i.e.* intelligibly written sentences, in some cases long connected passages, of whose import they have no knowledge, their self-conscious intelligence being continuously directed to some other task. The carrying out of post-hypnotic suggestions affords in many cases similar evidence. Thus a subject may be told that after waking he will perform some action when a given signal, such as a cough, is repeated for the fifth time. In the post-hypnotic state he remains unaware of his instructions, is not conscious of noting the signals, and yet carries out the suggestion at the fifth signal, thereby proving that the signals have been in some sense noted and counted. Many interesting varieties of this experiment have been made, some of much greater complexity; but all agreeing in indicating that the suggested action is prepared for and determined by cerebral processes that do not affect the consciousness of the subject, but seem to occur as a system of processes detached from the main stream of cerebral activity; that is to say, they imply the operation of relatively dissociated neural systems.

Many authorities go further than this; they argue that, since actions of the kind described are determined by processes which involve operations, such as counting, that we are accustomed to regard as distinctly mental in character and that normally involve conscious activity, we must believe that in these cases also consciousness or psychical activity is involved, but that it remains as a separate system or stream of consciousness concurrent with the normal or personal consciousness.

In recent years the study of various abnormal mental states, especially the investigations by French physicians of severe forms of hysteria, have brought to light many facts which seem to justify this assumption of a secondary stream of consciousness, a co- or sub-consciousness coexistent with the personal consciousness; although, from the nature of the case, an absolute proof of such co-consciousness can hardly be obtained. The co-consciousness seems to vary in degree of complexity and coherence from a mere succession of fragmentary sensations to an organized stream of mental activity, which may rival in all respects the primary consciousness; and in cases of the latter type it is usual to speak of the presence of a secondary personality. The co-consciousness seems in the simpler cases, *e.g.* in cases of hysterical or hypnotic anaesthesia, to consist of elements split off from the normal primary consciousness, which remains correspondingly poorer; and the assumption is usually made that such a stream of co-consciousness is the psychical correlate of groups and systems of neurones dissociated from the main mass of cerebral neurones. If, in spite of serious objections, we entertain this conception, we find that it helps us to give some account of various hypnotic phenomena that otherwise remain quite inexplicable; some such conception seems to be required more particularly by the facts of negative hallucination and the execution of post-hypnotic suggestions involving such operations as counting and exact discrimination without primary consciousness.

*Supernormal Hypnotic Phenomena.*—The facts hitherto considered, strange and perplexing as many of them are, do not seem to demand for their explanation any principles of action fundamentally different from those operative in the normal human mind. But much of the interest that has centred in hypnotism in recent years has been due to the fact that some of its manifestations seem to go beyond all such principles of explanation, and to suggest the reality of modes of influence and action that science has not hitherto recognized. Of these

by far the best attested are the post-hypnotic unconscious reckoning of time and telepathy or "thought-transference" (for the latter see TELEPATHY). The post-hypnotic reckoning and noting of the lapse of time seems in some instances to have been carried out, in the absence of all extraneous aids and with complete unconsciousness on the part of the normal personality, with such extreme precision that the achievement cannot be accounted for by any intensification of any faculty that we at present recognize or understand. Thus, Dr Milne Bramwell has reported the case of a patient who, when commanded in hypnosis to perform some simple action after the lapse of many thousands of minutes, would carry out the suggestion punctually to the minute, without any means of knowing the exact time of day at which the suggestion was given or the time of day at the moment its performance fell due; more recently a similar case, even more striking in some respects, has been carefully observed and described by Dr T. W. Mitchell. Other reported phenomena, such as teleaesthesia or clairvoyance, and telekinesia, are hardly sufficiently well attested to demand serious consideration in this place.

*Medical Applications of Hypnotism.*—The study and practice of hypnotism is not yet, and probably never will be, regarded as a normal part of the work of the general practitioner. Its successful application demands so much time, tact, and special experience, that it will probably remain, as it is now, and as it is perhaps desirable that it should remain, a specialized branch of medical practice. In England it is only in recent years that it has been possible for a medical man to apply it in his practice without incurring professional odium and some risk of loss of reputation. That, in certain classes of cases, it may effect a cure or bring relief when all other modes of treatment are of no avail is now rapidly becoming recognized; but it is less generally recognized that it may be used with great advantage as a supplement to other modes of treatment in relieving symptoms that are accentuated by nervous irritability or mental disturbance. A third wide field of usefulness lies before it in the cure of undesirable habits of many kinds. Under the first heading may be put insomnia, neuralgia, neurasthenia, hysteria in almost all its many forms; under the second, inflammations such as that of chronic rheumatism, contractures and paralyses resulting from gross lesion of the brain, epilepsy, dyspepsia, menstrual irregularities, sea-sickness; under the third, inebriety, the morphia and other drug habits, nail-biting, *enuresis nocturna*, masturbation, constipation, facial and other twitchings. In pronounced mental diseases hypnotism seems to be almost useless; for in general terms it may be said that it can be applied most effectively where the brain, the instrument through which it works, is sound and vigorous. The widespread prejudice against the use of hypnotism is no doubt largely due to the marvellous and (to most minds) mysterious character of the effects producible by its means; and this prejudice may be expected to diminish as our insight into the mode of its operation deepens. The more purely bodily results achieved by hypnotic suggestion become in some degree intelligible if we regard it as a powerful means of diverting nervous energy from one channel or organ to others, so as to give physiological rest to an overworked organ or tissue, or so as to lead to the atrophy of one nervous habit and the replacement of it by a more desirable habit. And in the cure of those disorders which involve a large mental element the essential part played by it is to drive out some habitually recurrent idea and to replace it by some idea, expectation or conviction of healthy tendency.

It seems clear that the various systems of "mind-curing" in the hands of persons lacking all medical training, which are now so frequently the cause of distressing and needless disasters, owe their rapid spread to the fact that the medical profession has hitherto neglected to attach sufficient importance to the mental factor in the causation and cure of disease; and it seems clear, too, that a more general and more intelligent appreciation of the possibilities of hypnotic treatment would constitute the best means at the disposal of the profession for combating this growing evil.

*The Dangers of Hypnotism.*—Much has been written on this head of late years, and some of the enthusiastic advocates of hypnotic treatment have done harm to their cause by ignoring or denying in a too thoroughgoing manner the possibility of undesirable results of the spread of the knowledge and practice of hypnotism. Like all powerful agencies, chloroform or morphia, dynamite or strong electric currents, hypnotic suggestion can only be safely used by those who have special knowledge and experience, and, like them, it is liable to abuse. There is little doubt that, if a subject is repeatedly hypnotized and made to entertain all kinds of absurd delusions and to carry out very frequently posthypnotic suggestions, he may be liable to some ill-defined harm; also, that an unprincipled hypnotizer might secure an undue influence over a naturally weak subject.

But there is no ground for the belief that hypnotic treatment, applied with good intentions and reasonable care and judgment, does or can produce deleterious effects, such as weakening of the will or liability to fall spontaneously into hypnosis. All physicians of large experience in hypnotic practice are in agreement in respect to this point. But some difference of opinion exists as to the possibility of deliberately inducing a subject to commit improper or criminal actions during hypnosis or by posthypnotic suggestion. There is, however, no doubt that subjects retain even in deep hypnosis a very considerable power of resistance to any suggestion that is repugnant to their moral nature; and it has been shown that, on some cases in which a subject in hypnosis is made to perform some ostensibly criminal action, such as firing an unloaded pistol at a bystander or putting poison into a cup for him to drink, he is aware, however obscurely, of the unreal nature of the situation. Nevertheless it must be admitted that a person lacking in moral sentiments might be induced to commit actions from which in the normal state he would abstain, if only from fear of punishment; and it is probable that a skilful and evil-intentioned operator could in some cases so deceive a well-disposed subject as to lead him into wrong-doing. The proper precaution against such dangers is legislative regulation of the practice of hypnotism such as is already enforced in some countries.

**BIBLIOGRAPHY.**—The literature of hypnotism has increased in volume at a rapid rate during recent years. Of recent writings the following may be mentioned as among the most important:—*Treatment by Hypnotism and Suggestion* by C. Lloyd Tuckey, M.D. (5th ed., London, 1907); *Hypnotism, its History, Practice and Theory*, by J. Milne Bramwell, M.B. (2nd ed., London, 1906); *Hypnotism*, by Albert Moll (5th ed., London, 1901). All these three books give good general accounts of hypnotism, the first being the most strictly medical, the last the most general in its treatment. See also *Hypnotism, or Suggestion in Psycho-Therapy*, by August Forel (translated from the 5th German ed. by G. H. W. Armit, London, 1906); a number of papers by Ed. Gurney, and by Ed. Gurney and F.W.H. Myers in *Proc. of the Soc. for Psychological Research*, especially "The Stages of Hypnotism," in vol. ii.; also some more recent papers in the same journal by other hands; chapter on Hypnotism in *Human Personality and its Survival of bodily Death*, by F. W. H. Myers (London, 1903); *The Psychology of Suggestion*, by Boris Sidis, Ph.D. (New York, 1898); "Zur Psychologie der Suggestion" by Prof. Th. Lipp, and other papers in the *Zeitschrift für Hypnotismus*. Of special historical interest are the following:—*Étude sur le magnétisme*, par A. A. Liébeault (Paris, 1883); *Hypnotisme, suggestion, psycho-thérapie*, par Prof. Bernheim (Paris, 1891); *Braid on Hypnotism* (a new issue of James Braid's *Neurypnology*), edited by A. E. Waite (London, 1899); *Traité du somnambulisme*, by A. Bertrand (Paris, 1826). A full bibliography is appended to Dr Milne Bramwell's *Hypnotism*. (W. McD.)

**HYPOCAUST** (Gr. ὑποκαυστον: ὑπό, beneath, and καίνω, to burn), the term given to the chamber formed under the floors of the Roman baths, through which the hot air from the furnace passed, sometimes to a single flue, as in the case of the *lepidarium*, but in the *calidarium* and sweating-room to a series of flues placed side by side forming the lining of the walls. The floor of the hot-air chamber consisted of tiles, 2 ft. square, laid on a bed of concrete; on this a series of dwarf piers 2 ft. high were built of 8-in. square tiles placed about 16 in. apart, which carried the floor of the hall or room; this floor was formed of a bed of concrete covered with layers of pounded bricks and marble cement, on which the marble pavement in slabs or tesserae was laid. In colder countries, as for instance in Germany and

England, the living rooms were all heated in a similar way, and round Trèves (Trier) both systems have been found in two or three Roman villas, with the one flue for the ordinary rooms and several wall flues for the hot baths. In England these hypocausts are found in every Roman settlement, and the chief interest in these is centred in the magnificent mosaic pavements with which the principal rooms were laid. Many of the pavements found in London and elsewhere have been preserved in the British or the Guildhall museums; and in some of the provincial towns, such as Leicester and Lincoln, they remain *in situ* many feet below the present level of the town.

**HYPOCHONDRIASIS** (synonyms—"the spleen," "the vapours"), a medical term (from τὸ ὑποχόνδριον, τὰ ὑποχόνδρια, the soft part of the body immediately under the χόνδρος or cartilage of the breast-bone) given by the ancients, and indeed by physicians down to the time of William Cullen, to diseases or derangements of one or more of the abdominal viscera. Cullen (*Clinical Lectures*, 1777) classified it amongst nervous diseases, and Jean Pierre Falret (1794-1870) more fully described it as a morbid condition of the nervous system characterized by depression of feeling and false beliefs as to an impaired state of the health. The subjects of hypochondriasis are for the most part members of families in which hereditary predisposition to degradation of the nervous system is strong, or those who have suffered from morbid influences affecting this system during the earlier years of life. It may be dependent on depressing disease affecting the general system, but under such circumstances it is generally so complicated with the symptoms of hysteria as to render differentiation difficult (see HYSTERIA). Hypochondriasis is often handed down from one generation to another in its individual form, but it is also not unfrequently to be met with in an individual as the sole manifestation in him of a family tendency to insanity. In its most common form it is manifested by simple false belief as to the state of the health, the intellect being otherwise unaffected. We may instance the "vapourish" woman or the "splenetic" as terms society has applied to its milder manifestations. Such persons are constantly asserting a weak state of health although no palpable cause can be discovered. In its more definite phases pain or uneasy sensations are referred by the patient to some particular region, generally the abdomen, the heart or the head. That these are subjective is apparent from the fact that the general health is good; all the functions of the various systems are duly performed; the patient eats and sleeps well; and, when any circumstance temporarily overrides the false belief, he is happy and comfortable. No appeal to the reason is of any avail, and the hypochondriac idea so dominates his existence as to render him unable to perform the ordinary duties of life. In its most aggravated form hypochondriasis amounts to actual insanity, delusions arising as to the existence of living creatures in the intestines or brain, or to the effect that the body is materially changed; e.g. into glass, wood, &c. The symptoms of this condition may be remittent; they may even disappear for years, and only return on the advent of some exciting cause. Suicide is occasionally committed in order to escape from the constant misery. Recovery can only be looked for by placing the patient under such morally hygienic conditions as may help to turn his mind to other matters. (See also NEUROPATHOLOGY.)

**HYPOCRISY**, pretence, or false assumption of a high character, especially in regard to religious belief or practice. The Greek ὑπόκρισις, from which the word is derived through the Old French, meant primarily the acting of a part on the stage, from ὑποκρίνεσθαι, to give an answer, to speak dialogue, play a part on the stage, hence to practice dissimulation.

**HYPOSTASIS**, in theology, a term frequently occurring in the Trinitarian controversies of the 4th and 5th centuries. According to Irenaeus (i. 5, 4) it was introduced into theology by Gnostic writers, and in earliest ecclesiastical usage appears, as among the Stoics, to have been synonymous with ὁδία. Thus Dionysius of Rome (cf. *Routh, Rel. Sacr.* iii. 373) condemns the attempt to sever the Godhead into three separate *hypostases* and three deities, and the Nicene Creed in the anathemas speaks of

ἡ ἱερίαι ὑποστάσεις ἡ οὐσίας. Alongside, however, of this persistent interchange there was a desire to distinguish between the terms, and to confine ὑπόστασις to the Divine persons. This tendency arose in Alexandria, and its progress may be seen in comparing the early and later writings of Athanasius. That writer, in view of the Arian trouble, felt that it was better to speak of οὐσία as "the common undifferentiated substance of Deity," and ὑπόστασις as "Deity existing in a personal mode, the substance of Deity with certain special properties" (οὐσία μετὰ τινων ἰδιωμάτων). At the council of Alexandria in 362 the phrase τρεῖς ὑποστάσεις was permitted, and the work of this council was supplemented by Basil, Gregory of Nazianzus and Gregory of Nyssa in the formula μία οὐσία, τρεῖς ὑποστάσεις or μία οὐσία ἐν τριῶν ὑποστάσεσιν.

The results arrived at by these Cappadocian fathers were stated in a later age by John of Damascus (*De orth. fid. iii. 6*), quoted in R. L. Outley, *The Doctrine of the Incarnation*, ii. 257.

**HYPOSTYLE**, in architecture, the term applied to a hall, the flat ceiling of which is supported by columns, as in the Hall of Columns at Karnak. In this case the columns flanking the central avenue are of greater height than those of the side aisles, and this admits of openings in the wall above the smaller columns, through which light is admitted over the aisle roof, through clerestory windows.

**HYPOSULPHITE OF SODA**, the name originally given to the substance known in chemistry as sodium thiosulphate,  $\text{Na}_2\text{S}_2\text{O}_3$ ; the earlier name is still commonly used, especially by photographers, who employ this chemical as a fixer. In systematic chemistry, sodium hyposulphite is a salt of hyposulphuric acid, to which Schützenberger gave the formula  $\text{H}_2\text{SO}_2$ , but which Bernthsen showed to be  $\text{H}_2\text{S}_2\text{O}_4$ . (See SULPHUR.)

**HYPOTHEC** (Lat. *hypotheca*, Gr. ὑπόθεσις), in Roman law, the most advanced form of the contract of pledge. A specific thing may be given absolutely to a creditor on the understanding that it is to be given back when the creditor's debt is paid; or the property in the thing may be assigned to the creditor while the debtor is allowed to remain in possession, the creditor as owner being able to take possession if his debt is not discharged. Here we have the kind of security known as pledge and mortgage respectively. In the *hypotheca*, the property does not pass to the creditor, nor does he get possession, but he acquires a preferential right to have his debt paid out of the hypothecated property; that is, he can sell it and pay himself out of the proceeds, or in default of a purchaser he can become the owner himself. The name and the principle have passed into the law of Scotland, which distinguishes between conventional hypothecs, as *botomry* and *respondentia*, and tacit hypothecs established by law. Of the latter the most important is the landlord's hypothec for rent (corresponding to distress in the law of England), which extends over the produce of the land and the cattle and sheep fed on it, and over stock and horses used in husbandry. The law of agricultural hypothec long caused much discontent in Scotland; its operation was restricted by the Hypothec Amendment (Scotland) Act 1867, and finally by the Hypothec Abolition (Scotland) Act 1880 it was enacted that the "landlord's right of hypothec for the rent of land, including the rent of any buildings thereon, exceeding two acres in extent, let for agriculture or pasture, shall cease and determine." By the same act and by the Agricultural Holdings (Scotland) Act 1883; other rights and remedies for rent, where the right of hypothec had ceased, were given to the landlord.

**HYPOTHESIS** (from Gr. ὑποθέσθαι, to put under; cf. Lat. *suppositio*, from *sub-ponere*), in ordinary language, an explanation, supposition or assumption, which is put forward in the absence of ascertained facts or causes. Both in ordinary life and in the acquisition of scientific knowledge hypothesis is all-important. A detective's work consists largely in forming and testing hypothesis. If an astronomer is confronted by some phenomenon which has no obvious explanation he may postulate some set of conditions which from his general knowledge of the subject would or might give rise to the phenomenon in question; he then tests his hypothesis until he discovers whether it does

or does not conflict with the facts. An example of this process is that of the discovery of the planet Neptune: certain perturbations of the orbit of Uranus had been observed, and it was seen that these could be explained on the hypothesis of the existence of a then unknown planet, and this hypothesis was verified by actual observation. The progress of inductive knowledge is by the formation of successive hypotheses, and it frequently happens that the demolition of one or even many hypotheses is the direct road to a new and accurate hypothesis, *i.e.* to fresh knowledge. A hypothesis may, therefore, turn out to be entirely wrong, yet it may be of the greatest practical use.

The recognition of the importance of hypotheses has led to various attempts at drawing up exact rules for their formation, but logicians are generally agreed that only very elementary principles can be laid down. Thus a hypothesis must contain nothing which is at variance with known facts or principles; it should not postulate conditions which cannot be verified empirically. J. S. Mill (*Logic* III. xiv. 4) laid down the principle that a hypothesis is not "genuinely scientific" if it is "destined always to remain a hypothesis"; it must "be of such a nature as to be either proved or disproved by comparison with observed facts"; in the same spirit Bacon said that in searching for causes in nature "Deum semper excipimus." Mill's principle, though sound in the abstract, has, except in a few cases, little practical value in determining the admissibility of hypotheses, and in practice any rule which tends to discourage hypothesis is in general undesirable. The most satisfactory check on hypothesis is expert knowledge in the particular field of research by which rigorous tests may be applied. This test is roughly of two kinds, first by the ultimate principles or presuppositions on which a particular branch of knowledge rests, and second by the comparison of correlative facts. Useful light is shed on this distinction by Lotze, who contrasts (*Logic*, § 273) *postulates* ("absolutely necessary assumptions without which the content of the observation with which we are dealing would contradict the laws of our thought") with *hypotheses*, which he defines as conjectures, which seek "to fill up the postulate thus abstractly stated by specifying the concrete causes, forces or processes, out of which the given phenomenon really arose in this particular case, while in other cases maybe the same postulate is to be satisfied by utterly different though equivalent combinations of forces or active elements." Thus a hypothesis may be ruled out by principles or postulates without any reference to the concrete facts which belong to that division of the subject to explain which the hypothesis is formulated. A true hypothesis, therefore, seeks not merely to connect or colligate two separate facts, but to do this in the light of and subject to certain fundamental principles. Various attempts have been made to classify hypotheses and to distinguish "hypothesis" from a "theory" or a mere "conjecture": none of these have any great practical importance, the differences being only in degree, not in kind.

The adjective "hypothetical" is used in the same sense, both loosely in contradistinction to "real" or "actual," and technically in the phrases "hypothetical judgment" and "hypothetical syllogism." (See LOGIC and SYLLOGISM.)

See Naville, *La Logique de l'hypothèse* (1886), and textbooks of logic, *e.g.* those of Jevons, Bosanquet, Joseph; Liebmann, *Der Klimax d. Theorien*.

**HYPOTRACHELIUM** (Gr. ὑποτραχήλιον, the lower part of the neck, πρᾶξιλος), in classical architecture, the space between the annulet of the echinus and the upper bed of the shafts, including, according to C. R. Cockerell, the three grooves or sinkings found in some of the older examples, as in the temple of Neptune at Paestum and the temple of Aphaea at Aegina; there being only one groove in the Parthenon, the Theseum and later examples. In the temple of Ceres and the so-called Basilica at Paestum the hypotrachelium consists of a concave sinking carved with vertical lines suggestive of leaves, the tops of which project forward. A similar decoration is found in the capital of the columns flanking the tomb of Agamemnon at Mycenae, but here the hypotrachelium projects forward with a cavetto moulding, and is carved with triple leaves like the buds of a

rose. In the Roman Doric Order the term was sometimes applied to that which is generally known as the "necking," the space between the fillet and the annulet.

**HYPSONETER** (Gr. ὑψος, height, μέτρον, a measure), an instrument for measuring heights which employs the principles that the boiling-point of a liquid is lowered by diminishing the pressure, and that the barometric pressure varies with the height of the point of observation. The instrument consists of a cylindrical vessel in which the liquid, usually water, is boiled, surmounted by a jacketed column, in the outer partitions of which the vapour circulates, while in the central one a thermometer is placed. To deduce the height of the station from the observed boiling-point, it is necessary to know the relation existing between the boiling-point and pressure, and also between the pressure and height of the atmosphere.

**HYRACOIDEA**, a suborder of ungulate mammals represented at the present day only by the Syrian hyrax (*Procavia syriaca*), the "coney" of the Bible, and its numerous African relatives, all of which may be included in the single genus *Procavia* (or *Hyrax*), and consequently in the family *Procaviidae*. These creatures have no proper English name, and are generally known as hyraxes, from the scientific term (*Hyrax*) by which they were for many years designated—a term which has unfortunately had to give place to the earlier *Procavia*. In size these animals may be compared roughly to rabbits and hares; and they have rodent-like habits, hunching up their backs after the fashion of some foreign members of the hare-family, more especially the Liu-Kiu rabbit. In the matter of nomenclature these animals have been singularly unfortunate. In the title "hyrax" they have, for instance, usurped the Greek name for the shrew-mouse; while in the Bible they have been given the old English name for the rabbit. Perhaps rock-rabbit would be the best name. At the Cape they are known to the Dutch as *dass* (badger), which has been anglicized into "dassie."

As regards the recent forms, the dentition in the fully adult animal consists only of incisors and cheek-teeth, the formula being  $i. \frac{1}{1}, c. \frac{0}{0}, p. \frac{1}{1}, m. \frac{1}{1}$ . There is, however, a minute upper canine developed at first, which is early shed; and in extinct forms this tooth was

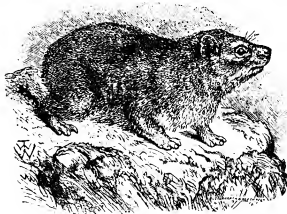

FIG. 1.—The Cape Hyrax (*Procavia capensis*).

functional and molar-like. The upper incisors have persistent pulps, and are curved longitudinally, forming a semicircle as in rodents; they are, however, not flattened from before backwards as in that order, but prismatic, with an antero-external, an antero-internal and a posterior surface, the first two only being covered with enamel; their tips are consequently not chisel-shaped, but sharp-pointed. They are preceded by functional, rooted milk-teeth. The lower incisors have long tapering roots, but not of persistent growth; and are straight, directed somewhat forwards, with awl-shaped, tri-lobed crowns. Behind the incisors is a considerable gap, followed by the cheek-teeth, which are all contiguous, and formed almost exactly on the pattern of some of the perissodactyle ungulates. The milk-dentition includes three pairs of incisors and one of canines in each jaw. The hyoid arch is unlike that of any known mammal. The dorsal and lumbar vertebrae are very numerous, 28 to 30, of which 21 or 22 bear ribs. The tail is extremely short. There are no clavicles. In the fore foot, the three middle toes are subequally developed, the fifth is present, but smaller, and the first is rudimentary, although, in one species at least, all its

normal bones are present. The terminal phalanges of the four outer digits are small, somewhat conical and flattened in form. The carpus has a distinct os centrale. There is a slight ridge on the femur in the place of a third trochanter. The fibula is complete, thickest at its upper end, where it generally unites with the tibia. The articulation between the tibia and astragalus is more complex than in other mammals, the end of the malleolus entering into it. The hind-foot is very like that of a rhinoceros, having three well-developed toes. There is no trace of a first toe, and the fifth metatarsal is represented by a small nodule. The terminal phalange of the inner (or second) digit is deeply cleft, and has a peculiar long curved claw, the others having short broad nails. The stomach is formed upon much the same principle as that of the horse or rhinoceros, but is more elongated transversely and divided by a constriction into two cavities—a large left *cul de sac*, lined by a very dense white epithelium, and a right pyloric cavity, with a thick, soft, vascular lining. The intestinal canal is long, and has, in addition to the ordinary short, but capacious and sacculated caecum at the commencement of the colon, lower down, a pair of large, conical, pointed caeca. The liver is much subdivided, and there is no gall-bladder. The brain resembles that of typical ungulates far more than that of rodents. The testes are permanently abdominal. The ureters open into the fundus of the bladder as in some Rodents. The



FIG. 2.—Skull and Dentition of Tree-Hyrax (*Procavia dorsalis*)

female has six teats, of which four are inguinal and two axillary, and the placenta is zony and deciduous. There is a gland on the back.

The more typical members of the genus are terrestrial in their habits, and their cheek-teeth have nearly the same pattern as in rhinoceroses; while the interval between the upper incisors is less than the width of the teeth; and the lower incisors are only slightly notched at the cutting edge. Vertebrae: C. 7, D. 22, L. 8, S. 6, C. 6. Of this form the earliest known species, *P. capensis*, is the type; but there are many other species, as *P. syriaca*, and *P. brucei* from Syria and eastern Africa. They inhabit mountainous and rocky regions, and live on the ground. In a second section the molar teeth have the same pattern as in *Palaotherium* (except that the third lower molar has but two lobes); the interval between the upper incisors exceeds the width of the teeth; and the lower incisors have distinctly trilobed crowns. Vertebrae: C. 7, D. 21, L. 7, S. 5, C. 10. The members of this section frequent the trunks and large branches of trees, sleeping in holes. There are several species from Western and South Africa, as *P. arboreus* and *P. dorsalis*. The members of both groups appear to have a power like that possessed by geckos of clinging to vertical surfaces of rocks and trees by the soles of their feet.

**Extinct Hyracoidea.**—For many years extinct representatives of the Hyracoidea were unknown, partly owing to the fact that certain fossils were not recognized as really belonging to that group. The longest known of these was originally named *Leptodon graecus*, but, on account of the preoccupation of the generic title, the designation has been changed to *Pliohyrax graecus*. This animal, whose remains occur in the Lower Pliocene of both Attica and Samos, was about the size of a donkey, and possessed three pairs of upper incisor teeth, of which the innermost were large and trilobed, recalling those of the existing genus. On the other hand, the two outer pairs of incisors were in contact with one another and with the canines, so as to form on each side a series continuous with the cheek-teeth.

The next representatives of the group occur in the Upper Eocene beds of the Fayum district of Egypt, where the genera *Sagatherium* and *Megalohyrax* occur. These are regarded as representing a distinct family, the *Sagatheriidae*, characterized by the possession of the full series of twenty-two teeth in the upper jaw, among which the first pair of incisors was modified to form trilobed rootless tusks, while the two remaining pairs were separated from one another and from the teeth in front by gaps. The canine was like a premolar, and in contact with the first tooth of that series; and the cheek-teeth were short-crowned, with the premolar simpler than the molars, and a third lobe to the last lower tooth of the latter

series. The members of this genus were small or medium-sized ungulates with single-rooted incisors. On the other hand, the representatives of the contemporary genus *Megalohyrax* were approximately as large as *Pliohyrax*, and in some instances had double roots to the second and third incisors.

It is now possible to define the suborder Hyraoidea as including ungulates with a centrale in the carpus, plantigrade feet, in which the first and fifth toes are reduced in greater or less degree, and claws and a foramen in the lower end of the humerus are absent. The femur has a small third trochanter, the radius and ulna and tibia and fibula are respectively separate, at least in the young, and the fibula articulates with the astragalus. The earlier forms had the full series of 44 teeth, with the premolars simpler than the molars; but in the later types the canines and some of the incisors disappear, and at least the hinder premolars become molar-like. In all cases the first upper incisors are large and rootless.

That the group originated in Africa there can be no reasonable doubt; and it is remarkable that so early as the Upper Eocene the types in existence differed comparatively little in structure from the modern forms. In fact the hyraxes were then almost as distinct from other mammals as they are at the present day.

See also C. W. Andrews, *Descriptive Catalogue of the Tertiary Vertebrata of the Fayum*, British Museum (1906). (R. L. \*)

**HYRCANIA.** (1) An ancient district of Asia, south of the Caspian Sea, and bounded on the E. by the river Oxus, called *Vr'kana*, or "Wolf's Land," in Old Persian. It was a wide and indefinite tract. Its chief city is called *Tapta* by Strabo, *Zadrcarta* by Arrian (probably the modern Astarabad). The latter is evidently the same as *Carta*, mentioned by Strabo as an important city. Little is known of the history of the country. Xenophon says it was subdued by the Assyrians; Curtius that 6000 Hyrcanians were in the army of Darius III. (2) Two towns named Hyrcania are mentioned, one in Hyrcania, the other in Lydia. The latter is said to have derived its name from a colony of Hyrcanians, transported thither by the Persians.

**HYRCANUS** (*Ἰρκανός*), a Greek surname, of unknown origin, borne by several Jews of the Maccabean period.

**JOHN HYRCANUS I.**, high priest of the Jews from 135 to 105 B.C., was the youngest son of Simon Maccabaeus. In 137 B.C. he, along with his brother Judas, commanded the force which repelled the invasion of Judaea led by Cendebeus, the general of Antiochus VII. *Sidetes*. On the assassination of his father and two elder brothers by Ptolemy, governor of Jericho, his brother-in-law, in February 135, he succeeded to the high priesthood and the supreme authority in Judaea. While still engaged in the struggle with Ptolemy, he was attacked by Antiochus with a large army (134), and compelled to shut himself up in Jerusalem; after a severe siege peace was at last secured only on condition of a Jewish disarmament, and the payment of an indemnity and an annual tribute, for which hostages were taken. In 129 he accompanied Antiochus as a vassal prince on his ill-fated Parthian expedition; returning, however, to Judaea before winter, he escaped the final disaster. By the judicious mission of an embassy to Rome he now obtained confirmation of the alliance which his father had previously made with the growing western power; at the same time he availed himself of the weakened state of the Syrian monarchy under Demetrius II. to overrun Samaria, and also to invade Idumaea, which he completely subdued, compelling its inhabitants to receive circumcision and accept the Jewish faith. After a long period of rest he directed his arms against the town of Samaria, which, in spite of the intervention of Antiochus, his sons Antigonus and Aristobolus ultimately took, and by his orders razed to the ground (c. 100 B.C.). He died in 105, and was succeeded by Aristobolus, the eldest of his five sons. The external policy of Hyrcanus was marked by considerable energy and tact, and aided as it was by favouring circumstances, was so successful as to leave the Jewish nation in a position of independence and of influence such as it had not known since the days of Solomon. During its later years his reign was much disturbed, however, by the contentions for ascendancy which arose between the Pharisees and Sadducees, the two rival sects or parties which then for the first time (under those names at least) came into prominence. Josephus has related the curious circumstances under which he ultimately relinquished his personal support from the former to the latter.

**JOHN HYRCANUS II.**, high priest from 78 to 40 B.C., was the eldest son of Alexander Jannaeus by his wife Alexandra, and was thus a grandson of the preceding. When his father died in 78, he was by his mother forthwith appointed high priest, and on her death in 69 he claimed the succession to the supreme civil authority also; but, after a brief and troubled reign of three months, he was compelled to abdicate both kingly and priestly dignities in favour of his more energetic and ambitious younger brother Aristobolus II. In 63 it suited the policy of Pompey that he should be restored to the high priesthood, with some semblance of supreme command, but of much of this semblance even he was soon again deprived by the arrangement of the pro-consul Gabinus, according to which Palestine was in 57 B.C. divided into five separate circles (*συνδοαί, συνθέματα*). For services rendered to Caesar after the battle of Pharsalia, he was again rewarded with the sovereignty (*προστασία τοῦ ἔθνους*, Jos. *Ant.* xx. 10) in 47 B.C. Antipater of Idumaea, however, being at the same time made procurator of Judaea. In 41 B.C. he was practically superseded by Antony's appointment of Herod and Phasael to be tetrarchs of Judaea; and in the following year he was taken prisoner by the Parthians, deprived of his ears that he might be permanently disqualified for priestly office, and carried to Babylon. He was permitted in 33 B.C. to return to Jerusalem, where on a charge of treasonable correspondence with Malchus, king of Arabia, he was put to death in 30 B.C.

See Josephus (*Ant.* xiii. 8-10; xiv. 5-13; *Bell. Jud.* i. 2; i. 8-13). Also MACCABEES, *History*. (J. H. A. H.)

**HYSSOP** (*Hyssopus officinalis*), a garden herb belonging to the natural order *Labiatae*, formerly cultivated for use in domestic medicine. It is a small perennial plant about 2 ft. high, with slender, quadrangular, woody stems; narrowly elliptical, pointed, entire, dotted leaves, about 1 in. long and  $\frac{1}{2}$  in. wide, growing in pairs on the stem; and long terminal, erect, half-whorled, leafy spikes of small violet-blue flowers, which are in blossom from June to September. Varieties of the plant occur in gardens with red and white flowers, also one having variegated leaves. The leaves have a warm, aromatic, bitter taste, and are believed to owe their properties to a volatile oil which is present in the proportion of  $\frac{1}{4}$  to  $\frac{3}{4}$  %. Hyssop is a native of the south of Europe, its range extending eastward to central Asia. A strong tea made of the leaves, and sweetened with honey, was formerly used in pulmonary and catarrhal affections, and externally as an application to bruises and indolent swellings.

The hedge hyssop (*Gratiola officinalis*) belongs to the natural order *Scrophulariaceae*, and is a native of marshy lands in the south of Europe, whence it was introduced into Britain more than 300 years ago. Like *Hyssopus officinalis*, it has smooth opposite entire leaves, but the stems are cylindrical, the leaves twice the size, and the flowers solitary in the axils of the leaves and having a yellowish-red veined tube and bluish-white limb, while the capsules are oval and many-seeded. The herb has a bitter, nauseous taste, but is almost odourless. In small quantities it acts as a purgative, diuretic and emetic when taken internally. It was formerly official in the Edinburgh Pharmacopoeia, being esteemed as a remedy for dropsy. It is said to have formed the basis of a celebrated nostrum for gout, called *Eau médicinale*, and in former times was called *Gratia Dei*. When growing in abundance, as it does in some damp pastures in Switzerland, it becomes dangerous to cattle. *G. peruviana* is known to possess similar properties.

The hyssop ('ezob) of Scripture (Ex. xii. 22; Lev. xiv. 4, 6; Numb. xix. 6, 18; 1 Kings v. 13 (iv. 33); Ps. li. 9 (7); John xix. 29), a wall-growing plant adapted for sprinkling purposes, has long been the subject of learned disputation, the only point on which all have agreed being that it is not to be identified with the *Hyssopus officinalis*, which is not a native of Palestine. No fewer than eighteen plants have been supposed by various authors to answer the conditions, and Celsius has devoted more than forty pages to the discussion of their several claims. By Tristram (*Oxford Bible for Teachers*, 1880) and others the caper plant (*Capparis spinosa*) is supposed to be meant; but, apart from other difficulties, this identification is open to the objection that the caper seems to be, at least in one passage (Eccl. xii. 5), otherwise designated (*Abiyōnāh*). Theñius (on 1 Kings v. 13) suggests *Orthocentrus saxatile*.

The most probable opinion would seem to be that found in Maimonides and many later writers, according to which the Hebrew 'enob is to be identified with the Arabic *sa'alar*, now understood to be *Satureja Thymus*, a plant of very frequent occurrence in Syria and Palestine, with which *Thymus Serpyllum*, or wild thyme, and *Satureja Thymora* are closely allied. Its smell, taste and medicinal properties are similar to those of *H. officinalis*. In Morocco the *sa'alar* of the Arabs is *Origanum combolium*; and it appears probable that several plants of the genera *Thymus*, *Origanum* and others nearly allied in form and habit, and found in similar localities, were used under the name of hyssop.

**HYSTASPES** (the Greek form of the Persian *Vishtāspa*). (1) A semi-legendary king (*kava*), praised by Zoroaster as his protector and a true believer, son of Aurvatāsa (Lohrasp). The later tradition and the Shahname of Firdousi makes him (in the modern form Kai Gushtāsp) king of Iran. As Zoroaster probably preached his religion in eastern Iran, Vishtāspa must have been a dynast in Bactria or Sogdiana. The Zoroastrian religion was already dominant in Media in the time of the Assyrian king Sargon (c. 715 B.C.), and had been propagated here probably in much earlier times (cf. PERSIA); the time of Zoroaster and Vishtāspa may therefore be put at c. 1000 B.C. (2) A Persian, father of Darius I., under whose reign he was governor of Parthia, as Darius himself mentions in the Behistun inscription (2. 65). By Ammianus Marcellinus, xxiii. 6. 32, and by many modern authors he has been identified with the protector of Zoroaster, which is equally impossible for chronological and historical reasons, and from the evidence of the development of Zoroastrianism itself (see PERSIA: *Ancient History*). (Ed. M.)

**HYSTERESIS** (Gr. *ὕστερησις*, from *ὕστερος*, to lag behind), a term added to the vocabulary of physical science by J. A. Ewing, who defines it as follows: When there are two quantities M and N such that cyclic variations of N cause cyclic variations of M, then if the changes of M lag behind those of N, we may say that there is *hysteresis* in the relation of M to N (*Phil. Trans.*, 1885, 176, p. 524). The phenomenon is best known in connexion with magnetism. If an iron bar is subjected to a magnetic force which is first gradually increased to a maximum and then gradually diminished, the resulting magnetization of the bar for any given value of the magnetic force will be greater when the force is decreasing than when it is increasing; the iron always tends to retain the magnetic condition which it has previously acquired, and changes of its magnetization consequently lag behind changes of the magnetic force. Thus there is hysteresis in the relation of magnetization to magnetic force. In consequence of hysteresis the process of magnetizing a piece of iron to a certain intensity and then restoring it to its original condition, or of effecting a double reversal of its magnetization, involves the expenditure of energy, which is dissipated as heat in the iron. Electrical generators and transformers often contain pieces of iron the magnetization of which is reversed many times in a second, and in order to economize power and to avoid undue heating it is essential that hysteresis should in such cases be as small as possible. Iron and mild steels showing remarkably little hysteresis are now specially manufactured for use in the construction of electrical machinery. (See MAGNETISM.)

**HYSTERIA**, a term applied to an affection which may manifest itself by a variety of symptoms, and which depends upon a disordered condition of the highest nervous centres. It is characterized by psychical peculiarities, while in addition there is often derangement of the functions subserved by the lower cerebral and spinal centres. Histological examination of the nervous system has failed to disclose associated structural alterations.

By the ancients and by modern physicians down to the time of Sydenham the symptoms of hysteria were supposed to be directly due to disturbances of the uterus (Gr. *ὑστέρα*, whence the name). This view is now universally recognized to be erroneous. The term "functional" is often used by English neurologists as synonymous with hysterical, a nomenclature which is tentatively advantageous since it is at least non-committal. P. J. Müblius has defined hysteria as "a state in which ideas control the body and produce morbid changes in its functions." P. Janet, who has done much to popularize the psychical origin

of the affection, holds that there is "a limitation of the field of consciousness" comparable to the contraction of the visual fields met with in the disease. The hysterical subject, according to this view, is incapable of taking into the field of consciousness all the impressions of which the normal individual is conscious. Strong momentary impressions are no longer controlled so efficiently because of the defective simultaneous impressions of previous memories. Hence the readiness with which the impulse of the moment is obeyed, the loss of emotional control and the increased susceptibility to external suggestion, which are so characteristic. A secondary subconscious mental state is engendered by the relegation of less prominent impressions to a lower sphere. The dual personality which is typically exemplified in somnambulism and in the hypnotic state is thus induced. The explanation of hysterical symptoms which are independent of the will, and of the existence of which the individual may be unaware, is to be found in a relative preponderance of this secondary subconscious state as compared with the primary conscious personality. An elaboration of this theory affords an explanation of hysterical symptoms dependent upon a "fixed idea." The following definition of hysteria has recently been advanced by J. F. F. Babinski: "Hysteria is a psychical condition manifesting itself principally by signs that may be termed primary, and in an accessory sense others that we may call secondary. The characteristic of the primary signs is that they may be exactly reproduced in certain subjects by suggestion and dispelled by persuasion. The characteristic of the secondary signs is that they are closely related to the primary phenomena."

The causes of hysteria may be divided into (a) the predisposing, such as hereditary predisposition to nervous disease, sex, age and national idiosyncrasy; and (b) the immediate, such as mental and physical exhaustion, fright and other emotional influences, pregnancy, the puerperal condition, diseases of the uterus and its appendages, and the depressing influence of injury or general disease. Perhaps, taken over all, hereditary predisposition to nerve-instability may be asserted as the most prolific cause. There is frequently direct inheritance, and cases of epilepsy and insanity or other form of nervous disease are rarely wanting when the family history is carefully enquired into. As regards age, the condition is apt to appear at the evolution periods of life—puberty, pregnancy and the climacteric—without any further assignable cause except that first spoken of. It is rare in young children, but very frequent in girls between the ages of fifteen and twenty-five, while it sometimes manifests itself in women at the menopause. It is much more common in the female than in the male—in the proportion of 20 to 1. Certain races are more liable to the disease than others; thus the Latin races are much more prone to hysteria than are those who come of a Teutonic stock, and in more aggravated and complex forms. In England it has been asserted that an undue proportion of cases occur among Jews. Occupation, or be it rather said want of occupation, is a prolific cause. This is noticeable more especially in the higher classes of society.

An hysterical attack may occur as an immediate sequel to an epileptic fit. If the patient suffers only from *petit mal* (see EPILEPSY), unaccompanied by true epileptic fits, the significance of the hysterical seizure, which is really a post-epileptic phenomenon, may remain unrecognized.

It is convenient to group the very varied symptoms of hysteria into paroxysmal and chronic. The popular term "hysterics" is applied to an explosion of emotionalism, generally the result of mental excitement, on which convulsive fits may supervene. The characters of these vary, and may closely resemble epilepsy. The hysterical fit is generally preceded by an aura or warning. This sometimes takes the form of a sensation as of a lump in the throat (*globus hystericus*). The patient may fall, but very rarely is injured in so doing. The eyes are often tightly closed, the body and limbs become rigid, and the back may become so arched that the patient rests on her heels and head (*opisthotonos*). This stage is usually followed by violent struggling movements. There is no loss of consciousness. The attack may last for half-an-hour

or even longer. Hysterical fits in their fully-developed form are rarely seen in England, though common in France. In the chronic condition we find an extraordinary complexity of symptoms, both physical and mental. The physical symptoms are extremely diverse. There may be a paralysis of one or more limbs associated with rigidity, which may persist for weeks, months or years. In some cases, the patient is unable to walk; in others there are peculiarities of the gait quite unlike anything met with in organic disease. Perversions of sensation are usually present; a common instance is the sensation of a nail being driven through the vertex of the head (*clavus hystericus*). The region of the spine is a very frequent seat of hysterical pain. Loss of sensation (*anaesthesia*), of which the patient may be unaware, is of common occurrence. Very often this sensory loss is limited exactly to one-half of the body, including the leg, arm and face on that side (*hemianaesthesia*). Sensation to touch, pain, heat and cold, and electrical stimuli may have completely disappeared in the anaesthetic region. In other cases, the anaesthesia is relative or it may be partial, certain forms of sensation remaining intact. Anaesthesia is almost always accompanied by an inability to recognize the exact position of the affected limb when the eyes are closed. When hemianaesthesia is present, sight, hearing, taste and smell are usually impaired on that side of the body. Often there is loss of voice (hysterical aphonia). It is to such cases of hysterical paralysis and sensory disturbance that the wonderful cures effected by quacks and charlatans may be referred. The mental symptoms have not the same tendency to pass away suddenly. They may be spoken of as interparoxysmal and paroxysmal. The chief characteristics of the former are extreme emotionalism combined with obstructiveness, a desire to be an object of interest and a constant craving for sympathy which is often procured at an immense sacrifice of personal comfort. Obstructiveness is the invariable symptom. Hysteria may pass into absolute insanity.

The treatment of hysteria demands great tact and firmness on the part of the physician. The affection is a definite entity and has to be clearly distinguished from malingering, with which it is so often erroneously regarded as synonymous. Drugs are of little value. The moral treatment is all-important. In severe cases, removal from home surroundings and isolation, either in a hospital ward or nursing home, are essential, in order that full benefit may be derived from psychotherapeutic measures.

**BIBLIOGRAPHY.**—Charcot, *Leçons sur les maladies du système nerveux* (1877); S. Weir Mitchell, *Lectures on Diseases of the Nervous System especially in Women* (1885); Buzzard, *Simulation of Hysteria by Organic Nervous Disease* (1891); Pittres, *Leçons cliniques sur l'hystérie et l'hypnotisme* (1891); Richer, *Etudes cliniques sur la grande hystérie* (1891); Gilles de la Tourette, *Traité clinique et thérapeutique de l'hystérie* (1891); Bastian, *Hysterical or Functional Paralysis* (1893); Ormerod, Art. "Hysteria," in Clifford Allbutt's *System of Medicine* (1899); Camus and Pagniez, *Isolément et Psychothérapie* (1904). (J. B. T.; E. BRA.)

**HYSTERON-PROTERON** (Gr. ὑστερον, latter, and πρότερον, former), a figure of speech, in which the order of words or phrases is inverted, and that which should logically or naturally come last is put first, to secure emphasis for the principal idea; the classical example is Virgil's "*moriamur et in media arma ruamus*," "let us die and charge into the thick of the fight" (Aen. ii. 358). The term is also applied to any inversion in order of events, arguments, &c.

**HYTHE**, a market town and watering-place, one of the Cinque Ports, and a municipal and parliamentary borough of Kent, England, 67 m. S.E. by E. of London on a branch of the South Eastern & Chatham railway. Pop. (1901) 5557. It is beautifully situated at the foot of a steep hill near the eastern extremity of Romney Marsh, about half a mile from the sea, and consists principally of one long street running parallel with the shore, with which it is connected by a straight avenue of wych elms. On account of its fine situation and picturesque and interesting neighbourhood, it is a favourite watering-place. A sea-wall and parade extend eastward to Sandgate, a distance of 3 m. There is communication with Sandgate by means of a tramway along the front. On the slope of the hill above the town stands

the fine church of St Leonard, partly Late Norman, with a very beautiful Early English chancel. The tower was rebuilt about 1750. In a vault under the chancel there is a collection of human skulls and bones supposed to be the remains of men killed in a battle near Hythe in 456. Lionel Lukin (1742-1834), inventor of the life-boat, is buried in the churchyard. Hythe possesses a guildhall founded in 1794 and two hospitals, that of St Bartholomew founded by Haimo, bishop of Rochester, in 1336, and that of St John (rebuilt in 1802), of still greater antiquity but unknown date, founded originally for the reception of lepers. A government school of musketry, in which instructors for the army are trained, was established in 1854, and has been extended since, and the Shorncliffe military camp is within 2½ m. of the town.

Lympe, which is now 3 m. inland, is thought to have been the original harbour which gave Hythe a place among the Cinque Ports. The course of the ancient estuary may be distinctly traced from here along the road to Hythe, the sea-sand lying on the surface and colouring the soil. Here are remains of a Roman fortress, and excavations have brought to light many remains of the Roman *Portus Lemanis*. Large portions of the fortress walls are standing. At the south-west corner is one of the circular towers which occurred along the line of wall. The site is now occupied by the fine old castellated mansion of Studfall castle, formerly a residence of the archdeacons of Canterbury. The name denotes a fallen place, and is not infrequently thus applied to ancient remains. The church at Lympe is Early English, with a Norman tower built by Archbishop Lanfranc, and Roman material may be traced in the walls. A short distance east is Shipway or Shepway Cross, where some of the great assemblies relating to the Cinque Ports were held. A mile north from Hythe is Saltwood Castle, of very ancient origin, but rebuilt in the time of Richard II. The castle was granted to the see of Canterbury in 1026, but escheated to the crown in the time of Henry II., when the murder of Thomas à Beckett is said to have been concerted here, and having been restored to the archbishops by King John remained a residence of theirs until the time of Henry VIII. It was restored as a residence in 1852. About 2 m. N.W. of Saltwood are remains of the fortified 14th-century manor-house of Westenanger. It is quadrangular and surrounded by a moat, and of the nine towers (alternately square and round) by which the walls were defended, three remain.

The parliamentary borough of Hythe, which includes Folkestone, Sandgate and a number of neighbouring villages, returns one member. The town is governed by a mayor, 4 aldermen and 12 councillors. Area 2617 acres.

Hythe (Heda, Heya, Hethe, Hith, i.e. landing-place) was known as a port in Saxon times, and was granted by Halfden, a Saxon thegn, to Christ Church, Canterbury. In the Domesday Survey the borough is entered among the archbishop's lands as appurtenant to his manor of Saltwood, and the bailiff of the town was appointed by the archbishop. Hythe was evidently a Cinque Port before the Conquest, as King John in 1205 confirmed the liberties, viz. freedom from toll, the right to be impounded only at the Shepway court, &c., which the townsmen had under Edward the Confessor. The liberties of the Cinque Ports were confirmed in Magna Carta and later by Edward I. in a general charter, which was confirmed, often with additions, by subsequent kings down to James II. John's charter to Hythe was confirmed by Henry IV., Henry V. and Henry VI. These charters were granted to the Cinque Ports in return for the fifty-seven ships which they supplied for the royal service, of which five were contributed by Hythe. The ports were first represented in the parliament of 1365, to which they each sent four members.

Hythe was governed by twelve jurats until 1574, when it was incorporated by Elizabeth under the title of the mayor, jurats and commonalty of Hythe; a fair for the sale of fish, &c., was also granted, to be held on the feast of St Peter and St Paul. As the sea gradually retreated from Hythe and the harbour became choked up with sand, the town suffered the fate of other places near it, and lost its old importance.



The ninth letter of the English and Latin alphabet, the tenth in the Greek and Phoenician, because in these the symbol Teth (the Greek  $\theta$ ) preceded it. Teth was not included in the Latin alphabet because that language had no sound corresponding to the Greek  $\theta$ , but the symbol was metamorphosed and utilized as the numeral C=100, which took this form through the influence of the initial letter of the Latin *centum*. The name of I in the Phoenician alphabet was *Yod*. Though in form it seems the simplest of letters it was originally much more complex.

In Phoenician it takes the form  $\text{𐤃}$ , which is found also in the earliest Syriac and Palestinian inscriptions with little modification. Ultimately in Hebrew it became reduced to a very small symbol, whence comes its use as a term of contempt for things of no importance as in "not one jot or tittle" (Matthew v. 18). The name passed from Phoenician to Greek, and thence to the Latin of the vulgate as *iota*, and from the Latin the English word is derived. Amongst the Greeks of Asia it appears only as the simple upright I, but in some of the oldest alphabets elsewhere, as Crete, Thera, Attica, Achaia and its colonies in lower Italy, it takes the form  $\text{𐀀}$  or  $\text{𐀁}$ , while at Corinth and Coreyra it appears first in a form closely resembling the later Greek *sigma*  $\Sigma$ . It had originally no cross-stroke at top and bottom, I being not *i* but *z*. The Phoenician alphabet having no vowel symbols, the value of *yod* was that of the English *y*. In Greek, where the consonant sound had disappeared or been converted into *h*, I is regularly used as a vowel. Occasionally, as in Pamphylian, it is used dialectically as a glide between *i* and another vowel, as in the proper name  $\Delta\alpha\mu\acute{\alpha}\rho\alpha\nu\alpha\varsigma$ . In Latin I was used alike for both vowel and consonant, as in *iugum* (yoke). The sound represented by it was approximately that still assigned to *i* on the continent. Neither Greek nor Latin made any distinction in writing between short and long *i*, though in the Latin of the Empire the long sound was occasionally represented by a longer form of the symbol I. The dot over the *i* begins in the 5th or 6th century A.D. In pronunciation the English short *i* is a more open sound than that of most languages, and does not correspond to the Greek and Latin sound. Nor are the English short and long *i* of the same quality. The short *i* in Sweet's terminology is a high-front-wide vowel, the long *i*, in English often spelt *ee* in words like *seed*, is diphthonged, beginning like the short vowel but becoming higher as it proceeds. The Latin short *i*, however, in final syllables was open and ultimately became *e*, e.g. in the neuter of *i*-stems as *utile* from *utilis*. Medially both the short and the long sounds are very common in syllables which were originally unaccented, because in such positions many other sounds passed into *i*: *officio* but *facio*, *redimo* but *emo*, *quidlibet* but *libet* (*libet* is later); *colludo* but *laedo*, *fidio* from an older *feido*, *istis* (dative plural) from an earlier *istois*.

(P. Gr.)

**IAMBIC**, the term employed in prosody to denote a succession of verses, each consisting of a foot or metre called an iambus ( $\acute{\alpha}\mu\beta\omicron\varsigma$ ), formed of two syllables, of which the first is short and the second long ( $\sim -$ ). After the dactylic hexameter, the iambic trimeter was the most popular metre of ancient Greece. Archilochus is said to have been the inventor of this iambic verse, the  $\tau\rho\iota\mu\epsilon\tau\rho\varsigma$  consisting of three iambic feet. In the Greek tragedians an iambic line is formed of six feet arranged in obedience to the following scheme:—

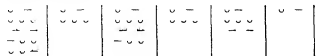

Much of the beauty of the verse depends on the caesura, which is usually in the middle of the third foot, and far less frequently in the middle of the fourth. The English language runs more naturally in the iambic metre than in any other. The normal

blank verse in English is founded upon an iambic basis, and Milton's line—

And swims | or sinks | or wades | or creeps | or flies | — exhibits it in its primitive form. The ordinary alexandrine of French literature is a hexapod iambic, but in all questions of quantity in modern prosody great care has to be exercised to recollect that all ascriptions of classic names to modern forms of rhymed or blank verse are merely approximate. The octosyllabic, or four-foot iambic metre, has found great favour in English verse founded on old romances. Decasyllabic iambic lines rhyming together form an "heroic" metre.

**IAMBlichus** (d. c. A.D. 330), the chief representative of Syrian Neoplatonism, is only imperfectly known to us in the events of his life and the details of his creed. We learn, however, from Suidas, and from his biographer Erenapius, that he was born at Chalcis in Coele-Syria, the scion of a rich and illustrious family, that he studied under Anatolius and afterwards under Porphyry, the pupil of Plotinus, that he himself gathered together a large number of disciples of different nations with whom he lived on terms of genial friendship, that he wrote "various philosophical books," and that he died during the reign of Constantine, — according to Fabricius, before A.D. 333. His residence (probably) at his native town of Chalcis was varied by a yearly visit with his pupils to the baths of Gadara. Of the books referred to by Suidas only a fraction has been preserved. His commentaries on Plato and Aristotle, and works on the Chaldaean theology and on the soul, are lost. For our knowledge of his system we are indebted partly to the fragments of these writings preserved by Stobaeus and others, and to the notices of his successors, especially Proclus, partly to his five extant books, the sections of a great work on the Pythagorean philosophy. Besides these, Proclus (412-485) seems to have ascribed to him<sup>1</sup> the authorship of the celebrated book *On the Egyptian Mysteries* (so-called), and although its differences in style and in some points of doctrine from the writings just mentioned make it improbable that the work was by Iamblichus himself, it certainly emanated from his school, and in its systematic attempt to give a speculative justification of the polytheistic cultus of the day, marks the turning-point in the history of thought at which Iamblichus stood.

As a speculative theory Neoplatonism (*q.v.*) had received its highest development from Plotinus. The modifications introduced by Iamblichus were the elaboration in greater detail of its formal divisions, the more systematic application of the Pythagorean number-symbolism, and chiefly, under the influence of Oriental systems, the thorough-going mythic interpretation of what the previous philosophy had still regarded as notional. It is on the last account, probably, that Iamblichus was looked upon with such extravagant veneration. As a philosopher he had learning indeed, but little originality. His aim was to give a philosophical rendering of the popular religion. By his contemporaries he was accredited with miraculous powers (which he, however, disclaimed), and by his followers in the decline of Greek philosophy, and his admirers on its revival in the 15th and 16th centuries, his name was scarcely mentioned without the epithet "divine" or "most divine," while, not content with the more modest eulogy of Erenapius that he was inferior to Porphyry only in style, the emperor Julian regarded him as not even second to Plato, and said that he would give all the gold of Lydia for one epistle of Iamblichus.

Theoretically, the philosophy of Plotinus was an attempt to harmonize the principles of the various Greek schools. At the head of his system he placed the transcendent incommunicable one ( $\acute{\epsilon}\nu\ \acute{\alpha}\mu\acute{\epsilon}\tau\epsilon\tau\omicron\varsigma$ ), whose first-begotten is intellect ( $\nu\omicron\upsilon\varsigma$ ), from which proceeds soul ( $\psi\upsilon\chi\eta$ ), which in turn gives birth to *phantasia*.

<sup>1</sup> Besides the anonymous testimony prefixed to an ancient MS. of Proclus, *De Myst.* viii. 3 seems to be quoted by the latter as Iamblichus's. Cf. Meiners, "Judicium de libro qui de Myst. Arg. inscribitur," in *Comment. Soc. Reg. Sci. Gott.*, vol. iv., 1781, p. 77.

realm of nature. Immediately after the absolute one, Iamblichus introduced a second superexistent unity to stand between it and the many as the producer of intellect, and made the three succeeding moments of the development (intellect, soul and nature) undergo various modifications. He speaks of them as intellectual (*θεοὶ νοεροί*), supramundane (*ὑπερκόσμιος*), and mundane gods (*ἐγκόσμιος*). The first of these—which Plotinus represented under the three stages of (objective) being (*ὄν*), (subjective) life (*ζωή*), and (realized) intellect (*νοῦς*)—is distinguished by him into spheres of intelligible gods (*θεοὶ νοητοί*) and of intellectual gods (*θεοὶ νοεροί*), each subdivided into triads, the latter sphere being the place of ideas, the former of the archetypes of these ideas. Between these two worlds, at once separating and uniting them, some scholars think there was inserted by Iamblichus, as afterwards by Proclus, a third sphere partaking of the nature of both (*θεοὶ νοητοὶ καὶ νοεροί*). But this supposition depends on a merely conjectural emendation of the text. We read, however, that "in the intellectual hebdomad he assigned the third rank among the fathers to the Demiurge." The Demiurge, Zeus, or world-creating potency, is thus identified with the perfected *νοῦς*, the intellectual triad being increased to a hebdomad, probably (as Zeller supposes) through the subdivision of its first two members. As in Plotinus *νοῦς* produced nature by mediation of *ψυχή*, so here the intelligible gods are followed by a triad of psychic gods. The first of these is incommunicable and supramundane, while the other two seem to be mundane though rational. In the third class, or mundane gods (*θεοὶ ἐγκόσμιος*), there is a still greater wealth of divinities, of various local position, function, and rank. We read of gods, angels, demons and heroes, of twelve heavenly gods whose number is increased to thirty-six or three hundred and sixty, and of seventy-two other gods proceeding from them, of twenty-one chiefs (*ἡγεμόνες*) and forty-two nature-gods (*θεοὶ γενεσιουργοί*), besides guardian divinities, of particular individuals and nations. The world is thus peopled by a crowd of superhuman beings influencing natural events, possessing and communicating knowledge of the future, and not inaccessible to prayers and offerings.

The whole of this complex theory is ruled by a mathematical formalism of triad, hebdomad, &c., while the first principle is identified with the monad, *νοῦς* with the dyad, and *ψυχή* with the triad, symbolic meanings being also assigned to the other numbers. "The theorems of mathematics," he says, "apply absolutely to all things," from things divine to original matter (*ἕλη*). But though he thus subjects all things to number, he holds elsewhere that numbers are independent existences, and occupy a middle place between the limited and unlimited.

Another difficulty of the system is the account given of nature. It is said to be "bound by the indissoluble chains of necessity which men call fate," as distinguished from divine things which are not subject to fate. Yet, being itself the result of higher powers becoming corporeal, a continual stream of elevating influence flows from them to it, interfering with its necessary laws and turning to good ends the imperfect and evil. Of evil no satisfactory account is given; it is said to have been generated accidentally.

In his doctrine of man Iamblichus retains for the soul the middle place between intellect and nature which it occupies in the universal order. He rejects the passionless and purely intellectual character ascribed to the human soul by Plotinus, distinguishing it sharply both from those above and those below it. He maintains that it moves between the higher and lower spheres, that it descends by a necessary law (not solely for trial or punishment) into the body, and, passing perhaps from one human body to another, returns again to the supersensible. This return is effected by the virtuous activities which the soul performs through its own power of free will, and by the assistance of the gods. These virtues were classified by Porphyry as political, purifying (*καθαρωτικά*), theoretical, and paradigmatic; and to these Iamblichus adds a fifth class of priestly virtues (*ιερατικά ἄρετά*), in which the divinest part of the soul raises itself above intellect to absolute being.

Iamblichus does not seem ever to have attained to that ecstatic communion with and absorption in deity which was the aim of earlier Neoplatonism, and which Plotinus enjoyed four times in his life, Porphyry once. Indeed his tendency was not so much to raise man to God as to bring the gods down to man—a tendency shown still more plainly in the "Answer of Abamon the master to Porphyry's letter to Anebo and solutions of the doubts therein expressed," afterwards entitled the *Liber de mysteriis*, and ascribed to Iamblichus.

In answer to questions raised and doubts expressed by Porphyry, the writer of this treatise appeals to the innate idea all men have of the gods as testifying to the existence of divinities countless in number and various in rank (to the correct arrangement of which he, like Iamblichus, attaches the greatest importance). He holds with the latter that above all principles of being and intelligence stands the absolute one, from whom the first god and king spontaneously proceeds; while after these follow the ethereal, empyrean, and heavenly gods, and the various orders of archangels, angels, demons, and heroes distinguished in nature, power, and activity, and in greater profusion than even the imagination of Iamblichus had conceived. He says that all the gods are good (though he in another place admits the existence of evil demons who must be propitiated), and traces the source of evil to matter; rebuts the objection that their answering prayer implies passivity on the part of gods or demons; defends divination, soothsaying, and theurgic practices as manifestations of the divine activity; describes the appearances of the different sorts of divinities; discusses the various kinds of sacrifice, which he says must be suitable to the different natures of the gods, material and immaterial, and to the double condition of the sacrificer as bound to the body or free from it (differing thus in his psychology from Iamblichus); and, in conclusion, states that the only way to happiness is through knowledge of and union with the gods, and that theurgic practices alone prepare the mind for this union—again going beyond his master, who held assiduous contemplation of divine things to be sufficient. It is the passionless nature of the soul which permits it to be thus united to divine beings,—knowledge of this mystic union and of the worship associated with it having been derived from the Egyptian priests, who learnt it from Hermes.

On one point only does the author of the *De mysteriis* seem not to go so far as Iamblichus in thus making philosophy subservient to priestcraft. He condemns as folly and impiety the worship of images of the gods, though his master held that these *simulacra* were filled with divine power, whether made by the hand of man or (as he believed) fallen from heaven. But images could easily be dispensed with from the point of view of the writer, who not only held that all things were full of gods (*πάντα πλήρη θεῶν*, as Thales said), but thought that each man had a special divinity of his own—an *ἴδιος δαίμων*—as his guard and companion.

The following are the extant works of Iamblichus: (1) *On the Pythagorean Life* (Περὶ τοῦ Πυθαγορικοῦ βίου), ed. T. Kiessling (1815), A. Nauck (St Petersburg, 1884); for a discussion of the authorities used see E. Rohde in *Rheinisches Museum*, xxvi., xxvii. (1871, 1872); Eng. trans. by Thomas Taylor (1818). (2) *The Exhortation to Philosophy* (Λόγος προεργατικὸς εἰς φιλοσοφίαν), ed. T. Kiessling (1813); H. Piselli (1888). (3) *The treatise On the General Science of Mathematics* (Περὶ τῆς κοινῆς μαθηματικῆς ἐπιστήμης), ed. J. G. Frits (Copenhagen, 1790); N. Festa (Leipzig, 1891). (4) *The book On the Arithmetic of Nicomachus* (Περὶ τῆς Νικομάχου ἀριθμητικῆς ἀριθμητικῆς), along with fragments on fate (Περὶ εὐνομήτης) and prayer (Περὶ εὐχῆς), ed. S. Tennulius (1688), the *Arithmetic* by H. Pistelli (1894). (5) *The Theological Principles of Arithmetic* (Θεολογικὴν τῆς ἀριθμητικῆς)—the seventh book of the series—by F. Ast (Leipzig, 1817). Two lost books, treating of the physical and ethical significance of numbers, stood fifth and sixth, while books on music, geometry and astronomy followed. The emperor Julian had a great admiration for Iamblichus, whom he considered "intellectually not inferior to Plato"; but the *Letters to Iamblichus the Philosopher* which bear his name are now generally considered spurious.

The so-called *Liber de mysteriis* was first edited, with Latin translation and notes, by T. Gale (Oxford, 1678), and more recently by G. Parthey (Berlin, 1857); Eng. trans. by Thomas Taylor (1821).

There is a monograph on Iamblichus by G. E. Hebenstreit (*De Iamblichis, philosophi Syri, doctrina*, Leipzig, 1764), and one of the *De myst.* by Harless (*Das Buch v. d. ägypt. Myst.*, Munich, 1858). The best accounts of Iamblichus are those of Zeller, *Phil. d. Griechen*, iii. 2, pp. 613 sq., 2nd ed.; E. Vacherot, *Hist. de l'école d'Alexandrie* (1846), ii. 57 sq.; J. Simon, *Hist. de l'école d'Alexandrie* (1845); A. E. Chaigant, *Histoire de la psychologie des Grecs* (Paris, 1893), v. 67-108; T. Whittaker, *The Neo-Platonists* (Cambridge, 1901), (W. R. So.)

**IAMBlichus**, of Syria, the earliest of the Greek romance writers, flourished in the 2nd century A.D. He was the author of Βαβυλωνιακά, the loves of Rhodanes and Sinonis, of which an epitome is preserved in Photius (cod. 94). Garmus, a legendary king of Babylon, forces Sinonis to marry him and throws Rhodanes into prison. The lovers manage to escape, and after many singular adventures, in which magic plays a considerable part, Garmus is overthrown by Rhodanes, who becomes king of Babylon. According to Suidas, Iamblichus was a freedman, and a scholiast's note on Photius further informs us that he was a native Syrian (not descended from Greek settlers); that he borrowed the material for his romance from a love story told him by his Babylonian tutor, and that he subsequently applied himself with great success to the study of Greek. A MS. of the original in the library of the Escorial is said to have been destroyed by fire in 1670. Only a few fragments have been preserved, in addition to Photius's epitome.

See *Scriptores erotici*, ed. A. Hirschig (1856) and R. Hercher (1858); *M. Mai, Scriptorum veterum nova collectio*, ii.; E. Rohde, *Der griechische Roman* (1900).

**IANNINA** (i.e. "the city of St John"; Gr. *Ioannina*; Turk *Yanina*; also written Janina, Jannina, and, according to its Albanian pronunciation, Yanina), the capital of the vilayet of Iannina, Albania, European Turkey. Pop. (1905) about 22,000. The largest ethnic groups in the population are the Albanian and Greek; the purest form of colloquial Greek is spoken here among the wealthy and highly educated merchant families. The position of Iannina is strikingly picturesque. At the foot of the grey limestone mass of Mount Mitzekeli (1500 ft.), which forms part of the fine range of hills running north from the Gulf of Arta, there lies a valley (the *Hellopia* of antiquity) partly occupied by a lake; and the city is built on the slopes of a slight eminence, stretching down to the western shore. It has greatly declined from the state of barbaric prosperity which it enjoyed from 1788 to 1822, when it was the seat of Ali Pasha (q.v.), and was estimated to have from 30,000 to 50,000 inhabitants. The fortress—Demir Kule or Iron Castle, which, like the principal seraglio, was built on a promontory jutting into the lake—is now in ruins. But the city is the seat of a Greek archbishop, and still possesses many mosques and churches, besides synagogues, a Greek college (gymnasium), a library and a hospital. Sayades (opposite Corfu) and Arta are the places through which it receives its imports. The rich gold and silver embroidery for which the city has long been famous is still one of the notable articles in its bazaar; but the commercial importance of Iannina has notably declined since the cession of Arta and Thessaly to Greece in 1881. Iannina had previously been one of the chief centres of the Thessalian grain trade; it now exports little except cheese, hides, bitumen and sheepskins to the annual value of about £120,000; the imports, which supply only the local demand for provisions, textile goods, hardware, &c., are worth about double that sum.

The lake of Iannina (perhaps to be identified with the Pambotis or Pambotis of antiquity) is 6 m. long, and has an area of 24 sq. m., with an extreme depth of less than 35 ft. In time of flood it is united with the smaller lake of Labchistas to the north. There are no affluents of any considerable size, and the only outlets are underground passages or *katastrohra* extending for many miles through the calcareous rocks.

The theory supported by W. M. Leake (*Northern Greece*, London, 1835) that the citadel of Iannina is to be identified with Dodona, is now generally abandoned in favour of the claims of a more southern site. As Anna Comnena, in describing the capture of the town (ρά Ἰωάννινα) by Bohemond in 1082, speaks of the walls as being dilapidated, it may be supposed that the place existed before the 11th century. It is mentioned from time to time in the Byzantine annals, and on the establishment of the

lordship of Epirus by Michael Angelus Comnenus Ducas, it became his capital. In the middle ages it was successively attacked by Serbs, Macedonians and Albanians; but it was in possession of the successors of Michael when the forces of the Sultan Murad appeared before it in 1430 (cf. Hahn, *Alban. Studien*, Jena [1854], pp. 319-322). Since 1431 it has continued under Turkish rule.

Descriptions of Iannina will be found in Holland's *Travels* (1815); Hughes, *Travels in Greece*, &c. (1830); H. F. Towner, *Researches in the Highlands of Turkey* (London, 1869). See also ALBANIA and the authorities there cited.

**IAPETUS**, in Greek mythology, son of Uranus and Gaea, one of the Titans, father of Atlas, Prometheus, Epimetheus and Menoetius, the personifications of certain human qualities (Hesiod, *Theog.* 507). As a punishment for having revolted against Zeus, he was imprisoned in Tartarus (Homer, *Iliad*, viii. 479) or underneath the island of Inarime off the coast of Campania (Silius Italicus xii. 148). Hyginus makes him the son of Tartarus and Gaea, and one of the giants. Iapetus was considered the original ancestor of the human race, as the father of Prometheus and grandfather of Deucalion. The name is probably identical with Japhet (Japheth), and the son of Noah in the Greek legend of the flood becomes the ancestor of (Noah) Deucalion. Iapetus as the representative of an obsolete order of things is described as warring against the new order under Zeus, and is naturally relegated to Tartarus.

See F. G. Welcker, *Griechische Götterlehre*, i. (1857); C. H. Völcker, *Die Mythologie des Iapetischen Geschlechtes* (1824); M. Mayer, *Giganten und Titanen* (1887).

**IAPYDES**, or IAPODES, one of the three chief peoples of Roman Illyria. They occupied the interior of the country on the north between the Arsia (Arsa) and Tedanuis (perhaps the Zermanja), which separated them from the Liburnians. Their territory formed part of the modern Croatia. They are described by Strabo as a mixed race of Celts and Illyrians, who used Celtic weapons, tattooed themselves, and lived chiefly on spelt and millet. They were a warlike race, addicted to plundering expeditions. In 129 B.C. C. Sempronius Tuditanus celebrated a triumph over them, and in 34 B.C. they were finally crushed by Augustus. They appear to have had a *foedus* with Rome, but subsequently rebelled.

See Strabo iv. 207, vii. 313-315; Dio Cassius xlix. 35; Appian, *Illyria*, lo. 14, 16; Livy, *Epit.* lix. 131; Tibullus iv. 1. 108; Cicero, *Pro Balbo*, 14.

**IATROCHEMISTRY** (coined from Gr. *iarpós*, a physician, and "chemistry"), a stage in the history of chemistry, during which the object of this science was held to be "not to make gold but to prepare medicines." This doctrine dominated chemical thought during the 16th century, its foremost supporters being Paracelsus, van Helmont and de la Boë Sylvius. But it gave way to the new definition formulated by Boyle, viz. that the proper domain of chemistry was "to determine the composition of substances." (See CHEMISTRY: I. *History*; MEDICINE.)

**IAZYGES**, a tribe of Sarmatians first heard of in the Maeotis, where they were among the allies of Mithradates the Great. Moving westward across Scythia, and hence called Metanastae, they were on the lower Danube by the time of Ovid, and about A.D. 50 occupied the plains east of the Theiss. Here, under the general name of Sarmatae, they were a perpetual trouble to the Roman province of Dacia. They were divided into freemen and serfs (*Sarmatae Limigantes*), the latter of whom had a different manner of life and were probably an older settled population enslaved by nomad masters. They rose against them in A.D. 334, but were repressed by foreign aid. Nothing is heard of Iazyges or Sarmatae after the Hunnish invasions. Graves at Keszthely and elsewhere in the Theiss valley, shown by their contents to belong to nomads of the first centuries A.D., are referred to the Iazyges. (E. H. M.)

**IBADAN**, a town of British West Africa, in Yorubaland, Southern Nigeria, 123 m. by rail N.E. of Lagos, and about 50 m. N.E. of Abeokuta. Pop. (1910) estimated at 150,000. The town occupies the slope of a hill, and stretches into the valley

through which the river Ona flows. It is enclosed by mud walls, which have a circuit of 18 m., and is encompassed by cultivated land 5 or 6 m. in breadth. The native houses are all low, thatched structures, enclosing a square court, and the only break in the mud wall is the door. There are numerous mosques, *orishas* (idol-houses) and open spaces shaded with trees. There are a few buildings in the European style. Most of the inhabitants are engaged in agriculture; but a great variety of handicrafts is also carried on. Ibadan is the capital of one of the Yoruba states and enjoys a large measure of autonomy. Nominally the state is subject to the *alajin* (ruler) of Oyo; but it is virtually independent. The administration is in the hands of two chiefs, a civil and a military, the *bale* and the *balogun*; these together form the highest court of appeal. There is also an *iyaloda* or mother of the town, to whom are submitted all the disputes of the women. Ibadan long had a feud with Abeokuta, but on the establishment of the British protectorate the intertribal wars were stopped. In 1862 the people of Ibadan destroyed Ijaya, a neighbouring town of 60,000 inhabitants. A British resident and a detachment of Hausa troops are stationed at Ibadan.

See also YORUBAS, ABEOKUTA and LAGOS.

**IBAGUÉ**, or SAN BONIFACIO DE IBAGUÉ, a city of Colombia, and capital of the department of Tolima, about 60 m.W. of Bogotá and 18 m. N.W. of the Nevado de Tolima. Pop. (1900, estimate) 13,000. Ibagué is built on a beautiful plain between the Chipalo and Combeima, small affluents of the Cuello, a western tributary of the Magdalena. Its elevation, 4300 ft. above the sea, gives it a mild, subtropical climate. The plain and the neighbouring valleys produce cacao, tobacco, rice and sugar-cane. There are two thermal springs in the vicinity, and undeveloped mines of sulphur and silver. The city has an endowed college. It is an important commercial center, being on the road which crosses the Quindío pass, or *paramo*, into the Cauca valley. Ibagué was founded in 1550 and was the capital of the republic for a short time in 1854.

**IBARRA**, a city of Ecuador and capital of the province of Imbabura, about 50 m. N.N.E. of Quito, on a small fertile plain at the northern foot of Imbabura volcano, 7300 ft. above sea-level. Pop. (1900, estimate) 5000. It stands on the left bank of the Tahuandú, a small stream whose waters flow north and west to the Pacific through the Mira, and is separated from the higher plateau of Quito by an elevated transverse ridge of which the Imbabura and Mojanda volcanoes form a part. The surrounding country is mountainous, the valleys being very fertile. Ibarra itself has a mild, humid climate, and is set in the midst of orchards and gardens. It is the see of a bishop and has a large number of churches and convents, and many substantial residences. Ibarra has manufactures of cotton and woollen fabrics, hats, sandals (*alpargates*), sacks and rope from *cabulla* fibre, laces, sugar and various kinds of distilled spirits and cordials made from the sugar-cane grown in the vicinity. Mules are bred for the Colombian markets of Pasto and Popayan. Ibarra was founded in 1507 by Alvaro de Ibarra, the president of Quito. It has suffered from the eruptions of Imbabura, and more severely from earthquakes, that of 1859 causing great damage to its public buildings, and the greater one of the 16th of August 1868 almost completely destroyed the town and killed a large number of its inhabitants. The village of Carranqui,  $1\frac{1}{2}$  m. from Ibarra, is the birthplace of Atahualpa, the Inca sovereign executed by Pizarro, and close by is the small lake called Yaguarcocha where the army of Huaynacpac, the father of Atahualpa, inflicted a bloody defeat on the Carranquis. Another aboriginal battle-field is that of Hatuntauqui, near Ibarra, where Huaynacpac won a decisive victory and added the greater part of Ecuador to his realm. The whole region is full of *lolas*, or Indian burial mounds.

**IBERRIANS** (Iberii, *Ibēnes*), an ancient people inhabiting parts of the Spanish peninsula. Their ethnic affinities are not known, and our knowledge of their history is comparatively slight. It is almost impossible to make any statement in regard to them which will meet with general agreement. At the same

time, the general lines of Iberian controversy are clear enough. The principal sources of information about the Iberians are (1) historical, (2) numismatic, (3) linguistic, (4) anthropological.

1. *Historical*.—The name seems to have been applied by the earlier Greek navigators to the peoples who inhabited the eastern coast of Spain; probably it originally meant those who dwelt by the river Iberus (mod. *Ebro*). It is possible (Boudard, *Études sur l'alphabet ibérien* (Paris, 1852) that the river-name itself represents the Basque phrase *ibay-erri* "the country of the river." On the other hand, even in older Greek usage (as in *Thuc. vi. 1*) the term Iberia is said to have embraced the country as far east as the Rhone (see Herodorus of Heraclea, *Fragm. Hist. Gr. ii. 34*), and by the time of Strabo it was the common Greek name for the Spanish peninsula. Iberians thus meant sometimes the population of the peninsula in general and sometimes, it would appear, the peoples of some definite race (*tribes*) which formed one element in that population. Of the tribal distribution of this race, of its linguistic, social and political characteristics, and of the history of its relation to the other peoples of Spain, we have only the most general, fragmentary and contradictory accounts. On the whole, the historical evidence indicates that in Spain, when it first became known to the Greeks and Romans there existed many separate and variously civilized tribes connected by at least apparent identity of race, and by similarity (but not identity) of language, and sufficiently distinguished by their general characteristics from Phoenicians, Romans and Celts. The statement of Diodorus Siculus that the mingling of these Iberians with the immigrant Celts gave rise to the Celtiberians is in itself probable. Varro and Dionysius Afer proposed to identify the Iberians of Spain with the Iberians of the Caucasus, the one regarding the eastern, and other the western, settlements as the earlier.

2. *Numismatic*.—Knowledge of ancient Iberian language and history is mainly derived from a variety of coins, found widely distributed in the peninsula,<sup>1</sup> and also in the neighbourhood of Narbonne. They are inscribed in an alphabet which has many points of similarity with the western Greek alphabets, and some with the Punic alphabet; but which seems to retain a few characters from an older script akin to those of Minoan Crete and Roman Libya.<sup>2</sup> The same Iberian alphabet is found also rarely in inscriptions. The coinage began before the Roman conquest was completed; the monetary system resembles that of the Roman republic, with values analogous to *denarii* and *quinarii*. The coin inscriptions usually give only the name of the town, e.g. ΠΙΠΙΙΙΙ (Bilbilis), ΚΛΑΓΟΡΙΣ (Calagurris), ΣΕΒΡΙΚΣ (Segobriga), ΤΜΑΝΙΑΥ (Dumania). The types show late Greek and perhaps also late Punic influence, but approximate later to Roman models. The commonest reverse type, a charging horseman, reappears on the Roman coins of Bilbilis, Osca, Segobriga and other places. Another common type is one man leading two horses or brandishing a sword or a bow. The obverse has usually a male head, sometimes inscribed with what appears to be a native name.

3. *Linguistic*.—The survival of the non-Aryan language among the Basques around the west Pyrenees has suggested the attempt to interpret by its means a large class of similar-sounding place-names of ancient Spain, some of which are authenticated by their occurrence on the inscribed coins, and to link it with other traces of non-Aryan speech round the shores of the Western Mediterranean and on the Atlantic seaboard of Europe. This phase of Iberian theory opens with K. W. Humboldt (*Prüfung der Untersuchungen über die Urbevölkerung Hispaniens vermittelst der wassischen Sprache*, Berlin, 1821).

<sup>1</sup> For the prehistoric civilization of the peninsula as a whole see SPAIN.

<sup>2</sup> P. A. Boudard's *Études sur l'alphabet ibérien* (Paris, 1852), and *Nomismatique ibérienne* (Béziers, 1859); Aloiss Heiss, *Notes sur les monnaies celtibériennes* (Paris, 1865), and *Description générale des monnaies antiques de l'Espagne* (Paris, 1870); Phillips, *Über das iberische Alphabet* (Vienna, 1870); *Die Einwanderung der Iberer in die pyren. Halbinsel* (Vienna, 1870); W. M. Flinders Petrie, *Journ. Anthr. Inst.* xxix. (1899) 204, and above all E. Hübner, *Monumenta lingue Ibericae*.

who contended that there existed once a single great Iberian people, speaking a distinct language of their own; that an essentially "Iberian" population was to be found in Sicily, Sardinia and Corsica, in southern France, and even in the British Isles; and that the Basques of the present day were remnants of this race, which had elsewhere been expelled or absorbed. This last was the central and the seminal idea of the work, and it has been the point round which the battle of scholarship has mainly raged. The principal evidence which Humboldt adduced in its support was the possibility of explaining a vast number of the ancient topographical names of Spain, and of other asserted Iberian districts, by the forms and significations of Basque. In reply, Gaslin (*De l'Ibérie*, Paris, 1830), maintained that the name Iberia was nothing but a Greek misnomer of Spain, and that there was no proof that the Basque people had ever occupied a wider area than at present; and Bladé (*Origine des Basques*, Paris, 1860) took the same line of argument, holding that Iberia is a purely geographical term, that there was no proper Iberian race, that the Basques were always shut in by alien races, that their affinity is still to seek, and that the whole Basque-Iberian theory is a figment. His main contention has met with some acceptance,<sup>1</sup> but the great current of ethnographical speculation still flows in the direction indicated by Humboldt.

4. *Anthropological*.—Humboldt's "Iberian theory" depended partly on linguistic comparisons, but partly on his observation of widespread similarity of physical type among the population of south-western Europe. Since his time the anthropological researches of Broca, Thurnam and Davis, Huxley, Busk, Beddoe, Virchow, Tubino and others have proved the existence in Europe, from Neolithic times, of a race, small of stature, with long or oval skulls, and accustomed to bury their dead in tombs. Their remains have been found in Belgium and France, in Britain, Germany and Denmark, as well as in Spain; and they bear a close resemblance to a type which is common among the Basques as well as all over the Iberian peninsula. This Neolithic race has consequently been nicknamed "Iberians," and it is now common to speak of the "Iberian" ancestry of the people of Britain, recognizing the racial characteristics of "Iberians" in the "small swarthy Welshman," the "small dark Highlander," and the "Black Celts to the west of the Shannon," as well as in the typical inhabitants of Aquitania and Brittany.<sup>2</sup> Later investigators went further. M. d'Arbois de Jubainville, for example (*Les Premiers habitants de l'Europe*, Paris, 1877), maintained that besides possessing Spain, Gaul, Italy and the British Isles, "Iberian" peoples penetrated into the Balkan peninsula, and occupied a part of northern Africa, Corsica and Sardinia; and it is now generally accepted that a race with fairly uniform characteristics was at one time in possession of the south of France (or at least of Aquitania), the whole of Spain from the Pyrenees to the straits, the Canary Islands (the Guanches) a part of northern Africa and Corsica. Whether this type is more conveniently designated by the word *Iberian*, or by some other name ("Eur-african," "Mediterranean," &c.) is a matter of comparative indifference, provided that there is no misunderstanding as to the steps by which the term *Iberian* attained its meaning in modern anthropology.

**AUTHORITIES**.—K. W. von Humboldt, "Über die cantabrische oder baskische Sprache" in *Adelung, Mythridates* iv. (1817), and *Prüfung d. Untersuchungen des Urworts der paeninsularischen oder wälschischen Sprache* (Berlin, 1821); L. F. Gaslin, *De l'Ibérie* (Paris, 1830); T. B. G. Lorye de St Vincent, *Essai géologique sur le genre humain* (1838); M. Bagnéau, "Sur l'ethnologie des peuples ibériens," in *Bull. soc. anthrop.* (1867), pp. 146-161; J. F. Bladé, *Études sur l'origine des Basques* (Paris, 1860), *Défense des études*, &c. (Paris, 1870); Phillips, *Die Einwanderung der Iberer in die pyren. Halbinsel* (Vienna, 1870), *Über das iberische Alphabet* (Vienna, 1870); W. Boyd Dawkins, "The Northern Range of the Basques, in

*Fortnightly Rev.* N.S. xvi. 323-337 (1874); W. T. van Eys, "La Langue ibérienne et la langue basque," in *Revue de linguistique*, pp. 3-15 (1874); W. Webster, "The Basque and the Kelt," in *Journ. Anthropol. Inst.* v. 5-29 (1875); F. M. Tubino, *Los Aborígenes ibéricos o los Berberos en la península* (Madrid, 1876); A. Luchaire, *Les Origines linguistiques de l'Aquitaine* (Paris, 1877); W. Boyd Dawkins, *Early Man in Britain* (London, 1880); A. Castaing, "Les Origines des Aquitains," *Mém. Soc. Eth. N.S.* i. pp. 183-328 (1884); G. C. C. Gerland, "Die Basken und die Iberer" in Gröber, *Grundriss d. roman. Philologie*, i. pp. 313-334 (1888); M. H. d'Arbois de Jubainville, *Les Premiers habitants de l'Europe* (1889-1894); J. F. Bladé, *Les Vascons avant leur établissement en Novempopulanie*, Agen, (1891); W. Webster, "The Celt-Iberians," *Academy*, xi. 268-269 (and consequent correspondence) (1891); J. Rhys, "The Inscriptions and Language of the Northern Picts," *Proc. Soc. Ant. Scot.* xxvi. 263-351 (1892); F. Fita, "El Vasconce en las inscripciones ógmicas," *Bolet. Real. Acad. Madrid* (June 1893), xxii. 579-587; G. v. d. Gabelentz, "Baskisch u. Berberisch," *Sitz. k. preuss. Akad. Wiss.* 593-613 (Berlin, 1893), *Die Verwandtschaft der Baskischen mit der Berber-Sprache Nordafrikas nachgewiesen* (Braunschweig, 1894); M. H. d'Arbois de Jubainville, "Les Celtes en Espagne," *Récol. collat.* xv. 357-95 (1894); G. Buschan, "Über die iberische Rasse," *Asland*, lxxvi. 342-344 (1894); F. Olóriz y Aguilera, *Distribución geográfica del índice cefálico en España* (Madrid, 1894), "La Talla humana en España" in *Discursos R. Acad. Medicina* xxxvi. 389 (Madrid, 1896); R. Collignon, "La Race basque," *L'Anthropologie*, v. 276-287 (1894); T. de Aranzadi, "Le Peuple basque, résumé," *Bull. soc. anthrop.* 510-520 (1894), "Consideraciones acerca de la Euzkadi," *Revista de Antropología*, vi. 65-92 (1897); H. Schuchardt, *Baskische Studien*, i. "Über die Entstehung der Bezugsformen des baskischen Zeitworts," *Denkschriften der K. Akad. der Wiss.*, Phil.-Hist., Classe, Bd. 42, Abh. 3. (Wien, 1893); R. Salmon, *Rev. mens. Éc. d'anthr.* v. 155-181, 214-220 (1895); R. Collignon, "Anthr. du S.-O. de la France," *Mém. Soc. Anthr.* § 3. i. 4, p. 1-129 (1895), *Ann. de géogr.* v. 156-166 (1896), and with J. Deniker, "Les Maures de Sénégal," *L'Anthr.* vii. 57-69 (1897); G. V. H. Reu, *Mém. Éc. d'anthr.* vi. 97-107 (1897); G. de Ségur, *Africa: Anthropologie della stirpe Camitica* (Turin, 1897); *Atti del Italici* (1898); L. de Hoyos Sainz, "L'Anthropologie et la pré-historique en Espagne et en Portugal en 1897," *L'Anthropologie*, ix. 37-51 (1898); J. Deniker (see Collignon) "Les Races de l'Europe," *L'Anthropologie*, ix. 113-133 (1898); M. Géze, "De quelques rapports entre les langues berbère et basque," *Mém. soc. arch. du Midi de la France*, xiii. See also the works quoted in the footnotes; and the bibliography under *Basques*. (J. L. M.)

**IBEX**, one of the names of the Alpine wild goat, otherwise known as the steinbok and bouquetin, and scientifically as *Capra ibex*. Formerly the ibex was common on the mountain-ranges of Germany, Switzerland and Tirol, but is now confined to the Alps which separate Valais from Piedmont, and to the lofty peaks of Savoy, where its existence is mainly due to game-laws. The ibex is a handsome animal, measuring about  $4\frac{1}{2}$  ft. in length and standing about 40 in. at the shoulder. The skin is covered in summer with a short fur of an ash-grey colour, and in winter with much longer yellowish-brown hair concealing a dense fur beneath. The horns of the male rise from the crest of the skull, and after bending gradually backwards terminate in smooth tips; the front surface of the remainder carrying bold transverse ridges or knots. About 1 yd. is the maximum recorded length of ibex-horns. The fact that the fore-legs are somewhat shorter than those behind enables the ibex to ascend mountain slopes with more facility than it can descend, while its hoofs are as hard as steel, rough underneath and when walking over a flat surface capable of being spread out. These, together with its powerful sinews, enable it to take prodigious leaps, to balance itself on the smallest foothold and to scale almost perpendicular rocks. Ibex live habitually at a greater height than chamois or any other Alpine mammals, their vertical limit being the line of perpetual snow. There they rest in sunny nooks during the day, descending at night to the highest woods to graze. Ibex are gregarious, feeding in herds of ten to fifteen individuals; but the old males generally live apart from, and usually at greater elevations than, the females and young. They utter a sharp whistling sound not unlike that of the chamois, but when greatly irritated or frightened make a peculiar snorting noise. The period of gestation in the female is ninety days, after which she produces—usually at the end of June—a single young one which is able at once to follow its mother. Kids when caught young and fed on goat's milk can be readily tamed; and in the 16th century young tamed ibex were frequently driven to the

<sup>1</sup> W. van Eys, for example, "La Langue ibérienne et la langue basque," in *Revue de linguistique*, goes against Humboldt; but Prince Napoleon and to a considerable extent A. Luchaire maintain the justice of his method and the value of many of his results. See Luchaire, *Les Origines linguistiques de l'Aquitaine* (Paris, 1877). Compare the interesting results of the whole question in Boyd Dawkins's *Early Man in Britain* (London, 1880).

mountains along with the goats, in whose company they would afterwards return. Even wild ibex have been known to stray among the herds of goats, although they shun the society of chamois. Its flesh is said to resemble mutton, but has a flavour of game.

By naturalists the name "ibex" has been extended to embrace all the kindred species of wild goats, while by sportsmen it is used in a still more elastic sense, to include not only the true wild goat (known in India as the Sind ibex) but even the short-horned *Hemitragus zoolocrius* of the Nilgiris. Dealing only with species zoologically known as ibex, the one nearest akin to the European kind is the Asiatic or Siberian ibex (*Capra*



The Ibex (*Capra ibex*).

*sibirica*), which, with several local phases, extends from the northern side of Kashmir over an enormous area in Central Asia. These ibex, especially the race from the Thian Shan, are incomparably finer than the European species, their bold knotted horns sometimes attaining a length of close on 60 in. The Arabian, or Nubian, ibex (*C. nubiana*) is characterized by the more slender type of horn, in which the front edge is much narrower; while the Simien ibex (*C. vali*) of Central Abyssinia is a very large and dark-coloured animal, with the horns black instead of brownish, and bearing only slightly marked front ridges. The Caucasian ibex (*C. caucasica*), or tur, is a wholly fox-coloured animal, in which the horns are still flatter in front, and thus depart yet further from the ibex type. In the Spanish ibex (*C. pyrenaica*) the horns are flattened, with ill-defined knobs, and a spiral twist. (SEE GOAT.) (W. H. F.; R. L.)\*

**IBIS**, one of the sacred birds of the ancient Egyptians. James Bruce identified this bird with the *Abu-Hannes* or "Father John" of the Abyssinians, and in 1790 it received from Latham (*Index ornithologicus*, p. 766) the name of *Tantalus aethiopicus*. This determination was placed beyond question by Cuvier (*Ann. du Muséum*, iv. 116-135) and Savigny (*Hist. nat. et mythol. de l'ibis*) in 1805. They, however, removed it from the Linnaean genus *Tantalus* and, Lacépède having some years before founded a genus *Ibis*, it was transferred thither, and is now generally known as *I. aethiopicus*, though some speak of it as *I. religiosa*. No attempt can here be made to treat the ibis from a mythological or antiquarian point of view. Savigny's memoir contains a great deal of matter on the subject. Wilkinson (*Ancient Egyptians*, ser. 2, vol. ii. pp. 217-224) added some of the results of later research, and Renouf in his *Hibbert Lectures* explains the origin of the myth.

The ibis is chiefly an inhabitant of the Nile basin from Dongola southward, as well as of Kordofan and Sennar; whence about

midsummer it moves northwards to Egypt.<sup>1</sup> In Lower Egypt it bears the name of *Abu-mengel*, or "father of the sickle," from the form of its bill, but it does not stay long in that country, disappearing when the Nile has subsided. Hence most travellers have failed to meet with it there<sup>2</sup> (since their acquaintance with the birds of Egypt is limited to those which frequent the country in winter), and writers have denied generally to this species a place in its modern fauna (cf. Shelley, *Birds of Egypt*, p. 261). However, in 1864, von Heuglin (*Journ. für Ornithologie*, 1865, p. 100) saw a young bird which had been shot in the Delta, and E. C. Taylor (*Ibis*, 1878, p. 372) saw an adult which had been killed near Lake Menzal in 1877. The story told to Herodotus of its destroying snakes is, according to Savigny, devoid of truth, but Cuvier states that he discovered partly digested remains of a snake in the stomach of a mummied ibis.

The ibis is somewhat larger than a curlew, *Numenius arquata*, which bird it resembles, with a much stouter bill and stouter legs. The head and greater part of the neck are bare and black. The plumage is white, except the primaries, which are black, and a black plume, formed by the secondaries, tertials and lower scapulars, and richly glossed with bronze, blue and green, which curves gracefully over the hind-quarters. The bill and feet are also black. The young lack the ornamental plume, and in them the head and neck are clothed with short black feathers, while the bill is yellow. The nest is placed in bushes or high trees, the bird generally building in companies, and in the middle of August von Heuglin (*Orn. Nord-Ost-Afrikas*, p. 1138) found that it had from two to four young or much incubated eggs.<sup>3</sup> These are of a dingy white, splashed, spotted and speckled with reddish-brown.

Congeneric with the typical ibis are two or three other species, the *I. melanoccephala* of India, the *I. molucca* or *I. strictipennis*, of Australia, and the *I. bernieri* of Madagascar, all of which closely resemble *I. aethiopicus*; while many other forms not very far removed from it, though placed by authors in distinct genera,<sup>4</sup> are known. Among these are several beautiful species such as the Japanese *Geronticus nippon*, the *Lophotis cristata* of Madagascar, and the scarlet ibis,<sup>5</sup> *Eudocimus ruber*, of America. The glossy ibis, *Plegadis falcinellus*, found throughout the West Indies, Central and the south-eastern part of North America, as well as in many parts of Europe (whence it not unfrequently strays to the British Islands), Africa, Asia and Australia. This bird, believed to be the second kind of ibis spoken of by Herodotus, is rather smaller than the sacred ibis, and mostly of a dark chestnut colour with brilliant green and purple reflections on the upper parts, exhibiting, however, when young none of the rufous hue. This species lays eggs of a deep sea-green colour, having wholly the character of heron's eggs, and it often breeds in company with herons, while the eggs of all other ibises whose eggs are known resemble those of the sacred ibis. Though ibises resemble the curlews externally, there is no affinity between them. The *Ibididae* are more nearly related to the storks, *Ciconiidae*, and still more to the spoonbills, *Plataleidae*, with which latter many systematists consider them to form one group, the *Hemiglottidés* of Nitzsch. Together these groups form the sub-order *Ciconiæ* of the order *Ciconiiformes*. The true ibises are also to be clearly separated from the wood-ibises, *Tantalidae*, of which there are four or five species, by several not unimportant structural characters. Fossil remains of a true

<sup>1</sup> It has been said to occur occasionally in Europe (Greece and southern Russia).

<sup>2</sup> E. C. Taylor remarked (*Ibis*, 1859, p. 51), that the buff-backed heron, *Ardea bubalus*, was made by the tourists' dragomans to do duty for the "sacred ibis," and this seems to be no novel practice, since by it, or something like it, Hasselquist was misled, and through him Linnaeus.

<sup>3</sup> The ibis has more than once nested in the gardens of the Zoological Society in London, and even reared its young there.

<sup>4</sup> For some account of these may be consulted Dr Reichenow's paper in *Journ. für Ornithologie* (1877), pp. 143-156; Elliot's in *Proc. Zool. Society* (1877), pp. 477-510; and that of Oustalet in *Nouv. Arch. du Muséum*, ser. 2, vols. i. pp. 17-184.

<sup>5</sup> It is a popular error—especially among painters—that this bird was the sacred ibis of the Egyptians.

ibis, *I. pagana*, have been found in considerable numbers in the middle Tertiary beds of France.<sup>1</sup> (A. N.)

**IBLIS**, or **EBLIS**, in Moslem mythology the counterpart of the Christian and Jewish devil. He figures oftener in the Koran under the name Shaitan, Iblis being mentioned 11 times, whereas Shaitan appears in 87 passages. He is chief of the spirits of evil, and his personality is adapted to that of his Jewish prototype. Iblis rebelled against Allah and was expelled from Paradise. The Koranic legend is that his fall was a punishment for his refusal to worship Adam. Condemned to death he was afterwards respited till the judgment day (Koran vii. 13).

See Gustav Weil, *The Bible, the Koran and the Talmud* (London, 1846).

**IBN 'ABD RABBIHI** [Abū 'Umar Ahmad ibn Maḥmūd ibn 'Abd Rabbihi] (860-940), Arabian poet, was born in Cordova and descended from a freed slave of Hishām, the second Spanish Omayyad caliph. He enjoyed a great reputation for learning and eloquence. No diwan of his is extant, but many selections from his poems are given in the *Yatimat ud-Dahr*, i. 412-436 (Damascus, 1887). More widely known than his poetry is his great anthology, the *Iqd ul-Farid* ("The Precious Necklace"), a work divided into twenty-five sections, the thirteenth being named the middle jewel of the necklace, the chapters on either side of this being named after other jewels. It is an *adab* book (see ARABIA: *Literature*, section "Belles Lettres") resembling Ibn Qutaiba's *Uyūn ul-Akhhār*, from which it borrows largely. It has been printed several times in Cairo (1876, 1886, &c.). (G. W. T.)

**IBN 'ARABI** [Muḥyīuddīn Abū 'Abdallāh ibn 'Arabi] (1165-1240), Moslem theologian and mystic, was born in Murcia and educated in Seville. When thirty-eight he travelled in Egypt, Arabia, Bagdad, Mosul and Asia Minor, after which he lived in Damascus for the rest of his life. In law he was a Zahirite, in theology a mystic of the extreme order, though professing orthodox Ash'arite theology and combating in many points the Indo-Persian mysticism (pantheism). He claims to have had conversations with all the prophets past and future, and reports conversations with God himself. Of his numerous works about 150 still exist. The most extensive is the twelve-volume *Futūḥ ul-Makkiyyat* ("Meccan Revelations"), a general encyclopaedia of Sufic beliefs and doctrines. Numerous extracts from this work are contained in Sha'rānī's (d. 1365) manual of Sufic dogma (*Yawqūt*) published several times in Cairo. A short account of these works is given in A. von Kremer's *Geschichte der herrschenden Ideen des Islams*, pp. 102-109 (Leipzig, 1868). Another characteristic and more accessible work of Ibn 'Arabi is the *Fuṣūṣ ul-Hikam*, on the nature and importance of the twenty-seven chief prophets, written in 1230 (ed. Bulāq, 1837) and with the *Commentary* (Cairo, 1891) of Qāshānī (d. 1350); cf. analysis by M. Schreiner in *Journal of German Oriental Society*, lii. 516-525.

Of some 289 works said to have been written by Ibn 'Arabi 150 are mentioned in C. Brockelmann's *Gesch. der arabischen Literatur*, vol. i. (Weimar, 1898), pp. 441-448. See also R. A. Nicholson, *A Literary History of the Arabs*, pp. 399-404 (London, 1907). (G. W. T.)

**IBN ATHĪR**, the family name of three brothers, all famous in Arabian literature, born at Jazirat ibn 'Umar in Kurdistan. The eldest brother, known as MAJID UD-DIN (1149-1210), was long in the service of the amir of Mosul, and was an earnest student of tradition and language. His dictionary of traditions (*Kitāb un-Nihāya*) was published at Cairo (1893), and his dictionary of family names (*Kitāb ul-Murassa'*) has been edited by Seybold (Weimar, 1806). The youngest brother, known as DIYA UD-DIN (1163-1239), served Saladin from 1191 on, then his son, al-Malik ul-Afdal, and was afterwards in Egypt, Samosata, Aleppo, Mosul and Bagdad. He was one of the most famous aesthetic and stylistic critics in Arabian literature. His *Kitāb ul-Mathal*, published in Bulāq in 1865 (cf. *Journal of the German Oriental Society*, xxxv. 148, and Goldziher's

<sup>1</sup> The name "Ibis" was selected as the title of an ornithological magazine, frequently referred to in this and other articles, which made its first appearance in 1859.

*Abhandlungen*, i. 161 sqq.), contains some very independent criticism of ancient and modern Arabic verse. Some of his letters have been published by D. S. Margoliouth "On the Royal Correspondence of Diya ed-Din el-Jazari" in the *Actes du dixième congrès international des orientalistes*, sect. 3, pp. 7-21.

The brother best known by the simple name of Ibn Athir was ABU-L-HASAN 'IZZUDDIN MAHOMMED IBN UL-ATHIR (1160-1234), who devoted himself to the study of history and tradition. At the age of twenty-one he settled with his father in Mosul and continued his studies there. In the service of the amir for many years, he visited Bagdad and Jerusalem and later Aleppo and Damascus. He died in Mosul. His great history, the *Kāmil*, extends to the year 1231; it has been edited by C. J. Tornberg, *Ibn ul-Athiri Chronicon quod perfectissimum inscribitur* (14 vols., Leiden, 1851-1876), and has been published in 12 vols. in Cairo (1873 and 1886). The first part of this work up to A.H. 310 (A.D. 923) is an abbreviation of the work of Ṭabarī (q.v.) with additions. Ibn Athir also wrote a history of the Atabegs of Mosul, published in the *Recueil des historiens des croisades* (vol. ii., Paris); a work (*Uṣd ul-Ghāba*), giving an account of 7500 companions of Mahomet (5 vols., Cairo, 1863), and a compendium (the *Lubbāb*) of Sam'ānī's *Kitāb ul-Anṣāb* (cf. F. Wüstenfeld's *Specimen el-Lobabi*, Göttingen, 1835). (G. W. T.)

**IBN BATUTA**, i.e. ABU ABDULLAH MAHOMMED, surnamed IBN BATUTA (1304-1378), the greatest of Moslem travellers, was born at Tangier in 1304. He entered on his travels at twenty-one (1325) and closed them in 1355. He began by traversing the coast of the Mediterranean from Tangier to Alexandria, finding time to marry two wives on the road. After some stay at Cairo, then probably the greatest city in the world (excluding China), and an unsuccessful attempt to reach Mecca from Aidhab on the west coast of the Red Sea, he visited Palestine, Aleppo and Damascus. He then made the pilgrimage to Mecca and Medina, and visited the shrine of Ali at Mashhad-Ali, travelling thence to Basra, and across the mountains of Khuzistan to Isfahan, thence to Shiraz and back to Kufa and Bagdad. After an excursion to Mosul and Diarbekr, he made the *haj* a second time, staying at Mecca three years. He next sailed down the Red Sea to Aden (then a place of great trade), the singular position of which he describes, noticing its dependence for water-supply upon the great cisterns restored in modern times. He continued his voyage down the African coast, visiting, among other places, Mombasa and Quiloa (Kilwa). Returning north he passed by the chief cities of Oman to New Ormuz (Hurmuz), which had about 15 years before, c. 1315, been transferred to its famous island-site from the mainland (Old Ormuz). After visiting other parts of the gulf he crossed the breadth of Arabia to Mecca, making the *haj* for the third time. Crossing the Red Sea, he made a journey of great hardship to Syene, and thence along the Nile to Cairo. After this, travelling through Syria, he made a circuit among the petty Turkish states into which Asia Minor was divided after the fall of the kingdom of Rum (Iconium). He now crossed the Black Sea to Kaffa, then mainly occupied by the Genoese, and apparently the first Christian city he had seen, for he was much perturbed by the bell-ringing. He next travelled into Kipchak (the Mongol khanate of Russia), and joined the camp of the reigning khan Mahommed Uzbeq, from whom the great and heterogeneous *Uzbeq* race is perhaps named. Among other places in this empire he travelled to Bolghar (54° 54' N.) in order to witness the shortness of the summer night, and desired to continue his travels north into the "Land of Darkness" (in the extreme north of Russia), of which wonderful things were told, but was obliged to forego this. Returning to the khan's camp he joined the cortège of one of the Khatuns, who was a Greek princess by birth (probably illegitimate) and in her train travelled to Constantinople, where he had an interview with the emperor Andronikos III. the Younger (1328-1341). He tells how, as he passed the city gates, he heard the guards muttering *Sarakinu*. Returning to the court of Uzbeq, at Sarai on the Volga, he crossed the steppes to Khwarizm and Bokhara; thence through Khorasan and Kabul, and over the Hindu Kush (to which he gives that name, its first occurrence). He reached

the Indus, on his own statement, in September, 1333. This closes the first part of his narrative.

From Sind, which he traversed to the sea and back again, he proceeded to Multan, and eventually, on the invitation of Mahommed Tughlak, the reigning sovereign, to Delhi. Mahommed was a singular character, full of pretence at least to many accomplishments and virtues, the founder of public charities, and a profuse patron of scholars, but a parricide, a fratricide, and as madly capricious, bloodthirsty and unjust as Caligula. "No day did his palace gate fail to witness the elevation of some object to affluence and the torture and murder of some living soul." He appointed the traveller to be kazi of Delhi, with a present of 12,000 silver dinars (rupees), and an annual salary of the same amount, besides an assignment of village lands. In the sultan's service Ibn Batuta remained eight years; but his good fortune stimulated his natural extravagance, and his debts soon amounted to four or five times his salary. At last he fell into disfavour and retired from court, only to be summoned again on a congenial duty. The emperor of China, last of the Mongol dynasty, had sent a mission to Delhi, and the Moor was to accompany the return embassy (1342). The party travelled through central India to Cambay and thence sailed to Calicut, classed by the traveller with the neighbouring Kaulam (Quilon), Alexandria, Sudak in the Crimea, and Zayton (Amoy harbour) in China, as one of the greatest trading havens in the world—an interesting enumeration from one who had seen them all. The mission party was to embark in Chinese junks (the word used) and smaller vessels, but that carrying the other envoys and the presents, which started before Ibn Batuta was ready, was wrecked totally; the vessel that he had engaged went off with his property, and he was left on the beach of Calicut. Not daring to return to Delhi, he remained about Honoré and other cities of the western coast, taking part in various adventures, among others the capture of Sindapur (Goa), and visiting the Maldivé Islands, where he became kazi, and married four wives, and of which he has left the best medieval account, hardly surpassed by any modern. In August 1344 he left the Maldives for Ceylon; here he made the pilgrimage to the "Footmark of our Father Adam." Thence he betook himself to Maabar (the Coromandel coast), where he joined a Mussulman adventurer, residing at Madura, who had made himself master of much of that region. After once more visiting Malabar, Canara and the Maldives, he departed for Bengal, a voyage of forty-three days, landing at Sadkawan (Chittagong). In Bengal he visited the famous Moslem saint Shaykh Jalaluddin, whose shrine (*Shah Jalal* at Silhet) is still maintained. Returning to the delta, he took ship at Sunargang (near Dacca) on a junk bound for Java (*i.e. Java Minor* of Marco Polo, or Sumatra). Touching the coast of Arakan or Burma, he reached Sumatra in forty days, and was provided with a junk for China by Malik al Dahir, a zealous disciple of Islam, which had recently spread among the states on the northern coast of that island. Calling (apparently) at Cambodia on his way, Ibn Batuta reached China at Zayton (Amoy harbour), famous from Marco Polo; he also visited Sin Kalan or Canton, and professes to have been in Khansa (*Kinsay* of Marco Polo, *i.e.* Hangchow), and Khanbalik (*Cambaluc* or Peking). The truth of his visit to these two cities, and especially to the last, has been questioned. The traveller's history, not least in China, singularly illustrates the free masonry of Islam, and its power of carrying a Moslem doctor over the known world of Asia and Africa. On his way home he saw the great bird *Rukh* (evidently, from his description, an island lifted by refraction); revisited Sumatra, Malabar, Oman, Persia, Bagdad, and crossed the great desert to Palmyra and Damascus, where he got his first news of home, and heard of his father's death fifteen years before. Diverging to Hamath and Aleppo, on his return to Damascus, he found the Black Death raging, so that two thousand four hundred died in one day. Revisiting Jerusalem and Cairo he made the *hajj* a fourth time, and finally reappeared at Fez (visiting Sardinia *en route*) on the 8th of November 1349, after twenty-four years' absence. Morocco, he felt, was, after all, the best of countries. "The *dirhems* of the West are but little; but then you get more for

them." After going home to Tangier, Ibn Batuta crossed into Spain and made the round of Andalusia, including Gibraltar, which had just then stood a siege from the "Roman tyrant Adifunus" (Alphonso XI. of Castile, 1312-1350). In 1352 the restless man started for Central Africa, passing by the oases of the Sahara (where the houses were built of rock-salt, as Herodotus tells, and roofed with camel skins) to Timbuktu and Gogo on the Niger, a river which he calls the Nile, believing it to flow down into Egypt, an opinion maintained by some up to the date of Lander's discovery. Being then recalled by his own king, he returned to Fez (early in 1354) via Takadda, Haggar and Tuat. Thus ended his twenty-eight years' wanderings which in their main lines alone exceeded 75,000 m. By royal order he dictated his narrative to Mahommed Ibn Juzai, who concludes the work, 13th of December 1355 (A.D.) with the declaration: "This Shaykh is the traveller of our age; and he who should call him the traveller of the whole body of Islam would not exceed the truth." Ibn Batuta died in 1378, aged seventy-three.

Ibn Batuta's travels have only been known in Europe during the 19th century; at first merely by Arabic abridgments in the *Gotha* and *Notices*, or extracts had been published by Seeetzen (c. 1808), Kosegarten (1818), Apetz (1819), and Burckhardt (1819), who in 1829 Dr S. Lee published for the Oriental Translation Fund a version from the abridged MSS. at Cambridge, which attracted much interest. The French capture of Constantinia afforded MSS. of the complete work, one of them the autograph of Ibn Juzai. And from these, after versions of fragments by various French scholars, was derived at last (1858-1859) the standard edition and translation of the whole by M. Défremery and Dr Sanguinetti, in 4 vols. See also Sir Henry Yule, *Cathay*, ii. 397-526; C. Raymond Beazley, *Dawn of Modern Geography*, iii. 535-538. Though there are some singular chronological difficulties in the narrative, and a good many cursory inaccuracies and exaggerations, there is no part of it except, perhaps, certain portions of the journeys in north China, which is open to doubt. The accounts of the Maldivé Islands, and of the Negro countries on the Niger, are replete with interesting and accurate particulars. The former agree surprisingly with that given by the only other foreign resident we know of, Pyrard de La Val, two hundred and fifty years later. Ibn Batuta's statements and anecdotes regarding the showy virtues and solid virtues of Sultan Muhammad Tughlak are in entire agreement with Indian historians, and add many fresh details. (H. Y.; C. R. B.)

**IBN DURAID** [Abū Bakr Mahommed ibn ul-Ḥasan ibn Duraid ul-Azdi] (837-934), Arabian poet and philologist, was born at Baṣra of south Arabian stock. At his native place he was trained under various teachers, but fled in 871 to Oman at the time Baṣra was attacked by the negroes, known as the Zanj, under Muḥallabī. After living twelve years in Oman he went to Persia, and, under the protection of the governor, 'Abdallah ibn Mahommed ibn Mikāl, and his son, Isma'īl, wrote his chief works. In 920 he went to Bagdad, where he received a pension from the caliph Moqtadir.

The *Maqāṣira*, a poem in praise of Ibn Mikāl and his son, has been edited by A. Haitsma (1773), E. Scheidus (1786) and N. Boyesen (1828). Various commentaries on the poem exist in MS. (cf. C. Brockelmann, *Gesch. der ar. Lit.*, i. 211 ff., Weimar, 1898). The *Jamhara fi-l-Lughā* is a large dictionary written in Persian but not printed. Another work is the *Kitāb ul-Jahīriga* ("Book of Etymology"), edited by F. Wüstenfeld (Göttingen, 1854); it was written in opposition to the anti-Arabian party to show the etymological connexion of the Arabian tribal names. (G. W. T.)

**IBN FARĀDĪ** [Abū-l-Walīd 'Abdallah ibn ul-Farādī] (962-1012), Arabian historian, was born at Cordova and studied law and tradition. In 992 he made the pilgrimage and proceeded to Egypt and Kairawan, studying in these places. After his return in 1009 he became *caḍi* in Valencia, and was killed at Cordova when the Berbers took the city.

His chief work is the *History of the Learned Men of Andalusia*, edited by F. Codera (Madrid, 1891-1892). He wrote also a history of the poets of Andalusia. (G. W. T.)

**IBN FARĪD** [Abū-l-Qāsim 'Umar ibn ul-Fārīdī] (1181-1235), Arabian poet, was born in Cairo, lived for some time in Mecca and died in Cairo. His poetry is entirely Sufic, and he was esteemed the greatest mystic poet of the Arabs. Some of his poems are said to have been written in ecstasies. His diwan has been published with commentary at Beirūt, 1887, &c.; and in the commentaries of Burinī (d. 1615) and 'Abdul-Ghānī (d. 1730) at Marseilles, 1853, and at Cairo; and with the commentary of Rushayyid Ghālib



(10th century) at Cairo, 1803. One of the separate poems was edited by J. von Hammer Purgstall as *Das arabische hohe Lied der Liebe* (Vienna, 1854).

See R. A. Nicholson, *A Literary History of the Arabs* (London, 1907), pp. 394-398. (G. W. T.)

**IBN GABIROL** [SOLOMON BEN JUDAH], Jewish poet and philosopher, was born at Malaga, probably about 1021. The early part of his troublous life was spent at Saragossa, but few personal details of it are recorded. His parents died while he was a child and he was under the protection first of a certain Jekuthiel, who died in 1030, and afterwards of Samuel ha-Nagid, the well-known patron of learning. His passionate disposition, however, embittered no doubt by his misfortunes, involved him in frequent difficulties and led to his quarrelling with Samuel. It is generally agreed that he died young, although the date is uncertain. Al Harizi<sup>1</sup> says at the age of twenty-nine, and Moses b. Ezra<sup>2</sup> about thirty, but Abraham Zacuto<sup>3</sup> states that he died (at Valencia) in 1070. M. Steinschneider<sup>4</sup> accepts the date 1058.

His literary activity began early. He is said to have composed poems at the age of sixteen, and elegies by him are extant on Hai Gaon (died in 1038) and Jekuthiel (died in 1030), each of which was written probably soon after the death of the person commemorated. About the same time he also wrote his *Anag*, a poem on grammar, of which only 97 lines out of 400 are preserved. Moses ben Ezra says of him that he imitated Moslem models, and was the first to open to Jewish poets the door of versification,<sup>5</sup> meaning that he first popularized the use of Arabic metres in Hebrew. It is as a poet that he has been known to the Jews to the present day, and admired for the youthful freshness and beauty of his work, in which he may be compared to the romantic school in France and England in the early 10th century. Besides his lyrical and satirical poems, he contributed many of the finest compositions to the liturgy (some of them with the acrostic "Shelomoh ha-qaton"), which are widely different from the artificial manner of the earlier payyetanim. The best known of his longer liturgical compositions are the philosophical *Kether Malkuth* (for the Day of Atonement) and the *Azharoth*, on the 613 precepts (for *Shebhū'oth*). Owing to his pure biblical style he had an abiding influence on subsequent liturgical writers.

Outside the Jewish community he was known as the philosopher Avicbron (Avencebrol, Avicebrol, &c.) The credit of identifying this name as a medieval corruption of Ibn Gabirol is due to S. Munk, who showed that selections made by Shem Tóbb Palquera (or Falquera) from the Meqor Hayyim (the Hebrew translation of an Arabic original) by Ibn Gabirol, corresponded to the Latin *Fons Vitae* of Avicbron. The Latin version, made by Johannes Hispanensis and Gundisalvi about one hundred years after the author's death, had at once become known among the Schoolmen of the 12th century and exerted a powerful influence upon them, although so little was known of the author that it was doubted whether he was a Christian or a Moslem. The teaching of the *Fons Vitae* was entirely new to the country of its origin, and being drawn largely from Neoplatonic sources could not be expected to find favour with Jewish thinkers. Its distinctive doctrines are: (1) that all created beings, spiritual or corporeal, are composed of matter and form, the various species of matter being but varieties of the universal matter, and similarly all forms being contained in one universal form; (2) that between the primal One and the intellect (the *vois* of Plotinus) there is interposed the divine Will, which is itself divine and above the distinction of form and matter, but is the cause of their union in the being next to itself, the intellect, in which Avicbron holds that the distinction does exist. The

doctrine that there is a material, as well as a formal, element in all created beings was explicitly adopted from Avicbron by Duns Scotus (as against the view of Albertus Magnus and Thomas Aquinas), and perhaps his exaltation of the will above the intellect is due to the same influence. Avicbron develops his philosophical system throughout quite independently of his religious views—a practice wholly foreign to Jewish teachers, and one which could not be acceptable to them. Indeed, this charge is expressly brought against him by Abraham ben David of Toledo (died in 1180). It is doubtless this non-religious attitude which accounts for the small attention paid to the *Fons Vitae* by the Jews, as compared with the wide influence of the philosophy of Maimonides.

The other important work of Ibn Gabirol is *Islāh al-akhlāq* (the improvement of character), a popular work in Arabic, translated into Hebrew (*Tiqqun middeth ha-nephesh*) by Judah ibn Tibbon. It is widely different in treatment from the *Fons*, being intended as a practical not a speculative work.

The collection of moral maxims, compiled in Arabic but best known (in the Hebrew translation of Judah ibn Tibbon) as *Mibhar ha-peninin*, is generally ascribed to Ibn Gabirol, though on less certain grounds.

<sup>1</sup> BIBLIOGRAPHY.—Texts of the liturgical poems are to be found in the prayer-books: others in Dukes and Edelmann, *Treasures of Oxford* (Oxford, 1850); Dukes, *Shirē Shelomoh* (Hanover, 1858); S. Sachs, *Shir ha-shirim asher li-Shelomoh* (Paris, 1868, incomplete); Brody, *Die weltlichen Gedichte des . . . Gabirol* (Berlin, 1807, &c.); *Avencebrol's Fons Vitae* (Latin text) in Clemens Bäumker's *Beiträge zur Gesch. d. Philosophie*, Bd. i. Hefte 2-4 (Münster, 1802); *The Improvement of the Moral Qualities* (Arabic and English) ed. by S. S. Wise (New York, 1901); *A Choice of Pearls* (Hebrew and English) ed. by Ascher (London, 1850).

On the philosophy in general: S. Munk, *Mélanges* (quoted above); Guttman, *Die Philosophie des Sal.-ibn Gabirol* (Göttingen, 1889); D. Kaufmann, *Studien über Sal.-ibn Gabirol* (Budapest, 1899); S. Horowitz, "Die Psychologie Ibn Gabirol's," in *Jahresbericht des . . . theol. Seminars Fränkelscher Stiftungs* (Breslau, 1900); Wittmann, "Zur Stellung Avencebrol's . . ." (in *Bäumker's Beiträge*, Bd. v. Heft 1, Münster, 1905). (A. C. V.)

**IBN HAUQAL**, strictly IBN HAQVAL, a 10th century Arabian geographer. Nothing is known of his life. His work on geography, written in 977, is only a revision and extension of the *Musallik ul-Mamalik* of al-Istakhri, who wrote in 951. This itself was a revised edition of the *Kitāb ul-Ashkāl* or *Shuwar ul-Aqālim* of Abū Zaid ul-Balkhī, who wrote about 921. Ibn Hauqal's work was published by M. J. de Goeje (Leiden, 1873). An anonymous epitome of the book was written in 1233.

See M. J. de Goeje, "Die Istahri-Balhi Frage," in the *Zeitschrift der Deutschen Morgenländischen Gesellschaft*, xxv. 42 sqq.

**IBN HAZM** [Abū Maḥmūd 'Alī ibn 'Almad ibn 'Hāzim] (904-1064), Moslem theologian, was born in a suburb of Cordova. He studied history, law and theology, and became a vizier as his father had been before him, but was deposed for heresy, and spent the rest of his life quietly in the country. In legal matters he belonged first to the Shāfi'ite school, but came to adopt the views of the Zahirites, who admitted only the external sense of the Koran and tradition, disallowing the use of analogy (*Qiyās*) and *Taqlid* (appeal to the authority of an imām), and objecting altogether to the use of individual opinion (*Ra'y*). Every sentence of the Koran was to be interpreted in a general and universal sense; the special application to the circumstances of the time it was written was denied. Every word of the Koran was to be taken in a literal sense, but that sense was to be learned from other uses in the Koran itself, not from the meaning in other literature of the time. The special feature of Ibn 'Hāzim's teaching was that he extended the application of these principles from the study of law to that of dogmatic theology. He thus found himself in opposition at one time to the Mo'azzilites, at another to the Ash'arites. He did not, however, succeed in forming a school. His chief work is the *Kitāb ul-Mīlāl wan-Nihāl*, or "Book of Sects" (published in Cairo, 1899).

For his teaching cf. I. Goldziher, *Die Zahiriten*, pp. 116-172 (Leipzig, 1884), and M. Schreiner in the *Journal of the German Oriental Society*, lii. 464-486. For a list of his other works see C. Brockelmann's *Geschichte der arabischen Literatur*, vol. i. (Weimar, 1898), p. 400. (G. W. T.)

<sup>1</sup> *Jud. Har. Macama*, ed. Lagarde (Göttingen, 1883), p. 89, l. 61. <sup>2</sup> See the passage quoted by Munk, *Mélanges de philosophie arabe et juive* (Paris, 1859), pp. 264 and 517.

<sup>3</sup> *Libor Jacobus*, ed. Filipowski (London, 1857), p. 217.

<sup>4</sup> *Hebr. Übersetzungen* (Berlin, 1893), § 219, note 70; cf. Kaufmann, *Studien über Sal.-ibn Gabirol* (Budapest, 1899), p. 79, note 2.

<sup>5</sup> See Munk, *op. cit.* pp. 515-516, transl. on pp. 263-264. Metre had been already used by Dunash.

**IBN HISHÂN** [Abū Maḥammad 'Abdulmalik ibn Hishām ibn Ayyūb ul-Himyārī] (d. 834), Arabian biographer, studied in Kufa but lived afterwards in Fostat (old Cairo), where he gained a name as a grammarian and student of language and history. His chief work is his edition of Ibn Ishāq's (q.v.) *Life of the Apostle of God*, which has been edited by F. Wüstenfeld (Göttingen, 1858-1860). An abridged German translation has been made by G. Weil (Stuttgart, 1864; cf. P. Brönne, *Die Commentatoren des Ibn Ishāq und ihre Scholien*, Halle, 1895). Ibn Hishām is said to have written a work explaining the difficult words which occur in poems on the life of the Apostle, and another on the genealogies of the Himyārīs and their princes. (G. W. T.)

**IBN ISHĀQ** [Maḥammad ibn Ishāq Abū 'Abdallāh] (d. 768), Arabic historian, lived in Medina, where he interested himself to such an extent in the details of the Prophet's life that he was attacked by those to whom his work seemed to have a rationalistic tendency. He consequently left Medina in 733, and went to Alexandria, then to Kufa and Hira, and finally to Bagdad, where the caliph Maṅṣūr provided him with the means of writing his great work. This was the *Life of the Apostle of God*, which is now lost and is known to us only in the recension of Ibn Hishām (q.v.). The work has been attacked by Arabian writers (as in the *Fihrist*) as untrustworthy, and it seems clear that he introduced forged verses (cf. *Journal of the German Oriental Society*, xiv, 288 sqq.). It remains, however, one of the most important works of the age. (G. W. T.)

**IBN JUBAIR** [Abū-l-Ḥusain Maḥammad ibn Aḥmad ibn Jubair] (1145-1217), Arabian geographer, was born in Valencia. At Granada he studied the Koran, tradition, law and literature, and later became secretary to the Mohad governor of that city. During this time he composed many poems. In 1183 he left the court and travelled to Alexandria, Jerusalem, Medina, Mecca, Damascus, Mosul and Bagdad, returning in 1185 by way of Sicily.

The *Travels of Ibn Jubair* were edited by W. Wright (Leiden, 1852); and a new edition of this text, revised by M. J. de Goeje, was published by the Gibb's Trustees (London, 1897). A part relating to Sicily was published, with French translation and notes, by M. Amari in the *Journal asiatique* (1845-1846) and a French translation alone of the same part by G. Crolla in *Museon*, vi, 123-132. (G. W. T.)

**IBN KHALDŪN** [Abū Zaid ibn Maḥammad ibn Maḥammad ibn Khaldūn] (1332-1406), Arabic historian, was born at Tunis. He studied the various branches of Arabic learning with great success. In 1352 he obtained employment under the Marfīnid sultan Abū Inān (Fāris I.) at Fez. In the beginning of 1356, his integrity having been suspected, he was thrown into prison until the death of Abū Inān in 1358, when the vizier al-Ḥasan ibn Omar set him at liberty and reinstated him in his rank and offices. He here continued to render great service to Abū Salem (Ibrahīm III.), Abū Inān's successor, but, having offended the prime minister, he obtained permission to emigrate to Spain, where, at Granada, he was received with great cordiality by Ibn al-Aḥmar, who had been greatly indebted to his good offices when an exile at the court of Abū Salem. The favours he received from the sovereign excited the jealousy of the vizier, and he was driven back to Africa (1364), where he was received with great cordiality by the sultan of Bougie, Abū Abdallāh, who had been formerly his companion in prison. On the fall of Abū Abdallāh Ibn Khaldūn raised a large force amongst the desert Arabs, and entered the service of the sultan of Tlemcen. A few years later he was taken prisoner by Abdalaziz ('Abd ul-'Aziz), who had defeated the sultan of Tlemcen and seized the throne. He then entered a monastic establishment, and occupied himself with scholastic duties, until in 1370 he was sent for to Tlemcen by the new sultan. After the death of 'Abd ul-'Aziz he resided at Fez, enjoying the patronage and confidence of the regent. After some further vicissitudes in 1378 he entered the service of the sultan of his native town of Tunis, where he devoted himself almost exclusively to his studies and wrote his history of the Berbers. Having received permission to make the pilgrimage to Mecca, he reached Cairo, where he was presented to the sultan,

al-Malik udh-Dhahir Barkuk, who insisted on his remaining there, and in the year 1384 made him grand cadi of the Maliki rite for Cairo. This office he filled with great prudence and probity, removing many abuses in the administration of justice in Egypt. At this time the ship in which his wife and family, with all his property, were coming to join him, was wrecked, and every one on board lost. He endeavoured to find consolation in the completion of his history of the Arabs of Spain. At the same time he was removed from his office of cadi, which gave him more leisure for his work. Three years later he made the pilgrimage to Mecca, and on his return lived in retirement in the Fayum until 1399, when he was again called upon to resume his functions as cadi. He was removed and reinstated in the office no fewer than five times.

In 1400 he was sent to Damascus, in connexion with the expedition intended to oppose Timur or Tamerlane. When Timur had become master of the situation, Ibn Khaldūn let himself down from the walls of the city by a rope, and presented himself before the conqueror, who permitted him to return to Egypt. Ibn Khaldūn died on the 16th of March 1406, at the age of sixty-four.

The great work by which he is known is a "Universal History," but it deals more particularly with the history of the Arabs of Spain and Africa. Its Arabic title is *Kitāb ul-Tarīkh wa'l-Asnād Muḥaddath wa'l-Khabar*, its Arabic title is *Kitāb ul-Ajām wa'l-Berber*; that is, "The Book of Examples and the Collection of Origins and Information respecting the History of the Arabs, Foreigners and Berbers." It consists of three books, an introduction and an autobiography. Book i. treats of the influence of civilization upon man; book ii. of the history of the Arabs and other peoples from the remotest antiquity until the author's own times; book iii. of the history of the Berber tribes and of the kingdoms founded by that race in North Africa. The introduction is an elaborate treatise on the science of history and the development of society, and the autobiography contains the history not only of the author himself, but of his family and of the dynasties which ruled in Fez, Tunis and Tlemcen during his lifetime. An edition of the Arabic text has been printed at Bīlāq, (7 vols., 1867) and a part of the work has been translated by the late Baron MCG. de Slane under the title of *Histoire des Berbères* (Algiers, 1852-1856); it contains an admirable account of the author and analysis of his work. Vol. i., the *Muqaddama* (preface), was published by M. Quatremère (3 vols., Paris, 1858), often republished in the East, and a French translation was made by MCG. de Slane (3 vols., Paris, 1868). The part of the history relating to the expeditions of the Franks into Moslem lands were edited by C. Tornberg (Upsala, 1840), and the parts treating of the Banū-'Abmar kings of Granada were translated into French by M. Gaudfroy-Demombynes in the *Journal asiatique*, ser. 9, vol. xiii. The *Autobiography* of Ibn Khaldūn was translated into French by de Slane in the *Journal asiatique*, ser. 4, vol. iii. For an English appreciation of the philosophical spirit of Ibn Khaldūn see R. Flint's *History of the Philosophy of History* (Edinburgh, 1893), pp. 157-170. (E. H. P.; G. W. T.)

**IBN KHALLIKĀN** [Abū-l-'Abbās Aḥmad ibn KhalīkĀn] (1211-1282), Arabian biographer, was born at Arbelā, the son of a professor reputed to be descended from the Barmecides of the court of Harun al-Rashid. When eighteen he went to Aleppo, where he studied for six years, then to Damascus, and in 1238 to Alexandria and Cairo. In 1252 he married and became chief cadi of Syria in Damascus in 1261. Having held this office for ten years, he was professor in Cairo until 1278, when he again took office in Damascus for three years. In 1281 he accepted a professorship in the same city, but died in the following year.

His great work is the *Kitāb Waḥayyū ul-'A'yām*, "The Obituaries of Eminent Men." It contains in alphabetical order the lives of the most celebrated persons of Moslem history and literature, except those of Mahomet, the four caliphs and the companions of Mahomet and their followers (the *Tāribīn*). The work is anecdotal and contains many brief extracts from the poetry of the writers. It was published by F. Wüstenfeld (Göttingen, 1835-1843), in part by MCG. de Slane (Paris, 1838-1842), and also in Cairo (1859 and 1882). An English translation by MCG. de Slane was published for the Oriental Translation Fund in 4 vols. (London, 1842-1871). Thirteen extra biographies from a manuscript in Amsterdam were published by Pijnappel (Amsterdam, 1845). A Persian translation exists in manuscript, and various extracts from the work are known. Several supplements to the book have been written, the best known being that of Maḥammad ibn Shākir (d. 1362), published at Cairo 1852. A collection of poems by Ibn KhalīkĀn is also extant. (G. W. T.)

**IBN QUTAIBA**, or KOTAIBA [Abū Maḥammad ibn Muslim ibn Qutaiba] (828-889), Arabian writer, was born at Bagdad or

Kufa, and was of Iranian descent, his father belonging to Merv. Having studied tradition and philology he became *cađi* in Dinawār and afterwards teacher in Bagdad, where he died. He was the first representative of the eclectic school of Bagdad philologists that succeeded the schools of Kufa and Bašra (see ARABIA: Literature, section "Grammar"). Although engaged also in the literary polemic (cf. I. Goldziher, *Muhammedanische Studien*, ii. 136, Halle, 1890), his chief works were directed to the training of the ideal secretary. Of these five may be said to form a series. The *Adab ul-Katib* ("Training of the Secretary") contains instruction in writing and is a compendium of Arabic style. It has been edited by Max Grūnert (Leiden, 1900). The *Kitāb ush-Sharāh* is still in manuscript. The *Kitāb ul-Ma'arif* has been edited by F. Wūstenfeld as the *Handbuch der Geschichte* (Göttingen, 1850); the *Kitāb ush-Shi'r wash-Shu'arāh* ("Book of Poetry and Poets'") edited by M. J. de Goeje (Leiden, 1904).<sup>2</sup> The fifth and most important is the '*U'yūn ul-Akhhār*, which deals in ten books with lordship, war, nobility, character, science and eloquence, asceticism, friendship, requests, foods and women, with many illustrations from history, poetry and proverb (ed. C. Brockelmann, Leiden, 1900 sqq.).

For other works (which were much quoted by later Arabian writers) see C. Brockelmann, *Gesch. der arabischen Literatur*, vol. i. (Weimar, 1898), pp. 120-122. (G. W. T.)

**IBN ŠA'D** [Abū 'Abdallāh Maḥammad ibn Ša'd ibn Manī' uz-Zuhri, often called Kātib ul-Waqidi ("secretary of Waqidi'") of Bašra] (d. 845), Arabian biographer, received his training in tradition from Waqidi and other celebrated teachers. He lived for the most part in Bagdad, and had the reputation of being both trustworthy and accurate in his writings, which, in consequence, were much used by later writers. His work, the *Kitāb ul-Taḥqāq ul-Kabir* (15 vols.) contains the lives of Mahomet, his Companions and Helpers (including those who fought at Badr as a special class) and of the following generation (the Followers) who received their traditions from the personal friends of the Prophet.

This work has been edited under the superintendence of E. Sachau (Leiden, 1904 sqq.); cf. O. Loth, *Das Classenbuch des Ibn Sa'd* (Leipzig, 1869). (G. W. T.)

**IBN TIBBON**, a family of Jewish translators, who flourished in Provence in the 12th and 13th centuries. They all made original contributions to philosophical and scientific literature, but their permanent fame is based on their translations. Between them they rendered into Hebrew all the chief Jewish writings of the middle ages. These Hebrew translations were, in their turn, rendered into Latin (by Buxtorf and others) and in this form the works of Jewish authors found their way into the learned circles of Europe. The chief members of the Ibn Tibbon family were (1) JUDAH BEN SAUL (1120-1190), who was born in Spain but settled in Lunel. He translated the works of Babya, Halevi, Saadiāh and the grammatical treatises of Janah. (2) His son, SAMUEL (1150-1230), translated the *Guide of the Perplexed* by Maimonides. He justly termed his father "the father of the Translators," but Samuel's own method surpassed his father's in lucidity and fidelity to the original. (3) Son of Samuel, MOSES (died 1283). He translated into Hebrew a large number of Arabic books (including the Arabic form of Euclid). The Ibn Tibbon family thus rendered conspicuous services to European culture, and did much to further among Jews who did not understand Arabic the study of science and philosophy. (I. A.)

**IBN TUFAYL**, of ṬUFAYL [Abū Bakr Maḥammad ibn 'Abd-ul-Malik ibn Tufayl ul-Qaisi] (d. 1185), Moslem philosopher, was born at Guadix near Granada. There he received a good training in philosophy and medicine, and is said to have been a pupil of Avempace (*q.v.*). He became secretary to the governor of Granada, and later physician and vizier to the Mohad caliph, Abu Ya'qūb Yūsuf. He died at Morocco.

His chief work is a philosophical romance, in which he describes the awakening and growth of intellect in a child removed from the influences of ordinary life. Its Arabic title is *Risālāt Ḥayy ibn Yaqẓān*; it was edited by E. Pococke as *Philosophus autodidactus* (Oxford, 1671; 2d ed., 1700), and with a French translation by L. Gauthier (Algiers, 1900). An English translation by S. Ockley was published in 1708 and has been reprinted since. A Spanish translation by F. Pons Boigues was published at Saragossa in 1900. Another work of Ibn Tufayl, the *Kitāb Asrār ul-Hikma ul-mashraqiyya* ("Secrets of Eastern Science"), was published at Bulaq (1882); cf. S. Munk, *Mélanges* (1859), pp. 410 sqq., and T. J. de Boer, *Geschichte der Philosophie im Islam* (Stuttgart, 1901), pp. 160 sqq. (also an English translation). (G. W. T.)

**IBN USAIBI'Ā** [Muwaffaqūddin Abū-l-'Abbās Aḥmad ibn ul-Qāsim Abi Usaib'ā] (1203-1270), Arabian physician, was born at Damascus, the son of an oculist, and studied medicine at Damascus and Cairo. In 1236 he was appointed by Saladin physician to a new hospital in Cairo, but surrendered the appointment the following year to take up a post given him by the amir of Damascus in Salkhad near that city. There he lived and died. He wrote '*U'yūn ul-Anbā' fi Ṭabaqāt ul-Ajibba*' or "Lives of the Physicians," which in its first edition (1245-1246) was dedicated to the vizier of Damascus. This he enlarged, though it is uncertain whether the new edition was made public in the lifetime of the author.

Edition by A. Müller (Königsberg, 1884).

(G. W. T.)

**IBO**, a district of British West Africa, on the lower Niger immediately above the delta, and mainly on the eastern bank of the river. The chief town, frequently called by the same name (more correctly Abo or Āboh), lies on a creek which falls into the main stream about 150 m. from its mouth and contains from 6000 to 8000 inhabitants. The Ibo are a strong well-built Negro race. Their women are distinguished by their embonpoint. The language of the Ibo is one of the most widely spoken on the lower Niger. The Rev. J. F. Schön began its reduction in 1841, and in 1861 he published a grammar (*Oku Ibo Grammatical Elements*, London, Church Miss. Soc.). (See NIGERIA.)

**IBRAHIM AL-MAUŠILĪ** (742-804), Arabian singer, was born of Persian parents settled in Kufa. In his early years his parents died and he was trained by an uncle. Singing, not study, attracted him, and at the age of twenty-three he fled to Mosul, where he joined a band of wild youths. After a year he went to Rai (Rei, Rhagae), where he met an ambassador of the caliph Maṅšūr, who enabled him to come to Bašra and take singing lessons. His fame as a singer spread, and the caliph Maḥdi brought him to the court. There he remained a favourite under Hādī, while Harūn al-Rashid kept him always with him until his death, when he ordered his son (Ma'mūn) to say the prayer over his corpse. Ibrahim, as might be expected, was no strict Moslem. Two or three times he was knouted and imprisoned for excess in wine-drinking, but was always taken into favour again. His powers of song were far beyond anything else known at the time. Two of his pupils, his son Ishāq and Muḥāriq, attained celebrity after him.

See the Preface to W. Ahlwardt's *Abu Nowas* (Greifswald, 1861), pp. 13-18, and the many stories of his life in the *Kitāb ul-Aghānī*, v. 2-49. (G. W. T.)

**IBRAHIM PASHA** (1780-1848), Egyptian general, is sometimes spoken of as the adopted son of Mehemet Ali, pasha of Egypt. He is also and more commonly called his son. He was born in his father's native town, Kavala in Thrace. During his father's struggle to establish himself in Egypt, Ibrahim, then sixteen years of age, was sent as a hostage to the Ottoman capitan pasha (admiral), but when Mehemet Ali was recognized as pasha, and had defeated the English expedition under General A. M. Fraser, he was allowed to return to Egypt. When Mehemet Ali went to Arabia to prosecute the war against the Wahhabis in 1813, Ibrahim was left in command in Upper Egypt. He continued the war with the broken power of the Mamelukes, whom he suppressed. In 1816 he succeeded his brother Tusun in command of the Egyptian forces in Arabia. Mehemet Ali had already begun to introduce European discipline into his army, and Ibrahim had probably received some training, but his first campaign was conducted more in the old Asiatic

<sup>1</sup> Summary in E. C. Browne, *A Literary History of Persia* (London, 1902), pp. 387 f.

<sup>2</sup> The preface was translated into German by Theodor Nöldeke in his *Beiträge* (Hanover, 1864), pp. 1-51.

style than his later operations. The campaign lasted two years, and terminated in the destruction of the Wahhabis as a political power. Ibrahim landed at Yembo, the port of Medina, on the 30th of September 1816. The holy cities had been recovered from the Wahhabis, and Ibrahim's task was to follow them into the desert of Nejd and destroy their fortresses. Such training as the Egyptian troops had received, and their artillery, gave them a marked superiority in the open field. But the difficulty of crossing the desert to the Wahhabi stronghold of Deraiya, some 400 m. east of Medina, and the courage of their opponents, made the conquest a very arduous one. Ibrahim displayed great energy and tenacity, sharing all the hardships of his army, and never allowing himself to be discouraged by failure. By the end of September 1818 he had forced the Wahhabi leader to surrender, and had taken Deraiya, which he ruined. On the 11th of December 1810 he made a triumphal entry into Cairo. After his return he gave effective support to the Frenchman, Colonel Séve (Suleiman Pasha), who was employed to drill the army on the European model. Ibrahim set an example by submitting to be drilled as a recruit. When in 1824 Mehemet Ali was appointed governor of the Morea by the sultan, who desired his help against the insurgent Greeks, he sent Ibrahim with a squadron and an army of 17,000 men. The expedition sailed on the 10th of July 1824, but was for some months unable to do more than come and go between Rhodes and Crete. The fear of the Greek fire ships stopped his way to the Morea. When the Greek sailors mutinied from want of pay, he was able to land at Modon on the 26th of February 1825. He remained in the Morea till the capitulation of the 1st of October 1828 was forced on him by the intervention of the Western powers. Ibrahim's operations in the Morea were energetic and ferocious. He easily defeated the Greeks in the open field, and though the siege of Missolonghi proved costly to his own troops and to the Turks who operated with him, he brought it to a successful termination on the 24th of April 1826. The Greek guerrilla bands harassed his army, and in revenge he desolated the country and sent thousands of the inhabitants into slavery in Egypt. These measures of repression aroused great indignation in Europe, and led first to the intervention of the English, French and Russian squadrons (see NAVARINO, BATTLE OF), and then to the landing of a French expeditionary force. By the terms of the capitulation of the 1st of October 1828, Ibrahim evacuated the country. It is fairly certain that the Turkish government, jealous of his power, had laid a plot to prevent him and his troops from returning to Egypt. English officers who saw him at Navarino describe him as short, grossly fat and deeply marked with smallpox. His obesity did not cause any abatement of activity when next he took the field. In 1831, his father's quarrel with the Porte having become flagrant, Ibrahim was sent to conquer Syria. He carried out his task with truly remarkable energy. He took Acre after a severe siege on the 27th of May 1832, occupied Damascus, defeated a Turkish army at Homs on the 8th of July, defeated another Turkish army at Beilan on the 20th of July, invaded Asia Minor, and finally routed the grand vizier at Konia on the 21st of December. The convention of Kutaiah on the 6th of May left Syria for a time in the hands of Mehemet Ali. Ibrahim was undoubtedly helped by Colonel Séve and the European officers in his army, but his intelligent docility to their advice, as well as his personal hardihood and energy, compare most favourably with the sloth, ignorance and arrogant conceit of the Turkish generals opposed to him. He is entitled to full credit for the diplomatic judgment and tact he showed in securing the support of the inhabitants, whom he protected and whose rivalries he utilized. After the campaign of 1832 and 1833 Ibrahim remained as governor in Syria. He might perhaps have administered successfully, but the exactions he was compelled to enforce by his father soon ruined the popularity of his government and provoked revolts. In 1838 the Porte felt strong enough to renew the struggle, and war broke out once more. Ibrahim won his last victory for his father at Nezb on the 24th of June 1839. But Great Britain and Austria intervened to preserve the integrity of Turkey.

Their squadrons cut his communications by sea with Egypt, a general revolt isolated him in Syria, and he was finally compelled to evacuate the country in February 1841. Ibrahim spent the rest of his life in peace, but his health was ruined. In 1846 he paid a visit to western Europe, where he was received with some respect and a great deal of curiosity. When his father became imbecile in 1848 he held the regency till his own death on the 10th of November 1848.

See Edouard Gouin, *L'Égypte au XIX<sup>e</sup> siècle* (Paris, 1847); Aimé Vingtrinier, *Soliman-Pasha (Colonel Séve)* (Paris, 1886). A great deal of unpublished material of the highest interest with regard to Ibrahim's personality and his system in Syria is preserved in the British Foreign Office archives; for references to these see *Cambridge Mod. Hist.* x. 852, bibliography to chap. xvii.

**IBSEN, HENRIK** (1828-1906), Norwegian dramatic and lyric poet, eldest son of Knud Henriksen Ibsen, a merchant, and of his wife Marichen Cornelia Altenburg, was born at Skien on the 20th of March 1828. For five generations the family had consisted on the father's side of a blending of the Danish, German and Scottish races, with no intermixture of pure Norwegian. In 1836 Knud Ibsen became insolvent, and the family withdrew, in great poverty, to a cottage in the outskirts of the town. After brief schooling at Skien, Ibsen was, towards the close of 1843, apprenticed to an apothecary in Grimstad; here he remained through seven dreary years of drudgery, which set their mark upon his spirit. In 1847, in his nineteenth year, he began to write poetry. He made a gloomy and almost sinister impression upon persons who met him at this time, and one of his associates of those days has recorded that Ibsen "walked about Grimstad like a mystery sealed with seven seals." He had continued, by assiduous reading, his self-education, and in 1850 he contrived to come up as a student to Christiania. In the same year he published his first work, the blank-verse tragedy of *Catiline*, under the pseudonym Brynjolf Bjarme. A second drama, *The Viking's Barrow*, was acted (but not printed) a few months later; Ibsen was at this time entirely under the influence of the Danish poet Oehlenschläger. During the next year or two he made a very precarious livelihood in Christiania as a journalist, but in November 1851 he had the good fortune to be appointed "stage-poet" at the little theatre of Bergen, with a small but regular salary. He was practically manager at this house, and he also received a travelling stipend. In 1852, therefore, he went for five months to study the stage, to Copenhagen and to Dresden. Among many dramatic experiments which Ibsen made in Bergen, the most considerable and most satisfactory is the saga-drama of *Mistress Inger at Østtraat*, which was produced in 1855; and printed at Christiania in 1857; here are already perceptible some qualities of his mature character. Much less significant, although at the time more successful, is *The Feast at Solhaug*, a tragedy produced in Bergen in 1856; here for a moment Ibsen abandoned his own nascent manner for an imitation of the popular romantic dramatist of Denmark, Henrik Hertz. It is noticeable that Ibsen, by far the most original of modern writers for the stage, was remarkably slow in discovering the true bent of his genius. His next dramatic work was the romantic tragedy of *Olaf Liljekrans*, performed in 1857, but unprinted until 1898. This was the last play Ibsen wrote in Bergen. In the summer of the former year his five years' appointment came to an end, and he returned to Christiania. Almost immediately he began the composition of a work which showed an extraordinary advance on all that he had written before, the beautiful saga-drama of *The Warriors in Helgeland*, in which he threw off completely the influence of the Danish-romantic tragedians, and took his material directly from the ancient Icelandic sources. This play marks an epoch in the development of Norwegian literature. It was received by the managers, both in Christiania and Copenhagen, with contemptuous disapproval, and in the autumn of 1857 Ibsen could not contrive to produce it even at the new theatre of which he was now the manager. *The Warriors* was printed at Christiania in 1858, but was not acted anywhere until 1861. During these years Ibsen suffered many reverses and humiliations, but he persisted in his own line in art. Some of his finest short poems,

among others the admirable seafaring romance, *Terje Vigen*, belong to the year 1860. The annoyances which Ibsen suffered, and the retrograde and ignorant conditions which he felt around him in Norway, developed the ironic qualities in his genius, and he became an acid satirist. The brilliant rhymed drama, *Love's Comedy*, a masterpiece of lyric wit and incisive vivacity, was published in 1862. This was a protest against the conventionalality which deadens the beauty of all the formal relations between men and women, and against the pettiness, the publicity, and the prosiness of betrothed and married life among the middle classes in Norway; it showed how society murders the poetry of love. For some time past Ibsen had been meditating another saga-drama in prose, and in 1864 this appeared, *Kongsemierne* (The Pretenders). These works, however, now so universally admired, contained an element of strangeness which was not welcome when they were new. Ibsen's position in Christiania grew more and more disagreeable, and he had positive misfortunes which added to his embarrassment. In 1862 his theatre became bankrupt, and he was glad to accept the poorly-paid post of "aesthetic adviser" at the other house. An attempt to obtain a poet's pension (*digtergæge*) was unsuccessful; the Storching, which had just voted one to Björnson, refused to do the same for Ibsen. His cup was full of disillusion and bitterness, and in April 1864 he started, by Berlin and Trieste, ultimately to settle in Rome. His anger and scorn gave point to the satirical arrows which he shot back to his thankless fatherland from Italy in the splendid poem of *Brand*, published in Copenhagen in 1866, a fierce attack on the Laodicean state of religious and moral sentiment in the Norway of that day; the central figure, the stern priest Brand, who attempts to live like Christ and is snubbed and hounded away by his latitudinarian companions, is one of the finest conceptions of a modern poet. Ibsen had scarcely closed *Brand* before he started a third lyric-dramatic satire, *Peer Gynt* (1867), which remains, in a technical sense, the most highly finished of all his metrical works. In *Brand* the hero had denounced certain weaknesses which Ibsen saw in the Norwegian character, but these and other faults are personified in the hero of *Peer Gynt*; or rather, in this figure the poet pictured, in a type, the Norwegian nation in all the egotism, vacillation, and lukewarmness which he believed to be characteristic of it. Ibsen, however, acted better than he preached, and he soon forgot his abstraction in the portrait of Peer Gynt as a human individual. In this magnificent work modern Norwegian literature first rises to a level with the finest European poetry of the century. In 1860 Ibsen wrote the earliest of his prose dramas, the political comedy, *The Young Men's League*, in which for the first time he exercised his extraordinary gift for perfectly natural and yet pregnant dialogue. Ibsen was in Egypt, in October 1860, when his comedy was put on the stage in Christiania, amid violent expressions of hostility; on hearing the news, he wrote his brilliant little poem of defiance, called *At Port Said*. By this time, however, he had become a successful author; *Brand* sold largely, and has continued to be the most popular of Ibsen's writings. In 1866, moreover, the Storching had been persuaded to vote him a "poet's pension," and there was now an end of Ibsen's long struggle with poverty. In 1868 he left Rome, and settled in Dresden until 1874, when he returned to Norway. But after a short visit he went back to Germany, and lived first at Dresden, afterwards at Munich, and did not finally settle in Christiania until 1891. His shorter lyrical poems were collected in 1871, and in that year his name and certain of his writings were for the first time mentioned to the English public. At this time he was revising his old works, which were out of print, and which he would not resign again to the reading world until he had subjected them to what in some instances (for example, *Mistress Inger at Östraal*) amounted to practical recomposition. In 1873 he published a double drama, each part of which was of unusual bulk, the whole forming the tragedy of *Emperor and Galilean*; this, Ibsen's latest historical play, has for subject the unsuccessful struggle of Julian the Apostate to hold the world against the rising tide of Christianity. The work is of an experimental kind, and takes its place between the early

poetry and the later prose of the author. Compared with the series of plays which Ibsen had already inaugurated with *The Young Men's League*, *Emperor and Galilean* preserves a colour of idealism and even of mysticism which was for many years to be absent from Ibsen's writings, but to reappear in his old age with *The Master-builder*. There is some foundation for the charge that Ibsen has made his romantic Greek emperor needlessly squalid, and that he has robbed him, at last, too roughly of all that made him a sympathetic exponent of Hellenism. Ibsen was now greatly occupied by the political spectacle of Germany at war first in Denmark, then in France, and he believed that all things were conspiring to start a new epoch of individualism. He was therefore deeply disgusted by the Paris commune, and disappointed by the conservative reaction which succeeded it. This disillusion in political matters had a very direct influence upon Ibsen's literary work. It persuaded him that nothing could be expected in the way of reform from democracies, from large blind masses of men moved capriciously in any direction, but that the sole hope for the future must lie in the study of personality, in the development of individual character. He set himself to diagnose the conditions of society, which he had convinced himself lay sick unto death. Hitherto Ibsen had usually employed rhymed verse for his dramatic compositions, or, in the case of his saga-plays, a studied and artificial prose. Now, in spite of the surprising achievements of his poetry, he determined to abandon versification, and to write only in the language of everyday conversation. In the first drama of this his new period, *The Pillars of Society* (1877), he dealt with the problem of hypocrisy in a small commercial centre of industry, and he drew in the Bernick family a marvellous picture of social egotism in a prosperous seaport town. There was a certain similarity between this piece and *A Doll's House* (1879), although the latter was much the more successful in awakening curiosity. Indeed, no production of Ibsen's has been so widely discussed as this, which is nevertheless not the most coherently conceived of his plays. Here also social hypocrisy, was the object of the playwright's satire, but this time mainly in relation to marriage. In *A Doll's House* Ibsen first developed his views with regard to the individualism of woman. In his previous writings he had depicted woman as a devoted and willing sacrifice to man; here he begins to explain that she has no less a duty to herself, and must keep alive her own conception of honour and of responsibility. The conclusion of *A Doll's House* was violently and continuously discussed through the length and breadth of Europe, and to the situation of Nora Helmer is probably due more than to anything else the long tradition that Ibsen is "immoral." He braved convention still more audaciously in *Ghosts* (1881), perhaps the most powerful of the series of plays in which Ibsen diagnoses the diseases of modern society. It was received in Norway with a tumult of ill-will, and the author was attacked no less venomously than he had been twenty years before. Ibsen was astonished and indignant at the reception given to *Ghosts*, and at the insolent indifference of the majority to all ideas of social reform. He wrote, more as a pamphlet than as a play, what is yet one of the most effective of his comedies, *An Enemy of the People* (1882). Dr Stockmann, the hero of that piece, discovers that the drainage system of the bathing-station on which the little town depends is faulty, and the water impure and dangerous. He supposes that the corporation will be grateful to have these deficiencies pointed out; on the contrary, they hound him out of their midst as an "enemy of the people." In this play occurs Ibsen's famous and typical saying, "a minority may be right—a majority is always wrong." This polemical comedy seemed at first to be somewhat weakened by the personal indignation which runs through it, but it has held the stage. Ibsen's next drama, *The Wild Duck* (1884), was written in singular contrast with the zest and fire which had inspired *An Enemy of the People*. Here he is squalid and pessimistic to a degree elsewhere unparalleled in his writings; it is not quite certain that he is not here guilty of a touch of parody of himself. The main figure of the play is an unhealthy, unlucky enthusiast, who goes

about making hopeless mischief by exposing weak places in the sordid subterfuges of others. This drama contains a figure, Hjalmar Ekdal, who claims the bad pre-eminence of being the meanest scoundrel in all drama. *The Wild Duck* is the darkest, the least relieved, of Ibsen's studies of social life, and his object in composing it is not obvious. With *Rosmersholm* (1886) he rose to the height of his genius again; this is a mournful, but neither a pessimistic nor a cynical play. The fates which hang round the contrasted lives of Rosmer and Rebecca, the weak-willed scrupulous man and the strong-willed unshrinking woman, the old culture and the new, the sickly conscience and the robust one, create a splendid dramatic antithesis. Ibsen then began to compose a series of dramas, of a more and more symbolical and poetic character; the earliest of these was the mystical *The Lady from the Sea* (1888). At Christmas 1890 he brought out *Hedda Gabler*; two years later *The Master-builder* (*Bygmester Solnaes*), in which many critics see the highest attainment of his genius; at the close of 1894 *Little Eyolf*; in 1896 *John Gabriel Borkman*; and in 1900 *When We Dead Awaken*. On the occasion of his seventieth birthday (1898) Ibsen was the recipient of the highest honours from his own country and of congratulations and gifts from all parts of the world. A colossal bronze statue of him was erected outside the new National Theatre, Christiania, in September 1899. In 1901 his health began to decline, and he was ordered by the physician to abandon every species of mental effort. The evil advanced, and he became unconscious of the passage of events. After lingering in this sad condition he died, without suffering, on the 23rd of May 1906, and was accorded a public funeral, with the highest national honours.

No recent writer belonging to the smaller countries of Europe has had so widely spread a fame as that of Ibsen, and although the value of his dramatic work is still contested, it has received the compliment of vivacious discussion in every part of the world. There would, perhaps, have been less violence in this discussion if it had been perceived that the author does not pose as a moral teacher, but as an imaginative investigator. He often and with much heat insisted that he was not called upon as a poet to suggest a remedy for the diseases of society, but to diagnose them. In this he was diametrically opposed to Tolstoy, who admitted that he wrote his books for the healing of the nations. If the subjects which Ibsen treats, or some of them, are open to controversy, we are at least on firm ground in doing homage to the splendour of his art as a playwright. He reintroduced into modern dramatic literature something of the velocity and inevitability of Greek tragic intrigue. It is very rarely that any technical fault can be found with the architecture of his plots, and his dialogue is the most lifelike that the modern stage has seen. His long apprenticeship to the theatre was of immense service to him in this respect. In every country, though least perhaps in England, the influence of Ibsen has been marked in the theatrical productions of the younger school. Even in England, on the rare occasions when his dramas are acted, they awaken great interest among intelligent playgoers.

The editions of Ibsen's works are numerous, but the final text is included in the *Samlede Værker*, with a bibliography by J. B. Halvorsen, published in Copenhagen, in 10 vols. (1898-1902). They have been translated into the principal European languages, and into Japanese. The study of Ibsen in English was begun by Mr Gosse in 1872, and continued by Mr William Archer, whose version of Ibsen's prose dramas appeared in 5 vols. (1890, 1891; new and revised edition, 1906). Other translators have been Mr C. Herford, Mr R. A. Stratfield, Miss Frances Lord and Mr Adie. His *Correspondence* was edited, in 2 vols., under the supervision of his son, Sigurd Ibsen, in 1904 (Eng. trans., 1905). Critical studies on the writings and position of Ibsen are innumerable, and only those which were influential in guiding opinion, during the early part of his career, in the various countries, can be mentioned here: Georg Brandes *Æsthetiske Studier* (Copenhagen, 1868); Les Quésnel, *Poésie scandinave* (Paris 1874); Valfrid Valsenius, *Henrik Ibsen* (Helsingfors, 1879); Edmund Gosse, *Studies in Northern Literature* (London, 1879); L. Passarge, *Henrik Ibsen* (Leipzig, 1883); G. Brandes, *Bjornsen och Ibsen* (Stockholm, 1882); Henrik Jaeger, *Henrik Ibsen 1828-1888* (Copenhagen, 1888; Eng. trans., 1890); T. Terwey, *Henrik Ibsen* (Amsterdam, 1882); G. Bernard Shaw, *The Quininess of Ibsen* (London, 1892). In France Count Moritz

Prozor carried on an ardent propaganda in favour of Ibsen from 1885, and Jules Lemaitre's articles in his *Les Contemporains* and *Impressions de théâtre* did much to encourage discussion. W. Archer forwarded the cause in England from 1878 onwards. In Germany Ibsen began to be known in 1866, when John Grieg, P. F. Siebold and Adolf Strodttmann successively drew attention to his early dramas; but his real popularity among the Germans dates from 1880. (E. G.)

**IBYCUS**, of Rhegium in Italy, Greek lyric poet, contemporary of Anacreon, flourished in the 6th century B.C. Notwithstanding his good position at home, he lived a wandering life, and spent a considerable time at the court of Polycrates, tyrant of Samos. The story of his death is thus related: While in the neighbourhood of Corinth, the poet was mortally wounded by robbers. As he lay dying he saw a flock of cranes flying overhead, and called upon them to avenge his death. The murderers took themselves to Corinth, and soon after, while sitting in the theatre, saw the cranes hovering above. One of them, either in alarm or jest, ejaculated, "Behold the avengers of Ibycus," and thus gave the clue to the detection of the crime (Plutarch, *De Garrulitate*, xiv.). The phrase, "the cranes of Ibycus," passed into a proverb among the Greeks for the discovery of crime through divine intervention. According to Suidas, Ibycus wrote seven books of lyrics, to some extent mythical and heroic, but mainly erotic (Cicero, *Tusc. Disp. iv.* 33), celebrating the charms of beautiful youths and girls. F. G. Welcker suggests that they were sung by choruses of boys at the "beauty competitions" held at Lesbos. Although the metre and dialect are Dorian, the poems breathe the spirit of Aeolian melody.

The best editions of the fragments are by F. W. Schneidewin (1833) and Bergk, *Poetae Lyrici Graeci*.

**ICA** (Yca, or Ecca), a city of southern Peru and the capital of a department of the same name, 170 m. S.S.E. of Lima, and 46 m. by rail S.E. of Pisco; its port on the Pacific coast. Pop. (1906, official estimate) 6000. It lies in a valley of the foothills of the Cordillera Occidental, which is watered by the Rio de Ica, is made highly fertile by irrigation, and is filled with vineyards and cotton fields; between this valley and the coast is a desert. The original town was founded in 1563, 4 m. E. of its present site, but it was destroyed by the earthquake of 1571, and again by that of 1664, after which the present town was laid out near the ruins. In 1882 a Chilean marauding expedition inflicted great damage to private property in the town and vicinity. These repeated disasters give the place a partially ruined appearance, but it has considerable commercial and industrial prosperity. It has a large cotton factory and there are some smaller industries. Wine-making is one of the principal industries of the valley, and much brandy, called *pisco*, is exported from Pisco. A new industry is that of drying the fruits for which this region is celebrated. Ica is the seat of a national college.

The department of Ica lies between the Western Cordillera and the Pacific coast, and extends from the department of Lima S.E. to that of Arequipa. Pop. (1906, official estimate) 68,220; area 8721 sq. m. Ica is in the rainless region of Peru, and the greater part of its surface is barren. It is crossed by the rivers Pisco, Ica and Grande, whose tributaries drain the western slope of the Cordillera, and whose valleys are fertile and highly cultivated. The valley of the Nasca, a tributary of the Grande, is celebrated for an extensive irrigating system constructed by the natives before the discovery of America. The principal products of the department are cotton, grapes, wine, spirits, sugar and fruit. These are two good ports on the northern coast, Tambo de Mora and Pisco, the latter being connected with the capital by a railway across the desert, 46 m. long.

**ICE** (a word common to Teutonic languages; cf. Ger. *Eis*), the solid crystalline form which water assumes when exposed to a sufficiently low temperature. It is a colourless crystalline substance, assuming forms belonging to the hexagonal system, and distinguished by a well-marked habit of twinning, which occasions the beautiful "ice flowers" displayed by hoar-frost. It is frequently precipitated as hoar-frost, snow or hail; and in the glaciers and snows of lofty mountain systems or of regions

of high latitude it exists on a gigantic scale, being especially characteristic of the seas and lands around the poles. In various regions, especially in France and Italy, great quantities of ice form in caves, which, in virtue of their depth below the earth's surface, their height above the sea-level, or their exposure to suitable winds, or to two or more of these conditions in combination, are unaffected by ordinary climatic changes, so that the mean annual temperature is sufficiently low to ensure the permanency of the ice. The temperature at which water freezes, and also at which ice melts, is so readily determined that it is employed as one of the standard temperatures in the graduation of ordinary thermometer scales, this temperature being the zero of the Centigrade and Réaumur scales, and 32° of the Fahrenheit (see THERMOMETRY). In the act of freezing, water, though its temperature remains unchanged, undergoes a remarkable expansion so that ice at 0° C. is less dense than water—a fact demonstrated by its power of floating. The sub-aqueous retention of "ground-ice" or "anchor-ice," which forms in certain circumstances at the bottom of streams or pools in which there are many eddies, is due to the cohesion between it and the stones or rocks which compose the bed of the streams or pools. As water expands on freezing, so conversely ice contracts on melting; and the ice-cold water thus formed continues to contract when heated until it has reached its point of maximum density, the temperature at which this occurs being about 39° Fahr. or 4° C. Above this point water continuously expands, and at no temperature is it less dense than ice as is shown by the following table:—

Density of ice at	0° C. =	.9175
" water at	0° C. =	.99988
" "	4° C. =	1.00000
" "	16° C. =	.99976
" "	100° C. =	.95866

Under the influence of heat, ice itself behaves as most solids do, contracting when cooled, expanding when heated. According to Plücker, the coefficient of cubical dilatation at moderately low temperatures is 0.000185. From a series of elaborate experiments, Person deduced 0.505 as the specific heat of ice, or about half that of water.

Though no rise of temperature accompanies the melting of ice, there is yet a definite quantity of heat absorbed, namely, about 80 calories per gram; this is called the latent heat of fusion of water (see FUSION). The same amount of heat is evolved when water becomes ice. That ice can be melted by increase of pressure was first pointed out by James Thomson in 1849. He showed that, since water expands on freezing, the laws of thermodynamics require that its freezing-point must be lowered by increase of pressure; and he calculated that for every additional atmosphere of pressure the freezing-point of water was lowered by 0.0075°. This result was verified by his brother, Sir William Thomson (Lord Kelvin), in 1850. The Thomsons and H. L. F. Helmholtz successfully applied this behaviour of ice under pressure to the explanation of many properties of the substance. When two blocks of ice at 0° C. are pressed together or even simply laid in contact, they gradually unite along their touching surfaces till they form one block. This "regelation" is due to the increased pressure at the various points of contact causing the ice there to melt and cool. The water so formed tends to escape, thus relieving the pressure for an instant, refreezing and returning to the original temperature. This succession of melting and freezing, with their accompanying thermal effects, goes on until the two blocks are cemented into one.

Ice forms over fresh water if the temperature of the air has been for a sufficient time at or below the freezing-point; but not until the whole mass of water has been cooled down to its point of maximum density, so that the subsequent cooling of the surface can give rise to no convection currents, is freezing possible. Sea-water, in the most favourable circumstances, does not freeze till its temperature is reduced to about -2° C.; and the ice, when formed, is found to have rejected four-fifths of the salt which was originally present. In the upper provinces

of India water is made to freeze during cold clear nights by leaving it overnight in porous vessels, or in bottles which are wrapped in moistened cloth. The water then freezes in virtue of the cold produced by its own evaporation or by the drying of the moistened wrapper. In Bengal the natives resort to a still more elaborate forcing of the conditions. Pits are dug about 2 ft. deep and filled three-quarters full with dry straw, on which are set flat porous pans containing the water to be frozen. Exposed overnight to a cool dry gentle wind from the north-west, the water evaporates at the expense of its own heat, and the consequent cooling takes place with sufficient rapidity to overbalance the slow influx of heat from above through the cooled dense air or from below through the badly conducting straw.

See WATER, and for the manufacture of ice see REFRIGERATING.

**ICEBERG** (from ice and *Berg*, Ger. for hill, mountain), a floating mass of ice broken from the end of a glacier or from an ice-sheet. The word is sometimes, but rarely, applied to the arch of an Arctic glacier viewed from the sea. It is more commonly used to describe huge floating masses of ice that drift from polar regions into navigable waters. They are occasionally encountered far beyond the polar regions, rising into beautiful forms with breakers roaring into their caves and streams of water pouring from their pinnacles in the warmer air. When, however, they rest in comparatively warm water, melting takes place most rapidly at the base and they frequently overturn. Only one-ninth of the mass of ice is seen above water. When a glacier descends to the sea, as in Alaska, and "advances into water, the depth of which approaches its thickness, the ends are broken off and the detached masses float away as icebergs. Many of the bergs are overturned, or at least tilted, as they set sail. If this does not happen at once it is likely to occur later as the result of the wave-cutting and melting which disturb their equilibrium" (T. C. Chamberlain and R. D. Salisbury, *Geology: Processes and their Results*, 1905). These bergs carry a load of debris from the glacier and gradually strewn their load upon the sea floor. They do not travel far before losing all stony and earthy debris, but glacial material found in dredgings shows that icebergs occasionally carry their load far from land. The structure of the iceberg varies with its origin and is always that of the glacier or ice-sheet from which it was broken. The breaking off of the ice-sheet from a Greenland glacier is called locally the "calving" of the glacier. The constantly renewed material from which the icebergs are formed is brought down by the motion of the glacier. The ice-sheet cracks at the end, and masses break off, owing to the upward pressure of the water upon the lighter ice which is pushed into it. This is accomplished with considerable violence. The disintegration of an Arctic ice-sheet is a simpler matter, as the ice is already floating.

**ICELAND** (Dan. *Island*), an island in the North Atlantic Ocean, belonging to Denmark. Its extreme northerly point is touched by the Arctic Circle; it lies between 13° 22' and 24° 35' W., and between 63° 12' and 66° 33' N., and has an area of 40,437 sq. m. Its length is 298 m. and its breadth 194 m., the shape being a rough oval, broken at the north-west, where a peninsula, diversified by a great number of fjords, projects from the main portion of the island. The total length of the coast-line is about 3730 m., of which approximately one-third belongs to the north-western peninsula. Iceland is a plateau or tableland, built up of volcanic rocks of older and younger formation, and pierced on all sides by fjords and valleys. Compared with the tableland, the lowlands have a relatively small area, namely, one-fourteenth of the whole; but these lowlands are almost the only parts of the island which are inhabited. In consequence of the rigour of its climate, the central tableland is absolutely uninhabitable. At the outside, not more than one-fourth of the area of Iceland is inhabited; the rest consists of elevated deserts, lava streams and glaciers. The north-west peninsula is separated from the main mass of the island by the bays Hunaflói and Breiðfjörð, so that there are really two tablelands, a larger and a smaller. The isthmus which connects the two is only 4½ m. across, but has an altitude of 748 ft. The

mean elevation of the north-west peninsula is 2000 ft. The fjords and glens which cut into it are shut in by precipitous walls of basalt, which plainly shows that they have been formed by erosion through the mass of the plateau. The surface of this tableland is also bare and desolate, being covered with gravel and fragments of rock. Here and there are large straggling snowfields, the largest being Glámu and Drangajökull,<sup>1</sup> on the culminating points of the plateau. The only inhabited districts are the shores of the fjords, where grass grows capable of supporting sheep; but a large proportion of the population gain their livelihood by fishing. The other and larger tableland, which constitutes the substantial part of Iceland, reaches its culminating point in the south-east, in the gigantic snowfield of Vatnajökull, which covers 3300 sq. m. The axis of highest elevation of Iceland stretches from north-west to south-east, from the head of Hvammsfjörur to Hornafjörur, and from this water-parting the rivers descend on both sides. The crest of the water-parting is crowned by a chain of snow-capped mountains, separated by broad patches of lower ground. They are really a chain of minor plateaus which rise 4500 to 6250 ft. above sea-level and 2000 to 3000 ft. above the tableland itself. In the extreme east is Vatnajökull, which is separated from Tungnafellsjökull by Vonarskard (3300 ft.). Between Tungnafellsjökull and Hofsjökull lies the broad depression of Sprengisandr (2130 ft.). Continuing north-west, between Hofsjökull and the next snow-capped mountain, Langjökull, lies Kjölur (2000 ft.); and between Langjökull and Eiríksjökull, Flosaskard (2630 ft.). To the north of the jöklar last mentioned there are a number of lakes, all well stocked with fish. Numerous valleys or glens penetrate into the tableland, especially on the north and east, and between them long mountain spurs, sections of the tableland which have resisted the action of erosion, thrust themselves towards the sea. Of these the most considerable is the mass crowned by Mýrdalsjökull, which stretches towards the south. The interior of the tableland consists for the most part of barren, grassless deserts, the surface being covered by gravel, loose fragments of rock, lava, driftsand, volcanic ashes and glacial detritus.

Save the lower parts of the larger glens, there are no lowlands on the north and east. The south coast is flat next the sea; but immediately underneath Vatnajökull there is a strip of gravel and sand, brought down and deposited by the glacial streams. The largest low-lying plain of Iceland, lying between Mýrdalsjökull and Reykjanes, has an area of about 1550 sq. m. In its lowest parts this plain barely keeps above sea-level, but it rises gradually towards the interior, terminating in a ramification of valleys. Its maximum altitude is attained at 381 ft. near Geysir. On the west of Mount Hekla this plain connects by a regular slope directly with the tableland, to the great injury of its inhabited districts, which are thus exposed to the clouds of pumice dust and driftsand that cover large areas of the interior. Nevertheless the greater part of this lowland plain produces good grass, and is relatively well inhabited. The plain is drained by three rivers—Markarfljót, Thjórsá and Oefusá—all of large volume, and numerous smaller streams. Towards the west there exist a number of warm springs. There is another lowland plain around the head of Faxaflói, nearly 400 sq. m. in extent. As a rule the surface of this second plain is very marshy. Several dales or glens penetrate the central tableland; the eastern part of this lowland is called Borgarfjörur, the western part Mýrar.

The great basins on the west of the island (Faxaflói and Breiðfjörður),<sup>2</sup> as well as the many bays on the north, which are

separated from one another by rocky promontories, appear to owe their origin to subsidences of the surface; whereas the fjords of the north-west peninsula, which make excellent harbours, and those of the east coast seem to be the result chiefly of erosion.

**Glaciers.**—An area of 5170 sq. m. is covered with snowfields and glaciers. This extraordinary development of ice and snow is due to the raw, moist climate, the large rainfall and the low summer temperature. The snow-line varies greatly in different parts of the island, its range being from 1300 to 4250 ft. It is highest on the tableland, on the north side of Vatnajökull, and lowest on the north-west peninsula, to the south of North Cape. Without exception the great névés of Iceland belong to the interior tableland. They consist of slightly rounded domes or billowy snowfields of vast thickness. In external appearance they bear a closer resemblance to the glaciers of the Polar regions than to those of the Alps. The largest snowfields are Vatnajökull (3280 sq. m.), Hofsjökull (520) Langjökull (500) and Mýrdals-

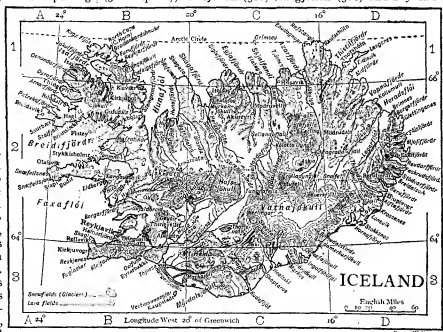

jökull (390). The glaciers which stream off from these snowfields are often of vast extent, e.g. the largest glacier of Vatnajökull has an area of 150 to 200 sq. m., but the greater number are small. Altogether, more than 120 glaciers are known in Iceland. It is on the south side of Vatnajökull that they descend lowest; the lower end of Breidamerkurjökull was in the year 1804 only 30 ft. above sea-level. The glaciers of the north-west peninsula also descend nearly to sea-level. The great number of streams of large volume is due to the moist climate and the abundance of glaciers, and the milky white or yellowish-brown colour of their waters (whence the common name Hvítá, white) is due to the glacial clays. The majority of them change their courses very often, and vary greatly in volume; frequently they are impetuous torrents, forming numerous waterfalls. Iceland also possesses a great number of lakes, the largest being Thingvallavatn<sup>3</sup> and Thorisvatn, each about 27 sq. m. in area. Mývatn, in the north, is well known from the natural beauty of its surroundings. Above its surface tower a great number of volcanoes and several craters, and its waters are alive with water-fowl, a multitude of ducks of various species breeding on its islands. The lakes of Iceland owe their origin to different causes, some being due to glacial erosion, others to volcanic subsidence. Mývatn fills a depression between lava streams, and has a depth of not more than 8½ ft. The group of lakes called Fiskivötn (or Veidivötn), which lie in a desolate region to the west of Vatnajökull, consist for the most part of crater lakes. The groups of lakes which lie north-west from Langjökull occupy basins formed between ridges of glacial gravel; and in

<sup>1</sup> Jökull, plural jöklar, Icel. snowfield, glacier.

<sup>2</sup> Flói, bay; fjörur, fjord.

<sup>3</sup> Vatn, lake.



the valleys numerous lakes are found at the backs of the old moraines.

**Volcanoes.**—Iceland is one of the most volcanic regions of the earth; volcanic activity has gone on continuously from the formation of the island in the Tertiary period down to the present time. So far as is known, there have in historic times been eruptions from twenty-five volcanic vents. Altogether 107 volcanoes are known to exist in Iceland, with thousands of craters, great and small. The lava-streams which have flowed from them since the Glacial epoch now cover an area of 4650 sq. m. They are grouped in dense masses round the volcanoes from which they have flowed, the bulk of the lava dating from outbreaks which occurred in prehistoric times. The largest volume of lava which has issued at one outflow within historic times is the stream which came from the craters of Laki at Skaptá. This belongs to the year 1783, and covers an area of 218 sq. m., and amounts to a volume represented by a cube each of whose sides measures 7½ m. The largest unbroken lava-field in Iceland is Oðaðhraun (Lava of Evil Deeds), upon the tableland north from Vatnajökull (2000 to 4000 ft. above sea-level). It is the accretion of countless eruptions from over twenty volcanoes, and covers an area of 1300 sq.m. (or, including all its ramifications and minor detached streams, 1700 sq. m.), and its volume would fill a cube measuring 13.4 m. in every direction. As regards their superificies, the lava-streams differ greatly. Sometimes they are very uneven and jagged (*apahraun*), consisting of blocks of lava loosely flung together in the utmost confusion. The great lava-fields, however, are composed of vast sheets of lava, ruptured and riven in divers ways (*helluhraun*). The smooth surface of the viscous billow lava is further diversified by long twisted "ropes," curving backwards and forwards up and down the undulations. Moreover, there are gigantic fissures, running for several miles, caused by subsidences of the underlying sections. The best-known fissure of this character is Almannaqjá at Thingvellir. On the occasion of outbreaks the fine ashes are scattered over a large portion of the island, and sometimes carried far across the Atlantic. After the eruption of Katla in 1625 the ashes were blown as far as Bergen in Norway, and when Askja was in eruption in 1875 a rain of ashes fell on the west coast of Norway 11 hours 40 minutes, and at Stockholm 15 hours, afterwards. The volcanic ash frequently proves extremely harmful, destroying the pastures so that the sheep and cattle die of hunger and disease. The outbreak of Laki in 1783 occasioned the loss of 11,500 cattle, 28,000 horses and 190,500 sheep—that is to say, 33% of the cattle in the island, 77% of the horses and 82% of the sheep. After that the island was visited by a famine, which destroyed 9500 people, or one-fifth of the total population.

The Icelandic volcanoes may be divided into three classes: (1) cone-shaped, like Vesuvius, built up of alternate layers of ashes, scoriae and lava; (2) cupola-shaped, with an easy slope and a vast crater opening at the top—these shield-shaped cupolas are composed entirely of layers of lava, and their inclination is seldom steeper than 7°-8°; (3) chains of craters running close alongside a fissure in the ground. For the most part the individual craters are low, generally not exceeding 300 to 500 ft. These crater chains are both very common and often very long. The chain of Laki, which was formed in 1783, extends 20 m., and embraces about one hundred separate craters. Sometimes, however, the lava-streams are vomited straight out of gigantic fissures in the earth without any crater being formed. Many of the Icelandic volcanoes during their periods of quiescence are covered with snow and ice. Then when an outbreak occurs the snow and ice melt, and in that way they sometimes give rise to serious catastrophes (*jökulhlaup*), through large areas being suddenly inundated by great floods of water, which bear masses of ice floating on their surface. Katla caused very serious destruction in this way by converting several cultivated districts into barren wastes. In the same way in the year 1562 Oerfajökull, the loftiest mountain in Iceland (6424 ft.), swept forty farms, together with their inhabitants and live stock, bodily into the ocean. The best-known volcano is Hekla

(5108 ft.), which was in eruption eighteen times within the historic period down to 1845. Katla during the same period was active thirteen times down to 1860. The largest volcano is Askja, situated in the middle of the lava-field of Oðaðhraun. Its crater measures 34 sq. m. in area. At Mývatn there are several volcanoes, which were particularly active in the years 1724-1730. On several occasions there have been volcanic outbreaks under the sea outside the peninsula of Reykjanes, islands appearing and afterwards disappearing again. The crater chain of Laki has only been in eruption once in historic times, namely, the violent and disastrous outbreak of 1783. Iceland, however, possesses no constantly active volcano. There are often long intervals between the successive outbreaks, and many of the volcanoes (and this is especially true of the chains of craters) have only vented themselves in a solitary outbreak.

Earthquakes are frequent, especially in the districts which are peculiarly volcanic. Historical evidence goes to show that they are closely associated with three naturally defined regions: (1) the region between Skjálfaði and Axarfjörð in the north, where violent earth tremblings are extremely common; (2) at Faxaflói, where minor vibrations are frequent; (3) the southern lowlands, between Reykjanes and Mýrdalsjökull, have frequently been devastated by violent earthquake shocks, with great loss of property and life, e.g. on the 14th-16th of August 1784, when 92 farmsteads were totally destroyed, and 372 farmsteads and 11 churches were seriously damaged; and again in August and September 1896, when another terrible earthquake destroyed 161 farmsteads and damaged 155 others. Hot springs are found in every part of Iceland, both singly and in groups; they are particularly numerous in the western portion of the southern lowlands, where amongst others is the famous Geyser (g.g.). Sulphur springs and boiling mud lakes are also general in the volcanic districts; and in places there are carbonic acid springs, these more especially on the peninsula of Snæfellsnes, north of Faxaflói.

**Geology.**—Iceland is built up almost entirely of volcanic rocks, none of them older, however, than the middle of the Tertiary period. The earlier flows were probably contemporaneous with those of Greenland, the Faeroes, the western islands of Scotland and the north-east of Ireland. The principal varieties are basalt and palagonitic breccias, the former covering two-thirds of the entire area, the latter the remaining one-third. Compared with these two systems, all other formations have an insignificant development. The palagonitic breccias, which stretch in an irregular belt across the island, are younger than the basalt. In the north-west, north and east the coasts are formed of basalt, and rise in steep, gloomy walls of rock to altitudes of 3000 ft. and more above sea-level. Deposits of clay, with remains of plants of the Tertiary period, lignite and tree-trunks pressed flat, which the Icelanders call *surtarbrandur*, occur in places in the heart of the basalt formation. These fossiliferous strata are developed in greatest thickness in the north-west peninsula. Indeed, in some few places well-marked impressions of leaves and fruit have been discovered, proving that in Tertiary times Iceland possessed extensive forests, and its annual mean temperature must have been at least 48° Fahr., whereas the present mean is 35.6°. The palagonitic breccias, which attain their greatest development in the south of the island and on the tableland, consist of reddish, brown or yellowish rocks, tufts and breccias, belonging to several different groups or divisions, the youngest of which seems to be of a date subsequent to the Glacial epoch. All over Iceland, in both the basalt and breccia formations, there occur small intrusive beds and dikes of liparite, and as this rock is of a lighter colour than the basalt, it is visible from a distance. In the south-east of the island, in the parish of Lón, there exist a few mountains of gabbro—a rock which does not occur in any other part of Iceland. Near Húsavík in the north there have been found marine deposits containing a number of marine shells; they belong to the Red Rag division of the Pliocene. In the middle of Iceland, where the geological foundation is tuff and breccias, large areas are buried under ancient outflows of lava, which bear evidences of glacial scratching. These lava streams, which are of a doleritic character, flowed before the Glacial age, or during its continuance, out of lava cones with gigantic crater openings, such as may be seen at the present day. During the glacial epoch the whole of Iceland was covered by a vast sheet of inland ice, except for a few small isolated peaks rising along its outer margins. This ice-cap had on the tableland a thickness of 2300 to 2600 ft. Rocks scored by glacial ice and showing plain indications of striation, together with thousands of erratic blocks, are found scattered all over Iceland. Signs of elevation subsequent to the Glacial epoch are common all round the island, especially on the north-west peninsula. There are found strikingly developed marine terraces of gravel, shore lines and

surf beaches marked on the solid rock. In several places there are traces of shells; and sometimes skeletal remains of whales and walrus, as well as ancient driftwood, have been discovered at tolerable distances from the present coast. The ancient shore-lines occur at two different altitudes. Along the higher, 230 to 260 ft. above the existing sea-level, shells have been found which are characteristic of high Arctic latitudes and no longer exist in Iceland; whereas on the lower shore-line, 100 to 130 ft., the shells belong to species which occur amongst the coast fauna of the present day.

The geysers and other hot springs are due to the same causes as the active volcanoes, and the earthquakes are probably manifestations of the same forces. A feature of special interest to geologists in the present conditions of the island is the great power of the wind both as a transporting and denuding agent. The rock sculpture is often very similar to that of a tropical desert.<sup>1</sup>

**Climate.**—Considering its high latitude and situation, Iceland has a relatively mild climate. The meteorological conditions vary greatly, however, in different parts of the island. In the south and east the weather is generally changeable, stormy and moist; whilst on the north the rainfall is less. The climate of the interior tableland approximates to the continental type and is often extremely cold. The mean annual temperature is 37°-2° F. in Stykkishólmur on Breiðfjörðr, 38°-3° at Eyrafjallakki in the south of Iceland. 41° at Vestmannaeyjar, 36° at Akureyri in the north, 36°-9° at Berufjörðr in the east, and 30°-6° at Mödrudalur on the central tableland. The range is great not only from year to year, but also from month to month. For instance, at Stykkishólmur the highest annual mean for March was 39°-7°, and the lowest 8°, during a period of thirty-eight years. Iceland lies contiguous to that part of the north Atlantic in which the shifting areas of low pressure prevail, so that storms are frequent and the barometer is seldom firm. The barometric pressure at sea-level in the south-west of Iceland during the period 1878-1900 varied between 30.8 and 27.1 in. The climate of the coasts is relatively mild in summer, but tolerably cold in winter. The winter means of the north and east coasts average 31°-7° and 31°-3° F. respectively; the summer means, 42°-8° and 44°-6°; and the means of the year, 33°-1° and 35°-6°. The winter means of the south and west coasts average 32° and 31°-7° respectively; the summer means, 48°-2° and 50°; the annual means, 37°-4° and 39°-2°. The rainfall on the south and east coasts is considerable, e.g. at Vestmannaeyjar, 40.4 in. in the year; at Berufjörðr, 43.6 in. On the west coast it is less, e.g. 24.3 in. at Stykkishólmur; but least of all on the north coast, being only 14.6 in. on the island of Grimsey, which lies off that coast. Mist is commonly prevalent on the east coast; at Berufjörðr there is mist on no fewer than 212 days in the year. The south and west coasts are washed by the Gulf Stream, and the north coast by an Arctic current, which frequently brings with it a quantity of drift-ice, and thus exercises a considerable effect upon the climate of the island; sometimes it blocks the north coast in the summer months. On the whole, during the 19th century, the north coast was free from ice on an average of one year in every four or five. The clearness of the atmosphere has been frequently remarked. Thunderstorms occur mostly in winter.

**Flora.**—The vegetation presents the characteristics of an Arctic European type, and is tolerably uniform throughout the island, the differences even on the tableland being slight. At present 435 species of phanerogams and vascular cryptogams are known; the lower orders have been little investigated. The grasses are of the greatest importance to the inhabitants, for upon them they are dependent for the keep of their live stock. Heather covers large tracts, and also affords pasture for sheep. The development of forest trees is insignificant. Birch woods exist in a good many places, especially in the warmer valleys; but the trees are very short, scarcely attaining more than 3 to 10 ft. in height. In a few places, however, they reach 13 to 20 ft. and occasionally more. A few mountain ash or rowan trees (*Sorbus aucuparia*) are found singly here and there, and attain to 30 ft. in height. Willows are also pretty general, the highest in growth being *Salix phylicifolia*, 7 to 10 ft. The wild flora of Iceland is small and delicate, with bright blue and white heads being especially admired. Wild crowsberries and bilberries are the only fruit found in the island.

**Fauna.**—The Icelandic fauna is of a sub-Arctic type. But while the species are few, the individuals are often numerous. The land

mammals are very poorly represented; and it is doubtful whether any species is indigenous. The polar bear is an occasional visitant, being brought to the coast by the Greenland drift-ice. Foxes are common, both the white and the blue occurring; mice and the brown rat have been introduced, though one variety of mouse is possibly indigenous. Reindeer were introduced in 1770. The marine mammalia are numerous. The walrus is now seldom seen, although in prehistoric times it was common. There are numerous species of seals; and the seas abound in whales. Of birds there are over 100 species, more than one-half being aquatic. In the interior the whistling swan is common, and numerous varieties of ducks are found in the lakes. The eider duck, which breeds on the islands of Breiðfjörðr, is a source of livelihood to the inhabitants, as are also the many kinds of sea-fowl which breed on the sea-cliffs. Iceland possesses neither reptiles nor batrachians. The fish fauna is abundant in individuals, some sixty-eight species being found off the coasts. The cod fisheries are amongst the most important in the world. Large quantities of herring, plaice and halibut are also taken. Many of the rivers abound in salmon, and trout are plentiful in the lakes and streams.

**Population and Towns.**—The census of 1890 gave a total population of 70,927, and this number had increased by 1901 to 78,480. The increase during the 19th century was 27,000, while at least 15,600 Icelanders emigrated to America, chiefly to Manitoba, from 1872 to the close of the century. The largest town is Reykjavik on Faxaflói, with 6700 inhabitants, the capital of the island, and the place of residence of the governor-general and the bishop. Here the Althing meets; and here, further, are the principal public institutions of the island (library, schools, &c.). The town possesses a statue to Thorvaldsen, the famous sculptor, who was of Icelandic descent. The remaining towns include Isafjörðr (pop. 1000) on the north-west peninsula, Akureyri (1000) on the north and Seydisfjörðr (800) in the east.

**Industries.**—The principal occupation of the Icelanders is cattle-breeding, and more particularly sheep-breeding, although the fishing industries have come rapidly to the front in modern times. In 1850, 82% of the population were dependent upon cattle-breeding and 7% upon fishing; in 1890 the numbers were 64% and 18% respectively. The culture of grain is not practised in Iceland; all bread-stuffs are imported. In ancient times barley was grown in some places, but it never paid for the cost of cultivation. Cattle-breeding has declined in importance, while the number of sheep has increased. Formerly gardening was of no importance, but considerable progress has been made in this branch in modern times, as also in the cultivation of potatoes and turnips. Fruit-trees will not thrive; but black and red currants and rhubarb are grown, the last-named doing excellently. Iceland possesses four agricultural schools, one agricultural society, and small agricultural associations in nearly every district. The fisheries give employment to about 12,000 people. For the most part the fishing is carried on from open boats, notwithstanding the dangers of so stormy a coast. But larger decked vessels have come into increasing use. In summer the waters are visited by a great number of foreign fishermen, inclusive of about 300 fishing-boats from French ports, as well as by fishing-boats from the Faeroes and Norway, and steam trawlers from England. Excellent profit is made in certain parts of the island from the herring fishery; this is especially the case on the east coast. There are marine insurance societies and a school of navigation at Reykjavik. The export of fish and fish products has greatly increased. In 1849 to 1855 the annual average exported was 1480 tons; whereas at the close of the century (in 1890) it amounted to 11,339 tons and 68,079 barrels of oil, valued at £276,596.

**Commerce.**—From the first colonization of the island down to the 14th century the trade was in the hands of native Icelanders and Norsemen; in the 15th century it was chiefly in the hands of the English, in the 16th of Germans from the Hansa towns. From 1602 to 1786 commerce was a monopoly of the Danish government; in the latter year it was declared free to all Danish subjects and in 1854 free to all nations. Since 1874, when Iceland obtained her own administration, commerce has increased considerably. Thus the total value of the imports and exports together in 1840 did not exceed £170,000; while in 1891-1895 the imports averaged £35,600 and the exports £340,000. In

<sup>1</sup> See Th. Thoroddsen, "Explorations in Iceland during the years 1881-1898," *Geographical Journal*, vol. xiii. (1899), pp. 251-274, 480-513, with map.

1902 imports were valued at £596,103 and exports at £511,083. Trade is almost entirely with Denmark, the United Kingdom, and Norway and Sweden, in this order according to value. The principal native products exported are live sheep, horses, salt meat, wool and hides, to which must be added the fish products—cod, train-oil, herring and salmon—eiderdown and woollen wares. The spinning, weaving and knitting of wool is a widespread industry, and the native tweed (*óðmal*) is the principal material for the clothing of the inhabitants. The imports consist principally of cereals and flour, coffee, sugar, ale, wines and spirits, tobacco, manufactured wares, iron and metal wares, timber, salt, coal, &c. The money, weights and measures in use are the same as in Denmark. The Islands Bank in Reykjavík (1904) is authorized to issue bank-notes up to £133,900 in total value.

**Communications.**—All land journeys are made on horseback, and in the remoter parts all goods have to be transported by the same means. Throughout the greater part of the island there exist no proper roads even in the inhabited districts, but only bridle-paths, and in the uninhabited districts not even these. Nevertheless much has been done to improve such paths as there are, and several miles of driving roads have been made, more particularly in the south. Since 1888 many bridges have been built; previous to that year there was none. The larger rivers have been spanned by iron swing-bridges, and the Blanda is crossed by a fixed iron bridge. Postal connexion is maintained with Denmark by steamers, which sail from Copenhagen and call at Leith. Besides, steamers go round the island, touching at nearly every port.

**Religion.**—The Icelanders are Lutherans. For ecclesiastical purposes the island is divided into 20 deaneries and 142 parishes, and the affairs of each ecclesiastical parish are administered by a parish council, and in each deanery by a district (*hjeradó*) council. When a living falls vacant, the governor-general of the island, after consultation with the bishop, selects three candidates, and from these the congregation chooses one, the election being subsequently confirmed by the governor-general. In the case of certain livings, however, the election requires confirmation by the crown. In 1847 a theological seminary was founded at Reykjavík, and there the majority of the Icelandic ministry are educated; some, however, are graduates of the university of Copenhagen.

**Health.**—The public health has greatly improved in modern times; the death-rate of young children has especially diminished. This improvement is due to greater cleanliness, better dwellings, better nourishment, and the increase in the number of doctors. There are now doctors in all parts of the country, whereas formerly there were hardly any in the island. There is a modern asylum for leprosy at Laugarnes near Reykjavík, and a medical school at Reykjavík, opened in 1876. The general sanitary affairs of the island are under the control of a chief surgeon (national physician) who lives in Reykjavík, and has superintendence over the doctors and the medical school.

**Government.**—According to the constitution granted to Iceland in 1874, the king of Denmark shares the legislative power with the Althing, an assembly of 36 members, 30 of whom are elected by household suffrage, and 6 nominated by the king. The Althing meets every second year, and sits in two divisions, the upper and the lower. The upper division consists of the 6 members nominated by the king and 6 elected by the representatives of the people out of their own body. The lower division consists of the remaining 24 representative members. The minister for Iceland, who resided in Copenhagen until 1903, when his office was transferred to Reykjavík, is responsible to the king and the Althing for the maintenance of the constitution, and he submits to the king for confirmation the legislative measures proposed by the Althing. The king appoints a governor-general (*landskjöfvingi*) who is resident in the island and carries on the government on the responsibility of the minister. Formerly Iceland was divided into four quarters, the east, the south, the west and north. Now the north and the east are united under one governor, and the south and the west under

another. The island is further divided into 18 *sýslur* (counties), and these again into 169 *hreppur* (rapes) or poor-law districts. Responsible to the governors are the sheriffs (*sýslumenn*), who act as tax gatherers, notaries public and judges of first instance; the sheriff has in every *hreppur* an assistant, called *hreppstjóri*. In every *hreppur* there is also a representative committee, who administer the poor laws, and look after the general concerns of the *hreppur*. These committees are controlled by the committees of the *sýslur* (county boards), and these again are under the control of the *amtiráð* (quarter board), consisting of three members. From the sheriff courts appeals lie to the superior court at Reykjavík, consisting of three judges. Appeals may be taken in all criminal cases and most civil cases to the supreme court at Copenhagen.

Iceland has her own budget, the Althing having, by the constitution of 1874, the right to vote its own supplies. As the Althing only meets every other year, the budget is passed for two years at once. The total income and expenditure are each about £70,000 per financial period. There is a national reserve fund of about £60,000, but no public debt; nor is there any contribution for either military or naval purposes. Iceland has her own customs service, but the only import duties levied are upon spirits, tobacco, coffee and sugar, and in each case the duties are fairly low.

**Education.**—Education is pretty widespread amongst the people. In the towns and fishing villages there are a few elementary schools, but often the children are instructed at home; in some places by peripatetic teachers. It is incumbent upon the clergy to see that all children are taught reading, writing and arithmetic. The people are great readers; considering the number of the inhabitants, books and periodicals have a very extensive circulation. Eighteen newspapers are issued (once and twice a week), besides several journals, and Iceland has always been distinguished for her native literature. At Reykjavík there are a Latin school, a medical school and a theological school; at Mödruvellir and Hafnarfjörður, modern high schools (*Realskolen*); and in addition to these there are four agricultural schools, a school of navigation, and three girls' schools. The national library at Reykjavík contains some 40,000 volumes and 3000 MSS. At the same place there is also a valuable archaeological collection. Amongst the learned societies are the Icelandic Literary Society (*Bókmenntafélag*), the society of the Friends of the People, and the Archaeological Society of Reykjavík.

**AUTHORITIES.**—Among numerous works of Dr Thorvald Thoroddsen, see *Geschichte der Islands Geographie* (Leipzig, 1898); and the following articles in *Geografisk Tidsskrift* (Copenhagen): "Om Islands geografiske og geologiske Underøgsølse" (1893); "Islandske Fjorde og Bugter" (1901); "Geog. og geol. Undersøvel ved den sydlige Del af Faxaflói paa Island" (1903); "Lavårkener og Vulkaner paa Islands Hóland" (1905). See also C. S. Forbes, *Iceland* (London, 1860); S. Baring-Gould, *Iceland, its Scenes and Sagas* (London, 1863); Sir R. F. Burton, *Ultima Thule* (Edinburgh, 1875); W. T. McCormick, *A Ride across Iceland* (London, 1892); J. Coles, *Summer Travelling in Iceland* (London, 1882); H. J. Johnston Lavis, "Notes on the Geography, Geology, Agriculture and Economics of Iceland," *Scott. Geog. Mag.* xi. (1895); W. Bisiker, *Across Iceland* (London, 1902); J. Hann, "Die Anomalien der Witterung auf Island in dem Zeitraume 1851-1900, &c.," *Sitzungsberichte, Vienna Acad. Sci.* (1904); P. Hermann, *Island in Vergangenheit und Gegenwart* (Leipzig, 1907). Also *Geografisk Tidsskrift*, and the *Geographical Journal* (London), *passim*. (TH. T.)

#### HISTORY

Shortly after the discovery of Iceland by the Scandinavian, c. 850 (it had long been inhabited by a small colony of Irish Cuidees), a stream of immigration set in towards it, which lasted for sixty years, and resulted in the establishment of some 4000 homesteads. In this immigration three distinct streams can be traced. (1) About 870-890 four great noblemen from Norway, Ingolf, Ketil Hang, Skalla-Grim and Thorolf, settled with their dependants in the south-west of the new found land. (2) In 890-900 there came from the western Islands Queen Aud, widow of Olaf the White, king of Dublin, preceded and followed by a number of her kinsmen and relations (many like herself being

## Table of Icelandic Literature and History.

Heroic Age	870-930 930-980 980-1030	Poetry of Western Islands. Early Icelandic poets, chiefly abroad. Icelandic poems abroad.	I. <i>The Commonwealth.</i> 400 years. Settlement by colonists from Western Isles and Norway. Constitution worked out—Events of earliest sagas take place. Christianity comes in—Events of later sagas take place. Peace—Ecclesiastical organization.
Saga Telling	1030-1100	<i>First era of phonetic change.</i>	
The Literary Age	1100-1150 1150-1210 1210-1248 1248-1284	ARI and his school—THORODD—Vernacular writing begins. SAGA-WATNESS—Second generation of historians. SNORRI and his school—Biographers. STUBLA—Second era of phonetic change.	First civil wars—1208-22—Rise of Sturlungs. Second civil wars, 1226-48—Fall of Great Houses. Change of law, 1271—Submission to Norwegian kings.
Continental Influence chiefly Norse.	1284-1320 1300-1413	Collecting and editing—Foreign romances. Annals—Copeys—New Medieval poetry begins. Death of old traditions, &c.	II. <i>Medievalism.</i> 250 years. Foreign influence through Norway. Great eruptions, 1250 and 1380—Epidemics—Danish rule, 1380. Epidemics—Norse trade—Close of intercourse with Norway. Isolation from Continent—English trade.
Dark Age	1413-1530	Only Medieval poetry flourishes.	III. <i>Reformation—Absolute Rule—Decay.</i> 300 years. Religious struggle—New organization—Hanse trade. Danish monopoly—Pirates' ravages.
Reformation	1530-1575	ODD—Printing— <i>Third era of phonetic change.</i> First annals.	
Renaissance	1575-1640 1640-1700	HALDOR—Paper copies taken. JON VIDALIN—Arni Magnússon—MSS. taken abroad. Egbert Olafsson.	Smallpox kills one-third population, 1707. Great famine, 10,000 die, 1759—Sheep plague, 1762—Eruption, 1785. Great eruption, 1783. Beginnings of recovery—Travellers make known island to Europe—Free constitution in Denmark, 1848.
Gradual Decay	1700-1750 1750-1768 1768-1800 1800-1850	Finn Jonsson—Icelandic scholars abroad. Rationalistic movement—European influences first felt.	IV. <i>Modern Iceland.</i> Increasing wealth and population—Free trade, 1854—Jon Sigurðsson and some rule struggle. Home rule granted.
Recovery of Iceland	1850-1874 1874	Modern thought and learning—Icelandic scholars abroad.	

Christians, Helgi Biolan, Biorn the Eastern, Helgi the Lean, the Kith the Foolish, &c., who settled the best land in the island (west, north-west and north), and founded families who long swayed its destinies. There also came from the Western Islands, a fellowship of vikings seeking a free home in the north. They had colonized the west in the viking times; they had "fought at Hafursfirth," helping their stay-at-home kinsmen against the centralization of the great head-king, who, when he had crushed opposition in Norway, followed up his victory by compelling them to flee or bow to his rule. Such were Ingimund the Old, Geirmund Hellskin, Thord Beardie (who had wed St. Edmund's granddaughter), Audun Shackle, Bryniulf the Old, Uni, to whom Harold promised the earldom of the new land if he could make the settlers acknowledge him as king (a hopeless project), and others by whom the north-west, north and east were almost completely "claimed." In 900-930 a few more incomers direct from Norway completed the settlement of the south, north-east and south-east. Among them were Earl Hrollaug (half-brother of Hrolf Ganger and of the first earl of Orkney), Hialti, Hrafnkell Frey's priest, and the sons of Asbiorn. Fully three-quarters of the land was settled from the west, and among these immigrants there was no small proportion of Irish blood. In 1100 there were 4500 franklins, i.e. about 50,000 souls.

The unit of Icelandic politics was the homestead with its franklin-owner (*hændi*), its primal organization the hundred-moot (*thing*), its tie the *goðor* (godar) or chieftainship. The chief who had led a band of kinsmen and dependants to the new land, taken a "claim" there, and parcelled it out among them, naturally became their leader, presiding as priest at the temple feasts and sacrifices of heathen times, acting as speaker of their moot, and as their representative towards the neighbouring chiefs. He was not a feudal lord nor a local sheriff, for any franklin could change his *goðor* when he would, and the rights of "judgment by peers" were in full use; moreover, the office could be bequeathed, sold, divided or pledged by the possessor; still the *goði* had considerable power as long as the commonwealth lasted.

Disputes between neighbouring chiefs and their clients, and uncertainty as to the law, brought about the *Constitution of Ulfthof* (c. 930), which appointed a central moot for the whole island, the Althing, and a speaker to speak a single "law" (principally that followed by the Gula-moot in Norway); the *Reforms of Thord Gellir* (964), settling a fixed number of moots and chieftaincies, dividing the island into four quarters (thus characterized by Ari: north, thickest settled, most famous; east, first completely settled; south, best land and greatest chiefs; west, remarkable for noble families), to each of which a head-court, the "quarter-court," was assigned; and the *Innovations of Skapti* (ascribed in the saga to Nial) the Law-

*Speaker* (d. 1030), who set up a "fifth court" as the ultimate tribunal in criminal matters, and strengthened the community against the chiefs. But here constitutional growth ceased: the law-making body made few and unimportant modifications of custom; the courts were too weak for the chiefs who misused and defied them; the speaker's power was not sufficiently supported; even the ecclesiastical innovations, while they secured peace for a time, provoked in the end the struggles which put an end to the commonwealth.

Christianity was introduced c. 1000 from Norway. Thews were established in 1096, and an ecclesiastical code made c. 1125. The first disputes about the jurisdiction of the clergy were moved by Gudmund in the 13th century, bringing on a civil war, while the questions of patronage and rights over glebe and mortmainland occupied Bishop Arni and his adversaries fifty years afterwards, when the land was under Norwegian viceroys and Norwegian law. For the civil wars broke down the great houses who had monopolized the chieftaincies; and after violent struggles (in which the Sturlungs of the first generation perished at Orlygstad, 1238, and Reykiaholt, 1241, while of the second generation Thord Kakali was called away by the king in 1250, and Thorgrils Skardi slain in 1258) the submission of the island to Norway quarter after quarter took place in 1262-1264, under Gizur's auspices, and the old Common Law was replaced by the New Norse Code "Ironside" in 1271.

The political life and law of the old days is abundantly illustrated in the sagas (especially *Eyrybyggja*, *Hensa-Thori*, *Reyk-dæla*, *Hrafnkell and Niala*), and the two collections of law-rolls (*Codex Regius*, c. 1235, and *Stadarhol's Book*, c. 1271), the *Libellus*, the *Liberfragments*, and the *Landnamabok* of Ari, and the *Diplomatarium*. K. Maurer has made the subject his own in his *Beiträge, Island, Grágás*, &c.

The medieval Icelandic church had two bishoprics, Skalholt (S., W. and E.) 1056, and Holar (N.) 1106, and about 175 parishes (two-thirds of which belonged to the southern bishopric). They belonged to the metropolitan see of Bremen, then to Lund, lastly to Nidaros, 1237. There were several religious foundations: Thingore (founded 1133), Thwersa (1155), Hitardale (c. 1166), Kirkby Nunnery (1184), Stad Nunnery (1206) and Sauby (c. 1200) were Benedictine, while Ver (1168), Flatay after Holyfeld (1172), Videy (1226), Madderfeld Priory (1206) and Skrid Priory (14th century) were Augustinian. The bishops, elected by the people at the Althing till 1237, enjoyed considerable power; two, Thorlak of Skalholt and John of Holar, were publicly voted saints at the Althing, and one, Gudmund, received the title of "Good" by decree of the bishop and chapter. Full details as to ecclesiastical history will be found in the *Biskupasögur* (edited by Dr. Vigfusson).

Iceland was not agricultural but pastoral, depending upon flocks and herds for subsistence, for, though rye and other grain

would grow in favoured localities, the hay, self-sown, was the only regular crop. In some districts the fisheries and fowling were of importance, but nine-tenths of the population lived by their sheep and cattle. Life on each homestead was regularly portioned out: out door occupations—fishing, shepherding, fowling, and the hay-making and fuel-gathering—occupying the summer; while indoor business—weaving, tool-making, &c.—filled up the long winter. The year was broken by the spring feasts and moots, the great Althing meeting at midsummer, the marriage and arval gatherings after the summer, and the long yule feasts at midwinter. There were but two degrees of men, free and unfree, though only the franklins had any political power; and, from the nature of the life, social intercourse was unrestrained and unfettered; goði and thrall lived the same lives, ate the same food, spoke the same tongue, and differed little in clothing or habits. The thrall had a house of his own and was rather villain or serf than slave, having rights and a legal price by law. During the heathen days many great chiefs passed part of their lives in Norway at the king's court, but after the establishment of Christianity in Iceland they kept more at home, visiting the continent, however, for purposes of state, suits with clergy, &c. Trade was from the first almost entirely in foreign (Norse) hands.

The introduction of a church system brought little change. The great families put their members into orders, and so continued to enjoy the profits of the land which they had given to the church; the priests married and otherwise behaved like the franklins around them in everyday matters, farming, trading, going to law like laymen.

Life in the commonwealth was turbulent and anarchic, but free and varied; it produced men of mark, and fostered bravery, adventure and progress. But on the union with Norway all this ceased, and there was left but a low dead level of poor peasant proprietors careless of all save how to live by as little labour as possible, and pay as few taxes as they could to their foreign rulers. The island received a foreign governor (*Earl, Hirdstjóri* or *Stjéptamts-madr* as he was successively called), and was parcelled out into counties (*sýslur*), administered by sheriffs (*sýslumadr*) appointed by the king. A royal court took the place of the Althing courts; the local business of the local things was carried out by the (*kreppstjóri*) bailiff, a subordinate of the sheriff; and the goðorð, things, quarter-courts, trial by jury, &c., were swept away by these innovations. The power of the crown was increased by the confiscation of the great Sturlung estates, which were under-leased to farmers, while the early falling off of the Norse trade threatened to deprive the island of the means of existence; for the great epidemics and eruptions of the 14th century had gravely attacked its pastoral wealth and ruined much of its pasture and fishery.

The union of the Three Crowns transferred the practical rule of Iceland to Denmark in 1280, and the old Treaty of Union, by which the island had reserved its essential rights, was disregarded by the absolute Danish monarchs; but, though new taxation was imposed, it was rather their careless neglect than their too active interference that damaged Iceland's interests. But for an English trade, which sprang up out of the half-smuggling, half-buccaneering enterprise of the Bristol merchants, the island would have fared badly, for during the whole of the 15th century their trade with England, exporting sulphur, eiderdown (of which the English taught them the value), wool, and salt stock-fish, and importing as before wood, iron, honey, wine, grain and flax goods, was their only link with the outer world. This period of Iceland's existence is eventless: she had got peace but with few of its blessings; all spirit seemed to have died with the commonwealth; even shepherding and such agriculture as there had been sank to a lower stage; wagons, ploughs and carts went out of use and knowledge; architecture in timber became a lost art, and the fine carved and painted halls of the heathen days were replaced by turf-walled barns half sunk in the earth; the large decked luggers of the old days gave way to small undecked fishing-boats.

The Reformation in Iceland wakened men's minds, but it left their circumstances little changed. Though the fires of martyrdom were never lighted in Iceland, the story of the easily accepted Reformation is not altogether a pleasant one. When it was accomplished, the little knot of able men who came to the front did much in preserving the records of the past, while Odd and Hallgrím exhibit the noblest impulses of their time. While there was this revolution in religion a social and political revolution never came to Iceland. The Hanse trade replaced the English for the worse; and the Danish monopoly which succeeded it when the Danish kings began to act again with vigour was still less profitable. The glebes and hospital lands were a fresh power in the hands of the crown, and the subservient Lutheran clergy became the most powerful class in the island, while the system of under-leasing at rackrent and short lease with unsecured tenant right extended over at least a quarter of the better land.

A new plague, that of the English, Gascon and Algerine pirates, marked the close of the 16th century and opening of the 17th, causing widespread panic and some devastation in 1579, 1613-1616 and 1627. Nothing points more to the helplessness of the natives' condition than their powerlessness against these foes. But the 18th century is the most gloomy in Iceland's annals. Smallpox, famine, sheep disease, and the eruptions of 1765 and 1783 follow each other in terrible succession. Against such visitations, which reduced the population by about a fourth, little could be done. The few literary men, whose work was done and whose books were published abroad, were only concerned with the past, and Jon Vídalín is the one man of mark, beside Eggert Ólafsson, who worked and wrote for his own generation.<sup>1</sup>

Gradually the ideas which were agitating Europe spread through Scandinavia into Iceland, and its claims were more respectfully listened to. The continental system, which, by its leading to the blockade of Denmark, threatened to starve Iceland, was neutralized by special action of the British government. Trade and fishery grew a little brisker, and at length the turn came.

The rationalistic movement, headed by Magnus Stephenson, a patriotic, narrow-minded lawyer, did little good as far as church reform went, but was accompanied by a more successful effort to educate the people. A Useful Knowledge Society was formed and did some honest work. Newspapers and periodicals were published, and the very stir which the ecclesiastical disputes encouraged did good. When free trade came, and when the free constitution of Denmark had produced its legitimate effects, the endeavours of a few patriots such as Jon Sigurdsson were able to push on the next generation a step further. Questions of a modern political complexion arose; the cattle export controversy and the great home rule struggle began. After thirty years' agitation home rule was conceded in 1874 (see above, *Government*). (F. Y. P.)

#### ANCIENT LITERATURE

*Poetry.*—Iceland has always borne a high renown for song, but has never produced a poet of the highest order, the qualities which in other lands were most sought for and admired in poetry being in Iceland lavished on the saga, a prose epic, while Icelandic poetry is to be rated very high for the one quality which its authors have ever aimed at—melody of sound. To these generalizations there are few exceptions, though Icelandic literature includes a group of poems which possess qualities of high imagination, deep pathos, fresh love of nature, passionate dramatic power, and noble simplicity of language which Icelandic poetry lacks. The solution is that these poems do not belong to Iceland at all. They are the poetry of the "Western Islands."

It was among the Scandinavian colonists of the British coasts that in the first generations after the colonization of Iceland

<sup>1</sup>For the periods succeeding the union, Danish state papers and the *History of Finn Jonsson* are the best authority.

therefrom a magnificent school of poetry arose, to which we owe works that for power and beauty can be paralleled in no Teutonic language till centuries after their date. To this school, which is totally distinct from the Icelandic, ran its own course apart and perished before the 13th century, the following works belong (of their authors we have scarcely a name or two; their dates can be rarely exactly fixed, but they lie between the beginning of the 9th and the end of the 10th centuries), classified into groups:—

(a) The *Helgi* trilogy (last third lost save a few verses, but preserved in prose in *Hromund Grípsason's Saga*), the *Raising of Ángantýr* and *Death of Hialmar* (in *Hervarar Saga*), the fragments of a *Völsung Lay* (*Völsungakvíða*) (part interpolated in earlier poems, part underlying the prose in *Völsunga Saga*), all by one poet, to whom Dr Vigfússon would also ascribe *Völuspá*, *Vegtamskviða*, *Þrymskviða*, *Gríttu Song* and *Völundarkviða*.

(b) The Dramatic Poems:—*Flying of Loki*, the *För Skirnir*, the *Harbarðsljóð* and several fragments, all one man's work, to whose school belong, probably, the *Lay* underlying the story of Ivar's death in *Skjöldunga Saga*.

(c) The Didactic Poetry:—*Grimnismál*, *Vafþrúðnismál*, *Áttismál*, &c.

(d) The Genealogical and Mythological Poems:—*Hymndaldröf*, written for one of the Haurda-Kari family, so famous in the Orkneys; *Ynglingatal* and *Haustlong*, by Thiodolf of Hvin; *Ríg's Thal*, &c.

(e) The Dirges and Battle Songs—such as that on Hafur-firþ Battle *Hrafnsmal*, by Thiodolf of Hvin or Thorbjörn Hornklof, shortly after 870; Eirik's Dirge (*Eiríksmál*) between 950 and 969; the *Darl-Lay* on Cloniarf Battle (1014); *Blarka-mal* (fragments of which we have), and paraphrase of more is found in *Hróf Kraki's Saga* and in *Saxo*.

There are also fragments of poems in *Half's Saga*, *Amand Kappa-Bana's Saga*, in the Latin verses of Saxo, and the Shield Lays (*Ragnarsdrápa*) by Bragi, &c., of this school, which closes with the *San-Song*, a powerful Christian Dantesque poem, recalling some of the early compositions of the Irish Church, and with the 12th-century *Lay of Ragnar*, *Lay of Starck*, *The Proverb Song* (*Havamal*) and *Krakumal*, to which we may add those singular Gloss-poems, the *Þulur*, which also belong to the Western Isles.

To Greenland, Iceland's farthest colony, founded in the 10th century, we owe the two *Lays of Aili*, and probably *Hymiskviða*, which, though of a woe, harsher cast, yet belong to the Western Isles school and not to Iceland.

In form all these poems belong to two or three classes:—*kviða*, an epic "cantilena"; *låt*, a genealogical poem; *drápa*, songs of praise, &c., written in modifications of the old Teutonic metre which we know in Beowulf; *gald* and *lokkr*, spell and charm songs in a more lyric measure; and *mál*, a dialogue poem, and *liod*, a lay, in elegiac measure suited to the subject.

The characteristics of this Western school are no doubt the result of the contact of Scandinavian colonists of the viking-tide, living lives of the wildest adventure, with an imaginative and civilized race, that exercised upon them a very strong and lasting influence (the effects of which were also felt in Iceland, but in a different way). The frequent intermarriages which mingled the best families of either race are sufficient proof of the close communion of Northmen and Celts in the 9th and 10th centuries, while there are in the poems themselves traces of Celtic mythology, language and manners.<sup>1</sup>

When one turns to the early poetry of the Scandinavian continent, preserved in the rune-staves on the memorial stones of Sweden, Norway and Denmark, in the didactic *Havamal*, the *Great Völsung Lay* (i.e. Sigurd II., Fafnis's Lay, Sigdrifra's Lay) and *Hymndismál*, all circular, and all entirely consonant to the remains of Old English poetry in metre, feeling and treatment, one can see that it is with this school that the Icelandic "makers" are in sympathy, and that from it their verse naturally descends. While shrewdness, plain straightforwardness, and a certain stern way of looking at life are common to both, the Icelandic school adds a complexity of structure and ornament, an elaborate mythological and enigmatical phraseology, and a regularity of rhyme, assonance, luxuriance, quantity

<sup>1</sup> Many of these poems were English in prose by the translator of Mallet, by B. Thorpe in his *Samnord's Edda*, and two or three by Messrs Morris and Magnusson, as appendices to their translation of *Völsunga Saga*. Earlier translations in verse are those in Dryden's *Miscellany* (vol. vi), A. Cottle's *Edda*, Mathias's *Translations*, and W. Herbert's *Old Icelandic Poetry*. Gray's versions of *Darradar-liod* and *Vegtamskviða* are well known.

and syllabification, which it caught from the Latin and Celtic poets, and adapted with exquisite ingenuity to its own main object, that of securing the greatest possible beauty of sound.

The first generations of Icelandic poets resemble in many ways the later troubadours; the books of the kings and the sagas are full of their strange lives. Men of good birth (nearly always, too, of Celtic blood on one side at least), they leave Iceland young and attach themselves to the kings and earls of the north, living in their courts as their henchmen, sharing their adventures in weal and woe, praising their victories, and hymning their deaths if they did not fall by their sides—men of quick passion, unhappy in their loves, jealous of rival poets and of their own fame, ever ready to answer criticism with a satire or with a sword-thrust, but clinging through all to their art, in which they attained most marvellous skill.

Such men were Egil, the foe of Eirik Bloodaxe and the friend of Æthelstan; Kormak, the hot-headed champion; Eyvind, King Haakon's poet, called Skaldaspillir, because he copied in his dirge over that king the older and finer *Eiríks-mal*; Gunnlaug, who sang at Æthelred's court, and fell at the hands of a brother bard, Hrafn; Halfred, Olaf Trygvason's poet, who lies in Jona by the side of Macbeth; Sighvat, Saint Olaf's henchman, most prolific of all his comrades; Thormod, Coalbrow's poet, who died singing after Sticklestad battle; Ref, Ottar the Black, Arnor the earls' poet, and, of those whose poetry was almost confined to Iceland, Gretti, Biorn the Hitdale champion, and the two model Icelandic masters, Einar Skulason and Markus the Lawman, both of the 12th century.

It is impossible to do more here than mention the names of the most famous of the long roll of poets which are noted in the works of Snorri and in the two *Skalda-tal*. They range from the rough and noble pathos of Egil, the mystic obscurity of Kormak, the pride and grief of Halfred, and the marvellous fluency of Sighvat, to the florid intricacy of Einar and Markus.

The art of poetry stood to the Icelanders in lieu of music; scarcely any prominent man but knew how to turn a mocking or laudatory stanza, and down to the fall of the commonwealth the accomplishment was in high request. In the literary age the chief poets belong to the great Sturlung family, Snorri and his two nephews, Sturla and Olaf, the White Poet, being the most famous "makers" of their day. Indeed, it is in Snorri's *Edda*, a poetic grammar of a very perfect kind, that the best examples of the whole of northern poetry are to be found. The last part, *Hattatal*, a treatise on metre, was written for Earl Skúli about 1222, in imitation of Earl Rognvald and Hall's *Hattalykill* (*Clavis metrica*) of 1150. The second part, *Skaldskapar-mal*, a gradus of synonyms and epithets, which contains over 240 quotations from 65 poets, and 10 anonymous lays—a treasury of verse—was composed c. 1230. The first part, an exquisite sketch of northern mythology, *Gylfa-ginning*, was probably prefixed to the whole later. There is some of Sturla's poetry in his *Íslendinga Saga*, and verses of Snorri occur in the *Grammatical Treatise* on figures of speech, &c., of Olaf, which contains about one hundred and forty quotations from various authors, and was written about 1250.

Besides those sources, the *Kings' Lives* of Snorri and later authors contain a great deal of verse by Icelandic poets. King Harold Sigurdsson, who fell at Stamford Bridge 1066, was both a good critic and composed himself. Many tales are told of him and his poet visitors and henchmen. The Icelandic sagas also comprise much verse which is partly genuine, partly the work of the 12th and 13th century editors. Thus there are genuine pieces in *Nial's Saga* (chaps. 34, 78, 103, 126, 146), in *Eyryggja*, *Laxdæla*, *Egill's Saga* (part only), *Grettla* (two and a half stanzas, cf. *Landnámabók*), *Biorn's Saga*, *Gunnlaug's Saga*, *Havard's Saga*, *Kormak's Saga*, *Viga-Glum's Saga*, *Erik the Red's Saga* and *Fostbrædra Saga*. In *Nial's*, *Gistli's* and *Droplaug's Sons' Sagas* there is good verse of a later poet, and in many sagas worthless rubbish foisted in as ornamental.

To these may be added two or three works of a semi-literary kind, composed by learned men, but by heroes and warriors. Such are *Konungu-tal*, *Hugsinnismál* (a paraphrase of Cato's

Distichs), *Merlin's Prophecy* (paraphrased from Geoffrey of Monmouth by Gunnlaug the monk), *Jomsvikinga-drápa* (by Bishop Ketil), and the *Islandinga-drápa*, which has preserved brief notices of several lost sagas concerning Icelandic worthies, with which *Gudmundar-drápa*, though of the 14th century, may be also placed.

Just as the change of law gave the death-blow to an already perishing commonwealth, so the rush of medieval influence, which followed the union with Norway, completed a process which had been in force since the end of the 11th century, when it overthrew the old Icelandic poetry in favour of the rimur.

The introduction of the *dans*, ballads (or *fornkvæði*, as they are now called) for singing, with a burden, usually relating to a love-tale, which were immensely popular with the people and performed by whole companies at weddings, yule feasts and the like, had relegated the regular Icelandic poetry to more serious events or to the more cultivated of the chiefs. But these "jigs," as the Elizabethans would have called them, dissatisfied the popular ear in one way: they were, like old English ballads, which they closely resembled, in rhyme, but void of alliteration, and accordingly they were modified and replaced by the "rimur," the staple literary product of the 15th century. These were rhymed but also alliterative, in regular form, with prologue or *mansong* (often the prettiest part of the whole), main portion telling the tale (mostly derived in early days from the French romances of the Carolingian, Arthurian or Alexandrian cycles, or from the mythic or skrók-sögur), and epilogue. Their chief value to us lies in their having preserved versions of several French poems now lost, and in their evidence as to the feelings and bent of Icelanders in the "Dark Age" of the island's history. The ring and melody which they all possess is their chief beauty.

Of the earliest, *Ólafsríma*, by Einar Gilsson (c. 1350), and the best, the Aristophanic *Skida-ríma* (c. 1430), by Einar Fostri, the names may be given. Rimur on sacred subjects was called "dikturn"; of these, on the legends of the saints' lives, many remain. The most notable of its class is the *Líða* of Eysteinn Asgrímsson, a monk of Holyfell (c. 1350), a most "sweet sounding song." Later the poems of the famous Jon Arason (b. 1484), last Catholic bishop of Holar (c. 1530), *Líomr* ("gleam") and *Píslográtr* ("passion-tears"), deserve mention. Arason is also celebrated as having introduced printing into Iceland.

Taste has sunk since the old days; but still this rimur poetry is popular and genuine. Moreover, the very prosaic and artificial verse of Sturla and the last of the old school deserved the oblivion which came over them, as a casual perusal of the stanzas scattered through *Islandinga* will prove. It is interesting to notice that a certain number of *kenningar* (poetical paraphrases) have survived from the old school even to the present day, though the mass of them have happily perished. The change in the *phothesis* of the language is well illustrated by the new metres as compared with the old Icelandic *drott-kvæði* in its varied forms. Most of the older rimur and dikturn are as yet unprinted. Many of the *fornkvæði* are printed in a volume of the old *Nordiske Litteratur-Samfund*.

The effects of the Reformation was deeply felt in Icelandic literature, both prose and verse. The name of Hallgrím Petursson, whose *Passion-hymns*, "the flower of all Icelandic poetry," have been the most popular composition in the language, is foremost of all writers since the second change of faith. The gentle sweetness of thought, and the exquisite harmony of wording in his poems, more than justify the popular verdict. His *Hymns* were finished in 1660 and published in 1666, two great Protestant poets thus being contemporaries. A collection of Reformation hymns, adapted, many of them, from the German, the *Holar-book*, had preceded them in 1610. There was a good deal of verse-writing of a secular kind, far inferior in every way, during this period. In spite of the many physical distresses that weighed upon the island, ballads (*fornkvæði*) were still written, ceasing about 1750, rimur composed, and more elaborate compositions published.

The most notable names are those of the improvisatore

Stephen the Blind; Thorlak Gudbrandsson, author of *Ulfar-Rímur*, d. 1707; John Magnusson, who wrote *Hristafta*, a didactic poem; Stefan Olafsson, composer of psalms, rimur, &c., d. 1688; Gunnar Pálsson, the author of *Gunnarslag*, often printed with the Eddic poems, c. 1791; and Eggert Olafsson, traveller, naturalist and patriot, whose untimely death in 1768 was a great loss to his country. His *Brunadar-balkr*, a Georgic written, like Tusser's *Points*, with a practical view of raising the state of agriculture, has always been much prized. Paul Vidalin's ditties are very naïve and clever.

Of later poets, down to more recent times, perhaps the best was Sigurd Broadfirth, many of whose prettiest poems were composed in Greenland like those of Jon Briarsson before him, c. 1750; John Thorlaksson's translation of Milton's great epic into Eddic verse is praiseworthy in intention, but, as may be imagined, falls far short of its aim. He also turned Pope's *Essay on Man* and Klopstock's *Messiah* into Icelandic. Benedikt Gröndal tried the same experiment with Homer in his *Ilión's Kvæði*, c. 1825. There is a fine prose translation of the *Odyssey* by Sveinbjörn Egilsson, the lexicographer, both faithful and poetic in high degree.

*Sagas*.—The real strength of ancient Icelandic literature is shown in its most indigenous growth, the "Saga" (see also SAGA). This is, in its purest form, the life of a hero, composed in regular form, governed by fixed rules, and intended for oral recitation. It bears the strongest likeness to the epic in all save its unversified form; in both are found, as fixed essentials, simplicity of plot, chronological order of events, set phrases used even in describing the restless play of emotion or the changeful fortunes of a fight or a storm, while in both the absence of digression, comment or intrusion of the narrator's person is invariably maintained. The saga grew up in the quieter days which followed the change of faith (1002), when the deeds of the great families' heroes were still cherished by their descendants, and the exploits of the great kings of Norway and Denmark handed down with reverence. Telling of stories was a recognized form of entertainment at all feasts and gatherings, and it was the necessity of the reciter which gradually worked them into a regular form, by which the memory was relieved and the artistic features of the story allowed to be more carefully elaborated. That this form was so perfect must be attributed to Irish influence, without which indeed there would have been a saga, but not the same saga. It is to the west that the best sagas belong; it is to the west that nearly every classic writer whose name we know belongs; and it is precisely in the west that the admixture of Irish blood is greatest. In comparing the Irish tales with the saga, there will be felt deep divergencies in matter, style and taste, the richness of one contrasting with the chastened simplicity of the other; the one's half-comic, half-earnest bombast is wholly unlike the other's grim humour; the marvellous, so unearthly in the one, is almost credible in the other; but in both are the keen grasp of character, the biting phrase, the love of action and the delight in blood which almost assumes the garb of a religious passion.

When the saga had been fixed by a generation or two of oral reciters, it was written down; and this stereotyped form, so that afterwards when literary works were composed by learned men (such as Abbot Karl's *Sverri's Saga* and Sturla's *Islandinga*) the same style was adopted.

Taking first the sagas relating to Icelanders, of which some thirty-five or forty remain out of three that number, they were first written down between 1140 and 1220, in the generation which succeeded Ari and felt the Icelandic sagas. impulse his books had given to writing, on separate scrolls, no doubt mainly for the reciter's convenience; they then went through the different phases which such popular compositions have to pass in all lands—editing and compounding (1220-1260), padding and amplifying (1260-1300), and finally collection in large MSS. (14th century). Sagas exist showing all these phases, some primitive and rough, some refined and beautified, some diluted and weakened, according as their copyists have been faithful, artistic or foolish; for the first generation

of MSS. have all perished. We have also complex sagas put together in the 13th century out of the scrolls relating to a given locality, such a group as still exists untouched in *Vappfirðinga* being fused into such a saga as *Níala* or *Laxdæla*. Of the authors nothing is known; we can only guess that some belong to the Sturlung school. According to subject they fall into two classes, those relating to the older generation before Christianity and those telling of St Olaf's contemporaries; only two fall into a third generation.

Beginning with the sagas of the west, most perfect in style and form, the earliest in subject is that of *Gold-Thori* (c. 930), whose adventurous career it relates; *Hensa-Porrissaga* tells of the burning of Blund-Ketil, a noble chief, an event which led to Thord Gelli's reforms next year (c. 964); *Gistlasaga* (960-980) tells of the career and death of that ill-fated outlaw; it is beautifully written, and the verses by the editor (13th century) are good and appropriate; *Hord's Saga* (980) is the life of a band of outlaws on Whalesfirth, and especially of their leader Hord. Of later subject are the sagas of *Havard* and his revenge for his son, murdered by a neighbouring chief (997-1002); of the *Heiðarísasaga* (990-1014), a typical tale of a great blood feud, written in the most primitive prose; of Gunnlaug and Hrafn (*Gunnlaugsaga Ormsungu*, 980-1008), the rival poets and their ill-starred love. The verse in this saga is important and interesting. To the west also belong the three great complex sagas *Egla*, *Eyrbyggja* and *Laxdæla*. The first (870-980), after noticing the migration of the father and grandfather of the hero poet Egil, and the origin of the feud between them and the kings of Norway, treats fully of Egil's career, his enmity with Eirik Bloodaxe, his service with Æthelstan, and finally, after many adventures abroad, of his latter days in Iceland at Borg, illustrating very clearly what manner of men those great settlers and their descendants were, and the feelings of pride and freedom which led them to Iceland. The style is that of Snorri, who had himself dwelt at Borg. *Eyrbyggja* (800-1031) is the saga of politics, the most loosely woven of all the compound stories. It includes a mass of information on the law, religion, traditions, &c., of the heathen days in Iceland, and the lives of Eric, the real discoverer of Greenland, Biorn of Broadwick, a famous chief, and Snorri, the greatest statesman of his day. Dr Vigfusson would ascribe its editing and completion to Sturla the Lawman, c. 1250. *Laxdæla* (910-1026) is the saga of Romance. Its heroine Gudrun is the most famous of all Icelandic ladies. Her love for Kiartan the poet, and his career abroad, his betrayal by his friend Bolli, the sad death of Kiartan at his hands, the revenge taken for him on Bolli, whose slayers are themselves afterwards put to death, and the end of Gudrun, who becomes an anchoress after her stormy life, make up the pith of the story. The contrast of the characters, the rich style and fine dialogue which are so remarkable in this saga, have much in common with the best works of the Sturlung school.

Of the north there are the sagas of *Kormak* (930-960), most primitive of all, a tale of a wild poet's love and feuds, containing many notices of the heathen times; of *Vatnalsasaga* (890-980), relating to the settlement and the chief family in Waterdale; of *Halfred* the poet (906-1014), narrating his fortune at King Olaf's court, his love affairs in Iceland, and finally his death and burial at Iona; of *Reyk-dæla* (900), which preserves the lives of Askell and his son Viga-Skuti; of *Svarf-dæla* (980-990), a cruel, coarse story of the old days, with some good scenes in it, unfortunately imperfect, chapters 1-10 being forged; of *Viga-Glum* (970-990), a fine story of a heathen hero, brave, crafty and cruel. To the north also belong the sagas of *Gretti* the Strong (1010-1031), the life and death of the most famous of Icelandic outlaws, the real story of whose career is mixed up with the mythical adventures of Beowulf, here put down to Grettir, and with late romantic episodes and fabulous folk-tales (Dr Vigfusson would ascribe the best parts of this saga to Sturla; its last editor, whose additions would be better away, may have touched it up about 1300), and the stories of the *Ljosvetningasaga* (1000-1060). Gudmund the Mighty and his family and neighbours are the heroes of these tales, which form a little

cycle. The *Banda-manna saga* (1050-1060), the only comedy among the sagas, is also a northern tale; it relates the struggles of a plebeian who gets a chieftancy against the old families of the neighbourhood, whom he successfully outwits; *Ól-kofra Þattr* is a later imitation of it in the same humorous strain. The sagas of the north are rougher and coarser than those of the west, but have a good deal of individual character.

Of tales relating to the east there survive the Weapon-firth cycle—the tales of *Thorstein the White* (c. 900), of *Thorstein the Staffsmitten* (c. 985), of *Gunnar Thídrand's Bone* (1000-1008) and of the *Weapon-firth Men* (975-990), all relating to the family of Hof and their friends and kin for several generations—and the story of *Hrafnkell Frey's Priest* (c. 960), the most idyllic of sagas and best of the eastern tales. Of later times there are *Droplaug's Sons' Saga* (997-1007), written probably about 1100, and preserved in the uncouth style of the original (a brother's revenge for his brother's death is the substance of it; *Brand-krossa Þattr* is an appendix to it), and the tales of *Thorstein Hall of Síde's Son* (c. 1014) and his brother *Thídrandi* (c. 996), which belong to the cycle of *Hall o' Síde's Saga*, unhappily lost; they are weird tales of bloodshed and magic, with idyllic and pathetic episodes.

The sagas of the south are either lost or absorbed in that of *Níal* (970-1014), a long and complex story into which are woven the tales of *Gunnar Níal*, and parts of others, as *Brian Boroimhe*, *Hall o' Síde*, &c. It is, whether we look at style, contents or legal and historical weight, the foremost of all sagas. It deals especially with law, and contains the pith and the moral of all early Icelandic history. Its hero Níal, type of the good lawyer, is contrasted with its villain Mord, the ensample of cunning, chicanery, and legal wrong doing; and a great part of the saga is taken up with the three cases and suits of the divorce, the death of Hoskuld and the burning of Níal, which are given with great minuteness. The number and variety of its dramatic personae give it the liveliest interest throughout. The women Halgerda, Berghora and Ragnhild are as sharply contrasted as the men Gunnar, Skarphedin, Flósi and Kari. The pathos of such tragedies as the death of Gunnar and Hoskuld and the burning is interrupted by the humour of the Althing scenes and the intellectual interest of the legal proceedings. The plot dealing first with the life and death of Gunnar, type of the chivalry of his day, then with the burning of Níal by Flósi, and how it came about, and lastly with Kari's revenge on the burners, is the ideal saga-plot. The author must have been of the east, a good lawyer and genealogist, and have composed it about 1250, to judge from internal evidence. It has been overworked by a later editor, c. 1300, who inserted many spurious verses.

Relating partly to Iceland, but mostly to Greenland and Vinland (N. America), are the *Floamannasaga* (985-990), a good story of the adventures of Thorgrils and of the struggles of shipwrecked colonists in Greenland, a *land and graphic and terrible picture*; and *Eiríksaga rauða North America* (990-1000), two versions, one northern (Flatey-book), one western, the better (in *Hawk's Book*, and AM. 557), the story of the discovery of Greenland and Vinland (America) by the Icelanders at the end of the 9th century. Later is the *Fostbræðrasaga* (1015-1030), a very interesting story, told in a quaint romantic style, of Thorgerð, the reckless henchman of King Olaf, and how his death was avenged in Greenland by his sworn brother the true-hearted Thormod Coalbrow's poet, who afterwards dies at Sticklestad. The tale of *Einar Sookisson* (c. 1125) may also be noticed. The lost saga of *Poet Helgi*, of which only fragments remain, was also laid in Greenland.

Besides complete sagas there are embedded in the *Heimskringla* numerous small *Þattrir* or episodes, small tales of Icelanders' adventures, often relating to poets and their lives at the kings' courts; one or two of these seem to be fragments of sagas now lost. Among the more notable are those of *Orm Stórfósson*, *Ogmund Digt*, *Halldor Snorrason*, *Thorstein Oxfof*, *Hromund Hall*, *Thorwald Tasaldi*, *Svadi* and *Arnor Heringar-nef*, *Audunn of Westfirth*, *Sneglu-Halli*, *Hrafn of Hruftford*, *Hreidar*



*Heimski. Gísli Illugíson, Ivar* the poet, *Gull-Æsu Thord, Einar Skuldason* the poet, *Mani* the poet, &c.

The forged Icelandic sagas appear as early as the 13th century. They are very poor, and either worked up on hints given in genuine stories or altogether apocryphal.

*History.*—About the year of the battle of Hastings was born Ari Froði Thorgilsson (1067-1148), one of the blood of Queen Aud, who founded the famous historical school of Iceland, and himself produced its greatest monument in a work which can be compared for value with the English Domesday Book. Nearly all that we know of the heathen commonwealth may be traced to the collections of Ari. It was he too that fixed the style in which history should be composed in Iceland. It was he that secured and put into order the vast mass of fragmentary tradition that was already dying out in his day. And perhaps it is the highest praise of all to him that he wrote in his own "Danish tongue," and so ensured the use of that tongue by the cultured of after generations. Ari's great works are *Konungabók*, or *The Book of Kings*, relating the history of the kings of Norway from the rise of the Yngling dynasty down to the death of Harald Sigurdsson in the year of his own birth. This book he composed from the dictation of old men such as Odd Kolsson, from the genealogical poems, and from the various dirges, battle-songs and eulogia of the poets. It is most probable that he also compiled shorter *Kings' Books* relating to Denmark and perhaps to England. *The Konungabók* is preserved under the *Heimskringla* of Snorri Sturluson, parts of it almost as they came from Ari's hands, for example *Ynglinga* and *Harald Fairhair's Saga*, and the prefaces stating the plan and critical foundations of the work, parts of it only used as a framework for the magnificent superstructure of the lives of the two Olafs, and of Harald Hadrada and his nephew Magnus the Good. The best text of Ari's *Konungabók* (*Ynglinga*, and the sagas down to but not including Olaf Trygvason's) is that of Frisböck.

*The Book of Settlements (Landnamabók)* is a wonderful performance, both in its scheme and carrying out. It is divided into five parts, the first of which contains a brief account of the discovery of the island; the other four, one by one taking a quarter of the land, describe the name, pedigree and history of each settler in geographical order, notice the most important facts in the history of his descendants, the names of their home-steads, their courts and temples, thus including mention of 4000 persons, one-third of whom are women, and 2000 places. The mass of information contained in so small a space, the clearness and accuracy of the details, the immense amount of life which is breathed into the whole, astonish the reader, when he reflects that this colossal task was accomplished by one man, for his collaborator Kolslegg merely filled up his plan with regard to part of the east coast, a district with which Ari in his western home at Stád was little familiar. *Landnamabók* has reached us in two complete editions, one edited by Sturla, who brought down the genealogies to his own grandfather and grandmother, Sturla and Gudny, and one by Hawk, who traces the pedigrees still later to himself.

Ari also wrote a *Book of Icelanders (Islendingabók, c. 1127)*, which has perished as a whole, but fragments of it are embedded in many sagas and *Kings' Lives*; it seems to have been a complete epitome of his earlier works, together with an account of the constitutional history, ecclesiastical and civil, of Iceland. An abridgment of the latter part of it, the little *Libellus Islendorum* (to which the title of the bigger *Liber—Islendingabók*—is often given), was made by the historian for his friends Bishops Ketil and Thorlak, for whom he wrote the *Liber* (c. 1137). This charming little book is, with the much later collections of laws, our sole authority for the Icelandic constitution of the commonwealth, but, "as much as it tells, the lost *Liber* would have been of still greater importance." *Kristni-Saga*, the story of the christening of Iceland, is also a work of Ari's, "overlaid" by a later editor, but often preserving Ari's very words. This saga, together with several scattered tales of early Christians in Iceland before the change of faith (1000), may have made up

a section of the lost *Liber*. Of the author of these works little is known. He lived in quiet days a quiet life; but he shows himself in his works, as Snorri describes him, "a man wise, of good memory and a speaker of the truth." If Thucydides is justly accounted the first political historian, Ari may be fitly styled the first of scientific historians.

A famous contemporary and friend of Ari is Sæmund (1056-1131), a great churchman, whose learning so impressed his age that he got the reputation of a magician. He was the friend of Bishop John, the founder of the great Odd-Verjar family, and the author of a *Book of Kings* from Harald Fairhair to Magnus the Good, in which he seems to have fixed the exact chronology of each reign. It is most probable that he wrote in Latin. The idea that he had anything to do with the poetic *Edda* in general, or the *Sun's Song* in particular, is unfounded.

The flame which Ari had kindled was fed by his successors in the 12th century. Eirik Oddsson (c. 1150) wrote the lives of Sigurd Evil-deacon and the sons of Harold Gille, in his *Hryggjar-Stykki* (Sheldrake), of which parts remain in the MSS. collections of *Kings' Lives, Markin-skinna*, &c. Karl Jonsson, abbot of Thingore, the Benedictine minister, wrote (c. 1184) *Sverrisaga* from the lips of that great king, a fine racy biography, with a style and spirit of its own. *Böglunga-Sögur* tell the story of the civil wars which followed Sverri's death. They are probably by a contemporary.

The Latin *Lives of St Olaf*, Odd's in Latin (c. 1175), compiled from original authorities, and the *Legendary Life*, by another monk whose name is lost, are of the medieval Latin school of Sæmund to which Gunnlaug belonged.

Snorri Sturluson (q.v.) was known to his contemporaries as a statesman and poet; to us he is above all an historian. Snorri (1170-1241) wrote the *Lives of the Kings (Heimskringla)*, from Olaf Trygvason to Sigurd the Crusader inclusive; and we have them substantially as they came from his hand in the *Great King Olaf's Saga; St Olaf's Saga*, as in *Heimskringla* and the Stockholm MS.; and the succeeding *Kings' Lives*, as in Hulda and Hrokkinskinna, in which, however, a few episodes have been inserted.

These works were indebted for their facts to Ari's labours, and to sagas written since Ari's death; but the style and treatment of them are Snorri's own. The fine Thucydidean speeches, the dramatic power of grasping character, and the pathos and poetry that run through the stories, along with a humour such as is shown in the *Edda*, and a varied grace of style that never flags or palls, make Snorri one of the greatest of historians.

Here it should be noticed that *Heimskringla* and its class of MSS. (*Eirspennil, Jofraskinna, Gullinskinna, Fris-bok* and *Kringla*) do not give the full text of Snorri's works. They are abridgments made in Norway by Icelanders for their Norwegian patrons, the *Life of St Olaf* alone being preserved intact, for the great interest of the Norwegians lay in him, but all the other *Kings' Lives* being more or less mutilated, so that they cannot be trusted for historic purposes; nor do they give a fair idea of Snorri's style.

*Agríp* is a 12th-century compendium of the *Kings' Lives* from Harald Fairhair to Sverri, by a scholastic writer of the school of Sæmund. As the only Icelandic abridgment of Norwegian history taken not from Snorri but sources now lost, it is of worth. Its real title is *Konunga-tal*.

*Noregs Konunga-tal*, now called *Fagrskinna*, is a Norse compendium of the *Kings' Lives* from Halfdan the Black to Sverri's accession, probably written for King Haakon, to whom it was read on his death-bed. It is an original work, and contains much not found elsewhere. As non-Icelandic it is only noticed here for completeness.

Styrmi Karason, a contemporary of Snorri's, dying in 1245, was a distinguished churchman (lawman twice) and scholar. He wrote a *Life of St Olaf*, now lost; his authority is cited. He also copied out *Landnamabók* and *Sverri's Life* from his MSS., of which surviving copies were taken.

Sturla, Snorri's nephew, wrote the *Hakonssaga* and *Magnussaga* at the request of King Magnus, finishing the first c. 1265, the

latter c. 1280. King Haakon's *Life* is preserved in full; of the other only fragments remain. These are the last of the series of historic works which Ari's labours began, from which the history of Norway for 500 years must be gathered.

A few books relating the history of other Scandinavian realms will complete this survey. In *Skjoldunga-bok* was told the history of the early kings of Denmark, perhaps derived from Ari's collections, and running parallel to *Ynglinga*. The earlier part of it has perished save a fragment *Sogu-brot*, and citations and paraphrases in Saxo, and the mythical *Ragnar Lodbrok's* and *Gongu-Hrofl's Sagas*; the latter part, *Lives of Harold Bluetooth and the Kings down to Sney II.*, is still in existence and known as *Skjoldunga*.

The *Knuts saga* is of later origin and separate authorships, parallel to Snorri's *Heimskringla*, but earlier in date. The *Lives of King Valdemar and his Son*, written c. 1185, by a contemporary of Abbot Karl's, are the last of this series. The whole were edited and compiled into one book, often quoted as *Skjoldunga*, by a 13th-century editor, possibly Olaf, the White Poet, Sturla's brother, guest and friend of King Valdemar II. *Jomsvinginga Saga*, the history of the pirates of Jom, down to Knut the Great's days, also relates to Danish history.

The complex work now known as *Orkneyinga* is made up of the *Earls' Saga*, lives of the first great earls, Turf-Einar, Thorfinn, &c.; the *Life of St Magnus*, founded partly on Abbot Robert's Latin life of him (c. 1150) an Orkney work, partly on Norse or Icelandic biographies; a *Miracle-book* of the same saint; the *Lives of Earl Rognwald and Sney*, the last of the vikings, and a few episodes such as the *Burning of Bishop Adam*. A scholastic sketch of the rise of the Scandinavian empire, the *Foundation of Norway*, dating c. 1120, is prefixed to the whole.

*Fereyinga* tells the tale of the conversion of the Fereys or Faroes, and the lives of its chiefs Sigmund and Leif, composed in the 13th century from their separate sagas by an Icelander of the Sturlung school.

*Biographies*.—The saga has already been shown in two forms, its original epic shape and its later development applied to the lives of Norwegian and Danish kings and earls, as heroic but deeper and broader subjects than before. In the 13th century it is put to a third use, to tell the plain story of men's lives for their contemporaries, after satisfying which demand it dies away for ever.

These biographies are more literary and medieval and less poetic than the Icelandic sagas and king's lives; their simplicity, truth, realism and purity of style are the same. They run in two parallel streams, some being concerned with chiefs and champions, some with bishops. The former are mostly found embedded in the complex mass of stories known as *Sturlunga*, from which Dr Vigfusson has extricated them, and for the first time set them in order. Among them are the sagas of *Thorgils and Hafidis* (1118–1121), the feud and peacemaking of two great chiefs, contemporaries of Ari; of *Sturla* (1150–1183), the founder of the great Sturlung family, down to the settlement of his great lawsuit by Jon Lotsson, who thereupon took his son Snorri the historian to fosterage,—a humorous story but with traces of the decadence about it, and glimpses of the evil days that were to come; of the *Omundar-brennusaga* (1185–1200), a tale of feud and fire-raising in the north of the island, the hero of which, Gudmund Dyri, goes at last into a cloister; of *Hrafn Sveinbjornsson* (1100–1213), the noblest Icelander of his day, warrior, leech, seaman, craftsman, poet and chief, whose life at home, travels and pilgrimages abroad (Hrafn was one of the first to visit Becket's shrine), and death at the hands of a foe whom he had twice spared, are recounted by a loving friend in pious memory of his virtues, c. 1220; of *Aron Hiorleifsson* (1200–1255), a man whose strength, courage and adventures befit rather a henchman of Olaf Trygvasson than one of King Haakon's thanes (the beginning of the feuds that rise round Bishop Gudmund are told here), of the *Sveinfeil-men* (1248–1252), a pitiful story of a family feud in the far east of Iceland.

But the most important works of this class are the *Islandinga Saga* and *Thorgils Saga* of Lawman Sturla. Sturla and his

brother Olaf were the sons of Thord Sturlason and his mistress Thora. Sturla was born and brought up in prosperous times, but his manhood was passed in the midst of strife, in which his family fell one by one, and he himself, though a peaceful man who cared little for politics, was more than once forced to fly for his life. While in refuge with King Magnus, in Norway, he wrote his two sagas of that king and his father. After his first stay in Norway he came back in 1271, with the new Norse law-book, and served a second time as lawman. The *Islandinga* must have been the work of his later years, composed at Fairry in Broadfirth, where he died, 30th July 1284, aged about seventy years. The saga of *Thorgils Skardi* (1252–1261) seems to have been the first of his works on Icelandic contemporary history; it deals with the life of his own nephew, especially his career in Iceland from 1252 to 1258. The second part of *Islandinga* (1242–1262), which relates to the second part of the civil war, telling of the careers of Thord Kakali, Kolbein the Young, Earl Gizur and Hrafn Oddsson. The end is imperfect, there being a blank of some years before the fragmentary ending to which an editor has affixed a notice of the author's death. The first part of *Islandinga* (1202–1242) tells of the beginning and first part of the civil wars, the lives of Snorri and Sighvat, Sturla's uncles, of his cousin and namesake Sturla Sighvatsson, of Bishop Gudmund, and Thorwald Gizursson,—the fall of the Sturlungs, and with them the last hopes of the great houses to maintain the commonwealth, being the climax of the story.

Sturla's power lies in his faithfulness to nature, minute observance of detail and purity of style. The great extent of his subject, and the difficulty of dealing with it in the saga form, are most skilfully overcome; nor does he allow prejudice or favour to stand in the way of the truth. He ranks below Ari in value and below Snorri in power; but no one else can dispute his place in the first rank of Icelandic writers.

Of the ecclesiastical biographers, an anonymous Skalholt clerk is the best. He wrote *Hungraka*, lives of the first five bishops of Skalholt, and biographies of his patron Bishop Paul (*Paðsaga*) and also of St Thorlak (*Thorlaks saga*). They are full of interesting notices of social and church life. Thorlak was a learned man, and had studied at Paris and Lincoln, which he left in 1161. These lives cover the years 1056–1193. The life of St John, a great reformer, a contemporary of Thorodd, whom he employed to build a church for him, is by another author (1052–1121). The life of Gudmund (*Gudmundar Saga Goda*), as priest, recounts the early life of this Icelandic Becket till his election as bishop (1160–1202); his after career must be sought out in *Islandinga*. It is written by a friend and contemporary. A later life by Arngrim, abbot of Thingore, written c. 1350, as evidence of his subject's sanctity, tells a good deal about Icelandic life, &c. The lives of Bishops Arni and Lawrence bring down our knowledge of Icelandic history into the 14th century. The former work, *Arno Saga Biskups*, is imperfect; it is the record of the struggles of church and state over patronage rights and glebes, written c. 1315; it now covers only the years 1269–1291; a great many documents are given in it, after the modern fashion. The latter, *Laurentius Saga Biskups*, by his disciple, priest Einar Hafidason, is a charming biography of a good and pious man, whose chequered career in Norway and Iceland is picturesquely told (1324–1331). It is the last of the sagas. *Bishop Jon's Table-Talk* (1325–1330) is also worth noticing; it contains many popular stories which the good bishop, who had studied at Bologna and Paris, was wont to tell to his friends.

*Annals*.—The *Annals* are now almost the sole material for Icelandic history; they had begun earlier, but after 1331 they got fuller and richer, till they end in 1430. The best are *Annales Regii*, ending 1306, *Einar Hafidason's Annals*, known as "Lawman's Annals," reaching to 1392, and preserved with others in *Flatey-book*, and the *New Annals*, last of all. The *Diplomatarium Islandicum*, edited by Jon Sigurdsson, contains what remains of deeds, inventories, letters, &c., from the old days, completing our scanty material for this dark period of the island's history.

*Literature of Foreign Origin.*—After the union with Norway and change of law genuine tradition died out with the great houses. The ordinary mediæval literature reached Iceland through Norway, and every one began to put it into a vernacular dress, so neglecting their own classics that but for a few collectors like Lawman Hauk they would have perished entirely.

The Norwegian kings, Haakon Haakonson (c. 1225), and Haakon V. (c. 1305), employed Icelanders at their courts in translating the French romances of the Alexander, Arthur and Charlemagne cycles. Some forty or fifty of these *Riddara-Sögur* (Romances of Chivalry) remain. They reached Iceland and were eagerly read, many Rimur being founded on them. Norse versions of *Mary of Brittany's Lays*, the stories of *Brutus* and of *Troy*, and part of the *Pharsalia* translated are also found. The *Speculum Regale*, with its interesting geographical and social information, is also Norse, written c. 1240, by a Halogalander. The computational and arithmetical treatises of Stiern-Odd, Biarni the Number-skilled (d. 1173), and Hauk Erlendsson the Lawman (d. 1334), and the geography of Ivar Bardsson, a Norwegian (c. 1340), are of course of foreign origin. A few tracts on geography, &c., in Hauk's book, and a *Guide to the Holy Land*, by Nicholas, abbot of Thwera (d. 1158), complete the list of scientific works.

The stories which contain the last lees of the old mythology and pre-history seem to be also non-Icelandic, but amplified by Icelandic editors, who probably got the plots from the Western Islands. *Völsunga Saga* and *Hervarar Saga* contain quotations and paraphrases of lays by the Helgi poet, and *Half's*, *Ragnar's* and *Asmund Kappabana's Sagas* all have bits of Western poetry in them. *Hrofl Kraki's Saga* paraphrases part of *Biarkamal*; *Hromund Grísson's* gives the story of Helgi and Kara (the lost third of the Helgi trilogy); *Gautrek's Arrow* Odd's, *Frithiof's Sagas*, &c., contain shreds of true tradition amidst a mass of later fictitious matter of no worth. With the *Riddara-Sögur* they enjoyed great popularity in the 15th century, and gave matter for many Rimur. *Þiðred's Saga*, a late version of the *Völsung* story, is of Norse composition (c. 1230), from North German sources.

The mediæval religious literature of Western Europe also influenced Iceland, and the *Homilies* (like the *Laws*) were, according to Thorodd, the earliest books written in the vernacular, antedating even Ari's histories. The lives of the *Virgin*, the *Apostles* and the *Saints* fill many MSS. (edited in four large volumes by Professor Unger), and are the works of many authors, chiefly of the 13th and 14th centuries; amongst them are the lives of *SS. Edward the Confessor, Oswald of Northumbria, Dunstan* and *Thomas of Canterbury*. Of the authors we know Priest Berg Gunsteinsson (d. 1211); Kygri-Biorn, bishop-elect (d. 1237); Bishop Brand (d. 1264); Abbot Runolf (d. 1307); Bishop Lawrence's son Arni (c. 1330); Abbot Berg (c. 1340), &c. A paraphrase of the historical books of the Bible was made by Bishop Brand (d. 1264), called *Gyðinga Sögur*. About 1310 King Haakon V. ordered a commentary on the Bible to be made, which was completed down to Exodus xix. To this Brand's work was afterwards affixed, and the whole is known as *Stiorn*. The Norse version of the famous *Barlaam and Josephat*, made for Prince Haakon (c. 1240), must not be forgotten.

*Post-classical Literature.*—The post-classical literature falls chiefly under three heads—religious, literary and scientific. Under the first comes foremost the noble translation of the New Testament by Odd Gottskalkson, the son of the bishop of Hólar. Brought up in Norway, he travelled in Denmark and Germany, and took upon him the new faith before he returned to Iceland, where he became secretary to Bishop Ogmund of Skalholt. Here he began by translating the Gospel of Matthew into his mother-tongue in secret. Having finished the remainder of the New Testament at his own house at Olves, he took it to Denmark, where it was printed at Roskild in 1540. Odd afterwards translated the Psalms, and several devotional works of the day, *Corvinus's Epistles*, &c. He was made lawman of the north and west, and died from a fall in the Laxa in Kjos, June 1556. Three years after his death the first press was set up in Iceland by John Matthewson, at Breidabolstad, in Hunafoe, and a

*Gospel and Epistle Book*, according to Odd's version, issued from it in 1562. In 1584 Bishop Gudbrand, who had brought over a splendid fount of type from Denmark in 1575 (which he completed with his own hands), printed a translation of the whole Bible at Hólar, incorporating Odd's versions and some books (*Proverbs* and the *Son of Sirach*, 1580) translated by Bishop Gizar, but supplying most of the Old Testament himself. This fine volume was the basis of every Bible issued for Iceland till 1826, when it was replaced by a bad modern version. For beauty of language and faithful simplicity of style the finer parts of this version, especially the New Testament, have never been surpassed.

The most notable theological work Iceland ever produced is the *Postill-Book* of Bishop John Vidalin (1666-1720), whose bold homely style and stirring eloquence made "John's Book," as it is lovingly called, a favourite in every household, till in the 19th century it was replaced for the worse by the more sentimental and polished Danish tracts and sermons. Theological literature is very popular, and many works on this subject, chiefly translations, will be found in the lists of Icelandic bibliographers.

The first modern scientific work is the *Iter per patriam* of Eggert Olafsson and Biarni Paulsson, which gives an account of the physical peculiarities—fauna, flora, &c.—of the island as far as could be done at the date of its appearance, 1772. The island was first made known to "the world" by this book and by the sketch of Unno von Troil, a Swede, who accompanied Sir Joseph Banks to Iceland in 1772, and afterwards wrote a series of "letters" on the land and its literature, &c. This tour was the forerunner of an endless series of "travels," of which those of Sir W. J. Hooker, Sir G. S. Mackenzie (1810), Ebenezer Henderson (1818), Joseph Paul Gaimard (1838-1843), Pajikull (1867) and, lastly, that of Sir Richard Burton, an excellent account of the land and people, crammed with information of every kind (1875), are the best.

Iceland is emphatically a land of proverbs, while of folk-tales, those other keys to the people's heart, there is plentiful store. Early work in this direction was done by Jon Gudmundsson, Olaf the Old and John Olafsson in the 17th century, who all put traditions on paper, and their labours were completed by the magnificent collection of Jon Arnason (1862-1864), who was inspired by the example of the Grimms. Many tales are but weak echoes of the sagas; many were family legends, many are old fairy tales in a garb suited to their new northern home; but, besides all these, there are a number of traditions and superstitions of indigenous origin.

The Renaissance of Iceland dates from the beginning of the 17th century, when a school of antiquaries arose. Arngrim Jonsson's *Brevis Commentarius* (1593), and *Crymogæa* (1609), were the first-fruits of this movement, of which Bishops Odd, Thorlak and Brynulf (worthy parallels to Parker and Laud) were the wise and earnest supporters. The first (d. 1630) collected much material for church history. The second (d. 1656) saved *Sturlunga* and the *Bishops' Lives*, encouraged John Egilsson to write his *New Hungerwaker*, lives of the bishops of the Dark Ages and Reformation, and helped Biorn of Skarðsa (d. 1655), a bold and patriotic antiquary (whose *Annals* continue Einar's, in his researches. The last (d. 1675) collected a fine library of MSS., and employed the famous Gízar Erlendsson, to whom and the bishop's brother, John Gizurarrson (d. 1648), we are indebted for transcripts of many lost MSS.

Torfaeus (1636-1719) and Bartholin, a Dane (d. 1690), roused the taste for northern literature in Europe, a taste which has never since flagged; and soon after them Arni Magnusson (1663-1730) transferred all that remained of vellum and good paper MSS. in Iceland to Denmark, and laid the foundations of the famous library and bequest, for which all Icelandic students are so much beholden. For over forty years Arni stuck to his task, rescuing every scrap he could lay hands on from the risks of the Icelandic climate and carelessness, and when he died only one good MSS. remained in the island. Besides his magnificent collection, there are a few MSS. of great value at

Upsala, at Stockholm, and in the old royal collection at Copenhagen. Those in the university library in the latter city perished in the fire of 1728. Sagas were printed at Upsala and Copenhagen in the 17th century, and the Arna-Magnaean fund has been working since 1772. In that year appeared also the first volume of Bishop Finn Jonsson's *Historia Ecclesiastica Islandiae*, a work of high value and much erudition, containing not only ecclesiastical but civil and literary history, illustrated by a well-chosen mass of documents, 870-1740. It has been continued by Bishop P. Peterson to modern times, 1740-1840. The results, however, of modern observers and scholars must be sought for in the periodicals, *Safn*, *Felagsrit*, *Ný Felagsrit* and others. John Espolin's *Arbætur* is very good up to its date, 1821.

A brilliant sketch of Icelandic classic literature is given by Dr Gudbrand Vigfusson in the Prolegomena to *Sturlunga Saga* (Oxford, 1879). It replaces much earlier work, especially the *Sciographia* of Halfdan Einarsson (1777), and the *Saga-Bibliotek* of Müller. The numerous editions of the classics by the Icelandic societies, the Danish Société des Antiquités, Nordiske Litteratur Samfund, and the new Gæmel Nordisk Litteratur Samfund, the splendid Norwegian editions of Unger, the labours of the Icelanders Sigurdsson and Gislason, and of those foreign scholars in Scandinavia and Germany who have thrown themselves into the work of illustrating, publishing and editing the sagas and poems (men like P. A. Munch, S. Bugge, F. W. Bergmann, Th. Möbius and K. von Maurer, to name only a few), can only be referred to here. See also Finnur Jónsson, *Den Oldnorske og Oldislandske Litteraturs Historie* (Copenhagen, 1893-1900), R. E. Anderson's translation (Chicago, 1884), of Winkel Horn's *History of the Literature of the Scandinavian North*, and W. Morris and E. Magnusson's *Saga Library*. (F. Y. F.)

#### RECENT LITERATURE

The recent literature of Iceland has been in a more flourishing state than ever before since the 13th century. Lyrical poetry is by far the largest and the most interesting portion of it. The great influence of Jónas Hallgrímsson (1807-1845) is still felt, and his school was the reigning one up to the end of the 19th century, although then a change seemed to be in sight. The most successful poet of this school is Steingrím Thorsteinsson (b. 1830). He is specially famous for his splendid descriptions of scenery (*The Song of Gilshakki*), his love-songs and his sarcastic epigrams. As a translator he has enriched the literature with *The Arabian Nights*, *Sakuntala*, *King Lear* and several other masterpieces of foreign literature. Equal in fame is Matthías Jochumsson (b. 1835), who, following another of Jónas Hallgrímsson's many ways, has successfully revived the old metres of the classical Icelandic poets, whom he resembles in his majestic, but sometimes too gorgeous, language. He is as an artist inferior to Steingrím Thorsteinsson, but surpasses him in bold flight of imagination. He has successfully treated subjects from Icelandic history (*Grettisljóð*, a series of poems about the famous outlaw Grettir). His chief fault is a certain carelessness in writing; he can never write a bad poem, but rarely a poem absolutely flawless. He has translated Tegnér's *Fritziöfs Saga*, several plays of Shakespeare and some other foreign masterpieces. The great religious poet of Iceland, Hallgrím Pétursson, has found a worthy successor in Valdemar Briem (b. 1848), whose *Songs of the Bible* are deservedly popular. He is like Matthías Jochumsson in the copious flow of his rhetoric; some of his poems are perfect both as regards form and contents, but he sometimes neglects the latter while polishing the former. An interesting position is occupied by Benedict Gröndal (b. 1826), whose travesties of the old romantic stories,<sup>1</sup> and his Aristophanic drama *Gandreiðin* ("The Magic Ride") about contemporary events, are among the best satirical and humorous productions of Icelandic literature.

Influenced by Jónas Hallgrímsson with regard to language and poetic diction, but keeping unbroken the traditions of Icelandic medieval poetry maintained by Sigurðr Breiðfjörð (1798-1846), is another school of poets, very unlike the first. In the middle of the 19th century this school was best represented by Hjálmar Jónsson from Bóla (1796-1875), a poor farmer <sup>1</sup>E.g. "The Battle of the Plains of Death," a burlesque on the battle of Solferino.

with little education, but endowed with great poetical talents, and the author of satirical verses not inferior to those of Juvenal both in force and coarseness. In the last decades of the 19th century this school produced two poets of a very high order, both distinctly original and Icelandic. One is Páll Ólafsson (b. 1827). His songs are mostly written in the medieval quatrains (*ferskeylla*), and are generally of a humorous and satirical character; his convivial songs are known by heart by every modern Icelandic; and although some of the poets of the present day are more admired, there is none who is more loved by the people. The other is Þorsteinn Erlingsson (b. 1858). His exquisite satirical songs, in an easy and elegant but still manly and splendid language, have raised much discussion. Of his poems may be mentioned *The Oath*, a series of most beautiful ballads, with a tragical love-story of the 17th century as their base, but with many and happy satirical allusions to modern life; *Jörundur*, a long poem about the convict king, the Danish pirate Jørgensen, who nearly succeeded in making himself the master of Iceland, and *The Fate of the Gods and The Men of the West* (the Americans), two poems which, with their anti-clerical and half-socialist tendencies, have caused strong protests from orthodox Lutheran clergy. Near to this school, but still standing apart, is Grímur Thomsen (b. 1820).

In the beginning of the 'eighties a new school arose—having its origin in the colony of Icelandic students at the University of Copenhagen. They had all attended the lectures of Georg Brandes, the great reformer of Scandinavian literature, and, influenced by his literary theories, they chose their models in the realistic school. This school is very dissimilar from the half-romantic school of Jónas Hallgrímsson; it is nearer the national Icelandic school represented by Páll Ólafsson and Þorsteinn Erlingsson, but differs from those writers by introducing foreign elements hitherto unknown in Icelandic literature, and—especially in the case of the prose-writers—by imitating closely the style and manner of some of the great Norwegian novelists. Their influence brought the Icelandic literature into new roads, and it is interesting to see how the tough Icelandic element gradually assimilates the foreign. Of the lyrical poets, Hannes Hafsteinn (b. 1861) is by far the most important. In his splendid ballad, *The Death of Skarphedinn*, and in his beautiful series of songs describing a voyage through some of the most picturesque parts of Iceland, he is entirely original; but in his love-songs, beautiful as many of them are, a strong foreign influence can be observed. Among the innovations of this poet we may note a predilection for new metres, sometimes adopted from foreign languages, sometimes invented by himself, a thing practised rarely and generally with small success by the Icelandic poets.

No Icelandic novelist has as yet equalled Jón Þórðsson (1819-1868). The influence of the realistic school has of late been predominant. The most distinguished writer of that school has been Gestur Pálsson (1852-1891), whose short stories with their sharp and biting satire have produced many imitations in Iceland. The best are *A Home of Love* and *Captain Sigurd*. Jónas Jónasson (b. 1856), a clergyman of northern Iceland, has, in a series of novels and short stories, given accurate, but somewhat dry, descriptions of the more gloomy sides of Icelandic country life. His best novel is *Randiðr from Hvassafell*, an historical novel of the middle ages. Besides these we may mention Torfhildur Hólm, one of the few women who have distinguished themselves in Icelandic literature. Her novels are mostly historical. The last decade of the 19th century saw the establishment of a permanent theatre at Reykjavík. The poet Matthías Jochumsson has written several dramas, but their chief merit is lyrical. The most successful of Icelandic dramatists as yet is Indriði Einarsson, whose plays, chiefly historical, in spite of excessive rhetoric, are very interesting and possess a true dramatic spirit.

In geography and geology Þorvaldur Þórðsson has acquired a European fame for his researches and travels in Iceland, especially in the rarely-visited interior. Of his numerous writings in Icelandic, Danish and German, the *History of*

*Icelandic Geography* is a monumental work. In history Páll Melsteð's (b. 1812) chief work, the large *History of the World*, belongs to this period, and its pure style has had a beneficial influence upon modern Icelandic prose.

Of the younger historians we may mention Þorkell Bjarnason (*History of the Reformation in Iceland*). Jón Þorkelsson (b. 1822), inspector of the archives of Iceland, has rendered great services to the study of Icelandic history and literature by his editions of the *Diplomatarium Islandicum* and *Obituarium Islandicum*, and by his *Icelandic Poetry in the 15th and 16th Century*, written in Danish, an indispensable work for any student of that period. A leading position among Icelandic lexicographers is occupied by Jón Þorkelsson, formerly head of the Latin school at Reykjavík, whose *Supplement til islandske Ordboeger*, an Icelandic-Danish vocabulary (three separate collections), has hardly been equalled in learning and accuracy. Other distinguished philologists are his successor as head of the Latin school, Björn Magnússon Olsen (*Researches on Sturlunga, Ari the Wise, The Runes in the Old Icelandic Literature*—the last two works in Danish); Finnur Jónsson, professor at the University of Copenhagen (*History of the Old Norwegian and Icelandic Literature*, in Danish, and excellent editions of many old Icelandic classical works); and Valtýr Guðmundsson, lecturer at the University of Copenhagen (several works on the old architecture of Scandinavia) and editor of the influential Icelandic literary and political review, *Eimreiðin* ("The Locomotive").

See J. C. Poestion, *Isländische Dichter der Neuzeit* (Leipzig, 1897); C. Küchler, *Geschichte der isländischen Dichtung der Neuzeit* (Leipzig, 1896); Ph. Schweitzer, *Inland; Land und Leute* (Leipzig, 1885); Alexander Baumgartner, *Inland und die Faroer* (Freiburg im Breisgau, 1898). (S. Bl.)

**ICELAND MOSS**, a lichen (*Cetraria islandica*) whose erect or ascending foliaceous habit gives it something of the appearance of a moss, whence probably the name. It is often of a pale chestnut colour, but varies considerably, being sometimes almost entirely greyish white; and grows to a height of from 3 to 4 in., the branches being channelled or rolled into tubes, which terminate in flattened lobes with fringed edges. It grows abundantly in the mountainous regions of northern countries, and it is specially characteristic of the lava slopes and plains of the west and north of Iceland. It is found on the mountains of north Wales, north England, Scotland and south-west Ireland. As met with in commerce it is a light-grey harsh cartilaginous body, almost destitute of colour, and having a slightly bitter taste. It contains about 70% of lichenin or lichen-starch, a body isomeric with common starch, but wanting any appearance of structure. It also yields a peculiar modification of chlorophyll, called thallochlor, fumaric acid, lichenostearic acid and cetraric acid, to which last it owes its bitter taste. It forms a nutritious and easily digested amylaceous food, being used in place of starch in some preparations of cocoa. It is not, however, in great request, and even in Iceland it is only habitually resorted to in seasons of scarcity. Cetraric acid or cetrarin, a white micro-crystalline powder with a bitter taste, is readily soluble in alcohol, and slightly soluble in water and ether. It has been recommended for medicinal use, in doses of 2 to 4 grains, as a bitter tonic and aperient.

**ICE-PLANT**, the popular name for *Mesembryanthemum crystallinum*, a hardy annual most effective for rockwork. It is a low-growing spreading herbaceous plant with the fleshy stem and leaves covered with large glittering papillae which give it the appearance of being coated with ice. It is a dry-country plant, a native of Greece and other parts of the Mediterranean region, the Canary Islands, South Africa and California. *Mesembryanthemum* is a large genus (containing about 300 species) of erect or prostrate fleshy herbs or low shrubs, mostly natives of South Africa, and rarely hardy in the British Isles where they are mostly grown as greenhouse plants. They bear conspicuous white, yellow or red flowers with many petals inserted in the calyx-tube. The thick fleshy leaves are very variable in shape, and often have spiny rigid hairs on the margin. They are essentially sun-loving plants. The best-known member of the genus is *M. cordifolium*, var. *variegatum*, with heart-shaped

green and silvery leaves and bright rosy-purple flowers. It is extensively used for edging flower-beds and borders during the summer months.

**ICE-YACHTING**, the sport of sailing and racing ice-boats. It is practised in Great Britain, Norway and Sweden, to some extent, and is very popular in Holland and on the Gulf of Finland, but its highest development is in the United States and Canada. The Dutch ice-yacht is a flat-bottomed boat resting crossways upon a plank about three feet wide and sixteen long, to which are affixed four steel runners, one each at bow, stern and each end of the planking. The rudder is a fifth runner fixed to a tiller. Heavy mainsails and jibs are generally used and the boat is built more for safety than for speed. The ice-boat of the Gulf of Finland is a V-shaped frame with a heavy plank running from bow to stern, in which the mast is stepped. The stern or steering runner is worked by a tiller or wheel. The sail is a large lug and the boom and gaff are attached to the mast by travellers. The passengers sit upon planks or rope netting. The Russian boats are faster than the Dutch.

In 1790 ice-yachting was in vogue on the Hudson river, its headquarters being at Poughkeepsie, New York. The type was a square box on three runners, the two forward ones being nailed to the box and the third acting as a rudder operated by a tiller. The sail was a flatheaded sprit. This primitive type generally obtained until 1853, when triangular frames with "boxes" for the crew aft and jib and mainsail rig were introduced. A heavy, hard-tidied type soon developed, with short gaffs, low sails, large jibs and booms extending far over the stern. It was over-canvassed and the mast was stepped directly over the runner-plank, bringing the centre of sail-balance so far aft that the boats were apt to run away, and the over-canvassing frequently caused the windward runner to swing up into the air to a dangerous height. The largest and fastest example of this type, which prevailed until 1879, was Commodore J. A. Roosevelt's first "Icicle," which measured 66 ft. over all and carried 1070 sq. ft. of canvas. In 1879 Mr H. Relyea built the "Robert Scott," which had a single backbone and wire guy-ropes, and it became the model for all Hudson river ice-yachts. Masts were now stepped farther forward, jibs were shortened, booms cut down, and the centre of sail-balance was brought more inboard and higher up, causing the centres of effort and resistance to come more in harmony. The shallow steering-box became elliptical. In 1881 occurred the first race for the American Challenge Pennant, which represents the championship of the Hudson river, the clubs competing including the Hudson river, North Shrewsbury, Orange lake, Newburgh and Carthage Ice-Yacht Clubs. The races are usually sailed five times round a triangle of which each leg measures one mile, at least two of the legs being to windward. Ice-yachts are divided into four classes, carrying respectively 600 sq. ft. of canvas or more, between 450 and 600, between 300 and 450, and less than 300 sq. ft. Ice-yachting is very popular on the Great Lakes, both in the United States and Canada, the Kingston (Ontario) Club having a fleet of over 25 sail. Other important centres of the sport are Lakes Minnetonka and White Bear in Minnesota, Lakes Winnebago and Pepin in Wisconsin, Bar Harbor lake in Maine, the St Lawrence river, Quinte Bay and Lake Champlain.

A modern ice-yacht is made of a single-piece backbone the entire length of the boat, and a runner-plank upon which it rests at right angles, the two forming a kite-shaped frame. The best woods for these pieces are basswood, butternut and pine. They are cut from the log in such a way that the heart of the timber expands, giving the planks a permanent curve, which, in the finished boat, is turned upward. The two forward runners, usually made of soft cast iron and about 2 ft. 7 in. long and 2½ in. high, are set into oak frames a little over 5 in. long and 5 in. high. The runners have a cutting edge of 90°, though a V-shaped edge is often preferred for racing. The rudder is a runner about 3 ft. 7 in. long, worked by a tiller, sometimes made very long, 7½ ft. not being uncommon. This enables the helmsman to lie in the box at full length and steer with his feet, leaving his hands free to tend the sheet. Masts and spars are

generally made hollow for racing-yachts and the rigging is pliable steel wire. The sails are of 10-oz. duck for a boat carrying 400 sq. ft. of canvas. They have very high peaks, short hoists and long booms. The mainsail and jib rig is general, but a double-masted lateen rig has been found advantageous. The foremost ice-yacht builder of America is G. E. Buckhout of Poughkeepsie.

An ice-yacht about 40 ft. in length will carry 6 or 7 passengers or crew, who are distributed in such a manner as to preserve the balance of the boat. In a good breeze the crew lie out on the windward side of the runner-plank to balance the boat and reduce the pressure on the leeward runner. A course of 20 m. with many turns has been sailed on the Hudson in less than 48 minutes, the record for a measured mile with flying start being at the rate of about 72 m. an hour. In a high wind, however, ice-yachts often move at the rate of 85 and even 90 m. an hour.

Several of the laws of ice navigation seem marvellous to the uninitiated. Commodore Irving Grinnell, who has made a scientific study of the sport, says: "The two marked peculiarities of ice-yachting which cause it to differ materially from yachting on the sea are: (1) Sailing faster than the wind. (2) Sheets flat aft under all circumstances." Mr H. A. Buck, in the "Badminton Library," *Skating, Curling, Tobogganing, &c.*, thus explains these paradoxes. An ice-boat sails faster than the wind because she invariably sails at some angle to it. The momentum is increased by every puff of wind striking the sails obliquely, until it is finally equalled by the increase of friction engendered. Thus the continued bursts of wind against the sails cause a greater accumulation of speed in the ice-yacht than is possessed by the wind itself. When the boat sails directly before the wind she is, like a balloon, at its mercy, and thus does not sail faster than the wind. The ice-yacht always sails with its sheets flat aft, because the greater speed of the boat changes the angle at which the wind strikes the sail from that at which it would strike if the yacht were stationary to such a degree that, in whatever direction the yacht is sailing, the result is always the same as if the yacht were close-hauled to the wind. It follows that the yacht is actually overhauling the wind, and her canvas shivers as if in the wind's eye. When eased off her momentum becomes less and less until it drops to the velocity of the wind, when she can readily be stopped by being spun round and brought head to the wind. The latter method is one way of "coming to," instead of luffing up in the usual way from a beam wind. In beating to windward an ice-boat is handled like a water yacht, though she points more closely.

On the bays near New York a peculiar kind of ice-boat has developed, called *scooter*, which may be described as a toboggan with a sail. A typical scooter is about 15 ft. long with an extreme beam of 5 ft., perfectly oval in form and flat. It has mainsail and jib carried on a mast 9 or 10 ft. long and set well aft, and is provided with two long parallel metal runners. There is no rudder, the scooter being steered entirely by trimming the sails, particularly the jib. As the craft is flat and buoyant it sails well in water, and can thus be used on very thin ice without danger. A speed of 50 m. an hour has been attained by a scooter (see *Outing* for March 1905).

See *Ice Sports*, in the "Isthmian Library"; *Skating, Curling, Tobogganing, &c.* in the "Badminton Library."

**I-CH'ANG** (YI-CH'ANG, anciently known as *Yi-ling*), a town of China in the province of Hu-peh, one of the four ports opened to foreign trade by treaty in 1877. It is situated in 30° 42' N. and (approximately) 111° 20' E., on the Yangtze-Kiang, 1000 m. from Shanghai. Built on the left bank of the river where it escapes from the ravines and gorges which for 350 m. have imprisoned its channel, I-ch'ang is exposed to considerable risk of floods; in 1870 the waters rose 20 ft. in one day, and the town had many of its houses and about half of its wall swept away. The first English vessels to ascend the river as far as I-ch'ang were those of Admiral Sir James Hope's expedition in 1861. All cargo to or from Szech'uen is here transhipped

from steamer to junk, or *vice versa*. About 10 m. above I-ch'ang the famed scenery of the Yangtze gorges begins. Through these the great river runs in a series of rapids, which make navigation by vessels of any size extremely difficult. A very large trade, nevertheless, is carried on by this route between Chung'king and I-ch'ang. As a local centre of distribution this port is of no great consequence, the transhipment trade with Szech'uen being almost its sole business. The population is estimated at 35,000. The number of foreign residents is very small, trade being carried on by Chinese agents. Before the anti-opium campaign of 1906 (see CHINA) opium was much grown. The trade of the port amounted in 1890 to £531,229, and in 1904 to £124,442, the principal import being cotton yarn and the principal export opium.

**ICHNEUMON** (Gr. *ἰχνημων*, from *ἰχνη*, to track out), the common name of the North African representative of a number of small weasel-shaped mammals belonging to the carnivorous family *Viverridae*; the Indian representatives of the group being known as mongooses. A large number of species of the type genus are known, and range over southern Asia and all Africa, the typical *Herpestes ichneumon* also occurring in the south of Spain. The latter is an inhabitant of Egypt and the north of Africa, where it is known to foreign residents as "Pharaoh's rat." It is covered with long harsh fur of a tawny-grey colour, darker on the head and along the middle of the back, its legs reddish and its feet and tail black. It lives largely on rats and mice, birds and reptiles, and for this reason it is domesticated. It is, however, fond of poultry and their eggs, and its depredations among fowls detract from its merits as a vermin-killer. During the inundations of the Nile it is said to approach the habitations of man, but at other seasons it keeps to the fields and to the banks of the river. The Indian mongoose (*H. mango*) is considerably smaller than the Egyptian animal, with fur of a pale-grey colour, the hairs being largely white-ringed, while the cheeks and throat are more or less reddish. Like



Egyptian Ichneumon (*Herpestes ichneumon*).

The former it is frequently domesticated. It is especially serviceable in India as a serpent-killer, destroying not only the eggs and young of these creatures, but killing the most venomous adult snakes. The fact that it survives those encounters has led to the belief that it either enjoys immunity from the effects of snake poison, or that after being bitten it has recourse, as the Hindus maintain, to the root of a plant as an antidote. It has been found, however, that when actually bitten it falls a victim to the poison as rapidly as other mammals, while there is no evidence of its seeking a vegetable antidote. The truth seems to be that the mongoose, by its exceeding agility and quickness of eye, avoids the fangs of the snake while fixing its own teeth in the back of the reptile's neck. Moreover, when excited, the mongoose erects its long stiff hair, and it must be very difficult for a snake to drive its fangs through this and the thick skin which all the members of the genus possess. The mongoose never hesitates to attack a snake; the moment he sees his enemy, "as his whole nature," writes a spectator of one of those fights, "appears to be changed. His fur stands on end, and he presents the incarnation of intense rage. The snake invariably attempts to escape, but, finding it impossible to evade the rapid onslaught of the mongoose, raises his crest and lashes out fiercely at his little persecutor, who seems to delight in dodging out of the way just in time. This goes on until the mongoose sees his opportunity, when like lightning he rushes in and seizes the snake with his teeth by the back of the neck close to the head, shaking him as a terrier does a rat. These tactics are repeated until the snake is killed." The mongoose is equally dexterous in killing rats and other four-footed vermin.

**ICHNEUMON-FLY**, a general name applied to parasitic insects of the section *Ichneumonidea* (or *Entomophaga*), other

*Hymenoptera*, from the typical genus *Ichneumon*, belonging to the chief family of that section—itsself fancifully so called after the Egyptian mammal (*Herpestes*). The species of the families (*Ichneumonidae*, *Braconidae*, *Evaniidae*, *Proctotrypidae*, and *Chalcididae* are often indiscriminately called "Ichneumons," but the "super-family" of the Ichneumonoidea in the classification of W. H. Ashmead contains only the *Evaniidae*, the *Stephanidae*, and the large assemblage of insects usually included in the two families of the *Ichneumonidae* and the *Braconidae*, which are respectively equivalent to the *Ichneumon* *genuini* and *I. adsciti* of older naturalists, chiefly differing in the former having two recurrent nerves to the anterior wing, whilst the latter has only one such nerve. The *Ichneumonidae* proper are one of the most extensive groups of insects. Gravenhorst described some 1650 European species, to which considerable subsequent additions have been made. There are 6 sub-families of the *Ichneumonidae*, viz. the *Ichneumoninae*, *Cryptinae*, *Agriotypinae*, *Ophioninae*, *Tryphoninae* and *Pimplinae*, differing considerably in size and facies, but united in the common attribute of being, in their earlier stages, parasitic upon other insects. They have all long narrow bodies; a small free head with long filiform or setaceous antennae, which are never elbowed, and have always more than sixteen joints; the abdomen attached to the thorax at its hinder extremity between the base of the posterior coxae, and provided in the female with a straight ovipositor often exerted and very long; and the wings veined, with perfect cells on the disk of the front pair. Ashmead proposes to separate the *Agriotypidae* (which are remarkable for their aquatic habit, being parasitic on caddis-worms) from the *Ichneumonidae* on account of their firm ventral abdominal segments and spined scutellum. He also separates from the *Braconidae* the *Alysiidae* as a distinct family; they have peculiar mandibles with out-turned tips.

Their parasitic habits render these flies of great importance in the economy of nature, as they serve to check any inordinate increase in the numbers of injurious insects. Without their aid it would in many cases be impossible for the agriculturist to hold his own against the ravages of his minute insect foes, whose habits are not sufficiently known to render artificial checks or destroying agents available. The females of all the species are constantly on the alert to discover the proper living food for their own larvae, which are hatched from the eggs they deposit in or on the eggs, larvae or pupae of other insects of all orders, chiefly *Lepidoptera*, the caterpillars of butterflies and moths being specially attacked (as also are spiders). Any one who has watched insect life during the summer can hardly have failed to notice the busy way in which the parent ichneumon, a small four-winged fly, with constantly vibrating antennae, searches for her prey; and the clusters of minute cocoons round the remains of some cabbage-butterfly caterpillar must also have been observed by many. This is the work of *Apanteles* (or *Microgaster*) *glomeratus*, one of the *Braconidae*, which in days past was a source of disquietude to naturalists, who believed that the life of the one defunct larva had transmigrated into the numerous smaller flies reared from it. Ichneumon-flies which attack external feeders have a short ovipositor, but those attached to wood-feeding insects have that organ of great length, for the purpose of reaching the haunts of their concealed prey. Thus a species from Japan (*Bracon penetrator*) has its ovipositor nine times the length of the body; and the large species of *Rhyssa* and *Ephialtes*, parasitic on *Sirex* and large wood-boring beetles in temperate Europe, have very long instruments (with which when handled they will endeavour to sting, sometimes penetrating the skin), in order to get at their secreted victims. A common reddish-coloured species of *Ophion* (*O. obscurum*), with a sabre-shaped abdomen, is noteworthy from the fact of its eggs being attached by stalks outside the body of the caterpillar of the puss-moth (*Cerura vinula*). Lepidopterists wishing to breed the latter cut off the eggs of the parasite with scissors.

The larvae of the ichneumon-flies are white, fleshy, cylindrical, footless grubs; the majority of them spin silk cocoons before

pupating, often in a mass (sometimes almost geometrically), and sometimes in layers of different colours and texture.

**AUTHORITIES.**—Among the older works on Ichneumonoidea may be specially mentioned J. L. K. Gravenhorst, *Ichneumonologia Europaea* (Breslau, 1829); A. H. Haliday (*Entom. Mag.* i-v, 1832, 1838), and A. Förster (*Verhandl. Naturhist. Ver. Rheinl. u. Westph.* xix., xxv., 1862, 1868). Full reference to the systematic literature of the group will be found in C. G. de Dalla Torre's *Catalogus hymenopterorum*, vols. iii., iv. (Leipzig, 1898-1902), and a comprehensive summary in W. H. Ashmead's recent memoir (*Proc. U.S. Nat. Mus.* xxiii., 1901). For the British species consult C. Morley, *Ichneumons of Great Britain* (Plymouth, 1903), and T. A. Marshall (*Trans. Entom. Soc.*, 1885-1899).

**ICHOGRAPHY** (Gr. *ἴχθυος*, a trace, and *γραφῆς*, description), in architecture, a term defined by Vitruvius (i. 2) as "the ground-plan of the work," i.e. the geometrical projection or horizontal section representing the plan of any building, taken at such a level as to show the outer walls, with the doorways, windows, fireplaces, &c., and the correct thickness of the walls; the position of piers, columns or pilasters, courtyards and other features which constitute the design.

**ICHTHYOLOGY** (from Gr. *ἰχθῦς*, fish, and *λόγος*, doctrine or treatise), the branch of zoology which treats of the internal and external structure of fishes, their mode of life, and their distribution in space and time. According to the views now generally adopted, all those vertebrate animals are referred to the class of fishes which combine the following characteristics: they live in water, and by means of gills or branchiae breathe air dissolved in water; the heart consists of a single ventricle and single atrium; the limbs, if present, are modified into fins, supplemented by unpaired median fins; and the skin is either naked or covered with scales or with osseous plates or bucklers. With few exceptions fishes are oviparous. There are, however, not a few members of this class which show a modification of one or more of these characteristics, and which, nevertheless, cannot be separated from it.

#### I. HISTORY AND LITERATURE DOWN TO 1830

The commencement of the history of ichthyology coincides with that of zoology generally. Aristotle (384-322 B.C.) had a perfect knowledge of the general structure of fishes, which he clearly discriminates both from the aquatic animals with lungs and mammae, i.e. Cetaceans, and from the various groups of aquatic invertebrates. According to him: "the special characteristics of the true fishes consist in the branchiae and fins, the majority having four fins, but those of an elongate form, as the eels, having two only. Some, as the *Muraena*, lack the fins altogether. The rays swim with their whole body, which is spread out. The branchiae are sometimes furnished with an operculum, sometimes they are without one, as in the cartilaginous fishes. . . . No fish has hairs or feathers; most are covered with scales, but some have only a rough or a smooth skin. The tongue is hard, often toothed, and sometimes so much adherent that it seems to be wanting. The eyes have no lids, nor are any ears or nostrils visible, for what takes the place of nostrils is a blind cavity; nevertheless they have the senses of tasting, smelling and hearing. All have blood. All scaly fishes are oviparous, but the cartilaginous fishes (with the exception of the sea-devil, which Aristotle places along with them) are viviparous. All have a heart, liver and gall-bladder; but kidneys and urinary bladder are absent. They vary much in the structure of their intestines: for, whilst the mullet has a fleshy stomach like a bird, others have no stomachic dilatation. Pyloric caeca are close to the stomach, and vary in number; there are even some, like the majority of the cartilaginous fishes, which have none whatever. Two bodies are situated along the spine, which have the function of testicles; they open towards the vent, and are much enlarged in the spawning season. The scales become harder with age. Not being provided with lungs, fishes have no voice, but several can emit grunting sounds. They sleep like other animals. In most cases the females exceed the males in size; and in the rays and sharks the male is distinguished by an appendage on each side of the vent."

authors from personal examination—a comparatively small proportion, but descriptions and figures still formed in great measure the substitute for our modern collections and museums. With the increasing accumulation of forms, the want of a fixed nomenclature had become more and more felt.

Peter Artedi (1705-1734) would have been a great ichthyologist if Ray or Willughby had not preceded him. But he was fully conscious of the fact that both had prepared the way for him, and therefore he did not fail to reap every possible advantage from their labours. His work, edited by Linnaeus, is divided as follows:—

(1) In the *Bibliotheca ichthyologica* Artedi gives a very complete list of all preceding authors who had written on fishes, with a critical analysis of their works. (2) The *Philosophia ichthyologica* is devoted to a description of the external and internal parts of fishes; Artedi fixes a precise terminology for all the various modifications of the organs, distinguishing between those characters which determine a genus and such as indicate a species or merely a variety; in fact he establishes the method and principles which subsequently have guided every systematic ichthyologist. (3) The *Genera piscium* contains well-defined diagnoses of forty-five genera, for which he has fixed an unchangeable nomenclature. (4) In the *Species piscium* descriptions of seven-hundred species, examined by himself, are given—descriptions which even now are models of exactitude and method. (5) Finally, in the *Synonymia piscium* references to all previous authors are arranged for every species, very much in the manner which is adopted in the systematic works of the present day.

Artedi has been justly called the father of ichthyology. So admirable was his treatment of the subject, that even Linnaeus could only modify and add to it. Indeed, so far as ichthyology is concerned, Linnaeus has scarcely done anything beyond applying binominal terms to the species properly described and classified by Artedi. His classification of the genera appears in the 12th edition of the *Systema* thus:—

A. *Amphibia nantia*.—*Spiraculis compositis*.—Petryomyzon, Raia, Squalus, Chimaera. *Spiraculis solitariis*.—Lophius, Acipenser, Cyclopterus, Baiistes, Ostracion, Tetrodon, Diodon, Centricus, Syngnathus, Pegasus.

B. *Pisces apodes*.—Muraena, Gymnotus, Trichirurus, Anarrhichas, Ammodytes, Ophidium, Stromateus, Xiphias.

C. *Pisces jugulares*.—Callionymus, Uranoscopus, Trachinus, Gadus, Blennius.

D. *Pisces thoracici*.—Cepala, Echenes, Coryphaena, Gobius, Cottus, Scorpaena, Zeus, Pleuronectes, Chaetodon, Sparus, Labrus, Sciaena, Perca, Gasterosteus, Scomber, Mullus, Trigla.

E. *Pisces abdominales*.—Cobitis, Amia, Silurus, Teuthis, Loricaria, Salmo, Fistularia, Esox, Elops, Argentina, Atherina, Mugil, Mormyrus, Exocoetia, Polynemus, Clupea, Cyprinus.

Two contemporaries of Linnaeus, L. T. Gronow and J. T. Klein, attempted a systematic arrangement of fishes.

The works of Artedi and Linnaeus led to an activity of research, especially in Scandinavia, Holland, Germany and England, such as has never been equalled in the history of biological science. Whilst some of the pupils and followers of Linnaeus devoted themselves to the examination and study of the fauna of their native countries, others proceeded on voyages of discovery to foreign and distant lands. Of these latter the following may be especially mentioned: O. Fabricius worked out the fauna of Greenland; Peter Kalm collected in North America, F. Hasselquist in Egypt and Palestine, M. T. Brännich in the Mediterranean, Osbeck in Java and China, K. P. Thunberg in Japan; Forskäll examined and described the fishes of the Red Sea; G. W. Steller, P. S. Pallas, S. G. Gmelin, and A. J. Gildensstädt traversed nearly the whole of the Russian empire in Europe and Asia. Others attached themselves as naturalists to celebrated navigators, such as the two Forsters (father and son) and Solander, who accompanied Cook; P. Commerson, who travelled with Bougainville; and Pierre Sonnerat. Of those who studied the fishes of their native countries, the most celebrated were Pennant (Great Britain), O. F. Müller (Denmark), Duhamel du Monceau (France), C. von Meindinger (Austria), J. Cornide (Spain), and A. Parra (Cuba).

The mass of materials brought together was so great that, not long after the death of Linnaeus, the necessity made itself felt for collecting them in a compendious form. Several compilers undertook this task; they embodied the recent discoveries in new editions of the classical works of Artedi and Linnaeus, but,

they only succeeded in burying those noble monuments under a chaotic mass of rubbish. For ichthyology it was fortunate that two men at least, Bloch and Lacepède, made it a subject of prolonged original research.

Mark Eliezer Bloch (1723-1799), a physician of Berlin, had reached the age of fifty-six when he began to write on ichthyological subjects. His work consists of two divisions:—

(1) *Öconomische Naturgeschichte der Fische Deutschlands* (Berl., 1782-1784); (2) *Naturgeschichte der ausländischen Fische* (Berl., 1785-1795). The first division, which is devoted to a description of the fishes of Germany, is entirely original. His descriptions as well as figures were made from nature, and are, with few exceptions, still serviceable; indeed many continue to be the best existing in literature. Bloch was less fortunate, and is much less trustworthy, in his natural history of foreign fishes. For many of the species he had to trust to more or less incorrect drawings and descriptions by travellers; frequently, also, he was deceived as to the origin of specimens which he purchased. Hence his accounts contain numerous errors, which it would have been difficult to correct had not nearly the whole of the materials on which his work is based been preserved in the collections at Berlin.

After the completion of his great work Bloch prepared a general system of fishes, in which he arranged not only those previously described, but also those with which he had afterwards become acquainted. The work was ably edited and published after Bloch's death by a philologist, J. G. Schneider, under the title *M. E. Blochii Systema ichthyologiae iconibus ex illustratum* (Berl., 1801). The number of species enumerated amounts to 1510. The system is based upon the number of the fins, the various orders being termed *Hendecapterygii*, *Decapterygii*, &c. An artificial method like this led to the most unnatural combinations and distinctions.

Bloch's *Naturgeschichte* remained for many years the standard work. But as regards originality of thought Bloch was far surpassed by his contemporary, B. G. E. de Lacepède, born at Agen, in France, in 1756, who became professor at the museum of natural history in Paris, where he died in 1825.

Lacepède had to contend with great difficulties in the preparations of his *Histoire des poissons* (Paris, 1798-1803, 5 vols.), which was written during the most disturbed period of the French Revolution. A great part of it was composed whilst the author was separated from collections and books, and had to rely on his notes and manuscripts only. Even the works of Bloch and other contemporaneous authors remained unknown or inaccessible to him for a long time. His work, therefore, abounds in the kind of errors into which a compiler is liable to fall. Thus the influence of Lacepède on the progress of ichthyology was vastly less than that of his fellow-labourer; and the labour laid on his successors in correcting numerous errors probably outweighed the assistance which they derived from his work.

The work of the principal students of ichthyology in the period between Ray and Lacepède was chiefly systematizing and describing; but the internal organization of fishes also received attention from more than one great anatomist. Albrecht von Haller, Peter Camper and John Hunter examined the nervous system and the organs of sense; and Alexander Monro, *secundus*, published a classical work, *The Structure and Physiology of Fishes Explained and Compared with those of Man and other Animals* (Edin., 1785). The electric organs of fishes (*Torpedo* and *Gymnotus*) were examined by Réaumur, J. N. S. Allamand, E. Bancroft, John Walsh, and still more exactly by J. Hunter. The mystery of the propagation of the eel formed rather a large number of essays, and even the artificial propagation of *Salmonidae* was known and practised by J. G. Giedtsch (1764).

Bloch and Lacepède's works were almost immediately succeeded by the labours of Cuvier, but his early publications were tentative, preliminary and fragmentary, so that some little time elapsed before the spirit infused into ichthyology by this great anatomist could exercise its influence on all the workers in this field.



Aristotle's information on the habits of fishes, their migrations, mode and time of propagation, and economic uses is, so far as it has been tested, surprisingly correct. Unfortunately, we too often lack the means of recognizing the species of which he gives a description. His ideas of specific distinction were as vague as those of the fishermen whose nomenclature he adopted; it never occurred to him that vernacular names are subject to change, or may be entirely lost in course of time, and the difficulty of identifying his species is further increased by the circumstance that sometimes several popular names are applied by him to the same fish, or different stages of growth are designated by distinct names. The number of fishes known to Aristotle seems to have been about one hundred and fifteen, all of which are inhabitants of the Aegean Sea.

That one man should have laid so sure a basis for future progress in zoology is less surprising than that for about eighteen centuries a science which seemed to offer particular attractions to men gifted with power of observation was no further advanced. Yet such is the case. Aristotle's successors remained satisfied to be his copiers or commentators, and to collect fabulous stories or vague notions. With few exceptions (such as Ausonius, who wrote a small poem, in which he describes from his own observations the fishes of the Moselle) authors abstained from original research; and it was not until about the middle of the 16th century that ichthyology made a new step in advance by the appearance of Belon, Rondelet and Salviani, who almost simultaneously published their great works, by which the idea of species was established.

P. Belon travelled in the countries bordering on the eastern part of the Mediterranean in the years 1547-1550; he collected **Belon**. rich stores of positive knowledge, which he embodied in several works. The one most important for the progress of ichthyology is that entitled *De aquatilibus libri duo* (Paris, 1553). Belon knew about one hundred and ten fishes, of which he gives rude but generally recognizable figures. Although Belon rarely gives definitions of the terms used by him, it is not generally very difficult to ascertain the limits which he intended to assign to each division of aquatic animals. He very properly divides them into such as are provided with blood and those without it—two divisions corresponding in modern language to vertebrate and invertebrate aquatic animals. The former are classified by him according to size, the further subdivisions being based on the structure of the skeleton, mode of propagation, number of limbs, form of the body and physical character of the habitat.

The work of the Roman ichthyologist H. Salviani (1514-1572), bears evidence of the high social position which the author **Salviani**. held as physician to three popes. Its title is *Aquatilium animalium historia* (Rome, 1554-1557, fol.). It treats exclusively of the fishes of Italy. Ninety-two species are figured on seventy-six plates, which, as regards artistic execution, are masterpieces of that period, although those specific characteristics which nowadays constitute the value of a zoological drawing were overlooked by the author or artist. No attempt is made at a natural classification, but the allied forms are generally placed in close proximity. The descriptions are equal to those given by Belon, entering much into the details of the economy and uses of the several species, and were evidently composed with the view of collecting in a readable form all that might prove of interest to the class of society in which the author moved. Salviani's work is of a high order. It could not fail to render ichthyology popular in the country to the fauna of which it was devoted, but it was not fitted to advance ichthyology as a science generally; in this respect Salviani is not to be compared with Rondelet or Belon.

G. Rondelet (1507-1557) had the great advantage over Belon of having received a medical education at Paris, and especially **Rondelet**. of having gone through a complete course of instruction in anatomy as a pupil of Guentherus of Andernach. This is conspicuous throughout his works—*Libri de piscibus marinis* (Lyons, 1554); and *Universae aquatilium historiae pars altera* (Lyons, 1555). Nevertheless they cannot be regarded

as more than considerably enlarged editions of Belon's work. For, although he worked independently of the latter, the system adopted by him is characterized by the same absence of the true principles of classification. His work is almost entirely limited to European and chiefly to Mediterranean forms, and comprises no fewer than one hundred and ninety-seven marine and forty-seven fresh-water fishes. His descriptions are more complete and his figures much more accurate than those of Belon; and the specific account is preceded by introductory chapters, in which he treats in a general manner of the distinctions, the external and internal parts, and the economy of fishes. Like Belon, he had no conception of the various categories of classification—confounding throughout his work the terms "genus" and "species," but he had an intuitive notion of what his successors called a "species," and his principal object was to give as much information as possible regarding such species.

For nearly a century the works of Belon and Rondelet continued to be the standard works on ichthyology; but the science did not remain stationary during that period. The attention of naturalists was now directed to the fauna of foreign countries, especially of the Spanish and Dutch possessions in the New World; and in Europe the establishment of anatomical schools and academies led to careful investigation of the internal anatomy of the most remarkable European forms. Limited as these efforts were as to their scope, they were sufficiently numerous to enlarge the views of naturalists, and to destroy that fatal dependence on preceding authorities which had kept in bonds even Rondelet and Belon. The most noteworthy of those engaged in these inquiries in tropical countries were W. Piso and G. Marcgrave, who accompanied as physicians the Dutch governor, Count Maurice of Nassau, to Brazil (1630-1644).

Of the men who left records of their anatomical researches, we may mention Borelli (1608-1679), who wrote a work *De motu animalium* (Rome, 1680, 4to), in which he explained the mechanism of swimming and the function of the air-bladder; M. Malpighi (1628-1694), who examined the optic nerve of the sword-fish; the celebrated J. Swammerdam (1637-1680), who described the intestines of numerous fishes; and J. Duverney (1648-1730), who investigated in detail the organs of respiration.

A new era in the history of ichthyology commences with Ray, Willughby and Artedi, who were the first to recognize the true principles by which the natural affinities of animals should be determined. Their labours stand in so intimate a connexion with each other that they represent but one great step in the progress of this science.

J. Ray (1628-1705) was the friend and guide of F. Willughby (1635-1672). They found that a thorough reform in the method of treating the vegetable and animal kingdoms had become necessary; that the only way of bringing **Ray and Willughby**. order into the existing chaos was by arranging the various forms according to their structure. They therefore substituted facts for speculation, and one of the first results of this change, perhaps the most important, was that, having recognized "species" as such, they defined the term and fixed it as the starting-point of all sound zoological knowledge.

Although they had divided their work so that Ray attended to the plants principally, and Willughby to the animals, the *Historia piscium* (Oxf., 1686), which bears Willughby's name on the title-page and was edited by Ray, is their joint production. A great part of the observations contained in it were collected during the journeys they made together in Great Britain and in the various countries of Europe.

By the definition of fishes as animals with blood, breathing by gills, provided with a single ventricle of the heart, and either covered with scales or naked, the Ceteaceans are excluded. The fishes proper are arranged primarily according to the cartilaginous or the osseous nature of the skeleton, and then subdivided according to the general form of the body, the presence or the absence of ventral fins, the soft or the spinous structure of the dorsal rays, the number of dorsal fins, &c. No fewer than four hundred and twenty species are thus arranged and described, of which about one hundred and eighty were known to the

The *Descriptions and Figures of Two Hundred Fishes collected at Yagapatom on the Coast of Coromandel* (Lond., 1803, 2 vols.) by Patrick Russel, and *An Account of the Fishes found in the River Ganges and its Branches* (Edin., 1822, 2 vols.) by F. Hamilton (formerly Buchanan), were works distinguished by greater accuracy of the drawings (especially the latter) than was ever attained before. A *Natural History of British Fishes* was published by E. Donovan (Lond., 1802-1808); and the Mediterranean fauna formed the study of the lifetime of A. Risso, *Ichthyologie de Nice* (Paris, 1810); and *Histoire naturelle de l'Europe méridionale* (Paris, 1827). A slight beginning in the description of the fishes of the United States was made by Samuel Latham Mitchell (1764-1831), who published, besides various papers, a *Memoir on the Ichthyology of New York*, in 1815.

G. Cuvier (1769-1832) devoted himself to the study of fishes with particular predilection. The investigation of their anatomy, and especially of their skeleton, was continued until **Cuvier** he had succeeded in completing so perfect a framework of the system of the whole class that his immediate successors required only to fill up those details for which their master had had no leisure. He ascertained the natural affinities of the infinite variety of forms, and accurately defined the divisions, orders, families and genera of the class, as they appear in the various editions of the *Régne Animal*. His industry equalled his genius; he formed connections with almost every accessible part of the globe; and for many years the museum of the Jardin des Plantes was the centre where all ichthyological treasures were deposited. Thus Cuvier brought together a collection which, as it contains all the materials on which his labours were based, must still be considered as the most important. Soon after the year 1820, Cuvier, assisted by one of his pupils, A. Valenciennes, commenced his great work on fishes, *Histoire naturelle des Poissons*, of which the first volume appeared in 1828. After Cuvier's death in 1832 the work was left entirely in the hands of Valenciennes, whose energy and interest gradually slackened, rising to their former pitch in some parts only, as, for instance, in the treatise, on the herring. He left the work unfinished with the twenty-second volume (1848), which treats of the Salmonoids. Yet, incomplete as it is, it is indispensable to the student.

The system finally adopted by Cuvier is the following:—

A. POISSONS OSSEUX.

I. A BRANCHES EN PEIGNES OU EN LAMES.

1. A Mâchoire Supérieure Libre.

a. Acanthoptérygiens.

Percoïdes.	Sparoïdes.	Branches labyrinthiques.
Polynèmes.	Chétodontoïdes.	Lophoïdes.
Mulles.	Scombroïdes.	Gobioides.
Joues cuirassées.	Muges.	Labroides.
Sciénoïdes.		

b. Malacoptérygiens.

Abdominaux.	Subbrachiens.	Afodes.
Cyprinoides.	Gadoïdes.	Murénoïdes.
Siluroïdes.	Pleuronectes.	
Salmonoides.	Discoboles.	
Clupéoides.		
Lucioïdes.		

2. A Mâchoire Supérieure Fixée.

Sclérodermes. Gymnodontes.

II. A BRANCHES EN FORME DE HOUPPES.

Lophobranches.

B. CARTILAGINEUX OU CHONDROPTÉRYGIENS.

Sturioniens. Plagiostomes. Cyclostomes.

We have only to compare this system with that of Linnaeus if we wish to measure the gigantic stride made by ichthyology during the intervening period of seventy years. The various characters employed for classification have been examined throughout the whole class, and their relative importance has been duly weighed and understood. The important category of "family" appears now in Cuvier's system fully established as intermediate between genus and order. Important changes in Cuvier's system have been made and proposed by his successors, but in the main it is still that of the present day.

Cuvier had extended his researches beyond the living forms, into the field of palaeontology; he was the first to observe the close resemblance of the scales of the fossil *Palaeoniscus* to those

of the living *Polypterus* and *Lepidosteus*, the prolongation and identity of structure of the upper caudal lobe in *Palaeoniscus* and the sturgeons, the presence of peculiar "fulcra" on the anterior margin of the dorsal fin in *Palaeoniscus* and *Lepidosteus*, and inferred from these facts that the fossil genus was allied either to the sturgeons or to *Lepidosteus*. But it did not occur to him that there was a close relationship between those recent fishes. *Lepidosteus* and, with it, the fossil genus remained in his system a member of the order of *Malacopterygii abdominales*.

It was left to L. Agassiz (1807-1873) to point out the importance of the structure of the scales as a characteristic, and to open a path towards the knowledge of a whole new subclass of fishes, the *Ganoidei*. Impressed with the fact that the peculiar scales of *Polypterus* and *Lepidosteus* are common to all fossil osseous fishes down to the Chalk, he takes the structure of the scales generally as the base for an ichthyological system, and distinguishes four orders:—

1. *Placoides*.—Without scales proper, but with scales of enamel, sometimes large, sometimes small, and reduced to mere points (Rays, Sharks and Cyclostomi, with the fossil *Hybodontes*). 2. *Ganoidei*.—With angular bony scales, covered with a thick stratum of enamel: to this order belong the fossil *Lepidosteus*, *Sauroïdes*, *Pycnodontes* and *Coelacanthi*; the recent *Polypterus*, *Lepidosteus*, *Sclerodermi*, *Gymnodontes*, *Lophobranches* and *Siluroïdes*; also the *Sturgeons*. 3. *Ctenoides*.—With rough scales, which have their free margins denticulated: *Chaetodontidae*, *Pleuronectidae*, *Percidae*, *Polyacanthi*, *Sciaenidae*, *Sparidae*, *Scorpenidae*, *Aulostomi*. 4. *Cycloïdes*.—With smooth scales, the hind margin of which lacks denticulation: *Labridae*, *Mugilidae*, *Scombridae*, *Gadoïde*, *Gobiidae*, *Muraenidae*, *Lucioïde*, *Salmonidae*, *Clupeidae*, *Cyprinidae*.

If Agassiz had had an opportunity of acquiring a more extensive and intimate knowledge of existing fishes before his energies were absorbed in the study of fossil remains, he would doubtless have recognized the artificial character of his classification. The distinctions between cycloid and ctenoid scales, between placoid and ganoid fishes, are vague, and can hardly be maintained. So far as the living and post-Cretaceous forms are concerned, he abandoned the vantage-ground gained by Cuvier; and therefore his system could never supersede that of his predecessor, and finally shared the fate of every classification based on the modifications of one organ only. But Agassiz opened an immense new field of research by his study of the infinite variety of fossil forms. In his principal work, *Recherches sur les poissons fossiles*, Neuchâtel, 1833-1843, 4to, atlas in fol., he placed them before the world arranged in a methodical manner, with excellent descriptions and illustrations. His power of discernment and penetration in determining even the most fragmentary remains is astonishing; and, if his order of *Ganoïdes* is an assemblage of forms very different from what is now understood by that term, he was the first who recognized that such an order of fishes exists.

The discoverer of the *Ganoïde* was succeeded by their explorer Johannes Müller (1801-1858). In his classical memoir *Über den Bau und die Grenzen der Ganoïden* (Berl., 1846) he showed that the *Ganoïdes* differ from all the other osseous fishes, and agree with the *Plagiostomes*, in the structure of the heart. By this primary character, all heterogeneous elements, as *Siluroïdes*, *Osteoglossidae*, &c., were eliminated from the order as understood by Agassiz. On the other hand, he did not recognize the affinity of *Lepidosiren* to the *Ganoïdes*, but established for it a distinct subclass, *Dipnoi*, which he placed at the opposite end of the system. By his researches into the anatomy of the lampreys and *Amphioxus*, their typical distinctness from other cartilaginous fishes was proved; they became the types of two other subclasses, *Cyclostomi* and *Leptocardii*.

Müller proposed several other modifications of the Cuvierian system; and, although all cannot be maintained as the most natural arrangements, yet his researches have given us a much more complete knowledge of the organization of the *Teleostean* fishes, and later inquiries have shown that, on the whole, the combinations proposed by him require only some further modification and another definition to render them perfectly natural.

The discovery (in the year 1871) of a living representative of a genus hitherto believed to be long extinct, *Ceratodus*, threw a new light on the affinities of fishes. The writer of the present article, who had the good fortune to examine this fish, was enabled to show that, on the one hand, it was a form most closely allied to *Lepidosiren*, and, on the other, that it could not be separated from the Ganoid fishes, and therefore that *Lepidosiren* also was a Ganoid,—a relation already indicated by Huxley in a previous paper on "Devonian Fishes."

Having followed the development of the ichthyological system down to this period, we now enumerate the most important contributions to ichthyology which appeared contemporaneously with or subsequently to the publication of the great work of Cuvier and Valenciennes. For the sake of convenience we may arrange these works under two heads.

#### I. VOYAGES, CONTAINING GENERAL ACCOUNTS OF ZOOLOGICAL COLLECTIONS

- A. French.—1. *Voyage autour du monde sur les corvettes de S. M. l'Uranie et la Physicienne, sous le commandement de M. Freycinet, Zoologie—Poissons*, par Quoy et Gaimard (Paris, 1824). 2. *Voyage de la Coquille, Zoologie*, par Lesson (Paris, 1825-1830). 3. *Voyage de l'Astrolabe, sous le commandement de M. J. Dumont d'Urville, Poissons*, par Quoy et Gaimard (Paris, 1834). 4. *Voyage au Pôle Sud par M. J. Dumont d'Urville, Poissons*, par Hombron et Jacquinot (Paris, 1853-1854).  
B. English.—1. *Voyage of H. M. S. Sulphur, "Fishes"* by J. Richardson (London, 1844-1845). 2. *Voyage of H. M. S. Erebus and Terror, "Fishes"* by J. Richardson (London, 1845). 3. *Voyage of H. M. S. Beagle, "Fishes"* by L. Jenyns (London, 1842).  
C. German.—1. *Reise der österreichischen Fregate Novara, "Fische"*, von R. Kner (Vienna, 1865).

#### II. FAUNA

- A. Great Britain.—1. R. Parnell, *The Natural History of the Fishes of the Firth of Forth* (Edin., 1838). 2. W. Yarrell, *A History of British Fishes* (3rd ed., London, 1859). 3. J. Couch, *History of the Fishes of the British Islands* (London, 1862-1865).  
B. Denmark and Scandinavia.—1. H. Krøyer, *Danmark's Fiske* (Copenhagen, 1838-1853). 2. S. Nilsson, *Skandinavisk Fauna*, vol. iv., "Fiskarna" (Lund, 1855). 3. Fries och Ekström, *Skandinavisk Fiskar* (Stockh., 1836).  
C. Russia.—1. Nordmann, "Ichthyologie pontique," in *Demi-doff's Voyage dans la Russie méridionale*, tome iii. (Paris, 1840).  
D. Germany.—1. Heckel and Kner, *Die Süßwasserfische der österreichischen Monarchie*, Leipzig, 1858. 2. C. T. E. Siebold, *Die Süßwasserfische von Mitteleuropa*, (Leipzig, 1863).  
E. Italy and Mediterranean.—1. Bonaparte, *Iconografia della fauna italiana*, tom. iii., "Pesci" (Rome, 1832-1841). 2. Costa, *Fauna del regno di Napoli, "Pesci"* (Naples, about 1850).  
F. France.—1. E. Blanchard, *Les Poissons des eaux douces de la France* (Paris, 1866).  
G. Spanish Peninsula.—The fresh-water fish fauna of Spain and Portugal was almost unknown, until F. Steindachner paid some visits to those countries for the purpose of exploring the principal rivers. His discoveries were described in several papers in the *Sitzungsberichte der Akademie zu Wien*. B. du Bouage and F. de B. Capello made contributions to our knowledge of the marine fishes on the coast of Portugal (*Journ. Scienc. Acad. Lish.*).  
H. North America.—1. J. Richardson, *Fauna Boreali-Americana*, part iii., "Fishes" (London, 1836). The species described in this work are nearly all from the British possessions in the north. 2. DeKay, *Zoology of New York*, part iv., "Fishes" (New York, 1842). 3. Reports of the U. S. Comm. of Fish and Fisheries (5 vols., Washington, 1873-1879) and Reports and special publications of the U. S. Bureau of Fisheries contain valuable information. Numerous descriptions of North American fresh-water fishes have been published in the reports of the various U. S. Government expeditions, and in North American scientific journals. In J. H. Storer, S. F. Baird, C. Girard, W. O. Ayres, E. D. Cope, D. S. Jordan, G. Brown Goode, &c.  
I. Japan.—1. *Fauna Japonica, "Poissons"*, par H. Schlegel, (Leiden, 1850).  
J. East Indies; Tropical parts of the Indian and Pacific Oceans.—1. E. Rüppell, *Atlas zur Reise im nördlichen Afrika* (Frankf., 1828). 2. E. Rüppell, *Neu Wirbelthiere, "Fische"* (Frankf., 1837). 3. R. L. Playfair and A. Günther, *The Fishes of Zanzibar* (London, 1845). 4. Klunzinger, *Die Fische der Rother Meer*, (Vienna, 1870-1871). 5. F. Day, *The Fishes of India* (London, 1865, 4to) contains an account of the fresh-water and marine species. 6. A. Günther, *Die Fische der Südzee* (Hamburg, 4to), from 1873 (in progress). 7. Unsurpassed in activity, as regards the exploration of the fish fauna of the East Indian archipelago, is P. Bleeker (1819-1878), a surgeon in the service of the Dutch East Indian Government, who, from the year 1840, for nearly thirty years, acquired immense collections of the fishes of the various islands, and described them in extremely numerous papers, published chiefly

in the journals of the Batavian Society. Soon after his return to Europe (1860) Bleeker commenced to collect the final results of his labours in a grand work, illustrated by coloured plates, *Atlas ichthyologique des Indes Orientales Néerlandaises* (Amsterd., fol., 1862), the publication of which was interrupted by the author's death in 1878.

K. Africa.—1. A. Günther, "The Fishes of the Nile," in *Peterkirk's Travels in Central Africa* (London, 1869). 2. W. Peters, *Naturwissenschaftliche Reise nach Mossambique*, iv., "Flussfische" (Berl., 1868, 4to).

L. West Indies and South America.—1. L. Agassiz, *Selecta genera et species piscium, quae in sinere per Brasiliam collegit J. B. de Spix* (Munic., 1829, fol.). 2. F. de Castelnau, *Animaux nouveaux ou rares, recueillis pendant l'expédition dans les parties centrales de l'Australie du Sud, "Poissons"* (Paris, 1855). 3. L. Vaillant and F. Bocour, *Mission scientifique au Mexique et dans l'Amérique centrale, "Poissons"* (Paris, 1874). 4. F. Poey, the celebrated naturalist of Havana, devoted many years of study to the fishes of Cuba. His papers and memoirs are published partly in two periodicals, issued by himself, under the title of *Memorias sobre la historia natural de la isla de Cuba* (from 1851), and *Repertorio fisico-científico de la isla de Cuba* (from 1865), partly in North American scientific journals. And, finally, F. Steindachner and A. Günther have published many contributions, accompanied by excellent figures, to our knowledge of the fishes of Central and South America.

M. New Zealand.—1. F. W. Hutton and J. Hector, *Fishes of New Zealand* (Wellington, 1872).  
N. Arctic Regions.—1. C. Litken, "A Revised Catalogue of the Fishes of Greenland," in *Manual of the Natural History, Geology and Physics of Greenland* (London, 1875, 8vo). 2. The fishes of Spitzbergen were examined by A. J. Malmgren (1865). (A. C. G.)

#### II. HISTORY AND LITERATURE FROM 1880

In the systematic account which followed the above chapter in the 6th edition of the *Encyclopaedia Britannica*, the following classification, which is the same as that given in the author's *Introduction to the Study of Fishes* (London, 1880) was adopted by Albert Günther:—

##### Subclass I.: PALAEOICHTHYES.

###### Order I.: Canadonterygii.

With two suborders: Plagiostomata and Holoptera.

###### Order II.: Gadoidei.

With eight suborders: Placodermi, Acanthodini, Dipnoi, Chondrostei, Polypteroidei, Pycnodontoidei, Lepidosteoidae, Amioidae.

##### Subclass II.: TELEOSTEI.

###### Order I.: Acanthopterygii.

With the divisions Perciformes, Beryciformes, Kuriformes, Polymeniformes, Sciaeniformes, Xiphiformes, Trichuriformes, Cotto-Scorombiformes, Gobiiformes, Blenniiformes, Mugiliformes, Gastrosteiformes, Centriciformes, Gobiociformes, Channiformes, Labyrinthibranchii, Lophotiformes, Tacteniformes and Notacanthiformes.

###### Order II.: Acanthopterygii Pharyngognathi.

###### Order III.: Anacanthini.

With two divisions: Gadoidei and Pleuronectoidei.

###### Order IV.: Physostomi.

###### Order V.: Lophobranchii.

###### Order VI.: Plectognathi.

##### Subclass III.: CYCLOSTOMATA.

###### Subclass IV.: LEPTOCARDII.

It was an artificial system, in which the most obvious relationships of the higher groups were lost sight of, and the results of the already fairly advanced study of the fossil forms to a great extent discarded. This system gave rise to much adverse criticism; as T. H. Huxley forcibly put it in a paper published soon after (1883), opposing the division of the main groups into Palaicthytes and Teleostei: "Assuredly, if there is any such distinction to be drawn on the basis of our present knowledge among the higher fishes, it is between the Ganoids and the Plagiostomes, and not between the Ganoids and the Teleostei"; at the same time expressing his conviction, "first, that there are no two large groups of animals for which the evidence of a direct genetic connexion is better than in the case of the Ganoids and the Teleosteans; and secondly, that the proposal to separate the Elasmobranchii (Chondropterygii of Günther), Ganoidi and Dipnoi of Müller into a group apart from, and equivalent to, the Teleostei appears to be inconsistent with the plainest relations of these fishes." This verdict has been endorsed by all subsequent workers at the classification of fishes.

Günther's classification would have been vastly improved

had he made use of a contribution published as early as 1871, but not referred to by him. As not even a passing allusion is made to it in the previous chapter, we must retrace our steps to make good this striking omission. Edward Drinker Cope (1840-1897) was a worker of great originality and relentless energy, who, in the sixties of the last century, inspired by the doctrine of evolution, was one of the first to apply its principles to the classification of vertebrates. Equally versed in recent and fossil zoology, and endowed with a marvellous gift, or "instinct" for perceiving the relationship of animals, he has done a great deal for the advance of our knowledge of mammals, reptiles and fishes. Although often careless in the working out of details and occasionally a little too bold in his deductions, Cope occupies a high rank among the zoologists of the 19th century, and much of his work has stood the test of time.

The following was Cope's classification, 1871 (*Tr. Amer. Philos. Soc.* xiv. 449).

- Subclass I. Holocephali.
- " II. Selachii.
- " III. Dipnoi.
- " IV. Crossopterygia, with two orders:  
        Haplística and Cladística.
- " V. Actinopteri.

The latter is subdivided in the following manner:—

- Tribe I.: Chondrostei.
- Two orders: Selachostomi and Glianostomi.
- Tribe II.: Physostomi.
- Twelve orders: Ginglymodi, Halecomorphi, Nematognathi, Scyphobori, Plectospondyli, Isospondyli, Haplomi, Glanencheli, Ichthycephali, Holostomi, Enchelycephali, Colocephali.
- Tribe III.: Physoclysti.
- Ten orders: Opisthomi, Percecosae, Syntetognathi, Hemi-branchii, Lophobranchii, Pediculati, Heterosomata, Plectognathi, Percomorphi, Pharyngognathi.

Alongside with so much that is good in this classification, there are many suggestions which cannot be regarded as improvements on the views of previous workers. Attaching too great an importance to the mode of suspension of the mandible, Cope separated the Holocephali from the Selachii and the Dipnoi from the Crossopterygia, thus obscuring the general agreement which binds these groups to each other, whilst there is an evident want of proportion in the five subclasses. The exclusion from the class Pisces of the Leptocardi, or lancelets, as first advocated by E. Haeckel, was a step in the right direction, whilst that of the Cyclostomes does not seem called for to such an authority as R. H. Traquair, with whom the writer of this review entirely concurs.

The group of Crossopterygians, first separated as a family from the other Ganoids by Huxley, constituted a fortunate innovation, and so was its division into two minor groups, by which the existing forms (*Polypteroidei*) were separated as Cladística. The divisions of the Actinopteri, which includes all Teleostomes other than the Dipneusti and Crossopterygia also showed, on the whole, a correct appreciation of their relationships. The Chondrostei being well separated from the other Ganoids with which they were generally associated. In the groupings of the minor divisions, which Cope termed orders, we had a decided improvement on the Cuvierian-Müllerian classification, the author having utilized many suggestions of his fellow countrymen Theodore Gill, who has done much towards a better understanding of their relationships. In the association of the Characins with the Cyprinids (Plectospondyli) in the separation of the flat-fishes from the Ganoids, in the approximation of the Lophobranchs to the sticklebacks and of the Plectognaths to the Acanthopterygians, and in many other points, Cope was in advance of his time, and it is to be regretted that his contemporaries did not more readily take up any of his excellent suggestions for the improvement of their systems.

In the subsequent period of his very active scientific life, Cope made many alterations to his system, the latest scheme published by him being the following ("Synopsis of the families of Vertebrata," *Amer. Natur.*, 1889, p. 849):—

- Class : **Agnatha.**
- I. Subclass : OSTRACODERMI.
- Orders : Arrhina, Diplorhina.
- II. Subclass : MARSIPBRANCHII.
- Orders : Hyperotreti, Hyperoarti.
- Class : **Pisces.**
- I. Subclass : HOLOCEPHALI.
- II. Subclass : DIPNOI.
- III. Subclass : ELASMOBRANCHII.
- Orders : Ichthyotomi, Selachii.
- IV. Subclass : TELEOSTOMI.
- (i.) Superorder : *Rhipidopterygia.*
- Orders : Rhipidistia, Actinistia.
- (ii.) Superorder : *Crossopterygia.*
- Orders : Placodermi, Haplística, Taxistia, Cladística.
- (iii.) Superorder : *Podopterygia* (Chondrostei).
- (iv.) Superorder : *Actinopterygia.*
- Orders : Physostomi, Physoclysti.

This classification is that followed, with many emendations, by A. S. Woodward in his epoch-making *Catalogue of Fossil Fishes* (4 vols., London, 1889-1901), and in his most useful *Outlines of Vertebrate Paleontology* (Cambridge, 1898), and was adopted by Günther in the 10th edition of the *Encyclopaedia Britannica*:—

- Class : **Agnatha.**
- I. Subclass : CYCLOSTOMI.
- With three orders : (a) *Hyperoartia* (Lampreys); (b) *Hyperotreti* (Myxinoidei); (c) *Cycistae* (Palaeospondylus).
- II. Subclass : OSTRACODERMI.
- With four orders : (a) *Heterostraci* (Coelolepidae, Psammosteidae, Drepanaspidae, Pteraspidae); (b) *Osteostraci* (Cephalaspidae, Ateleaspidae, &c.); (c) *Antiarchi* (Asterolepidae, Pterichthys, Bothrolepis, &c.); (d) *Anaspida* (Birkenidae).
- Class : **Pisces.**
- I. Subclass : ELASMOBRANCHII.
- With four orders : (a) *Pleuropterygia* (Cladoseclache); (b) *Ichthyotomi* (Pleuraacanthidae); (c) *Acanthodii* (Diplacanthidae, and Acanthodidae); (d) *Selachii* (divided from the structure of the vertebral centres into Asterospondyli and Tetraspondyli).
- II. Subclass : HOLOCEPHALI.
- With one order : *Chimaeridae*.
- III. Subclass : DIPNOI.
- With two orders : (a) *Sirenoidei* (Lepidosiren, Ceratodus, Uronemidae, Ctenodontidae); (b) *Arthrodira* (Homosteus, Coccosteus, Dinichthys).
- IV. Subclass : TELEOSTOMI.
- A. Order : *Crossopterygia*.
- With four suborders : (1) *Haplística* (Tarassius); (2) *Rhipidistia* (Holoptychidae, Rhizodontidae, Osteolepidae); (3) *Actinistia* (Coelacanthidae); (4) *Cladística* (Polypterus).
- B. Order : *Actinopterygia*.
- With about twenty suborders : (1) *Chondrostei* (Palaeoniscidae, Platysomidae, Chondrosteidae, Sturgeons); (2) *Protospondyli* (Semionotidae, Macrosemidae, Pycnodontidae, Eugnathidae, Amidae, Pachycormidae); (3) *Aethesopondii* (Aspidorhynchidae, Lepidosteidae); (4) *Isospondyli* (Pholidorhynchidae, Osteoglossidae, Chupidae, Leptolepidae, &c.); (5) *Plectospondyli* (Cyprinidae, Characinae); (6) *Nemalognathi*; (7) *Apodes*; and the other Teleosteans.

There are, however, grave objections to this system, which cannot be said to reflect the present state of our knowledge. In his masterly paper on the evolution of the Dipneusti, L. Dollo has conclusively shown that the importance of the autostyly on which the definition of the Holocephali from the Elasmobranchii or Selachii and of the Dipneusti from the Teleostomi rested, had been exaggerated, and that therefore the position assigned to these two groups in Günther's classification of 1880 still commended itself. Recent work on *Palaeospondylus*, on the Ostracoderms, and on the Arthrodira, throws great doubt on the propriety of the positions given to them in the above classification, and the rank assigned to the main divisions of the Teleostomi do not commend themselves to the writer of the present article, who would divide the fishes into three subclasses:—

#### I. Cyclostomi

#### II. Selachii

#### III. Teleostomi,

the characters and contents of which will be found in separate

articles; in the present state of uncertainty as to their position, *Palaespondylus* and the *Ostracodermi* are best placed *hors cadre* and will be dealt with under these names.

The three subclasses here adopted correspond exactly with those proposed in Theo. Gill's classification of the recent fishes ("Families and Subfamilies of Fishes," *Mem. Nat. Ac. Sci.* vi, 1893), except that they are regarded by that authority as classes.

The period dealt with in this chapter, ushered in by the publication of Günther's *Introduction to the Study of Fishes*, has been one of extraordinary activity in every branch of ichthyology, recent and fossil. A glance at the *Zoological Record*, published by the Zoological Society of London, will show the ever-increasing number of monographs, morphological papers and systematic contributions, which appear year after year. The number of new genera and species which are being proposed is amazing, but it is difficult to tell how many of them will simply go to swell the already overburdened synonymy. Perhaps a reasonable estimate of the living species known at the present day would assess their number at about 13,000.

It is much to be regretted that there is not a single general modern systematic work on fishes. The most important treatises, the 7th volume of the *Cambridge Natural History*, by T. W. Bridge and G. A. Boulenger, and D. S. Jordan's *Guide to the Study of Fishes*, only profess to give definitions of the families with enumerations of the principal genera. Günther's *Catalogue of the Fishes in the British Museum* therefore remains the only general descriptive treatise, but its last volume dates from 1870, and the work is practically obsolete. A second edition of it was begun in 1894, but only one volume, by Boulenger, has appeared, and the subject is so vast that it seems doubtful now whether any one will ever have the time and energy to repeat Günther's achievement. The fish fauna of the different parts of the world will have to be dealt with separately, and it is in this direction that descriptive ichthyology is most likely to progress.

North America, the fishes of which were imperfectly known in 1880, now possesses a *Descriptive Catalogue* in 4 stout volumes, by D. S. Jordan and B. W. Evermann, replacing the synopsis brought out in 1882 by D. S. Jordan and C. H. Gilbert. A similar treatise should embrace all the fresh-water species of Africa, the fishes of the two principal river systems, the Nile and the Congo, having recently been worked out by G. A. Boulenger. Japanese ichthyology has been taken in hand by D. S. Jordan and his pupils.

The fishes of the deep sea have been the subject of extensive monographs by L. Vaillant (*Travailleurs et Talisman*), A. Günther (*Challenger*), A. Alcock (*Investigator*), R. Collett (*Hirondelle*), S. Garman (*Albatross*) and a general résumé up to 1895 was provided in G. B. Goode's and T. H. Bean's *Oceanic Ichthyology*. More than 600 true bathybalial fishes are known from depths of 1000 fathoms and more, and a great deal of evidence has been accumulated to show the general transition of the surface fauna into the bathybalial.

A recent departure has been the exploration of the Antarctic fauna. Three general reports, on the results of the *Southern Cross*, the *Belgica* and the Swedish *South Polar* expeditions, had already been published in 1907, and others on the *Scottia* and *Discovery* were in preparation. No very striking new types of fishes have been discovered, but the results obtained are sufficient to entirely disprove the theory of bipolarity which some naturalists had advocated. Much has been done towards ascertaining the life-histories of the fishes of economic importance, both in Europe and in North America, and our knowledge of the larval and post-larval forms has made great progress.

Wonderful activity has been displayed in the field of paleontology, and the careful working out of the morphology of the archaic types has led to a better understanding of the general lines of evolution; but it is to be regretted that very little light on the relationships of the living groups of Teleostean has been thrown by the discoveries of paleontologists.

Among the most remarkable additions made in recent years, the work of R. H. Traquair on the problematic fishes *Palaespondylus*, *Thelodus*, *Drepanaspis*, *Lanarkia*, *Aleleaspis*, *Birkenia* and *Lanauis*, ranks foremost; next to it must be placed the researches of A. S. Woodward and Bashford Dean on the primitive shark *Cladoseleache*, and of the same authors, J. S. Newberry, C. R. Eastman, E. W. Claypole and L. Hussakof, on the Arthrodira, a group the affinities of which have been much discussed.

**AUTHORITIES.**—The following selection from the extremely extensive ichthyological literature which has appeared during the period 1880–1906 will supplement the bibliographical notice appended to section I. **I. THE GENERAL SUBJECT:** A. Günther, *Introduction to the Study of Fishes* (Edinburgh, 1880); B. Dean, *Fishes Living and Fossil* (New York, 1895); T. W. Bridge and G. A. Boulenger, *Fishes*, *Cambridge Natural History*, vii, (1904); D. S. Jordan, *Guide to the Study of Fishes* (2 vols., New York, 1905); H. P. Bland, *Zoological*; A. Fritsch, *Fauna der Gaskelne und der Gaskelne der Permformation Böhmens* (vols. i–iii., Prague, 1879–1894); K. A. von Zittel, *Handbuch der Paläozoologie*, vol. iii. (Munich, 1887); A. Smith Woodward, *Catalogue of Fossil Fishes in the British Museum*, vols. i–iii. (London, 1889–1895); A. Smith Woodward, *Outlines of Vertebrate Palaeontology for Students of Zoology* (Cambridge, 1928); J. S. Newberry, "The Palaeozoic Fishes of North America," *Mon. U.S. Geol. Surv.* vol. xvi. (1889); J. V. Rohon, "Die oberjurassischen Fische von Ösel, Thysitidae und Tremataspidae," *Mém. Ac. Imp. Sc. St-Petersb.* xxxvii. (1892); O. Jaekel, *Die Seelischer vom Bolca, ein Beitrag zur Morphologie der Wirbeltiere* (Leipzig, 1894); B. Dean, "Contributions to the Morphology of Cladoseleache," *Journ. Morphol.* ix. (1894); R. H. Traquair, "The Asterolepidae," *Mon. Palaeont. Soc.* (1894–1904, in progress); "Report on Fossil Fishes collected by the Geological Survey of Scotland in the Silurian Rocks of the South of Scotland," *Trans. Roy. Soc. Edin.* xxix. (1899); L. Dollo, "Sur la phylogénèse des Dipneustes," *Bull. Soc. Belge Géol.* vol. ix. (1895); E. W. Claypole, "The Ancestry of the Upper Devonian Placoderms of Ohio," *Amer. Geol.* xvii. (1896); B. Dean, "Palaeontological Notes," *Mem. N.Y. Ac. ii.* (1901); A. Stewart and S. W. Williston, "Cretaceous Fishes of Kansas," *Univ. Geol. Surv. Kansas*, vi. (Topeka, 1901); A. S. Woodward, "Fossil Fishes of the English Chalk," *Palaeontolog.* Soc. (1902–1903, etc.); R. H. Traquair, "The Lower Devonian Fishes of Galloway," *Roy. Soc. Edin. Trans.* 40 (1903); W. J. and I. B. J. Sollas, "Account of the Devonian Fish Palaespondylus," *Phil. Trans.* 196 (1903); C. T. Regan, "Phylogeny of the Teleostomi," *Ann. & Mag. N.H.* (7) 13 (1904); C. R. Eastman, "Fishes of Monte Bolca," *Bull. Mus. C.Z.* 46 (1904); "Structure and Relations of Mylostoma," *Op. cit.* 2 (1906); O. Abel, "Fossile Flugfische," *Jahrb. Geol. Reichsanst.* 56 (Wien, 1906); L. Hussakof, "Studies on the Arthrodira," *Mem. Amer. Mus. N.H.* ix. (1906). **III. FAUNISTIC** (recent fishes): (A) EUROPE: E. Bader, *Die mitteleuropäischen Süßwasserfische* (2 vols., Berlin, 1901–1902). **GREAT BRITAIN:** F. Day, *The Fishes of Great Britain and Ireland* (2 vols., London, 1889–1894); J. T. Cunningham, *The Natural History of the Marketable Marine Fishes of the British Islands* (London, 1896); W. C. M'Intosh and A. T. Masterman, *The Life-Histories of the British Marine Food-Fishes* (London, 1897); Sir H. Maxwell, *British Fresh-water Fish* (London, 1904); F. G. Afalro, *British Salt-water Fish* (London, 1904). Numerous important researches into the development, life-conditions and distributions, carried out at the Biological Laboratories at Plymouth and St Andrews and during the survey of the fishing grounds of Ireland, have been published by W. L. Calderwood, J. T. Cunningham, E. W. L. Holt, W. C. M'Intosh, J. W. Fulton, W. Garstang and Prince in the *Journ. Mar. Biol. Assoc.*, *The Reports of the Fishery Board of Scotland*, *Sci. Trans. Dublin Soc.* and *Ann. Mag. Nat. Hist. **DEMARK AND SCANDINAVIA:** W. Liljeborg, *Sveriges och Norges Fiskar* (3 vols., Upsala, 1881–1891); F. A. Smith, *A History of Scandinavian Fishes* by B. Fries, C. U. Ekström and C. Sundevall, with Plates by W. von Wright (second edition, revised and completed by F. A. S., Stockholm, 1892); G. J. Stuxens, *Report of the Danish Biological Station* (Copenhagen, 1802–1900) (annual reports containing much information on fishes and fishing in the Danish seas). (C) FINLAND: G. Sundman and A. J. Mela, *Finland's Fiskar* (Helsingfors, 1883–1891). (D) GERMANY: K. Möbius and F. Heinicke, "Die Fische der Ostsee," *Bericht Commis. Untersuch. Deutsch. Meere* (Kiel, 1883); F. Heinicke, E. Ehrenbaum and G. Düncker have published their investigations into the life-history and development of the fishes of Heligoland in *Wissenschaftl. Meeresuntersuchungen* (Kiel and Leipzig, 1894–1899). (E) SWITZERLAND: V. Fatio, *Faune des vertébrés de la Suisse: Poissons* (2 vols., Geneva and Basel, 1882–1890). (F) FRANCE: E. Moreau, *Histoire naturelle des poissons de la France* (3 vols., Paris, 1881); *Supplément* (Paris, 1891). (G) PYRENEAN PENINSULA: D. Carlos de Braganca, *Resultados das investigações scientificas feitas a bordo do yacht "Amélia." Pescas maritimas, i.* and *ii.* (Lisbon, 1890–1904). (H) ITALY AND MEDITERRANEAN: P. Döderlein, *Manuale italo-gero del Mediterraneo* (Palermo, 1881–1891, not completed; interrupted*

by the death of the author); E. W. L. Holt, "Recherches sur la reproduction des poissons osseux, principalement dans le golfe de Marseille," *Ann. Mus. Mars. v.* (Marseilles, 1899); (I) WESTERN AND CENTRAL ASIA: L. Lortet, "Poissons et reptiles du lac de Tibériade," *Arch. Mus. d'Hist. Nat. Lyon*, iii. (1883); S. Herzstein, *Wissenschaftliche Resultate der von N. M. Przewalski nach Central Asien unternommenen Reisen: Fische* (St Petersburg, 1888-1891); L. Berg, *Fishes of Turkestan* (Russian text, St Petersburg, 1905); G. Radde, S. Kamensky and F. Kawrasky, have worked out the Cyprinids and Salmonids of the Caucasus (Tiflis, 1896-1899). (II) JAPAN: F. Steindachner and L. Döderlein, *Beiträge zur Kenntnis der Fische Japans*, "Denkschr. Ak. Wien," (vols. 57 and 68, 1883); K. Otaki, T. Fujita and T. Higurashi, *Fishes of Japan* (in Japanese) (Tokyo, 1903, in progress). Numerous papers by D. S. Jordan, in collaboration with E. O. Snyder, E. C. Starks, H. W. Fowler and N. Sindo. (K) EAST INDIES: F. Day, *The Fauna of British India: Fishes* (2 vols., London, 1889) (chiefly an abridgment of the author's *Fishes of India*); M. Weber, "Die Süßwasserfische des Indischen Archipels," *Zool. Ergebnisse e. Reise in Niederl. Ostind.* iii. (Leiden, 1894). Numerous contributions to the fauna of the Malay Peninsula and Archipelago by G. A. Boulenger, L. Vaillant, F. Steindachner, G. Dunder, W. Voelz and C. L. Poey, (L) ASHMOLEY: G. A. Boulenger, *Matériaux pour la faune du Congo: poissons nouveaux* (Brussels, 1898-1902, in progress); and *Poissons du bassin du Congo* (Brussels, 1901); G. Pfeffer, *Die Thierwelt Ostafrikas: Fische* (Berlin, 1896); A. Günther, G. A. Boulenger, G. Pfeffer, F. Steindachner, D. Vinciguerra, J. Pellegrin and E. Lönnberg have published numerous contributions to the fish-fauna of tropical Africa in various periodicals. The marine fishes of South Africa have received special attention on the part of J. D. F. Gilchrist, *Marine Investigations in South Africa*, I. and II. (1898-1904), and new species have been described by G. A. Boulenger and C. T. Regan. (M) NORTH AMERICA: D. S. Jordan and B. W. Evermann, *The Fishes of North and Middle America* (4 vols., Washington, 1896-1900); D. S. Jordan and B. W. Evermann, *American Food and Game Fishes* (New York, 1902); D. S. Jordan and C. H. Gilbert "The Fishes of Bering Sea," in *Fur-Seals and Fur-Seal Islands* (Washington, 1899); The U.S. Bureau of Fisheries (since 1903) has published annually a *Report* and a *Bulletin*, containing a vast amount of information on North American fishes and every subject having a bearing on the fisheries of the United States; S. E. Meeck, "Fresh-water Fishes of Mexico," *Field Columb. Mus. Zool. v.* (1904). (N) SOUTH AMERICA: C. H. and R. S. Eigenmann, "A Catalogue of the Fresh-water Fishes of South America," *Proc. U.S. Nat. Mus.* 14 (Washington, 1901); the same authors, F. Steindachner, G. A. Boulenger, C. Berg and C. T. Regan have published contributions in periodicals on this fauna. (O) AUSTRALIA: J. E. Tenison-Woods, *Fish and Fisheries of New South Wales* (Sydney, 1882); J. Douglas Ogilby, *Edible Fishes and Crustaceans of New South Wales* (Sydney, 1893); J. Douglas Ogilby and E. R. Waite are authors of numerous papers on Australian fishes in *Proc. Linn. Soc. N.S. Wales and Rec. Austral. Mus.* (P) SOUTH PACIFIC: D. S. Jordan and B. W. Evermann, "Shore Fishes of the Hawaiian Islands," *Bull. U.S. Fish. Comm.* 23 (1905). (Q) MADAGASCAR: H. E. Sauvage, *Histoire physique, naturelle et politique de Madagascar*, A. Grandidier, xvi. *Poissons* (Paris, 1891). (R) OCEANIC FISHERIES: G. B. Goode and T. H. Bean, *Oceanic Ichthyology* (Washington, 1895); A. Günther, *Deep-sea Fishes of the "Challenger" Expedition* (London, 1887); C. H. Gilbert, "Deep-sea Fishes of the Hawaiian Islands," *Bull. U.S. Fish. Comm.* 23 (1905); R. Collett, *Norske Nordhavs Expedition: Fiske* (Christiania, 1880); C. F. Lütken, *Djibphna-Toglets Zoologisk-botaniske Udbytte: Kara-Havets Fiske* (Copenhagen, 1886); L. Vaillant, *Expéditions scientifiques du "Traveller" et du "Talisman": Poissons* (Paris, 1888); A. Agassiz, *Three Cruises of the U.S. Coast and Geodetic Survey Steamer "Blake"* (Boston and New York, 1888); A. Alcock, *Illustrations of the Zoology of H.M.S. "Investigator"* (Calcutta, 1892-1893, in progress); A. Alcock, *Descriptive Catalogue of the Indian Deep-sea Fishes in the Indian Museum* (Calcutta, 1899, contains references to all the previous papers of the author on the subject); R. Collett, *Résultats des campagnes scientifiques accomplies par Albert Ier prince de Monaco: poissons provenant des campagnes du yacht "L'Irondele"*, (Monaco, 1896); R. Koehler, *Résultats scientifiques de la campagne du "Caudan"*, (Paris, 1896); C. H. Gilbert and F. Cramer, "Report on the Fishes dredged in Deep Water near the Hawaiian Islands," *Proc. U.S. Nat. Mus.* xix. (Washington, 1896); C. Lütken, *Spolia Atlantica*, "Vidensk. Selsk. Skr. v.ii. and xi. (Copenhagen, 1892-1898); C. Lütken, *Danish Golf Expedition. II: Ichthyological Results* (Copenhagen, 1898); S. Garman, "Reports on an Exploration of the West Coast of Mexico, Central and South America, and off the Galapagos Islands in charge of Alexander Agassiz, by the U.S. Fish Commission Steamer "Albatross," during 1891," *Mem. Mus. Comp. Zool.* vol. xvii. (Cambridge, U.S.A., 1899). (S) ANTARCTIC FISHERIES: G. A. Boulenger, *Report on the Collections made during the voyage of the "Southern Cross": Fishes* (London, 1902); L. Dollo, *Expédition Antarctique Belge* (S.Y. "Belgica"). *Poissons* (Antwerp, 1904); E. Lönnberg, *Swedish South Polar Expedition: Fishes* (Stockholm, 1905); G. A. Boulenger, *Fishes of the "Discovery" Antarctic Expedition* (London, 1906).

(G. A. B.)

### III. DEFINITION OF THE CLASS *Pisces*. ITS PRINCIPAL DIVISIONS

Fishes, constituting the class *Pisces*, may be defined as Craniata Vertebrata, or Chordata, in which the anterior portion of the central nervous system is expanded into a brain surrounded by an unsegmented portion of the axial skeleton; which are provided with a heart, breathing through gills; and in which the limbs, if present, are in the form of fins, as opposed to the pentadactyle, structure common to the other Vertebrata. With the exception of a few forms in which lungs are present in addition to the gills, thus enabling the animal to breathe atmospheric air for more or less considerable periods (Dipneusti), all fishes are aquatic throughout their existence.

In addition to the paired limbs, median fins are usually present, consisting of dermal rays borne by endoskeletal supports, which in the more primitive forms are strikingly similar in structure to the paired fins that are assumed to have arisen from the breaking up of a lateral fold similar to the vertical folds out of which the dorsal, anal and caudal fins have been evolved. The body is naked, or scaly, or covered with bony shields or hard spines.

Leaving aside the Ostracophori, which are dealt with in a separate article, the fishes may be divided into three subclasses:

I. Cyclostomi or Marsipobranchii, with the skull imperfectly developed, without jaws, with a single nasal aperture, without paired fins, and with an unpaired fin without dermal rays. Lampreys and hag-fishes.

II. Selachii or Chondropterygii, with the skull well developed but without membrane bones, with paired nasal apertures, with median and paired fins, the ventrals bearing prehensile organs (claspers) in the males. Sharks, skates and chimaeras.

III. Teleostomi, with the skull well developed and with membrane bones, with paired nasal apertures, primarily with median and paired fins, including all other fishes. (G. A. B.)

### IV. ANATOMY<sup>1</sup>

The special importance of a study of the anatomy of fishes lies in the fact that fishes are on the whole undoubtedly the most archaic of existing craniates, and it is therefore to them especially that we must look for evidence as to the evolutionary history of morphological features occurring in the higher groups of vertebrates.

In making a general survey of the morphology of fishes it is essential to take into consideration the structure of the young developing individual (embryology) as well as that of the adult (comparative anatomy in the narrow sense). Paleontology is practically dumb excepting as regards external form and skeletal features, and even of these our knowledge must for long be in a hopelessly imperfect state. While it is of the utmost importance to pay due attention to embryological data it is equally important to consider them critically and in conjunction with broad morphological considerations. Taken by themselves they are apt to be extremely misleading.

*External Features.*—The external features of a typical fish are intimately associated with its mode of life. Its shape is more or less that of a spindle; its surface is covered with a highly glandular epidermis, which is constantly producing lubricating mucus through the agency of which skin-friction is reduced to an extraordinary degree; and finally it possesses a set of remarkable propelling organs or fins.

The exact shape varies greatly from the typical spindle shape with variations in the mode of life; e.g. bottom-living fishes may be much flattened from above downwards as in the rays, or from side to side in the Pleuronectids such as flounder, plaice or sole, or the shape may be much elongated as in the eels.

*Head, Trunk and Tail.*—In the body of the fish we may recognize the three main subdivisions of the body—head, trunk and tail—as in the higher vertebrates, but there is no definite narrowing of the anterior region to form a neck such as occurs in the higher groups, though a suspicion of such a narrowing occurs in the young *Lepidosiren*.

<sup>1</sup>For general anatomy of fishes, see T. W. Bridge, *Cambridge Natural History*, and R. Wiedersheim, *Vergl. Anat. der Wirbeltiere*. The latter contains an excellent bibliography.

The tail, or postanal region, is probably a secondary development—a prolongation of the hinder end of the body for motor purposes. This is indicated by the fact that it frequently develops late in ontogeny.

The vertebrate, in correlation perhaps with its extreme cephalization, develops from before backwards (except the alimentary canal, which develops more *en bloc*), these remaining at the hind end for a prolonged period a mass of undifferentiated embryonic tissue from the anterior side of which the definitive tissues are constantly being developed. After development has reached the level of the anus it still continues backwards and the tail region is formed, showing a continuation of the same tissues as in front, notochord, nerve cord, gut, myotomes. Of these the (postanal) gut soon undergoes atrophy.

**Fins.**—The fins are extensions of the body surface which serve for propulsion. To give the necessary rigidity they are provided with special skeletal elements, while to give mobility they are provided with special muscles. These muscles, like the other voluntary muscles of the body, are derived from the primitive myotomes and are therefore segmental in origin. The fins are divisible into two main categories—the median or unpaired fins and the paired fins.

The median fins are to be regarded as the more primitive. The fundamental structure of the vertebrate, with its median

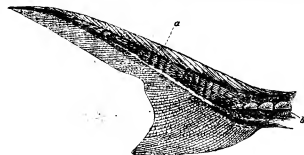
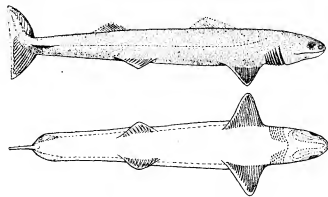

FIG. 1.—Heterocercal Tail of *Acipenser*. *a*, Modified median scales ("fulcra"); *b*, bony plates.

skeletal axis and its great muscular mass divided into segments along each side of the body, indicates that its primitive method of movement was by waves of lateral flexure, as seen in an Amphioxus, a cyclostome or an eel. The system of median fins consists in the first instance of a continuous fin-fold extending round the posterior end of the body—as persists even in the adult in the existing Dipneusti. A continuous median fin-fold occurs also in various Teleosts (many deep-sea Teleosts, eels,



From *Cambridge Natural History*, vol. vii., "Fishes, &c.," by permission of Messrs. Macmillan & Co., Ltd.

FIG. 2.—*Cladoselache*. (After Dean.)

&c.), though the highly specialized features in other respects make it probable that we have here to do with a secondary return to a condition like the primitive one. In the process of segmentation of the originally continuous fin-fold we notice first of all a separation of and an increase in size of that portion of the fin which from its position at the tip of the tail region is in the most advantageous position for producing movements of the body. There is thus formed the *caudal* fin. In this region

there is a greatly increased size of the fin-fold—both dorsally and ventrally. There is further developed a highly characteristic asymmetry. In the original symmetrical or *protocercal* (= *diphycercal*) type of tail (as seen in a cyclostome, a Dipnoan and in most fish embryos) the skeletal axis of the body runs straight out to its tip—the tail fold being equally developed above and below the axis. In the highly developed caudal fin of the majority of fishes, however, the fin-fold is developed to a much greater extent on the ventral side, and correlated with this the skeletal axis is turned upwards as in the *heterocercal* tail of sharks and sturgeons. The highest stage in this evolution of the caudal fin is seen in the Teleostean fishes, where the ventral tail-fold becomes developed to such an extent as to produce a secondarily symmetrical appearance (*homocercal* tail, fig. 4).

The sharks have been referred to as possessing heterocercal tails, but, though this is true of the majority, within the limits of the group all three types of tail occur, from the protocercal tail of the fossil *Pleuraecanthus* and the living *Chlamydoselachus* to the highly developed, practically homocercal tail of the ancient *Cladoselache* (fig. 2).

The praecaual portion of the fin-fold on the dorsal side of the body becomes broken into numerous finlets in living Crossopterygians, while in other fishes it disappears throughout part of its length, leaving only one, two or three enlarged portions—the *dorsal* fins (fig. 4, *d.f.*). Similarly the praecaual part of the fin-fold ventrally becomes reduced to a single *anal* fin (*a.f.*), occasionally continued backwards by a series of finlets (*Scombridae*). In the sucker-fishes (*Remora*, *Echeneis*) the anterior dorsal fin is metamorphosed into a sucker by which the creature attaches itself to larger fishes, turtles, &c.

The paired fins—though more recent developments than the median—are yet of very great morphological interest,

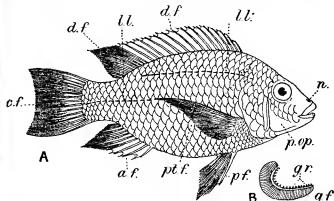

From *Cambridge Natural History*, vol. vii., "Fishes, &c.," by permission of Messrs. Macmillan & Co., Ltd.

FIG. 4.—*Tilapia dollii*, a teleostean fish, to illustrate external features. (After Boulenger.)

- A, Side view.
- B, First branchial arch.
- a.f.*, Anal fin.
- c.f.*, Caudal fin.
- d.f.*, Dorsal fin.
- g.f.*, Gill lamellae.
- g.r.*, Gill rakers.
- ll.*, Lateral line organs.
- n.*, Nasal opening.
- p.f.*, Pelvic fin.
- p.op.*, Preoperculum.
- p.f.*, Pectoral fin.

as in them we are compelled to recognize the homologues of the paired limbs of the higher vertebrates. We accordingly distinguish the two pairs of fins as pectoral or anterior and pelvic (= "ventral" or posterior). There are two main types of paired fin—the *archipterygial* type, a paddle-like structure supported by a jointed axis which bears lateral rays and exists in an unmodified form in *Neoceratodus* alone amongst living fishes, and the *actinopterygial* type, supported by fine raylike structures as seen in the fins of any ordinary fish. The relatively

less efficiency of the archipterygium and its predominance amongst the more ancient forms of fishes point to its being the more archaic of these two types.

In the less highly specialized groups of fishes the pectoral fins are close behind the head, the pelvic fins in the region of the cloacal opening. In the more specialized forms the pelvic fins frequently show a more or less extensive shifting towards the head, so that their position is described as thoracic (fig. 4) or jugular (*Gadus*—cod, haddock, &c., fig. 5).



FIG. 5.—Burbot (*Lota vulgaris*), with jugular ventral fins.

The median fin, especially in its caudal section, is the main propelling organ; the paired fins in the majority of fishes serve for balancing. In the Dipneusti the paired fins are used for clambering about amidst vegetation, much in the same fashion as the limbs of Urodeles. In *Ceratodus* they also function as paddles. In various Teleosts the pectoral fins have acquired secondarily a leg-like function, being used for creeping or skipping over the mud (*Periophthalmus*; cf. also Trigluids, Scorpaenids and Pediculati). In the "flying" fishes the pectoral fins are greatly enlarged and are used as wings, their quivering movements frequently giving a (probably erroneous) impression of voluntary flapping movements. In the gobies and lump-suckers (*Cycloperidae*) the pelvic fins are fused to form an adhesive sucker; in the *Gobiesocidae* they take part in the formation of a somewhat similar sucker.

The evolutionary history of the paired limbs forms a fascinating chapter in vertebrate morphology. As regards their origin two hypotheses have attracted special attention: (1) that originated by Gegenbaur, according to which the limb is a modified gill septum, and (2) that supported by James K. Thacher, F. M. Balfour, St. George Mivart and others, that the paired fins are persisting and modified portions of a once continuous fin-fold on each side of the body. The majority of morphologists are now inclined to accept the second of these views. Each has been supported by plausible arguments, for which reference must be made to the literature of the subject.<sup>1</sup> Both views rest upon the assumed occurrence of stages for the existence of which there is no direct evidence, viz. in the case of (1) transitional stages between gill septum and limb, and in the case of (2) a continuous lateral fin-fold. (There is no evidence that the lateral row of spines in the acanthodian *Cimacanthus* has any other than a defensive significance.) In the opinion of the writer of this article, such assumptions are without justification, now that our knowledge of Dipnoan and Crossopterygian and Urodele embryology points towards the former possession by the primitive vertebrate of a series of projecting, voluntarily movable, and hence potentially motor structure on each side of the body. It must be emphasized that these—the true external gills—are the *only* organs known actually to exist in vertebrates which might readily be transformed into limbs. When insuperable objections are adduced to this having actually taken place in the course of evolution, it will be time enough to fall back upon purely hypothetical ancestral structures on which to base the evolutionary history of the limbs.

The ectoderm covering the general surface is highly glandular. In the case of the Dipneusti, flask-shaped multicellular glands like those of Amphibians occur in addition to the scattered gland cells.

A characteristic feature of glandular activity is the production of a slight electrical disturbance. In the case of *Malopterurus* this elsewhere subsidiary function of the skin has become so exaggerated as to lead to the conversion of the skin of each side of the body into a powerful electrical organ.<sup>2</sup> Each of these consists of some two million small chambers, each containing an electric disk and all deriving their nerve supply from the branches of a single enormous axis cylinder. This takes its origin from a gigantic ganglion cell situated latero-dorsally in the spinal cord between the levels of the first and second spinal nerves.

**Cement Organs.**—The larvae of certain Teleostomes and Dipnoans possess special glandular organs in the head region for the secretion of a sticky cement by which the young fish is able to attach itself to water-plants or other objects. As a rule these are ectodermal in origin; e.g. in *Lepidosiren* and *Protopterus*<sup>3</sup> the crescentic cement organ lying ventrally behind the

mouth consists of a glandular thickening of the deep layer of the ectoderm. In young ganoid fishes prooral cement organs occur. In Crossopterygians there is one cup-shaped structure on each side immediately in front of the mouth. Here the glandular epithelium is endodermal, developed<sup>4</sup> as an outgrowth from the wall of the alimentary canal, closely resembling a gill pouch. In *Amia*<sup>5</sup> the same appears to be the case. In a few Teleosts similar organs occur, e.g. *Sarcodaces*, *Hyperopisus*,<sup>6</sup> where so far as is known they are ectodermal.

**Photogenic Organs.**—The slimy secretion produced by the epidermal glands of fishes contains in some cases substances which apparently readily undergo a slow process of oxidation, giving out light of low wave-length in the process and so giving rise to a phosphorescent appearance. In many deep-sea fishes (this property of producing light-emitting secretion has undergone great development, leading to the existence of definite photogenic organs. These vary much in character, and much remains to be done in working out their minute structure. Good examples are seen in the Teleostean family *Scopelidae*, where they form brightly shining eye-like spots scattered about the surface of the body, especially towards the ventral side.

**External Gills.**—In young Crossopterygians and in the young *Protopterus* and *Lepidosiren* true external gills occur of the same morphological nature as those of Urodele amphibians. In Crossopterygians a single one is present on each side of the hyoid arch; in the two Dipnoans mentioned four are present

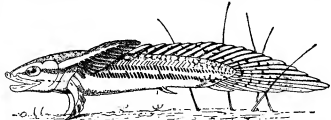

From Trans. Zool. Soc. of London.

FIG. 6.—Larva of Polypterus. (After Budgett.)

on each side—on visceral arches III, IV, V, and VI. (It may be recalled that in Urodeles they occur on arches III, IV, and V, with vestiges<sup>7</sup> on arches I, and II.) Each external gill develops as a projection of ectoderm with mesodermal core near the upper end of its visceral arch; the main aortic arch is prolonged into it as a loop. When fully developed it is pinnate, and is provided with voluntary muscles by which it can be moved freely to renew the water in contact with its respiratory surface. In the case of *Polypterus* a short rod of cartilage projects from the



From Phil. Transactions, Royal Society of London.

FIG. 7.—Thirty Days' Larval Lepidosiren. (After Graham Kerr.)

hyoid arch into the base of the external gill. Their occurrence with identical main features in the three groups mentioned indicates that the external gills are important and archaic organs of the vertebrata. Their non-occurrence in at least some of the groups where they are absent is to be explained by the presence of a large vascular yolk sac, which necessarily fulfils in a very efficient way the respiratory function.

**Alimentary Canal.**—The alimentary canal forms a tube traversing the body from mouth to cloacal opening. Corresponding with structural and functional differences it is for descriptive

<sup>1</sup> J. Graham Kerr, *The Budgett Memorial Volume*.

<sup>2</sup> J. Phelps, *Science*, vol. N.S. ix, p. 366; J. Eycleshymer and Wilson, *Amer. Journ. Anat.* v. (1906) p. 154.

<sup>3</sup> J. S. Budgett, *Trans. Zool. Soc. Lond.* xvi, 1901, p. 130.

<sup>4</sup> L. Drüner, *Zool. Jahrbücher Anat.* Band xiv. (1904), S. 434.

<sup>1</sup> Cf. J. Graham Kerr, *Proc. Camb. Phil. Soc.* v. 227.

<sup>2</sup> For electric organs see W. Biedermann, *Electro-Physiology*.

<sup>3</sup> J. Graham Kerr, *Quart. Journ. Micr. Sci.* vol. xlv.



purposes divided into the following regions—(1) Buccal cavity or mouth cavity, (2) Pharynx, (3) Oesophagus or gullet, (4) Stomach, (5) Intestine, and (6) Cloaca. The buccal cavity or mouth cavity is morphologically a stomodaeum, *i.e.* it represents an inpushing of the external surface. Its opening to the exterior is wide and gaping in the embryo in certain groups (Selachians and Crossopterygians), and even in the adult among the Cyclostomata, but in the adult Gnathostome it can be voluntarily

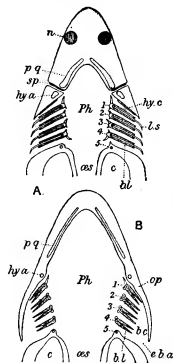

From Bridge, *Cambridge Natural History*, vol. vii., "Fishes, &c." (by permission of Macmillan & Co., Ltd.). After Boas, *Lehrbuch der Zoologie* (by permission of Gustav Fischer).

FIG. 8.—Diagrams to illustrate the relations of branchial clefts and pharynx in an Elasmobranch (A) and a Teleost (B); 1, 2, &c., Branchial septa.

- b.e., Opercular cavity.  
b.l., Respiratory lamellae.  
c, Coelom.  
o.p., Opercular opening.  
h.y.a., Hyoid arch.  
l.s., Valvular outer edge of gill septum.  
n, Nasal aperture.  
oes, Oesophagus.  
op, Operculum.  
p.q., Palatoquadrate cartilage.  
Ph, Pharynx.  
sp, Spiracle.

hyobranchial. In common usage the hyomandibular cleft is called the spiracle, and the series of clefts behind it the branchial clefts.

The typical functional gill cleft forms a vertical slit, having on each side a gill septum which separates it from its neighbours in the series. The lining of the gill cleft possesses over a less or greater extent of its area a richly developed network of capillary blood-vessels, through the thin covering of which the respiratory exchange takes place between the blood and the water which washes through the gill cleft. The area of respiratory surface tends to become increased by the development of outgrowths. Frequently these take the form of regular plate-like structures known as gill lamellae. In the Selachians these lamellae are strap-like structures (*Elasmobranch*) attached along nearly their

whole length to the gill septum as shown in fig. 8, A. In the Holocephali and in the sturgeon the outer portions of the gill septa have disappeared and this leads to the condition seen in the higher Teleostomes (fig. 8, B), where the whole of the septum has disappeared except its thick inner edge containing the skeletal arch. It follows that in these higher Teleostomes—including the ordinary Teleosts—the gill lamellae are attached only at their extreme inner end.

In the young of Selachians and certain Teleosts (e.g. *Gymnarchus* and *Heterotis*)<sup>2</sup> the gill lamellae are prolonged as filaments which project freely to the exterior. These must not be confused with true external gills.

The partial atrophy of the gill septa in the Teleostomes produces an important change in their appearance. Whereas in the Selachian a series of separate gill clefts is seen in external view each covered by a soft valvular backgrowth of its anterior lip, in the Teleostean fish, on the other hand, a single large opening is seen on each side (opercular opening) covered over by the enormously enlarged valvular flap belonging to the anterior lip of the hyobranchial cleft. This flap, an outgrowth of the hyoid arch, is known as the operculum.

In the Teleostomi there are usually five functional clefts, but these are the survivors of a formerly greater number. Evidence of reduction is seen at both ends of the series. In front of the first functional cleft (the hyobranchial) there is laid down in the embryo the rudiment of a spiracular cleft. In the less highly organized fishes this survives in many cases as an open cleft.

In many sharks and in sturgeons the spiracle forms a conspicuous opening just behind the eye. In rays and skates, which are modified in correlation with their ground feeding habit, the spiracle is a large opening which during the great widening out of the body during development comes to be situated on the dorsal side, while the branchial clefts come to be ventral in position. In existing Crossopterygians the spiracle is a slit-like opening on the dorsal side of the head which can be opened or closed at will. In Dipnoeans, as in the higher Teleostomes, the spiracle is found as an embryonic rudiment, but in this case it gives rise in the adult to a remarkable sense organ of problematical function.<sup>3</sup>

Traces of what appear to be pre-spiracular clefts exist in the embryos of various forms. Perhaps the most remarkable of these is to be found in the larval Crossopterygian,<sup>4</sup> and apparently also in *Amia*<sup>5</sup> at least, amongst the other ganoids, where a pair of endotermal pouches become cut off from the main endoterm and, establishing an opening to the exterior, give rise to the lining of the cement organs of the larva. Posteriorly there is evidence that the extension backwards of the series of gill clefts was much greater in the primitive fishes. In the surviving sharks (*Chlamydoselachus* and *Notidinus cinereus*), there still exist in the adult respectively six and seven branchial clefts, while in embryonic Selachians there are frequently to be seen pouch-like outgrowths of endoterm apparently representing rudimentary gill pouches but which never develop. Further evidence of the progressive reduction in the series of clefts is seen in the reduction of their functional activity at the two ends of the series. The spiracle, even where persisting in the adult, has lost its gill lamellae either entirely or excepting a few vestigial lamellae forming a "pseudobranch" on its anterior wall (Selachians, sturgeons). A similar reduction affects the lamellae on the anterior wall of the hyobranchial cleft (except in Selachians) and on the posterior wall of the last branchial cleft.

A pseudobranch is frequently present in Teleostomes on the anterior wall of the hyobranchial cleft, *i.e.* on the inner or posterior-face of the operculum. It is believed by some morphologists to belong really to the cleft in front.<sup>6</sup>

*Phylogeny*.—The phylogeny of the gill clefts or pouches is uncertain. The only organs of vertebrates comparable with them morphologically are the enterocoele pouches of the endoterm which

<sup>2</sup> J. S. Budgett, *op. cit.*

<sup>3</sup> W. E. Agar, *Anat. Anz.*, 1905, S. 298.

<sup>4</sup> J. Graham Kerr, *The Budgett Memorial Volume*.

<sup>5</sup> J. Phelps, *Science*, vol. N.S. ix. p. 366; J. Eyleshymer and Wilson, *Amer. Journ. Anat.*, v. 1906, p. 154.

<sup>6</sup> F. Maurer, *Morph. Jahrb.* ix., 1884, S. 229, and xiv., 1888, S. 175.

give rise to the mesoderm. It is possible that the respiratory significance of the wall of the gill cleft has been secondarily acquired. This is indicated by the fact that they appear in some cases to be lined by an ingrowth of ectoderm. This suggests that there may have been a spreading inwards of respiratory surface from the external gills. It is conceivable that before their walls became directly respiratory the gill clefts served for the pumping of fresh water over the external gills at the bases of which they lie.

**Lung.**—As in the higher vertebrates, there develops in all the main groups of gnathostomatous fishes, except the Selachians, an outgrowth of the pharyngeal wall intimately associated with gaseous interchange. In the Crossopterygians and Dipnoans this pharyngeal outgrowth agrees exactly in its midventral origin and in its blood-supply with the lungs of the higher vertebrates, and there can be no question about its being morphologically the same structure as it is also in function.

In the Crossopterygians the ventrally placed slit-like glottis leads into a common chamber produced anteriorly into two horns and continued backwards into two "lungs." These are smooth, thin-walled, saccular structures, the right one small, the left very large and extending to the hind end of the splanchnocoel. In the Dipnoans the lung has taken a dorsal position close under the vertebral column and above the splanchnocoel. Its walls are sacculated, almost spongy in *Lepidostreus* and *Protopterus*, so as to give increase to the respiratory surface. In *Neoceratodus* (fig. 9) an indication of division into two halves is seen in the presence of two prominent longitudinal ridges, one dorsal and one ventral. In *Lepidostreus* and *Protopterus* the organ is completely divided except at its anterior end into a right and a left lung. The anterior portion of the lung or lungs is connected with the median ventral glottis by a short wide vestibule which lies on the right side of the oesophagus.

In the Teleostei the representative of the lung, here termed the swimbladder, has for its predominant function a hydrostatic one; it acts as a float. It arises as a diverticulum of the gut-wall which may retain a tubular connexion with the gut (*physostomatous* condition) or may in the adult completely lose such connexion (*physoclistic*). It shows two conspicuous differences from the lung of other forms: (1) it arises in the young fish as a dorsal instead of as a ventral diverticulum, and (2) it derives its blood-supply not from the sixth aortic arch but from branches of the dorsal aorta.

These differences are held by many to be sufficient to invalidate the homologizing of the swimbladder with the lung. The following facts, however, appear to do away with the force of such a contention. In the Dipnoans (e.g. *Neoceratodus*) the lung as a whole has acquired a dorsal position, but its connexion with the mid-ventral glottis is asymmetric, passing round the right side of the gut. Were the predominant

function of the lung in such a form to become hydrostatic we might expect the course of evolution to lead to a shifting of the glottis dorsalwards so as to bring it nearer to the definitive situation of the lung. (2) In *Erythrinus* and other Characids the glottis is not mid-ventral but decidedly lateral in position, suggesting either a retention of, or a return to, ancestral stages in the dorsalward migration of the glottis. (3) The blood-supply of the Teleostean swimbladder is from branches of the dorsal aorta, which may be distributed over a long anteroposterior extent of that vessel. Embryology, however, shows that the swimbladder arises as a localized diverticulum. It follows that the blood-supply from a long stretch of the aorta can hardly be primitive. We should rather expect the primitive blood-supply to be from the main arteries of the pharyngeal wall, i.e. from the hinder aortic arch as is the case with the lungs of other forms. Now in *Amia* at least we actually find such a blood-supply, there being here a pulmonary artery corresponding with that in lung-possessing forms. Taking these points into consideration there seems no valid reason for doubting that in lung and swimbladder we are dealing with the same morphological structure.

**Function.**—In the Crossopterygians and Dipnoans the lung is used for respiration, while at the same time fulfilling a hydrostatic function. Amongst the Actinopterygians a few forms still use it for respiration, but its main function is that of a float. In connexion with this function there exists an interesting compensatory mechanism whereby the amount of gas in the swimbladder may be diminished (by absorption), or, on the other hand, increased, so as to counteract alterations in specific gravity produced, e.g. by change of pressure with change of depth. This mechanism is specially developed in physoclistic forms, where there occur certain glandular patches ("red glands") in the lining epithelium of the swimbladder richly stuffed with capillary blood-vessels and serving apparently to secrete gas into the swimbladder. That the gas in the swimbladder is produced by some vital process, such as secretion, is already indicated by its composition, as it may contain nearly 90% of oxygen in deep-sea forms or a similar proportion of nitrogen in fishes from deep lakes, i.e. its composition is quite different from what it would be were it accumulated within the swimbladder by mere ordinary diffusion processes. Further, the formation of gas is shown by experiment to be controlled by branches of the vagus and sympathetic nerves in an exactly similar fashion to the secretion of saliva in a salivary gland. (See below for relations of swimbladder to ear).

Of the important non-respiratory derivatives of the pharyngeal wall (thyroid, thymus, postbranchial bodies, &c.), only the thyroid calls for special mention, as important clues to its evolutionary history are afforded by the lampreys. In the larval lamprey the thyroid develops as a longitudinal groove on the pharyngeal floor. From the anterior end of this groove there pass a pair of peripharyngeal ciliated tracts to the dorsal side of the pharynx where they pass backwards to the hind end of the pharynx. Morphologically the whole apparatus corresponds closely with the endostyle and peripharyngeal and dorsal ciliated tracts of the pharynx of *Amphioxus*. The correspondence extends to function, as the open thyroid groove secretes a sticky mucus which passes into the pharyngeal cavity for the entanglement of food particles exactly as in *Amphioxus*. Later on the thyroid groove becomes shut off from the pharynx; its secretion now accumulates in the lumina of its interior and it functions as a ductless gland as in the Gnathostomata. The only conceivable explanation of this is a developmental history of the thyroid in the lamprey is that it is a repetition of phylogenetic history.

Behind the pharynx comes the main portion of the alimentary canal concerned with the digestion and absorption of the food. This forms a tube varying greatly in length, more elongated and coiled in the higher Teleostomes, shorter and straighter in the Selachians, Dipnoans and lower Teleostomes. The oesophagus or gullet, usually forming a short, wide tube, leads into the glandular, more or less dilated stomach. This is frequently in the form of a letter J, the longer limb being continuous with the gullet, the shorter with the intestine. The curve of the J may be as in *Polypterus* and the perch produced backwards into a large pocket. The intestine is usually marked off from the stomach by a ring-like sphincter muscle forming the



FIG. 9.—Lung of *Neoceratodus*, opened in its lower half to show its cellular pouches. a, Right half; b, Left half; c, Cellular pouches; d, Pulmonary vein; e, Arterial blood-vessel; f, Oesophagus, opened to show glottis (gl.)

away with the force of such a contention. In the Dipnoans (e.g. *Neoceratodus*) the lung as a whole has acquired a dorsal position, but its connexion with the mid-ventral glottis is asymmetric, passing round the right side of the gut. Were the predominant

pyloric valve. In the lower gnathostomatous fishes (Selachians, Crossopterygians, Dipnoans, sturgeons) the intestine possesses the highly characteristic spiral valve, a shelf-like projection into its lumen which pursues a spiral course, and along the turns of which the food passes during the course of digestion. From its universal occurrence in the groups mentioned we conclude that it is a structure of a very archaic type, once characteristic of ancestral Gnathostomata; a hint as to its morphological significance is given by its method of development.<sup>1</sup> In an early stage of development the intestinal rudiment is coiled into a spiral and it is by the fusion together of the turns that the spiral valve arises. The only feasible explanation of this peculiar method of development seems to lie in the assumption that the ancestral gnathostome possessed an elongated coiled intestine which subsequently became shortened with a fusion of its coils. In the higher fishes the spiral valve has disappeared—but still found, however, in a reduced condition in *Amia* and *Lepidosteus*, and possibly as a faint vestige in one or two Teleosts (certain *Clupeidae*<sup>2</sup> and *Salmonidae*<sup>3</sup>). In the majority of the Teleosts the absence of spiral valves is coupled with a secondary elongation of the intestinal region, which in extreme cases (*Loricariidae*) may be accompanied by a secondary spiral coiling.

The terminal part of the alimentary canal—the cloaca—is characterized by the fact that into it open the two kidney ducts. In Teleosts the cloaca is commonly flattened out, so that the kidney ducts and the alimentary canal come to open independently on the outer surface.

The lining of the alimentary canal is throughout the greater part of its extent richly glandular. And at certain points local enlargements of the secretory surface take place so as to form glandular diverticula. The most ancient of these as indicated by its occurrence even in *Amphioxus* appears to be the liver, which, originally—as we may assume—mainly a digestive gland, has in the existing Craniates developed important excretory and glycogen-storing functions. Arising in the embryo as a simple caecum, the liver becomes in the adult a compact gland of very large size, usually bi-lobed in shape and lying in the front portion of the splanchnocoel. The stalk of the liver rudiment becomes drawn out into a tubular bile duct, which may become subdivided into branches, and as a rule develops on its course a pocket-like expansion, the gall-bladder. This may hang freely in the splanchnocoel or may be, as in many Selachians, imbedded in the liver substance.

The pancreas also arises by localized bulging outwards of the intestinal lining—there being commonly three distinct rudiments in the embryo. In the Selachians the whitish compact pancreas of the adult opens into the intestine some little distance behind the opening of the bile duct, but in the Teleostomes it becomes involved in the liver outgrowth and mixed with its tissue, being frequently recognizable only by the study of microscopic sections. In the Dipnoans the pancreatic rudiment remains imbedded in the wall of the intestine: its duct is united with that of the liver.

**Pyloric Caeca.**—In the Teleostomi one or more glandular diverticula commonly occur at the commencement of the intestine and are known as the pyloric caeca. There may be a single caecum (crossopterygians, *Ammodytes* amongst Teleosts) or there may be nearly two hundred (mackerel). In the sturgeons the numerous caeca form a compact gland. In several families of Teleosts, on the other hand, there is no trace of these pyloric caeca.

In Selachians a small glandular diverticulum known as the *rectal gland* opens into the terminal part of the intestine on its dorsal side.

**Cœlomic Organs.**—The development of the mesoderm in the restricted sense (mesothelium) as seen in the fishes (lamprey, *Lepidosiren*, *Protopterus*, *Polypterus*) appears to indicate beyond

doubt that the mesoderm segments of vertebrates are really enterocoelic pouches in which the development of the lumen is delayed. Either the inner, or both inner and outer (e.g. *Lepidosiren*) walls of the mesoderm segment pass through a myoepithelial condition and give rise eventually to the great muscle segments (myomeres, or myotomes) which lie in series on each side of the trunk. In the fishes these remain distinct throughout life. The fins, both median and paired, obtain their musculature by the ingrowth into them of muscle buds from the adjoining myotomes.

**Electrical Organs.**<sup>4</sup>—It is characteristic of muscle that at the moment of contraction it produces a slight electrical disturbance. In certain fishes definite tracts of the musculature show a reduction of their previously predominant function of contraction and an increase of their previously subsidiary function of producing electrical disturbance; so that the latter function is now predominant.

In the skates (*Raja*) the electrical organ is a fusiform structure derived from the lateral musculature of the tail; in *Gymnotus*—the electric eel—and in *Mormyrus* it forms an enormous structure occupying the place of the ventral halves of the myotomes along nearly the whole length of the body; in *Torpedo* it forms a large, somewhat kidney-shaped structure as viewed from above lying on each side of the head and derived from the musculature of the anterior visceral arches. In *Torpedo* the nerve-supply is derived from cranial nerves VII, IX, X, and the anterior branchial branches of X.

The electric organ is composed of prismatic columns each built up of a row of compartments. Each compartment contains a lamellated electric disc representing the shortened-up and otherwise metamorphosed muscle fibre. On one face (ventral in *Torpedo*, anterior in *Raja*) of the electric disc is a gigantic end-plate supplied by a beautiful, dichotomously branched, terminal nervous arborization.

The development of the mesoderm of the head region is too obscure for treatment here.<sup>5</sup> The ventral portion of the trunk mesoderm gives rise to the splanchnocoel or general coelom. Except in the Myxinooids the anterior part of the splanchnocoel becomes separated off as a pericardiac cavity, though in adult Selachians the separation becomes incomplete, the two cavities being in communication by a pericardio-peritoneal canal.

**Nephridial System.**—The kidney system in fishes consists of segmentally arranged tubes leading from the coelom into a longitudinal duct which opens within the hinder end of the organ—the whole forming what is known as the *archinephros* (Lankester) or *holonephros* (Price). Like the other segmented

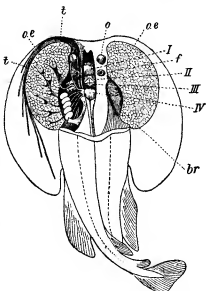

From Gegenbaur, *Untersuchungen zur vergleich. Anat. der Wirbeltiere*, by permission of Wilhelm Engelmann.

FIG. 10.—View of *Torpedo* from the dorsal side: the electric organs are exposed.

- I, Forebrain.
- II, Mesencephalon.
- III, Cerebellum.
- IV, Electric lobe.
- br, Common muscular sheath covering branchial clefts (on the left side this has been removed so as to expose the series of branchial sacs).
- f, Spiracle.
- oe, Electric organ, on the left side the nerve-supply is shown.
- o, Eye.
- t, Sensory tubes of lateral line system.

<sup>1</sup> J. Rückert, *Arch. Entwicklungsmech.* Band iv., 1897, S. 298; J. Graham Kerr, *Phil. Trans. B.* 192, 1900, p. 325, and *The Budget Memorial Volume*.

<sup>2</sup> Cuvier et Valenciennes, *Hist. nat. des poissons*, xix., 1846, p. 151.

<sup>3</sup> J. Rathke, *Üb. d. Darmkanal u.s.w. d. Fische*, Halle, 1824, S. 62.

<sup>4</sup> Cf. W. Biedermann, *Electro-Physiology*.

<sup>5</sup> Literature in N. K. Koltzoff, *Bull. Soc. Nat. Moscow*, 1904, p. 259.

organs of the vertebrate the archinephros develops from before backwards. The sequence is, however, not regular. A small number of tubules at the head end of the series become specially enlarged and are able to meet the excretory needs during larval existence (*Pronephros*): the immediately succeeding tubules remain undeveloped, and then come the tubules of the rest of the series which form the functional kidney of the adult (*Mesonephros*).

The kidney tubules subserve the excretory function in two different ways. The wall of the tubule, bathed in blood from the posterior cardinal vein, serves to extract nitrogenous products of excretion from the blood and pass them into the lumen of the tubule. The open ciliated funnel or nephrostome at the coelomic end of the tubule serves for the passage outwards of coelomic fluid to flush the cavity of the tubule. The secretory activity of the coelomic lining is specially concentrated in certain limited areas in the neighbourhood of the nephrostomes, each such area ensheathing a rounded mass depending into the coelom and formed of a blood-vessel coiled into a kind of skein—a glomerulus. In the case of the pronephros the glomeruli are as a rule fused together into a single glomus. In the mesonephros they remain separate and in this case the portion of coelom surrounding the glomerulus tends to be nipped off from the general coelom—to form a Malpighian body. The separation may be incomplete—the Malpighian coelom remaining in connexion with the general coelom by a narrow peritoneal canal. The splanchnocoelic end of this is usually ciliated and is termed a peritoneal funnel: it is frequently confused with the nephrostome.

*Mesonephros*.—The kidney of the adult fish is usually a compact gland extending over a considerable distance in an anteroposterior direction and lying immediately dorsal to the coelomic cavity.

Peritoneal funnels are present in the adult of certain Selachians (e.g. *Acanthias*, *Squatina*), though apparently in at least some of these forms they no longer communicate with the Malpighian bodies or tubules. The kidneys of the two sides become fused together posteriorly in *Protopterus* and in some Teleosts. The mesonephric ducts undergo fusion posteriorly in many cases to form a median urinary or urogenital sinus. In the Selachians this median sinus is prolonged forwards into a pair of horn-like continuations—the sperm sacs. In Dipnoans the sinus becomes greatly dilated and forms a large, rounded, dorsally placed cloacal caecum. In Actinopterygians a urinary bladder of similar morphological import is commonly present.

*Gonads*.—The portion of coelomic lining which gives rise to the reproductive cells retains its primitive relations most nearly in the female, where, as a rule, the genital cells are still shed into the splanchnocoel. Only in Teleostomes (*Lepidosteus* and most Teleosts) the modification occurs that the ovary is shut off from the splanchnocoel as a closed cavity continuous with its duct.

In a few Teleosts (*Salmonidae*, *Muraenidae*, *Cobitis*) the ovary is not a closed sac, its eggs being shed into the coelom as in other groups.

The appearance of the ovary naturally varies greatly with the character of the eggs.

The portion of coelomic lining which gives rise to the male genital cells (testis) is in nearly, if not quite, all cases, shut off from the splanchnocoel. The testes are commonly elongated in form. In Dipneusti<sup>1</sup> (*Lepidosiren* and *Protopterus*) the hinder portion of the elongated testis has lost its sperm-producing function, though the spermatozoa produced in the anterior portion have to traverse it in order to reach the kidney. In *Polypterus*<sup>2</sup> the testis is continued backwards as a "testis ridge," which appears to correspond with the posterior vesicular region of the testis in *Lepidosiren* and *Protopterus*. Here also the spermatozoa pass back through the cavities of the testis ridge to reach the kidney duct. In the young Teleost<sup>3</sup> the rudiment of the duct forms a backward continuation of the

testis containing a network of cavities and opening as a rule posteriorly into the kidney duct. It is difficult to avoid the conclusion that the testis duct of the Teleost is for the most part the equivalent morphologically of the posterior vesicular region of the testis of *Polypterus* and the Dipneusti.

*Relations of Renal and Reproductive Organs*. (1) *Female*.—In the Selachians and Dipnoans the oviduct is of the type (Müllerian duct) present in the higher vertebrates and apparently representing a split-off portion of the archinephric duct. At its anterior end is a wide funnel-like coelomic opening. Its walls are glandular and secrete accessory coverings for the eggs. In the great majority of Teleosts and in *Lepidosteus* the oviduct possesses no coelomic funnel, its walls being in structural continuity with the wall of the ovary. In most of the more primitive Teleostomes (Crossopterygians, sturgeons, *Amia*) the oviduct has at its front end an open coelomic funnel, and it is difficult to find adequate reason for refusing to regard such oviducts as true Müllerian ducts. On this interpretation the condition characteristic of Teleosts would be due to the lips of the oviduct becoming fused with the ovarian wall, and the duct itself would be a Müllerian duct as elsewhere.

A departure from the normal arrangement is found in those Teleosts which shed their eggs into the splanchnocoel, e.g. amongst

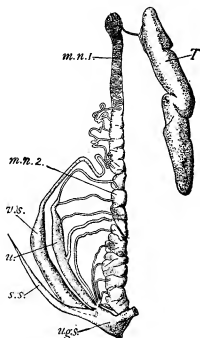

From *Arch. zool. expérimentale*, by permission of Schleicher-Frères.

FIG. 11.—Urino-Genital Organs of the right side in a male *Scyllium*. (After Borcea.)

m.n. 1, Anterior (genital) portion of mesonephros with its coiled duct.

m.n. 2, Posterior (renal) portion of mesonephros.

s.s., Sperm sac.

T, Testis.

u, "Ureter" formed by fusion of collecting tubes of renal portion of mesonephros.

u.g.s., Urino-genital sinus;

v.s., Vesicula seminalis.

testis through covered-in canals to the Malpighian bodies or kidney tubules. The system of covered-in canals forms the testicular network, the individual canals being termed vasa efferentia. In all probability the series of vasa efferentia was originally spread over the whole length of the elongated testis (cf. *Lepidosteus*), but in existing fishes the series is as a rule

<sup>1</sup> J. Graham Kerr, *Proc. Zool. Soc. Lond.*, (1901), p. 484.

<sup>2</sup> J. S. Budgett, *Trans. Zool. Soc. Lond.* xv. (1901), vol. p. 224.

<sup>3</sup> H. F. Jürgensen, *Arch. zool. zool. Inst. Würzburg*, Band ix., 1889.

<sup>4</sup> E. J. Bles, *Proc. Roy. Soc.* 62, 1897, p. 232.

restricted to a comparatively short anteroposterior extent. In Selachians the vasa efferentia are restricted to the anterior end of testis and kidney, and are connected by a longitudinal canal ending blindly in front and behind. The number of vasa efferentia varies and in the rays (*Raia*, *Torpedo*) may be reduced to a single one opening directly into the front end of the mesonephric duct. The anterior portion of the mesonephros is much reduced in size in correlation with the fact that it has lost its renal function. The hinder part, which is the functional kidney, is considerably enlarged. The primary tubules of this region of the kidney have undergone, a modification of high morphological interest. Their distal portions have become much elongated, they are more or less fused, and their openings into the mesonephric duct have undergone backward migration until they open together either into the mesonephric duct at its posterior end or into the urinogenital sinus independently of the mesonephric duct. The mesonephric duct is now connected only with the anterior part of the kidney, and serves merely as a vas deferens or sperm duct. In correlation with this it is somewhat enlarged, especially in its posterior portion, to form a vesicula seminalis.

The morphological interest of these features lies in the fact that they represent a stage in evolution which carried a little further would lead to a complete separation of the definitive kidney (*metanephros*) from the purely genital anterior section of the mesonephros (*epididymis*), as occurs so characteristically in the Amniota.

Dipneusti.—In *Lepidosiren* <sup>1</sup> a small number (about half a dozen) of vasa efferentia occur towards the hind end of the vesicular part of the testis and open into Malpighian bodies. In *Protopterus* the vasa efferentia are reduced to a single one on each side at the extreme hind end of the testis.

Teleostomi.—In the actinopterygian Ganoids a well-developed testicular network is present; e.g. in *Lepidosteus* <sup>2</sup> numerous vasa efferentia arise from the testis along nearly its whole length and pass to a longitudinal canal lying on the surface of the

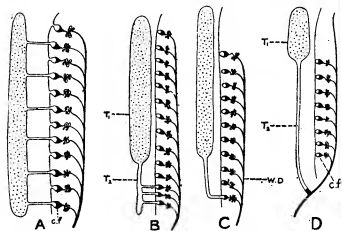

Graham Kerr, Proc. Zool. Soc. Lond.

FIG. 12.—Diagram illustrating Connection between Kidney and Testis in Various Groups of Fishes.

- A, Distributed condition of vasa efferentia (*Acipenser*, *Lepidosteus*).  
 B, Vasa efferentia reduced to a few at the hind end (*Lepidosiren*).  
 C, Reduction of vasa efferentia to a single one posteriorly (*Protopterus*).  
 D, Direct communication between testis and kidney duct (*Polypterus*, Teleosts).  
 c.f., Nephrostome leading from Malpighian coelom into kidney tubule.  
 T<sub>1</sub>, Functional region of testis.  
 T<sub>2</sub>, Vesicular region of testis.  
 W.D., Mesonephric duct.

kidney, from which in turn transverse canals lead to the Malpighian bodies. (In the case of *Amia* they open into the tubules or even directly into the mesonephric duct.) In the Teleosts and in *Polypterus* there is no obvious connexion between testis and kidney, the wall of the testis being continuous with that of its duct, much as is the case with the ovary and its duct in the female. In all probability this peculiar condition is to be

explained <sup>3</sup> by the reduction of the testicular network to a single vas efferens (much as in *Protopterus* or as in *Raia* and various anurous Amphibians at the front end of the series) which has come to open directly into the mesonephric duct (cf. fig. 12).

*Organs of the Mesenchyme.*—In vertebrates as in all other Metazoa, except the very lowest, there are numerous cell elements which no longer form part of the regularly arranged epithelial layers, but which take part in the formation of the packing tissue of the body. Much of this forms the various kinds of connective tissue which fill up many of the spaces between the various epithelial layers; other and very important parts of the general mesenchyme become specialized in two definite directions and give rise to two special systems of organs. One of these is characterized by the fact that the intercellular substance or matrix assumes a more or less rigid character—it may be infiltrated with salts of lime—giving rise to the supporting tissues of the skeletal system. The other is characterized by the intercellular matrix becoming fluid, and by the cell elements losing their connexion with one another and forming the characteristic fluid tissue, the blood, which with its well-marked containing walls forms the blood vascular system.

*Skeletal System.*—The skeletal system may be considered under three headings—(1) the choral skeleton, (2) the cartilaginous skeleton and (3) the osseous skeleton.

1. *Choral Skeleton.*—The most ancient element of the skeleton appears to be the *notochord*—a cylindrical rod composed of highly vacuolated cells lying ventral to the central nervous system and dorsal to the gut. Except in *Amphioxus*—where the condition may probably be secondary, due to degenerative shortening of the central nervous system—the notochord extends from a point just behind the infundibulum of the brain (see below) to nearly the tip of the tail. In ontogeny the notochord is a derivative of the dorsal wall of the archenteron. The outer layer of cells, which are commonly less vacuolated and form a "chordal epithelium," soon secretes a thin cuticle which ensheathes the notochord and is known as the primary sheath. Within this there is formed later a secondary sheath, like the primary, cuticular in nature. This secondary sheath attains a considerable thickness and plays an important part in strengthening the notochord. The notochord with its sheaths is in existing fishes essentially the skeleton of early life (embryonic or larval). In the adult it may, in the more primitive forms (*Cyclostomata*, *Dipneusti*), persist as an important part of the skeleton, but as a rule it merely forms the foundation on which the cartilaginous or bony vertebral column is laid down.

2. *Cartilaginous or Chondral Skeleton.*—(A) Vertebral column.<sup>4</sup> In the embryonic connective tissue or mesenchyme lying just outside the primary sheath of the notochord there are developed a dorsal and a ventral series of paired nodules of cartilage known as *arcualia* (fig. 13, *d.a.*, *v.a.*). The dorsal arcualia are commonly prolonged upwards by supradorsal cartilages which complete the *neural arches* and serve to protect the spinal cord. The ventral arcualia become, in the tail region only, also incorporated in complete arches—the *haemal arches*. In correlation with the flattening of the body of the fish from side to side the arches are commonly prolonged into elongated neural or haemal spines.

The relations of the arcualia to the segmentation of the body, as shown by myotomes and spinal nerves, is somewhat obscure. The mesenchyme in which they arise is segmental in origin (sclerotome), which suggests that they too may have been primitively segmental, but in existing fishes there are commonly two sets of arcualia to each body segment.

In gnathostomatous fishes the arcualia play a most important part in that cartilaginous tissue derived from them comes into special relationships with the notochord and gives rise to the vertebral column which functionally replaces this notochord in most of the fishes. This replacement occurs according to two different methods, giving rise to the different types of vertebral column known as chondracentric and arcricentrous.

<sup>1</sup> J. Graham Kerr, Proc. Zool. Soc. Lond. (1901) p. 484.

<sup>2</sup> F. M. Balfour and W. N. Parker, Phil. Trans. (1882).

<sup>3</sup> J. Graham Kerr, Proc. Zool. Soc. Lond. (1901), p. 495.

<sup>4</sup> H. Gadow and E. C. Abbott, Phil. Trans. 186 (1895), p. 163

(a) Chordacentric type. An incipient stage in the evolution of a chordacentric vertebral column occurs in the Dipneusti, where cartilage cells from the arcualia become amoeboid and migrate into the substance of the secondary sheath, boring their way through the primary sheath (fig. 13, C). They wander throughout the whole extent of the secondary sheath, colonizing it as it were, and settle down as typical stationary cartilage cells. The secondary sheath is thus converted into a cylinder of cartilage. In Selachians exactly the same thing takes place, but in recent forms development goes a step further, as the cartilage cylinder becomes broken into a series of segments, known as vertebral centra. The wall of each segment becomes much thickened in the middle so that the notochord becomes constricted within each centrum and the space occupied by it

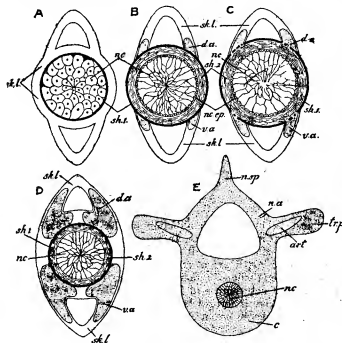

From Wiedersheim, *Grundriss der vergleichenden Anatomie*, by permission of Gustav Fischer.

FIG. 13.—Diagrammatic transverse sections to illustrate the morphology of the vertebral column.

- A, Primitive conditions as seen in any young embryo.  
 B, Conditions as it occurs in Cyclostomata, sturgeons, embryos of bony Actinopterygians.  
 C, Condition found in Selachians and Dipnoans.  
 D and E, Illustrating the developmental process in bony Actinopterygians and higher vertebrates.
- c*, Centrum.  
*d.a.*, Dorsal arcualia.  
*n.a.*, Neural arch.  
*nc*, Notochord.  
*nc.ep.*, Chordal epithelium.  
*n.sp.*, Neural spine.  
*sh.1.*, Primary sheath.  
*sh.2.*, Secondary sheath.  
*sk.l.*, Connective tissue.  
*tr.p.*, Transverse process.  
*v.a.*, Ventral arcualia.

is shaped like the cavity of a dice-box. When free from notochord and surrounding tissues such a cartilaginous centrum presents a deep conical cavity at each end (*amphicoelous*).

A secondary modification of the centrum consists in the calcification of certain zones of the cartilaginous matrix. The precise arrangement of these calcified zones varies in different families and affords characters which are of taxonomic importance in palaeontology where only skeletal structures are available (see SELACHIANS).

(b) Arcicentric type. Already in the Selachians the vertebral column is to a certain extent strengthened by the broadening of the basis of the arcualia so as partially to surround the centra. In the Teleostomes, with the exceptions of those ganoids mentioned, the expanded bases of the arcualia undergo complete fusion to form cartilaginous centra which, unlike the chordacentric centra, lie outside the primary sheath (figs. 13, D and E). In these forms no invasion of the secondary sheath by cartilage cells takes place. The composition of the groups of arcualia which give rise to the individual centrum is different in different groups. The end result is an amphicoelous or bicon-

cave centrum in general appearance much like that of the Sclachian.

In *Lepidosteus* the spaces between adjacent centra become filled by a secondary development of intervertebral cartilage which then splits in such a way that the definitive vertebrae are *opisthocelous*, i.e. concave behind, convex in front.

*Ribs*.—In the Crossopterygians a double set of "ribs" is present on each side of the vertebral column, a ventral set lying immediately outside the splanchnocoel lining and apparently serially homologous with the haemal arches of the caudal region, and a second set passing outwards in the thickness of the body wall at a more dorsal level. In the Teleostomes and Dipnoans only the first type is present; in the Selachians only the second. It would appear that it is the latter which is homologous with the ribs of vertebrates above fishes.

*Median Fin Skeleton*.—The foundation of the skeleton of the median fins consists of a series of rod-like elements, the radialia, each of which frequently is segmented into three portions. In a few cases the radialia correspond segmentally with the neural and haemal arches (living Dipnoans, *Pleuracanthus* tail region) and this suggests that they represent morphologically prolongations of the neural and haemal spines. That this is so is rendered probable by the fact that we must regard the evolution of the system of median fins as commencing with a simple flattening of the posterior part of the body. It is only natural to suppose that the edges of the flattened region would be at first supported merely by prolongations of the already existing spinous processes. In the Cyclostomes (where they are branched) and in the Selachians, the radialia form the main supports of the fin, though already in the latter they are reinforced by a new set of fin rays apparently related morphologically to the osseous or placoid skeleton (see below).

The series of radialia tends to undergo the same process of local concentration which characterizes the fin-fold as a whole. In its extreme form this leads to complete fusion of the basal portions of a number of radialia (dorsal fins of *Holoptychius* and various Selachians, and anal fin of *Pleuracanthus*). In view of the identity in function it is not surprising that a remarkable resemblance exists between the mechanical arrangements (of skeleton, muscles, &c.), of the paired and unpaired fins. The resemblance to paired fins becomes very striking in some of the cases where the basal fusion mentioned above takes place (*Pleuracanthus*).

(B) *Chondrocranium*<sup>1</sup>.—In front of the vertebral column lies the cartilaginous trough, the chondrocranium, which protects the brain. This consists of a praechordal portion—

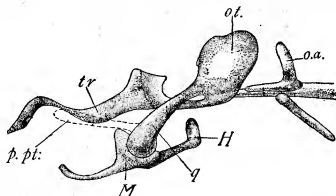

Trans. Roy. Soc. Edinburgh.

FIG. 14.—Chondrocranium of a young *Lepidosteus*, showing the suspension of the lower jaw by the upper portion of the mandibular arch. (After Agur.)

- H, Hyoid arch. q, Quadrate = upper end of mandibular arch.  
 M, Mandibular arch. o.a., Occipital arch. tr, Trabeula.

The palato-ptyergoid bar (*p.p.t.*) is represented by a faint vestige which disappears before the stage figured.

developed out of a pair of lateral cartilaginous rods—the *trabeulae cranii*—and a parachordal portion lying on either side of the anterior end of the notochord. This arises in development

<sup>1</sup> For development cf. Gaupp in Hertwig's *Handbuch der Entwicklungslchre*.

from a cartilaginous rod (parachordal cartilage) lying on each side of the notochord and possibly representing a fused rod of dorsal arcualia. The originally separate parachordals and trabeculae become connected to form a trough-like, primitive cranium, complete or nearly so laterally and ventrally but open dorsally. With the primitive cranium there are also connected cartilaginous capsules developed round the olfactory and auditory organs. There also become fused with the hinder

or anterior margin of the mouth: it is the primitive upper jaw or palato-pterygoquadrate cartilage. The portion of the arch dorsal to the palato-pterygoquadrate outgrowth may form the suspensorial apparatus of the lower jaw, being fused with the cranium at its upper end. This relatively primitive con-arrangement (*protostylic*, as it may be termed) occurs in Dipneusti among fishes (cf. fig. 14). More usually this dorsal part of the mandibular arch becomes reduced, its place being occupied by a ligament (pre-spiracular) uniting the jaw apparatus to the chondrocranium, the upper jaw being also attached to the chondrocranium by the ethmopalatine ligament situated more anteriorly. The main attachment, however, of the jaws to the chondrocranium in such a case, as holds for the majority of fishes, is through the enlarged dorsal segment of the hyoid arch (hyomandibular) which articulates at its dorsal end with the chondrocranium, while its ventral end is attached to the hinge region of the jaw by stout ligamentous bands. A skull in which the jaws are suspended in this manner is termed a *hyostylic* skull (e.g. *Scyllium* in fig. 15).

In *Notidanus* (fig. 15, B) there is a large direct articulation of the upper jaw to the chondrocranium in addition to the indirect one through the hyomandibular: such a skull is amphistylic. In *Heterodontus* the upper jaw is firmly bound to the cranium throughout its length, while in *Holocephali* (fig. 15, C) complete fusion has taken place, so that the lower jaw appears to articulate directly with the cranium ("auto stylic" condition). In Dipneusti<sup>1</sup> (*Lepidosiren* and *Protopterus*) the cartilaginous upper jaw never develops (except in its hinder quadrate portion) beyond the condition of a faint rudiment, owing doubtless to its being replaced functionally by preciously developed bone.

(D) *Appendicular Skeleton*.—The skeleton of the free part of the limb is attached to the limb girdle which lies embedded in the musculature of the body. Each limb girdle is probably to be looked upon as consisting, like the skeleton of the visceral arches, of a pair of lateral half-hoops of cartilage. While in *Pleuracanthus* the lateral halves are distinct (and segmented like the branchial arches), in living Selachians generally the two halves are completely fused ventrally with one another. The part of the girdle lying dorsal to the articulation of the limb is termed scapular in the case of the pectoral limb, iliac in the case of the pelvic, while the ventral portions are known respectively as coracoid and ischio-pubic.

In most Teleostomes the primitive pelvic girdle does not develop; in the Dipneusti it is represented by a median unpaired cartilage.

The skeleton of the free limb is probably seen in the most archaic form amongst existing fishes in the biserial archipterygium of *Ceratodus* (fig. 16). This is indicated by the relative predominance of this type of fin amongst the geologically more ancient fishes. The biserial archipterygium consists of a segmented axial rod, bearing a praeaxial and a postaxial series of jointed rays.

In *Protopterus* and *Lepidosiren* the limbs are reduced and the lateral rays have less (*Protopterus*) or more (*Lepidosiren*) completely disappeared.

<sup>1</sup> Cf. W. E. Agar, *Trans. Roy. Soc. Edin.* xlv. (1906), 49.

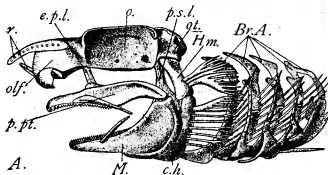

After W. K. Parker, *Trans. Zool. Soc. London*.

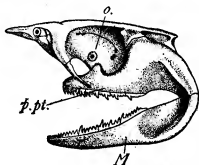

After Gegenbaur, *Untersuchungen zur verg. Anat. der Wirbeltiere*, by permission of Wilhelm Engelmann.

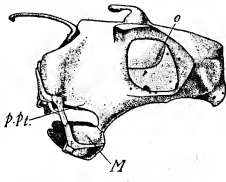

After Hübner, Brown's *Tierreich*, by permission of Gustav Fischer.

FIG. 15.—Chondrocranium, &c. of *Scyllium* (A), *Notidanus cinereus* (B) and *Chimaera* (C).

Br.A. Branchial arches. olf. Olfactory capsule.  
c.h. Ceratohyal. ol. Olfactory capsule.  
e.p.l. Ethmopalatine ligament. p.pt. Palato-pterygoquad bar.  
Hm. Hyomandibular. p.s.l. Prespiracular ligament.  
M. Meckel's cartilage. r. Rostrum.  
o. Orbit.

end of the cranium a varying number of originally distinct neural arches.

(C) *Visceral Arches*.—The skeleton of the visceral arches consists essentially of a series of half-hoops of cartilage, each divided in the adult into a number of segments and connected with its fellow by a median ventral cartilage. The skeleton of arches I. and II. (mandibular and hyoidean) undergoes modifications of special interest (figs. 14 and 15). The lower portion of the mandibular arch becomes greatly thickened to support the lower or hinder edge of the mouth. It forms the primitive lower jaw or "Meckel's cartilage." Dorsal to this an outgrowth arises from the anterior face of the arch which supports the upper

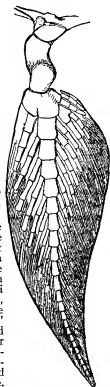

FIG. 16.—Fore-limb of *Ceratodus*.

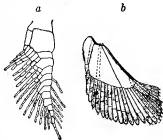
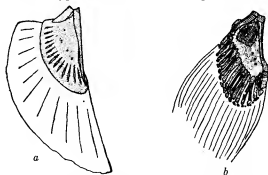

FIG. 17.—a, Skeleton of pectoral limb of *Pleuracanthus*. (From Gegenbaur, after Fritsch.) b, Skeleton of pectoral limb of *Acanthias*. (After Gegenbaur.)

This type of fin amongst the geologically more ancient fishes. The biserial archipterygium consists of a segmented axial rod, bearing a praeaxial and a postaxial series of jointed rays.

In *Protopterus* and *Lepidosiren* the limbs are reduced and the lateral rays have less (*Protopterus*) or more (*Lepidosiren*) completely disappeared.

In such an archaic Selachian as *Pleuracanthus* the fin is clearly of the biserial archipterygial type, but the lateral rays are reduced (pectoral) or absent (pelvic) (fig. 17, a) on one side of the axis. In a typical adult Selachian the pectoral fin skeleton



From Budgett, *Trans. Zool. Soc. London*, xvi, part vii. From Wiedersheim's *Verg. Anat. der Wirbeltiere*, by permission of Gustav Fischer.

FIG. 18.—Skeleton of Pectoral Limb of *Polypterus*. a, 30 mm. larva. b, Adult.

has little apparent resemblance to the biserial archipterygium—the numerous outwardly directed rays springing from a series of large basal cartilages (*pro-, meso-, and meta-ptyergium*). The condition in the young (e.g. fig. 17, b, *Acanthias*) hints strongly, however, at the possibility of the fin skeleton being really a modified biserial archipterygium, and that the basal cartilages represent the greatly enlarged axis which has become fixed back along the side of the body. In Crossopterygians (*Polypterus*) the highly peculiar fin skeleton (fig. 18) while still in the embryonic cartilaginous stage is clearly referable to a similar condition. In the



From Wiedersheim's *Verg. Anat. der Wirbeltiere*, by permission of Gustav Fischer.

FIG. 19.—Skeleton of Pectoral Fin of Actinopterygians—with the increased development of dermal fin rays—there comes about reduction of the primitive limb skeleton. The axis becomes particularly

reduced, and the fin comes to be attached directly to the pectoral girdle by a number of basal pieces (Teleosts) probably representing vestigial rays (cf. fig. 19).

Views on the general morphology of the fin skeleton are strongly affected by the view held as to the mode of evolution of the fins. By upholders of the lateral fold hypothesis the type of fin skeleton described for *Cladoseleache*<sup>1</sup> is regarded as particularly primitive. It is, however, by no means clear that the obscure basal structures figured (Fig. 20) in this fin do not really represent the pressed back axis as in *Pleuracanthus*.

The pelvic fin skeleton, while built obviously on the same plan as the pectoral, is liable to much modification and frequently degeneration.

*Ossous or Bony Skeleton*.—The most ancient type of bony skeleton appears to be represented in the placoid elements such

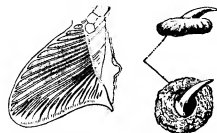

From Bashford Dean, *Mem. N.Y. Acad. of Science*.

FIG. 20.—Skeleton of Pectoral Fin of *Cladoseleache*.

as are seen in the skin of the Selachian (fig. 21). Each placoid element consists of a spine with a broadly expanded base embedded in the dermis. The base is composed of bone: the spine of the somewhat modified bone known as dentine. Ensheathing the tip of the spine is



FIG. 21.—Placoid elements of a male Thorn-back, *Raia clavata*.

a layer of extremely hard enamel formed by the inner surface of the ectoderm which originally covered it. Such typical placoid

scales are well seen on any ordinary skate. In the groups of fishes above the Selachians, the coating of placoid elements shows various modifications. The spines disappear, though they may be present for a time in early development. The bony basal plates tend to undergo fusion—in certain cases they form a continuous bony cuirass (various Siluroides, trunk-fishes) formed of large plates jointed together at their edges. More usually the plates are small and regular in size. In Crossopterygians and *Lepidosteus* and in many extinct forms the scales are of the ganoid type, being rhomboidal and having their outer layer composed of hard glistening ganoin. In other Teleostomes the scales are as a rule thin, rounded and overlapping—the so-called cycloid type (fig. 22, A); where the posterior edge shows toothlike projections the scale is termed ctenoid (fig. 22, B). In various Teleosts the scales are vestigial (ecl); in others (as in most electric fishes) they have completely disappeared.

*Teeth*.—Certain of the placoid elements belonging to that part of the skin which gives rise to the lining of the stomodaeum have their spines enlarged or otherwise modified to form teeth. In the majority of fishes these remain simple, conical structures: in some of the larger sharks (*Carcharodon*) they become flattened into trenchant blades with serrated edges: in certain rays (*Myliobatis*) they form a pavement of flattened plates suited for crushing molluscan shells. In the young *Neoceratodus*<sup>2</sup>

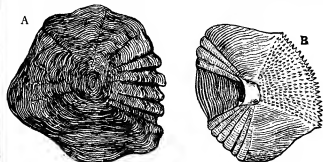

FIG. 22.—A, Cycloid Scale of *Scopelus resplendens* (magn.). B, Ctenoid Scale of *Lethrinus* (magn.).

there are numerous small conical teeth, the bases of which become connected by a kind of spongework of bony trabeculae. As development goes on a large basal mass is formed which becomes the functional tooth plate of the adult, the original separate denticles disappearing completely. In the other two surviving Dipnoans, similar large teeth exist, though here there is no longer trace in ontogeny of their formation by the basal fusion of originally separate denticles. In the Selachians the bony skeleton is restricted to the placoid elements. In the Teleostomes and the Dipnoans the original cartilaginous skeleton becomes to a great extent unsheathed or replaced by bony tissue. It seems highly probable that the more deeply seated osseous elements occurring in these as in the higher groups arose in the course of evolution by the spreading inwards of bony trabeculae from the bases of the placoid elements. Such a method has been demonstrated as occurring in individual development in the case of certain of the more superficially placed bones.<sup>3</sup>

The placoid element with its cap of enamel secreted by the ectoderm is probably originally derived from a local thickening of the basement membrane which with the external cuticle may be looked on as the most ancient skeletal structure in the Metazoa. The basal plate appears to have been a later development than the spine: in the palaeozoic *Coelolepidae*<sup>4</sup> the basal plate is apparently not yet developed.

Only a brief summary can be given here of the leading features in the osteology of fishes. Care must be taken not to assume that bony elements bearing the same name in fishes and in other groups, or even in the various sub-divisions of the fishes, are necessarily strictly homologous. In all probability bony elements occupying similar positions and described by the same anatomical

<sup>2</sup> R. Semon, *Zool. Forschungsreisen*, Band i. § 115.

<sup>3</sup> O. Hertwig, *Arch. mikr. Anat.* xi. (1874).

<sup>4</sup> R. H. Traquair, *Trans. Roy. Soc. Edin.* xxxix. (1899).

<sup>1</sup> Bashford Dean, *Journ. Morph.* ix. (1894) 87, and *Trans. New York Acad. Sci.* xiii. (1894) 115.



name have been evolved independently from the ancestral covering of placoid elements.

**Teleostei.**—It will be convenient to take as the basis of our description the bony skeleton of such a Teleostean fish as the salmon. In the vertebral column all the cartilaginous elements are replaced by bone. The haemal spines of the turned-up tip of the tail are flattened (hypural bones) and serve to support the caudal fin rays.

In *Argyroleplecus* and in one or two deep-sea forms the vertebral column remains cartilaginous.

Apart from the ossification of the radially which takes place in the adults of bony fishes there exist special supporting structures in the fins (paired as well as median) of all the gnathostomatous fishes and apparently in nature independent of the cartilaginous skeleton. These are known as dermal fin-rays.<sup>1</sup> Morphologically they are probably to be looked on (like placoid elements) as local exaggerations of the basement membrane.

In their detailed characters two main types of dermal fin-ray may be recognized. The first of these are horny unjointed rays and occur in the fins of Selachians and at the edge of the fins of Teleostomes (well seen in the small posterior dorsal or "adipose" fin, particularly in Siluroids). The second type of dermal fin-ray is originally arranged in pairs and forms the main supports of the fin in the adult Teleost (fig. 23). The members of each pair are in close contact except proximally where they separate and embrace the tip of one of the radials. The fin-rays of this second type are frequently branched and jointed; in other cases they form unbranched rigid spines.

In the angler or fishing-frog (*Lophius*) the anterior rays of the dorsal fin become greatly elongated to form small fishing-rods, from which depend bait-like lures for the attraction of its prey.

In the skull of the adult salmon it is seen that certain parts of the chondrocranium (fig. 24) have been replaced by bone ("cartilage bones") while other more superficially placed bones ("membrane bones") cover its surface (fig. 25). Of cartilage bones four are developed round the foramen magnum—the basioccipital, supraoccipital and two exoccipitals. In front of

pair of lateral ethmoids lying at the anterior boundary of the orbit. A series of five distinct elements are ossified in the wall of the auditory or otic capsule, the prootic and opisthotic more ventrally, and the sphenotic, pterotic and epiotic more dorsally. The roof of the cranium is covered in by the following dermal bones—parietals (on each side of the supraoccipital), frontals, dermal ethmoid and small nasals, one over each olfactory organ. The floor of the cranium on its oral aspect is ensheathed by the large parasphenoid and the smaller vomer in front of and overlapping it. The cartilaginous lower jaw is ossified posteriorly to form the articular (fig. 25) with a small membrane bone, the angular, ventral to it, but the main part of the jaw is replaced functionally by a large membrane bone which ensheathes it—the dentary—evolved in all probability by the spreading outwards of bony tissue from the bases of the placoid elements (teeth) which it bears. The original upper jaw (palato-pterygoid bar) is replaced by a chain of bones—palatine in front, then

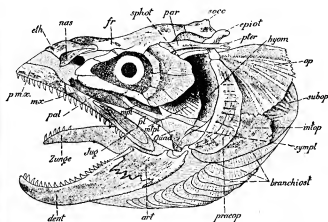

From Wiedersheim, *Verg. Anat. der Wirbeltiere*, by permission of Gustav Fischer.

FIG. 25.—Complete Skull of Salmon from left side.

art,	Articular.	op,	Opercular.
branchiost,	Branchiostegal.	pal,	Palatine.
dent,	Dentary.	par,	Parietal.
epio,	Epiotic.	pmax,	Premaxilla.
eth,	Dermal ethmoid.	preop,	Preopercular.
fr,	Frontal.	pt,	Pterygoid.
hyom,	Hyomandibular.	pter,	Pterotic.
intop,	Interopercular.	quad,	Quadrate.
jugal,	Jugal.	socc,	Supraoccipital.
mpl,	Mesopterygoid.	sphen,	Sphenotic.
mtpl,	Metapterygoid.	subop,	Subopercular.
mx,	Maxilla.	symp,	Symplectic.
nas,	Nasal.	Zunge,	Tongue.

pterygoid and mesopterygoid, and posteriorly metapterygoid and quadrate, the latter giving articulation to the articular bone of the lower jaw. These representatives of the palatopterygoid bar no longer form the functional upper jaw. This function is performed by membrane bones which have appeared external to the palatopterygoid bar—the premaxilla and maxilla—which carry teeth—and the small scale-like jugal behind them. The quadrate is suspended from the skull as in the Selachians (hyostylic skull) by the upper portion of the hyoid arch—here represented by two bones—the hyomandibular and symplectic. The ventral portion of the hyoid arch is also represented by a chain of bones (styhoidal, epihyal, ceratohyal, hypohyal and the ventral unpaired basihyal), as is also each of the five branchial arches behind it. In addition to the bony elements belonging to the hyoid arch proper a series of membrane bones support the opercular flap. Ventrally these project backwards from the ceratohyal a series of ten overlapping branchiostegal rays, while more dorsally are the broader interopercular, subopercular and opercular.

In addition to the bones already enumerated there is present a ring of circumorbital bones, a preopercular, behind and external to the hyomandibular and quadrate, and squamosal, external to the hinder end of the auditory capsule.



From Parker & Haswell's *Fishes of the World*, by permission of Messrs. Macmillan & Co., Ltd.

FIG. 23.—One of the radials of the salmon, consisting of three segments.  $plg^1$ ,  $plg^2$ ,  $plg^3$ , and supporting a dermal fin ray D.F.R.

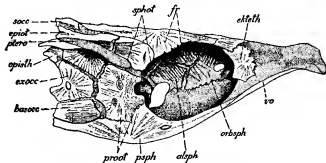

From Wiedersheim, *Verg. Anat. der Wirbeltiere*, by permission of Gustav Fischer.

FIG. 24.—Chondrocranium of Salmon, seen from the right side.

al sph,	Alisphenoid.	orb sph,	Orbitosphenoid.
basi occ,	Basioccipital.	proot,	Prootic.
ek eth,	Lateral ethmoid.	psph,	Parasphenoid.
epio,	Epiotic.	ptero,	Pterotic.
ex occ,	Exoccipital.	socc,	Supra occipital.
fr,	Frontal.	sphen,	Sphenotic.
opisth,	Opisthotic.	vo,	Vomer.

the basioccipital is the basisphenoid with an alisphenoid on each side. The region (presphenoid) immediately in front of the basisphenoid is unossified, but on each side of it an orbitosphenoid is developed, the two orbitosphenoids being closely approximated in the mesial plane and to a certain extent fused, forming the upper part of the interorbital septum. In the anterior or ethmoidal portion of the cranium the only cartilage bones are a

<sup>1</sup> Cf. E. S. Goodrich, *Quart. Journ. Micr. Sci.* xviii. (1904). 465.

In the salmon, pike, and various other Teleosts, extensive regions of the chondrocranium persist in the adult, while in others (e.g. the cod) the replacement by bone is practically complete. Bony elements may be developed in addition to those noticed in the salmon.

In the sturgeon the chondrocranium is ensheathed by numerous membrane bones, but cartilage bones are absent. In the *Crossopterygians*<sup>1</sup> the chondrocranium persists to a great extent in the adult, but portions of it are replaced by cartilage bones—the most interesting being a large sphenethmoid like that of the frog. Numerous membrane bones cover the chondrocranium externally. In the Dipneusti<sup>2</sup> the chondrocranium is strengthened in the adult by numerous bones. One of the most characteristic is the great palatopterygoid bone which develops very early by the spreading of ossification backwards from the tooth bases, and whose early development probably accounts for the non-development of the palatopterygoid cartilage.

**Appendicular Skeleton.**—The primitive pectoral girdle, which in the Dipneusti is strengthened by a sheath of bone, becomes in the Teleostomes reduced in size (small scapula and coracoid bones) and replaced functionally by a secondary shoulder girdle formed of superficially placed membrane bones (supraclavicular and cleithrum or "clavicle," with, in addition in certain cases, an infraclavicular and one or two postclavicular elements), and connected at its dorsal end with the skull by a post-temporal bone.

The pelvic girdle is in Teleostomes completely absent as a rule.

The skeleton of the free limb undergoes ossification to a less or greater extent in the Teleostomes.

In *Polypterus* the pectoral fin (fig. 18, B) shows three ossifications in the basal part of the fin—pro-, meso- and metapterygium. Of these the metapterygium probably represents the ossified skeletal axis: while the propterygium and also the numerous diverging radials probably represent the lateral rays of one side of the archipterygium.

In the *Teleostomes* the place of the pelvic girdle is taken functionally by an element apparently formed by the fusion of the basal portions of several radials.

**Vascular System.**—The main components of the blood vascular system in the lower vertebrates are the following: (1) a single or double dorsal aorta lying between the enteron and notochord; (2) a ventral vessel lying beneath the enteron; and (3) a series of paired hoop-like aortic arches connecting dorsal and ventral vessels round the sides of the pharynx. The blood-stream passes forwards towards the head in the ventral vessel, dorsalswards through the aortic arches, and tailwards in the dorsal aorta.

The dorsal aorta is single throughout the greater part of its extent, but for a greater or less extent at its anterior end (*circulus cephalicus*) it consists of two paired aortic roots. It is impossible to say whether the paired or the unpaired condition is the more primitive, general morphological conditions being in favour of the latter, while embryological evidence rather supports the former. The dorsal aorta, which receives its highly oxygenated blood from the aortic arches, is the main artery for the distribution of this oxygenated blood. Anteriorly the aortic roots are continued forwards as the dorsal carotid arteries to supply the head region. A series of paired, segmentally-arranged arteries pass from the dorsal aorta to supply the muscular body wall, and the branches which supply the pectoral and pelvic fins (subclavian or brachial artery, and iliac artery) are probably specially enlarged members of this series of segmental vessels. Besides these paired vessels a varying number of unpaired branches pass from dorsal aorta to the wall of the alimentary canal with its glandular diverticula (coeliac, mesenteric, rectal).

The ventral vessel undergoes complicated changes and is represented in the adults of existing fishes by a series of important structures. Its post-anal portion comes with the atrophy of the post-anal gut to lie close under the caudal portion of the dorsal aorta and is known as the caudal vein. This assumes a secondary connexion with, and drains its blood into, the posterior cardinal veins (see below). In the region between cloaca and liver the ventral vessel becomes much branched or even reticular and—

serving to convey the food-laden blood from the wall of the enteron to the capillary network of the liver—is known as the hepatic portal vein. The short section in front of the liver is known as the hepatic vein and this conveys the blood, which has been treated by the liver, into a section of the ventral vessel, which has become highly muscular and is rhythmically contractile. This enlarged muscular portion, in which the contractility—probably once common to the main vessels throughout their extent—has become concentrated, serves as a pump and is known as the heart. Finally the precardiac section of the ventral vessel—the ventral aorta—conveys the blood from heart to aortic arches.

In addition to the vessels mentioned a large paired vein is developed in close relation to the renal organ which it serves to drain. This is the posterior cardinal. An anterior prolongation (anterior cardinal) serves to drain the blood from the head region. From the point of junction of anterior and posterior cardinal a large transverse vessel leads to the heart (*ductus Cuvieri*).

**Heart.**—Originally a simple tube curved into a somewhat S-shape, the heart, by enlargements, constrictions and fusions of its parts, becomes converted into the complex, compact heart of the adult. In this we recognize the following portions—(1) *Sinus venosus*, (2) *Atrium*, (3) *Ventricle*. A fourth chamber, the *conus arteriosus*, enlarged and contractile hinder end of the ventral aorta, is also physiologically a part of the heart. The sinus venosus receives the blood from the great veins (ductus Cuvieri and hepatic veins).

It—like the atrium which it enters by an opening guarded by two lateral valves—has thin though contractile walls. The atrium is as a rule single, but in the Dipnoans, in correlation with the importance of their pulmonary breathing, it is incompletely divided into a right and a left auricle. In *Neoceratodus* the incomplete division is effected by the presence of a longitudinal shelf projecting into the atrial cavity from its posterior wall. The opening of the sinus venosus is to the right of this shelf, that of the pulmonary vein to the left. In *Prototerus* and *Lepidosiren* a nearly complete septum is formed by the fusion of trabeculae, there being only a minute opening in it posteriorly. The atrium opens by a wide opening guarded by two or more flap valves provided with chordae tendinae into the ventricle.

The ventricle, in correspondence with it being the main pumping apparatus, has its walls much thickened by the development of muscular trabeculae which, in the lower forms separated by wide spaces in which most of the blood is contained, become in the Teleostomes so enlarged as to give the wall a compact character, the spaces being reduced to small scattered openings on its inner surface. In the Dipnoans the ventricle, like the atrium, is incompletely divided into a right and left ventricle. In *Ceratodus* this is effected by an extension of the interauricular shelf into the ventricle. In *Lepidosiren* the separation of the two ventricles is complete but for a small perforation anteriorly, the heart in this respect showing a closer approximation to the condition in the higher vertebrates than is found in any Amphibians or in any reptiles except the Crocodylia. The *conus arteriosus* is of interest from the valvular arrangements in its interior to prevent regurgitation of blood from ventral aorta into ventricle. In their simplest condition, as seen e.g. in an embryonic Selachian, these arrangements consist of three, four or more prominent longitudinal ridges projecting into the lumen of the conus, and serving to obliterate the lumen when jammed

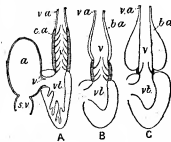

From Boss, *Lehrbuch der Zoologie*, by permission of Gustav Fischer.

FIG. 26.—Diagram to illustrate the condition of the Conus in an Elasmobranch (A), *Amia* (B) and a typical Teleost (C).

a, Atrium.  
b.a, Bulbus aortae.  
c.a, Conus arteriosus.  
s.v, Sinus venosus.  
v, v', Valves.  
v.a, Ventral aorta.  
v', Ventricle.

<sup>1</sup> R. H. Traquair, *Journ. Anat. Phys. v.* (1871) 166; J. S. Budgett, *Trans. Zool. Soc. Lond.* xiv. 315.

<sup>2</sup> T. W. Bridge, *Trans. Zool. Soc. Lond.* xiv. (1898) 350; W. E. Agar, *op. cit.*

together by the systole of the conus. As development goes on each of these ridges becomes segmented into a row of pocket valves with their openings directed anteriorly so that regurgitation causes them to open out and occlude the lumen by their free edges meeting. Amongst the Teleostomes the lower ganoids show a similar development of longitudinal rows of valves in the conus. In *Amia* (fig. 26, B), however, the conus is shortened

and the number of valves in each longitudinal row is much reduced. This leads to the condition found in the Teleosts (fig. 26, O), where practically all trace of the conus has disappeared, a single circle of valves representing a last survivor of each row (save in a few exceptional cases, e.g. *Albula*, *Tarpon*, *Osteoglossum*, where two valves of each row are present).

In front of the conus vestige of the Teleost there is present a thick walled *bulbus aortae* differing from the conus in not being rhythmically contractile, its walls being on the contrary richly provided with elastic tissue.

The Dipnoans<sup>1</sup> show an important advance in the conus as in atrium and ventricle. The conus has a characteristic spiral twist. Within it in *Neoceratodus* are a number of longitudinal rows of pocket valves. One of these rows is marked out by the very large size of its valves and by the fact that they are not distinct from one another but even in the adult form a continuous, spirally-running, longitudinal fold. This ridge projecting into the lumen of the conus divides it incompletely into two channels, the one beginning (i.e. at its hinder end) on the left side and ending in front ventrally, the other beginning on the right and ending dorsally. In *Protopterus* a similar condition occurs, only in the front end of the conus a second spiral fold is present opposite the first and, meeting this, completes the division of the conus cavity into two separate parts. The rows of pocket valves which do not enter into the formation of the spiral folds are here greatly reduced.

These arrangements in the conus of the Dipnoans are of the highest morphological interest, pointing in an unmistakable way towards the condition found in the higher lung-breathing vertebrates. Of the two cavities into which the conus is partially divided in the Dipneusti the one which begins posteriorly on the right receives the (venous) blood from the right side of the heart, and ending up anteriorly dorsal to the other cavity communicates only with aortic arches V. and VI. In the higher vertebrates this cavity has become completely split off to form the root of the pulmonary arteries, and a result of aortic arch V. receiving its blood along with the functionally much more important VI. (the pulmonary arch) from this special part of the conus has been the almost complete disappearance of this arch (V.) in all the higher vertebrates.

**Arterial System.**—There are normally six aortic arches laid down corresponding with the visceral arches, the first (mandi-

bular) and second (hoyoidean) undergoing atrophy to a less or greater extent in post-embryonic life. Where an external gill is present the aortic arch loops out into this, a kind of short-circuiting of the blood-stream taking place as the external gill atrophies. As the walls of the clefts assume their respiratory function the aortic arch becomes broken into a network of capillaries in its respiratory portion, and there is now distinguished a ventral afferent and a dorsal efferent portion of each arch. Complicated developmental changes, into which it is unnecessary to enter,<sup>2</sup> may lead to each efferent vessel draining the two sides of a single cleft instead of the adjacent walls of two clefts as it does primitively. In the Crossopterygians and Dipnoans as in the higher vertebrates the sixth aortic arch gives off the pulmonary artery to the lung. Among the Actinopterygians this, probably primitive, blood-supply to the lung (swim-bladder) persists only in *Amia*.

**Venous System.**—The most interesting variations from the general plan outlined have to do with the arrangements of the posterior cardinals. In the Selachians these are in their anterior portion wide and sinus-like, while in the region of the kidney they become broken into a sinusoidal network supplied by the postrenal portion now known as the renal portal vein. In the Teleostomes the chief noteworthy feature is the tendency to asymmetry, the right posterior cardinal being frequently considerably larger than the left and connected with it by transverse anastomotic vessels, the result being that most of the blood from the two kidneys passes forwards by the right posterior cardinal. The Dipnoans (fig. 27) show a similar asymmetry, but here the anterior end of the right posterior cardinal disappears, being replaced functionally by a new vessel which conveys the blood from the right posterior cardinal to the sinus venosus instead of to the outer end of the ductus Cuvieri. This new vessel is the posterior vena cava which thus in the series of vertebrates appears for the first time in the Dipneusti.

**Pulmonary Veins.**—In *Polypterus* (fig. 28) the blood is drained from the lungs by a pulmonary vein on each side which unites in front with its fellow and opens into the great hepatic vein behind the heart. In the Dipnoans the conjoined pulmonary veins open directly into the left section of the atrium as in higher forms. In the Actinopterygians with their specialized air-bladder the blood passes to the heart via posterior cardinals, or hepatic portal, or—a probably more primitive condition—directly into the left ductus Cuvieri (*Amia*).

**Lymphatics.**—More or less irregular lymphatic spaces occur in the fishes as elsewhere and, as in the Amphibia, localized muscular developments are present forming lymph hearts.

**Central Nervous System.**—The neural tube shows in very early stages an anterior dilated portion which forms the rudiment of the brain in contradistinction to the hinder, narrower part which forms the spinal cord. This enlargement of the brain is correlated with the increasing predominance of the nerve

<sup>1</sup> Cf. F. Hochstetter in O. Hertwig *Handbuch der Entwicklungslehre*.

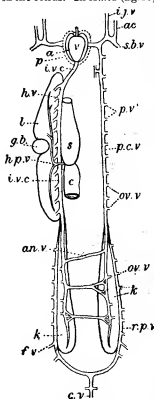

After Newton Parker, from *Trans. of the Royal Irish Academy*, vol. xxx.

FIG. 27.—Venous System of *Protopterus*, as seen from ventral side.

- a., Atrium.
- ac., Anterior cardinal.
- an.v., Anatomostomic vein.
- c., Intestine.
- c.v., Caudal vein.
- f.v., Femoral vein.
- g.b., Gall-bladder.
- h.v., Hepatic vein.
- i.j.v., Inferior jugular vein.
- i.r.v., Inferior renal vein.
- p.c.v., Posterior vena cava.
- k., Kidney.
- l., Liver.
- ov.v., Ovarian veins.
- p.c., Pericardium.
- p.p.v., Left posterior cardinal.
- p.v., Parietal veins.
- r.p.v., Renal portal.
- s., Stomach.
- s.b.v., Subclavian.

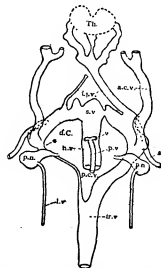

FIG. 28.—Venous System of *Polypterus* 30 mm. larva (dorsal view).

- a.c.v., Anterior cardinal vein.
- d.c., Ductus Cuvieri.
- h.v., Hepatic vein.
- i.j.v., Inferior jugular vein.
- i.r.v., Inferior renal vein.
- l.v., Lateral cutaneous vein.
- p.c.v., Posterior cardinal vein.
- p.n., Pronephros.
- p.v., Pulmonary vein.
- s.b.v., Subclavian vein.
- s.v., Sinus venosus.
- Th., Thyroid.
- v., Vein from pharyngeal wall.
- \*
- Anterior portion of left posterior cardinal vein.

<sup>1</sup> J. V. Boas, *Morphol. Jahrb.* vi. (1880).

centres at the anterior end of the body which tend to assume more and more complete control over those lying behind.

**Spinal Cord.**—A remarkable peculiarity occurs in the sun fishes (*Molidae*), where the body is greatly shortened and where the spinal cord undergoes a corresponding abbreviation so as to be actually shorter than the brain.

**Brain.**—It is customary to divide the brain into three main regions, fore-, mid-, and hind-brain, as in the most familiar vertebrates there is frequently seen in the embryo a division of the primitive brain dilatation into three vesicles lying one behind the other. A consideration of the development of the brain in the various main groups of vertebrates shows that these divisions are not of equal importance. In those archaic groups where the egg is not encumbered by the presence of a large mass of yolk it is usual for the brain to show in its early stages a division into two main regions which we may term the primitive fore-brain or cerebrum and the primitive hind-brain or rhombencephalon. Only later does the hinder part of the primitive fore-brain become marked off as mid-brain. In the fully developed brain it is customary to recognize the series of regions indicated below, though the boundaries between these regions are not mathematical lines or surfaces any more than are any other biological boundaries:—

Rhombencephalon (Hind-brain)	{ Myelencephalon (Medulla oblongata).
	{ Metencephalon (Cerebellum).
Cerebrum (Primitive Fore-brain)	{ Mesencephalon (Mid-brain).
	{ Thalamencephalon (Diencephalon).
	{ [Hemispheres (Telencephalon).]

The myelencephalon or medulla oblongata calls for no special remark, except that in the case of *Torpedo* there is a special upward bulging of its floor on each side of the middle line forming the electric lobe and containing the nucleus of origin of the nerves to the electric organ.

The cerebellum occurs in its simplest form in lampreys and Dipnoans (fig. 20, C), where it forms a simple band-like thickening of the anterior end of the roof of the hind-brain. In Selachians

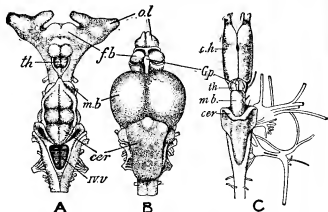

A and B from Wiedersheim, by permission of Gustav Fischer.

FIG. 29.—Brain of *Scyllium* (A), *Salmo* (B) and *Lepidosiren* (C).

The three figures are not drawn to the same scale.

cer, Cerebellum.	G.p., Pineal body.
c.h., Cerebral hemisphere.	m.b., Roof of mid-brain, optic lobes, tectum opticum.
th, Thalamencephalon.	o.l., Olfactory lobe.
f.b., Primitive fore-brain (in B the line points to the thickened wall of the fore-brain, the so-called "basal ganglia").	IV.v., Fourth ventricle.

it is very large and bulges upwards, forming a conspicuous organ in a dorsal view of the brain (fig. 20, A). In Teleosts (fig. 20, B) the cerebellum is also large. It projects back as a great tongue-like structure over the roof of the fourth ventricle, while in front it dips downwards and projects under the roof of the mid-brain forming a highly characteristic *valvula cerebelli*. A *valvula cerebelli* occurs also in ganoids, while in the Crossopterygians a similar extension of the cerebellum projects backwards into the IV. ventricle or cavity of the hind-brain (fig. 30).

The mesencephalon is a conspicuous structure in the fishes from its greatly developed roof (*tectum opticum*) which receives the end pencils of the optic nerve. Normally it projects upwards as a pair of large optic lobes, but in the Dipnoans (fig. 29, C) the lateral thickening is not sufficiently great to cause obvious lateral swellings in external view.

The thalamencephalon is one of the most interesting parts of the brain from its remarkable uniformity throughout the Vertebrata. Even in *Amphioxus* the appearance of a sagittal section strongly suggests vestiges of a once present thalamencephalon.<sup>1</sup> The roof—like that of the myelencephalon—remains

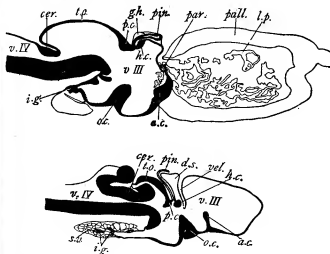

FIG. 30.—Median Longitudinal Section through the brain of *Lepidosiren* and *Polypterus*. In the upper figure (*Lepidosiren*) the habenuular ganglion and hemisphere are shown in outline though not actually present in a median section.

a.c., Anterior commissure.	par., Paraphysis.
cer., Cerebellum.	pin., Pincal body.
d.s., Dorsal sac.	p.c., Posterior commissure.
g.h., Habenuular ganglion.	s.v., Saccus vasculosus.
h.c., Habenuular commissure.	t.o., Tectum opticum.
i.g., Infundibular gland.	v.III, Third ventricle.
i.p., Lateral plexus.	v.IV, Fourth ventricle.
o.c., Optic chiasma.	vel., Velum transversum.
pall., Pallium.	

to a great extent membranous, forming with the closely applied *pia mater* a vascular roof to the III. ventricle. Frequently a transverse fold of the roof dips down into the III. ventricle forming the *velum transversum* (fig. 30).

The side walls of the thalamencephalon are greatly thickened forming the *thalamus* (epithalamus and hypothalamus), while a ganglionic thickening of the roof posteriorly on each side forms the *ganglia habenuularia* which receive olfactory fibres from the base of the hemisphere. The habenuular ganglia are unusually large in the lampreys and are here strongly asymmetrical, the right being the larger.

The floor of the thalamencephalon projects downwards and backwards as the infundibulum. The side walls of this are thickened to form characteristic *lobi inferiores*, while the blind end develops glandular outgrowths (infundibular gland, fig. 30) overlaid by a rich development of blood sinuses and forming with them the *saccus vasculosus*. The optic chiasma, where present, is involved in the floor of the thalamencephalon and forms a large, upwardly-projecting ridge. Farther forwards on the floor or anterior wall is the anterior commissure (see below).

Passing forwards from the mid-brain (cf. fig. 30) a series of interesting structures are found connected with the roof of the primitive fore-brain, viz.—posterior commissure (intercalary region), pincal organ, habenuular commissure with anterior parietal organ, dorsal sac (= pincal cushion), *velum transversum*, paraphysis. The posterior commissure is situated in the boundary between thalamencephalon and mid-brain. It is formed of

<sup>1</sup>C. v. Kupffer, *Studien z. vergl. Entwicklungsgeschichte der Cranioten*.

fibres connecting up the right and left sides of the tectum opticum (?). The habenular or superior commissure situated farther forwards connects the two ganglia habenulae. In the immediate neighbourhood of these ganglia there project upwards two diverticula of the brain-roof known as the pineal organ and the parapineal (or anterior parietal) organ. The special interest of these organs<sup>1</sup> lies in the fact that in certain vertebrates one (parapineal in *Sphenodon* and in lizards) or both (*Petromyzon*) exhibit histological features which show that they must be looked on as visual organs or eyes. In gnathostomatous fishes they do not show any definite eye-like structure, but in certain cases (*Polyodon*, *Callichthys*, &c.) the bony plates of the skull-roof are discontinuous over the pineal organ forming a definite parietal foramen such as exists in lizards where the eye-like structure is distinct. It is also usual to find in the epithelial wall of the pineal organ columnar cells which show club-shaped ends projecting into the lumen (exactly as in the young visual cells of the retina<sup>2</sup>) and are prolonged into a root-like process at the other end. Definite nerve fibres pass down from these parietal organs to the brain. It is stated that the fibres from the pineal organ pass into the posterior commissure, those of the parapineal organ into the habenular commissure.

The facts mentioned render it difficult to avoid the conclusion that these organs either have been sensory or are sensory. Possibly they represent the degenerate and altered vestiges of eye-like organs present in archaic vertebrates, or it may be that they represent the remains of organs not eye-like in function but which for some other reason lay close under the surface of the body. It would seem natural that a diverticulum of brain-tissue exposed to the influence of light-rays should exhibit the same reaction as is shown frequently elsewhere in the animal kingdom and tend to assume secondarily the characters of a visual organ. The presence of the rod-like features in the epithelial cells is perhaps in favour of the latter view. In evolution we should expect these to appear before the camera-like structure of a highly developed eye, while in the process of degeneration we should expect these fine histological characters to go first.

Selachians.—No parapineal organ is present. The pineal body (except in *Torpedo* where it is absent) is in the form of a long slender tube ending in front in a dilated bulb lying near the front end of the brain in close contact with, or enclosed in, a definite foramen in the cranial roof.

Holocephali and Crossopterygii.—Here also the pineal body is long and tubular: at its origin it passes dorsalswards or slightly backwards behind the large dorsal sac.

Actinopterygian Ganoids resemble Selachians on the whole. In *Amia* a parapineal organ is present, and it is said to lie towards the left side and to be connected by a thick nerve with the left habenular ganglion (cf. *Petromyzon*, article CYCLOSTOMATA). This is adduced to support the view that the pineal and parapineal bodies represent originally paired structures.

Teleostei.—A parapineal rudiment appears in the embryo of some forms, but in the adult only the pineal organ is known to exist. This is usually short and club-shaped, its terminal part with much folded wall and glandular in character. In a few cases a parietal foramen occurs (*Callichthys*, *Loricaria*, &c.).

Dipneusti.—The pineal organ is short and simple. No parapineal organ is developed.

The dorsal sac is formed by that part of the roof of the thalamencephalon lying between the habenular commissure and the region of the velum. In some cases a longitudinal groove is present in which the pineal organ lies (Dipneusti). In the Crossopterygians the dorsal sac is particularly large and was formerly mistaken for the pineal organ.

The *velum transversum* is a transverse, inwardly-projecting fold of the roof of the primitive fore-brain in front of the dorsal sac. To those morphologists who regard the hemisphere region or telencephalon as a primitively unpaired structure the velum is an important landmark indicating the posterior limit of the telencephalon. Those who hold the view taken in this article

that the hemispheres are to be regarded as paired outpushings of the side wall of the primitive fore-brain attribute less morphological importance to the velum. Physiologically the velum is frequently important from the plexus of blood-vessels which passes with it into the III. ventricle.

In *Petromyzon* and *Chimaera* the velum is not developed. In Dipnoans there are present in its place paired transverse folds which are probably merely extensions backwards of the lateral plexuses.

The Paraphysis is a projection from the roof of the primitive fore-brain near its anterior end. It is well seen in Dipnoans<sup>3</sup> (*Lepidosiren* and *Protopterus*) where in the larva (exactly as in the urodele larva) it forms a blindly ending tube sloping upwards and forwards between the two hemispheres. In the adult it becomes mixed with the two lateral plexuses and is liable to be confused with them. In the other groups—except the Teleosts where it is small (*Anguilla*) or absent (most Teleosts)—the paraphysis is by no means such a definite structure, but generally there is present a more or less branched and divided diverticulum of the brain wall, frequently glandular, which is homologized with the paraphysis. The morphological significance of the paraphysis is uncertain. It may represent the remains of an ancient sense organ, or it may simply represent the last connexion between the brain and the external ectoderm from which it was derived.

An important derivative of the primitive fore-brain is seen in the pair of cerebral hemispheres which in the higher vertebrates become of such relatively gigantic dimensions. The hemispheres appear to be primitively associated with the special sense of smell, and they are prolonged anteriorly into a pair of olfactory lobes which come into close relation with the olfactory organ. From a consideration of their adult relations and of their development—particularly in those groups where there is no disturbing factor in the shape of a large yolk sac—it seems probable that the hemispheres are primitively paired outpushings of the lateral wall of the primitive fore-brain<sup>4</sup> in order to give increased space for the increased mass of nervous matter associated with the olfactory sense. They are most highly developed in the Dipneusti amongst fishes. They are there (cf. fig. 29, C) of relatively enormous size with thick nervous floor (corpus striatum) and side walls and roof (pallium) surrounding a central cavity (lateral ventricle) which opens into the third ventricle. At the posterior end of the hemisphere a small area of its wall remains thin and membranous, and this becomes pushed into the lateral ventricle by an ingrowth of blood-vessel to form the huge lateral plexus (=plexus hemisphaerium). In this great size of the hemispheres<sup>5</sup> and also in the presence of a rudimentary cortex in the Dipnoi we see, as in many other features in these fishes, a distinct foreshadowing of conditions occurring in the higher groups of vertebrates. The Cyclostomes possess a distinct though small pair of hemispheres. In the Selachians the relatively archaic *Notidanidae*<sup>6</sup> possess a pair of thick-walled hemispheres, but in the majority of the members of the group the paired condition is obscured (fig. 29, A).

In the Teleostomes the mass of nervous matter which in other groups forms the hemispheres does not undergo any pushing outwards except as regards the small olfactory lobes. On the contrary, it remains as a great thickening of the lateral wall of the thalamencephalon (the so-called basal ganglia), additional space for which, however, may be obtained by a considerable increase in length of the fore-brain region (cf. fig. 30, A) or by actual involution into the third ventricle (*Polypterus*).<sup>7</sup> The great nervous thickenings of the thalamencephalic wall bulge into its cavity and are covered over by the thin epithelial roof of the thalamencephalon which is as a consequence liable to be confused with the pallium or roof of the hemispheres with which it has nothing to do: the homologue of the pallium

<sup>1</sup> J. Graham Kerr, *Quart. Journ. Micr. Sci.*, vol. xlv.

<sup>2</sup> F. K. Studnička, *S.B. böhm. Gesell.* (1901); J. Graham Kerr, *Quart. Journ. Micr. Sci.*, vol. xlvi., and *The Budget Memorial Volume*.

<sup>3</sup> F. K. Studnička, *S.B. böhm. Gesell.* (1909).

<sup>4</sup> F. K. Studnička, *S.B. böhm. Gesell.* (1896).

<sup>5</sup> J. Graham Kerr, *The Budget Memorial Volume*.

<sup>6</sup> Cf. F. K. Studnička's excellent account of the parietal organs in A. Oepel's *Lehrbuch vergl. mikr. Anatomie*, t. v. (1905).

<sup>7</sup> F. K. Studnička, *S.B. böhm. Gesell.* (1901); J. Graham Kerr, *Quart. Journ. Micr. Sci.*, vol. xlvi., and *The Budget Memorial Volume*.

as of other parts of the hemisphere is contained within the lateral thickening of the telencephalic wall, not in its membranous roof.<sup>1</sup>

Associated with the parts of the fore-brain devoted to the sense of smell (especially the corpora striata) is the important system of bridging fibres forming the anterior commissure which lies near the anterior end of the floor, or in the front wall, of the primitive fore-brain. It is of great interest to note the appearance in the *Dipnoans* (*Lepidosiren* and *Protopterus*) of a corpus callosum (cf. fig. 30 B) lying dorsal to the anterior commissure and composed of fibres connected with the pallial region of the two hemispheres.

**Sense Organs.**—The olfactory organs are of special interest in the Selachians, where each remains through life as a widely-open, sacular involution of the ectoderm which may be prolonged backwards to the margin of the buccal cavity by an open oronasal groove, thus retaining a condition familiar in the embryo of the higher vertebrates. In Dipnoans the olfactory organ communicates with the roof of the buccal cavity by definite posterior nares as in the higher forms—the communicating passage being doubtless the morphological equivalent of the oronasal groove, although there is no direct embryological evidence for this. In the Teleostomes the olfactory organ varies from a condition of great complexity in the Crossopterygians down to a condition of almost complete atrophy in certain Teleosts (*Plectognathi*).<sup>2</sup>

The eyes are usually of large size. The lens is large and spherical and in the case of most Teleostomes accommodation for distant vision is effected by the lens being pulled bodily nearer the retina. This movement is brought about by the contraction of smooth muscle fibres contained in the *processus falciformis*, a projection from the choroid which terminates in contact with the lens in a swelling, the *campanula Halleri*. In *Amia* and in Teleosts a network of capillaries forming the so-called choroid gland surrounds the optic nerve just outside the retina. As a rule the eyes of fishes have a silvery, shining appearance due to the deposition of shining flakes of guanin in the outer layer of the choroid (*Argentea*) or, in the case of Selachians, in the inner layers (*Opetum*). Fishes which inhabit dark recesses, e.g. of caves or of the deep sea, show an enlargement, or more frequently, a reduction, of the eyes. Certain deep-sea Teleosts possess remarkable telescopic eyes with a curious asymmetrical development of the retina.<sup>3</sup>

The otocyst or auditory organ agrees in its main features with that of other vertebrates. In Selachians the otocyst remains in the adult open to the exterior by the *ductus endolymphaticus*. In *Squatina*<sup>4</sup> this is unusually wide and correlated; with this the calcareous otocyst are replaced by sand-grains from the exterior. In Dipnoans (*Lepidosiren* and *Protopterus*) curious outgrowths arise from the ductus endolymphaticus and come to overlie the roof of the fourth ventricle, recalling the somewhat similar condition met with in certain Amphibians.

In various Teleosts the swim-bladder enters into intimate relations with the otocyst. In the simplest condition these relations consist in the prolongation forwards of the swim-bladder as a blindly ending tube on either side, the blind end coming into direct contact either with the wall of the otocyst itself or with the fluid surrounding it (perilymph) through a gap in the rigid periotic capsule. A wave of compression causing a slight inward movement of the swim-bladder wall will bring about a greatly magnified movement of that part of the wall which is not in relation with the external medium, viz. the part in relation with the interior of the auditory capsule. In this way the perception of delicate sound waves may be rendered much more perfect. In the Ostariophysi (*Sagemehl*), including the *Cyprinidae*, the *Siluridae*, the *Characiniidae* and the *Gymnotidae*, a physiologically similar connexion between swim-bladder and otocyst is brought about by the intervention of a chain of auditory ossicles (Weberian ossicles) formed by modification of the anterior vertebrae.<sup>5</sup>

<sup>1</sup> F. K. Studnička, *S.B. böhm. Gesell.* (1901); J. Graham Kerr, *Quart. Journ. Micro. Sci.* xvi., and *The Budget Memorial Volume*.

<sup>2</sup> R. Wiedersheim, *Kölliker's Festschrift*: cf. also *Anat. Ans.* (1887).

<sup>3</sup> A. Brauer, *Verhandl. deutsch. zool. Gesell.* (1902).

<sup>4</sup> C. Stewart, *Journ. Linn. Soc. Zool.* (1906), 439.

<sup>5</sup> T. W. Bridge and A. C. Haddon, *Phil. Trans.* 184 (1893).

**Lateral Line Organs.**<sup>6</sup>—Epidermal sense buds are scattered about in the ectoderm of fishes. A special arrangement of these in lines along the sides of the body and on the head region form the highly characteristic sense organs of the lateral line system. In *Lepidosiren* these organs retain their superficial position; in other fishes they become sunk beneath the surface into a groove, which may remain open (some Selachians), but as a rule becomes closed into a tubular channel with openings at intervals. It has been suggested that the function of this system of sense organs is connected with the perception of vibratory disturbances of comparatively large wave length in the surrounding medium.

**Peripheral Nerves.**—In the Cyclostomes the dorsal afferent and ventral efferent nerves are still, as in *Amphioxus*, independent, but in the gnathostomatous fishes they are, as in the higher vertebrates, combined together into typical spinal nerves.

As regards the cranial nerves the chief peculiarities of fishes relate to (1) the persistence of the branchial clefts and (2) the presence of an elaborate system of cutaneous sense organs supplied by a group of nerves (*lateralis*) connected with a centre in the brain which develops in continuity with that which receives the auditory nerve. These points may be exemplified by the arrangements in Selachians (see fig. 31). I., II., III., IV. and VI. call for no special remark.

**Trigeminal (V.).**—The *ophthalmicus profundus* branch (*op.p.*)—which probably is morphologically a distinct cranial nerve—

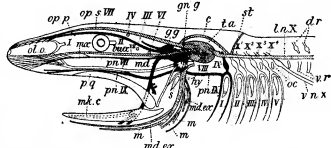

From Bridge, *Cambridge Natural History*, vol. vii. "Fishes" (by permission of Macmillan & Co. Ltd.). After Wiedersheim, *Grundriss der vergleichenden Anatomie* (by permission of Gustav Fischer).

FIG. 31.—Diagram of Cranial nerves of a Fish. Cranial nerves and branchial clefts are numbered with Roman figures. Trigeminal black; Facialis dotted; Lateralis oblique shading; Glossopharyngeal cross-hatched; Vagus white.

bucc.	Buccal.	mx.	Maxillary.
c.	Commissure between pre- and postauditory parts of lateral system.	oc.	Occipitospinal.
d.r.	Dorsal roots of spinal nerves.	o.o.	Olfactory organ.
g.g.	Gasserian ganglion.	op.p.	Ophthalmicus profundus.
gn.g.	(Geniculate) ganglion of VII.	op.s.	Ophthalmicus superficialis.
hy.	Hyomandibular.	pn.	Palatine.
l.n.x.	Lateralis vagi.	pg.	Palatopterygo-quadrate cartilage.
m.	Motor branches of hy.	st.	Spiracle.
md.	Mandibular.	s.t.	Supra-temporal branch of lateral line system.
md.ex.	External mandibular.	l.a.	Lateralis centre in brain.
mk.c.	Meckel's cartilage.	v.n.	Visceral nerve.
		v.r.	Ventral roots.

passes forwards along the roof of the orbit to the skin of the snout. As it passes through the orbit it gives off the long ciliary nerves to the eyeball, and is connected with the small ciliary ganglion (also connected with III.) which in turn gives off the short ciliary nerves to the eyeball. The *ophthalmicus superficialis* (cut short in the figure) branch passes from the root ganglion of V. (Gasserian ganglion), and passes also over the orbit to the skin of the snout. It lies close to, or completely fused with, the corresponding branch of the lateralis system.

The main trunk of V. branches over the edge of the mouth into the *maxillary* (*mx.*) and *mandibular* (*md.*) divisions, the former, like the two branches already mentioned, purely sensory, the latter mixed—supplying the muscles of mastication as well as the teeth of the lower jaw and the lining of the buccal floor.

The main trunk of the *Facialis* (VII.) bifurcates over the

<sup>6</sup> For literature of lateral line organs see Cole, *Trans. Linn. Soc.* vii. (1898).

spiracle into a prespiracular portion—the main portion of which passes to the mucous membrane of the palate as the palatine (*pn.VII.*)—and a postspiracular portion, the hyomandibular (*hy.*) trunk which supplies the muscles of the hyoid arch and also sends a few sensory fibres to the lining of the spiracle, the floor of mouth and pharynx and the skin of the lower jaw. Combined with the main trunk of the facial are branches belonging to the *lateralis* system.

*Lateralis Group of Nerves.*—The *lateralis* group of nerves are charged with the innervation of the system of cutaneous sense organs and are all connected with the same central region in the medulla. A special sensory area of the ectoderm becomes involution below the surface to form the otocyst, and the nerve fibres belonging to this form the auditory nerve (*VIII.*). Other portions of the *lateralis* group become mixed up with various other cranial nerves as follows:

(a) Facial portion.

(1) *Ophthalmicus superficialis* (*op.s.VII.*): passes to lining of nose or to the lateral line organs of the dorsal part of snout.

(2) *Buccal* (*bucc.VII.*): lies close to maxillary division of *V.* and passes to the sensory canals of the lower side of the snout.

(3) *External mandibular* (*md.ex.*): lies in close association with the mandibular division of *V.*, supplies the sensory canals of the lower jaw and hyoid region.

*Lateralis vagi* (*l.n.X.*) becomes closely associated with the vagus. It supplies the lateral line organs of the trunk.

In the lamprey and in Dipnoans the *lateralis vagi* loses its superficial position in the adult and comes into close relation with the notochord.

In Actinopterygians and at least some Selachians a *lateralis* set of fibres is associated with *IX.*, and in the former fishes a conspicuous trunk of *lateralis* fibres passes to some or all (*Gadus*) of the fins. This has been called the *lateralis accessorius* and is apparently connected with *V.*, *VII.*, *IX.*, *X.* and certain spinal nerves.<sup>1</sup>

*Vagus Group* (*IX.*, *X.*, *XI.*).—The *glossopharyngeus* (*IX.*) forks over the first branchial cleft (pretrematic and post-trematic branches) and also gives off a palatine branch (*pn.IX.*). In some cases (various Selachians, Ganoids and Teleosts) it would seem that *IX.* includes a few fibres of the *lateralis* group.

*Vagus* (*X.*) is shown by its multiple roots arising from the medulla and also by the character of its peripheral distribution to be a compound structure formed by the fusion of a number of originally distinct nerves. It consists of (1) a number of branchial branches (*X.<sup>1</sup>*, *X.<sup>2</sup>* &c.), one of which forks over each gill cleft behind the hyobranchial and which may (Selachians) arise by separate roots from the medulla; (2) an intestinal branch (*v.n.X.*) arising behind the last branchial and innervating the wall of the oesophagus and stomach and it may be even the intestine throughout the greater part of its length (*Myxine*).

The *accessorius* (*XI.*) is not in fishes separated as a distinct nerve from the vagus.

With increased development of the brain its hinder portion, giving rise to the vagus system, has apparently come to encroach on the anterior portion of the spinal cord, with the result that a number of spinal nerves have become reduced to a less or more vestigial condition. The dorsal roots of these nerves disappear entirely in the adult, but the ventral roots persist and are to be seen arising ventrally to the vagus roots. They supply certain muscles of the pectoral fins and of the visceral arches and are known as spino-occipital nerves.<sup>2</sup>

These nerves are divisible into an anterior more ancient set—the occipital nerves—and a posterior set of more recent origin—(occipito-spinal nerves). In Selachians 1-5 pairs of occipital nerves alone are recognizable; in Dipnoans 2-3 pairs of occipital and 2-3 pairs of occipito-spinal; in Ganoids 1-2 pairs occipital and 1-5 pairs occipito-spinal; in Teleosts finally the occipital nerves have entirely disappeared while there are 2 pairs of occipito-spinal. In Cyclostomes no special spino-occipital nerves have been described.

The fibres corresponding with those of the *Hypoglossus* (*XII.*) of higher vertebrates spring from the anterior spinal nerves.

<sup>1</sup> For literature of lateral line organs see Cole, *Trans. Linn. Soc.*, vii. (1898).

<sup>2</sup> M. Fürbringer in Gegenbaur's *Festschrift* (1896).

which are here, as indeed in Amphibia, still free from the cranium.

*Sympathetic.*—The sympathetic portion of the nervous system does not in fishes attain the same degree of differentiation as in the higher groups. In Cyclostomes it is apparently represented by a fine plexus with small ganglia found in the neighbourhood of the dorsal aorta and on the surface of the heart and receiving branches from the spinal nerves. In Selachians also a plexus occurs in the neighbourhood of the cardinal veins and extends over the viscera: it receives visceral branches from the anterior spinal nerves. In Teleosts the plexus has become condensed to form a definite sympathetic trunk on each side, extending forwards into the head and communicating with the ganglia of certain of the cranial nerves. (J. G. K.)

#### V. DISTRIBUTION IN TIME AND SPACE

The origin of Vertebrates, and how far back in time they extend, is unknown. The earliest fishes were in all probability devoid of hard parts and traces of their existence can scarcely be expected to be found. The hypothesis that they may be derived from the early Crustaceans, or Arachnids, is chiefly based on the somewhat striking resemblance which the mailed fishes of the Silurian period (Ostracodermi) bear to the Arthropods of that remote time, a resemblance, however, very superficial and regarded by most morphologists as an interesting example of mimetic resemblance—whatever this term may be taken to mean. The minute denticles known as conodonts, which first appear in the Ordovician, were once looked upon as teeth of Cyclostomes, but their histological structure does not afford any support to the identification and they are now generally dismissed altogether from the Vertebrates. As a compensation the Lower Silurian of Russia has yielded small teeth or spines which seem to have really belonged to fishes, although their exact affinities are not known (*Palaeodus* and *Archodus* of J. V. Rohon).

It is not until we reach the Upper Silurian that satisfactory remains of unquestionable fishes are found, and here they suddenly appear in a considerable variety of forms, very unlike modern fishes in every respect, but so highly developed as to convince us that we have to search in much earlier formations for their ancestors. These Upper Silurian fishes are the *Coleolepidae*, the *Ateleaspidae*, the *Birkeniidae*, the *Pteraspidae*, the *Tremataspidae* and the *Cephalaspidae*, all referred to the Ostracopora. The three last types persist in the Devonian, in the middle of which period the Osteolepid Crossopterygii, the Dipneusti and the Arthrodira suddenly appear. The most primitive Selachian (*Cladoseleache*), the Acanthodian Selachians (*Diplacanthidae*), the Chimaerids (*Psycodius*), and the Palaeoniscid ganoids (*Chirolepis*) appear in the Upper Devonian, along with the problematic *Palaeospondylus*.

In the Carboniferous period, the Ostracopora and Arthrodira have disappeared, the Crossopterygii and Dipneusti are still abundant, and the Selachians (*Pleuracanthidae*, Acanthodians, truesharks) and Chondrostean ganoids (*Palaeoniscidae* and *Platysomidae*) are predominant. In the Upper Permian the Holostean ganoids (*Acanthoporus*) make their appearance, and the group becomes dominant in the Jurassic and the Lower Cretaceous. In the Trias, the Crossopterygii and Dipneusti dwindle in variety and the *Ceratodontidae* appear; the Chondrostean and Holostean ganoids are about equally represented, and are supplemented in the Jurassic by the first, annectant representatives of the Teleostei (*Pholidophoridae*, *Leptolepidae*). In the latter period, the Holostean ganoids are predominant, and with them we find numerous Cretacian sharks, some primitive skates (*Squatinae* and *Rhinobatidae*), Chimaerids and numerous Coelacanthid crossopterygians.

The fish-fauna of the Lower Cretaceous is similar to that of the Jurassic, whilst that of the Chalk and other Upper Cretaceous formations is quite modern in aspect, with only a slight admixture of Coelacanthid crossopterygians and Holostean ganoids, the Teleostean being abundantly represented by *Elopidae*, *Albulidae*, *Halosauridae*, *Scopelidae* and *Berycidae*,

many being close allies of the present inhabitants of the deep sea. At this period the spiny-rayed Teleosteans, dominant in the seas of the present day, made their first appearance.

With the Eocene, the fish-fauna has assumed the essential character which it now bears. A few Pycnodonts survive as the last representatives of typically Mesozoic ganoids, whilst in the marine deposits of Monte Bolca (Upper Eocene) the principal families of living marine fishes are represented by genera identical with or more or less closely allied to those still existing; it is highly remarkable that forms so highly specialized as the sucking-fish or remoras, the flat-fish (*Pleuronectidae*), the Pediculati, the Plectognaths, &c., were in existence, whilst in the freshwater deposits of North America *Osteoglossidae* and *Cichlidae* were already represented. Very little is known of the freshwater fishes of the early Tertiaries. What has been preserved of them from the Oligocene and Miocene shows that they differed very slightly from their modern representatives. We may conclude that from early Tertiary times fishes were practically as they are at present. The great hiatus in our knowledge lies in the period between the Cretaceous and the Eocene.

At the present day the Teleosteans are in immense preponderance, Selachians are still well represented, the Chondrosteian ganoids are confined to the rivers and lakes of the temperate zone of the northern hemisphere (*Acipenseridae*, *Polyodontidae*), the Holosteian ganoids are reduced to a few species (*Lepidosteus*, *Amia*) dwelling in the fresh waters of North America, Mexico and Cuba, the Crossopterygians are represented by the isolated group *Polypteridae*, widely different from any of the known fossil forms, but with ten species inhabiting the rivers and lakes of Africa, whilst the Dipneusti linger in Australia (*Neoceratodus*), in South America (*Lepidostreus*), and in tropical Africa (*Protopterus*). The imperfections of the geological record preclude any attempt to deal with the distribution in space as regards extinct forms, but several types, at present very restricted in their habitat, once had a very wide distribution. The *Ceratodontidae*, for instance, of which only one species is now living, confined to the rivers of Queensland, has left remains in Triassic, Rhaetic, Jurassic and Cretaceous rocks of Europe, North America, Patagonia, North and South Africa, India and Australia; the *Amiidae* and *Lepidosteidae* were abundant in Europe in Eocene and Miocene times; the *Osteoglossidae*, now living in Africa, S.E. Asia and South America, occurred in North America and Europe in the Eocene.

In treating of the geographical distribution of modern fishes, it is necessary to distinguish between fresh-water and marine forms. It is, however, not easy to draw a line between these categories, as a large number of forms are able to accommodate themselves to either fresh or salt water, whilst some periodically migrate from the one into the other. On the whole, fishes may be roughly divided into the following categories:—

- I. Marine fishes. A. shore-fishes; B. pelagic fishes; C. deep-sea fishes.
- II. Brackish-water fishes.
- III. Fresh-water fishes.
- IV. Migratory fishes. A. anadromous (ascending fresh waters to spawn); B. catadromous (descending to the sea to spawn).

About two-thirds of the known recent fishes are marine. Such are nearly all the Selachians, and, among the Teleosteans, all the *Heteromi*, *Pediculati* and the great majority of *Apoles*, *Thoracosti*, *Percesoces*, *Anacanthini*, *Acanthoptygii* and *Plectognathi*. All the *Crossopterygii*, *Dipneusti*, *Opisthomi*, *Symbranchii*, and nearly all the *Ganoidei* and *Ostariophysii* are confined to fresh-water.

The three categories of marine fishes have thus been defined by Günther:—

"1. *Shore Fishes*—that is, fishes which chiefly inhabit parts of the sea in the immediate neighbourhood of land either actually raised above, or at least but little submerged below, the surface of the water. They do not descend to any great depth,—very few to 300 fathoms, and the majority live close to the surface. The distribution of these fishes is determined, not only by the temperature of the surface water, but also by the nature of the adjacent land and its animal

and vegetable products,—some being confined to flat coasts with soft or sandy bottoms, others to rocky and fissured coasts, others to living coral formations. If it were not for the frequent mechanical and involuntary removals to which these fishes are exposed, their distribution within certain limits, as it no doubt originally existed, would resemble still more that of freshwater fishes than we find it actually does at the present period.

2. *Pelagic Fishes*—that is, fishes which inhabit the surface and uppermost strata of the open ocean, and approach the shores only accidentally or occasionally (in search of prey), or periodically (for the purpose of spawning). The majority spawn in the open sea, their ova and young being always found at a great distance from the shore. With regard to their distribution, they are still subject to the influences of light and the temperature of the surface water; but they are independent of the variable local conditions which tie the shore fish to its original home, and therefore roam freely over a space which would take a freshwater or shore fish thousands of years to cover in its gradual dispersal. Such are devoid of rapidity of motion are dispersed over similarly large areas by the oceanic currents, more slowly than the strong swimmers, but not less surely. An accurate definition, therefore, of their distribution within certain areas equivalent to the terrestrial regions is much less feasible than in the case of shore fishes.

3. *Deep-Sea Fishes*—that is, fishes which inhabit such depths of the ocean that they are but little or not at all influenced by light or the surface temperature, and which, by their organization, are prevented from reaching the surface stratum in a healthy condition. Living almost under identical tellurian conditions, the same type, the same species, may inhabit an abyssal depth under the equator as well as one near the arctic or antarctic circle; and all that we know of these fishes points to the conclusion that no separate horizontal regions can be distinguished in the abyssal fauna, and that no division into bathymetrical strata can be attempted on the base of generic much less of family characters."

A division of the world into regions according to the distribution of the shore-fishes is a much more difficult task than that of tracing continental areas. It is possible perhaps to distinguish four great divisions: the Arctic region, the Atlantic region, the Indo-Pacific region and the Antarctic region. The second and third may be again subdivided into three zones: Northern, Tropical and Southern. This appears to be a more satisfactory arrangement than that which has been proposed into three zones primarily, each again subdivided according to the different oceans. Perhaps a better division is that adopted by D. S. Jordan, who arranges the littoral fishes according to coast lines; we then have an East Atlantic area, a West Atlantic, an East Pacific and a West Pacific, the latter including the coasts of the Indian Ocean. The tropical zone, whatever be the ocean, is that in which fishes flourish in greatest abundance and where, especially about coral-reefs, they show the greatest variety of bizarre forms and the most gorgeous coloration. The fish-fauna of the Indo-Pacific is much richer than that of the Atlantic, both as regards genera and species.

As regards the Arctic and Antarctic regions, the continuity or circumpolar distribution of the shore fishes is well established. The former is chiefly characterized by its Cottids, Cyclopterids, Zoarcids and Gadids, the latter by its Nototheniids. The theory of bipolarity receives no support from the study of the fishes.

Pelagic fishes, among which we find the largest Selachians and Teleosteans, are far less limited in their distribution, which, for many species, is nearly world-wide. Some are dependent upon currents, but the great majority being rapid swimmers able to continue their course for weeks, and frequently without the necessity of rest (many sharks, scombrids, sword-fishes), pass from one ocean into the other. Most numerous between the tropics, many of these fishes occasionally wander far north and south of their habitual range, and there are few genera that are at all limited in their distribution.

Deep-sea fishes, of which between seven hundred and eight hundred species are known, belong to the most diverse groups and quite a number of families are exclusively bathyphilic (*Chlamydoselachidae*, *Stomatidae*, *Alepocephalidae*, *Nemichthyidae*, *Synphobranchidae*, *Sacopharyngidae*, *Cetomimidae*, *Halosauridae*, *Lipogenidae*, *Notacanthidae*, *Chiasmodontidae*, *Icosteidae*, *Muraenolepididae*, *Macruridae*, *Anomalopidae*, *Podalidae*, *Trachypteridae*, *Lophotidae*, *Ceratidae*, *Gigantactinidae*). But they are all comparatively slight modifications of the forms living on the surface of the sea or in the shallow parts, from



which they may be regarded as derived. In no instance do these types show a structure which may be termed archaic when compared with their surface allies. That these fishes are localized in their vertical distribution, between the 100-fathoms line, often taken as the arbitrary limit of the bathyal fauna, and the depth of 2750 fathoms, the lowest point whence fishes have been procured, there is little doubt. But our knowledge is still too fragmentary to allow of any general conclusions, and the same applies to the horizontal distribution. Yet the same species may occur at most distant points; as these fishes dwell beyond the influence of the sun's rays, they are not affected by temperature, and living in the Arctic zone or under the equator makes little difference to them. A great deal of evidence has been accumulated to show the gradual transition of the surface into the bathyal forms; a large number of surface fishes have been met with in deep water (from 100 to 500 fathoms), and these animals afford no support to Alexander Agassiz's supposition of the existence of an azoic zone between the 200-fathoms line and the bottom.

Brackish-water fishes occur also in salt and fresh water, in some localities at least, and belong to various groups of Teleostei. Sticklebacks, gobies, grey mullets, blennies are among the best-known examples. The facility with which they accommodate themselves to changes in the medium in which they live has enabled them to spread readily over very large areas. The three-spined stickleback, for instance, occurs over nearly the whole of the cold and temperate parts of the northern hemisphere, whilst a grey mullet (*Mugil capito*) ranges without any appreciable difference in form from Scandinavia and the United States along all the Atlantic coasts to the Cape of Good Hope and Brazil. It would be hardly possible to base zoo-geographical divisions on the distribution of such forms.

The fresh-water fishes, however, invite to such attempts. How greatly their distribution differs from that of terrestrial animals has long ago been emphasized. The key to their mode of dispersal is, with few exceptions, to be found in the hydrography of the continents, latitude and climate, excepting of course very great altitudes, being inconsiderable factors, the fish-fauna of a country deriving its character from the headwaters of the river-system which flows through it. The lower Nile, for instance, is inhabited by fishes bearing a close resemblance to, or even specifically identical with, those of tropical Africa, thus strikingly contrasting with the land-fauna of its banks. The knowledge of the river-systems is, however, not sufficient for tracing areas of distribution, for we must bear in mind the movements which have taken place on the surface of the earth, owing to which present conditions may not have existed within comparatively recent times, geologically speaking; and this is where the systematic study of the aquatic animals affords scope for conclusions having a direct bearing on the physical geography of the near past. It is not possible here to enter into the discussion of the many problems which the distribution of fresh-water fishes involves; we limit ourselves to an indication of the principal regions into which the world may be divided from this point of view. The main divisions proposed by Günther in the 6th edition of the *Encyclopædia Britannica* still appear the most satisfactory. They are as follows:—

1. THE NORTHERN ZONE OR Holarctic Region.—Characterized by Acipenseridae, Few Siluridae. Numerous Cyprinidae, Salmonidae, Esocidae, Percidae.

2. EUROPEAN, ASIAN OR Palaearctic Region. Characterized by absence of osseous Ganoidi; Cobitinae and Barbus numerous.

3. THE TROPICAL ZONE OR Neartic Region. Characterized by osseous Ganoidi and abundance of Catostominae; but no Cobitinae or Barbus.

4. THE EQUATORIAL ZONE.—Characterized by the development of Siluridae.

A. Cyprinoid Division. Characterized by presence of Cyprinidae, Mastacembellidae, Anabantidae, Ophiocephalidae.

1. Indian Region. Characterized by absence of Dipneusti, Polypteridae, Mormyridae and Characinae. Cobitinae numerous.

2. African Region.—Characterized by presence of Dipneusti, Polypterid and Mormyrid; Cichlid and Characini numerous.

B. Acyprinoid Division. Characterized by absence of Cyprinidae and the other families mentioned above.

1. Tropical American or Neotropical Region. Characterized by presence of Dipneusti; Cichlidae and Characinae numerous; Gymnotidae and Loricariidae.

2. Tropical Pacific Region. Includes the Australian as well as the Polynesian Region. Characterized by presence of Dipneusti, Cichlidae and Characinae absent.

III. THE SOUTHERN ZONE.—Characterized by absence of Cyprinidae and scarcity of Siluridae, Haplochromidae and Galaxiidae represent the Salmonids and Esocids of the northern zone. One region only.

1. Antarctic Region. Characterized by the small number of species; the fishes of

- The Tasmanian subregion;
- The New Zealand subregion; and
- The Patagonian or Fuegian subregion being almost identical.

Although, as expressed in the above synopsis, the resemblance between the Indian and African regions is far greater than exists between them and the other regions of the equatorial zone, attention must be drawn to the marked affinity which some of the fishes of tropical Africa show to those of South America (*Lepidosirenidae*, *Characinae*, *Cichlidae*, *Nandidae*), an affinity which favours the supposition of a connexion between these two parts of the world in early Tertiary times.

The boundaries of Günther's regions may thus be traced, beginning with the equatorial zone, this being the richest.

EQUATORIAL ZONE.—Roughly speaking, the borders of this zoological zone coincide with the geographical limits of the tropics of Cancer and Capricorn; its characteristic forms, however, extend in undulating lines several degrees both northwards and southwards. Commencing from the west coast of Africa, the desert of the Sahara forms a boundary between the equatorial and northern zones; as the boundary approaches the Nile, it makes a sudden sweep towards the north as far as northern Syria, crosses through Persia and Afghanistan to the southern ranges of the Himalayas, and follows the course of the Yang-tse-Kiang, which receives its contingent of equatorial fishes through its southern tributaries. Its continuation through the North Pacific may be indicated by the tropic, which strikes the coast of Mexico at the southern end of the Gulf of California. Equatorial types of South America are known to extend so far northwards; and, by following the same line, the West India Islands are naturally included in this zone.

Towards the south the equatorial zone embraces the whole of Africa and Madagascar, and seems to extend still farther south in Australia, its boundary probably following the southern coast of that continent; the detailed distribution of the fresh-water fishes of south-western Australia has been little studied, but the tropical fishes of that region follow the principal water-course, the Murray river, far towards the south and probably to its mouth. The boundary-line then stretches to the north of Tasmania and New Zealand, coinciding with the tropic until it strikes the western slope of the Andes, on the South American continent, where it again bends southward to embrace the system of the Rio de la Plata.

The four regions into which the equatorial zone is divided arrange themselves into two well-marked divisions, one of which is characterized by the presence of Cyprinid fishes, combined with the development of *Labyrinthic* Percosocæ (*Anabantidae* and *Ophiocephalidae*) and Mastacembellids, whilst in the other these types are absent. The boundary between the Cyprinoid and Acyprinoid division seems to follow the now exploded Wallace's line—a line drawn from the south of the Philippines between Borneo and Celebes, and farther south between Bali and Lombok. Borneo abounds in Cyprinids; from the Philippine Islands a few only are known, and in Bali two species have been found; but none are known from Celebes or Lombok, or from islands situated farther east.

The Indian region comprises Asia south of the Himalayas and the Yang-tse-Kiang, and includes the islands to the west of Celebes and Lombok. Towards the north-east the island of Formosa, which also by other parts of its fauna shows the

characters of the equatorial zone, has received some characteristic Japanese freshwater fishes. Within the geographical boundaries of China the freshwater fishes of the tropics pass gradually into those of the northern zone, both being separated by a broad, debatable ground. The affluents of the great river traversing this district are more numerous from the south than from the north, and carry the southern fishes far into the temperate zone. Scarcely better defined is the boundary of this region towards the north-west, in which fishes were very poorly represented by types common to India and Africa.

The African region comprises the whole of Africa south of the Sahara. It might have been conjectured that the more temperate climate of its southern extremity would have been accompanied by a conspicuous difference in the fish fauna. But this is not the case; the difference between the tropical and southern parts of Africa consists simply in the gradual disappearance of specifically tropical forms, whilst Silurids, Cyprinids and even *Anabas* penetrate to its southern coast; no new form, except a *Galaxias* at the Cape of Good Hope, has entered to impart to South Africa a character distinct from the central portion of the continent. In the north-east the African fauna passes the isthmus of Suez and penetrates into Syria; the system of the Jordan presents so many African types that it has to be included in a description of the African region as well as of the Europaeo-Asiatic.

The boundaries of the Neotropical or Tropical American region have been sufficiently indicated in the definition of the equatorial zone. A broad and most irregular band of country, in which the South and North American forms are mixed, exists in the north.

The Tropical Pacific region includes all the islands east of Wallace's line, New Guinea, Australia (with the exception of its south-eastern portion), and all the islands of the tropical Pacific to the Sandwich group.

**NORTHERN ZONE.**—The boundaries of the northern zone coincide in the main with the northern limit of the equatorial zone; but they overlap the latter at different points. This happens in Syria, as well as east of it, where the mixed faunae of the Jordan and the rivers of Mesopotamia demand the inclusion of this territory in the northern zone as well as in the equatorial; in the island of Formosa, where a Salmonid and several Japanese Cyprinids flourish; and in Central America, where a *Lepidosteus*, a Cyprinid (*Sclerogathus meridionalis*), and an *Amiurus* (*A. meridionalis*) represent the North American fauna in the midst of a host of tropical forms.

There is no separate arctic zone for freshwater fishes; ichthyic life becomes extinct towards the pole wherever the fresh water remains frozen throughout the year, or thaws for a few weeks only; and the few fishes which extend into high latitudes belong to types in no wise differing from those of the more temperate south. The highest latitude at which fishes have been obtained is 82° N. lat., whence specimens of char (*Salmo arcticus* and *Salmo naresii*) have been brought back.

**The Palaearctic or Europaeo-Asiatic Region.**—The western and southern boundaries of this region coincide with those of the northern zone. Bering Strait and the Kamchatka Sea have been conventionally taken as the boundary in the north, but the fishes of both coasts, so far as they are known, are not sufficiently distinct to be referred to two different regions. The Japanese islands exhibit a decided Palaearctic fish fauna with a slight influx of tropical forms in the south. In the east, as well as in the west, the distinction between the Europaeo-Asiatic and the North American regions disappears almost entirely as we advance farther towards the north. Finally, the Europaeo-Asiatic fauna mingles with African and Indian forms in Syria, Persia and Afghanistan.

The boundaries of the North American or Nearctic region have been sufficiently indicated. The main features and the distribution of this fauna are identical with those of the preceding region.

**SOUTHERN ZONE.**—The boundaries of this zone have been indicated in the description of the equatorial zone; they over-

lap the southern boundaries of the latter in South Australia and South America, but we have not the means of defining the limits to which southern types extend northwards. This zone includes Tasmania, with at least a portion of south-eastern Australia (Tasmanian sub-region), New Zealand and the Auckland Islands (New Zealand sub-region), and Chile, Patagonia, Tierra del Fuego and the Falkland Islands (Fuegian sub-region). No freshwater fishes are known from Kerguelen's Land, or from islands beyond 55° S. lat.

The Tropical American region is the richest (about 1300 species); next follow the African region (about 1000), the Indian region (about 800), the Europaeo-Asiatic region (about 500), the North American region (about 400), the Tropical Pacific region (about 60); whilst the Antarctic region is quite insignificant.

Of the migratory fishes, or fishes travelling regularly from the sea to fresh waters, most, if not all, were derived from marine forms. The anadromous forms, annually or periodically ascending rivers for the purpose of spawning, such as several species of *Acipenser*, *Salmo*, *Coregonus*, *Clupea* (shads), and *Petromyzon*, are only known from the northern hemisphere, whilst the catadromous forms, spending most of their life in fresh water but resorting to the sea to breed, such as *Anguilla*, some species of *Mugil*, *Galaxias* and *Pleuronectes*, have representatives in both hemispheres. (G. A. B.)

**ICHTHYOPHAGI** (Gr. for "fish-eaters"), the name given by ancient geographers to several coast-dwelling peoples in different parts of the world and ethnically unrelated. Nearachus mentions such a race as inhabiting the barren shores of the Mekran on the Arabian Sea; Pausanias locates them on the western coast of the Red Sea. Ptolemy speaks of fish-eaters in Ethiopia, and on the west coast of Africa; while Pliny relates the existence of such tribes on the islands in the Persian Gulf. Herodotus (book i. c. 200) mentions three tribes of the Babylonians who were solely fish-eaters, and in book iii. c. 19 refers to Ichthyophagi in Egypt. The existence of such tribes was confirmed by Sir Richard F. Burton (*El-Medinah*, p. 144).

**ICHTHYOSAURUS**, a fish or porpoise-shaped marine reptile which characterized the Mesozoic period and became extinct immediately after the deposition of the Chalk. It was named *Ichthyosaurus* (Gr. fish-lizard) by C. König in 1818 in allusion to its outward form, and is best known by nearly complete skeletons from the Lias of England and Germany. The large head is produced into a slender, pointed snout; and the jaws are provided with a row of conical teeth nearly uniform in size and deeply implanted in a continuous groove. The eye is enormous, and is surrounded by a ring of overlapping "sclerotic

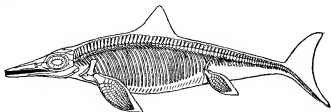

From British Museum Guide to Fossil Reptiles and Fishes, by permission of the Trustees.

Skeleton of *Ichthyosaurus communis*, with outline of body and fins, from the Lower Lias of Lyme Regis, Dorset; original nearly four metres in length.

plates," which would serve to protect the eye-ball during diving. The vertebrae are very numerous, short and deeply biconcave, imparting great flexibility to the backbone as in fishes. The neck is so short and thick that it is practically absent. There are always two pairs of paddle-like limbs, the hinder pair never disappearing as in porpoises and other Cetacea, though often much reduced in size. A few specimens from the Upper Lias of Württemberg (in the museums of Stuttgart, Tübingen, Budapest and Chicago) exhibit remains of the skin, which is quite smooth and forms two triangular median fins, one in the middle of the back, the other at the end of the tail. The dorsal fin consists merely of skin without any internal skeleton, while

the tail-fin is expanded in a vertical plane and has the lower lobe stiffened by the tapering end of the backbone, which is sharply bent downwards. Immature individuals are sometimes observable within the full-grown skeletons, suggesting that this reptile was viviparous.

The largest known species of *Ichthyosaurus* is *I. trigrionodon* from the Upper Lias of Banz, Bavaria, with the head measuring about two metres in length and probably representing an animal not less than ten metres in total length. *I. platyodon*, from the English Lower Lias, seems to have been almost equally large. *I. intermedius* and *I. communis*, which are the commonest species in the English Lower Lias, rarely exceed a length of three or four metres. The species in rocks later than the Lias are known for the most part only by fragments, but the remains of Lower Cretaceous age are noteworthy for their very wide geographical distribution, having been found in Europe, the East Indies, Australia, New Zealand and South America. Allied Ichthyosaurians named *Ophthalmosaurus* and *Baptanodon*, from the Upper Jurassic of England and North America, are nearly or quite toothless and have very flexible broad paddles. The earliest known Ichthyosaurians (*Mizosaurus*), which occur in the Trias, are of diminutive size, with paddles which suggest that these marine reptiles were originally descended from land or marsh animals (see REPTILES).

**AUTHORITIES.**—R. Owen, *A Monograph of the Fossil Reptilia of the Liassic Formations*, part iii. (Mon. Palaeont. Soc., 1881); E. Fraas, *Die Ichthyosaurier der süddeutschen Trias- und Jura-Ab Lagerungen* (Tübingen, 1891). Also good figures in T. Hawkins, *The Book of the Great Sea-dragons* (London, 1840). (A. S. Wo.)

**ICHTHYOSIS**, or XERODERMA, a general thickening of the whole skin and marked accumulation of the epidermic elements, with atrophy of the sebaceous glands, giving rise to a hard, dry, scaly condition, whence the names, from *ixôis*, fish, and *ênôis*, dry, *derma*, skin. This disease generally first appears in infancy, and is probably congenital. It differs in intensity and in distribution, and is generally little amenable to any but palliative remedies, such as the regular application of oily substances. Ichthyosis lingualis ("smokers' tongue"), a variety common in heavy smokers, occurs in opaque white patches on the tongue, gums and roof of the mouth. Cancer occasionally starts from the patches. The affection is obstinate, but may disappear spontaneously.

**ICKNIELD STREET.** (1) The Saxon name (earlier *Icenhyllt*) of a prehistoric (not Roman) "Ridgeway" along the Berkshire downs and the Chilterns, which crossed the Thames near Strealey and ended somewhere near Ting or Dunstable. In some places there are traces of a double road, one line on the hills and one in the valley below, as if for summer and winter use. No modern highroad follows it for any distance. Antiquaries have supposed that it once ran on to Royston, Newmarket and Norfolk, and have connected its name with the Icen, the Celtic tribe inhabiting East Anglia before the Roman conquest. But the name does not occur in early documents so far east, and it has certainly nothing to do with that of the Icen (Haverfield, *Victoria History of Norfolk*, i. 286). See further **ERMINE STREET.** (2) A Roman road which ran through Derby, Lichfield, Birmingham and Alcester is sometimes called Icknield Street and sometimes Rycknield Street. The origin of this nomenclature is very obscure (*Vict. Hist. of Warwick*, i. 239).

(F. J. H.)

**ICON** (through the Latinized form, from Gr. *εἰκών*, portrait, image), generally any image or portrait-figure, but specially the term applied to the representations in the Eastern Church of sacred personages, whether in painting or sculpture, and particularly to the small metal plaques in archaic Byzantine style, venerated by the adherents of the Greek Church. See **ICONOCLASTS**; **IMAGE-WORSHIP**; **BYZANTINE ART.** The term "iconography" once confined to the study of engravings (*q.v.*), is now applied to the history of portrait images in Christian art, though it is also used with a qualifying adjective of Greek, Roman and other art.

**ICONIUM** (mod. *Konia*), a city of Asia Minor, the last of the Phrygian land towards Lycaonia, was commonly reckoned to

Lycaonia in the Roman time, but retained its old Phrygian connexion and population to a comparatively late date. Its natural surroundings must have made it an important town from the beginning of organized society in this region. It lies in an excellently fertile plain, 6 m. from the Pisidian mountains on the west, with mountains more distant on the north and south, while to the east the dead level plain stretches away for hundreds of miles, though the distant view is interrupted by island-like mountains. Streams from the Pisidian mountains make the land on the south-west and south of the city a garden; but on the east and north-east a great part of the naturally fertile soil is uncultivated. Trees grow nowhere except in the gardens near the city. Irrigation is necessary for productiveness, and the water-supply is now deficient. A much greater supply was available for agriculture in ancient times and might be reintroduced.

Originally a Phrygian city, as almost every authority who has come into contact with the population calls it, and as is implied in Acts xiv. 6, it was in a political sense the chief city of the Lycaonian tetrarchy added to the Galatian country about 165 B.C., and it was part of the Roman province Galatia from 25 B.C. to about A.D. 295. Then it was included in the province Pisidia (as Ammianus Marcellinus describes it) till 372, after which it formed part of the new province Lycaonia so long as the provincial division lasted. Later it was a principal city of the theme of Anatolia. It suffered much from the Arab raids in the three centuries following A.D. 660; its capture in 708 is mentioned, but it never was held as a city of the caliphs. In later Roman and Byzantine times it must have been a large and wealthy city. It was a metropolis and an archbishopric, and one of the earliest councils of the church was held there in A.D. 235. The ecclesiastical organization of Lycaonia and the country round Iconium on all sides was complete in the early 4th century, and monuments of later 3rd and 4th century Christianity are extremely numerous. The history of Christian Iconium is utterly obscure. The city was thrice visited by St Paul, probably in A.D. 47, 50 and 53; and it is the principal scene of the tale of Paul and Thecla (which though apocryphal has certainly some historical basis; see **THECLA**). There was a distinct Roman element in Iconium, arising doubtless from the presence of Roman traders. This was recognized by Claudius, who granted the honorary title *Claudiconium*, and by Hadrian, who elevated the city to the rank of a Roman colony about A.D. 130 under the name *Colonia Aelia Hadriana Augusta Iconiensium*. The period of its greatest splendour was after the conquest by the Seljuk Turks about 1072-1074. It soon became the capital of the Seljuk state, and one of the most brilliant cities of the world. The palace of the sultans and the mosque of Ala ed-din Kaikobad formerly covered great part of the Acropolis hill in the northern part of the city. Farther south there is still the great complex of buildings which form the chief seat of the Mevlevi dervishes, a sect widely spread over Anatolia. Many other splendid mosques and royal tombs adorned the city, and justified the Turkish proverb, "See all the world; but see Konia." The walls, about 2 m. in circumference, consisted of a core of rubble and concrete, coated with ancient stones, inscriptions, sculptures and architectural marbles, forming a striking sight, which no traveller ever examined in detail. Beyond the walls extended the gardens and villas of a prosperous Oriental population, especially on the south-west towards the suburb of Meram.

When the Seljuk state broke up, and the Osmanli or Ottoman sovereignty arose, Konia decayed, its population dwindled and the splendid early Turkish buildings were suffered to go to ruin. As trade and intercourse diminished Konia grew poorer and more ruinous. The walls and the palace, still perfect in the beginning of the 19th century, were gradually pulled down for building material, and in 1882 there remained only a small part of the walls, from which all the outer stones had been removed, while the palace was a ruin. At that time and for some years later a large part of Konia was like a city of the dead. But about 1895 the advent of the Anatolian railway began to restore its prosperity. A good supply of drinking water was

brought to the city by Ferid Pasha, who governed the vilayet ably for several years, till in 1903 he was appointed Grand Vizier. The sacred buildings, mosques, &c., were patched up (except a few which were quite ruinous) and the walls wholly removed, but an unsightly fragment of a palace-tower still remained in 1906. In 1904-1905 the first two sections of the Bagdad railway, 117 m., to Karaman and Ereğli, were built. In the city there is a branch of the Ottoman bank, a government technical school, a French Catholic mission and a school, an Armenian Protestant school for boys, an American mission school for girls, mainly Armenian, and other educational establishments.

The founder of the Mevlevi dancing dervishes, the poet Mahommed Jelal-ed-Din (Rumi), in 1307, though tempted to assume the inheritance along with the empire of the Seljuk sultan Ala ed-din Kaikobad III., who died without heirs, preferred to pass on the power to Osman, son of Ertoghrul, and with his own hands invested Osman and girt him with the sword: this investiture was the legitimate beginning of the Osmanli authority. The heirs of Jelal-ed-Din (Rumi) were favoured by the Osmanli sultans until 1516, when Selim was on the point of destroying the Mevlevi establishment as hostile to the Osmanli and the faith; and though he did not do so the Mevlevi and their chiefs were deprived of influence and dignity. In 1829 Mahmud II. restored their dignity in part, and in 1889 Abd-ul-Hamid II. confirmed their exemption from military duty. The head of the Mevlevi dervishes (Aziz-Effendi, Hazreti-Mevlana, Mollah-Unkiar, commonly styled simply Chelebi-Effendi) has the right to gird on the sultan's sword at his investiture, and is master of the considerable revenues of the greatest religious establishment in the empire. He has also the privilege of corresponding direct with the caliph; but otherwise is regarded as rather opposed to the Osmanli administration, and has no real power.

Iconium is distant by rail 466 m. from the Bosphorus at Hajdar-Pasha, and 380 from Smyrna by way of Afium-Kara-Hissar. It has recently become the seat of a considerable manufacture of carpets, owing to the cheapness of labour. The population was estimated at 44,000 in 1890, and is now probably over 50,000. Mercury mines have begun to be worked; other minerals are known to exist. (W. M. RA.)

**ICONOCLASTS** (Gr. *εικονοκλάστης*: *εἰκών*, image, and *κλάω*, to break), the name applied particularly to the opponents in the 8th and 9th centuries of the use of images in Christian cult.

As regards the attitude towards religious images assumed by the primitive Christian Church, several questions have often been treated as one which cannot be too carefully kept apart. There can be no doubt that the early Christians were unanimous in condemning heathen image-worship and the various customs, some immoral, with which it was associated. A form of iconolatry specially deprecated in the New Testament was the then prevalent adoration of the images of the reigning emperors (see Rev. xv. 2). It is also tolerably certain that, if for no other reasons besides the Judaism, obscurity, and poverty of the early converts to Christianity, the works of art seen in their meeting-houses cannot at first have been numerous. Along with these reasons would co-operate towards the exclusion of visible aids to devotion, not only the church's sacramental use of Christ's name as a name of power, and its living sense of his continued real though unseen presence, but also, during the first years, its constant expectation of his second advent as imminent. It was a common accusation brought against Jews and Christians that they had "no altars, no temples, no known images" (Min. Fel. Oct. c. 10), that "they set up no image or form of any god" (see Arnob. *Adv. Gent.* vi. 1; similarly Celsus); and this charge was never denied; on the contrary Origen gloried in it (*c. Celsum*, bk. 7, p. 386). At a comparatively early date, indeed, we read of various Gnostic sects calling in the fine arts to aid their worship; thus Irenaeus (*Haer.* i. 25. 6), speaking of the followers of Marcellina, says that "they possess images, some of them painted, and others formed from different kinds of material; and they maintain that a likeness of Christ

was made by Pilate at that time when Jesus lived among men. They crown these images, and set them up along with the images of the philosophers of the world; that is to say, with the images of Pythagoras and Plato and Aristotle and the rest. They have also other modes of honouring these images after the same manner as the Gentiles" (cf. Aug. *De Haer.* c. 7). It is also well known that the emperor Alexander Severus found a place for several Scripture characters and even for Christ in his lararium (Lamprid. *Vit. Alex. Sev.* c. 29). But there is no evidence that such a use of images extended at that period to orthodox Christian circles. The first unmistakable indication of the public use of the painter's art for directly religious ends does not occur until A.D. 306, when the synod of Elvira, Spain, decreed (can. 36) that "pictures ought not to be in a church, lest that which is worshipped and adored be painted on walls."<sup>1</sup> This canon is proof that the use of sacred pictures in public worship was not at the beginning of the 4th century a thing unknown within the church in Spain; and the presumption is that in other places, about the same period, the custom was looked upon with a more tolerant eye. Indications of the existence of allied forms of sacred Christian art prior to this period are not wholly wanting. It seems possible to trace some of the older and better frescos in the catacombs to a very early age; and Bible manuscripts were often copiously illuminated and illustrated even before the middle of the 4th century. An often-quoted passage from Tertullian (*De Pudic.* c. 10, cf. c. 7) shows that in his day the communion cup was wont to bear a representation of the Good Shepherd. Clement of Alexandria (*Paedag.* iii. 11) mentions the dove, fish, ship, lyre, anchor, as suitable devices for Christian signet rings. Origen (*c. Celsum*, bk. 3) repudiates graven images as only fit for demons.

During the 4th and following centuries the tendency to enlist the fine arts in the service of the church steadily advanced; not, however, so far as appears, with the formal sanction of any regular ecclesiastical authority, and certainly not without strong protests raised by more than one powerful voice. From a passage in the writings of Gregory of Nyssa (*Orat. de Laudibus Theodori Martyris*, c. 2) it is easy to see how the stories of recent martyrs would offer themselves as tempting subjects for the painter, and at the same time be considered to have received from him their best and most permanent expression; that this feeling was widespread is shown in many places by Paulinus of Nola (*Ob. 431*), from whom we gather that not only martyrdoms and Bible histories, but also symbols of the Trinity were in his day freely represented pictorially. Augustine (*De Cons. Ev.* i. 10) speaks less approvingly of those who look for Christ and his apostles "on painted walls" rather than in his written word. How far the Christian feeling of the 4th and 5th centuries was from being settled in favour of the employment of the fine arts is shown by such a case as that of Eusebius of Caesarea, who, in reply to a request of Constantia, sister of Constantine, for a picture of Christ, wrote that it was unlawful to possess images pretending to represent the Saviour either in his divine or in his human nature, and added that to avoid the reproach of idolatry he had actually taken away from a lady friend the pictures of Paul and of Christ which she had.<sup>2</sup> Similarly Epiphanius in a letter to John, bishop of Jerusalem, tells how in a church at Anablatha near Bethel he had found a curtain painted with the image "of Christ or of some other saint," which he had torn down and ordered to be used for the burial of a pauper. The passage, however, reveals not only what Epiphanius thought on the subject, but also that such pictures must have been becoming frequent. Nilus, the disciple and defender of Chrysostom, permitted the symbol of the cross in churches and also pictorial delineations of Old and New Testament history, but deprecated other symbols, pictures of martyrs, and most of all the representation of Christ. In the time of Gregory the Great the Western Church obtained

<sup>1</sup> "Placuit picturas in ecclesia esse non debere, ne quod colitur et adoratur in parietibus depingatur." See Hefele, *Conciliengesch.* i. 170.

<sup>2</sup> The letter, which is most probably, though not certainly, genuine, appears in the *Acta* of the second council of Nice.

something like an authoritative declaration on the question about images, but in a sense not quite the same as that of the synod of Elvira. Srenus of Marseilles had ordered the destruction of all sacred images within his diocese; this action called forth several letters from Pope Gregory (viii. 2. 111; ix. 4. 11), in which he disapproved of that course, and, drawing the distinction which has since been authoritative for the Roman Church, pointed out that—

"It is one thing to worship a picture and another to learn from the language of a picture what that is which ought to be worshipped. What those who can read learn by means of writing, that do the uneducated learn by looking at a picture. . . . That, therefore, ought not to have been destroyed which had been placed in the churches, not for worship, but solely for instructing the minds of the ignorant."

With regard to the symbol of the cross, its public use dates from the time of Constantine, though, according to many Christian archaeologists it had, prior to that date, a very important place in the so-called "disciplina arcani." The introduction of the crucifix was later; originally the favourite combination was that of the figure of a lamb lying at the foot of the cross; the council of Constantinople, called "in Trullo," in 692 enjoined that this symbol should be discontinued, and that where Christ was shown in connexion with his cross he should be represented in his human nature. In the catacombs Christ is never represented hanging on the cross, and the cross itself is only portrayed in a veiled and hesitating manner. In the Egyptian churches the cross was a pagan symbol of life borrowed by the Christians and interpreted in the pagan manner. The cross of the early Christian emperors was a *labarum* or token of victory in war, a standard for use in battle. Religious feeling in the West recoiled from the crucifix as late as the 6th century, and it was equally abhorrent to the Monophysites of the East who regarded the human nature of Christ as swallowed up in the divine. Nevertheless it seems to have originated in the East, perhaps as a protest against the extreme Monophysites, who even denied the passibility of Christ. Perhaps the Nestorians, who clung to the human aspect of Christ, introduced it about 550. From the East it soon passed to the West.

Not until the 8th century were the religious and theological questions which connect themselves with image-worship distinctly raised in the Eastern Church in their entirety. The controversy began with an address which Leo the Isaurian, in the tenth year of his reign (726), delivered in public "in favour of overthrowing the holy and venerable images," as says Theophanes (*Chronogr.*, in *Migne Patr. Gr.* 108, 816). This emperor had, in the years 717 and 718, hurled back the tide of Arab conquest which threatened to engulf Byzantium, and had also shown himself an able statesman and legislator. Born at Germanicia in Syria, and, before he mounted the throne, captain-general of the Anatolian theme, he had come under the influence of the anti-idolator sects, such as the Jews, Montanists, Paulicians and Manicheans, which abounded in Asia Minor, but of which he was otherwise no friend. But his religious reform was unpopular, especially among the women, who killed an official who, by the emperor's command, was destroying an image of Christ in the vestibule of the imperial palace of Chalcedon. This *éméute* provoked severe reprisals, and the partisans of the images were mutilated and killed, or beaten and exiled. A rival emperor even, Agallianus, was set up, who perished in his attempt to seize Constantinople. Italy also rose in arms, and Pope Gregory II. wrote to Leo blaming his interference in religious matters, though he dissuaded the rebels in Venetia, the Exarchate and the Pentapolis from electing a new emperor and marching against Leo. In 730 Germanus the patriarch resigned rather than subscribe to a decree condemning images; later he was strangled in exile and replaced by an iconoclast, Anastasius. Meanwhile, inside the Arab empire, John of Damascus wrote his three dogmatic discourses against the traducers of images, arguing that their use was not idolatry but only a relative worship (*προσκύνησις σχετική*). The next pope, Gregory III. convoked a council of ninety-three bishops, which excommunicated the iconoclasts, and the fleet which Leo sent to retaliate

on the Latin peninsula was lost in a storm in the Adriatic. The most Leo was able to do was to double the tribute of Calabria and Sicily, confiscate the pope's revenues there, and impose on the bishops of south Italy a servitude to Byzantium which lasted for centuries.

Leo III. died in June 740, and then his son Constantine V. began a persecution of the image-worshippers in real earnest. In his eagerness to restore the simplicity of the primitive church he even assailed Mariolatry, intercession of saints, relics and perhaps infant baptism, to the scandal even of the iconoclast bishops themselves. His reign began with the seizure for eighteen months of Constantinople by his brother-in-law Artavasdes, who temporarily restored the images. He was captured and beheaded with his accomplices in November 742, and in February 754 Constantine held in the palace of Hieria a council of 388 bishops, mostly of the East; the patriarchs of Rome, Antioch, Alexandria and Jerusalem refused to attend. In it images were condemned, but the other equally conservative leanings of the emperor found no favour. The chief upholders of images, the patriarch Germanus, George of Cyprus and John of Damascus, were anathematized, and Christians forbidden to adore or make images or even to hide them. These decrees were obstinately resisted, especially by the monks, large numbers of whom fled to Italy. In 765 the emperor demanded of his subjects all over his empire an oath on the cross that they detested images, and St Stephen the younger, the chief upholder of them, was murdered in the streets. A regular crusade now began against monks and nuns, and images and relics were destroyed on a great scale. In parts of Asia Minor (Lydia and Caria) the monks were even forced to marry the nuns. In 769 Pope Stephen III. condemned the council of Hieria, and in 775 Constantine V. died. His son Leo IV. died in 780, leaving a widow, Irene, of Athenian birth, who seized the opportunity presented by the minority of her ten-year-old son Constantine VI. to restore the images and dispersed relics. In 784 she invited Pope Adrian I. to come and preside over a fresh council, which was to reverse that of 754 and heal the schism with Rome. In August 786 the council met, but was broken up by the imperial guards, who were Easterns and sturdy iconoclasts. Irene replaced them by a more trustworthy force, and convoked a fresh council of three hundred bishops and monks innumerable in September 787, at Nicaea in the church of St Sophia. The cult of images was now solemnly restored, iconoclast bishops deposed or reconciled, the dogmatic theory of images defined, and church discipline re-established. The order thus imposed lasted twenty-four years, until a military revolution placed a soldier of fortune, half Armenian, half Persian, named Leo, on the throne; he, like his soldiers, was persuaded that the ill-success of the Roman arms against Bulgarians and other invaders was due to the idolatry rampant at court and elsewhere. The soldiers stoned the image of Christ which Irene had set up afresh in the palace of Chalcedon, and this provoked a counter-demonstration of the clergy. Leo feigned for a while to be on their side, but on the 2nd of February 815, in the sanctuary of St Sophia, publicly refused to prostrate himself before the images, with the approbation of the army and of many bishops who were iconoclasts at heart. Irene's patriarch Nicephorus was now deposed and one Theodotus, a kinsman of Constantine Copronymus, consecrated in his place on the 1st of April 815. A fresh council was soon convoked, which cursed Irene and re-enacted the decrees of 754. This reaction lasted only for a generation under Leo the Armenian, who died 820, Michael II. 820-829, and Theophilus 829-842; and was frustrated mainly by the exertions of Theodore of Studion and his monks, called the Studitæ. Theodore refused to attend or recognize the new council, and was banished first to Bithynia and thence to Smyrna, whence he continued to address his appeals to the pope, to the eastern patriarchs and to his dispersed monks. He died in 826. Theophilus, the last of the iconoclast emperors, was a devoted Mariolater and controversialist who invited the monks to discuss the question of images with him, and whipped or branded them when he was out-argued; he at length banished them from the cities, and

branded on the hands a painter of holy pictures, Lazarus by name, who declined to secularize his art; he also raised to the patriarchal throne John Hylilas, chief instigator of the reaction of 815. In 842 Theophilus died, leaving his wife Theodora regent; she was, like Irene, addicted to images, and chose as patriarch a monk, Methodius, whom the emperor Michael had imprisoned for laying before him Pope Paschal I.'s letter of protest. John Hylilas was deposed and flogged in turn. A fresh council was now held which re-enacted the decrees of 787, and on the 20th of February 842 the new patriarch, the empress, clergy and court dignitaries assisted in the church of St Sophia at a solemn restoration of images which lasted until the advent of the Turks. The struggle had gone on for 116 years.

The iconoclastic movement is perhaps the most dramatic episode in Byzantine history, and the above outline of its external events must be completed by an appreciation of its deeper historical and religious significance and results. We can distinguish three parties among the combatants:—

1. The partisans of image worship. These were chiefly found in the Hellenic portions of the empire, where Greek art had once held sway. The monks were the chief champions of images, because they were illuminators and artists. Their doctors taught that the same grace of the Holy Spirit which imbued the living saint attaches after death to his relics, name, image and picture. The latter are thus no mere representations, but as it were emanations from the archetype, vehicles of the supernatural personality represented, and possessed of an inherent sacramental value and power, such as the name of Jesus had for the earliest believers. Here Christian image-worship borders on the beliefs which underlie sympathetic magic (see IMAGE WORSHIP).

2. The iconoclasts proper, who not only condemned image worship in the sense just explained but rejected all religious art whatever. Fleeting matter to their mind was not worthy to embody or reflect heavenly supersensuous energies denoted by the names of Christ and the saints. For the same reason they rejected relics and, as a rule, the worship of the cross. Statues of Christ, especially of him hanging on the cross, inspired the greatest horror and indignation; and this is why none of the graven images of Christ, common before the outbreak of the movement, survive. More than this—although the synod of 692 specially allowed the crucifix, yet Greek churches have discarded it ever since the 8th century.

This idea that material representation involves a profanation of divine personages, while disallowing all religious art which goes beyond scroll-work, spirals, flourishes and geometrical designs, yet admits to the full of secular art; and accordingly the iconoclastic emperors replaced the holy pictures in churches with frescoes of hunting scenes, and covered their palaces with garden scenes where men were plucking fruit and birds singing amid the foliage. Contemporary Mahomedans did the same, for it is an error to suppose that this religion was from the first hostile to profane art. At one time the mosques were covered with mosaics, analogous to those of Ravenna, depicting scenes from the life of Mahomet and the prophets. The Arabs only forbade plastic art in the 9th century, nor were their essentially Semitic scruples ever shared by the Persians.

The prejudice we are considering is closely connected with the Manichaean view of matter, which in strict consistency rejected the belief that God was really made flesh, or really died on the cross. The Manichaeans were therefore, by reason of their dualism, arch-enemies no less of Christian art than of relics and cross-worship; the Monophysites were equally so by reason of their belief that the divine nature in Christ entirely absorbed and sublated the human; they shaded off into the party of the *aphthartodokeis*, who held that his human body was incorruptible and made of ethereal fire, and that his divine nature was impassible. Their belief made them, like the Manichaeans, hostile to material portraiture of Christ, especially of his sufferings on the cross. All these nearly allied schools of Christian thought could, moreover, address, as against the image-

worshippers, a very effective appeal to the Bible and to Christian antiquity. Now Egypt, Asia Minor, Armenia, western Syria and the Hauran were almost wholly given up to these forms of opinion. Accordingly in all the remains of the Christian art of the Hauran one seeks in vain for any delineation of human face or figure. The art of these countries is mainly geometrical, and allows only of monograms crowned with laurels, of peacocks, of animals gambolling amid foliage, of fruit and flowers, of crosses which are either *svastikas* of Hindu and Mycenaean type, or so lost in enveloping arabesques as to be merely decorative. Such was the only religious art permitted by the Christian sentiment of these countries, and also of the large *endaves* of semi-Manichaean belief formed in the Balkans by the transportation thither of Armenians and Paulicians. And it is important to remark that the protagonists of iconoclasm in Byzantium came from these lands where image cult offended the deepest religious instincts of the masses. Leo the Isaurian had all the scruples of a Paulician, even to the rejection of the cult of Virgin and saints; Constantine V. was openly such. Michael Balbus was reared in Phrygia among Montanists. The soldiers and captains of the Byzantine garrisons were equally Armenians and Syrians, in whom the sight of a crucifix or image set up for worship inspired nothing but horror.

The issue of the struggle was not a complete victory even in Byzantium for the partisans of image-worship. The iconoclasts left an indelible impress on the Christian art of the Greek Church, in so far as they put an end to the use of graven images; for the Eastern icon is a flat picture, less easily regarded than would be a statue as a *nidus* within which a spirit can lurk. Half the realm of creative art, that of statuary, was thus suppressed at a blow; and the other half, painting, forfeited all the grace and freedom, all the capacity of new themes, forms and colours, all the development which we see in the Latin Church. The Greeks have produced no Giotto, no Fra Angelico, no Raphael. Their artists have no choice of subjects and no initiative. Colour, dress, attitude, grouping of figures are all dictated by traditional rules, set out in regular manuals. God the Father may not be depicted at all—a restriction intelligible when we remember that the image in theory is fraught with the virtue of the archetype; but everywhere the utmost timidity is shown. What else could an artist do but make a slavish and exact copy of old pictures which worked miracles and perhaps had the reputation as well of having fallen from heaven?

3. Between these extreme parties the Roman Church took the middle way of common sense. The hair-splitting distinction of the Byzantine doctors between veneration due to images (*προσκύνησις τιμητική*), and the adoration (*προσκύνησις λατρευτική*) due to God alone, was dropped, and the utility of pictures for the illiterate emphasized. Their use was declared to be this, that they taught the ignorant through the eye what they should adore with the mind; they are not themselves to be adored. Such was Gregory the Great's teaching, and such also is the purport of the Caroline books, which embody the conclusions arrived at by the bishops of Germany, Gaul and Aquitaine, presided over by papal legates at the council of Frankfurt in 794; and incidentally also reveal the hatred and contempt of Charlemagne for the Byzantine empire as an institution, and for Irene, its ruler, as a person. The theologians whom Louis the Pious convened at Paris in 825, to answer the letter received from the iconoclast emperor Michael Balbus, were as hostile to the orthodox Greeks as to the image-worshippers, and did not scruple to censure Pope Adrian for having approved of the empress Irene's attitude. The council of Trent decided afresh in the same sense.

Two incidental results of the iconoclastic movement must be noticed, the one of less, the other of more importance. The lesser one was the flight of Greek iconolatrous monks from Asia Minor and the Levant to Sicily and Calabria, where they established convents which for centuries were the western homes of Greek learning, and in which were written not a few of the oldest Greek MSS. found in our libraries. The greater event

was the scission between East and West. The fury of the West against the iconoclastic emperors was such that the whole of Italy clamoured for war. It is true that Pope Stephen II. applied in 753 to Constantine V., one of the worst destroyers of images, for aid against the Lombards, for the emperor of Byzantium was still regarded as the natural champion of the church. But Constantine refused aid, and the pope turned to the Frankish King Pippin. The die was cast. Henceforth Rome was linked with the Carolingian house in an alliance which culminated in the coronation of Charlemagne by the pope on the 25th of December 800.

In the crusading epoch the Cathars and Paulicians carried all over Europe the old iconoclastic spirit, and perhaps held to transmit it to Wycliffe and Hus. Not the least rare clause in the document compiled about 1389 by the Wycliffites in defence of their defunct teacher is the following: "Hit semes that this offryngne ymages is a sotile cast of Antichriste and his clerkis for to drawe almes fro pore men . . . certis, these ymages of hemselve may do nouthre gode nor yvel to mennis soules, but that myghten wourme a man's body in colde, if thati were sette upon a fire."

At the period of the Reformation it was unanimously felt by the reforming party that, with the invocation of saints and the practice of reverencing their relics, the adoration of images ought also to cease. The leaders of the movement were not, however, perfectly agreed on the question as to whether these might not in some circumstances be retained in churches. Luther had no sympathy with the iconoclastic outbreaks which then occurred; he classed images in themselves as among the "adiaphora," and condemned only their cultus; so also the "Confessio Tetrapolitana" leaves Christians free to have them or not, if only due regard be had to what is expedient and edifying. The "Heidelberg Catechism," however, emphatically declares that images are not to be tolerated at all in churches.

SOURCES.—"Acts of the Seventh Ecumenical Council held in Nicaea, 787," in Mansi's *Concilia*, vols. xii. and xiii.; "Acts of the Iconoclastic Council of 845" in a treatise of Nicephorus discovered by M. Lezouart and printed in the *Stances Acad. des Inscriptions* (May 1903); Theophanes, *Chronographia*, edit. de Boor (Leipzig, 1883-1885); and *Patr. Gr.* vol. 108. Also his "Continuators" in *Patr. Gr.* vol. 109; Nicephorus, *Chronicon*, edit. de Boor (Leipzig, 1880), and *Patr. Gr.* vol. 100; Georgios Monachus, *Chronicon*, edit. Muralt (Petersburg, 1859), and *Patr. Gr.* 110; anonymous "Life of Leo the Armenian" in *Patr. Gr.* 108; *The Book of the Kings*, by Joseph Gesenius, *Patr. Gr.* 109; "Life of S. Stephanus, Junior," *Patr. Gr.* 100; "St. John of Damascus," three "Sermons" against the iconoclasts, *Patr. Gr.* 95; Nicephorus Patriarch, "Antirrhethici," *Patr. Gr.* 100; Theodore Studita, "Antirrhethici," *Patr. Gr.* 99. For bibliography of contemporary hymns, letters, &c., bearing on the controversy see K. Krumbacher's *History of Byzantine Literature*, 2nd ed. p. 674. Literature: Louis Brehier, *La Querelle des images*, and *Les Origines du crucifix* (Paris, 1904); Librairie Blond, in French, each volume 60 centimes (brief but admirable); Karl Schwartzlose, *Der Bilderstreit* (Gotha, 1890); Karl Schenk, "The Emperor Leo II.," in *Byzant. Zeitschrift* (1896, German); Th. Uspenski, *Skizzen zur Geschichte der byzantinischen Kultur* (St. Petersburg, 1892, Russian); Lombard, *Études d'histoire byzantine*; Constantine V. (Paris, 1902, *Biblioth. de l'université de Paris*, xvi.); A. Tougaard, *La Persécution iconoclaste* (Paris, 1897); and *Rev. des questions historiques* (1891); Marin, *Les Moines de Constantinople* (Paris, 1897, bk. iv. *Les Moines et les empereurs iconoclastes*); Alice Gardner, *Theodore of Studium* (London, 1905); Louis Jaubourg, *Histoire de l'hérésie des iconoclastes* (Paris, 1679-1683); J. Dailly (Dallaues), *De imaginibus* (Leiden, 1642, and in French, Geneva, 1644); Spanheim, *Historia imaginum* (Leiden, 1686). See also the account of this epoch in the *Histories* of Neander, Gibbon and Milman; Aug. Fr. Gröfner, "Der Bildersturm" in *Byzantinische Geschichte* 2 (1873); C. J. von Hefele, *Conciliengeschichte* 3 (1877), 366 ff. (also in English translation; Karl Krumbacher, *Byzant. Literaturgeschichte* (2nd ed. p. 1090).

**ICONOSTASIS**, the screen in a Greek church which divides the altar and sanctuary from the rest of the church. It is generally attached to the first eastern pier or column and rises to the level of the springing of the vault. The iconostasis or image-bearer has generally three doors, one on each side of the central door, beyond which is the principal altar. The screen is subdivided into four or five tiers, each tier decorated with a series of panels containing representations of the saints: of these

only the heads, hands and feet are painted, the bodies being covered with embossed metal work, richly gilded. There is a fine example in the Russo-Greek chapel, Welbeck Street, London, which was rebuilt in 1864-1865.

**ICOSAHEDRON** (Gr. ἰκωσι, twenty, and ἔδρα, a face or base), in geometry, a solid enclosed by twenty faces. The "regular icosahedron" is one of the Platonic solids; the "great icosahedron" is a Kepler-Poinsot solid; and the "truncated icosahedron" is an Archimedean solid (see POLYHEDRON). In crystallography the icosahedron is a possible form, but it has not been observed; it is closely simulated by a combination of the octahedron and pentagonal dodecahedron, which has twenty triangular faces, but only eight are equilateral, the remaining twelve being isosceles (see CRYSTALLOGRAPHY).

**ICTERUS**, a bird so called by classical authors, and supposed by Pliny to be the same as the *Galgulus*, which is generally identified with the golden oriole (*Oriolus galbula*).<sup>1</sup> It signified a bird in the plumage of which yellow or green predominated, and hence Brisson did not take an unhappy liberty when he applied it in a scientific sense to some birds of the New World of which the same could be said. These are now held to constitute a distinct family, *Icteridae*, intermediate it would seem between the BUNTINGS (*q.v.*) and STARLINGS (*q.v.*); and, while many of them are called troopials (the English equivalent of the French *Troupiales*, first used by Brisson), others are known as the American GRACKLES (*q.v.*). The typical species of *Icterus* is the *Oriolus icterus* of Linnaeus, the *Icterus vulgaris* of Daudin and modern ornithologists, an inhabitant of northern Brazil, Guiana, Venezuela, occasionally visiting some of the Antilles and of the United States. Thirty-three species of the genus *Icterus* alone, and more than seventy others belonging to upwards of a score of genera, are recognized by Sclater and Salvin (*Nomenclator*, pp. 35-39) as belonging to the Neotropical Region, though a few of them emigrate to the northward in summer. *Cassicus* and *Ostinops* may perhaps be named as the most remarkable. They are nearly all gregarious birds, many of them with loud and in most cases, where they have been observed, with melodious notes, rendering them favourites in captivity, for they readily learn to whistle simple tunes. Some have a plumage wholly black, others are richly clad, as is the well-known Baltimore oriole, golden robin or hangnest of the United States, *Icterus baltimore*, whose brightly contrasted black and orange have conferred upon it the name it most commonly bears in North America, those colours being, says Catesby (*Birds of Carolina*, i. 48), the tinctures of the armorial bearings of the Calverts, Lords Baltimore, the original grantees of Maryland, but probably more correctly those of their liveries. The most divergent form of *Icteridae* seems to be that known in the United States as the meadow-lark, *Sialia magna* or *S. ludoviciana*, a bird which in aspect and habits has considerable resemblance to the larks of the Old World, *Alaudidae*, to which, however, it has no near affinity, while *Dolichonyx oryzivorus*, the bobolink or rice-bird, with its very bunting-like bill, is not much less aberrant. (A. N.)

**ICTINUS**, the architect of the Parthenon at Athens, of the Hall of the Mysteries at Eleusis, and of the temple of Apollo at Bassae, near Phigalia. He was thus active about 450-430 B.C. We know little else about him; but the remains of his two great temples testify to his wonderful mastery of the principles of Greek architecture.

**IDA** (d. 559), king of Bernicia, became king in 547, soon after the foundation of the kingdom of Bernicia by the Angles. He built the fortress of Bebbanburh, the modern Bamborough, and after his death his kingdom, which did not extend south of the Tees, passed in turn to six of his sons. The surname of

<sup>1</sup> The number of names by which this species was known in ancient times—*Chloris* or *Chlorion*, *Galbulus* (akin to *Galgulus*), *Parra* and *Vireo*—may be explained by its being a common and conspicuous bird, as well as one which varied in plumage according to age and sex (see ORIOLE). Owing to its general colour, *Chloris* was in time transferred to the GREENFINCH (*q.v.*), while the names *Galbula*, *Parra* and *Vireo* have since been utilized by ornithologists (see JACAMAR and JACANA).

"Flame-Bearer," sometimes applied to him, refers, however, not to Ida, but to his son Theodic (d. 587).

See J. R. Green, *Making of England*, vol. i. (London, 1897).

**IDAHO**, a western state of the United States of America, situated between 42° and 46° N. lat. and 111° and 117° W. long. It is bounded N. by British Columbia and Montana, E. by Montana and Wyoming, S. by Utah and Nevada, and W. by Oregon and Washington. Its total area is 83,888 sq. m., of which 83,354 sq. m. are land surface, and of this 41,851.55 sq. m. were in July 1908 unappropriated and unreserved public lands of the United States, and 31,775.7 sq. m. were forest reserves, of which 15,153.5 sq. m. were reserved between the 1st of July 1906 and the 1st of July 1907.

**Physical Features.**—Idaho's elevation above sea-level varies from 738 ft. (at Lewiston, Nez Perce county) to 12,078 ft. (Hyndman Peak, on the boundary between Custer and Blaine counties), and its mean elevation is about 4500 ft. The S.E. corner of the wedge-shaped surface of the state is a part of the Great Basin region of the United States. The remainder of the state is divided by a line running S.E. and N.W., the smaller section, to the N. and E., belonging to the Rocky Mountain region, and the larger, S. and W. of this imaginary line, being a part of the Columbia Plateau region. The topography of the Great Basin region in Idaho is similar to that of the same region in other states (see NEVADA); in Idaho it forms a very small part of the state; its mountains are practically a part of the Wasatch Range of Utah; and the southward drainage of the region (into Great Salt Lake, Bear River) also applies to it from the other parts of the state. The Rocky Mountain region of Idaho is bounded by most of the state's irregular E. boundary—the Bitter Root, the Cœur d'Alene and the Cabinet ranges being parts of the Rocky Mountain System. The Rocky Mountain region reaches across the N. part of the state (the Panhandle), and well into the middle of the state farther S., where the region is widest and where the Salmon River range is the principal one. The region is made up in general of high ranges deeply glaciated, preserving some remnants of ancient glaciers, and having fine "Alpine" scenery, with many sharp peaks and ridges, U-shaped valleys, cirques, lakes and waterfalls. In the third physiographic region, the Columbia plateau, are the Saw Tooth, Boise, Owyhee and other rugged ranges, especially on the S. and W. borders of the region. The most prominent features of this part of the state are the arid Snake river plains and three mountain-like elevations—Big, Middle and East Buttes—that rise from their midst. The plains extend from near the S.E. corner of the state in a curve to the N. and N.W. for about 350 m. over a belt 50 to 100 m. wide, and cover about 20,000 sq. m. Where they cross the W. border at Lewiston is the lowest elevation in the state, 738 ft. above the sea. Instead of being one plain formed by erosion, this region is rather a series of plains built up with sheets of lava, several thousand feet deep, varying considerably in elevation and in smoothness of surface according to the nature of the lava, and being greater in area than any other lava beds in North America except those of the Columbia river, which are of similar formation and, with the Snake river plains, form the Columbia plateau. Many volcanic cones mark the surface, but by far the most prominent among them are Big Butte, which rises precipitously 2350 ft. above the plain (7650 ft. above the sea) in the E. part of Blaine county, and East Butte, 700 ft. above the plain, in the N.W. part of Bingham county. Middle Butte (400 ft. above the plain, also in Bingham county) is an upraised block of stratified basalt. The Snake river (which receives all the drainage of Idaho except small amounts taken by the Spokane, the Pend Oreille and the Kootenai in the N., all emptying into the Columbia, and by some minor streams of the S.E. that empty into Great Salt Lake, Utah) rises in Yellowstone National Park a few miles from the heads of the Madison fork of the Missouri, which flows to the Gulf of Mexico, and the Green fork of the Colorado, which flows to the Gulf of California. It flows S.W. and then W. for about 800 m. in a tremendous canyon across southern Idaho; turns N. and runs for 200 m. as the boundary between Idaho and Oregon (and for a short distance between Idaho and Washington); turns again at Lewiston (where it ceases to be the boundary) and where the Clearwater empties into it) to the W. into a deep, narrow valley, and joins the Columbia in S.E. Washington. Practically all the valley of the Snake from Idaho Falls in S.E. Idaho (Bingham county) to the mouth is of cañon character, with walls from a few hundred to 6000 ft. in height (about 650 m. in Idaho). The finest parts are among the most magnificent in the west; among its falls are the American (Oneida and Blaine counties), and the Shoshone and the Salmon (Lincoln county). At Shoshone Falls the river makes a sudden plunge of nearly 200 ft., and the Falls have been compared with the Niagara and Zambezi; a short distance back of the main fall is a cataract of 125 ft., the Bridal Veil. Between Henry's Fork and Malade (or Big Wood) river, a distance of 200 m., the river apparently has no northern tributaries; but several streams, as the Camas, Medicine Lodge and Birch creeks, and Big and Little Lost rivers, which fail to penetrate the plain of the Snake after reaching its border, are believed to

join it through subterranean channels. The more important affluents are the North Fork in the E., the Raft, Salmon Falls and the Bruneau in the S., the Owyhee and the Payette in the S.W., and the Salmon and Clearwater in the W. The scenery on some of these tributaries is almost as beautiful as that of the Snake, though lacking the grandeur of its greater scene. In 1904 electricity, generated by water-power from the rivers, notably the Snake, began to be utilized in mining operations. Scattered among the mountains are numerous (glacial) lakes. In the N. are: Cœur d'Alene Lake, in Kootenai county, about 30 m. long and from 2 to 4 m. wide, drained by the Spokane river; Priest Lake, in Bonner county, 20 m. long and about 10 m. wide; and mostly in Bonner, but partly in Kootenai county, a widening of Clark Fork, Lake Pend Oreille, 60 m. long and from 3 to 15 m. wide, which is spanned by a trestle of the Northern Pacific 8400 ft. long. Bear Lake, in the extreme S.E., lies partly in Utah. Mineral springs and hot springs are also a notable feature of Idaho's physiography; being found in Washington, Ada, Blaine, Bannock, Cassia, Owyhee, Oneida, Nez Perce, Kootenai, Shoshone and Fremont counties. At Soda Springs in Bannock county are scores of springs whose waters, some ice cold and some warm, contain magnesium, soda, iron, sulphur, &c.; near Hailey, Blaine county, water with a temperature of 144° F. is discharged from numerous springs; and at Boise, water with a temperature of 165° is obtained from wells.

The fauna and flora of Idaho are similar in general to those of the other states in the north-western part of the United States.

**Climate.**—The mean annual temperature of Idaho from 1898 to 1903 was 45.5° F. There are several distinct climate zones within the state. North of Clearwater river the climate is comparatively mild, the maximum in 1902 (96° F.) being lower than the highest temperature in the state and the minimum (–16°) higher than the lowest temperature registered. The mildest region of the state is the Snake river basin between Twin Falls and Lewiston, and the valley through the Boise, Payette and Weiser rivers; here the mean annual temperature in 1902 was 52° F., the maximum was 106° F., and the minimum was –13° F. In the Upper Snake basin, in the Camas prairie and Lost river regions, the climate is much colder, the highest temperature in 1902 being 101° and the lowest –35° F. The mean annual rainfall for the entire state in 1903 was 16.60 in.; the highest amount recorded was at Murray, Shoshone county (37.70 in.) and the lowest was at Garnet, Elmore county (5.69 in.).

**Agriculture.**—The principal source of wealth in Idaho is its 1904 agriculture, but it had long been secondary to mining, and its development had been impeded by certain natural disadvantages. Except for the broad valleys of the Panhandle, where the soils are black in colour and rich in vegetable mould, the surface of the state is arid; the Snake river valley is a vast lava bed, covered with deposits of salt and sand, or soils of volcanic origin. And, apart from this, the farming country was long without transport facilities. The fertile northern plateaus, the Camas and Nez Perce prairies and the Patuxent country—a wide level of rich soil for growing the durum or macaroni wheat—until 1898 had no market nearer than Lewiston, 50-70 m. away; and even in 1898, when the railway was built, large parts of the region were not tapped by it, and were as much as 30 m. from any shipping point, for the road had followed the Clearwater. In the arid southern region, also, there was no railway until 1885, when the Oregon Short Line was begun. Like limitations in N. and S. had like effects: for years the country was devoted to live-stock, which could be driven to a distant market. Timothy was grown in the northern, and alfalfa in the southern, regions as a forage crop. Even at this earliest period, irrigation, simple and individual, had begun in the southern section, the head waters of the few streams in this district being soon surrounded by farms. Co-operation and colonization followed, and more ditching was done, co-operative irrigation canals were constructed with some elaborate and large dams and head gates. The Carey Act (1894) and the Federal Reclamation Act (1902) introduced the most important period of irrigation. Under the Carey Act the Twin Falls project, deriving water from the Snake river near Twin Falls, and irrigating more than 200,000 acres, was completed in 1903-1904. The great projects undertaken with Federal aid were: the Mindoka, in Lincoln and Cassia counties, of which survey began in March 1903 and construction in December 1904, and which was completed in 1907, commanding an irrigable area of 130,000-150,000 acres,<sup>1</sup> and has a diversion dam (rock-fill type) 600 ft. long, and 130 m. of canals and 110 m. of laterals; the larger Payette-Boise project in Ada, Canyon and Owyhee counties (372,000 acres irrigable; 300,000 m. of desert; 60% privately owned), whose principal features are the Payette dam (rock-fill), 100 ft. high and 400 ft. long, and the Boise dam (masonry), 33 ft. high and 400 ft. long, 200 m. of canals, 100 m. of laterals, a tunnel 1100 ft. long and 12,500 h.p. transmitted 29 m., 3000 h.p. being necessary to pump to a height of 50-90 ft. water for the irrigation of 15,000 acres; and the Dubois project, the largest in the state, on which survey and reconnaissance work were done in 1903-1904, which requires storage sites on the North Fork of the

<sup>1</sup> Of these 80,000 acres are reached directly—72,000 N., and 8000 S., of the Snake river; and from 50,000 to 70,000 acres more are above the level of the canals and will have water pumped to them by the 11,000-30,000 h.p. developed.



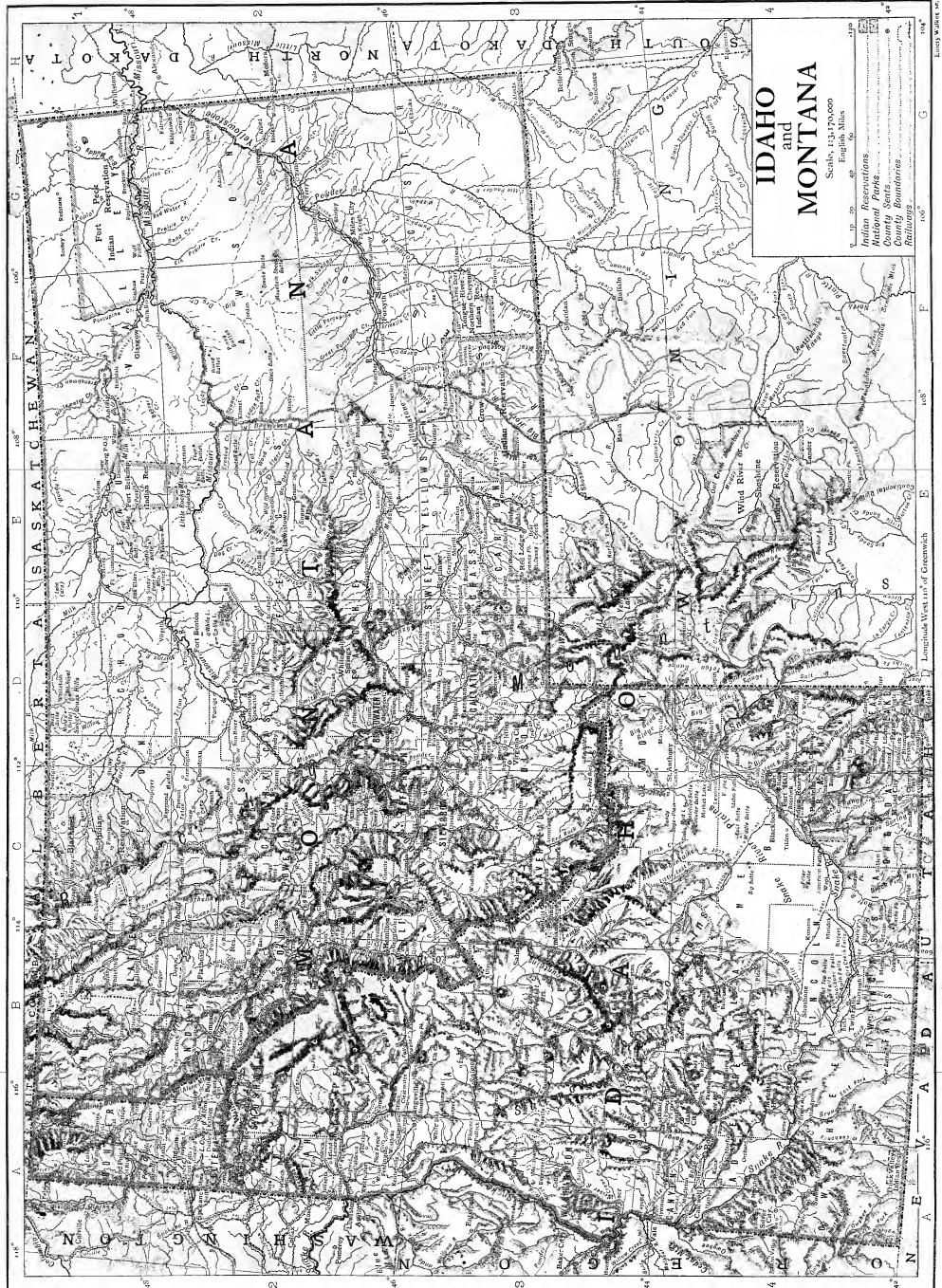

# IDAHO and MONTANA

Scale, 1:3,750,000  
English Miles  
to  
Kilometers

- ..... Recreation
- ..... National Parks
- ..... County Seats
- ..... County Boundaries
- ..... Railroads

Latitude and Longitude

Scale, 1:3,750,000

English Miles

Kilometers

Recreation

National Parks

County Seats

County Boundaries

Railroads

Washington

Oregon

Nevada

Utah

Arizona

New Mexico

Texas

Oklahoma

Kansas

Nebraska

South Dakota

North Dakota

Wyoming

Snake and on nearly all the important branches of the North Fork, and whose field is 200,000—250,000 acres, almost entirely Federal property, in the W. end of Fremont county between Mud Lake and the lower end of Big Lost river. A further step in irrigation is the utilization of underground waters: in the Big Camas Prairie region, Blaine county, water 10 ft. below the surface is tapped and pumped by electricity generated from the only surface water of the region, Cassin Creek. In 1899 the value of the crops and other agricultural products of the irrigated region amounted to more than seven-tenths of the total for the state. In 1907, according to the Report of the state commissioner of immigration, 1,559,915 irrigated acres were under cultivation, and 3,266,386 acres were "covered" by canals 37.89 m. long and costing \$11,257,023.

Up to 1900 the most prosperous period (absolutely) in the agricultural development of the state was the last decade of the 19th century; the relative increase, however, was greater between 1880 and 1890. The number of farms increased from 1885 to 1889 to 6903 in 1890 and to 17,471 in 1900; the farm acreage from 327,798 in 1880 to 1,302,256 in 1890 and to 3,204,903 acres in 1900; the irrigated area (exclusive of farms on Indian reservations) from 217,005 acres in 1889 to 602,568 acres in 1899; the value of products increased from \$1,515,314 in 1879 to \$3,848,930 in 1889, and to \$18,051,625 in 1899; the value of farm land with improvements (including buildings) from \$2,832,890 in 1880 to \$17,431,580 in 1890 and \$42,318,183 in 1900; the value of implements and machinery from \$363,930 in 1880 to \$1,172,450 in 1890 and to \$3,295,045 in 1900; and that of live-stock from \$4,023,800 in 1880 to \$7,253,490 in 1890 and to \$21,657,974 in 1900. In 1900 the average size of farms was 184.2 acres, the value of the output of the prevailing form of tenure, 91.3% of the farms being so operated in 1900 (2.3% by cash tenants and 6.4% by share tenants). As illustrative of agricultural conditions the contrast of the products of farms operated by Indians, Chinese and whites is of considerable interest, the value of products (not fed to live-stock) per acre of the 563 Indian farms being in 1899 \$1.40, that of the 16,876 white farms \$4.67, and that of the 23 Chinese farms intensively cultivated and devoted to market vegetables \$60.83.

The income from agriculture in 1899 was almost equally divided between crops, \$8,951,440 and animal products, (\$8,784,364) in that year forest products were valued at \$12,852,400. Hay, crops, hay and forest were the most valuable (\$4,238,993), yielding 47.4% of the total value of crops, an increase of more than 200% over that of 1889, and in 1907, according to the Year-book of the Department of Agriculture, the crop was valued at \$8,585,000. Wheat, which in 1899 ranked second (\$2,131,953), showed an increase of more than 400% in the decade, and the farm value of the crop of 1907, according to the Year-book of the United States Department of Agriculture, was \$5,788,000; the value of the barley crop in 1899 (\$3,127,390) also increased more than 400% over that of 1889, and in 1907 the farm value of the crop according to the same authority, was \$1,265,000; the value of the oat crop in 1899 (\$702,955) showed an increase of more than 300% in the decade, and the value of the product in 1907, according to the United States Department of Agriculture, was \$2,397,000.

More than one-half of the cereal crop in 1905 was produced in the prairie and plateau region of Nez Perce and Latah counties. The production of orchard fruits (apples, cherries, peaches, pears, plums and prunes) increased greatly from 1889 to 1899; the six counties of the Canyon (probably the leading fruit county of the state), and Latah (famous for its plums), Owyhee and Nez Perce counties had in 1900 89% of the plum and prune trees, 85% of all pear trees, 78% of all cherry trees, and 74% of all apple trees in the state, and in 1906 it was estimated by the State Commissioner of Immigration that there were nearly 48,000 acres of land devoted to orchard fruits in Idaho. Viticulture is of importance, particularly in the Lewiston valley. In 1906, 234,000 tons of sugar beets were raised, and fields in the Boise valley raised 30 tons per acre.

Of the animal products in 1899, the most valuable was live-stock sold during the year (\$3,909,454); the stock-raising industry was carried on most extensively in the S. E. part of the state. Wool ranked second in value (\$2,210,790), and according to the estimate of the National Association of Wool Manufacturers for 1907, Idaho ranked fourth among the wool-producing states in number of sheep (2,900,000), third in wool, washed and unwashed (17,250,000 lb), and fourth in scoured wool (5,692,500 lb). In January 1908, according to the Year-book of the Department of Agriculture, the number and farm values of live-stock were: milch cows, 69,000, valued at \$2,208,000, and other neat cattle, 344,000, valued at \$5,848,000; horses, 150,000, \$11,250,000; sheep, 3,575,000, \$12,691,000; and swine, 130,000, \$9,100,000. According to state reports for 1906, most of the neat cattle were raised in Lemhi, Idaho, Washington, Cassia and Owyhee counties; Nez Perce, Canyon, Fremont, Idaho, and Washington counties had the largest number of horses; Owyhee, Blaine and Canyon counties had the largest numbers of sheep, and Idaho and Nez Perce counties were the principal swine-raising regions. The pasture lands of the state have been greatly decreased by the increase of forest reserves, especially by the large reservations made in 1906-1907.

MINING.—The mineral resource of Idaho are second only to the agricultural; indeed it was primarily the discovery of the immense

value of the deposits of gold and silver about 1860 that led to the settlement of Idaho Territory. In Idaho, as elsewhere, the first form of mining was a very lucrative working of placer deposits; this gave way to vein mining and a greatly reduced production of gold and silver after 1878, on account of the exhaustion of the placers. Then came an adjustment to new conditions and a gradual increase of the product. The total mineral product in 1906, according to the Mine and Geology report, was valued at \$8,317. The total gold production of Idaho from 1860 to 1906 has been estimated at \$250,000,000, of which a large part was produced in the Idaho Basin, the region lying between the N. fork of the Boise and the S. fork of the Payette rivers. In 1901-1902 rich gold deposits were discovered in the Thunder Mountain district in Idaho county. The counties with the largest production of gold in 1907 (state report) were Owyhee (\$362,742), Boise (\$282,444), Custer (\$210,900) and Idaho; the total for the state was \$1,075,618 in 1905; in 1906 it was \$1,149,100; and in 1907, according to state reports, \$1,373,631. The total of the state for silver in 1905 was \$5,242,172; in 1906 it was \$6,042,609; in 1907, according to state reports, it was \$5,546,554. The richest deposits of silver are those of Wood river and of the Cœur d'Alene district in Shoshone county (opened up in 1886); the county's product in 1906 was valued at \$5,322,706, an increase of \$917,743 over the preceding year; in 1907 it was \$4,780,093, according to state reports. The production of the next richest county, Owyhee, in 1907, was less than one tenth that of Shoshone county, which yields, besides, about one half of the lead mined in the United States, its product of lead being valued at \$9,851,076 in 1904, at \$14,305,205 in 1906, and at \$12,323,233 (state report) in 1907. Idaho was the 11th largest producer of the output of lead in the United States, Colorado in rank, to 1906, excepting the year 1899, when Colorado again was first; the value of the lead mined in 1906 was \$14,535,823, and of that mined in 1907 (state report), \$12,470,375. High grade copper ores have been produced in the Seven Devils and Washington districts of Washington county; there are deposits, little developed up to 1906, in Lemhi county (which was almost inaccessible by railway) and in Bannock county; the copper mined in 1905 was valued at \$1,134,846, and in 1907, according to state reports, at \$2,241,177, of which about two-thirds was the output of the Cœur d'Alene district in Shoshone county. Other districts in the Cœur d'Alene district, at Hailley, Blaine county and elsewhere; according to the state reports, the state's output in 1906 was valued at \$91,426 and in 1907 at \$534,087. Other minerals of economic value are sandstone, quarried at Boise, Ada county, at Preston, Oneida county, and at Goshen, Prospect and Idaho Falls, Blingham county, valued at \$22,265 in 1905, and at \$11,969 in 1906; limestone, valued at \$14,105 in 1905 and at \$12,600 in 1906, used entirely for the local manufacture of lime, part of which was used in the manufacture of sugar; and coal, in the Horseshoe Bend and Jerusalem districts in Bonner county, in Lemhi county for Union City, and in Blingham county. The total output of coal in 1906 was valued at \$365 tons, valued at \$18,538 as compared with 20 and to tons respectively in 1899 and 1900. Minerals developed slightly, or not at all, are granite, valued at \$1500 in 1905; surface salt, in the arid and semi-arid regions; nickel and cobalt, in Lemhi county; tungsten, near Murray, Shoshone county; monazite and zircon, in certain sands; and some pumice.

Manufactures.—The manufactures of Idaho in 1900 were relatively unimportant, the value of all products of establishments under the factory system being \$3,001,442; in 1905 the value of the same products had increased to \$10,227,000, or \$7,225,558. The manufacturing establishments were limited to the supply of local demands. The principal industries were devoted to lumber and timber products, valued at \$908,670 in 1900, and in 1905 at \$2,834,506, 211.9% more. In 1906 the Weyerhaeuser Syndicate built at Portlath, a town built by the syndicate in Latah county, a lumber mill, supposed to be the largest in the United States, with a daily capacity of 750,000 ft. In Bonner county there are great mills at Sand Point and at Bonner's Ferry. In these and the other 93 saw-mills in the state in 1905 steam generated by the waste wood was the common power for the mills. The raw material for the production of sugar was secured from the 35,000 sq. m. of timber land in the state (6164 sq. m. having been reserved up to 1905, and 31,775.7 sq. m. up to April 1907 by the United States government); four-fifths of the cut in 1900 was yellow pine. Flour and grist mill products ranked second among the manufactures, being valued at \$1,584,473 in 1905, an increase of nearly 116% over the product in 1900; and steam-car construction and repairs ranked third, with a value of \$913,670 in 1905 and \$523,631 in 1900. In 1903-1904 the cultivation of sugar beets and the manufacture of beet sugar were undertaken, and manufacturing establishments for the purpose were installed at Idaho Falls and Blingham county, Blingham county at Sugar and Sugar City (Fremont county), a place built up about the sugar refineries, and at Nampa, Canyon county. In 1906 between 57,000,000 and 64,000,000 lb of beet sugar were refined in the state. Brick-making was of little more than local importance in 1906, the largest kilns being at Boise, Sand Point and Cœur d'Alene City. Lime is made at Orofino, Shoshone county, and at Hope, Bonner county.

Communications.—The total railway mileage in January 1909 was 2,092.04 m., an increase from 206 m. in 1880 and 946 m. in 1860. The Great Northern, the Northern Pacific, and the Oregon Railway

& Navigation lines cross the N. part of the state; the Oregon Short Line crosses the S., and the Union Pacific, which owns the Oregon Railway & Navigation and the Oregon Short Line roads, crosses the eastern part. The constitution declares that railways are public highways; that the legislature has authority to regulate rates, and that discrimination in tolls shall not be allowed.

**Population.**—The population of Idaho in 1870 was 14,999; in 1880 it was 32,610, an increase of 117.4%; in 1890 it was 88,548, an increase of 158.8%; in 1900 161,772 (82.7% increase); and in 1910 325,594 (101.3% increase). Of the inhabitants 15.2% were in 1900 foreign-born and 4.5% were coloured, the coloured population consisting of 293 negroes, 1291 Japanese, 1467 Chinese and 4226 Indians. The Indians lived principally in three reservations, the Fort Hall and Lemhi reservations (1,350 sq. m. and 100 sq. m. respectively), in S.E. and E. Idaho, being occupied by the Shoshone, Bannock and Sheep-eater tribes, and the Cœur d'Alene reservation (632 sq. m.), in the N.W., by the Cœur d'Alene and Spokane tribes. The former Nez Perce reservation, in the N.W. part of the state, was abolished in 1895, and the Nez Perces were put under the supervision of the superintendent of the Indian School at Fort Lapwai, about 12 m. E. of Lewiston, in Nez Perce county. Of these tribes, the Nez Perce and Cœur d'Alene were self-supporting; the other tribes were in 1900 dependent upon the United States government for 30% of their rations. Of the 24,604 foreign-born inhabitants of the state, 3943 were from England, 2074 were from Germany, 2528 were Canadian English, 2822 were from Sweden, and 1633 were from Ireland, various other countries being represented by smaller numbers. The urban population of Idaho in 1900 (*i.e.* the population of places having 4000 or more inhabitants) was 6.2% of the whole. There were thirty-three incorporated cities, towns and villages, but only five had a population exceeding 2000; these were Boise (5957), Pocatello (4046), Lewiston (2425), Moscow (2484) and Wallace (2265). In 1906 it was estimated that the total membership of all religious denominations was 74,578, and that there were 32,425 Latter-Day Saints or Mormons (266 of the Reorganized Church), 18,057 Roman Catholics, 5884 Methodist Episcopalians (5313 of the Northern Church), 3770 Presbyterians (3608 of the Northern Church), 3206 Disciples of Christ, and 2374 Baptists (2331 of the Northern Convention).

**Government.**—The present constitution of Idaho was adopted in 1889. The government is similar in outline to that of the other states of the United States. The executive officials serve for a term of two years. Besides being citizens of the United States and residents of the state for two years preceding their election the governor, lieutenant-governor and attorney-general must each be at least thirty years of age, and the secretary of state, state auditor, treasurer and superintendent of education must be at least twenty-five years old. The governor's veto may be overridden by a two-thirds vote of the legislature; the governor, secretary of state, and the attorney-general constitute a Board of Pardons and a Board of State Prison Commissioners. The legislature meets biennially; its members, who must be citizens of the United States and electors of the state for one year preceding their election, are chosen biennially; the number of senators may never exceed twenty-four, that of representatives sixty; each county is entitled to at least one representative. The judiciary consists of a supreme court of three judges, elected every six years, and circuit and probate courts, the five district judges being elected every four years. Suffrage requirements are citizenship in the United States, registration and residence in the state for six months and in the county for thirty days immediately before election, but mental deficiency, conviction of infamous crimes (without restoration to rights of citizenship), bribery or attempt at bribery, bigamy, living in "what is known as patriarchal plural or celestial marriage," or teaching its validity or belonging to any organization which teaches polygamy, are disqualifications. Chinese or persons of Mongolian

<sup>1</sup> This disqualification and much other legislation were due to the large Mormon population in Idaho. In 1884-1885 all county and precinct officers were required to take a test oath abjuring bigamy, polygamy, or celestial marriage; and under this law in 1888 three

descent not born in the United States are also excluded from suffrage rights. Women, however, since 1897, have had the right to vote and to hold office, and they are subject to jury service. An Australian ballot law was passed in 1891. The constitution forbids the chartering of corporations except according to general laws. In 1909 a direct primary elections law was passed which required a majority of all votes to nominate, and, to make a majority possible, provided for preferential (or second-choice) voting, such votes to be canvassed and added to the first-choice vote for each candidate if there be no majority by the first-choice vote. The right of eminent domain over all corporations is reserved to the state; and no corporation may issue stock except for labour, service rendered, or money paid in. The waters of the state are, by the constitution of the state, devoted to the public use, contrary to the common law theory of riparian rights. By statute (1891) it has been provided that in civil actions three-fourths of a jury may render a verdict, and in misdemeanour cases five-sixths may give a verdict. Life insurance agents not residents of Idaho cannot write policies in the state. Divorces may be obtained after residence of six months on the ground of adultery, cruelty, desertion or neglect for one year, habitual drunkenness for the same period, felony or insanity. There are a state penitentiary at Boise, an Industrial Training School at St Anthony, an Insane Asylum at Blackfoot, and a North Idaho Insane Asylum at Orofino. The care of all defectives was let by contract to other states until 1906, when a state school for the deaf and blind was opened in Boise. No bureau of charities is in existence, but there is a Labor Commission, and a Commissioner of Immigration and a Commissioner of Public Lands to investigate the industrial resources. The offices of State Engineer and Inspector of Mines have been created.

**Education.**—The public schools in 1905-1906 had an enrolment of 62,726, or 81.5% of the population between 5 and 21 years of age. The average length of school term was 6.8 months, the average expenditure (year ending Aug. 31, 1906) for instruction for each child was \$19.29, and the expenditure for all school purposes was \$1,008,481. There was a compulsory attendance law, which, however, was not enforced. Higher education is provided by the University of Idaho, established in 1892 at Moscow, Latah county, which confers degrees in arts, science, music and engineering, and offers free tuition. In 1907-1908 the institution had 41 instructors and 426 regular and 58 special students. In 1901 the Academy of Idaho, another state institution with industrial and technical courses and a preparatory department, was established at Pocatello, Bannock county, to be a connecting link between the public schools and the university. There are two state normal schools, one at Lewiston and the other at Albion. The only private institution of college grade in Idaho was the College of Caldwell (Presbyterian, opened 1891) at Caldwell, Canyon county, with 65 students in 1906-1907. There are Catholic academies at Boise and Cœur d'Alene and a convent, Our Lady of Lourdes, at Wallace, Shoshone county, opened in 1905; Mormon schools at Paris (Bear Lake county), Preston (Oceana county), Rexburg (Fremont county), and Oakley (Cassia county); a Methodist Episcopal school (1906) at Weiser (Washington county); and a Protestant Episcopal school at Boise (1892). The Idaho Industrial Institute (non-denominational; incorporated in 1899) is at Weiser.

**Finance.**—The finances of Idaho are in excellent condition. The bonded debt on the 30th of September 1908 was \$1,364,000. The revenue system is based on the general property tax and there is a State Board of Equalization. Each year \$100,000 is set aside for the sinking fund for the payment of outstanding bonds as fast as they become due. The constitution provides that the rate of taxation shall never exceed 10 mills for each dollar of assessed valuation, that when the taxable property amounts to \$50,000,000 the members of the territorial legislature were deprived of their seats as ineligible. An act of 1889, when the Mormons constituted over 20% of the population, forbade in the case of any who had since the 1st of January 1888 practised, taught, aided or encouraged polygamy or bigamy, their registration or voting until two years after they had taken a test oath renouncing such practices, and until they had satisfied the District Court that in the two years preceding they had been guilty of no such practices. The Constitutional Convention which met at Boise in July-August 1889 was strongly anti-Mormon, and the Constitution it framed was approved by a popular vote of 12,398 out of 14,184. The United States Supreme Court decided the anti-Mormon legislation case of Davis v. Beason in favour of the Idaho legislature. In 1893 the disqualification was made no longer retroactive, the two-year clause was omitted, and the test oath covered only present renunciation of polygamy.

rate shall not exceed 5 mills, when it reaches \$100,000,000, 3 mills shall be the limit, and when it reaches \$300,000,000 the rate shall not exceed 1½ mills; but a greater rate may be established by a vote of the people. No public debt (exclusive of the debt of the Territory of Idaho at the date of its admission to the Union as a state) may be created that exceeds 1½ % of the assessed valuation (except in case of war, &c.); the state cannot lend its credit to any corporation, municipality or individual; nor can any county, city or town lend its credit or become a stockholder in any company (except for municipal works).

**History.**—The first recorded exploration of Idaho by white men was made by Lewis and Clark, who passed along the Snake river to its junction with the Columbia; in 1805 the site of Fort Lemhi in Lemhi county was a rendezvous for two divisions of the Lewis and Clark expedition; later, the united divisions reached a village of the Nez Perce Indians near the south fork of the Clearwater river, where they found traces of visits by other white men. In 1810 Fort Henry, on the Snake river, was established by the Missouri Fur Company, and in the following year a party under the auspices of the Pacific Fur Company descended the Snake river to the Columbia. In 1834 Fort Hall in E. Idaho (Bingham county) was founded. It acquired prominence as the meeting-point of a number of trails to the extreme western parts of North America. Missions to the Indians were also established, both by the Catholics and by the Protestants. But the permanent settlements date from the revelation of Idaho's mineral resources in 1860, when the Cœur d'Alene, Palouses and Nez Perces were in the North, and the Blackfoots, Bannocks and Shoshones in the South. While trading with these Indians, Capt. Pierce learned in the summer of 1860 that there was gold in Idaho. He found it on Orofino Creek, and a great influx followed—especially to Orofino, Newsome, Elk City, Florence, where the ore was coming rich, and Warren. The news of the discovery of the Boisé Basin spread far and wide, and Idaho City, Placerville, Buena Vista, Centreville and Pioneer ville grew up. The territory now constituting Idaho was comprised in the Territory of Oregon from 1848 to 1853; from 1853 to 1859 the southern portion of the present state was a part of Oregon, the northern a part of Washington Territory; from 1859 to 1863 the territory was within the bounds of Washington Territory. In 1863 the Territory of Idaho was organized; it included Montana until 1864, and a part of Wyoming until 1868, when the area of the Territory of Idaho was practically the same as that of the present state. Idaho was admitted into the Union as a state in 1890. There have been a few serious Indian outbreaks in Idaho. In 1856 the Cœur d'Alenes, Palouses and Spokanes went on the war-path; in April 1857 they put to fight a small force under Col. Edward Jenner Steptoe; but the punitive expedition led by Col. George Wright (1803—1865) was a success. In 1877 the Nez Perces, led by Chief Joseph, refused to go on the reservation set apart for them, defeated a small body of regulars, were pursued by Major-General O. O. Howard, reinforced by frontier volunteers, and in September and October were defeated and retreated into Northern Montana, where they were captured by Major-General Nelson A. Miles. Occasional labour troubles have been very severe in the Cœur d'Alene region, where the attempt in 1892 of the Mine Owners' Association to discriminate in wages between miners and surfacemen brought on a union strike. Rioting followed the introduction of non-union men, the Frisco Mill was blown up, and many non-union miners were killed. The militia was called out and regular troops were hurried to Shoshone county from Fort Sherman, Idaho and Fort Missoula, Montana. These soon quieted the district. But the restlessness of the region caused more trouble in 1899. The famous Bunker Hill and Sullivan mines were wrecked, late in April, by union men. Federal troops, called for by Governor Frank Steunenberg, again took charge, and about 800 suspected men in the district were arrested and shut up in a stockade known as the "bull-pen." Ten prisoners, convicted of destroying the property of the mine-owners, were sentenced to twenty-two months in jail. The feeling among the union men was bitter against Steunenberg, who was assassinated on the 30th of

December 1905. The trial in 1907 of Charles H. Haywood, secretary of the Western Federation of Miners, who was charged with conspiracy in connexion with the murder, attracted national attention; it resulted in Haywood's acquittal. Before 1897 the administration of the state was controlled by the Republican party; but in 1896 Democrats, Populists and those Republicans who believed in free coinage of silver united, and until 1902 elected a majority of all candidates for state offices. In 1902, 1904, 1906 and 1908 a Republican state ticket was elected.

## GOVERNORS

## Territorial.

William H. Wallace	1863
W. B. Daniels, Secretary, Acting Governor	1863—1864
Caleb Lyon	1864—1865
C. de Witt Smith, Secretary, Acting Governor	1865
Horace C. Gilson	1865—1866
S. R. Howlett	1866
David W. Ballard	1866—1870
E. J. Curtis, Acting Governor	1870
Thomas W. Bennett	1871—1875
D. P. Thompson	1875—1876
Mason Brayman	1876—1880
John R. Neil	1880—1883
William M. Irwin	1883—1884
John M. Bunn	1884—1885
Edward A. Stevenson	1885—1889
George L. Shoup	1889—1890

## STATE GOVERNORS

George L. Shoup, <sup>1</sup> Republican	1890
Norman B. Wiley, Acting Governor	1890—1892
William J. McConnell, Republican	1893—1897
Frank Steunenberg, Democrat Populist	1897—1901
Frank W. Hunt,	1901—1903
John T. Morrison, Republican	1903—1905
Frank R. Gooding,	1905—1909
James H. Brady,	1909—

**BIBLIOGRAPHY.**—The physical features and economic resources of Idaho are discussed in J. L. Onderdonk's *Idaho: Facts and Statistics* (San Francisco, 1885), Israel C. Russell's "Geology and Water Resources of the Snake River Plains of Idaho," *U.S. Geological Survey, Bulletin 199* (Washington, 1902), *The State of Idaho* (a pamphlet issued by the State Commissioner of Immigration), Waldmor Lindgren's "Gold and Silver Veins of Silver City, De Lamar and other Mining Districts of Idaho," *U.S. Geological Survey, 20th Annual Report* (Washington, 1900), and "The Mining Districts of the Idaho Basin and the Boisé Ridge, Idaho," *U.S. Geological Survey, 18th Annual Report* (Washington, 1898). These reports should be supplemented by the information contained elsewhere in the publications of the Geological Survey (see the Indexes of the survey) and in various volumes of the United States Census. W. B. Hepburn's *Idaho Laws and Decisions, Annotated and Digested* (Boisé, 1909), and H. H. Bancroft's *Washington, Idaho, and Montana* (San Francisco, 1890) are the principal authorities for administration and history. The reports of the state's various executive officers should be consulted also.

**IDAR**, or EDAR, a native state of India, forming part of the Mahi Kantha agency, within the Gujarat division of Bombay. It has an area of 1669 sq. m., and a population (1901) of 168,557, showing a decrease of 44% in the decade as the result of famine. Estimated gross revenue, £20,000; tribute to the gaekwar of Baroda, £2000. In 1901 the raja and his posthumous son both died, and the succession devolved upon Sir Pertab Singh (*q.v.*) of Jodhpur. The line of railway from Ahmedabad through Parantj runs mainly through this state. Much of the territory is held by kinsmen of the raja on feudal tenure. The products are grain, oil-seeds and sugar-cane. The town of Idar is 64 m. N.E. of Ahmedabad. Pop. (1901) 7085. It was formerly the capital, but Ahmednagar (pop. 3200) is the present capital.

**IDAS**, in Greek legend, son of Aphareus of the royal house of Messene, brother of Lynceus. He is only mentioned in a single passage in Homer (*Iliad*, ix. 556 sqq.), where he is called the strongest of men on earth. He carried off Marpessa, daughter of Evenus, as his wife and dared to bend his bow against Apollo, who was also her suitor. Zeus intervened, and left the choice to Marpessa, who declared in favour of Idas, fearing that the god might desert her when she grew old (Apollodorus i. 7). The Apharetidæ are best known for their fight with the Dioscuri.

<sup>1</sup> Governor Shoup resigned in December to take his seat in the U.S. Senate.

A quarrel had arisen about the division of a herd of cattle which the four had stolen. Idas claimed the whole of the booty as the victor in a contest of eating, and drove the cattle off to Messene. The Dioscuri overtook him and lay in wait in a hollow oak. But Lynceus, whose keenness of sight was proverbial, saw Castor through the trunk and warned his brother, who thereupon slew the mortal Castor; finally, Pollux slew Lynceus, and Idas was struck by lightning (Apollodorus iii. 11; Pindar, *Nem.*, x. 60; Pausanias iv. 3. 1). According to others, the Dioscuri had carried off the daughters of Leucippus, who had been betrothed to the Apharetidae (Ovid, *Fasts.*, v. 699; Theocritus xxii. 137). The scene of the combat is placed near the grave of Aphareus at Messene, at Aphidna in Attica, or in Laconia; and there are other variations of detail in the accounts (see also Hyginus, *Fab.* 80). Idas and Lynceus were originally gods of light, probably the sun and moon, the herd of cattle (for the possession of which they strove with the Dioscuri) representing the heavenly bodies. The annihilation of the Apharetidae in the legend indicates the subordinate position held by the Messenians after the loss of their independence and subjugation by Sparta, the Dioscuri being distinctly Spartan, as the Apharetidae were Messenian heroes. The grave of Idas and Lynceus was shown at Sparta, according to Pausanias (iii. 13. 1), whose own opinion, however, is that they were buried in Messenia. On the chest of Cypselus, Marpessa is represented as following Idas from the temple of Apollo (by whom, according to some, she had been carried off), and there was a painting by Polygnotus of the rape of the Leucippidae in the temple of the Dioscuri at Athens.

In the article GREEK ART, fig. 66 (Pl. iv.) represents Idas and the Dioscuri driving off cattle.

**IDDESLEIGH, STAFFORD HENRY NORTHCOTE**, 1ST EARL OF (1818-1887), British statesman, was born in London, on the 27th of October 1818. His ancestors had long been settled in Devonshire, their pedigree, according to Burke, being traceable to the beginning of the 12th century. After a successful career at Balliol College, Oxford, he became in 1843 private secretary to Mr Gladstone at the board of trade. He was afterwards legal secretary to the board; and after acting as one of the secretaries to the Great Exhibition of 1851, co-operated with Sir Charles Trevelyan in framing the report which revolutionized the conditions of appointment to the Civil Service. He succeeded his grandfather, Sir Stafford Henry Northcote, as 8th baronet in 1851. He entered Parliament in 1855 as Conservative M.P. for Dudley, and was elected for Stamford in 1858, a seat which he exchanged in 1866 for North Devon. Steadily supporting his party, he became president of the board of trade in 1866, secretary of state for India in 1867, and chancellor of the exchequer in 1874. In the interval between these last two appointments he had been one of the commissioners for the settlement of the "Alabama" difficulty with the United States, and on Mr Disraeli's elevation to the House of Lords in 1876 he became leader of the Conservative party in the Commons. As a finance minister he was largely dominated by the lines of policy laid down by Mr Gladstone; but he distinguished himself by his dealings with the Debt, especially his introduction of the New Sinking Fund (1876), by which he fixed the annual charge for the Debt in such a way as to provide for a regular series of payments off the capital. His temper as leader was, however, too gentle to satisfy the more ardent spirits among his own followers, and party cabals (in which Lord Randolph Churchill—who had made a dead set at the "old gang," and especially Sir Stafford Northcote—took a leading part) led to Sir Stafford's transfer to the Lords in 1885, when Lord Salisbury became prime minister. Taking the titles of earl of Idesleigh and Viscount St Cyres, he was included in the cabinet as first lord of the treasury. In Lord Salisbury's 1886 ministry he became secretary of state for foreign affairs, but the arrangement was not a comfortable one, and his resignation had just been decided upon when on the 12th of January 1887 he died very suddenly at Lord Salisbury's official residence in Downing Street. Lord Idesleigh was elected lord rector of Edinburgh

University in 1883, in which capacity he addressed the students on the subject of "Desultory Reading." He had little leisure for letters, but amongst his works were *Twenty Years of Financial Policy* (1862), a valuable study of Gladstonian finance, and *Lectures and Essays* (1887). His *Life* by Andrew Lang appeared in 1890. Lord Idesleigh married in 1843 Cecilia Frances Farrer (d. 1910) (sister of Thomas, 1st Lord Farrer), by whom he had seven sons and three daughters.

He was succeeded as 2nd earl by his eldest son, WALTER STAFFORD NORTHCOTE (1845- ), who for some years was his father's private secretary. He was chairman of the Inland Revenue Board from 1877 to 1892; and is also known as a novelist. His eldest son STAFFORD HENRY NORTHCOTE, Viscount St Cyres (1869- ), was educated at Eton and Merton College Oxford. After taking a 1st class in History, he was elected a senior student of Christ Church, where he resided for a while as tutor and lecturer. His interest in the development of religious thought led him to devote himself specially to the history of the Roman Catholic Church in the 17th century, the first-fruits of which was his *François de Fénelon* (London, 1901); eight years later he published his *Pascal* (ib. 1909).

The second son of the 1st earl of Idesleigh, STAFFORD HENRY NORTHCOTE, 1st Baron Northcote (b. 1846), was educated at Eton and at Merton College, Oxford. He became a clerk in the foreign office in 1868, acted as private secretary to Lord Salisbury, and was attached to the embassy at Constantinople from 1876 to 1877. From 1877 to 1880 he was secretary to the chancellor of the exchequer, was financial secretary to the war office from 1885 to 1886, surveyor-general of ordnance, 1886 to 1887, and charity commissioner, 1891 to 1892. In 1887 he was created a baronet. In 1880 he was elected M.P. for Exeter as a Conservative, and retained the seat until 1899, when he was appointed governor of Bombay (1899-1903), being created a peer in 1900. Lord Northcote was appointed governor-general of the Commonwealth of Australia in 1903, and held this post till 1908. He married in 1873 Alice, adopted daughter of the 1st Lord Mount Stephen.

**IDEA** (Gr. *ἰδέα*, connected with *ἰδεῖν*, to see; cf. Lat. *species* from *specere*, to look at), a term used both popularly and in philosophical terminology with the general sense of "mental picture." To have no *idea* how a thing happened is to be without a mental picture of an occurrence. In this general sense it is synonymous with concept (*q.v.*) in its popular usage. In philosophy the term "idea" is common to all languages and periods, but there is scarcely any term which has been used with so many different shades of meaning. Plato used it in the sphere of metaphysics for the eternally existing reality, the archetype, of which the objects of sense are more or less imperfect copies. Chairs may be of different forms, sizes, colours and so forth, but "laid up in the mind of God" there is the one permanent *idea* or type, of which the many physical chairs are derived with various degrees of imperfection. From this doctrine it follows that these *ideas* are the sole reality (see further IDEALISM); in opposition to it are the empirical thinkers of all time who find reality in particular physical objects (see HYLOZOISM, EMPIRICISM, &c.). In striking contrast to Plato's use is that of John Locke, who defines "idea" as "whatever is the object of understanding when a man thinks" (*Essay on the Human Understanding* (I.), vi. 8). Here the term is applied not to the mental process, but to anything whether physical or intellectual which is the object of it. Hume differs from Locke by limiting "idea" to the more or less vague mental reconstructions of perceptions, the perceptual process being described as an "impression." Wundt widens the term to include "conscious representation of some object or process of the external world." In so doing he includes not only ideas of memory and imagination, but also perceptual processes, whereas other psychologists confine the term to the first two groups. G. F. Stout and J. M. Baldwin, in the *Dictionary of Philosophy and Psychology*, i. 498, define "idea" as "the reproduction with a more or less adequate image, of an object not actually present to the senses." They point out that an *idea*

and a perception are by various authorities contrasted in various ways. "Difference in degree of intensity," "comparative absence of bodily movement on the part of the subject," "comparative dependence on mental activity," are suggested by psychologists as characteristic of an idea as compared with a perception.

It should be observed that an idea, in the narrower and generally accepted sense of a mental reproduction, is frequently composite. That is, as in the example given above of the idea of chair, a great many objects, differing materially in detail, all call a single idea. When a man, for example, has obtained an idea of chairs in general by comparison with which he can say "This is a chair, that is a stool," he has what is known as an "abstract idea" distinct from the reproduction in his mind of any particular chair (see ABSTRACTION). Furthermore a complex idea may not have any corresponding physical object, though its particular constituent elements may severally be the reproductions of actual perceptions. Thus the idea of a centaur is a complex mental picture composed of the ideas of man and horse, that of a mermaid of a woman and a fish.

See PSYCHOLOGY.

**IDEALISM** (from Gr. *idea*, archetype or model, through Fr. *idéisme*), a term generally used for the attitude of mind which is prone to represent things in an imaginative light and to lay emphasis exclusively or primarily on abstract perfection (i.e. in "ideals"). With this meaning the philosophical use of the term has little in common.

To understand the philosophical theory that has come to be known under this title, we may ask (1) what in general it is and how it is differentiated from other theories of knowledge and reality, (2) how it has risen in the history of philosophy, (3) what position it occupies at present in the world of speculation.

1. *General Definition of Idealism.*—Idealism as a philosophical doctrine conceives of knowledge or experience as a process in which the two factors of subject and object stand in a relation of entire interdependence on each other as warp and woof. Apart from the activity of the self or subject in sensory reaction, memory and association, imagination, judgment and inference, there can be no world of objects. A thing-in-itself which is not a thing to some consciousness is an entirely unrealizable, because self-contradictory, conception. But this is only one side of the truth. It is equally true that a subject apart from an object is unintelligible. As the object exists through the constructive activity of the subject, so the subject lives in the construction of the object. To seek for the true self in any region into which its opposite in the form of a not-self does not enter is to grasp a shadow. It is in seeking to realize its own ideas in the world of knowledge, feeling and action that the mind comes into possession of itself; it is in becoming permeated and transformed by the mind's ideas that the world develops the fullness of its reality as object.

Thus defined, idealism is opposed to ordinary common-sense dualism, which regards knowledge or experience as the result of the more or less accidental relation between two separate and independent entities—the mind and its ideas on one side, the thing with its attributes on the other—that serve to limit and condition each other from without. It is equally opposed to the doctrine which represents the subject itself and its state and judgments as the single immediate datum of consciousness, and all else, whether the objects of an external world or person other than the individual subject whose states are known to itself, as having a merely problematic existence resting upon analogy or other process of indirect inference. This theory is sometimes known as idealism. But it falls short of idealism as above defined in that it recognizes only one side of the antithesis of subject and object, and so falls short of the doctrine which takes its stand on the complete correlativity of the two factors in experience. It is for this reason that it is sometimes known as subjective or incomplete idealism. Finally the theory defined is opposed to all forms of realism, whether in the older form which sought to reduce mind to a function of matter,

or in any of the newer forms which seek for the ultimate essence of both mind and matter in some unknown force or energy which, while in itself it is neither, yet contains the potentiality of both. It is true that in some modern developments of idealism the ultimate reality is conceived of in an impersonal way, but it is usually added that this ultimate or absolute being is not something lower but higher than self-conscious personality, including it as a more fully developed form may be said to include a more elementary.

2. *Origin and Development of Idealism.*—In its self-conscious form idealism is a modern doctrine. In it the self or subject may be said to have come to its rights. This was possible in any complete sense only after the introspective movement represented by the middle ages had done its work, and the thought of the individual mind and will as possessed of relative independence had worked itself out into some degree of clearness. In this respect Descartes' dictum—*cogito ergo sum*—may be said to have struck the keynote of modern philosophy, and all subsequent speculation to have been merely a prolonged commentary upon it. While in its completer form it is thus a doctrine distinctive of modern times, idealism has its roots far back in the history of thought. One of the chief proofs that has been urged of the truth of its point of view is the persistency with which it has always asserted itself at a certain stage in philosophical reflection and as the solution of certain recurrent speculative difficulties. All thought starts from the ordinary dualism or pluralism which conceives of the world as consisting of the juxtaposition of mutually independent things and persons. The first movement is in the direction of dispelling this appearance of independence. They are seen to be united under the relation of cause and effect, determining and determined, which turns out to mean that they are merely passing manifestations of some single entity or energy which constitutes the real unknown essence of the things that come before our knowledge. In the pantheism that thus takes the place of the old dualism there seems no place left for the individual. Mind and will in their individual manifestations fade into the general background of appearance without significance except as a link in a fated chain. Deliverance from the pantheistic conception of the universe comes through the recognition of the central place occupied by thought and purpose in the actual world, and, as a consequence of this, of the illegitimacy of the abstraction whereby material energy is taken for the ultimate reality.

The first illustration of this movement on a large scale was given in the Socratic reaction against the pantheistic conclusions of early Greek philosophy (see IONIAN SCHOOL). The whole movement of which Socrates was a part may be said to have been in the direction of the assertion of the rights of the subject. Its keynote is to be found in the Protagorean "man is the measure." This seems to have been interpreted by its author and by the Sophists in general in a subjective sense, with the result that it became the motto of a sceptical and individualistic movement in contemporary philosophy and ethics. It was not less against this form of idealism than against the determinism of the early physicists that Socrates protested. Along two lines the thought of Socrates led to idealistic conclusions which may be said to have formed the basis of all subsequent advance. (1) He perceived the importance of the universal or conceptual element in knowledge, and thus at a single stroke broke through the hard realism of ordinary common sense, disproved all forms of naturalism that were founded on the denial of the reality of thought, and cut away the ground from a merely sensational and subjective idealism. This is what Aristotle means by claiming for Socrates that he was the founder of definition. (2) He taught that life was explicable only as a system of ends. Goodness consists in the knowledge of what these are. It is by his hold upon them that the individual is able to give unity and reality to his will. In expounding these ideas Socrates limited himself to the sphere of practice. Moreover, the end or ideal of the practical life was conceived of in too vague a way to be of much practical use. His principle, however, was essentially sound, and led directly

**Ancient  
idealism:  
Socrates.**

to the Platonic Idealism. Plato extended the Socratic discovery to the whole of reality and while seeking to see the pre-Socratics with the eyes of the Socratics sought "to see Socrates with the eyes of the pre-Socratics." Not only were the virtues

**Plato.** to be explained by their relation to a common or universal good which only intelligence could apprehend, but there was nothing in all the furniture of heaven or earth which in like manner did not receive reality from the share it had in such an intelligible idea or essence. But these ideas are themselves intelligible only in relation to one another and to the whole. Accordingly Plato conceived of them as forming a system and finding their reality in the degree in which they embody the one all-embracing idea and conceived of not under the form of an efficient but of a final cause, an inner principle of action or tendency in things to realize the fullness of their own nature which in the last resort was identical with the nature of the whole. This Plato expressed in the myth of the Sun, but the garment of mythology in which Plato clothed his idealism, beautiful as it is in itself and full of suggestion, covered an essential weakness. The more Plato dwelt upon his world of ideas, the more they seemed to recede from the world of reality, standing over against it as principles of condemnation instead of revealing themselves in it. In this way the Good was made to appear as an end imposed upon things from without by a creative intelligence instead of as an inner principle of adaptation.

On one side of his thought Aristotle represents a reaction against idealism and a return to the position of common-sense dualism, but on another, and this the deeper side, he represents the attempt to restore the theory in a more satisfactory form. His account of the process of knowledge in his logical treatises exhibits the idealistic bent in its clearest form. This is as far removed as possible either from dualism or from empiricism. The universal is the real; it is that which gives coherence and individuality to the particulars of sense which apart from it are like the routed or disbanded units of an army. Still more manifestly in his *Ethics* and *Politics* Aristotle makes it clear that it is the common or universal which gives substance and reality to the individual. In spite of these and other anticipations of a fuller idealism, the idea remains as a form imposed from without on a reality otherwise conceived of as independent of it. As we advance from the logic to the metaphysics and from that to his ontology, it becomes clear that the concepts are only "categories" or predicates of a reality lying outside of them, and there is an ultimate division between the world as the object or matter of thought and the thinking or moving principle which gives its life. It is this that gives the Aristotelian doctrine in its more abstract statements an air of uncertainty. Yet besides the particular contribution that Aristotle made to idealistic philosophy in his logical and ethical interpretations, he advanced the case in two directions. (a) He made it clear that no explanation of the world could be satisfactory that was not based on the notion of continuity in the sense of an order of existence in which the reality of the lower was to be sought for in the extent to which it gave expression to the potentialities of its own nature—which were also the potentialities of the whole of which it was a part. (b) From this it followed that difficult as we might find it to explain the relation of terms so remote from each other as sense and thought, the particular and the universal, matter and mind, these oppositions cannot in their nature be absolute. These truths, however, were hidden from Aristotle's successors, who for the most part lost the thread which Socrates had put into their hand. When the authority of Aristotle was again invoked, it was its dualistic and formal, not its idealistic and metaphysical, side that was in harmony with the spirit of the age. Apart from one or two of the greatest minds, notably Dante, what appealed to the thinkers of the middle ages was not the idea of reality as a progressive self-revelation of an inner principle working through nature and human life, but the formal principles of classification which it seemed to offer for a material of thought and action given from another source.

Modern like ancient idealism came into being as a correction

of the view that threatened to resolve the world of matter and mind alike into the changing manifestations of some single non-spiritual force or substance. While, **Modern Idealism.** however, ancient philosophy may be said to have been unilinear, modern philosophy had a twofold origin, and till the time of Kant may be said to have pursued two independent courses.

All philosophy is the search for reality and rational certainty as opposed to mere formalism on the one hand, to authority and dogmatism on the other. In this sense modern philosophy had a common root in revolt against medievalism. In England this revolt sought for the certainty and clearness that reason requires in the assurance of an outer world given to immediate sense experience; on the continent of Europe, in the assurance of an inner world given immediately in thought. Though starting from apparently opposite poles and following widely different courses the two movements led more or less directly to the same results. It is easy to understand how English empiricism issued at once in the trenchant naturalism of Hobbes. It is less comprehensible how the Cartesian philosophy from the starting-point of thought allied itself with a similar point of view. This can be understood only by a study of the details of Descartes' philosophy (see **CARTESIANISM**). Suffice it to say that in spite of its spiritualistic starting-point its general result was to give a stimulus to the prevailing scientific tendency as represented by Galileo, Kepler and Harvey to the principle of mechanical explanations of the phenomena of the universe. True it was precisely against this that Descartes' immediate successors struggled. But the time-spirit was too strong for them. Determinism had other forms besides that of a crude materialism, and the direction that Malebranche succeeded in giving to speculation led only to the more complete denial of freedom and individuality in the all-devouring pantheism of Spinoza.

The foundations of idealism in the modern sense were laid by the thinkers who sought breathing room for mind and will in a deeper analysis of the relations of the subject to **Berkeley.** the world that it knows. From the outset English philosophy had a leaning to the psychological point of view, and Locke was only carrying on the tradition of his predecessors and particularly of Hobbes in definitely accepting it as the basis of his *Essay*. It was, however, Berkeley who first sought to utilize the conclusions that were implicit in Locke's starting-point to disprove "the systems of impious and profane persons which exclude all freedom, intelligence, and design from the formation of things, and instead thereof make a self-existent, stupid, unthinking substance the root and origin of all beings." Berkeley's statement of the view that all knowledge is relative to the subject—that no object can be known except under the form which our powers of sense-perception, our memory and imagination, our notions and inference, give it—is still the most striking and convincing that we possess. To have established this position was a great step in speculation. Henceforth ordinary dogmatic dualism was excluded from philosophy; any attempt to revive it, whether with Dr Johnson by an appeal to common prejudice, or in the more reflective Johnsonianism of the 18th-century Scottish philosophers, must be an anachronism. Equally impossible was it thenceforth to assert the mediate or immediate certainty of material substance as the cause either of events in nature or of sensations in ourselves. But with these advances came the danger of falling into error from which common-sense dualism and naturalistic monism were free. From the point of view which Berkeley had inherited from Locke it seemed to follow that not only material substance, but the whole conception of a world of objects, is at most an inference from subjective modifications which are the only immediately certain objects of knowledge. The implications of such a view were first clearly apparent when Hume showed that on the basis of it there seemed to be nothing that we could confidently affirm except the order of our own impressions and ideas. This being so, not only were physics and mathematics impossible as sciences of necessary

objective truth, but our apparent consciousness of a permanent self and object alike must be delusive.

It was these paradoxes that Kant sought to rebut by a more thoroughgoing criticism of the basis of knowledge the substance of which is summed up in his celebrated Refutation of Idealism,<sup>1</sup> wherein he sought to undermine Hume's scepticism by carrying it one step further and demonstrating that not only is all knowledge of self or object excluded, but the consciousness of any series of impressions and ideas is itself impossible except in relation to some external permanent and universally accepted world of objects.

But Kant's refutation of subjective idealism and his vindication of the place of the object can be fully understood only

when we take into account the other defect in the teaching of his predecessors that he sought in his *Critique* to correct. In continental philosophy the reaction against mechanical and pantheistic explanations of the universe found even more definite utterance than in English psychological empiricism in the metaphysical system of Leibnitz, whose theory of self-determined monads can be understood only when taken in the light of the assertion of the rights of the subject against the substance of Spinoza and the atoms of the materialist. But Leibnitz also anticipated Kant in seeking to correct the empirical point of view of the English philosophers. True, sense-given material is necessary in order that we may have thought. "But by what means," he asks, "can experience and the senses give ideas? Has the soul windows? Is it like a writing tablet? Is it like wax? It is plain that all those who think thus of the soul make it at bottom corporeal. True, nothing is in the intellect which has not been in the senses, but we must add except the intellect itself. The soul contains the notions of being, substance, unity, identity, cause, perception, reasoning and many other things the senses cannot give" (*Nouveaux essais*, ii. 1). But Leibnitz's conception of the priority of spirit had too little foundation, and the different elements he sought to combine were too loosely related to one another to stand the strain of the two forces of empiricism and materialism that were opposed to his idealism. More particularly by the confusion in which he left the relation between the two logical principles of identity and of sufficient reason underlying respectively analytic and synthetic, deductive and inductive thought, he may be said to have undermined in another way the idealism he strove to establish. It was in seeking to close up the fissure in his system represented by this dualism that his successors succeeded only in adding weakness to weakness by reducing the principle of sufficient reason to that of formal identity (see WOLFF) and representing all thought as in essence analytic. From this it immediately followed that, so far as the connexion of our experiences of the external world does not show itself irreducible to that of formal identity, it must remain unintelligible. As empiricism had foundered on the difficulty of showing how our thoughts could be an object of sense experience, so Leibnitzian formalism foundered on that of understanding how the material of sense could be an object of thought. On one view as on the other scientific demonstration was impossible.

The extremity to which philosophy had been brought by empiricism on the one hand and formalism on the other was

Kant. Kant's opportunity. Leibnitz's principle of the "nisi intellectus ipse" was expanded by him into a demonstration the completest yet effected by philosophy of the part played by the subject not merely in the manipulation of the material of experience but in the actual constitution of the object that is known. On the other hand he insisted on the synthetic character of this activity without which it was impossible to get beyond the circle of our own thoughts. The parts of the *Critique of Pure Reason*, more particularly the "Deduction of the Categories" in which this theory is worked out, may be said to have laid the foundation of modern idealism—"articulum stantis aut cadentis doctrinae." In spite of the defects of Kant's statement—to which it is necessary to return—the place of the concepts and ideals of the mind and the synthetic organizing

activity which these involve was established with a trenchancy which has been acknowledged by all schools alike. The "Copernican revolution" which he claimed to have effected may be said to have become the starting-point of all modern philosophy. Yet the divergent uses that have been made of it witness to the ambiguity of his statement which is traceable to the fact that Kant was himself too deeply rooted in the thought of his predecessors and carried with him too much of their spirit to be able entirely to free himself from their assumptions and abstractions. His philosophy was more like Michaelangelo's famous sculpture of the Dawn, a spirit yet encumbered with the stubble of the material from which it was hewn, than a clear cut figure with unmistakable outlines. Chief among these encumbering presuppositions was that of a fundamental distinction between perception and conception and consequent upon it between the synthetic and the analytic use of thought. It is upon this in the last resort that the distinction between the phenomenal world of our experience and a noumenal world beyond it is founded. Kant perceives that "perception without conception is blind, conception without perception is empty," but if he goes so far ought he not to have gone still further and inquired whether there can be any perception at all without a concept, any concept which does not presuppose a precept, and, if this is impossible, whether the distinction between a world of appearance which is known and a world of things-in-themselves which is not, is not illusory?

It was by asking precisely these questions that Hegel gave the finishing strokes to the Kantian philosophy. The starting-point of all valid philosophy must be the perception that the essence of all conscious apprehension is the *Hegel* union of opposites—of which that of subject and object is the most fundamental and all-pervasive. True, before differences can be united they must have been separated, but this merely proves that differentiation or analysis is only one factor in a single process. Equally fundamental is the element of synthesis. Nor is it possible at any point in knowledge to prove the existence of a merely given in whose construction the thinking subject has played no part nor a merely thinking subject in whose structure the object is not an organic factor. In coming, as at a certain point in its development it does, to the consciousness of an object, the mind does not find itself in the presence of an opponent, or of anything essentially alien to itself but of that which gives content and stability to its own existence. True, the stability it seems to find in it is incomplete. The object cannot rest in the form of its immediate appearance without involving us in contradiction. The sun does not "rise," the dew does not "fall." But this only means that the unity between subject and object to which the gift of consciousness commits us is incompletely realized in that appearance: the apparent truth has to submit to correction and supplementation before it can be accepted as real truth. It does not mean that there is anywhere a mere fact which is not also an interpretation nor an interpreting mind whose ideas have no hold upon fact. From this it follows that ultimate or absolute reality is to be sought not beyond the region of experience, but in the fullest and most harmonious statement of the facts of our experience. True a completely harmonious world whether of theory or of practice remains an ideal. But the fact that we have already in part realized the ideal and that the degree in which we have realized it is the degree in which we may regard our experience as trustworthy, is proof that the ideal is no mere idea as Kant taught, but the very substance of reality.

Intelligible as this development of Kantian idealism seems in the light of subsequent philosophy, the first statement of it in Hegel was not free from obscurity. The unity of opposites translated into its most abstract terms as the "identity of being and not-being," the principle that the "real is the rational," the apparent substitution of "bloodless" categories for the substance of concrete reality gave it an air of paradox in the eyes of metaphysicians while physicists were scandalized by the premature attempts at a complete philosophy of nature and

Stumbling blocks in Hegelian statements.

<sup>1</sup> *Kritik d. reinen Vernunft*, p. 197 (ed. Hartenstein).



history. For this Hegel was doubtless partly to blame. But philosophical critics of his own and a later day are not hereby absolved from a certain perversity in interpreting these doctrines in a sense precisely opposite to that in which they were intended. The doctrine of the unity of contraries so far from being the denial of the law of non-contradiction is founded on an absolute reliance upon it. Freed from paradox it means that in every object of thought there are different aspects or elements each of which if brought separately into consciousness may be so emphasized as to appear to contradict another. Unity may be made to contradict diversity, permanence change, the particular the universal, individuality relatedness. Ordinary consciousness ignores these "latent fires"; ordinary discussion brings them to light and divides men into factions and parties over them; philosophy not because it denies but because it acknowledges the law of non-contradiction as supreme is pledged to seek a point of view from which they may be seen to be in essential harmony with one another as different sides of the same truth. The "rationality of the real" has in like manner been interpreted as intended to sanctify the existing order. Hegel undoubtedly meant to affirm that the actual was rational in the face of the philosophy which set up subjective feeling and reason against it. But idealism has insisted from the time of Plato on the distinction between what is actual in time and space and the reality that can only partially be revealed in it. Hegel carried this principle further than had yet been done. His phrase does not therefore sanctify the established fact but, on the contrary, declares that it partakes of reality only so far as it embodies the ideal of a coherent and stable system which it is not. As little is idealism responsible for any attempt to pass off logical abstractions for concrete reality. The "Logic" of Hegel is merely the continuation of Kant's "Deduction" of the categories and ideas of the reason which has generally been recognized as the soberest of attempts to set forth the presuppositions which underlie all experience. "What Hegel attempts to show is just that the categories by which thought must determine its object are stages in a process that, beginning with the idea of 'Being,' the simplest of all determinations is driven on by its own dialectic till it reaches the idea of self-consciousness. In other words the intelligence when it once begins to define an object for itself, finds itself launched on a movement of self-asserting synthesis in which it cannot stop until it had recognized that the unity of the object with itself involves its unity with all other objects and with the mind that knows it. Hence, whatever we begin by saying, we must ultimately say 'mind'" (Caird, *Kant*, i. 443).

While the form in which these doctrines were stated proved fatal to them in the country of their birth, they took deep root in the next generation in English philosophy. Here the stone that the builders rejected was made the head of the corner. The influences which led to this result were manifold. From the side of literature the way was prepared for it by the genius of Coleridge, Wordsworth and Carlyle; from the side of morals and politics by the profound discontent of the constructive spirit of the century with the disintegrating conceptions inherited from utilitarianism. In talking root in England idealism had to contend against the traditional empiricism represented by Mill on the one hand and the pseudo-Kantianism which was rendered current by Mansel and Hamilton on the other. As contrasted with the first it stood for the necessity of recognizing a universal or ideal element as a constitutive factor in all experience whether cognitive or volitional; as contrasted with the latter for the ultimate unity of subject and object, knowledge and reality, and therefore for the denial of the existence of any thing-in-itself for ever outside the range of experience. Its polemic against the philosophy of experience has exposed it to general misunderstanding, as though it claimed some a priori path to truth. In reality it stands for a more thoroughgoing and consistent application of the test of experience. The defect of English empiricism from the outset had been the uncritical acceptance of the metaphysical dogma of a pure unadmitted sense-experience as the criterion of truth. This assumption idealism examines and rejects in the name of experience itself. Similarly it only carried the doctrine of relativity to its logical conclusion in denying that there could be any absolute relativity. Object stands in essentially relation to subject, subject to object. This being so, it is wholly illogical to seek for any test of the truth and reality of either except in the form which that relation itself takes. In its subsequent development idealism in England has passed through several clearly marked stages which may be

distinguished as (a) that of exploration and tentative exposition in the writings of J. F. Ferrier,<sup>1</sup> J. Hutchison Stirling,<sup>2</sup> Benjamin Jowett,<sup>3</sup> W. T. Harris;<sup>4</sup> (b) of confident application to the central problems of logic, ethics and politics, fine art and religion, and as a principle of constructive criticism and interpretation chiefly in T. H. Green,<sup>5</sup> E. Caird,<sup>6</sup> B. Bosanquet;<sup>7</sup> (c) of vigorous effort to develop on fresh lines its underlying metaphysics in F. H. Bradley,<sup>8</sup> M. E. McGaughey,<sup>9</sup> A. E. Taylor,<sup>10</sup> Josiah Royce,<sup>11</sup> and others; (d) under the influence of these writers idealism, as above expounded, though with difference of interpretation in individual writers, may be said towards the end of the 19th century to have been on its way to becoming the leading philosophy in the British Isles and America.

3. *Reaction against Traditional Idealism.*—But it was not to be expected that the position idealism had thus won for itself would remain long unchallenged. It had its roots in the literature and in forms of thought remote from the common track; it had been formulated before the great advances in psychology which marked the course of the century; its latest word seemed to involve consequences that brought it into conflict with the vital interest the human mind has in freedom and the possibility of real initiation. It is not, therefore, surprising that there should have been a vigorous reaction. This has taken mainly two opposite forms. On the one hand the attack has come from the old ground of the danger that is threatened to the reality of the external world and may be said to be in the interest of the object. On the other hand the theory has been attacked in the interest of the subject on the ground that in the statuesque world of ideas into which it introduces us it leaves no room for the element of movement and process which recent psychology and metaphysics alike have taught us underlies all life. The conflict of idealism with these two lines of criticism—the accusation of subjectivism on the one side of intellectualism and rigid objectivism on the other—may be said to have constituted the history of Anglo-Saxon philosophy during the first decade of the 20th century.

I. Whatever is to be said of ancient Idealism, the modern doctrine may be said notably in Kant to have been in the main a vindication of the subjective factor in knowledge. But that space and time, matter and cause should owe their origin to the action of the mind has always seemed paradoxical to common sense. Nor is the impression which its enunciation in Kant made, likely to have been lightened in this country by the connexion that was sure to be traced between Berkeleyanism and the new teaching or by the form which the doctrine received at the hands of T. H. Green, its leading English representative between 1870 and 1880. If what is real in things is ultimately nothing but their relations, and if relations are inconceivable apart from the relating mind, what is this but the dissolution of the solid ground of external reality which my consciousness seems to assure me underlies and eludes all the conceptual network by which I try to bring one part of my experience into connexion with another? It is quite true that modern idealists like Berkeley himself have sought to save themselves from the gulf of subjectivism by calling in the aid of a universal or infinite mind or by an appeal to a total or absolute experience to which our own is relative. But the former device is too obviously a *deus ex machina*, the purpose of which would be equally well served by supposing with Fichte the individual self to be endowed with the power of subconsciously extruding a world which returns to it in consciousness under the form of a foreign creation. The appeal to an Absolute on the other hand is only to substitute one difficulty for another. For granting that it places the centre of reality outside the individual self it does so only at the price of reducing the reality of the latter to an appearance;

<sup>1</sup> *Institutes of Metaphysics* (1854); *Works* (1866).

<sup>2</sup> *Secret of Hegel* (1865).

<sup>3</sup> *Dialogues of Plato* (1871).

<sup>4</sup> *Journal of Spec. Phil.* (1867).

<sup>5</sup> *Hume's Phil. Works* (1875).

<sup>6</sup> *Critical account of the Phil. of Kant* (1877).

<sup>7</sup> *Knowledge and Reality* (1885); *Logic* (1888).

<sup>8</sup> *Appearance and Reality* (1903).

<sup>9</sup> *Studies in Hegelian Cosmology* (1901).

<sup>10</sup> *Elements of Metaphysics* (1903).

<sup>11</sup> *The World and the Individual* (1901).

and if only one thing is real what becomes of the many different things which again my consciousness assures me are the one world with which I can have any practical concern? To meet these difficulties and give back to us the assurance of the substantiality of the world without us it has therefore been thought necessary to maintain two propositions which are taken to be the refutation of idealism. (1) There is given to us immediately in knowledge a world entirely independent of and different from our own impressions on the one hand and the conceptions by which we seek to establish relations between them upon the other. The relation of these impressions (and for the matter of that of their inter-relations among themselves) to our minds is only one of them. As a leading writer puts it: "There is such a thing as greenness having various relations, among others that of being perceived."<sup>1</sup> (2) Things may be, and may be known to be simply different. They may exclude one another, exist so to speak in a condition of armed neutrality to one another, without being positively thereby related to one another or altered by any change taking place in any of them. As the same writer puts it: "There is such a thing as numerical difference, different from conceptual difference,"<sup>2</sup> or expressing the same thing in other words "there are relations not grounded in the nature of the related terms."

In this double-barrelled criticism it is important to distinguish what is really relevant. Whatever the shortcomings of individual writers may be, modern idealism differs, as we have seen, from the arrested idealism of Berkeley precisely in the point on which dualism insists. In all knowledge we are in touch not merely with the self and its passing states, but with a real object which is different from them. On this head there is no difference, and idealism need have no difficulty in accepting all that its opponents here contend. The difference between the two theories does not consist in any difference of emphasis on the objective side of knowledge, but in the standard by which the nature of the object is to be tested—the difference is logical not metaphysical—it concerns the definition of truth or falsity in the knowledge of the reality which both admit. To idealism there can be no ultimate test, but the possibility of giving any fact which claims to be true its place in a coherent system of mutually related truths. To this dualism opposes the doctrine that truth and falsehood are a matter of mere immediate intuition: "There is no problem at all in truth and falsehood, some propositions are true and some false just as some roses are red and some white."<sup>3</sup> The issue between the two theories under this head may here be left with the remark that it is a curious comment on the logic of dualism that setting out to vindicate the reality of an objective standard of truth it should end in the most subjective of all the way a thing appears to the individual. The criticism that applies to the first of the above contentions applies *mutatis mutandis* to the second. As idealism differs from Berkeleyanism in asserting the reality of an "external" world so it differs from Spinozism in asserting the reality of difference within it. Determination is not merely negation. On this head there need be no quarrel between it and dualism. Ours is a many-sided, a many-coloured world. The point of conflict again lies in the nature and ground of the assigned differences. Dualism meets the assertion of absolute unity by the counter assertion of mere difference. But if it is an error to treat the unity of the world as its only real aspect, it is equally an error to treat its differences as something ultimately irreducible. No philosophy founded on this assumption is likely to maintain itself against the twofold evidence of modern psychology and modern logic. According to the first world, whether looked at from the side of our perception or from the side of the object perceived, can be made intelligible only when we accept it for what it is as a real continuity. Differences, of course, there are; and, if we like to say so, every difference is unique, but this does not mean that they are given in absolute independence of everything else, "fired at us out of

a cannon." They bear a definite relation to the structure of our physical and psychological nature, and correspond to definite needs of the subject that manifests itself therein. Similarly from the side of logic. It is not the teaching of idealism alone but of the facts which logical analysis has brought home to us that all difference in the last resort finds its ground in the quality or content of the things differentiated, and that this difference of content shows in turn a double strand, the strand of sameness and the strand of otherness—that *in* which and that *by* which they differ from one another. Idealism has, of course, no quarrel with numerical difference. All difference has its numerical aspect: two different things are always two both in knowledge and in reality. What it cannot accept is the doctrine that there are two things which are two in themselves apart from that which makes them two—which are not two of something. So far from establishing the truth for which dualism is itself concerned—the reality of all differences—such a theory can end only in a scepticism as to the reality of any difference. It is difficult to see what real difference there can be between things which are differences of nothing.

II. More widespread and of more serious import is the attack from the other side to which since the publication of A. Seth's *Hegelianism and Personality* (1887) and W. James's *Will to Believe* (1903) idealism has been subjected. Here also it is important to distinguish what is relevant from what is irrelevant in the line of criticism represented by these writers. There need be no contradiction between idealism and a reasonable pragmatism. In so far as the older doctrine is open to the charge of neglecting the conative and teleological side of experience it can afford to be grateful to its critics for recalling it to its own eponymous principle of the priority of the "ideal" to the "idea," of needs to the conception of their object. The real issue comes into view in the attempt, undertaken in the interest of freedom, to substitute for the notion of the world as a cosmos pervaded by no discernible principle and in its essence indifferent to the form impressed upon it by its active parts.

To the older idealism as to the new the essence of mind or spirit is freedom. But the guarantee of freedom is to be sought for not in the denial of law, but in the whole nature of mind and its relation to the structure of experience. *Without mind no orderly world*: only through the action of the subject and its "ideas" are the confused and incoherent data of sense-perception (themselves shot through with both strands) built up into that system of things we call Nature, and which stands out against the subject as the body stands out against the soul whose functioning may be said to have created it. On the other hand, *without the world no mind*: only through the action of the environment upon the subject is the idealizing activity in which it finds its being called into existence. Herein lies the paradox which is also the deepest truth of our spiritual life. In interpreting its environment first as a world of things that seem to stand in a relation of exclusion to one another and to itself, then as a natural system governed by rigid mechanical necessity, the mind can yet feel that in its very opposition the world is akin to it, bone of its bone and flesh of its flesh. What is true of mind is true of will. Idealism starts from the relativity of the world to purposive consciousness. But this again may be so stated as to represent only one side of the truth. It is equally true that the will is relative to the world of objects and interests to which it is attached through instincts and feelings, habits and sentiments. In isolation from its object the will is as much an abstraction as thought apart from the world of percepts, memories and associations which give it content and stability. And just as mind does not lose but gain in individuality in proportion as it parts with any claim to the capricious determination of what its world shall be, and becomes dominated by the conception of an order which is immutable so the will becomes free and "personal" in proportion as it identifies itself with objects and interests, and subordinates itself to laws and requirements which involve the suppression of all that is merely arbitrary and subjective. Here, too, subject and object grow together. The power and vitality of the one is the power and vitality of the other, and this is so because they are not two things with separate roots but are both rooted in a common reality which, while it includes, is more than it contains.

Passing by these contentions as unmeaning or irrelevant and seeing nothing but irreconcilable contradiction between the conceptions of the world as immutable law and a self-determining subject pragmatism (g.v.) seeks other means of vindicating the reality of freedom. It agrees with older forms of libertarianism in taking its stand on the fact of spontaneity as primary and self-evidencing,

<sup>1</sup> See *Mind*, New Series, xii, p. 433 sqq.

<sup>2</sup> *Proceedings of the Aristotelian Society* (1900-1901), p. 110.

<sup>3</sup> *Mind*, New Series, xiii, p. 523; cf. 204, 356.

but it is not content to assert its existence side by side with rigidly determined sequence. It carries the war into the camp of the enemy by seeking to demonstrate that the completely determined action which is set over against freedom as the basis of explanation in the material world is merely a hypothesis which, while it serves sufficiently well the limited purpose for which it is devised, is incapable of verification in the ultimate constituents of physical nature. There seems in fact nothing to prevent us from holding that while natural laws express the average tendencies of multitudes they give no clue to the movement of individuals. Some have gone farther and argued that from the nature of the case no causal explanation of any real change in the world of things is possible. "A cause is that which contains the effect ('causa aequat effectum')," but this is precisely what can never be proved with respect to anything that is claimed as a real cause in the concrete world. Everywhere the effect reveals an element which is indiscoverable in the cause with the result that the identity we seek for ever eludes us. Even the resultant of mechanical forces refuses to resolve itself into its constituents. In the "resultant" there is a new direction, and with it a new quality the component forces of which no analysis can discover.<sup>1</sup>

It is not here possible to do more than indicate what appear to be the valid elements in these two conflicting interpretations of the requirements of a true idealism. On behalf of the older it may be confidently affirmed that no solution is likely to find general acceptance which involves the rejection of the conception of unity and intelligible order as the primary principle of our world. The assertion of this principle by Kant was, we have seen, the corner-stone of idealistic philosophy in general, underlying as it does the conception of a permanent subject not less than that of a permanent object. As little from the side of knowledge is it likely that any theory will find acceptance which reduces all thought to a process of analysis and the discovery of abstract identity. There is no logical principle which requires that we should derive qualitative change by logical analysis from quantitative difference. Everywhere experience is synthetic: it gives us multiplicity in unity. Explanation of it does not require the annihilation of all differences but the apprehension of them in organic relation to one another and to the whole to which they belong. It was, as we have seen, this conception of thought as essentially synthetic for which Kant paved the way in his polemic against the formalism of his continental predecessors. The revival as in the above argument of the idea that the function of thought is the elimination of difference, and that rational connexion must fail where absolute identity is indiscoverable merely shows how imperfectly Kant's lesson has been learned by some of those who profess in his name.

Finally, apart from these more academic arguments there is an undoubted paradox in a theory which, at a moment when in whatever direction we look the best inspiration in poetry, sociology and physical science comes from the idea of the unity of the world, gives in its adhesion to pluralism on the ground of its preponderating practical value.

On the other hand, idealism would be false to itself if it interpreted the unity which it thus seeks to establish in any sense that is incompatible with the validity of moral distinctions and human responsibility in the fullest sense of the term. It would on its side be, indeed, a paradox if at a time when the validity of human ideals and the responsibility of nations and individuals to realize them is more universally recognized than ever before on our planet, the philosophical theory which hitherto has been chiefly identified with their vindication should be turned against them. Yet the depth and extent of the dissatisfaction are sufficient evidence that the most recent developments are not free from ambiguity on this vital issue.

What is thus suggested is not a rash departure from the general point of view of idealism (by its achievements in every field to which it has been applied, "stat mole sua") but a cautious inquiry into the possibility of reaching a conception of the world

<sup>1</sup> The most striking statement of this argument is to be found in Boutroux's treatise *De la contingence des lois de la nature*, first published in 1874 and reprinted without alteration in 1905. The same general line of thought underlies James Ward's *Naturalism and Agnosticism* (2nd ed., 1903), and A. J. Balfour's *Foundations of Ethics* (8th ed., 1902). H. Bergson's works on the other hand contain the elements of a reconstruction similar in spirit to the suggestions of the present article.

in which a place can be found at once for the idea of unity and determination and of movement and freedom. Any attempt here to anticipate what the course of an idealism inspired by such a spirit of caution and comprehension is likely to be cannot but appear dogmatic.

Yet it may be permitted to make a suggestion. Taking for granted the unity of the world idealism is committed to interpret it as spiritual as a unity of spirits. This is implied in the phrase by which it has sought to signalize its break with Spinozism: "from substance to subject." The universe or finite is one that realizes itself in finite particular minds and wills, not as accidents or imperfections of it, but as its essential form. These on their side, to be subject in the true sense must be conceived of as possessing a life which is truly their own, the expression of their own nature as self-determinant. In saying subject we say self, in saying self we say free creator. No conception of the infinite can therefore be true which does not leave room for movement, process, free creation. Oldness, sameness, permanence of principle and direction, these must be, otherwise there is *nothing*; but newness of embodiment, existence, realization also, otherwise nothing is.

Now it is just to these implications in the idea of spirit that some of the prominent recent expositions of Idealism seem to have failed to do justice. They have failed particularly when they have left the idea of "determination" unpurged of the suggestion of time succession. The very word lends itself to this mistake. Idealists have gone beyond others in asserting that the subject in the sense of a being which merely repeats what has gone before is timeless. This involves that its activity cannot be truly conceived of as included in an antecedent, as an effect in a cause or one term of an equation in the other. As the activity of a subject or spirit it is essentially a new birth. It is this failure that has led to the present revolt against a "block universe." But the difficulty is not to be met by running to the opposite extreme in the assertion of a loose and ramshackle one. This is merely another way of perpetuating the mistake of allowing the notion of determination by an *other* or a preceding to continue to dominate us in a region where we have in reality passed from it to the notion of determination by self or by self-acknowledged ideals. As the correction from the one side comes from a more whole-hearted acceptance of the conception of determination by an ideal as the essence of mind, so from the other side it must consist in the recognition of the valuelessness of a freedom which does not mean submission to a self-choosen, though not self-created, law.

The solution here suggested is probably more likely to meet with opposition from the side of Idealism than of Pragmatism. It involves, it will be said, the reality of time, the dependence of the Infinite in the finite, and therewith a departure from the whole line of Hegelian thought. (1) It does surely involve the reality of time in the sense that it involves the reality of existence. Time is agreed process. Without process the eternal is not complete or, if eternity means completeness, is not truly eternal. Our mistake lies in abstraction of the one from the other, which, as always, ends in confusion of the one with the other. Truth lies in giving each its place. Not only does eternity assert the conception of the hour but the hour asserts the conception of eternity—with what adequacy is another question. (2) The second of the above objections takes its point from the contradiction to religious consciousness which seems to be involved. This is certainly a mistake. Religious consciousness asserts, no doubt, that God is necessary to the soul: from Him as its inspiration, to Him as its ideal are all things. But it asserts with equal emphasis that the soul is necessary to God. To declare itself an unnecessary creation is surely on the part of the individual soul the height of impiety. God lives in the soul as it in Him. He also might say, from it as His offspring, to it as the object of His outgoing love are all things. (3) It is a mistake to attribute to Hegel the doctrine that time is an illusion. If in a well-known passage (*Logic* § 212) he seems to untenably to suggest, as we have immediately corrected it by assigning an "actualizing force" to this illusion and making it a necessary dynamic element of truth. "Consistently with this we have the conclusion stated in the succeeding section on the Will. "Good, the final end of the world, has being only while it constantly produces itself. And the world of the spirit and the world of nature continue to have this distinction, that the latter moves only in a recurring cycle while the former certainly also makes progress." The mistake is not Hegel's but ours. It is to be remedied not by giving up the idea of the Infinite but by ceasing to think of the Infinite as of a being endowed with a static perfection which the finite will merely reproduce, and definitely recognizing the forward effort of the finite as an essential element in its self-expression. If there be any truth in this suggestion it seems likely that the last word of idealism, like the first, will prove to be that the type of the highest reality is to be sought for not in any fixed Parmenidean circle of achieved being but in an ideal of good which will never fully expressed under the form of time can never become actual and so fulfil itself under any other.

BIBLIOGRAPHY. (A) General works besides those of the writers mentioned above: W. Wallace, *Metaphysics of Hegel* (1894), and Hegel's *Philosophy of Mind* (1894); A. Seth and R. B.

Haldane, *Essays in Phil. Criticism* (1883); John Watson, *Kant and his English Critics* (1881); J. B. Baillie, *Idealistic Construction of Experience* (1906); J. S. Mackenzie, *Outlines of Metaphysics* (1902); A. E. Taylor, *Elements of Metaphysics* (1903); R. L. Nettleship, *Lectures and Remains* (1897); D. G. Ritchie, *Philosophical Studies* (1905).

(b) Works on particular branches of philosophy: (a) *Logic*—F. H. Bradley, *Principles of Logic* (1883); B. Bosanquet, *Logic* (1888) and *Essentials of Logic* (1895). (b) *Psychology*—J. Dewey, *Psychology* (1886); G. F. Stout, *Analytic Psychology* (1896); B. Bosanquet, *Psychology of the Moral Self* (1897). (c) *Ethics*—F. H. Bradley, *Ethical Studies* (1876); J. Dewey, *Ethics* (1891); W. R. Sorley, *Elements of Naturalism* (2nd ed., 1904); J. S. Mackenzie, *Manual of Ethics* (4th ed., 1900); J. H. Muirhead, *Elements of Ethics* (3rd ed., 1910). (d) *Politics and Economics*—B. Bosanquet, *Philosophical Theory of the State* (1899), and *Aspects of the Social Problem* (1895); B. Bonar, *Philosophy and Political Economy in their historical Relations* (1873); D. G. Ritchie, *Natural Rights* (1895); J. S. Mackenzie, *An Introduct. to Social Phil.* (1890); J. MacCurt., *Six Radical Thinkers* (1907). (e) *Aesthetic*—B. Bosanquet, *History of Aesthetic* (1892), and *Introduct. to Hegel's Phil. of the Fine Arts* (1886); W. Hastie, *Phil. of Art by Hegel and Michelet* (1886). (f) *Religion*—J. Royce, *Religious Aspect of Philosophy* (1885), and *The Conception of God* (1897); R. B. Haldane, *The Pathway to Reality* (1903); E. Caird, *Evolution of Religion* (1893); J. Caird, *Introduct. to the Phil. of Religion* (1886); H. Jones, *Idealism as a Practical Creed* (1909).

(c) Recent Criticism. Besides works mentioned in the text: W. James, *Pragmatism* (1907). *A Pluralistic Universe* (1909). *The Meaning of Truth* (1909). H. Sturt, *Personal Idealism* (1902); F. C. S. Schiller, *Humanism* (1903); G. E. Moore, *Principia Ethica*; H. Rashdall, *The Theory of Good and Evil* (1907).

See also ETHICS and METAPHYSICS.

(J. H. Mu.)

**IDELER, CHRISTIAN LUDWIG** (1766–1846), German chronologist and astronomer, was born near Perleberg on the 21st of September 1766. After holding various official posts under the Prussian government he became professor at the university of Berlin in 1821, and eighteen years later foreign member of the Institute of France. From 1816 to 1822 he was tutor to the young princes William Frederick and Charles. He died in Berlin on the 10th of August 1846. He devoted his life chiefly to the examination of ancient systems of chronology. In 1825–1826 he published his great work, *Handbuch der mathematischen und technischen Chronologie* (2 vols.; 2nd ed., 1883), re-edited as *Lehrbuch der Chronologie* (1831); a supplementary volume, *Die Zeichnung der Chinesen*, appeared in 1839. Beside these important works he wrote also *Untersuchungen über d. Ursprung und d. Bedeutung d. Sternnamen* (1800) and *Über d. Ursprung d. Thierkreises* (1838). With Nolte he published handbooks on English and French language and literature. His son, JULIUS LUDWIG IDELER (1809–1842), wrote *Meteorologia veterum Græcorum et Romanorum* (1832).

**IDENTIFICATION** (Lat. *idem*, the same), the process of proving any one's identity, i.e. that he is the man he purports to be, or—if he is pretending to be some one else—the man he really is; or in case of dispute, that he is the man he is alleged to be. As more strenuous efforts have been made for the pursuit of criminals, and more and more severe penalties are inflicted on old offenders, means of identification have become essential, and various processes have been tried to secure that desirable end. For a long time they continued to be most imperfect; nothing better was devised than rough and ready methods of recognition depending upon the memories of officers of the law or the personal impressions of witnesses concerned in the case, supplemented in more recent years by photographs, not always a safe and unerring guide. The machinery employed was cumbersome, wasteful of time and costly. Detective policemen were marched in a body to inspect arrested prisoners in the exercising yards of the prison. Accused persons were placed in the midst of a number of others of approximately like figure and appearance, and the prosecutor and witnesses were called in one by one to pick out the offender. Inquiries, with a detailed description of distinctive marks, and photographs were circulated far and wide to local police forces. Officers, police and prison wardens were despatched in person to give evidence of identity at distant courts. Mis-identification was by no means rare. Many remarkable cases may be quoted. One of the most notable was that of the Frenchman Lesurques, in the days of the Directory, who was positively identified as having robbed

the Lyons mail and suffered death, protesting his innocence of the crime, which was afterwards brought home to another man, Duboscq, and this terrible judicial error proved to be the result of the extraordinary likeness between the two men. Another curious case is to be found in American records, when a man was indicted for bigamy as James Hoag, who avowed that he was really Thomas Parker. There was a marvellous conflict of testimony, even wives and families and personal friends being misled, and there was a narrow escape of mis-identification. The leading modern case in England is that of Adolf Beck (1905). Beck (who eventually died at the end of 1909) was arrested on the complaint of a number of women who positively swore to his identity as Smith, a man who had defrauded them. An ex-policeman who had originally arrested Smith also swore that Beck was the same man. There was a grave miscarriage of justice. Beck was sentenced to penal servitude, and although a closer examination of the personal marks showed that Beck could not possibly be Smith, it was only after a scandalous delay, due to the obstinacy of responsible officials, that relief was afforded. It has to be admitted that evidence as to identity based on personal impressions is perhaps of all classes of evidence the least to be relied upon.

Such elements of uncertainty cannot easily be eliminated from any system of jurisprudence, but some improvements in the methods of identification have been introduced in recent years. The first was in the adoption of anthropometry (*g.r.*), which was invented by the French savant, A. Bertillon. The reasons that led to its general supersession may be summed up in its costliness, the demand for superior skill in subordinate agents and the liability to errors not easy to trace and correct. A still more potent reason remained, the comparative failure of results. It was found in the first four years of its use in England and Wales that an almost inappreciable number of identifications were effected by the anthropometric system; namely, 152 in 1898, 243 in 1899, 462 in 1900, and 503 in 1901, the year in which it was supplemented by the use of "finger prints" (*g.r.*). The figures soon increased by leaps and bounds. In 1902 the total number of searches among the records were 6826 and the identifications 1722 for London and the provinces; in 1903 the searches were 11,919, the identifications 3642; for the first half of 1904 the searches were 6697 and the identifications 2335. In India and some of the colonies the results were still more remarkable; the recognitions in 1903 were 9512, and 17,289 in 1904. Were returns available from other countries very similar figures would no doubt be shown. Among these countries are Ireland, Australasia, Ceylon, South Africa, and many great cities of the United States; and the system is extending to Germany, Austria-Hungary and other parts of Europe.

The record of finger prints in England and Wales is kept by the Metropolitan police at New Scotland Yard. They were at first limited to persons convicted at courts at quarter sessions and assizes and to all persons sentenced at minor courts to more than a month without option of fine for serious offences. The finger prints when taken by prison wardens are forwarded to London for registration and reference on demand. The total number of finger-print slips was 70,000 in 1904, and weekly additions were being made at the rate of 350 slips. The advantages of the record system need not be emphasized. By its means identification is prompt, inevitable and absolutely accurate. By forwarding the finger prints of all remanded prisoners to New Scotland Yard, their antecedents are established beyond all hesitation.

In past times identification of criminals who had passed through the hands of the law was compassed by branding, imprinting by a hot iron, or tattooing with an indelible sign, such as a crown, fleur de lys or initials upon the shoulder or other part of the body. This practice, long since abandoned, was in a measure continued in the British army, when offenders against military law were ordered by sentence of court-martial to be marked with "D" for deserter and "B.C." bad character; this ensured their recognition and prevented re-enlistment; but all such penalties have now disappeared. (A. G.)

**IDEOGRAPH** (Gr. *ἰδέα*, idea, and *γράφω*, to write), a symbol or character painted, written or inscribed, representing ideas and not sounds; such a form of writing is found in Chinese and in most of the Egyptian hieroglyphs (see WRITING).

**IDIOBLAST** (Gr. *ἰδίος*, peculiar, and *βλαστός*, a shoot), a botanical term for an individual cell which is distinguished by its shape, size or contents, such as the stone-cells in the soft tissue of a pear.

**IDIOM** (Gr. *ἰδιωμα*, something peculiar and personal; *ἰδίος*, one's own, personal), a form of expression whether in words, grammatical construction, phraseology, &c., which is peculiar to a language; sometimes also a special variety of a particular language, a dialect.

**IDIOSYNCRASY** (Gr. *ἰδιοσυγκρασία*, peculiar habit of body or temperament; *ἰδίος*, one's own, and *σύνκρasis*, blending, tempering, from *συνκεράννσθαι*, to put together, compound, mix), a physical or mental condition peculiar to an individual usually taking the form of a special susceptibility to particular stimuli; thus it is an idiosyncrasy of one individual that abnormal sensations of discomfort should be excited by certain odours or colours, by the presence in the room of a cat, &c.; similarly certain persons are found to be peculiarly responsive or irresponsive to the action of particular drugs. The word is also used, generally, of any eccentricity or peculiarity of character, appearance, &c.

**IDOLATRY**, the worship (Gr. *λατρεία*) of idols (Gr. *εἰδώλον*), i.e. images or other objects, believed to represent or be the abode of a superhuman personality. The term is often used generically to include such varied forms as litholatry, dendrolatry, pyrolatry, zoolatry and even necrolatry. In an age when the study of religion was practically confined to Judaism and Christianity, idolatry was regarded as a degeneration from an uncorrupt primeval faith, but the comparative and historical investigation of religion has shown it to be rather a stage of an upward movement, and that by no means the earliest. It is not found, for instance, among Bushmen, Fuegians, Eskimos, while it reached a high development among the great civilizations of the ancient world in both hemispheres.<sup>1</sup> Its earliest stages are to be sought in naturism and animism. To give concreteness to the vague ideas thus worshipped the idol, at first rough and crude, comes to the help of the savage, and in course of time through inability to distinguish subjective and objective, comes to be identified with the idea it originally symbolized. The degraded form of animism known as fetishism is usually the direct antecedent of idolatry. A fetish is adored, not for itself, but for the spirit who dwells in it and works through it. Fetiches of stone or wood were at a very early age shaped and polished or coloured and ornamented. A new step was taken when the top of the log or stone was shaped like a human head; the rest of the body soon followed. The process can be followed with some distinctness in Greece. Sometimes, as in Babylonia and India, the representation combined human and animal forms, but the human figure is the predominant model; man makes God after his own image.

Idols may be private and personal like the teraphim of the Hebrews or the little figures found in early Egyptian tombs, or—a late development, public and tribal or national. Some, like the ancestral images among the Maoris, are the intermittent abodes of the spirits of the dead.

As the earlier stages in the development of the religious consciousness persist and are often manifest in idolatry, so in the higher stages, when men have attained loftier spiritual ideas, idolatry itself survives and is abundantly visible as a reactionary

<sup>1</sup> According to Varro the Romans had no animal or human image of a god for 170 years after the founding of the city; Herodotus (i. 131) says the Persians had no temples or idols before Artaxerxes I.; Lucian (*De sacrif.* 11) bears similar testimony for Greece and as to idols (*Dea Syr.* 3) for Egypt. Eusebius (*Præp. Evang.* i. 9) sums up the theory of antiquity in his statement "the oldest peoples had no idols." Images of the gods indeed presuppose a definiteness of conception and powers of discrimination that could only be the result of history and reflection. The iconic age everywhere succeeded to an era in which the objects of worship were aniconic, e.g. wooden posts, stone steles, cones.

tendency. The history of the Jewish people whom the prophets sought, for long in vain, to wean from worshipping images is an illustration: so too the vulgarities of modern popular Hinduism contrasted with the lofty teaching of the Indian sacred books.

In the New Testament the word *εἰδωλολατρεία* (*idololatría*, afterwards shortened occasionally to *εἰδωλατρεία*, *idolatria*) occurs in all four times, viz. in 1 Cor. x. 14; Gal. v. 20; 1 Peter iv. 3; Col. iii. 5. In the last of these passages it is used to describe the sin of covetousness or "mammon-worship." In the other places it indicates with the utmost generality all the rites and practices of those special forms of paganism with which Christianity first came into collision. It can only be understood by reference to the LXX., where *εἰδωλον* (like the word "idol" in A.V.) occasionally translates indifferently no fewer than sixteen words by which in the Old Testament the objects of what the later Jews called "strange worship" (עֲבוֹדָה זָרָה) are denoted (see *Encyclopædia Biblica*). In the widest acceptance of the word, idolatry in any form is absolutely forbidden in the second commandment, which runs "Thou shalt not make unto thee a graven image; [and] to no visible shape in heaven above, or in the earth beneath, or in the water under the earth, shalt thou bow down or render service" (see DECALOGUE). For some account of the questions connected with the breaches of this law which are recorded in the history of the Israelites see the article JEWS; those differences as to the interpretation of the prohibition which have so seriously divided Christendom are discussed under the head of ICONOCLASTS.

In the ancient church, idolatry was naturally reckoned among those *magna crimina* or great crimes against the first and second commandments which involved the highest ecclesiastical censures. Not only were those who had gone openly to heathen temples and partaken in the sacrifices (*sacrificati*) or burnt incense (*thurificati*) held guilty of this crime; the same charge, in various degrees, was incurred by those whose renunciation of idolatry had been private merely, or who otherwise had used unworthy means to evade persecution, by those also who had feigned themselves mad to avoid sacrificing, by all promoters and encouragers of idolatrous rites, and by idol makers, incense sellers and architects or builders of structures connected with idol worship. Idolatry was made a crime against the state by the laws of Constantius (*Cod. Theod.* xvi. 10. 4, 6), forbidding all sacrifices on pain of death, and still more by the statutes of Theodosius (*Cod. Theod.* xvi. 10. 12) enacted in 392, in which sacrifice and divination were declared treasonable and punishable with death; the use of lights, incense, garlands and libations was to involve the forfeiture of house and land where they were used; and all who entered heathen temples were to be fined. See Bingham, *Antiqq.* bk. xvi. c. 4.

See also IMAGE-WORSHIP; and on the whole question, RELIGION.

**IDOMENEUS**, in Greek legend, son of Deucalion, grandson of Minos and Pasiphaë, and king of Crete. As a descendant of Zeus and famous for his beauty, he was one of the suitors of Helen; hence, after her abduction by Paris, he took part in the Trojan War, in which he distinguished himself by his bravery. He is mentioned as a special favourite of Agamemnon (*Iliad*, iv. 257). According to Homer (*Odyssey*, iii. 191), he returned home safely with all his countrymen who had survived the war, but later legend connects him with an incident similar to that of Jephtha's daughter. Having been overtaken by a violent storm, to ensure his safety he vowed to sacrifice to Poseidon the first living thing that met him when he landed on his native shore. This proved to be his son, whom he slew in accordance with his vow; whereupon a plague broke out in the island, and Idomeneus was driven out. He fled to the district of Salentum in Calabria, and subsequently to Colophon in Asia Minor, where he settled near the temple of the Clarian Apollo and was buried on Mount Cercaphus (Virgil, *Aeneid*, iii. 121, 400, 531, and Servius on those passages). But the Cretans showed his grave at Cnossus, where he was worshipped as a hero with Meriones (*Diod. Sic.* v. 79).

**IDRIA**, a mining town in Carniola, Austria, 25 m. W. of Laibach. Pop. (1900) 5772. It is situated in a narrow Alpine valley, on the river Idria, an affluent of the Isonzo, and owes its prosperity to the rich mines of quicksilver which were accidentally discovered in 1497. Since 1580 they have been under the management of the government. The mercurial ores lie in a bed of clay slate, and is found both mingled with schist and in the form of cinnabar. A special excellence of the ore is the greatness of the yield of pure metal compared with the amount of the refuse. As regards the quantity annually extracted, the mines of Idria rank second to those of Almaden in Spain, which are the richest in the world.

**IDRIALIN**, a mineral wax accompanying the mercury ore in Idria. According to Goldschmidt it can be extracted by means of xylol, amyl alcohol or turpentine; also without decomposition, by distillation in a current of hydrogen, or carbon dioxide. It is a white crystalline body, very difficultly fusible, boiling above  $440^{\circ}\text{C}$ . ( $824^{\circ}\text{F}$ .), of the composition  $\text{C}_{20}\text{H}_{32}\text{O}$ . Its solution in glacial acetic acid, by oxidation with chromic acid, yielded a red powdery solid and a fatty acid fusing at  $62^{\circ}\text{C}$ ., and exhibiting all the characters of a mixture of palmitic and stearic acids.

**IDRISI**, or **IDRIS** [Abu Abdallah Mohammed Ibn Mahommed Ibn Abdallah Ibn Idrisi c. A.D. 1099–1154], Arabic geographer. Very little is known of his life. Having left Islamic lands and become the courtier and panegyrist of a Christian prince, though himself a descendant of the Prophet, he was probably regarded by strict Moslems as a scandal, whose name should not, if possible, be mentioned. His great-grandfather, Idrisi II., "Biamrillah," a member of the great princely house which had reigned for a time as caliphs in north-west Africa, was prince of Malaga, and likewise laid claim to the supreme title (Commander of the Faithful). After his death in 1055, Malaga was seized by Granada (1057), and the Idrisi family then probably migrated to Ceuta, where a freedman of theirs held power. Here the geographer appears to have been born in A.H. 493 (A.D. 1099). He is said to have studied at Cordova, and this tradition is confirmed by his elaborate and enthusiastic description of that city in his geography. From this work we know that he had visited, at some period of his life before A.D. 1154, both Lisbon and the mines of Andalusia. He had also once resided near Morocco city, and once was at (Algerian) Constantine. More precisely, he tells us that in A.D. 1117 he went to see the cave of the Seven Sleepers at Ephesus; he probably travelled extensively in Asia Minor. From doubtful readings in his text some have inferred that he had seen part of the coasts of France and England. We do not know when Roger II. of Sicily (1101–1154) invited him to his court, but it must have been between 1125 and 1150. Idrisi made for the Norman king a celestial sphere and a disk representing the known world of his day—both in silver. These only absorbed one-third of the metal that had been given him for the work, but Roger bestowed on him the remaining two-thirds as a present, adding to this 100,000 pieces of money and the cargo of a richly-laden ship from Barcelona. Roger next enlisted Idrisi's services in the compilation of a fresh description of the "inhabited" earth from observation, and not merely from books. The king and his geographer chose emissaries whom they sent out into various countries to observe, record and design; as they returned, Idrisi inserted in the new geography the information they brought. Thus was gradually completed (by the month of Shawwal, A.H. 548=mid-January, A.D. 1154), the famous work, best known from its patron and originator, as *Al Rojari*, but whose fullest title seems to have been, *The going out of a Curious Man to explore the Regions of the Globe, its Provinces, Islands, Cities and their Dimensions and Situation*. This has been abbreviated to *The Amusement of him who desires to traverse the Earth, or The Relaxation of a Curious Mind*. The title of *Nubian Geography*, based upon Sionita and Hezronita's misreading of a passage relating to Nubia and the Nile, is entirely unwarranted and misleading. The *Rogierian Treatise* contains a full description of the world as far as it was known to the

author. The "inhabited earth" is divided into seven "climates," beginning at the equinoctial line, and extending northwards to the limit at which the earth was supposed to be rendered uninhabitable by cold. Each climate is then divided by perpendicular lines into eleven equal parts, beginning with the western coast of Africa and ending with the eastern coast of Asia. The whole world is thus formed into seventy-seven equal square compartments. The geographer begins with the first part of the first climate, including the westernmost part of the Sahara and a small (north-westerly) section of the Sudan (of which a vague knowledge had now been acquired by the Moslems of Barbary), and thence proceeds eastward through the different divisions of this climate till he finds its termination in the Sea of China. He then returns to the first part of the second climate, and so proceeds till he reaches the eleventh part of the seventh climate, which terminates in north-east Asia, as he conceives that continent. The inconveniences of the arrangement (ignoring all divisions, physical, political, linguistic or religious, which did not coincide with those of his "climates") are obvious.

Though Idrisi was in such close relations with one of the most civilized of Christian courts and states, we find few traces of his influence on European thought and knowledge. The chief exception is perhaps in the delineation of Africa in the world-maps of Marino Sanuto (*q.v.*) and Pietro Vesconte. His account of the voyage of the *Maghrurin* or "Deceived Men" of Lisbon in the Atlantic (a voyage on which they seem to have visited Madeira and one of the Canaries) may have had some effect in stimulating the later ocean enterprise of Christian mariners; but we have no direct evidence of this. Idrisi's Ptolemaic leanings give a distinctly retrograde character to certain parts of his work, such as east Africa and south Asia; and, in spite of the record of the Lisbon Wanderers, he fully shares the common Moslem dread of the black, viscous, stormy and wind-swept waters of the western ocean, whose limits no one knew, and over which thick and perpetual darkness brooded. At the same time his breadth of view, his clear recognition of scientific truths (such as the roundness of the world) and his wide knowledge and intelligent application of preceding work (such as that of Ptolemy, Masudi and Al Jyhani) must not be forgotten. He also preserves and embodies a considerable amount of private and special information—especially as to Scandinavia (in whose delineation he far surpasses his predecessors), portions of the African coast, the river Niger (whose name is perhaps first to be found, after Ptolemy's doubtful Niger, in Idrisi), portions of the African coast, Egypt, Syria, Italy, France, the Adriatic shore-lands, Germany and the Atlantic islands. No other Arabic work contains a larger assortment of valuable geographical facts; unfortunately the place-names are often illegible or hopelessly corrupted in the manuscripts. Idrisi's world-map, with all its shortcomings, is perhaps the best product of that strangely feeble theme—the Mahomedan cartography of the middle ages.

Besides the *Rojari*, Idrisi wrote another work, largely geographical, cited by Abulfida as *The Book of Kingdoms*, but apparently entitled by its author *The Gardens of Humanity and the Amusement of the Soul*. This was composed for William the Bad (1154–1166), son and successor of Roger II., but is now lost. He likewise wrote, according to Ibn Said, on *Medicaments*, and composed verses, which are referred to by the Nubian Mahomedan poet Ibn Bashrun.

Two manuscripts of Idrisi exist in the Bibliothèque Nationale, Paris, and other two in the Bodleian Library, Oxford. One of the English MSS., brought from Egypt by Greaves, is illustrated by a map of the known world, and by thirty-three sectional maps (for each part of the first three climates). The second manuscript, brought by Pococke from Syria, bears the date of A.H. 906, or A.D. 1500. It consists of 320 leaves, and is illustrated by one general and seven-seventy particular maps, the latter consequently including all the parts of every climate. The general map was published by Dr Vincent in his *Periphus of the Erythraean Sea*. A copy of Idrisi's work in the Escorial was destroyed by the fire of 1671.

An epitome of Idrisi's geography, in the original Arabic, was printed, with many errors, in 1592 at the Medicean press in Rome, from a MS. preserved in the Grand Ducal library at Florence (*De geographia universali, Hortuluo cultissimus* . . .). Even the description of Mecca is here omitted. Pococke supplied it from

his MS. In many bibliographical works this impression has been wrongly characterized as one of the rarest of books. In 1619 two Maronite scholars, Gabriel Sionita and Joannes Hezronita, published at Paris a Latin translation of this epitome (*Geographia Nubiensis, id est, accuratissima lotius orbis in VII. climata divisi descriptio*). Besides its many inaccuracies of detail, this edition, by its unlucky title of *Nubiae Geographia*, started a fresh and fundamental error as to Idrisi's origin; it was founded on a misreading of a passage where Idrisi describes the Nile passing into Egypt through Nubia—not "*terram nostram*," as this version gives, but "*terram illius*" is here the true translation. George Hieronymus Velschius, a German scholar, had prepared a copy of the Arabic original, with a Latin translation, which he purposed to have illustrated with notes; but death interrupted this design, and his manuscript remains in the university library of Jena. Casiri (*Bib. Ar. Hist.* ii. 13) mentions that he had determined to re-edit this work, but he appears never to have executed his intention. The part relating to Africa was ably edited by Johann Melchior Hartmann (*Commentatio de geographia Africae Edrisiana*, Göttingen, 1791, and *Edrisii Africa*, Göttingen, 1796). Here are collected the notices of each region in other Moslem writers, so as to form, for the time, a fairly complete body of Arabic geography as to Africa. Hartmann afterwards published Idrisi's Spain (*Hispania*, Marburg, 3 vols., 1802-1818).

An (indifferent) French translation of the whole of Idrisi's geography (the only complete version which has yet appeared), based on one of the MSS. of the Bibliothèque Nationale, Paris, was published by Amédée Jaubert in 1836-1840, and forms volumes v. and vi. of the *Recueil de voyages* issued by the Paris Société de Géographie; but a good and complete edition of the original text is still a desideratum. A number of Oriental scholars at Leiden determined in 1861 to undertake the task. Spain and western Europe were assigned to Dozy; eastern Europe and western Asia to Engelmann; central and eastern Asia to DeFrémery; and Africa to de Goeje. The first portion of the work appeared in 1866, under the title of *Description de l'Afrique et de l'Espagne par Edrisi, texte arabe, publié avec une traduction, des notes et un glossaire par R. Dozy et M. J. de Goeje* (Leiden, E. J. Brill, 1866); but the other collaborators did not furnish their quota. Other parts of Idrisi's work have been separately edited; e.g., "*Spain*" in *Description de l'Espagne de . . . Aléridis*, by J. A. Cerdà, in Arabic and Spanish (Madrid, 1799); "*Sicily*" (*Descrizione della Sicilia . . . di Elidrisi*), by P. D. Magri and F. Tardia (Palermo, 1764); "*Italy*" (*Italia descritta nel "libro del Re Ruggero," compilato da Edrisi*), by M. Amari and C. Schiaparelli, in Arabic and Italian (Rome, 1883); "*Syria*" (*Syria descripta a . . . El Edrisio . . .*), by E. F. C. Rosenmüller, in Arabic and Latin, 1825, and (*Idrisi . . . Syria*), by J. Gildemeister (Bonn, 1885) (the last a Beilage to vol. viii. of the *Zeitschrift d. deutsch. Palästina-Vereins*). See also M. Casiri, *Bibliotheca Arabico-Hispana Escorialensis* (2 vols., Madrid, 1763-1770); V. Lagus, "Idrisii orientis terrarum Balticarum ex commercis Scandinavorum et Italorum ortum esse" in *Acti del IV<sup>o</sup> Congresso internaz. degli orientalisti in Firenze*, p. 395 (Florence, 1880); K. A. Brandel "Om och ur den arabiske geografen Idrisi," *Akad. afhand.* (Upsala, 1894). (C. R. B.)

**IDUMAEA** (Ἰδουμαία), the Greek equivalent of Edom (עֲדוּם), a territory which, in the works of the Biblical writers, is considered to lie S.E. of the Dead Sea, between the land of Moab and the Gulf of Akaba. Its name, which is connected with the root meaning "red," is probably applied in reference to the red sandstone ranges of the mountains of Petra.<sup>1</sup> This etymology, however, is not certain. The apparently theophorous name Obed-Edom (2 Sam. vi. 10) shows that Edom is the name of a divinity. Of this there is other evidence; a Leiden papyrus names Etum as the wife of the Semitic fire-god Reshu.

The early history of Edom is hidden in darkness. The Egyptian references to it are few, and do not give us much light regarding its early inhabitants. In the early records of the Pentateuch, the country is often referred to by the name of Seir, the general name for the whole range of mountains on the east side of the Jordan-Araba depression south of the Dead Sea. These mountains were occupied, so early as we can find any record, by a cave-dwelling aboriginal race known as Horites, who were smitten by the much-discussed king Chedorloamer (Gen. xiv. 6) and according to Deut. ii. 22 were driven out by the Semitic tribes of Esau's descendants. The Horites are to us little more than a name, though the discovery of cave-dwellers of very early date in Gezer in the excavations of 1902-1905 has enabled us to form some idea as to their probable culture-status and physical character.

The occupants of Edom during practically the whole period of Biblical history were the Bedouin tribes which claimed

descent through Esau from Abraham, and were acknowledged by the Israelites (Deut. xxiii. 7) as kin. That they intermarried with the earlier stock is suggested by the passage in Gen. xxxvi. 2, naming, as one of the wives of Esau, Oholibamah, daughter of Zibeon the Horite (corrected by verse 20). Among the peculiarities of the Edomites was government by certain officials known as שֹׁרֵפִים,<sup>2</sup> which the English versions (by too close a reminiscence of the Vulgate *duces*) translate "dukes." The now naturalized word "sheikhs" would be the exact rendering. In addition to this Bedouin organization there was the curious institution of an elective monarchy, some of whose kings are catalogued in Gen. xxxvi. 31-39 and 1 Chron. i. 43-54. These kings reigned at some date anterior to the time of Saul. No deductions as to their chronology can be based on the silence regarding them in Moses' song, Exodus xv. 15. There was a king in Edom (Num. xx. 14) who refused passage to the Israelites in their wanderings.

The history of the relations of the Edomites and Israelites may be briefly summarized. Saul, whose chief herdsmen, Doeg, was an Edomite (1 Sam. xxi. 7), fought successfully against them (1 Sam. xiv. 47). Joab (1 Kings xi. 16) or Abishai, as his deputy (1 Chron. xviii. 11, 13), occupied Edom for six months and devastated it; it was garrisoned and permanently held by David (2 Sam. vii. 14). But a refugee named Hadad, who escaped as a child to Egypt and grew up at the court of the Egyptian king, returned in Solomon's reign and made a series of reprisal raids on the Israelite territory (1 Kings xi. 14). This did not prevent Solomon introducing Edomites into his harem (1 Kings xi. 1) and maintaining a navy at Ezion-geber, at the head of the Gulf of Akaba (1 Kings ix. 26). Indeed, until the time of Jehoram, when the land revolted (2 Kings viii. 20, 22), Edom was a dependency of Judah, ruled by a viceroy (1 Kings xxii. 47). An attempt at recovering their independence was temporarily quelled in a campaign by Amaziah (2 Kings xiv. 7), and Azariah his successor was able to renew the sea trade of the Gulf of Akaba (2 Kings xiv. 22) which had probably languished since the wreck of Jehoshaphat's ships (1 Kings xxii. 48); but the ancient kingdom had been re-established by the time of Ahaz, and the king's name, Kaush-Malak, is recorded by Tiglath Pileser. He made raids on the territory of Judah (2 Chron. xxviii. 17). The kingdom, however, was short-lived, and it was soon absorbed into the vassalage of Assyria.

The later history of Edom is curious. By the constant western pressure of the eastern Arabs, which (after the restraining force of the great Mesopotamian kingdoms was weakened) assumed irresistible strength, the ancient Edomites were forced across the Jordan-Araba depression, and with their name migrated to the south of western Palestine. In 1 Maccabees v. 65 we find them at Hebron, and this is one of the first indications that we discover of the cis-Jordanic Idumaea of Josephus and the Talmud.

Josephus used the name Idumaea as including not only Gobilatis, the original Mount Seir, but also Amalekitis, the land of Amalek, west of this, and Akrabatis, the ancient Acrabim, S.W. of the Dead Sea. In *War IV. viii. 1*, he mentions two villages "in the very midst of Idumaea," named Betaris and Caphtarobas. The first of these is the modern Beit Jibrin (see ELETHEROPOLIS), the second is Tuffah, near Hebron. Jerome describes Idumaea as extending from Beit Jibrin to Petra, and ascribes the great caves at the former place to cave-dwellers like the aboriginal Horites. Ptolemy's account presents us with the last stage, in which the name Idumaea is entirely restricted to the cis-Jordanic district, and the old trans-Jordanic region is absorbed in Arabia.

The Idumean Antipater was appointed by Julius Caesar procurator of Judaea, Samaria and Galilee, as a reward for services rendered against Pompey. He was the father of Herod the Great, whose family thus was Idumean in origin. (See PALESTINE.) (R. A. S. M.)

<sup>2</sup> The same word is used in the anonymous prophecy incorporated in the book of Zachariah (xii. 5), and in one or two other places as well, of Hebrew leaders.

**IDUN**, or *IDUNA*, in Scandinavian mythology, the goddess of youth and spring. She was daughter of the dwarf Svald and wife of Bragi. She was keeper of the golden apples, the eating of which preserved to the gods their eternal youth. Loki, the evil spirit, kidnapped her and the apples, but was forced by the gods to restore her liberty. Idun personifies the year between March and September, and her myth represents the annual imprisonment of spring by winter.

**IDYL**, or *IDYLL* (Gr. *εἰδύλλιον*, a descriptive piece, from *εἶδος*, a shape or style; Lat. *idyllium*), a short poem of a pastoral or rural character, in which something of the element of landscape is preserved or felt. The earliest commentators of antiquity used the term to designate a great variety of brief and homely poems, in which the description of natural objects was introduced, but the pastoral idea came into existence in connexion with the Alexandrian school, and particularly with Theocritus, Bion and Moschus, in the 3rd century before Christ. It appears, however, that *εἰδύλλιον* was not, even then, used consciously as the name of a form of verse, but as a diminutive of *εἶδος*, and merely signified "a little piece in the style of" whatever adjective might follow. Thus the idyls of the pastoral poets were *εἰδύλλια αἰσθητικὰ*, little pieces in the goatherd style. We possess ten of the so-called "Idyls" of Theocritus, and these are the type from which the popular idea of this kind of poem is taken. But it is observable that there is nothing in the technical character of these ten very diverse pieces which leads us to suppose that the poet intended them to be regarded as typical. In fact, if he had been asked whether a poem was or was not an idyl he would doubtless have been unable to comprehend the question. As a matter of fact, the first of his poems, the celebrated "Dirge for Daphnis," has become the prototype, not of the modern idyl, but of the modern elegy, and the not less famous "Festival of Adonis" is a realistic mime. It was the six little epical romances, if they may be so called, which started the conception of the idyl of Theocritus. It must be remembered, however, that there is nothing in ancient literature which justifies the notion of a form of verse recognized as an "idyl." In the 4th century after Christ the word seems to have become accepted in Latin as covering short descriptive poems of very diverse characters, for the early MSS. of Ausonius contain a section of "Edyllia," which embraces some of the most admirable of the miscellaneous pieces of that writer. But that Ausonius himself called his poems "idyls" is highly doubtful. Indeed, it is not certain that the heading is not a mistake for "Epyllia." The word was revived at the Renaissance and applied rather vaguely to Latin and Greek imitations of Theocritus and of Virgil. It was also applied to modern poems of a romantic and pastoral character published by such writers as Tasso in Italy, Montemayor in Portugal and Ronsard in French. In 1658 the English critic, Edward Phillips, defined an "idyl" as "a kind of eclogue," but it was seldom used to describe a modern poem. Mme Deshoulières published a series of seven *Idylles* in 1675, and Boileau makes a vague reference to the form. The sentimental German idyls of Salomon Gessner (in prose, 1758) and Voss (in hexameters, 1800) were modelled on Theocritus. Goethe's *Alexis und Doro* is an idyl. It appears that the very general use, or abuse, of the word in the second half of the 19th century, both in English and French, arises from the popularity of two works, curiously enough almost identical in date, by two eminent and popular poets. The *Idylles héroïques* (1858) of Victor de Laprade and the *Idylls of the King* (1859) of Tennyson enjoyed a success in either country which led to a wide imitation of the title among those who had, perhaps, a very inexact idea of its meaning. Among modern Germans, Berthold Auerbach and Jeremias Gotthelf have been prominent as the composers of sentimental idyls founded on anecdotes of village-life. On the whole, it is impossible to admit that the idyl has a place among definite literary forms. Its character is vague and has often been purely sentimental, and our conception of it is further obscured by the fact that though the noun carries no bucolic idea with it in English, the adjective

("idyllic") has come to be synonymous with pastoral and rustic. (E. G.)

**IFFLAND, AUGUST WILHELM** (1759-1814), German actor and dramatic author, was born at Hanover on the 10th of April 1759. His father intended his son to be a clergyman, but the boy preferred the stage, and at eighteen ran away to Gotha in order to prepare himself for a theatrical career. He was fortunate enough to receive instruction from Hans Ekhof, and made such rapid progress that he was able in 1779 to accept an engagement at the theatre in Mannheim, then rising into prominence. He soon stood high in his profession, and extended his reputation by frequently playing in other towns. In 1796 he settled in Berlin, where he became director of the national theatre of Prussia; and in 1811 he was made general director of all representations before royalty. Ifland produced the classical works of Goethe and Schiller with conscientious care; but he had little understanding for the drama of the romantic writers. The form of play in which he was most at home, both as actor and playwright, was the domestic drama, the sentimental play of everyday life. His works are almost entirely destitute of imagination; but they display a thorough mastery of the technical necessities of the stage, and a remarkable power of devising effective situations. His best characters are simple and natural, fond of domestic life, but too much given to the utterance of sentimental commonplace. His best-known plays are *Die Jäger*, *Dienstpflicht*, *Die Advokaten*, *Die Mündel* and *Die Hagestolzen*. Ifland was also a dramatic critic, and German actors place high value on the reasonings and hints respecting their art in his *Almanach für Theater und Theaterfreunde*. In 1798-1802 he issued his *Dramatischen Werke* in 16 volumes, to which he added an autobiography (*Meine theatralische Laufbahn*). In 1807-1809 Ifland brought out two volumes of *Neue dramatische Werke*. Selections from his writings were afterwards published, one in 11 (Leipzig, 1827-1828), the other in 10 volumes (Leipzig, 1844, and again 1866). As an actor, he was conspicuous for his brilliant portrayal of comedy parts. His fine gentlemen, polished men of the world, and distinguished princes were models of perfection, and showed none of the traces of elaborate study which were noticed in his interpretation of tragedy. He especially excelled in presenting those types of middle-class life which appear in his own comedies. Ifland died at Berlin on the 22nd of September 1814. A bronze portrait statue of him was erected in front of the Mannheim theatre in 1864.

See K. Duncker, *Ifland in seinen Schriften als Künstler, Lehrer, und Direktor der Berliner Bühne* (1859); W. Koffka, *Ifland und Dalberg* (1865); and Lampe, *Studien über Ifland als Dramatiker* (Celle, 1899). Ifland's interesting autobiography, *Meine theatralische Laufbahn*, was republished by H. Holstein in 1885.

**IGLAU** (Czech *Jihlava*), a town of Austria, in Moravia, 56 n. N.W. of Brünn by rail. Pop. (1900) 24,387, of whom 4200 are Czechs and the remainder Germans. Iglau is situated on the Iglawa, close to the Bohemian frontier, and is one of the oldest towns in Moravia, being the centre of a German-speaking enclave. Among the principal buildings are the churches of St Jakob, St Ignatius, St John and St Paul, the town-hall, and the barracks formed from a monastery suppressed under the emperor Joseph II. There is also a fine cemetery, containing some remarkable monuments. It has the principal tobacco and cigar factory of the state monopoly, which employs about 2500 hands, and has besides a large and important textile and glass industry, corn and saw-mills, pottery and brewing. Fairs are periodically held in the town; and the trade in timber, cereals, and linen and woollen goods is generally brisk.

Iglau is an old mining town where, according to legend, the silver mines were worked so early as 799. King Ottakar I. (1198-1230) established here a mining-office and a mint. At a very early date it enjoyed exceptional privileges, which were confirmed by King Wenceslaus I. in the year 1250. The town-hall contains a collection of municipal and mining laws dating as far back as 1380. At Iglau, on the 6th of July 1436, the treaty was made with the Hussites, by which the emperor Sigismund was acknowledged king of Bohemia. A granite column near the



town marks the spot where Ferdinand I. in 1527, swore fidelity to the Bohemian states. During the Thirty Years' War Iglaui was twice captured by the Swedes. In 1742 it fell into the hands of the Prussians, and in December 1805 the Bavarians under Wrede were defeated near the town.

**IGLESIAS**, a town and episcopal see of Sardinia in the province of Cagliari, from which it is 34 m. W.N.W. by rail, 620 ft. above sea-level. Pop. (1901) 10,436 (town), 20,874 (commune). It is finely situated among the mountains in the S.W. portion of the island, and is chiefly important as the centre of a mining district; it has a government school for mining engineers. The minerals are conveyed by a small railway via Monteponi (with its large lead and zinc mine) to Portovesme (15 m. S.W. of Iglesias in the sheltered gulf of Carloforte), near Portoscuso, where they are shipped. The total amount of the minerals extracted in Sardinia in 1905 was 170,236 tons and their value £765,054 (chiefly consisting of 99,749 tons of calamine zinc, 26,051 of blende zinc, 24,798 tons of lead and 15,429 tons of lignite): the greater part of them—118,000 tons—was exported from Portoscuso by sea and most of the rest from Cagliari, the zinc going mainly to Antwerp, and in a less proportion to Bordeaux and Dunkirk, while the lead is sent to Pertusola near Spiza, to be smelted. At Portoscuso is also a tunny fishery.

The cathedral of Iglesias, built by the Pisans, has a good façade (restored); the interior is late Spanish Gothic. San Francesco is a fine Gothic church with a gallery over the entrance, while Sta Chiara and the church of the Capuchins (the former dating from 1285) show a transition between Romanesque and Gothic. The battlemented town walls are well preserved and picturesque; the castle, built in 1325, now contains a glass factory. The church of Nostra Signora del Buon Cammino above the town (1080 ft.) commands a fine view.

**IGNATIEV, NICHOLAS PAVLOVICH, COUNT (1832-1908)**, Russian diplomatist, was born at St Petersburg on the 20th of January 1832. His father, Captain Paul Ignatiev, had been taken into favour by the tsar Nicholas I, owing to his fidelity on the occasion of the military conspiracy in 1825; and the grand duke Alexander (afterwards tsar) stood sponsor at the boy's baptism. At the age of seventeen he became an officer of the Guards. His diplomatic career began at the congress of Paris, after the Crimean War, where he took an active part as military attaché in the negotiations regarding the rectification of the Russian frontier on the Lower Danube. Two years later (1858) he was sent with a small escort on a dangerous mission to Khiva and Bokhara. The khan of Khiva laid a plan for detaining him as a hostage, but he eluded the danger and returned safely, after concluding with the khan of Bokhara a treaty of friendship. His next diplomatic exploit was in the Far East, as plenipotentiary to the court of Peking. When the Chinese government was terrified by the advance of the Anglo-French expedition of 1860 and the burning of the Summer Palace, he worked on their fears so dexterously that he obtained for Russia not only the left bank of the Amur, the original object of the mission, but also a large extent of territory and sea-coast south of that river. This success was supposed to prove his capacity for dealing with Orientals, and paved his way to the post of ambassador at Constantinople, which he occupied from 1864 till 1877. Here his chief aim was to liberate from Turkish domination and bring under the influence of Russia the Christian nationalities in general and the Bulgarians in particular. His restless activity in this field, mostly of a semi-official and secret character, culminated in the Russo-Turkish war of 1877-1878, at the close of which he negotiated with the Turkish plenipotentiaries the treaty of San Stefano. As the war which he had done so much to bring about did not eventually secure for Russia advantages commensurate with the sacrifices involved, he fell into disfavour, and retired from active service. Shortly after the accession of Alexander III. in 1881, he was appointed minister of the interior on the understanding that he would carry out a nationalist, reactionary policy, but his shifty ways and his administrative incapacity so displeased his imperial

master that he was dismissed in the following year. After that time he exercised no important influence in public affairs. He died on the 3rd of July 1908.

**IGNATIUS (Ἰγνατίος)**, bishop of Antioch, one of the "Apostolic Fathers." No one connected with the history of the early Christian Church is more famous than Ignatius, and yet among the leading churchmen of the time there is scarcely one about whose career we know so little. Our only trustworthy information is derived from the letters which he wrote to various churches on his last journey from Antioch to Rome, and from the short epistle of Polycarp to the Philippians. The earlier patristic writers seem to have known no more than we do. Irenaeus, for instance, gives a quotation from his Epistle to the Romans and does not appear to know (or if he knew he has forgotten) the name of the author, since he describes him (*Adv. haer.* v. 28. 4) as "one of those belonging to us" (τῶν ἡμετέρων). If Eusebius possessed any knowledge about Ignatius apart from the letters he never reveals it. The only shred of extra information which he gives us is the statement that Ignatius "was the second successor of Peter in the bishopric of Antioch" (*Eccles. hist.* iii. 36). Of course in later times a cloud of tradition arose, but none of it bears the least evidence of trustworthiness. The martyrologies, from which the account of his martyrdom that used to appear in uncritical church histories is taken, are full of anachronisms and impossibilities. There are two main types—the Roman and the Syrian—out of which the others are compounded. They contradict each other in many points and even their own statements in different places are sometimes quite irreconcilable. Any truth that the narrative may contain is hopelessly overlaid with fiction. We are therefore limited to the Epistles for our information, and before we can use even these we are confronted with a most complex critical problem, a problem which for ages aroused the most bitter controversy, but which happily now, thanks to the labours of Zahn, Lightfoot, Harnack and Funk, may be said to have reached a satisfactory solution.

1. *The Problem of the Three Recensions.*—The Ignatian problem arises from the fact that we possess three different recensions of the Epistles. (a) *The short recension* (often called the Vossian) contains the letters to the Ephesians, Magnesians, Trallians, Romans, Philadelphians, Smyrnaeans and to Polycarp. This recension was derived in its Greek form from the famous Medicean MS. at Florence and first published by Vossius in 1646 (see *Theol. Literaturzeitung*, 1906, 596 f., for an early papyrus fragment in the Berlin Museum, containing *Ad Smyrn.* iii. *fin.* xii. *init.*). In the Medicean MS. the Epistle to the Romans is missing, but a Greek version of this epistle was discovered by Ruinart, embedded in a *martyrium*, in the National Library at Paris and published in 1689. There are also (1) a Latin version made by Robert Grosseteste, bishop of Lincoln, about 1250, and published by Ussher in 1644—two years before the Vossian edition appeared; (2) an Armenian version which was derived from a Syriac not earlier than the 5th century and published at Constantinople in 1783; (3) some fragments of a Syriac version published in Cureton's edition of Ignatius; (4) fragments of a Coptic version first published in Lightfoot's work (ii. 850-882). (b) *The long recension* contains the seven Epistles mentioned above in an expanded form and several additional letters besides. The Greek form of the recension, which has been preserved in ten MSS., has thirteen letters, the additional ones being to the Tarsians, the Philippians, the Antiochians, to Hero, to Mary of Cassobola and a letter of Mary to Ignatius. The Latin form, of which there are thirteen extant MSS., omits the letter of Mary of Cassobola, but adds to the list the Laus Heronis, two Epistles to the apostle John, one to the Virgin Mary and one from Mary to Ignatius. (c) *The Syriac or Curetonian recension* contains only three Epistles, viz. to Polycarp, to the Romans, and to the Ephesians, and these when compared with the same letters in the short and long recensions are found to be considerably abbreviated. The Syriac recension was made by William Cureton in 1845 from three Syriac MSS. which had recently been brought from the

Nitrian desert and deposited in the British Museum. One of these MSS. belongs to the 6th century, the other two are later. Summed up in a word, therefore, the Ignatian problem is this: which of these three recensions (if any) represents the actual work of Ignatius?

II. *History of the Controversy.*—The history of the controversy may be divided into three periods: (a) up to the discovery of the short recension in 1646; (b) between 1646 and the discovery of the Syriac recension in 1845; (c) from 1845 to the present day. In the first stage the controversy was theological rather than critical. The Reformation raised the question as to the authority of the papacy and the hierarchy. Roman Catholic scholars used the interpolated Ignatian Epistles very freely in their defence and derived many of their arguments from them, while Protestant scholars threw discredit on these Epistles. The Magdeburg centurions expressed the gravest doubts as to their genuineness, and Calvin declared that "nothing was more foul than those fairy tales (*naeniis*) published under the name of Ignatius!" It should be stated, however, that one Roman Catholic scholar, Denys Petau (Petavius), admitted that the letters were interpolated, while the Protestant Vedellius acknowledged the seven letters mentioned by Eusebius. In England the Ignatian Epistles took an important place in the episcopal controversy in the 17th century. Their genuineness was defended by the leading Anglican writers, e.g. Whitgift, Hooker and Andrewes, and vigorously challenged by Dissenters, e.g. the five Presbyterian ministers who wrote under the name of Smectymnus and John Milton.<sup>1</sup> The second period is marked by the recognition of the superiority of the Vossian recension. This was speedily demonstrated, though some attempts were made, notably by Jean Morin or Morinus (about 1656). Whiston (in 1711) and Meier (in 1836), to resuscitate the long recension. Many Protestants still maintained that the new recension, like the old, was a forgery. The chief attack came from Jean Daillé, who in his famous work (1666) drew up no fewer than sixty-six objections to the genuineness of the Ignatian literature. He was answered by Pearson, who in his *Indicæ epistolæ S. Ignatii* (1672) completely vindicated the authenticity of the Vossian Epistles. No further attack of any importance was made till the time of Baur, who like Daillé rejected both recensions. In the third stage—inaugurated in 1845 by Cureton's work—the controversy has ranged round the relative claims of the Vossian and the Curetonian recensions. Scholars have been divided into three camps, viz. (1) those who followed Cureton in maintaining that the three Syriac Epistles alone were the genuine work of Ignatius. Among them may be mentioned the names of Bunsen, A. Ritschl, R. A. Lipsius, E. de Pressensé, H. Ewald, Milman, Bohringer. (2) Those who accepted the genuineness of the Vossian recension and regarded the Curetonian as an abbreviation of it, e.g. Petermann, Denzinger, Uhlhorn, Merx, and in more recent times Th. Zahn, J. B. Lightfoot, Ad. Harnack and F. X. Funk. (3) Those who denied the authenticity of both recensions, e.g. Baur and Hilgenfeld and in recent times van Manen,<sup>2</sup> Völter<sup>3</sup> and van Loon.<sup>4</sup> The result of more than half a century's discussion has been to restore the Vossian recension to the premier position.

III. *The Origin of the Long Recension.*—The arguments against the genuineness of the long recension are decisive. (1) It conflicts with the statement of Eusebius. (2) The first trace of its use occurs in Anastasius of Antioch (A.D. 508) and Stephen Gobarus (c. 575–600). (3) The ecclesiastical system of the letters implies a date not earlier than the 4th century. (4) The recension has been proved to be dependent on the *Apotolical Constitutions*. (5) The doctrinal atmosphere implies the existence of Arian and Apollinarian heresies. (6) The added passages reveal a difference in style which stamps them at once as interpolations. There are several different theories

with regard to the origin of the recension. Some, e.g. Leclerc, Newman and Zahn, think that the writer was an Arian and that the additions were made in the interest of Arianism. Funk, on the other hand, regards the writer as an Apollinarian. Lightfoot opposes both views and suggests that it is better "to conceive of him as writing with a conciliatory aim."

IV. *The Objections to the Curetonian Recension.*—The objections to the Syriac recension, though not so decisive, are strong enough to carry conviction with them. (1) We have the express statement of Eusebius that Ignatius wrote seven Epistles. (2) There are statements in Polycarp's Epistle which cannot be explained from the three Syriac Epistles. (3) The omitted portions are proved by Lightfoot after an elaborate analysis to be written in the same style as the rest of the epistles and could not therefore have been later interpolations. (4) The Curetonian letters are often abrupt and broken and show signs of abridgment. (5) The discovery of the Armenian version proves the existence of an earlier Syriac recension corresponding to the Vossian of which the Curetonian may be an abbreviation. It seems impossible to account for the origin of the Curetonian recension on theological grounds. The theory that the abridgment was made in the interests of Eutychnianism or Monophysitism cannot be substantiated.

V. *The Date and Genuineness of the Vossian Epistles.*—We are left therefore with the seven Epistles. Are they the genuine work of Ignatius, and, if so, at what date were they written? The main objections are as follows: (1) The conveyance of a condemned prisoner to Rome to be put to death in the amphitheatre is unlikely on historical grounds, and the route taken is improbable for geographical reasons. This objection has very little solid basis. (2) The heresies against which Ignatius contends imply the rise of the later Gnostic and Docetic sects. It is quite certain, however, that Docetism was in existence in the 1st century (cf. 1 John), while many of the principles of Gnosticism were in vogue long before the great Gnostic sects arose (cf. the Pastoral Epistles). There is nothing in Ignatius which implies a knowledge of the teaching of Basilides or Valentinus. In fact, as Harnack says: "No Christian writer after 140 could have described the false teachers in the way that Ignatius does." (3) The ecclesiastical system of Ignatius is too developed to have arisen as early as the time of Trajan. At first sight this objection seems to be almost fatal. But we have to remember that the bishops of Ignatius are not bishops in the modern sense of the word at all, but simply pastors of churches. They are not mentioned at all in two Epistles, viz. *Romans* and *Philippians*, which seems to imply that this form of government was not universal. It is only when we read modern ecclesiastical ideas into Ignatius that the objection has much weight. To sum up, as Uhlhorn says: "The collective mass of internal evidence against the genuineness of the letters ... is insufficient to counterbalance the testimony of the Epistle of Polycarp in their favour. He who would prove the Epistles of Ignatius to be spurious must begin by proving the Epistle of Polycarp to be spurious, and such an undertaking is not likely to succeed." This being so, there is no reason for rejecting the opinion of Eusebius that the Epistles were written in the reign of Trajan. Harnack, who formerly dated them about 140, now says that they were written in the latter years of Trajan, or possibly a little later (117–125). The majority of scholars place them a few years earlier (110–117).<sup>5</sup>

The letters of Ignatius unfortunately, unlike the Epistles of St Paul, contain scant autobiographical material. We are told absolutely nothing about the history of his career. The fact that like St Paul he describes himself as an *εκρούα* (*Rom. 9*), and that he speaks of himself as "the last of the Antiochene Christians" (*Trall. 13; Smyrna. xi.*), seems to suggest that he had been converted from paganism somewhat late in life and that the process of conversion had been abrupt and violent. He bore the surname of Theophorus, i.e. "God-clad" or "bearing

<sup>1</sup> In his short treatise "Of Prelatical Episcopacy," works iii. p. 72 (Pickering, 1851).

<sup>2</sup> *Theologisch. Tijdschrift* (1892), 625–633.

<sup>3</sup> *Ib.* (1886) 114–136; *Die Ignatianischen Briefe* (1892).

<sup>4</sup> *Ib.* (1893) 275–316.

<sup>5</sup> But there are still a few scholars, e.g. van Manen and Völter, who prefer a date about 150 or later; van Loon goes as late as 175. See article "Old-Christian Literature," *Ency. Bib.* iii. col. 3488.

God." Later tradition regarded the word as a passive form ("God-borne") and explained it by the romantic theory that Ignatius was the child whom Christ took in his arms (Mark ix. 36-37). The date at which he became bishop of Antioch cannot be determined. At the time when the Epistles were written he had just been sentenced to death, and was being sent in charge of a band of soldiers to Rome to fight the beasts in the amphitheatre. The fact that he was condemned to the amphitheatre proves that he could not have been a Roman citizen. We lose sight of him at Tros, but the presumption is that he was martyred at Rome, though we have no early evidence of this.

But if the Epistles tell us little of the life of Ignatius, they give us an excellent picture of the man himself, and are a mirror in which we see reflected certain ideals of the life and thought of the day. Ignatius, as Schaff says, "is the incarnation of three closely connected ideas: the glory of martyrdom, the omnipotence of episcopacy, and the hatred of heresy and schism."

1. Zeal for martyrdom in later days became a disease in the Church, but in the case of Ignatius it is the mark of a hero. The heroic note runs through all the Epistles; thus he says:

"I bid all men know that of my own free will I die for God, unless ye should hinder me. . . . Let me be given to the wild beasts, for through them I can attain unto God. I am God's wheat, and I am ground by the wild beasts that I may be found the pure bread of Christ. Entice the wild beasts that they may become my sepulchre . . . ; come fire and cross and grapplings with wild beasts, wrenching of bones, hacking of limbs, crushings of my whole body; only be it mine to attain unto Jesus Christ" (*Rom.* 4-5).

2. Ignatius constantly contends for the recognition of the authority of the ministers of the church. "Do nothing," he writes to the Magnesians, "without the bishop and the presbyters." The "three orders" are essential to the church, without them no church is worthy of the name (cf. *Trall.* 3). "It is not lawful apart from the bishop either to baptize or to hold a love-feast" (*Smyrn.* 8). Respect is due to the bishop as to God, to the presbyters as the council of God and the college of apostles, to the deacons as to Jesus Christ (*Trall.* 3). These terms must not, of course, be taken in their developed modern sense. The "bishop" of Ignatius seems to represent the modern pastor of a church. As Zahn has shown, Ignatius is not striving to introduce a special form of ministry, nor is he endeavouring to substitute one form for another. His particular interest is not so much in the form of ministry as in the unity of the church. It is this that is his chief concern. Centrifugal forces were at work. Differences of theological opinion were arising. Churches had a tendency to split up into sections. The age of the apostles had passed away and their successors did not inherit their authority. The unity of the churches was in danger. Ignatius was resisting this fatal tendency which threatened ruin to the faith. The only remedy for it in those days was to exalt the authority of the ministry and make it the centre of church life. It should be noted that (1) there is no trace of the later doctrine of apostolical succession; (2) the ministry is never sacerdotal in the letters of Ignatius. As Lightfoot puts it: "The ecclesiastical order was enforced by him (Ignatius) almost solely as a security for doctrinal purity. The threefold ministry was the husk, the shell, which protected the precious kernel of the truth" (i. 40).

3. Ignatius fights most vehemently against the current forms of heresy. The chief danger to the church came from the Docetists who denied the reality of the humanity of Christ and ascribed to him a phantom body. Hence we find Ignatius laying the utmost stress on the fact that Christ "was truly born and ate and drank, was truly persecuted under Pontius Pilate . . . was truly raised from the dead" (*Trall.* 6). "I know that He was in the flesh even after the resurrection, and when He came to Peter and his company, He said to them, 'Lay hold and handle me, and see that I am not an incorporeal spirit'" (*Smyrn.* 3). Equally emphatic is Ignatius's protest against a return to Judaism. "It is monstrous to talk of Jesus Christ and to practise Judaism, for Christianity did not believe in Judaism but Judaism in Christianity" (*Magn.* 10).

Reference must also be made to a few of the more characteristic points in the theology of Ignatius. As far as Christology is

concerned, besides the insistence on the reality of the humanity of Christ already mentioned, there are two other points which call for notice. (1) Ignatius is the earliest writer outside the New Testament to describe Christ under the categories of current philosophy; cf. the famous passage in *Eph.* 7. "There is one only physician, of flesh and of spirit (*σαρκός και πνευματός*), generate and ingenerate (*γεννητός και άγεννητός*), God in man, true life in death, son of Mary and son of God, first passible and then impassible" (*πρώτος παθός και άπαθός*). (2) Ignatius is also the first writer outside the New Testament to mention the Virgin Birth, upon which he lays the utmost stress. "Hidden from the prince of this world were the virginity of Mary and her child-bearing and likewise also the death of the Lord, three mysteries to be cried aloud, the which were wrought in the silence of God" (*Eph.* 19). Here, it will be observed, we have the nucleus of the later doctrine of the deception of Satan. In regard to the Eucharist also later ideas occur in Ignatius. It is termed a *μυστήριον* (*Trall.* 2), and the influence of the Greek mysteries is seen in such language as that used in *Eph.* 20, where Ignatius describes the Eucharistic bread as "the medicine of immortality and the antidote against death." When Ignatius says too that "the heretics abstain from Eucharist because they do not allow that the Eucharist is the flesh of Christ," the words seem to imply that materialistic ideas were beginning to find an entrance into the church (*Smyrn.* 6). Other points that call for special notice are: (1) Ignatius's rather extravagant angelology. In one place for instance he speaks of himself as being able to comprehend heavenly things and "the arrays of angels and the musterings of principalities" (*Trall.* 5). (2) His view of the Old Testament. In one important passage Ignatius emphatically states his belief in the supremacy of Christ even over "the archives" of the faith, i.e. the Old Testament: "As for me, my archives—my inviolable archives—are Jesus Christ, His cross, His death, His resurrection and faith through Him" (*Philadelph.* 8).

AUTHORITIES.—T. Zahn, *Ignatius von Antiochien* (Gotha, 1873); J. B. Lightfoot, *Apostolic Fathers*, part II. (London, 2nd ed., 1889); F. X. Funk, *Die Echtheit der ignat. Briefe* (Tübingen, 1892); A. Harnack, *Chronologie der altchristlichen Literatur* (Leipzig, 1897). There is a good bibliography in G. Krüger, *Early Christian Literature* (Eng. trans., 1897, pp. 28-29). See also APOSTOLIC FATHERS.

(H. T. A.)

**IGNORAMUS** (Latin for "we do not know," "we take no notice of"), properly an English law term for the endorsement on the bill of indictment made by a grand jury when they "throw out" the bill, i.e. when they do not consider that the case should go to a petty jury. The expression is now obsolete, "not a true bill," "no bill," being used. The expressions "ignoramus jury," "ignoramus Whig," &c., were common in the political satires and pamphlets of the years following on the throwing out of the bill for high treason against the 2nd earl of Shaftesbury in 1681. The application of the term to an ignorant person dates from the early part of the 17th century. The *New English Dictionary* quotes two examples illustrating the early connexion of the term with the law or lawyers. George Ruggle (1575-1622) in 1615 wrote a Latin play with the title *Ignoramus*, the name being also that of the chief character in it, intended for one Francis Brakin, the recorder of Cambridge. It is a satire against the ignorance and pettifoggery of the common lawyers of the day. It was answered by a prose tract (not printed till 1648) by one Robert Callis, sergeant-at-law. This bore the title *The Case and Argument against Sir Ignoramus of Cambridge*.

**IGNORANCE** (Lat. *ignorantia*, from *ignorare*, not to know), want of knowledge, a state of mind which in law has important consequences. A well-known legal maxim runs: *ignorantia juris non excusat* ("ignorance of the law does not excuse"). With this is sometimes coupled another maxim: *ignorantia facti excusat* ("ignorance of the fact excuses"). That every one who has capacity to understand the law is presumed to know it is a very necessary principle, for otherwise the courts would be continually occupied in endeavouring to solve problems which by their very impracticability would render the administration of justice next to impossible. It would be necessary for the

court to engage in endless inquiries as to the true inwardness of a man's mind, whether his state of ignorance existed at the time of the commission of the offence, whether such a condition of mind was inevitable or brought about merely by indifference on his part. Therefore, in English, as in Roman law, ignorance of the law is no ground for avoiding the consequences of an act. So far as regards criminal offences, the maxim as to *ignorantia juris* admits of no exception, even in the case of a foreigner temporarily in England, who is likely to be ignorant of English law. In Roman law the harshness of the rule was mitigated in the case of women, soldiers and persons under the age of twenty-five, unless they had good legal advice within reach (*Dig. xxii. 6. 9*). Ignorance of a matter of fact may in general be alleged in avoidance of the consequences of acts and agreements, but such ignorance cannot be pleaded where it is the duty of a person to know, or where, having the means of knowledge at his disposal, he wilfully or negligently fails to avail himself of it (see CONTRACT).

In logic, ignorance is that state of mind which for want of evidence is equally unable to affirm or deny one thing or another. Doubt, on the other hand, can neither affirm nor deny because the evidence seems equally strong for both. For *Ignoratio Elenchi* (ignorance of the refutation) see FALLACY.

**IGNORANTINES** (*Frères Ignorantins*), a name given to the Brethren of the Christian Schools (*Frères des Écoles Chrétiennes*), a religious fraternity founded at Reims in 1680, and formally organized in 1683, by the priest Jean Baptiste de la Salle, for the purpose of affording a free education, especially in religion, to the children of the poor. In addition to the three simple vows of chastity, poverty and obedience, the brothers were required to give their services without any remuneration and to wear a special habit of coarse black material, consisting of a cassock, a hooded cloak with hanging sleeves and a broad-brimmed hat. The name Ignorantine was given from a clause in the rules of the order forbidding the admission of priests with a theological education. Other popular names applied to the order are *Frères de Saint-You*, from the house at Rouen, which was their headquarters from 1705 till 1770, *Frères à quatre bras*, from their hanging sleeves, and *Frères Fouetteurs*, from their former use of the whip (*fouet*) in punishments. The order, approved by Pope Benedict XIII. in 1724, rapidly spread over France, and although dissolved by the National Assembly's decree in February 1790, was recalled by Napoleon I. in 1804, and formally recognized by the French government in 1808. Since then its members have penetrated into nearly every country of Europe, and into America, Asia and Africa. They number about 14,000 members and have over 2000 schools, and are the strongest Roman Catholic male order. Though not officially connected with the Jesuits, their organization and discipline are very similar.

See J. B. Blain, *La Vie du vénérable J. B. de la Salle* (Versailles, 1887).

**IGUALADA**, a town of north-eastern Spain, in the province of Barcelona, on the left bank of the river Noya, a right-hand tributary of the Llobregat, and at the northern terminus of the Igualada-Martorell-Barcelona railway. Pop. (1900) 10,442. Igualada is the central market of a rich agricultural and wine-producing district. It consists of an old town with narrow and irregular streets and the remains of a fortress and ramparts, and a new town which possesses regular and spacious streets and many fine houses. The local industries, chiefly developed since 1880, include the manufacture of cotton, linen, wool, ribbons, cloth, chocolate, soap, brandies, leather, cards and nails. The famous mountain and convent of Montserrat or Monserrat (*q.v.*) is 12 m. E.

**IGUANA**, systematically *Iguanidae* (Spanish equivalent of Carib *iguana*), a family of pleurodont lizards, comprising about 50 genera and 300 species. With three exceptions, all the genera of this extensive family belong to the New World, being specially characteristic of the Neotropical region, where they occur as far south as Patagonia, while extending northward into the warmer parts of the Nearctic regions as far as California and

British Columbia. The exceptional genera are *Brachylophus* in the Fiji Islands, *Hopliurus* and *Chalarodon* in Madagascar. The iguanas are characterized by the peculiar form of their teeth, these being round at the root and blade-like, with serrated edges towards the tip, resembling in this respect the gigantic extinct reptile *Iguanodon*. The typical forms belonging to this family are distinguished by the large dewlap or pouch situated beneath the head and neck, and by the crest, composed of slender elongated scales, which extends in gradually diminishing height from the nape of the neck to the extremity of the tail. The latter organ is very long, slender and compressed. The tongue is generally short and not deeply divided at its extremity, nor is its base retracted into a sheath; it is always moist and covered with a glutinous secretion. The prevailing colour of the iguanas is green; and, as the majority of them are arboreal in their habits, such colouring is generally regarded as pro-

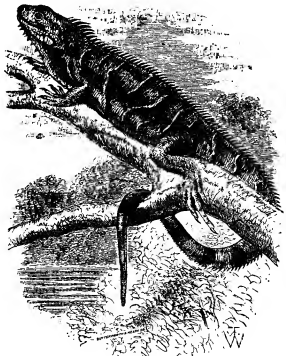

FIG. 1.—Iguana.

tective. Those on the other hand which reside on the ground have much duller, although as a rule equally protective hues. Some iguanas, however (e.g. *Anolis carolinensis*), possess, to an extent only exceeded by the chameleon, the power of changing their colours, their brilliant green becoming transformed under the influence of fear or irritation, into more sombre hues and even into black. They differ greatly in size, from a few inches to several feet in length.

One of the largest and most widely distributed is the common iguana (*Iguana tuberculata*), which occurs in the tropical parts of Central and South America and the West Indies, with the closely allied *I. rhinolephus*. It attains a length of 6 ft., weighing then perhaps 30 lb. and is of a greenish colour, occasionally mixed with brown, while the tail is surrounded with alternate rings of those colours. Its food consists of vegetable substances, mostly leaves, which it obtains from the forest trees among whose branches it lives and in the hollows of which it deposits its eggs. These are of an oblong shape about 1½ in. in length, and are said by travellers to be very pleasant eating, especially when taken raw, and mixed with farina. They are timid, defenceless animals, depending for safety on the comparative inaccessibility of their arboreal haunts, and their protective colouring, which is rendered even more effective by their remaining still on the approach of danger. But the favourite resorts of the iguana are trees which overhang the

water, into which they let themselves fall with a splash, whatever the height of the tree, and then swim away, or hide at the bottom for many minutes. Otherwise they exhibit few signs of animal intelligence. "The iguana," says H. W. Bates (*The Naturalist on the Amazons*), "is one of the stupidest animals I ever met. The one I caught dropped helplessly from a tree just ahead of me; it turned round for a moment to have an idiotic stare at the intruder and then set off running along the path. I ran

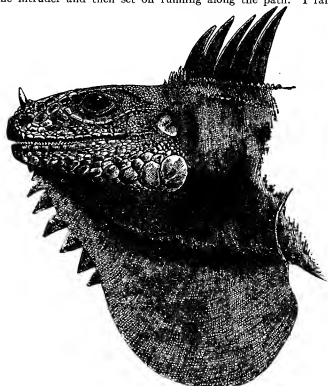

FIG. 2.—Head of *Iguana rhinolophus*.

after it and it then stopped as a timid dog would do, crouching down and permitting me to seize it by the neck and carry it off." Along with several other species, notably *Ctenosura aconthinura*, which is omnivorous, likewise called iguana, the common iguana, is much sought after in tropical America; the natives esteem its flesh a delicacy, and capture it by slipping a noose round its neck as it sits in fancied security on the branch of a tree.

Although chiefly arboreal, many of the iguanas take readily to the water; and there is at least one species, *Amblyrhynchus cristatus*, which leads for the most part an aquatic life. These marine lizards occur only in the Galapagos Islands, where they are never seen more than 20 yds. inland, while they may often be observed in companies several hundreds of yards from the shore, swimming with great facility by means of their flattened tails. Their feet are all more or less webbed, but in swimming they are said to keep these organs motionless by their sides. Their food consists of marine vegetation, to obtain which they dive beneath the water, where they are able to remain, without coming to the surface to breathe, for a very considerable time. Though they are thus the most aquatic of lizards, Darwin, who studied their habits during his visit to those islands, states that when frightened they will not enter the water. Driven along a narrow ledge of rock to the edge of the sea, they preferred capture to escape by swimming, while if thrown into the water they immediately returned to the point from which they started. A land species belonging to the allied genus *Conolophus* also occurs in the Galapagos, which differs from most of its kind in forming burrows in the ground.

**IGUANODON**, a large extinct herbivorous land reptile from the Wealden formation of western Europe, almost completely known by numerous skeletons from Bernissart, near Mons, Belgium. It is a typical representative of the ornithomimid (Gr. for bird-footed) Dinosauria. The head is large and laterally compressed with a blunt snout, nearly terminal nostrils and relatively small eyes. The sides of the jaws are provided with a close series of grinding teeth, which are often worn down to stumps; the front of the jaws forms a toothless beak, which would be encased originally in a horny sheath. When unworn the teeth are spatulate and crimped or serrated round the edge, closely resembling those of the existing Central American lizard, *Iguana*—hence the name *Iguanodon* (Gr. Iguana-tooth) proposed by Mantell, the discoverer of this reptile, in 1825. The bodies of the vertebrae are solid; and they are convexo-concave (i.e. *opisthocœlous*) in the neck and anterior part of the back, where there must have been much freedom of motion. The hindquarters are comparatively large and heavy, while the tail is long, deep and more or less laterally compressed, evidently adapted for swimming. The small and mobile forelimbs bear four complete fingers, with the thumb reduced to a bony spur. The pelvis and hind-limbs much resemble those of a running bird, such as those of an emu or the extinct moa; but the basal bones (metatarsals) of the three-toed foot remain separate throughout life, thus differing from those of the running birds, which are firmly fused together even in the young adult. No external armour has been found. The reptile doubtless frequented marshes, feeding on the succulent vegetation, and often swimming in the water. Footprints prove that when on land it walked habitually on its hind-limbs.

The earliest remains of *Iguanodon* were found by Dr G. A. Mantell in the Wealden formation of Sussex, and a large part of the skeleton, lacking the head, was subsequently discovered in a block of ragstone in the Lower Greensand near

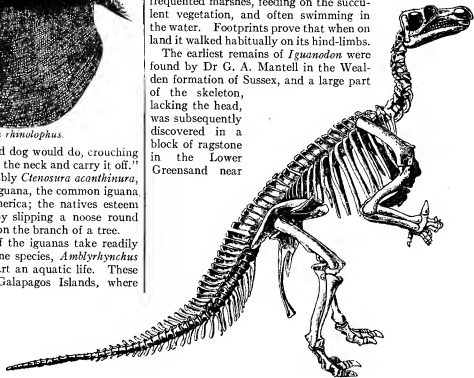

Skeleton of *Iguanodon bernissartensis*. (After Dollo.)

Maidstone, Kent. These fossils, which are now in the British Museum, were interpreted by Dr Mantell, who made comparisons with the skeleton of *Iguana*, on the erroneous supposition that the resemblance in the teeth denoted some relationship to this existing lizard. Several of the bones, however, could not be understood until the much later discoveries of Mr S. H. Beckles in the Wealden cliffs near Hastings; and an accurate knowledge of the skeleton was only obtained when many complete specimens were disinterred by the Belgian government from the Wealden beds at Bernissart, near Mons, during the years 1877-1880. These skeletons, which now form the most striking feature of the Brussels Museum, evidently represent a large troop of animals which were suddenly destroyed and buried in a deep

ravine or gully. The typical species, *Iguanodon mantelli*, measures 5 to 6 metres in length, while *I. bernissartensis* (see fig.) attains a length of 8 to 10 metres. They are found both at Bernissart and in the south of England, while other species are also known from Sussex. Nearly complete skeletons of allied reptiles have been discovered in the Jurassic and Cretaceous rocks of North America.

REFERENCES.—G. A. Mantell, *Petrefactions and their Teaching* (London, 1851); L. Dollo, papers in *Bull. Mus. Roy. d'Hist. Nat. Belg.*, vols. I-III. (1882-1884). (A. S. Wo.)

**IGUVIUM** (mod. Gubbio, *q.v.*), a town of Umbria, situated among the mountains, about 23 m. N.N.E. of Perugia and connected with it by a by-road, which joined the Via Flaminia near the temple of Jupiter Appenninus, at the modern Sceggia. It appears to have been an important place in pre-Roman times, both from its coins and from the celebrated *tabulae Iguvinae* (see below).

We find it in possession of a treaty with Rome, similar to that of the Camertes Umbri; and in 167 B.C. it was used as a place of safe custody for the Illyrian King Gentius and his sons (Liv. xlv. 43). After the Social War, in which it took no part, it received Roman citizenship. At that epoch it must have received full citizen rights since it was included in the tribus Clustumina (C.I.L. xi. e.g. 5838). In 49 B.C. it was occupied by Minucius Thermus on behalf of Pompey, but he abandoned the town. Under the empire we hear almost nothing of it. Silius Italicus mentions it as subject to fogs. A bishop of Iguvium is mentioned as early as A.D. 413. It was taken and destroyed by the Goths in 552, but rebuilt with the help of Narses. The Umbrian town had three gates only, and probably lay on the steep mountain side as the present town does, while the Roman city lay in the lower ground. Here is the theatre, which, as an inscription records, was restored by Cn. Satrius Rufus in the time of Augustus. The diameter of the orchestra is 76½ ft. and of the whole 230 ft., so that it is a building of considerable size; the stage is well preserved and so are parts of the external arcades of the auditorium. Not far off are ruins probably of ancient baths, and the concrete core of a large tomb with a vaulted chamber within. (T.As.)

Of Latin inscriptions (C.I.L. xi. 5803-5026) found at Iguvium two or three are of Augustan date, but none seem to be earlier. A Latin inscription of Iguvium (C.I.L. xi. 5824) mentions a priest whose functions are characteristic of the place "L. Veturius Rufio avisep extispicus, sacerdos publicus et privatus."

The ancient town is chiefly celebrated for the famous *Iguvine* (less correctly *Engubine*) *Tables*, which were discovered there in 1444, bought by the municipality in 1456, and are still preserved in the town hall. A Dominican, Leandro Alberti (*Descrizione d'Italia*, 1550), states that they were originally nine in number, and an independent authority, Antonio Concioli (*Statiuta civitatis Engubini*, 1673), states that two of the nine were taken to Venice in 1540 and never reappeared. The existing seven were first published in a careful but largely mistaken transcript by Buonarroti in 1724, as an appendix to Dempster's *De Etruria Regali*.

The first real advance towards their interpretation was made by Otfried Müller (*Die Etrusker*, 1828), who pointed out that though their alphabet was akin to the Etruscan their language was Italic. Lepsius, in his essay *De tabulis Engubinis* (1833), finally determined the value of the Umbrian signs and the received order of the *Tables*, pointing out that those in Latin alphabet were the latest. He subsequently published what may be called the *editio princeps* in 1841. The first edition, with a full commentary based on scientific principles, was that of Aufrecht and Kirchhoff in 1849-1851, and on this all subsequent interpretations are based (Bréal, Paris, 1875; Bücheler, *Umbriana*, Bonn, 1883, a reprint and enlargement of articles in *Fleckenstein's Jahrbuch*, 1875, pp. 127 and 313). The text is everywhere perfectly legible, and is excellently represented in photographs by the marquis Ranghiasi-Braleone, published with Bréal's edition.

<sup>1</sup>A portion of this article is taken by permission from R. S. Conway's *Italic Dialects* (Camb. Univ. Press, 1897).

*Language*.—The dialect in which this ancient set of liturgies is written is usually known as Umbrian, as it is the only monument we possess of any length of the tongue spoken in the Umbrian district before it was latinized (see UMBRIA). The name, however, is certainly too wide, since an inscription from Tuder of, probably, the 3rd century B.C. (R. S. Conway, *The Italic Dialects*, 352) shows a final *-s* and a medial *-d*, both apparently preserved from the changes which befall these sounds, as we shall see, in the dialect of Iguvium. On the other hand, inscriptions of Fulginia and Assisium (*ibid.*, 354-355) agree very well, so far as they go, with Iguvine. It is especially necessary to make clear that the language known as Umbrian is that of a certain limited area, which cannot yet be shown to have extended very far beyond the eastern half of the Tiber valley (from Interamna Nahartium to Urvinum Mataurense), because the term is often used by archaeologists with a far wider connotation to include all the Italic pre-Etruscan inhabitants of upper Italy; for instance, for instance, in his *Early Age of Greece*, frequently speaks of the "Umbrians" as the race to which belonged the Villanova culture of the Early Iron age. It is now one of the most urgent problems in the history of Italy to determine the actual historical relation (see further *ROME: History, ad. init.*) between the *Ouphoi* of, say, Herodotus and the language of Iguvium, of which we may now offer some description, using the term Umbrian strictly in this sense.

Under the headings LATIN LANGUAGE and OSCA LINGUA there have been collected (1) the points which separate all the Italic languages from their nearest congeners, and (2) those which separate Oscan-Umbrian from Latin. We have now to notice (3) the points in which Umbrian has diverged from Oscan. The first of them antedates by six or seven centuries the similar change in the Romance languages (see ROMANCE LANGUAGES).

(1) The palatalization of *k* and *g* before a following *i* or *e*, or consonant *i* as in *digit* (i.e. *digit*) = Lat. *decet*; *miueto* past part. passed on pronounced as though the *i* were an English or French *j* beside Umb. imperative *miugiu*, Lat. *mugis*.

(2) The loss of final-*d*, e.g. in the abl. sing. fem. Umb. *tiōs* = Oscan. *tōad*.

(3) The change of *q* between vowels to a sound akin to *r*, written by a special symbol  $\rho$  ( $\rho$ ) in Umbrian alphabet and by RS in Latin alphabet, e.g. *teda* in Umbrian alphabet = *dirsa* in Latin alphabet (see below), "let him give," exactly equivalent to Paaliginian *didā* (see *PAELIGINI*).

(4) The change of *-s-* to *-r-* between vowels as in *erom*, "esse" = Oscan. *erom*, and the gen. plur. fem. ending in *-aru* = Lat. *-arum*, Oscan. *-azum*.

To this there appear a long string of exceptions, e.g. *asa* = Lat. *ara*. These are generally regarded as mere archaisms, and unfortunately the majority of them are in words of whose origin and meaning very little is known, so that (for all we can tell) in many of the *-s-* may represent *-ss-* or *-ps-* as in *osatu* = Lat. *operato*, cf. Oscan. *opsaum*.

(5) The change of final *-ns* to *-f* as in the acc. plur. masc. *viufuf* = Lat. *viuifus*.

(6) In the latest stage of the dialect (see below) the change of final *-s* to *-r*, as in abl. plur. *arver*, *arriis*, i.e. "arvorum frugibus."

(7) The decay of all diphthongs; *ai*, *oi*, *ei* all become a monophthong variously written as *e* and *i* (rarely *ei*), as in the dat. sing. fem. *tote*, "civitati"; dat. sing. masc. *poplo*, "populo"; loc. sing. masc. *onse* (from *omē*?) "in umero." So *asu*, *eu*, *ou* all become *ā*, as in *ote* = Oscan. *atū*, Lat. *aut*.

(8) The change of initial *l* to *e*, as in *vutu* = Lat. *lavitio*.

Owing to the peculiar character of the *Tables* no grammatical statement about Umbrian is free from difficulty; and these bare outlines of its phonology must be supplemented by reference to the lucid discussion in C. D. Buck's *Oscan and Umbrian Grammar* (Boston, 1904), or to the earlier and admirably complete *Oskisch-umbrische Grammatik* of R. von Planta (Strassburg, 1892-1897). Some of the most important questions are discussed by R. S. Conway in *The Italic Dialects*, vol. ii. p. 495 seq.

Save for the consequences of these phonetic changes, Umbrian morphology and syntax exhibit no divergences from Oscan that need be mentioned here, save perhaps their peculiar perfect formations with *-t* and *-nti-* as in *ampelust*, fut. perf. "impenderi," *combsianciust*, "nuntiaverit" (or the like). Full accounts of the accidents and syntax, so far as it is represented in the *Tables*, will be found in the grammars of Buck and von Planta already mentioned, and in the second volume of Conway, *op. cit.*

*Chronology*. (1) *The Relative Dates of the Tables*.—At least four periods in the history of the dialect can be distinguished in the records we have left to us, by the help of the successive changes (a) in the alphabet and (b) in language, which the *Tables* exhibit. Of these only the outstanding features can be mentioned here; for a fuller discussion the reader must be referred to *The Italic Dialects*, pp. 400 seq.

(a) *Changes in Alphabet*.—Observe first that Tables I., II., III. and IV., and the first two inscriptions of V. are in Umbrian character; the Latin alphabet is used in the *Clavianer* paragraph (V. iii.), and the whole of VI. (a and b) and VII. (a and b).

What we may call the normal Umbrian alphabet (in which e.g. Table I. *a* is written) consists of the following signs, the writing being always from right to left:  $\rho$ ,  $\alpha$ ,  $\beta$ ,  $\gamma$ ,  $\delta$ ,  $\epsilon$ ,  $\zeta$ ,  $\eta$ ,  $\theta$ ,  $\iota$ ,  $\kappa$ ,  $\lambda$ ,  $\mu$ ,  $\nu$ ,  $\xi$ ,  $\psi$ ,  $\omega$ ,  $\pi$ .

1, p, r, s, x, t and d, v u and o, 8, f, d 3 (i.e. a voiceless palatal consonant.)

In the Latin alphabet, in which Tables VI. and VII. and the third inscription of Table V. are written, d is represented by RS, g by G but k by C, d by D, t by T, v and u by V but o by O, ð by ð, though the diacritic is often omitted. The interpunct is double with the Umbrian alphabet, single and medial with the Latin.

Tables VI. and VII., then, and V. iii., were written later than the rest. But even in the earlier group certain variations appear.

The latest form of the Umbrian alphabet is that of Table V. i. and ii., where the abbreviated form of *m* (*A*) and the angular and undivided form of *e* (*W* not *Z*) are especially characteristic.

Nearest to this is that of Tables III. and IV., which form a single document; then that of I. (a) and (b); earliest would seem that of II. (a) and II. (b). In II. a, 18 and 24, we have the archaic letter *s* (*M* = *s*) of the abecedaria (*E. S. Roberts, Int. Gr. Epig. pp. 17 ff.*), which appears in no other Italic nor in any Chalcidian inscription, though it survived longer in Etruscan and Venetic use. Against this may be set the use of *o* for *t* in I. b 1, but this appears also in IV. 20 and should be called rather Etruscan than archaic. These characteristics of II. a and b would be in themselves too slight to prove an earlier date, but they have perhaps some weight as confirming the evidence of the language.

(b) *Changes in Language.*—The evidence of date derived from changes in the language is more difficult to formulate, and the inquiry calls for the most diligent use of scientific method and critical judgment. Its intricacy lies in the character of the documents before us—religious formularies consisting partly of matter established in usage long before they were written down in their present shape, partly of additions made at the time of writing. The best example of this is furnished by the expansion and modernisation of the subject-matter of Table I. into Tables III. and VII. a. Hence we frequently meet with forms which had passed out of the language that was spoken at the time they were engraved, side by side with their equivalents in that language. We may distinguish four periods, as follows:

1. The first period is represented, not by any complete table, but by the old unmodernised forms of Tables III. and IV., which show the original guttural plosives unpalatalized, e.g. *kebu* = Lat. *cibum*.

2. In the second period the gutturals have been palatalized, but there yet is no change of final *s* to *r*. This is represented by the rest of III. and IV. and by II. a and b.

3. In the third period final *s* has everywhere become *r*. This appears in V. (i. and ii. and also iii.). Table I. is a copy or redraft made from older documents during this period. This is shown by the occasional appearance of *r* instead of final *s*.

4. Soon after the dialect had reached its latest form, the Latin alphabet was adopted. Tables VI. and VII. a contain an expanded form of the same liturgical direction as Table I.

It is probable that further research will amend this classification in detail, but its main lines are generally accepted.

(I.) *Actual Date of the Tables.*—Only the leading points can be mentioned here.

(i.) The Latin alphabet of the latest Tables resembles that of the *Tabula Bantina*, and might have been engraved at almost any time between 150 B.C. and 50 B.C. It is quite likely that the closer relations with Rome, which began after the Social War, led to the adoption of the Latin alphabet. Hence we should infer that the Tables in Umbrian alphabet were at all events older than 90 B.C.

(ii.) For an upper limit of date, in default of definite evidence, it seems imprudent to go back beyond the 5th century B.C., since neither in the one nor Campania have we any evidence of public written documents of any earlier century. When more is known of the earliest Etruscan inscriptions it may become possible to date the Iguvine Tables by their alphabetic peculiarities as compared with their mother-alphabet, the Etruscan. The "Tuscan name" is denounced in the comprehensive curse of Table VI. b, 53-60, and we may infer that the town of Iguvium was independent but in fear of the Etruscans at the time when the curse was first composed. The absence of all mention of either Gauls or Romans seems to prove that this time was at least earlier than 400 B.C.; and the curse may have been composed long before it was written down.

The chief sources in which further information may be sought have been already mentioned. (R. S. C.)

**IJOLITE** (derived from the first syllable of the Finnish words *Jiuaru, Jijoki, &c.*, common as geographical names in the Kola peninsula, and the Gr. *λίθος*, a stone), a rock consisting essentially of nepheline and augite, and of great rarity, but of considerable importance from a mineralogical and petrographical standpoint. It occurs in various parts of the Kola peninsula in north Finland on the shores of the White Sea. The pyroxene is morphic, yellow or green, and is surrounded by formless areas of nepheline. The accessory minerals are apatite, cancrinite, calcite, titanite and jwaarite, a dark-brown titaniferous variety of melauite-garnet. This rock is the plutonic and holo-

crystalline analogue of the nephelinites and nepheline-dolerites; it bears the same relation to them as the nepheline-syenites have to the phonolites. It is worth mentioning that a leucite-augite rock, resembling ijolite except in containing leucite in place of nepheline, is known to occur at Shonkin Creek, near Fort Benton, Montana, and has been called missourite.

**IKI**, an island belonging to Japan, lying off the north-western coast of Kiushiu, in 33° 45' N. lat. and 129° 40' E. long. It has a circumference of 86 m., an area of 51 sq. m., and a population of 36,530. The island is, for the most part, a tableland about 500 ft. above sea-level. The anchorage is at Gonoura, on the south-west. A part of Kublai Khan's Mongols landed at Iki when about to invade Japan in the 13th century, for it lies in the direct route from Korea to Japan via Tsushima. In the immediate vicinity are several rocky islets.

**ILAGAN**, the capital of the province of Isabela, Luzon, Philippine Islands, on an elevated site at the confluence of the Pina-canauan river with the Grande de Cagayan, about 200 m. N.N.E. of Manila. Pop. (1903) 16,008. The neighbouring country is the largest tobacco-producing section in the Philippines.

**ILCHESTER**, a market town in the southern parliamentary division of Somersetshire, England, in the valley of the river Ivel or Yevo, 5 m. N.W. of Yeovil. It is connected by a stone bridge with the village of Northover on the other side of the river. Ilchester has lost the importance it once possessed, and had in 1901 a population of only 564, but its historical interest is considerable. The parish church of St Mary is Early English and Perpendicular, with a small octagonal tower, but has been largely restored in modern times. The town possesses almshouses founded in 1426, a picturesque cross, and a curious ancient mace of the former corporation.

Ilchester (*Cair Pensarveoit, Ischalis, Ivelcestre, Yvelchester*) was a fortified British settlement, and subsequently a military station of the Romans, whose Fosse Way passed through it. Its importance continued in Saxon times, and in 1086 it was a royal borough with 107 burgesses. In 1180 a gold merchant was established, and the county gaol was completed in 1188. Henry II. granted a charter, confirmed by John in 1203, which gave Ilchester the same liberties as Winchester, with freedom from tolls and from being impaled without the walls, the fee farm being fixed at £26, 10s. od. The bailiffs of Ilchester are mentioned before 1230. The borough was incorporated in 1556, the fee farm being reduced to £8. Ilchester was the centre of the county administration from the reign of Edward III. until the 10th century, when the change from road to rail travelling completed the decay of the town. Its place has been taken by Taunton. The corporation was abolished in 1886. Parliamentary representation began in 1298, and the town continued to return two members until 1832. A fair on the 29th of August was granted by the charter of 1203. Other fairs on the 27th of December, the 22nd of July, and the Monday before Palm Sunday, were held under a charter of 1289. The latter, fixed as the 25th of March, was still held at the end of the 18th century, but there is now no fair. The Wednesday market dates from before the Conquest. The manufacture of thread lace was replaced by silk weaving about 1750, but this has decayed.

**ÎLE-DE-FRANCE**, an old district of France, forming a kind of island, bounded by the Seine, the Marne, the Beuvronne, the Thève and the Oise. In this sense the name is not found in written documents before 1429; but in the second half of the 15th century it designated a wide military province of government, bounded N. by Picardy, W. by Normandy, S. by Orléans and Nivernais, and E. by Champagne. Its capital was Paris. From the territory of Île-de-France were formed under the Revolution the department of the Seine, together with the greater part of Seine-et-Oise, Seine-et-Marne, Oise and Aisne, and a small part of Loiret and Nièvre. (The term Île-de-France is also used for Mauritius, *q.v.*)

See A. Longnon, "L'Île-de-France, son origine, ses limites, ses gouverneurs," in the *Mémoires de la Société de l'histoire de Paris et de l'Île-de-France*, vol. i. (1875).

**ILETSK**, formerly *Fort Iletskaia Zashchita*, a town of Russia, in the government of Orenburg, 48 m. S. of the town of Orenburg by the railway to Tashkent, near the Ilek river, a tributary of the Ural. Pop. 11,802 in 1897. A thick bed of excellent rock-salt is worked here to the extent of about 100,000 tons annually. The place is resorted to for its salt, mud and brine baths, and its koumiss cures.

**ILFELD**, a town in Germany, in the Prussian province of Hanover, situated at the south foot of the Harz, at the entrance to the Bährethal, 8 m. N. from Nordhausen by the railway to Wernigerode. Pop. 1600. It contains an Evangelical church, a celebrated gymnasium, once a monastical school, with a fine library, and manufactures of parquet-flooring, paper and plaster of Paris, while another industry in the town is brewing. It is also of some repute as a health resort.

Ilfeld, as a town, dates from the 14th century, when it sprang up round a Benedictine monastery. Founded about 1190 this latter was reformed in 1545, and a year later converted into the school mentioned above, which under the rectorship of Michael Neander (1525-1595) enjoyed a reputation for scholarship which it has maintained until to-day.

See Förstemann, *Monumenta rerum Ilfeldensium* (Nordhausen, 1843); M. Neander, *Bericht vom Kloster Ilfeld*, edited by Bouterwek (Göttingen, 1873); and K. Meyer, *Geschichte des Klosters Ilfeld* (Leipzig, 1897).

**ILFORD** [GREAT ILFORD], an urban district in the Romford parliamentary division of Essex, England, on the Roding, 7 m. E.N.E. of London by the Great Eastern railway. Pop. (1891) 10,913, (1901) 41,234. A portion of Hainault Forest lies within the parish. The hospital of St Mary and St Thomas, founded in the 12th century as a leper hospital, now contains almshouses and a chapel, and belongs to the marquess of Salisbury, who as "Master" is required to maintain a chaplain and six aged inmates. The chapel appears to be of the date of this foundation. Claybury Hall is a lunatic asylum (1893) of the London County Council. There are large photographic material works and paper mills. **LITTLE ILFORD** is a parish on the opposite (west) side of the Roding. The church of St Mary retains Norman portions, and has a curious monumental brass commemorating a boy in school-going clothes (1517). Pop. (1901) 17,015.

**ILFRACOMBE**, a seaport and watering-place in the Barnstaple parliamentary division of Devonshire, England, on the Bristol Channel, 225 m. W. by S. of London by the London & South-Western railway. Pop. of urban district (1901) 8557. The picturesque old town, built on the cliffs above its harbour, consists of one street stretching for about a mile through a network of lanes. Behind it rise the terraces of a more modern town, commanding a fine view across the Channel. With its beautiful scenery and temperate climate, Ilfracombe is frequented by visitors both in summer and winter. Grand rugged cliffs line the coast; while, inland, the country is celebrated for the rich colouring of its woods and glens. Wooded heights form a semicircle round the town, which is protected from sea winds by Capstone Hill. Along the inner face of this rock has been cut the Victoria Promenade, a long walk roofed with glass and used for concerts. The restored church of Holy Trinity dates originally from the 12th century. Sea-bathing is insecure, and is confined to a few small coves, approached by tunnels hewn through the rock. The harbour, a natural recess among the cliffs, is sheltered on the east by Hilsborough Head, where there are some alleged Celtic remains; on the west by Lantern Hill, where the ancient chapel of St Nicholas has been transformed into a lighthouse. In summer, passenger steamers run to and from Ilfracombe pier; but the shipping trade generally has declined, though herring fisheries are carried on with success. In the latter part of the 13th century Ilfracombe obtained a grant for holding a fair and market, and in the reign of Edward III. it was a place of such importance as to supply him with six ships and ninety-six men for his armament against Calais. During the Civil War, being garrisoned for the Roundheads, it was in 1644 captured by the Royalists, but in 1646 it fell into the hands of Fairfax.

**ILHAVO**, a seaport in the district of Aveiro, formerly included in the province of Beira, Portugal, 3 m. S.W. of Aveiro (*q.v.*), on the lagoon of Aveiro, an inlet of the Atlantic Ocean. Pop. (1900) 12,617. Ilhavo is inhabited chiefly by fishermen, but has a celebrated manufactory of glass and porcelain, the Vista-Alegre, at which the art of glass-cutting has reached a high degree of perfection. Salt is largely exported. Ilhavo is celebrated for the beauty of its women. It is said to have been founded by Greek colonists about 400 B.C., but this tradition is of doubtful validity.

**ILI**, one of the principal rivers of Central Asia, in the Russian province of Semiryecheensk. The head-stream, called the Tekez, rises at an altitude of 11,600 ft. E. of Lake Issyk-kul, in 82° 25' E. and 43° 23' N., on the W. slopes of mount Kash-katur. At first it flows eastward and north-eastward, until, after emerging from the mountains, it meets the Kungez, and then, assuming the name of Ili, it turns westwards and flows between the Trans-Ili Ala-tau mountains on the south and the Borokhoro and Talki ranges on the north for about 300 m. to Iliysk. The valley between 70° 30' and 82° E. is 50 m. wide, and the portion above the town of Kulja (Old Kulja) is fertile and populous, Taranchi villages following each other in rapid succession, and the pastures being well stocked with sheep and cattle and horses. At Iliysk the river turns north-west, and after traversing a region of desert and marsh falls by at least seven mouths into the Balkash Lake, the first bifurcation of the delta taking place about 115 m. up the river. But it is only the southern arm of the delta that permanently carries water. The total length of the river is over 900 m. From Old Kulja to New Kulja the Ili is navigable for at most only two and a half months in the year, and even then considerable difficulty is occasioned by the shoals and sandbanks. From New Kulja to Iliysk (280 m.) navigation is easy when the water is high, and practicable even at its lowest for small boats. At Iliysk there is a ferry on the road from Kopal to Vnyerny. The principal tributaries of the Ili are the Kash, Chilik and Charyn. A vast number of streams flow towards it from the mountains on both sides, but most of them are used up by the irrigation canals and never reach their goal. The wealth of coal in the valley is said to be great, and when the Chinese owned the country they worked gold and silver with profit. Fort Ili or Iliysk, a modern Russian establishment, must not be confounded with Ili, the old capital of the Chinese province of the same name. The latter, otherwise known as Hoi-yuan-chen, New Kulja (Gulja), or Manchu Kulja, was formerly a city of 70,000 inhabitants, but now lies completely deserted. Old Kulja, Tatar Kulja or Nin-yuan, is now the principal town of the district. The Chinese district of Ili formerly included the whole of the valley of the Ili river as far as Issyk-kul, but now only its upper part. Its present area is about 27,000 sq. m. and its population probably 70,000. It belongs administratively to the province of Sin-kiang or East Turkestan. (See *KULJA*.)

**ILION**, a village of Herkimer county, New York, U.S.A., about 12 m. S.E. of Utica, on the S. bank of the Mohawk river. Pop. (1890) 4057; (1900) 5138 (755 foreign-born); (1905, state census) 5924; (1910) 6588. It is served by the New York Central & Hudson river, and the West Shore railways, by the Utica & Mohawk Valley Electric railroad, and by the Erie canal. It has a public library (1868) of about 13,500 volumes, a public hospital and a village hall. The village owns its water-works and its electric-lighting plant. Its principal manufactures are Remington typewriters and Remington fire-arms (notably the Remington rifle); other manufactures are filing cabinets and cases and library and office furniture (the Clark & Baker Co.), knit goods, carriages and harness, and store fixtures. In 1828 Eliphalet Remington (1793-1861) established here a small factory for the manufacture of rifles. He invented, and, with the assistance of his sons, Philo (1816-1880), Samuel and Eliphalet, improved the famous Remington rifle, which was adopted by several European governments, and was supplied in large numbers to the United States army. In 1856 the company added the manufacture of farming tools, in 1870 sewing-machines,



and in 1874 typewriters. The last-named industry was sold to the Wyckoff, Seamans & Benedict Company in 1886, and soon afterwards, on the failure of the original Remington company, the fire-arms factory was bought by a New York City firm. A store was established on the present site of Iliou as early as 1816, but the village really dates from the completion of the Erie canal in 1825. On the canal list it was called Steele's Creek, but it was also known as Morgan's Landing, and from 1830 to 1843 as Remington's Corners. The post-office, which was established in 1845, was named Remington, in honour of Eliphalet Remington; but later the present name was adopted. The village was incorporated in 1852. Ilkeston is a part of the township of German Flats (pop. in 1900, 8663; in 1910, 10,160), settled by Palatine Germans about 1725. The township was the scene of several Indian raids during the French and Indian War and the War of Independence. Here General Herkimer began his advance to raise the siege of Fort Schuyler (1777), and subsequently Iliou was the rendezvous of Benedict Arnold's force during the same campaign.

**ILKESTON**, a market town and municipal borough, in the Ilkeston parliamentary division of Derbyshire, England, 9 m. E.N.E. of Derby, on the Midland and the Great Northern railways. Pop. (1891) 10,744, (1901) 25,384. It is situated on a hill commanding fine views of the Erewash valley. The church of St Mary is Norman and Early English, and has a fine chancel screen dating from the later part of the 13th century. The manufactures of the town are principally hosiery and lace, and various kinds of stoneware. Coal and iron are wrought in the neighbourhood. An alkaline mineral spring, resembling the seltzer water of Germany, was discovered in 1830, and baths were then erected, which, however, were subsequently closed. The town, which is very ancient, being mentioned in Domesday, obtained a grant for a market and fair in 1251, and received its charter of incorporation in 1887. It is governed by a mayor, 6 aldermen and 18 councillors. Area, 2526 acres.

**ILKLEY**, an urban district in the Otley parliamentary division of the West Riding of Yorkshire, England, 16 m. N.W. from Leeds, on the Midland and the North-Eastern railways. Pop. of urban district (1901) 7455. It is beautifully situated in the upper part of the valley of the Wharfe, and owing to the fine scenery of the neighbourhood, and to the bracing air of the high moorlands above the valley, has become a favourite health resort. Here and at Ben Rhydding, 1 m. E., are several hydropathic establishments. The church of All Saints is in the main Decorated, largely restored in 1860. Three ancient sculptured crosses are preserved in the churchyard. The institutions include a museum of local antiquities, a grammar school, the Siemens Convalescent Home and the Ilkley Bath Charitable Institution. The fine remains of Bolton Abbey lie in the Wharfe valley, 5 m. above Ilkley. Ilkley has been identified with the *Olicana* of Ptolemy, one of the towns of the British tribe of the Brigantes. There was a Roman fort near the present church of All Saints, and the site has yielded inscriptions and other small remains. Numerous relics are preserved in the museum.

**ILL**, a river of Germany, entirely within the imperial territory of Alsace-Lorraine. It rises on a north foothill of the Jura, S.W. of Basel, and flows N.N.E. parallel with the Rhine, which it enters from the left, 9 m. below Strassburg. Its course lies for the most part through low meadowland; and the stream, which is 123 m. long, receives numerous small affluents, which pour out of the short narrow valleys of the Vosges. It is navigable from Ladhof near Colmar to its confluence with the Rhine, a distance of 59 m. It is on this river, and not on the Rhine, that the principal towns of Upper Alsace are situated, e.g. Mülhausen, Colmar, Schlettstadt and Strassburg. The Ill feeds two important canals, the Rhine-Marne canal and the Rhine-Rhone canal, both starting from the neighbourhood of Strassburg.

**ILLAWARRA**, a beautiful and fertile district of New South Wales, Australia, extending from a point 33 m. S. of Sydney, along the coast southwards for 40 m. to Shoalhaven. It is thickly populated, and supplies Sydney with the greater part

of its dairy produce. There are also numerous collieries, producing coal of superior quality, and iron ore, fireclay and freestone are plentiful. The Illawarra Lake, a salt lagoon, 9 m. long and 3 m. wide, is encircled by hills and is connected with the sea by a narrow channel; quantities of fish are caught in it and wild fowl are abundant along its shores. The chief towns in the district are Wollongong, Kiama, Clifton and Shellharbour.

**ILLE-ET-VILAINE**, a maritime department of north-western France, formed in 1790 out of the eastern part of the old province of Brittany. Pop. (1906) 611,805. Area 2699 sq. m. It is bounded N. by the English Channel, the Bay of St Michel and the department of Manche; E. by Mayenne; S. by Loire-Inférieure; and W. by Morbihan and Côtes-du-Nord. The territory of Ille-et-Vilaine constitutes a depression bordered by hills which reach their maximum altitudes (over 800 ft.) in the N.E. and W. of the department. The centre of this depression, which separates the hills of Brittany from those of Normandy, is occupied by Rennes, capital of the department and an important junction of roads, rivers and railways. The department takes its name from its two principal rivers, the Ille and the Vilaine. The former joins the Vilaine at Rennes after a course of 18 m. through the centre of the department; and the latter, which rises in Mayenne, flows westwards as far as Rennes, where it turns abruptly south. The stream is tidal up to the port of Redon, and is navigable for barges as far as Rennes. The Vilaine receives the Meu and the Seiche, which are both navigable. There are two other navigable streams, the Airon and the Rance, the long estuary of which falls almost entirely within the department. The Ille-et-Rance canal connects the town of Rennes with those of Dinan and St Malo. The greater portion of the shore of the Bay of St Michel is covered by the Marsh of Dol, valuable agricultural land; which is protected from the inroads of the sea by dykes. Towards the open channel the coast is rocky. Small lakes are frequent in the interior of the department. The climate is temperate, humid and free from sudden changes. The south-west winds, while they keep the temperature mild, also bring frequent showers, and in spring and autumn thick fogs prevail. The soil is thin and not very fertile, but has been improved by the use of artificial manure. Cereals of all kinds are grown, but the principal are wheat, buckwheat, oats and barley. Potatoes, early vegetables, flax and hemp are also largely grown, and tobacco is cultivated in the arrondissement of St Malo. Apples and pears are the principal fruit, and the cider of the canton of Dol has a high reputation. Cheese is made in considerable quantities, and the butter of Rennes is amongst the best in France. Large numbers of horses and cattle are raised. Mines of iron, lead and zinc (Pont-Péan) and quarries of slate, granite, &c., are worked. There are flour and saw-mills, brick works, boat-building yards, iron and copper foundries and forges, dyeworks, and a widespread tanning industry. Sail-cloth, rope, pottery, boots and shoes (Fougères), edge-tools, nails, farming implements, paper and furniture are also among the products of the department. The chief ports are St Malo and St Servan. Fishing is very active on the coast, and St Malo, St Servan and Cancale equip fleets for the Newfoundland cod-banks. There are also important oyster-fisheries in the Bay of St Michel, especially at Cancale. The little town of Dinard is well known as a fashionable bathing-resort. Exports include agricultural products, butter, mine-posts and dried fish; imports, live-stock, coal, timber, building materials and American wheat. The department is served by the Western railway, and has over 130 m. of navigable waterway. The population is of less distinctively Celtic origin than the Bretons of Western Brittany, between whom and the Normans and Angevins it forms a transitional group. Ille-et-Vilaine is divided into the arrondissements of Fougères, St Malo, Montfort-sur-Meu, Redon, Rennes and Vitré, with 43 cantons and 360 communes. The chief town is Rennes, which is the seat of an archbishop and of a court of appeal, headquarters of the X. army corps, and the centre of an académie (educational division).

In addition to the capital, Fougères, St Malo, St Servan,

Redon, Vitré, Dol, Dinard and Cancale are the towns of chief importance and are separately noticed. At Combourg there is a picturesque château of the 14th and 15th centuries where Chateaubriand passed a portion of his early life. St Aubin-du-Cormier has the ruins of an important feudal fortress of the 13th century built by the dukes of Brittany for the protection of their eastern frontier. Montfort-sur-Meu has a cylindrical keep of the 15th century which is a survival of its old ramparts.

**ILLEGITIMACY** (from "illegitimus," Lat. *illegitimus*, not in accordance with law, hence born out of lawful wedlock), the state of being of illegitimate birth. The law dealing with

TABLE II.—*Illegitimate Births to 1000 Unmarried and Widowed Females, aged 15-49 years.*

Country.	1846-55.	1856-65.	1866-75.	1876-85.	1886-95.	1896-1905.
England and Wales . . . . .	17	18	16	13	10	8
Scotland . . . . .	..	22	23	20	17	13
Ireland . . . . .	..	5	4	5	5	3
Denmark . . . . .	..	28	27	26	24	23
Sweden . . . . .	20	22	23	22	22	..
Germany . . . . .	..	..	..	28	27	26
Netherlands . . . . .	..	..	10	9	9	6
Belgium . . . . .	16	16	17	19	17	17
France . . . . .	15	17	17	16	17	18
Italy . . . . .	..	..	..	24	24	19

as it is usually termed. This is given for certain countries in Table II.

TABLE I.—*Illegitimate Births per 1000 Births (excluding still-born).*

	1876-1880.	1881-1885.	1886-1890.	1891-1895.	1896-1900.	1901-1905.
England and Wales . . . . .	48	48	46	42	41	40
Scotland . . . . .	85	83	81	74	68	64
Ireland . . . . .	24	27	28	36	36	26
Denmark . . . . .	101	100	95	94	96	101
Norway . . . . .	84	81	75	71	74	..
Sweden . . . . .	100	102	103	105	113	..
Finland . . . . .	73	70	65	65	66	..
Russia . . . . .	28	27	27	27	27	..
Austria . . . . .	138	145	147	146	141	..
Hungary . . . . .	73	79	82	85	90	94
Switzerland . . . . .	47	48	47	46	45	..
Germany . . . . .	87	92	92	91	90	84
Netherlands . . . . .	31	30	32	31	27	23
Belgium . . . . .	74	82	87	88	80	68
France . . . . .	72	78	83	87	88	88
Portugal . . . . .	..	..	123	122	121	..
Spain . . . . .	..	..	..	..	49	44
Italy . . . . .	72	76	74	69	62	56
New South Wales . . . . .	42	41	49	60	69	70
Victoria . . . . .	43	46	44	49	60	70
Queensland . . . . .	39	41	44	48	59	65
South Australia . . . . .	..	22	25	30	38	41
West Australia . . . . .	..	..	..	48	51	42
Tasmania . . . . .	..	49	38	46	57	..
New Zealand . . . . .	23	24	32	38	44	45

the legitimation of children born out of wedlock will be found under LEGITIMACY and LEGITIMATION. How far the prevalence of illegitimacy in any community can be taken as a guide to the morality of that community is a much disputed question. The phenomenon itself varies so much in different localities, even in localities where the same factors seem to prevail, that affirmative conclusions are for the most part impossible to draw. In the United Kingdom, where the figures differ considerably for the three countries—England, Scotland, Ireland—the reasons that might be assigned for the differences are negative if applied on the same lines, as they might well be, to certain other countries. Then again, racial, climatic and social differences must be allowed for, and the influence of legislation is to be taken into account. The fact that in some countries marriage is forbidden until a man has completed his military service, in another, that consent of parents is requisite, in another, that "once a bastard always a bastard" is the rule, while in yet another that the merest of subsequent formalities will legitimize the offspring, must account in some degree for variations in figures.

Table I. gives the number of illegitimate births per 1000 births in various countries of the world for quinquennial periods. It is to be noted that still-born births are excluded, as in the United Kingdom (contrary to the practice prevailing in most European countries) registration of such births is not compulsory. The United States is omitted, as there is no national system of registration of births.

This method of measuring illegitimacy by ascertaining the proportion of illegitimate births in every thousand births is a fairly accurate one, but there is another valuable one which is often applied, that of comparing the number of illegitimate births with each thousand unmarried females at the child-bearing age—the "corrected" rate as opposed to the "crude,"

The generally accepted idea that the inhabitants of the warmer countries of the south of Europe are more ardent in tempera-

ment has at least no support as shown in the figures in Table I., where we find a higher rate of illegitimacy in Sweden and Denmark than in Spain or Italy. Religion, however, must be taken into account as having a strong influence in preventing unchastity, though it cannot be concluded that any particular creed is more powerful in this direction than another; for example, the figures for Austria and Ireland are very different. It cannot be said, either, that figures bear out the statement that where there is a high rate of illegitimacy there is little prostitution. It is more probable that in a country where the standard of living is low, and early marriages are the rule, the illegitimate birth-rate will be low. As regards England and Wales, the illegitimate birth-rate has been steadily declining for many years, not only in actual numbers, but also in proportion to the population.

TABLE III.—*England and Wales.*

Year.	Illegitimate Births.	Proportion to 1000 of population.	Illegitimate Births in 1000 Births.
1860	43,693	2.2	64
1865	46,585	2.2	62
1870	44,737	2.0	56
1875	40,813	1.7	48
1880	42,542	1.6	48
1885	42,793	1.6	48
1890	38,412	1.3	44
1895	38,836	1.3	42
1900	36,814	1.1	40
1905	37,315	1.1	40
1907	36,189	1.0	39

The corrected rate bears out the result shown in Table III as follows:

TABLE IV.—*England and Wales. Illegitimate Birth-rate calculated on the Unmarried and Widowed Female Population, aged 15-15 years.*

	Rate per 1000.	Compared with rate in 1876-1880, taken as 100.
1876-1880	14.4	100.0
1881-1885	13.5	93.8
1886-1890	11.8	81.9
1891-1895	10.1	70.1
1896-1900	9.2	63.9
1901-1905	8.4	58.3
1906	8.1	56.3
1907	7.8	54.2

Table V. gives the illegitimate births to 1000 births in England and Wales for the ten years 1807-1906 and for

## ILLEGITIMACY

TABLE V.—England and Wales. *Illegitimate Births to 1000 Births.*

	Ten years 1897-1906.		1907.		Ten years 1897-1906.		1907.		Ten years 1897-1906.		1907.		
Bedford . . . . .	49	53	Hertford . . . . .	40	42	Oxford . . . . .	53	56	N. Riding . . . . .	53	45		
Berks . . . . .	47	48	Huntingdon . . . . .	49	46	Rutland . . . . .	64	70	W. " . . . .	43	41		
Bucks . . . . .	40	44	Kent . . . . .	40	41	Shropshire . . . . .	64	61					
Cambridge . . . . .	48	53	Lancashire . . . . .	38	37	Somerset . . . . .	37	35	Anglesey . . . . .	81	75		
Chester . . . . .	41	39	Leicestershire . . . . .	40	38	Stafford . . . . .	40	38	Brecon . . . . .	44	40		
Cornwall . . . . .	50	48	Lincolnshire . . . . .	55	54	Suffolk . . . . .	56	62	Cardigan . . . . .	64	61		
Cumberland . . . . .	61	58	London . . . . .	37	38	Sussex . . . . .	52	52	Carmarthen . . . . .	37	41		
Derby . . . . .	41	41	Middlesex . . . . .	30	28	Warwick . . . . .	32	30	Carnarvon . . . . .	60	72		
Devon . . . . .	39	39	Monmouth . . . . .	29	27	Westmorland . . . . .	61	62	Denbigh . . . . .	49	47		
Dorset . . . . .	40	37	Norfolk . . . . .	62	65	Wilts . . . . .	41	42	Flint . . . . .	46	42		
Durham . . . . .	34	37	Northampton . . . . .	41	42	Worcester . . . . .	37	38	Glamorgan . . . . .	26	26		
Essex . . . . .	28	27	Northumberland . . . . .	39	38	Yorks— . . . . .			Merioneth . . . . .	71	77		
Gloucester . . . . .	36	36	Nottingham . . . . .	50	49	E. Riding . . . . .	52	49	Montgomery . . . . .	76	73		
Hants . . . . .	40	36							Pembroke . . . . .	52	47		
Hereford . . . . .	66	66							Radnor . . . . .	66	67		

TABLE VI.—Annual Illegitimate Birth-rates in each Registration County of England and Wales, 1870-1907.

Registration Counties.	Illegitimate Births to 1000 Unmarried and Widowed Females, aged 15-45 years.							Decrease per cent in each County between the period 1870-1872 and 1907.
	Three-year Periods.					Years.		
	1870-1872.	1880-1882.	1890-1892.	1900-1902.	1903-1905.	1906.	1907.	
England and Wales	17.0	14.1	10.5	8.5	8.3	8.1	7.8	54.1
London . . . . .	10.3	9.8	8.1	6.9	6.9	6.8	6.4	37.9
Bedford . . . . .	21.1	18.0	11.2	8.4	8.0	8.2	8.7	58.8
Berks . . . . .	16.8	13.4	10.3	8.7	8.6	8.1	8.4	50.0
Bucks . . . . .	19.0	16.5	12.6	9.1	8.9	7.3	8.8	53.7
Cambridge . . . . .	19.3	15.6	12.4	9.6	10.1	9.7	10.4	46.1
Chester . . . . .	17.5	14.2	10.3	7.7	7.3	7.2	6.9	60.6
Cornwall . . . . .	16.5	14.8	11.2	8.6	8.1	7.5	7.5	54.5
Cumberland . . . . .	29.2	23.9	18.6	12.3	12.3	12.3	11.0	62.3
Derby . . . . .	22.5	17.7	12.8	10.0	10.0	10.0	9.4	58.2
Devon . . . . .	14.0	10.6	8.1	6.7	6.5	6.7	6.1	56.4
Dorset . . . . .	14.2	13.1	9.6	7.2	7.2	8.1	6.4	54.9
Durham . . . . .	24.0	18.0	13.8	11.1	11.1	10.8	11.6	51.7
Essex . . . . .	16.2	12.7	9.1	7.3	7.1	6.7	6.4	60.5
Gloucester . . . . .	12.9	11.6	8.2	6.3	6.1	6.8	5.8	55.0
Hants . . . . .	13.6	11.8	8.5	7.3	7.1	6.9	6.4	52.9
Hereford . . . . .	21.4	19.0	13.4	11.2	11.5	10.3	11.0	48.6
Hertford . . . . .	18.4	15.3	10.4	7.0	7.2	6.6	7.5	59.2
Huntingdon . . . . .	19.8	14.0	12.9	10.9	9.7	9.7	9.7	51.0
Kent . . . . .	14.7	12.1	9.3	7.5	7.6	7.5	7.2	51.0
Lancashire . . . . .	16.2	13.6	10.2	7.9	7.8	7.5	7.2	55.6
Leicestershire . . . . .	19.9	16.1	11.4	8.6	7.9	7.5	7.3	63.3
Lincolnshire . . . . .	22.3	18.5	14.2	12.2	12.1	12.7	11.9	49.6
Middlesex . . . . .	9.4	9.4	6.5	5.9	6.0	6.1	5.7	36.4
Monmouth . . . . .	18.6	15.9	11.3	10.2	9.1	9.6	9.3	50.0
Norfolk . . . . .	27.3	22.6	16.7	13.4	13.4	12.5	12.8	53.1
Northampton . . . . .	18.7	15.9	11.7	9.1	8.8	9.0	7.7	58.8
Northumberland . . . . .	21.1	17.9	12.4	10.2	10.0	10.4	9.3	55.9
Nottingham . . . . .	24.5	21.7	15.4	12.7	12.6	12.0	11.9	51.4
Oxford . . . . .	19.0	15.4	10.4	9.0	9.1	9.3	9.2	51.6
Rutland . . . . .	18.1	12.7	7.9	7.2	6.8	9.0	11.4	37.0
Salop . . . . .	28.2	21.8	16.6	12.8	13.4	13.0	11.8	58.2
Somerset . . . . .	13.3	11.3	7.4	6.0	6.0	5.4	5.5	58.6
Stafford . . . . .	24.6	19.4	14.5	11.2	11.4	10.9	10.1	58.9
Suffolk . . . . .	22.0	17.8	14.0	12.0	11.7	12.4	12.5	43.2
Surrey . . . . .	9.5	8.5	6.6	5.9	5.7	5.9	5.7	40.0
Sussex . . . . .	13.7	11.5	8.7	7.2	7.0	6.5	6.4	53.3
Warwick . . . . .	14.9	13.2	9.7	7.6	7.5	6.6	6.8	54.4
Westmorland . . . . .	21.9	17.9	13.1	8.6	9.1	8.5	7.8	64.4
Wilts . . . . .	17.1	14.7	10.3	9.2	8.7	8.6	9.3	45.6
Worcester . . . . .	16.3	13.7	9.2	7.2	6.8	6.6	6.6	59.5
Yorks—								
E. Riding . . . . .	23.0	18.2	14.3	12.2	11.7	12.2	10.6	53.9
N. Riding . . . . .	27.7	20.2	15.4	12.1	11.9	10.2	10.2	63.2
W. Riding . . . . .	20.4	16.1	11.4	9.4	9.2	8.8	8.1	60.3
Anglesey . . . . .	19.7	16.7	15.7	16.1	14.9	13.3	12.9	34.5
Brecon . . . . .	19.9	18.0	12.5	10.1	9.2	9.2	8.3	58.3
Cardigan . . . . .	16.0	14.8	11.8	8.9	7.8	6.3	7.3	54.4
Carmarthen . . . . .	18.2	13.9	9.4	7.7	8.2	7.7	8.9	51.1
Carnarvon . . . . .	18.3	13.9	12.7	10.3	9.6	9.4	10.5	42.6
Denbigh . . . . .	21.1	17.6	13.4	12.3	11.6	13.5	10.3	51.2
Flint . . . . .	18.7	18.4	13.1	9.7	11.2	11.9	11.0	41.2
Glamorgan . . . . .	17.7	13.5	10.3	8.5	9.1	8.9	8.4	52.5
Merioneth . . . . .	24.4	19.5	16.4	13.5	13.4	13.2	12.7	48.0
Montgomery . . . . .	29.5	24.3	16.7	13.1	13.4	12.6	11.7	60.3
Pembroke . . . . .	21.6	15.9	12.4	8.9	10.2	10.7	8.4	61.1
Radnor . . . . .	41.8	33.2	20.1	14.4	13.4	8.3	11.3	73.0

TABLE VII.—Rate of Illegitimacy per 1000 Births.

Belfast . . . . .	31	Liverpool . . . . .	54
Birmingham . . . . .	35	Manchester . . . . .	28
Bradford . . . . .	40	Middlesboro' . . . . .	25
Bristol . . . . .	31	Newcastle . . . . .	36
Cork . . . . .	18	Nottingham . . . . .	60
Dublin . . . . .	28	Portsmouth . . . . .	33
Edinburgh . . . . .	69	Salford . . . . .	28
Glasgow . . . . .	63	Sunderland . . . . .	30
Leeds . . . . .	54		

TABLE VIII.—Scotland 1906.

Total Births.	Legitimate.	Illegitimate.	Births per 1000 of pop.	Percentage of Illegitimate to Total Births.	
132,005	122,699	9306	27.93	7.05	
	Illegitimate Births.	Percentage of Illegitimate to Total Births.	Illegitimate Births.	Percentage of Illegitimate to Total Births.	
1860	9,736	9.22	1895	9204	7.28
1865	11,262	9.96	1900	8534	6.49
1870	11,108	9.63	1901	8359	6.32
1875	10,786	8.73	1902	8300	6.28
1880	10,589	8.50	1903	8295	6.21
1885	10,680	8.47	1904	9010	6.79
1890	9,241	7.60	1905	9082	6.91
			1906	9306	7.05

TABLE IX.—Scotland 1906.

Districts:	Illegitimate Births.		Illegitimate Births per 1000 of Un-married Women and Widows between 15 and 45.
	No.	Per 1000 of Pop.	
Principal Town . . . . .	4318	7.14	
Large Town . . . . .	1029	5.58	
Small Town . . . . .	1724	6.23	
Mainland-rural . . . . .	2099	9.08	
Insular-rural . . . . .	136	5.88	
Shetland . . . . .	31	5.30	7.0
Orkney . . . . .	29	5.99	7.7
Caithness . . . . .	84	9.96	19.4
Sutherland . . . . .	28	6.81	10.1
Koss and Cromarty . . . . .	74	4.40	6.9
Inverness . . . . .	145	8.02	11.5
Nairn . . . . .	18	10.29	13.2
Elgin (or Moray) . . . . .	169	15.66	26.3
Banff . . . . .	202	12.93	25.4
Aberdeen . . . . .	1083	12.38	24.2
Kincardine . . . . .	93	8.15	17.0
Forfar . . . . .	676	9.43	14.2
Perth . . . . .	215	7.93	10.8
Fife . . . . .	308	4.56	9.7
Kinross . . . . .	20	9.95	22.2
Clackmannan . . . . .	53	6.69	10.9
Stirling . . . . .	235	4.91	13.2
Dumbarton . . . . .	163	4.14	9.7
Argyll . . . . .	148	10.07	12.7
Bute . . . . .	30	8.36	9.2
Renfrew . . . . .	410	4.46	8.5
Ayr . . . . .	499	6.23	14.3
Lanark . . . . .	2872	6.28	15.9
Lanithgow . . . . .	99	3.88	15.4
Edinburgh . . . . .	930	7.23	11.0
Haddington . . . . .	66	5.92	11.8
Berwick . . . . .	60	9.63	12.7
Peebles . . . . .	21	6.18	7.9
Selkirk . . . . .	46	9.13	11.5
Roxburgh . . . . .	83	8.67	9.8
Dumfries . . . . .	218	12.51	19.9
Kirkcudbright . . . . .	92	10.71	15.7
Wigtown . . . . .	106	12.79	22.5
Scotland . . . . .	9306	7.05	14.1

"It is difficult to explain the variations in the rates of illegitimacy in the several counties. It may be stated generally that the proportion of illegitimate children cannot alone serve as a standard of morality. Broadly speaking, however, the single and widowed women in London, in the counties south of the Thames, and in the south-western counties have comparatively few illegitimate children; on the other hand, the number of illegitimate children is comparatively high in Shropshire, in Herefordshire, in Staffordshire, in Nottinghamshire, in Cumberland, in North Wales, and also in

TABLE X.—Ireland. Proportion per cent of Illegitimate Births.

Ireland	1903.	1904.	1905.	1906.	1907.
		2.6	2.5	2.6	2.6
Leinster . . . . .	2.6	2.6	2.7	2.7	2.7
Munster . . . . .	2.3	2.2	2.3	2.2	2.1
Ulster . . . . .	3.3	3.4	3.5	3.5	3.3
Connaught . . . . .	0.5	0.7	0.7	0.7	0.6

nearly all the counties on the eastern seaboard, viz. Suffolk, Norfolk, Lincolnshire, the East and North Ridings of Yorkshire, and Durham. In the Registrar-General's Report for the year 1851 it was assumed that there was an indirect connexion between female illiteracy and illegitimacy. This may have been the case in the middle of the last century, but there is no conclusive evidence that such is the case at the present day. The proportions of illegitimacy and the proportions of married women who signed the marriage register

TABLE XI.—Ireland 1907.

County.	No. of Illegitimate Births.	Per cent of Total Births.
Leinster—		
Carlow . . . . .	27	3.56
Dublin . . . . .	34	1.15
Dublin Co. Borough . . . . .	314	3.29
Kildare . . . . .	22	1.46
Kilkenny . . . . .	54	3.29
King's . . . . .	24	2.07
Longford . . . . .	11	1.23
Louth . . . . .	27	2.01
Meath . . . . .	30	2.27
Queen's . . . . .	18	1.70
Westmeath . . . . .	19	1.57
Wexford . . . . .	89	4.11
Wicklow . . . . .	37	2.91
Munster—		
Clare . . . . .	23	1.04
Cork Co. and Co. Borough . . . . .	151	1.69
Kerry . . . . .	51	1.34
Limerick Co. and Co. Borough . . . . .	107	3.14
Tipperary N.R. . . . .	19	1.49
Tipperary S.R. . . . .	66	3.32
Waterford Co. and Co. Borough . . . . .	68	3.69
Ulster—		
Antrim . . . . .	83	5.08
Armagh . . . . .	290	3.49
Belfast Co. Borough . . . . .	355	3.13
County Down . . . . .	277	1.54
County Donegal . . . . .	14	1.36
Fermanagh . . . . .	41	3.15
Londonderry Co. and Borough . . . . .	54	4.35
Monaghan . . . . .	24	1.55
Tyrone . . . . .	116	3.80
Connaught—		
Galway . . . . .	32	.80
Leitrim . . . . .	10	.77
Mayo . . . . .	21	.45
Roscommon . . . . .	9	.50
Sligo . . . . .	9	.52
Leinster . . . . .	716	2.67
Munster . . . . .	495	2.11
Ulster . . . . .	1272	3.32
Connaught . . . . .	81	.60
	2564	

by mark are relatively high in Staffordshire, in North Wales, in Durham and in the North Riding of Yorkshire; on the other hand, in Norfolk, in Suffolk and in Lincolnshire there is a comparatively high proportion of illegitimacy and a low proportion of illiteracy."

This latter conclusion may be carried further by saying that in those European countries where elementary education is

the year 1907. Table VI. gives the "corrected" rate for certain three-year periods. In connexion with these tables the following extract from the Registrar-General's Report for 1907 (p. xxx.) is important.

most common, the rate of illegitimacy is high, and that it is low in the more illiterate parts, e.g. Ireland and Brittany.

It has been said that one of the contributory causes of illegitimacy is the contamination of great cities; statistics, however, disprove this, there being more illegitimacy in the rural districts. Table VII. gives the rate of illegitimacy in some of the principal towns of the United Kingdom.

That poverty is a determining factor in causing illegitimacy the following figures, giving the rate of illegitimacy in the poorest parts of London and in certain well-to-do parts, clearly disprove:—

Rate of Illegitimacy per 1000 Births.

London.	1901.	1903.	1905.	1907.
Stepney . . . . .	12	9	18	10
Bethnal Green . . . . .	13	15	13	11
Mile End Old Town . . . . .	15	13	16	15
Whitechapel . . . . .	22	24	19	19
St. George's, Hanover Sq. . . . .	40	45	45	45
Kensington . . . . .	48	41	49	54
Fulham . . . . .	43	42	45	40
Marylebone . . . . .	182	186	198	182

Tables VIII. and IX. give the rate of illegitimacy for the various counties of Scotland, and Table X. the rate for Ireland.

**BIBLIOGRAPHY**—The Annual Reports of the Registrars-General for England, Scotland and Ireland; statistical returns of foreign countries; A. Leffingwell, *Illegitimacy and the Influence of the Seasons upon Conduct* (1892). (T. A. 1.)

**ILLER**, a river of Bavaria, rising in the south-west extremity of the kingdom, among the Algäuer Alps. Taking a northerly course, it quits the mountains at Immenstadt, and, flowing by Kempten, from which point it is navigable for rafts, forms for some distance the boundary between Bavaria and Württemberg, and eventually strikes the Danube (right bank) just above Ulm. Its total length is 103 m.

**ILLINOIS**, a North Central state of the United States of America, situated between 37° and 42° 30' N. lat. and 87° 35' and 91° 40' W. long. It is bounded N. by Wisconsin, E. by Lake Michigan and Indiana, S.E. and S. by the Ohio river, which separates it from Kentucky, and S.W. and W. by the Mississippi river, which separates it from Missouri and Iowa. The Enabling Act of Congress, which provided for the organization of Illinois Territory into a state, extended its jurisdiction to the middle of Lake Michigan and the Mississippi river; consequently the total area of the state is 38,329 sq. m., of which 2337 sq. m. are water surface, though the official figures of the United States Geological Survey, which does not take into account this extension of jurisdiction, are 56,665 sq. m.

**Physiography**.—Physiographically, the state (except the extreme southern point) lies wholly in the Prairie Plains region. The N.E. corner is by some placed in the "Great Lakes District." The southern point touches the Coastal Plain Belt at its northward extension called the "Mississippi Embayment." The surface of Illinois is an inclined plane, whose general slope is toward the S. and S.W. The average elevation above sea-level is about 600 ft.; the highest elevation is Charles Mound (1257 ft.), on the Illinois-Wisconsin boundary line, one of a chain of hills that crosses Jo Daviess, Stephenson, Winnebago, Boone and McHenry counties. An elevation from 6 to 10 m. wide crosses the southern part of the state from Grand Tower, in Jackson county, on the Mississippi to Shawneetown, in Gallatin county, on the Ohio, the highest point being 1047 ft. above the sea; from Grand Tower N. along the Mississippi to the mouth of the Illinois there is a slight elevation and there is another elevation of minor importance along the Wabash. Many of the river bluffs rise to an unusual height, Starved Rock, near Ottawa, in La Salle county, being 150 ft. above the bed of the Illinois river. Cave in Rock, on the Ohio, in Hardin county, was once the resort of river pirates. The country S. of the elevation (mentioned above) between Grand Tower and Shawneetown was originally covered with forests.

The drainage of Illinois is far better than its low elevation and comparatively level surface would suggest. There are more than 275 streams in the state, grouped in two river systems, one having the Mississippi, which receives three-fourths of the waters of Illinois, as outlet, the other being tributary to the Wabash or Ohio rivers. The most important river is the Illinois, which, formed by the junction of the Des Plaines and the Kankakee, in the N.E. part of Grundy county, crosses the N. central and W. portions of

the state, draining 24,726 sq. m. At some points, notably at Lake Peoria, it broadens into vast expanses resembling lakes. The Kaskaskia, in the S., notable for its variations in volume, and the Rock, in the N., are the other important rivers emptying into the Mississippi; the Embarrass and Little Wabash, the Saline and Cache in the E., are the important tributaries of the Wabash and Ohio rivers. The Chicago river, a short stream, 6 m. long, formed by the union of its N. branches, naturally flowed to Lake Michigan, but by the construction of the Chicago Drainage Canal its waters were turned in 1900 so that they ultimately flow into the Mississippi.

The soil of Illinois is remarkable for its fertility. The surface soils are composed of drift deposits, varying from 10 to 200 ft. in depth; they are often overlaid with a black loam 10 to 15 in. deep, and in a large portion of the state there is a subsoil of yellow clay. The soil of the prairies is darker and coarser than that of the forests, but all differences disappear with cultivation. The soil of the river valleys is alluvial and especially fertile, the "American Bottom," extending along the Mississippi from Alton to Chester, having been in cultivation for more than 150 years. Along the river bluffs there is a silicious deposit called loess, which is well suited to the cultivation of fruits and vegetables. In general the N. part of the state is especially suited to the cultivation of hay, the N. and central parts to Indian corn, the E. to oats, and the S.W. to wheat.

**Climate**.—The climate of Illinois is notable for its extremes of temperature. The warm winds, which sweep across the Mississippi Valley from the Gulf of Mexico are responsible for the extremes of heat, and the Arctic winds of the north, which find no mountain range to break their strength, cause the extremes of cold. The mean annual temperature at Winnebago, near the N. border, is 47° F., and it increases to the southward at the rate of about 2° for every degree of latitude, being 52° F. at Springfield, and 58° F. in Cairo, at the S. extremity. The lowest temperature ever recorded in the state was -32° F., in February 1905, at Ashton in the N.W. and the highest was 115° F., in July 1901, at Centralia, in the S., making a maximum range of 147° F. The range of extremes is considerably greater in the N. than in the S., for example, at Winnebago extremes have ranged from -26° F. to 110° F., or 136° F., but at Cairo they have ranged only from -16° F. to 106° F., or 122° F. The mean annual precipitation is about 39 in. in the S. counties, but this decreases to the northward, being about 36 in. in the central counties and 34 in. along the N. border. The mean annual snowfall increases from 12 in. at the S. extremity to approximately 40 in. in the N. counties. In the N. the precipitation is 44.8% greater in spring than in it is in autumn and winter, but in the S. only 26.17% greater. At Cairo the prevailing wind is southerly during all months except February, and as far north as Springfield they are southerly from April to January; but throughout the N. half of the state, except along the shore of Lake Michigan, where they vary from N.E. to S.W., the winds are mostly from the W. or N.W. from October to March and very variable for the remainder of the year. The dampness and inasmuch, to which so many of the early settlers' fatal "chills and fever" were due, have practically disappeared by modern methods of sanitary drainage.

**Fauna and Flora**.—The fauna and flora, which are similar to those of the other North Central States of North America, impressed the early explorers with their richness and variety. "We have seen nothing like this for the fertility of the land, its prairies, woods, and wild cattle," wrote Père Jacques Marquette of the Illinois region, and later explorers also bore witness to the richness of the country. Many of the original wild animals, such as the bison, bear, beaver, deer and lynx, had disappeared; wolves, foxes and mink are rare; but rabbits, squirrels and raccoons are still common. The deer, which was once a species of deer, is now a species of white and white perch; of better food fish, the principal varieties are bass (black, striped and rock), crappie, pike, "the jack salmon" or wall-eyed pike, and sun fish. The yield of the fisheries in 1900 was valued at \$388,876. The most important fisheries on the Illinois river and its tributaries were at Havana, Pekin and Peoria, which in 1907-1908 were represented by a total catch of about 10,000,000 lb, out of a total for this river system of 17,570,000 lb. The flora is varied. Great numbers of grasses and flowering plants which once beautified the prairie landscape are still found on the uplands, and there are about 80 species of trees, of which the oak, hickory, maple and ash are the most common. The cypress is found only in the S. and the tamarack only in the N. The forest area, estimated at 10,200 sq. m. in 1900, is almost wholly in the southern counties, and nearly all the trees which the northern half of the state had before the coming of the whites were along the banks of streams. Among wild fruits are the cherry, plum, grape, strawberry, blackberry and raspberry.

**Industry and Commerce**.—The fertility of the soil, the mineral wealth and the transportation facilities have given Illinois a vast economic development. In 1900 more than seven-tenths of the inhabitants in gainful occupations were engaged in agriculture (25.6%), manufactures and mechanical pursuits (26.7%), and trade and transportation (22%).

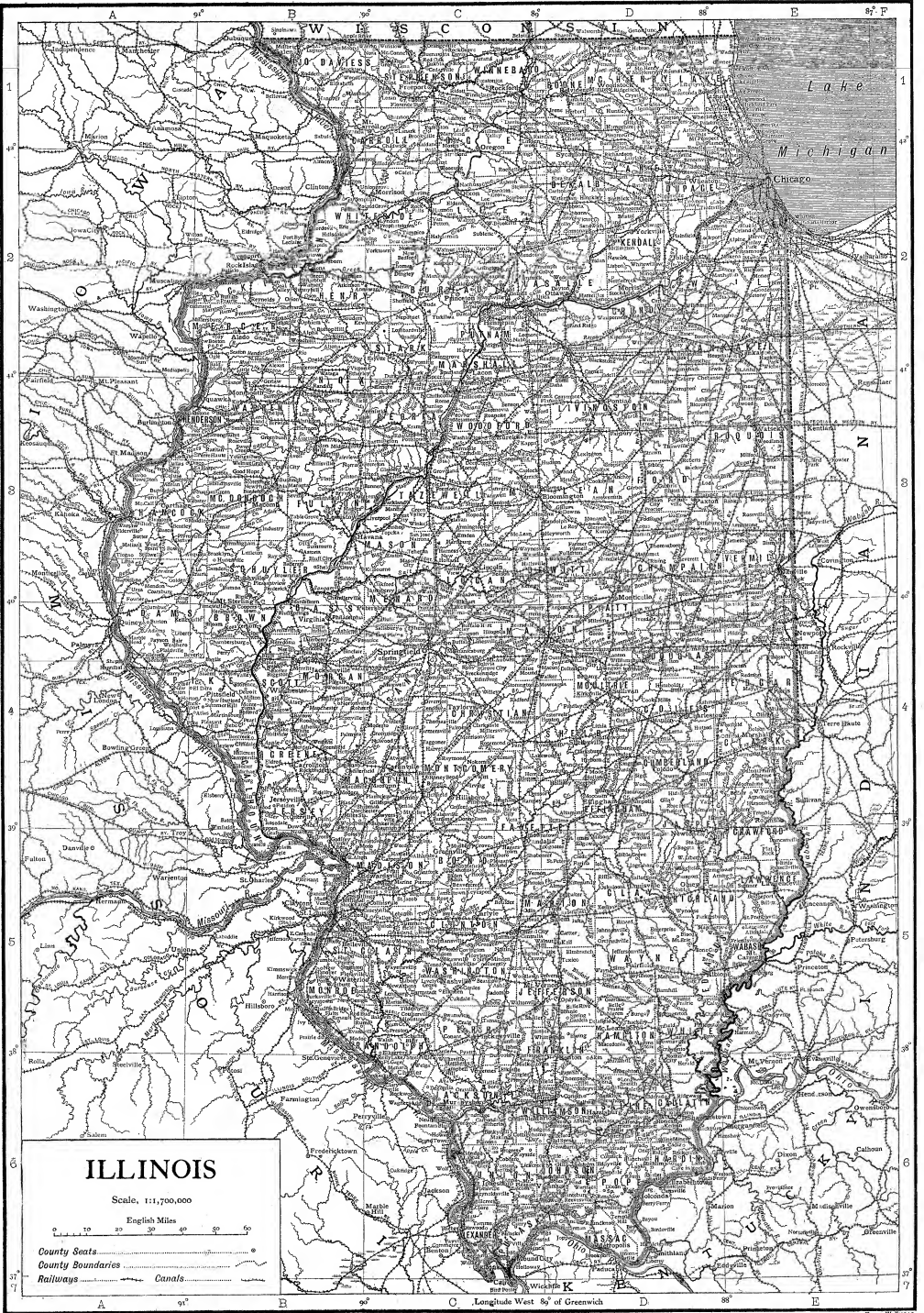

# ILLINOIS

Scale, 1:1,700,000

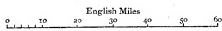

- County Seats
- County Boundaries
- Railways
- Canals

Longitude West 80° of Greenwich

Historically and comparatively, agriculture is the most important industry. In 1900 about nine-tenths of the total land area was inclosed in farms; the value of farm property (\$2,404,316,897) was greater than that of any other state; as regards the total value of farm products in 1890 Illinois was surpassed only by Iowa; in the value of crops Illinois led all the states, and the values of poultry and other products were respectively 35.6% and 87.1% greater than at the end of the preceding decade. During the last half of the 19th century the number of farms increased rapidly, and the average size declined from 158 acres in 1850 to 127.6 acres in 1870 and 124.2 acres in 1900. The prevailing form of tenure is that of owners, 60.7% of the farms being so operated in 1900; but during the decade 1890-1900 the number of farms cultivated by cash tenants increased 30.8%, and the number by share tenants 24.5% while the increase of cultivation by owners was only 1%. In proportion of farm lands improved (84.5%), Illinois was surpassed only by Iowa among the states. Cereals form the most important agricultural product (600,107,378 bushels in 1899—in value about three-fourths of the total agricultural products of the state). In the production of cereals Illinois surpassed the other states at the close of each decade during the last half of the 19th century except that ending in 1890, when Iowa was the leading state. Indian corn and oats are the most valuable crops. The rank of Illinois in the production of Indian corn was first in 1869 with about one-fifth of the total product, second in 1897 with nearly one-fourth, and one-tenth of the total crop of the country (5,521,000 bushels out of 99,931,000). In 1879, in 1899 and in 1905 (when it produced 133,779,762 bushels out of 953,216,197 from the entire country) it was first among the states producing oats, but it was surpassed by Iowa in 1880, 1906 and 1907; in 1907 the Illinois crop was 101,675,000 bushels. From 1850 until 1879 Illinois also led in the production of wheat; the competition of the more western states, however, caused a great decline in both acreage and production of that cereal, the state's rank in the number of bushels produced declining to third in 1880 and to fourteenth in 1899, but the crop and yield per acre in 1902 was larger than any since 1804; in 1905 the state ranked ninth, in 1906 eighth and in 1907 fifth (the crop being 40,104,000 bushels) among the wheat-growing states of the country. The rank of the state in the growing of rye also declined from second in 1870 to eighth in 1890 and to ninth in 1907 (when the crop was 1,106,000 bushels), and the rank in the growing of barley from third in 1869 to sixteenth in 1899. In 1907 the barley crop was 90,000 bushels, or 1.5% of the total, and first in 1907 among the most important crops; in 1907 2,664,000 acres produced 3,370,000 tons of hay valued at \$41,030,000. Potatoes and broom corn are other valuable products. The potato crop in 1907 was 13,398,000 bushels, valued at \$9,647,000, and the sugar beet, first introduced during the last decade of the 19th century, gave promise of becoming one of the most important crops. From 1880 to 1890 there was a distinct decline in the production of apples and peaches, but there was a great increase in that of cherries, plums and pears. The large urban population of the state makes animal products very valuable. Illinois ranking third in 1900 in the number of dairy cows, and in the farm value of dairy products; indeed, all classes of live stock, except sheep, increased in number from 1850 to 1900, and at the end of the latter year Illinois was surpassed only by Iowa in the number of horses and swine; in 1909 there were more horses in Illinois than in Iowa. Important influences in the agricultural development of the state have been the formation of Farmers' Institutes, organized in 1895, a Corn Breeders' Association in 1898, and the introduction of fertilizers, the use of which in 1890 was nearly seven times the amount in 1889, and the study of soils, carried on by the State Department of Agriculture and the United States Department of Agriculture.

The growth of manufacturing in Illinois during the last half of the 19th century, due largely to the development of her exceptional transportation facilities, was the most rapid and remarkable in the industrial history of the United States. In 1850 the state ranked fifteenth, in 1860 eighth, in 1870 sixth, in 1880 fourth, in 1890 and again in 1900 as regards the value of its manufactures. The average increases of invested capital and products for each decade from 1850-1900 were, respectively, 189-26% and 152-9%; in 1900 the capital invested (\$776,829,598, of which \$732,829,771 was in establishments under the "factory system"), and the product (\$1,259,730,168, of which \$1,200,868,308 was from establishments under the "factory system"), showed unusually small percentages of increase over those for 1890 (54.7% and 38.6% respectively); and in 1905 the capital and product of establishments under the "factory system" were respectively \$975,844,799 and \$1,410,342,129, showing increases of 33.2% and 25.8% over the corresponding figures for 1900.

The most important industry was the wholesale slaughtering and packing of meats, which yielded 22.9% of the total manufactured product of the state in 1900, and 22.5% of the total in

1905. From 1870 to 1905 Illinois surpassed the other states in this industry, yielding in 1900 and in 1905 more than one-third of the total product of the United States. The increase in the value of the product in this industry in Illinois between 1900 and 1905 was over 10%. An interesting phase of the industry is the secondary enterprises that have been developed out of it, nearly all portions of the slaughtered animal being finally put to use. The blood is converted into clarifying material, the entrails are used for sausage coverings, the hoofs and small bones furnish the raw material for the manufacture of glue, the large bones are carved into knife handles, and the horns into combs, the fats are made to yield butterine, lard and soap, and the hides and hair are used in the manufacture of mattresses and felts.

The manufacture of iron and steel products, and of products depending upon iron and steel as raw material, is second in importance. The iron for these industries is secured from the Lake Superior region, the coal and limestone from mines within the state. Indeed, in the manufacture of iron and steel, Illinois was surpassed in 1900 only by Pennsylvania and Ohio, the 1900 product being valued at \$60,303,144; but the value of foundry and machine shop products was even greater (\$63,878,352). In 1905 the iron and steel product had increased in value since 1900 44.9% to \$87,352,761; the foundry and machine shop products 25.2% to \$79,901,482; and the wire product showed even greater increase, largely because of a different classification in the two census years, the value in 1905 being \$14,099,556, as against \$2,879,188 in 1900, showing an increase of nearly 390%. The development of agriculture, by creating a demand for improved farm machinery, has stimulated the inventive genius; in many cases blacksmith shops have been transformed into machinery factories; also well-established companies of the eastern states have been induced to remove to Illinois by the low prices of iron and wood, due to cheap transportation rates on the Great Lakes. Consequently, in 1880, 1900 and again in 1905, Illinois surpassed any one of the other states in the production of agricultural implements, the product in 1900 being valued at \$42,033,796, or 41.5% of the total output of agricultural machinery in the United States; and in 1905 with a value of \$38,412,452 it represented 34.3% of the product of the entire country. In the building of railway cars by manufacturing corporations, Illinois also led the states in 1900 and in 1905, the product being valued at \$24,845,606 in 1900 and at \$30,926,464 (an increase of nearly one-fourth) in 1905; and in construction by railway companies second in 1900, with a product valued at \$16,580,424, which had increased 53.7% in 1905, when the product was valued at \$25,491,209. The greatest increase of products between 1890 and 1900 was in the manufacture of electrical apparatus (2400%), in which the increase in value of product was 37.2% between 1900 and 1905.

Another class of manufactures consists of those dependent upon agricultural products for raw material. Of these, the manufacture of distilled liquors was in 1900 and in 1905 its most important, Illinois leading the other states; the value of the product in 1905 was nearly 12% less than that of 1890, was increased by 41.6% to \$54,101,805, in 1905, Peoria, the centre of the industry, is the largest producer of whisky and high-class wines of the cities in the United States. There were also, in 1900, 35 direct and other indirect products made from Indian corn by glucose plants, which consumed one-fifth of the Indian corn product of the state, and the value of these products was \$18,122,814; in 1905 it was only \$14,532,180. Of other manufactures dependent upon agriculture, flour and grist mill products declined between 1890 and 1900, but between 1900 and 1905 increased 39.6% to the value of \$39,892,127. The manufacture of cheese, butter and condensed milk increased 60% between 1890 and 1900, but between 1900 and 1905 only 3.1%, the product in 1905 being valued at \$13,276,533.

Other prosperous industries are the manufacture of lumber and timber products (the raw material being floated down the Mississippi river from the forests of other states), whose output increased from 1890 to 1900 nearly 80%, but declined slightly between 1900 and 1905; of furniture \$27,431,846 in 1905; of musical instruments showing an increase of 44.8%, and of miscellaneous instruments (\$13,323,358 in 1905; \$8,156,445 in 1900; an increase of 63.3% in the period), in both of which Illinois was second in 1900 and in 1905; book and job printing, in which the state ranked second in 1900 (\$28,203,684 in 1905; \$19,761,780 in 1900; an increase of 43.2%), newspaper and periodical printing (\$28,644,981 in 1905; \$19,204,955 in 1900; an increase of 47.6%), in which it ranked third in 1900; and the manufacture of clothing, boots and shoes, the value of the clothing manufactured in 1905 was \$67,439,617 (men's \$55,202,999; women's \$12,236,618), an increase of 30.1% over 1900. The great manufacturing centre is Chicago, where more than seven-tenths of the manufactured products of the state were produced in 1900, and more than two-thirds in 1905.

In this development of manufactures, the mineral resources have been an important influence, nearly one-fourth (23.6%) of the manufactured product in 1900 depending upon minerals for raw material. Although the iron and steel industry is second in importance, and limestone is mined in the Lake Superior region, bituminous coal and limestone are supplied by the Illinois deposits. The great central coal field of North America extends into Illinois from

<sup>1</sup> The statistics for years prior to 1900 are taken from reports of the U. S. Census, those for years after 1900 from the *Year Books of the U. S. Department of Agriculture*. It should be borne in mind that in census years, when comparison can be made, the two sets of statistics often vary considerably.

Indiana as far N. as a line from the N. boundary of Grundy county to Rock Island, W. from Rock Island to Henderson county, then S.W. to the southern part of Jackson county, when it runs S. into Kentucky, thus including more than three-fourths (42,900 sq. m.) of the land surface of the state. In 1679 Hennepin reported deposits of coal near what is now Ottawa on the Illinois; there was some mining in 1810 on the Big Muddy river in Jackson county; and in 1833, 6,000 tons were mined. In 1907 (according to state authorities) coal was produced in 52 counties, Williamson, Sangamon, St. Clair, Macoupin and Madison giving the largest yield. In that year the tonnage was 51,317,146, and the value of the total product \$54,687,882; in 1908 the value of the state's product of coal was exceeded only by that of Pennsylvania (nearly six times as great). Nearly 30% of all coal mined in the state was mined by machinery in 1907. The output of petroleum in Illinois was long unimportant. The first serious attempts to find oil and gas in the state were in the 'fifties of the 19th century. In 1889 the yield of petroleum was 1460 barrels. In 1902 it was only 200 barrels, nearly all of which came from Litchfield, Montgomery county (where oil had been found in commercial quantities in 1886), and Washington, Tazewell county, in the west central part of the state; at this time it was used locally for lubricating purposes. There had been some drilling in Clark county in 1865, and in 1904 this field was again worked at Westfield. In 1905 the total output of the state was 181,084 barrels; in 1906 the amount increased to 4,397,050 barrels, valued at \$3,274,818; and in 1907, according to state reports, the output was 24,281,973 barrels, being nearly as great as that of the Appalachian field. The petroleum-producing area of commercial importance is a strip of land about 80 m. long, and of 3 to 10 or 12 m. wide in the S.E. part of the state, centering about Crawford county. In April 1906 the first pipe lines for petroleum in Illinois were laid; before that time all shipments had been in tank cars. In connexion with petroleum, natural gas has been found, especially in Clark and Crawford counties; in 1906 the state's product of natural gas was valued at \$87,211. Limestone is found in about 30 counties, principally Cook, Will and Kankakee; the value of the product in 1906 was \$2,942,331. Clay and clay products of the state were valued in 1906 at 12,795,453. Deposits of lead and zinc have been discovered and worked in Jo Daviess county, near Galena and Elizabeth, in the N.W. part of the state. A southern district, including parts of Hardin, Pope and Saline counties, has produced, including fluorspar, some lead, the maximum amount being 176,387 lb from the Fairview mine in 1866-1867. In 1905 the zinc from the entire state was valued at \$5,499,508; the lead product in 1906 was valued at \$65,208. Sandstone, quarried in 10 counties, was valued in 1905 at \$29,115 and in 1906 at \$19,125. Pope and Hardin counties were the only sources of fluorspar in the United States from 1842 until 1908, when fluorspar began to be mined in Kentucky; in 1906 the output was 28,268 tons, valued at \$160,623, and in 1905 33,275 tons, valued at \$220,206. The centre of the fluorspar district was Rosiclare in Hardin county. The cement deposits are also of value, natural cement being valued at \$118,221 and Portland cement at \$2,461,494 in 1906. Iron ore has been discovered. Glass sand is obtained from the Illinois river valley in La Salle county; in 1906 it was valued at \$156,684, making the state in this product second only to Pennsylvania and West Virginia (in 1905 it was second only to Pennsylvania). The value of the total mineral product of the state in 1906 was estimated at \$121,188,306.

**Communications.**—Transportation facilities have been an important factor in the economic development of Illinois. The first European settlers, who were French, came by way of the Great Lakes, and established intimate relations with New Orleans by the Mississippi river. The American settlers came by way of the Ohio river, and the immigrants from the New England and Eastern states found their way to Illinois over the Erie Canal and the Great Lakes. The first transportation problem was to connect Lake Michigan and the Mississippi river; this was accomplished by building the Illinois & Michigan canal to La Salle, at the head of the navigation on the Illinois river, a work which was begun in 1836 and completed in 1848 under the auspices of the state. In 1890 the Sanitary District of Chicago undertook the construction of a canal from Chicago to Joliet, where the new canal joins the Illinois & Michigan canal; this canal is 24 ft. deep and 160 ft. wide. The Federal government completed in October 1907 the construction of a

<sup>1</sup> According to the report of the State Geological Survey, the value of the total mineral product in the state for 1907 was \$152,122,648, the values of the different minerals being as follows: coal, \$54,687,382; pig iron, about \$52,228,000; petroleum, \$16,432,947; clay and clay products, \$13,351,362; zinc, \$6,614,608; limestone, \$4,333,651; Portland cement, \$2,632,576; sand and gravel, \$1,367,653; natural slag, \$174,282; fluorspar, \$14,971; mineral waters, \$91,700; lead ore, \$45,760; sandstone, \$14,996; and pyrite, \$5700.

new canal, the Illinois & Mississippi, popularly known as the Hennepin, from Hennepin to Rock river (just above the mouth of Green river), 7 ft. deep, 52 ft. wide (at bottom), and 80 ft. wide at the water-level. This canal provides, with the Illinois & Michigan canal and the Illinois river, an improved waterway from Chicago to the Mississippi river, and greatly increases the commercial and industrial importance of the "twin cities" of Sterling and Rock Falls, where the Rock river is dammed by a dam nearly 1500 ft. long, making the main feeder for the canal. This feeder, formally opened in 1907, runs nearly due S. to a point on the canal N.W. of Sheffield and N.E. of Mineral; there are important locks on either side of this junction. At the general election in November 1908 the people of Illinois authorized the issue of bonds to the amount of \$20,000,000 to provide for the canalizing of the Desplaines and Illinois rivers as far as the city of Utica, on the latter river, and connecting with the channel of the Chicago Sanitary District at Joliet. The situation of Illinois between the Great Lakes and the Appalachian Mountains has made it a natural gateway for railroads connecting the North Atlantic and the far Western states. The first railway constructed in the West was the Northern-Cross railroad from Meredosia on the Illinois river to Springfield, completed in 1842; during the last thirty years of the 19th century Illinois had a larger railway mileage than any of the American states, her mileage in January 1900 amounting to 12,215.63 m., second only to that of Texas. A Railway and Warehouse Commission has authority to fix freight and passenger rates for each road. It is the oldest commission with such power in the United States, and the litigation with railways which followed its establishment in 1871 fully demonstrated the public character of the railway business and was the precedent for the policy of state control elsewhere.<sup>2</sup>

**Population.**—In 1870 and 1880 Illinois was fourth among the states of the United States in population; but in 1890, in 1900, and in 1910, its rank was third, the figures for the last three years named being respectively 3,826,351, 4,821,550, and 5,638,591.<sup>3</sup> The increase from 1880 to 1890 was 24.3%; from 1890 to 1900, 26%. Of the population in 1900, 98.2% was white, 79.9% was native-born, and 51.2% was of foreign parentage (either one or both parents foreign-born). The principal foreign element was German, the Teutonic immigration being especially large in the decade ending in 1860; the immigrants from the United Kingdom were second in importance, those from the Scandinavian countries third, and those from southern Europe fourth. The urban population, on the basis of places having 4000 inhabitants or more, was 51% of the total; indeed the population of Cook county, in which the city of Chicago is situated, was two-fifths of the total population of the state; during the decade of the Civil War (1860-1870) the population of the state increased only 48.4%, and that of Cook county about 140%, while from 1870 to 1900 the increase of all counties, excluding Cook, was about 36%, the increase in Chicago was about 468%. Of the 100 incorporated cities, towns and villages, 614 had less than 1000 inhabitants, 27 more than 5000 and less than 10,000, 14 more than 10,000 and less than 20,000, 4 more than 20,000 and less than 25,000, and 7 more than 25,000. These seven were Chicago (1,698,575), the second city in population in the United States, Peoria (56,100), Quincy (36,252), Springfield (34,159), Rockford (31,051), East St. Louis (29,655), and Joliet (29,353). In 1906 it was estimated that the total number of communicants of all denominations was 2,077,197, and that of this total 932,084 were Roman Catholics, 263,344 were Methodist (235,092 of the Northern Church, 7198 of the Southern Church, 9833 of the African Methodist Episcopal Church, 5512 of the Methodist Protestant Church, and 3507 of the Free Methodist Church of North America), 202,566 were Lutherans (113,527 of the Evangelical Lutheran Synodical

<sup>2</sup> See the so-called *McLean County Case* (67 Ill. 11), the *Neal Ruggles Case* (91 Ill. 256), *The People v. The Illinois Central Railroad Co.* (95 Ill. 313), and *Munn v. Ill.* (94 U.S. 113).

<sup>3</sup> The populations in other census years were: (1810), 12,282; (1820), 55,211; (1830), 157,445; (1840), 476,183; (1850), 851,470; (1860), 1,711,951; (1870), 2,539,891; (1880), 3,077,871.



Conference, 36,366 of the General Council of the Evangelical Lutheran Church, 14,768 of the General Synod of the Evangelical Lutheran Church, and 14,005 of the Evangelical Lutheran Synod of Iowa and other states), 152,870 were Baptists (118,884 of the Northern Convention, 16,081 of the National (Colored) Baptist Convention, 7755 Free Baptists, 6671 General Baptists, and 5163 Primitive Baptists), 115,602 were Presbyterian (86,251 of the Northern Church, 17,208 of the Cumberland Church (now a part of the Northern Church), and 9555 of the United Presbyterian Church), 101,516 were Disciples of Christ, 59,973 were members of the German Evangelical Synod of North America, 54,875 were Congregationalists, and 36,364 were Protestant Episcopalians.

**Government.**—Illinois has been governed under four constitutions, a Territorial constitution of 1812, and three State constitutions of 1818, 1848 and 1870 (subsequently amended). Amendments may be made by a Constitutional Convention or a two-thirds vote of all the members elected to the legislature, ratification by the people being required in either instance. To call a Constitutional Convention it is necessary that a majority popular vote concur in the demand thereof of two-thirds of the members of each house of the General Assembly. The executive officials hold office for four years, with the exception of the treasurer, whose term of service is two years. The governor must be at least thirty years of age, and he must also have been a citizen of the United States and of Illinois for the five years preceding his election. His veto may be over-ridden by a two-thirds vote of all the members elected to the legislature. Members of the legislature, which meets biennially, are chosen by districts, three representatives and one senator from each of the 51 districts, 18 of which are in Cook county. The term of senators is four years, that of representatives two years; and in the election of representatives since 1870 there has been a provision for "minority" representation, under which by cumulative voting each voter may cast as many votes for one candidate as there are representatives to be chosen, or he may distribute his votes (giving three votes to one candidate, or 1½ votes each to two candidates, or one vote each to three candidates), the candidate or candidates receiving the highest number of votes being elected. A similar system of cumulative voting for aldermen may be provided for by ordinance of councils in cities organized under the general state law of 1872. Requisites for membership in the General Assembly are citizenship in the United States; residence in Illinois for five years, two of which must have been just preceding the candidate's election; and an age of 25 years for senators, and of 21 years for representatives. Conviction for bribery, perjury or other infamous crime, or failure (in the case of a collector or holder of public moneys) to account for and pay over all moneys due from him are disqualifications; and before entering upon the duties of his office each member of the legislature must take a prescribed oath that he has neither given nor promised anything to influence voters at the election, and that he will not accept, directly or indirectly, "money or other valuable thing from any corporation, company or person" for his vote or influence upon proposed legislation. Special legislation is prohibited when general laws are applicable, and special and local legislation is forbidden in any of twenty-three enumerated cases, among which are divorce, changing of an individual's name or the name of a place, and the grant to a corporation of the right to build railways or to exercise any exclusive franchise or privilege. The judiciary consists of a supreme court of 7 members elected for a term of 9 years; a circuit court of 54 judges, 3 for each of 18 judicial districts, elected for 6 years; and four appellate courts—one for Cook county (which has also a "branch appellate court," both the court and the branch court being presided over by three circuit judges appointed by the Supreme Court) and three other districts, each with three judges appointed in the same way. In Cook county a criminal court, and the supreme court of Cook county (originally the supreme court of Chicago), supplement the work of the circuit court. There are also county courts, consisting of one judge who serves

for four years; in some counties probate courts have been established, and in counties of more than 500,000 population juvenile courts for the trial and care of delinquent children are provided for.

The local government of Illinois includes both county and township systems. The earliest American settlers came from the Southern States and naturally introduced the county system; but the increase of population from the New England and Middle States led to a recognition of township organization in the constitution of 1848, and this form of government, at first prevalent only in the northern counties, is now found in most of the middle and southern counties. Cook county, although it has a township system, is governed, like those counties in which townships are not found, by a Board of Commissioners, elected by the townships and the city of Chicago. A general law of 1872 provides for the organization of municipalities, only cities and villages being recognized, though there are still some "towns" which have failed to reorganize under the new law. City charters are granted only to such municipalities as have a population of at least 1000.

Requirements for suffrage are age of 21 years or more, citizenship in the United States, and residence in the state for one year, in the county ninety days, and the election precinct thirty days preceding the exercise of suffrage. Women are permitted to vote for certain school officials and the trustees of the State University. Disfranchisement is brought about by conviction for bribery, felony or infamous crime, and an attempt to vote after such conviction is a felony.

The relation of the state to corporations and industrial problems has been a subject of important legislation. The constitution declares that the state's rights of eminent domain shall never be so abridged as to prevent the legislature from taking the property and franchises of incorporated companies and subjecting them to the public necessity in a way similar to the treatment of individuals. In 1903 the legislature authorized the municipal ownership of public service corporations, and in 1905 the city of Chicago took steps to acquire ownership of its street railways—a movement which seemed to have spent its force in 1907, when the municipal ownership candidates were defeated in the city's elections—and in 1902 the right of that city to regulate the price of gas was recognized by the United States Circuit Court of Appeals. Railways organized or doing business in the state are required by the constitution to have a public office where books for public inspection are kept, showing the amount of stock, its owners, and the amount of the road's liabilities and assets. No railway company may now issue stock except for money, labour, or property actually received and applied to purposes for which the corporation was organized. In 1907 a law went into effect making two cents a mile a maximum railway fare. An anti-trust law of 1893 exempted from the definition of trust combinations those formed by producers of agricultural products and live stock, but the United States Supreme Court in 1902 declared the statute unconstitutional as class legislation. According to a revised mining law of 1899 (subsequently amended), all mines are required to be in charge of certified mine managers, mine examiners, and hoisting engineers, when the services of the engineers are necessary; and every mine must have an escapement shaft distinct from the hoisting shaft. The number of men permitted to work in any mine not having an escapement shaft cannot, in any circumstances, exceed ten during the time in which the escapement or connexion is being completed.

Economic conditions have also led to an increase of administrative boards. A State Civil Service Commission was created by an act of the General Assembly of 1905. A Bureau of Labor Statistics (1879), whose members are styled Commissioners of Labor, makes a study of economic and financial problems and publishes biennial reports; a Mining Board (1883) and an inspector of factories and workshops (since 1893) have for their duty the enforcement of labour legislation. There are also a State Food Commission (1896) and a Live Stock Commission (1885). A Board of Arbitration (1805) has authority to make and publish investigations of all facts relating to strikes and

lock-outs, to issue subpoenas for the attendance and testifying of witnesses, and "to adjust strikes or lock-outs by mediation or conciliation, without a formal submission to arbitration."

The employment of children under 14 years of age in factories or mines, and working employees under 16 years of age for more than 60 hours a week, are forbidden by statute. The state has an excellent "Juvenile Court Law," which came into force on the 1st of July 1899 and has done much good, especially in Chicago. The law recognized that a child should not be treated like a mature malefactor, and provided that there should be no criminal procedure, that the child should not be imprisoned or prosecuted, that his interests should be protected by a probation officer, that he should be discharged unless found dependent, delinquent or truant, and in such case that he should be turned over to the care of an approved individual or charitable society. This law applies to counties having a minimum population of 500,000. The legal rate of interest is 5%, but this may be increased to 7% by written contract. A homestead owned and occupied by a householder having a family is exempt (to the amount of \$1000) from liability for debts, except taxes upon, and purchase money for, the same. Personal property to the value of \$300 also is exempt from liability for debt. Grounds for divorce are impotence of either party at time of marriage, previous marriage, adultery, wilful desertion for two years, habitual drunkenness, attempt on life, extreme and repeated cruelty, and conviction of felony or other infamous crime. The marriage of cousins of the first degree is declared incestuous and void. In June 1907 the Supreme Court of Illinois declared the sale of liquor not a common right and "sale without license a criminal offence," thus forcing clubs to close their bars or take out licenses.

The charitable institutions of the state are under the management of local trustees appointed by the governor. They are under the supervision of the Board of State Commissioners of Public Charities (five non-salaried members appointed by the governor); in 1908 there were 18 institutions under its jurisdiction. Of these, seven were hospitals for the insane—six for specific parts of the state, viz. northern at Elgin, eastern at Kankakee, central at Jacksonville, southern at Anna, western at Watson, and general at South Bartonville, and one at Chester for insane criminals. The others were the State Psychopathic Institute at Kankakee (established in 1907 as part of the insane service) for systematic study of mental and nervous diseases; one at Lincoln having charge of feeble-minded children; two institutions for the blind—a school at Jacksonville and an industrial home at Marshall Boulevard and 19th Street, Chicago; a home for soldiers and sailors (Quincy), one for soldiers' orphans (Normal), and one for soldiers' widows (Wilmetton); a school for the deaf (Jacksonville), and an eye and ear infirmary (Chicago). The Board of Charities also had supervision of the State Training School for (delinquent) Girls (1893) at Geneva, and of the St Charles School for (delinquent) Boys (1901) at St. Charles.

The trustees of each penal institution are appointed by the governor, and the commissioners of the two penitentiaries and the managers of the state reformatory compose a Board of Prison Industries. There were in 1908 two penitentiaries, one at Joliet and one at Chester, and, in addition to the two reformatory institutions for young offenders under the supervision of the Board of Charities, there is a State Reformatory for boys at Pontiac. The indeterminate sentence and parole systems are important features of the treatment of criminals. All but two of the counties have almshouses. In 1908, in some counties, the care of paupers was still let by contract to the lowest bidder or the superintendent was paid between \$1-00 and \$1-80—sceldom more than \$1-50—a week for each patient, and he paid a small (or no) rent on the county farm. Complete state control of the insane and the introduction of modern hospital and curative treatment in the state asylums (or hospitals) are gradually taking the place of county care for the insane and of antiquated custodial treatment in and political control of the state asylums—changes largely due to the action of Governor Deneen, who appointed in 1906 a Board of Charities pledged to reform. By a law of 1905 all employed in such institutions were put on a civil service basis. In 1907-1908, \$1,500,000 was spent in rehabilitating old buildings and in buying new land and erecting buildings.

**Education.**—Public education in Illinois had its genesis in the land of the North-West Territory reserved for educational purposes by the Ordinance of 1787. The first state school law, which provided for state taxation for public schools, was enacted in 1825. The section providing for taxation, however, was

repealed, but free schools supported by the sale of land reserved for education and by local taxation were established as early as 1834. In 1855 a second school law providing for a state school tax was enacted, and this is the foundation of the existing public school system; the constitution of 1870 also requires the legislature to provide a thorough and efficient system of public schools. In 1907-1908 the total school revenue, nine-tenths of which was derived from local taxation and the remainder chiefly from a state appropriation (for the year in question, \$1,057,000) including the proceeds derived from permanent school funds secured by the gift and sale of public lands on the part of the United States Government, was \$30,980,510-22. The attendance in some school of all children from 7 to 16 years of age is compulsory, and of the population of school age (1,500,066) 988,078 were enrolled in public schools. The average length of the school term in 1908 was 7-8 months, and the average monthly salary of teachers was \$82-12 for men and \$60-76 for women.

The state provides for higher education in the University of Illinois, situated in the cities of Champaign and Urbana. It was founded in 1867, through the United States land grant of 1862, as the Illinois Industrial University, and received its present name in 1885; since 1870 it has been co-educational. Associated with the University are the State Laboratory of Natural History, the State Water Survey, the State Geological Survey, the State Entomologist's Office, and Agricultural and Engineering Experiment Stations. The University confers degrees in arts, science, engineering, agriculture, law, medicine, pharmacy, dentistry, music, and library science; besides the usual subjects, it has a course in ceramics. The University publishes *Bulletins* of the Agricultural and Engineering Experiment Stations; *Reports* of the State Water Survey, of the State Natural History Survey, of the State Geological Survey, and of the State Entomologist's Office; *University Studies*; and *The Journal of English and German Philology*. The schools of medicine, pharmacy and dentistry are in Chicago. The faculty in 1907 numbered 408, and the total enrolment of students in 1907-1908 was 4743 (of whom 991 were women), distributed (with 13 duplicates in the classification) as follows: Graduate School, 203; Undergraduate Colleges, 2812; Summer Session, 367; College of Law, 186; College of Medicine, 476; College of Dentistry, 76; School of Pharmacy, 259; Academy, 377. In 1908 the University had a library of 103,000 volumes. The trustees of the institution, who have legislative power only, are the governor, the President of the Board of Agriculture, the State Superintendent of Public Instruction, and nine others elected by the people. There were in 1907 more than forty other universities and colleges in the state, the most important being the University of Chicago, North-western University at Evanston, Illinois Wesleyan University at Bloomington, Knox College, Galesburg, and Illinois College at Jacksonville. There were also six normal colleges, five of them public: the Southern Illinois State Normal College at Carbondale, the Eastern Illinois State Normal School at Charleston, the Western Illinois State Normal School at Macomb, the Chicago Normal School at Chicago, the Northern Illinois State Normal School at DeKalb, and the Illinois State Normal University at Normal.

**Finance.**—The total receipts for the biennial period ending the 30th of September 1908 were \$19,588,842-06, and the disbursements were \$21,278,805-27; and on the 1st of October 1908 there was a balance in the treasury of \$3,859,263-44. The bonded debt on the same date was \$17,500; these bonds ceased to bear interest in 1882, but although called in by the governor they have never been presented for payment. The system of revenue is based upon the general property tax; the local assessment of all real and personal property is required, with the aim of recording all kinds of property upon the assessment rolls. Boards of Revision and Boards of Supervision then equalize the assessments in the counties and townships, while a State Board of Equalization seeks to equalize the total valuation of the various counties. The tendency is for property valuations to decline, the estimated valuation from 1873 to 1893 decreasing 27% in Cook county and 39% in the other counties, while the assessments from 1888 to 1898 were in inverse ratio to the increase of wealth. There has also been great inequality in valuations, the increase of valuation in Cook county made in

compliance with the revenue law of 1898 being \$200,000,000, while that for the rest of the state was only \$4,000,000. Among other sources of revenue are an inheritance tax, which yields approximately \$1,000,000 a year, and 7% of the annual gross earnings of the Illinois Central railway, given in return for the state aid in the construction of the road. The constitution prohibits the state from lending its credit or making appropriations in aid of any corporation, association or individual, and from constructing internal improvements, and the counties, townships, and other political units cannot incur indebtedness in excess of 5% of their assessed property valuation. The legislature may not contract a debt of more than \$250,000 except to suppress treason, war or invasion, and no legislative appropriation may extend longer than the succeeding legislature. General banking laws must be submitted to the people for ratification.

*History.*—Illinois is the French form of Iliniwek, the name of a confederacy of Algonquian tribes. The first exploration by Europeans was that of the French. In 1659 Pierre Radisson and Medard Chouart des Gosseliers seem to have reached the upper Mississippi. It is certain that in 1673 part of the region known as the Illinois country was explored to some extent by two Frenchmen, Louis Joliet and Jacques Marquette, a Jesuit father. Marquette, under orders to begin a mission to the Indians, who were known to the French by their visits to the French settlements in the Lake Superior region, and Joliet, who acted under orders of Jean Talon, Intendant of Canada, ascended the Fox river, crossed the portage between it and the Wisconsin river, and followed that stream to the Mississippi, which they descended to a point below the mouth of the Arkansas. On their return journey they ascended the Illinois river as far as Lake Peoria; they then crossed the portage to Lake Michigan, and in 1675 Marquette founded a mission at the Indian town of Kaskaskia, near the present Utica, Ill. In 1679 the explorer La Salle, desiring to find the mouth of the Mississippi and to extend the domain of France in America, ascended the St Joseph river, crossed the portage separating it from the Kankakee, which he descended to the Illinois, and built in the neighbourhood of Lake Peoria a fort which he called Fort Crevecoeur. The vicissitudes of the expedition, the necessity for him to return to Canada for tools to construct a large river-boat, and opposition in Canada to his plans, prevented him from reaching the mouth of the Illinois until the 6th of February 1682. After such preliminary explorations, the French made permanent settlements, which had their origin in the missions of the Jesuits and the bartering posts of the French traders. Chief of these were Kaskaskia, established near the mouth of the Kaskaskia river, about 1720; Cahokia, a little below the mouth of the Missouri river, founded at about the same time; and Fort Chartres, on the Mississippi between Cahokia and Kaskaskia, founded in 1720 to be a link in a chain of fortifications intended to extend from the St Lawrence to the Gulf of Mexico. A monument of the labours of the missionaries is a manuscript dictionary (c. 1720) of the language of the Illinois, with catechism and prayers, probably the work of Father Le Boulanger.

In 1712 the Illinois river was made the N. boundary of the French province of Louisiana, which was granted to Antoine Crozat (1655-1738), and in 1721 the seventh civil and military district of that province was named Illinois, which included more than one-half of the present state, the country between the Arkansas river and the line 43° N. lat., as well as the country between the Rocky Mountains and the Mississippi; but in 1723 the region around the Wabash river was formed into a separate district. The trade of the Illinois country was now diverted to the settlements in the lower Mississippi river, but the French, although they were successful in gaining the confidence and friendship of the Indians, failed to develop the resources of the country. By the treaty of Paris, 1763, France ceded to Great Britain her claims to the country between the Ohio and Mississippi rivers, but on account of the resistance of Pontiac, a chief of the Ottawa who drew into conspiracy most of the tribes between the Ottawa river and the lower Mississippi, the English were not able to take possession of the country until 1765, when the French flag was finally lowered at Fort Chartres.

The policy of the British government was not favourable to the economic development of the newly-acquired country, since it was feared that its prosperity might react against the trade and industry of Great Britain. But in 1769 and the succeeding years of English control, this policy was relaxed, and immigration from the seaboard colonies, especially from Virginia, began. In 1771 the people of the Illinois country, through a meeting at Kaskaskia, demanded a form of self-government similar to that of Connecticut. The petition was rejected by General Thomas Gage; and Thomas Legge, earl of Dartmouth (1731-1801), Secretary of State for Plantations and President of the Board of Trade, drew up a plan of government for Illinois in which all officials were appointed by the crown. This, however, was never operative, for in 1774, by the famous Quebec Act, the Illinois country was annexed to the province of Quebec, and at the same time the jurisdiction of the French civil law was recognized. These facts explain the considerable sympathy in Illinois for the colonial cause in the War of Independence. Most of the inhabitants, however, were French, and these were Loyalists. Consequently, the British government withdrew their troops from the Illinois country. The English authorities instigated the Indians to make attacks upon the frontiers of the American colonies, and this led to one of the most important events in the history of the Illinois country, the capture of the British posts of Cahokia and Kaskaskia in 1778, and in the following year of Vincennes (Indiana), by George Rogers Clark (*q.v.*), who acted under orders of Patrick Henry, Governor of Virginia. These conquests had much to do with the securing by the United States of the country W. of the Alleghanies and N. of the Ohio in the treaty of Paris, 1783.

The Virginia House of Delegates, in 1778, extended the civil jurisdiction of Virginia to the north-west, and appointed Captain John Todd (1750-1782), of Kentucky, governor of the entire territory north of the Ohio, organized as "The County of Illinois"; the judges of the courts at Cahokia, Kaskaskia, and Vincennes, who had been appointed under the British administration, were now chosen by election; but this government was confined to the old French settlements and was entirely inefficient. In 1787, Virginia and the other states having relinquished their claims to the country west of the Alleghanies, the North-West Territory was organized by Congress by the famous Ordinance of 1787. Two years later St Clair county was formed out of the S.W. part of the Illinois country, while the E. portion and the settlements around Vincennes (Indiana) were united into the county of Knox, and in 1795 the S. part of St Clair county was organized into Randolph county, with Kaskaskia as the seat of administration. In 1800 the Illinois country was included in the Territory of Indiana, and in 1809 the W. part of Indiana from Vincennes N. to Canada was organized as the Territory of Illinois; it included, besides the present territory of the state, all of Wisconsin except the N. part of the Green Bay peninsula, a considerable part of Michigan, and all of Minnesota E. of the Mississippi. In 1812, by permission of Congress, a representative assembly was chosen, a Territorial constitution was adopted, and the Territorial delegate in Congress was elected directly by the people.

In 1818 Illinois became a state of the American Union, the Enabling Act fixing the line 42° 30' as the N. boundary, instead of that provided by the Ordinance of 1787, which passed through the S. bend of Lake Michigan. The reason given for this change was that if the Mississippi and Ohio rivers were the only outlets of Illinois trade, the interests of the state would become identified with those of the southern states; but if an outlet by Lake Michigan were provided, closer relations would be established with the northern and middle states, and so "additional security for the perpetuity of the Union" would be afforded.

Among the first problems of the new state were those relating to lands and Indians. Throughout the Territorial period there was conflict between French and English land claims. In 1804 Congress established land offices at Kaskaskia and Vincennes to examine existing claims and to eliminate conflict with future grants; in 1812 new offices were established at

Shawneetown and Edwardsville for the sale of public lands; and in 1816 more than 500,000 acres were sold. In 1818, however, many citizens were in debt for their lands, and "squatters" invaded the rights of settlers. Congress therefore reduced the price of land from \$2 to \$1.25 per acre, and adopted the policy of pre-emption, preference being given to the claims of existing settlers. The Indians, however, resisted measures looking toward the extinguishment of their claims to the country. Their dissatisfaction with the treaties signed in 1795 and 1804 caused them to espouse the British cause in the War of 1812, and in 1812 they overpowered a body of soldiers and settlers who had abandoned Fort Dearborn (See CHICAGO). For a number of years after the end of the conflict, the Indians were comparatively peaceful; but in 1831 the delay of the Sauk and Foxes in withdrawing from the lands in northern Illinois, caused Governor John Reynolds (1788-1865) to call out the militia. The following year Black Hawk, a Sauk leader, opened an unsuccessful war in northern Illinois and Wisconsin (the Black Hawk War); and by 1833 all Indians in Illinois had been removed from the state.

The financial and industrial policy of the state was unfortunate. Money being scarce, the legislature in 1810 chartered a state bank which was authorized to do business on the credit of the state. In a few years the bank failed, and the state in 1831 borrowed money to redeem the depreciated notes issued by the bank. A second state bank was chartered in 1835; two years later it suspended payment, and in 1843 the legislature provided for its liquidation. The state also undertook to establish a system of internal improvements, granting a loan for the construction of the Illinois and Michigan canal in 1836, and in 1837 appropriating \$10,000,000 for the building of railroads and other improvements. The experiment proved unsuccessful; the state's credit declined and a heavy debt was incurred, and in 1840 the policy of aiding public improvements was abandoned. Through the efforts of Governor Thomas Ford (1800-1850) a movement to repudiate the state debt was defeated, and a plan was adopted by which the entire debt could be reduced without excessive taxation, and by 1880 practically the entire debt was extinguished.

A notable incident in the history of the state was the immigration of the Mormons from Missouri, about 1840. Their principal settlements were in Hancock county. They succeeded in securing favours from the legislature, and their city of Nauvoo had courts and a military organization that was independent of state control. Political intrigue, claims of independence from the state, as well as charges of polygamy and lawless conduct, aroused such intense opposition to the sect that in 1844 a civil war broke out in Hancock county which resulted in the murder of Joseph Smith and the removal of the Mormons from Illinois in 1846.

The slavery question, however, was the problem of lasting political importance. Slaves had been brought into the Illinois country by the French, and Governor Arthur St Clair (1734-1818) interpreted the article of the Ordinance of 1787, which forbade slavery in the North-West Territory, as a prohibition of the introduction of slaves into the Territory, not an interference with existing conditions. The idea also arose that while negroes could not become slaves, they could be held as indentured servants, and such servitude was recognized in the Indiana Code of 1803, the Illinois constitution of 1818, and Statutes of 1819; indeed there would probably have been a recognition of slavery in the constitution of 1818 had it not been feared that such recognition would have prevented the admission of the state to the Union. In 1823 the legislature referred to the people a resolution for a constitutional convention to amend the constitution. The aim, not expressed, was the legalization of slavery. Although a majority of the public men of the state, indeed probably a majority of the entire population, was either born in the Southern states or descended from Southern people, the resolution of the legislature was rejected, the leader of the opposition being Governor Edward Coles (1786-1868), a Virginia slave-holder, who had freed his slaves on coming to

Illinois, and at least one half the votes against the proposed amendment of the constitution were cast by men of Southern birth. The opposition to slavery, however, was at first economic, not philanthropic. In 1837 there was only one abolition society in the state, but chiefly through the agitation of Elijah P. Lovejoy (see ALTON), the abolition sentiment grew. In 1842 the moral issue had become political, and the Liberty Party was organized, which in 1848 united with the Free Soil Party; but as the Whig Party approved the policy of non-extension of slavery, these parties did not succeed so well united as under separate existence. In 1854, however, the Liberty and Free Soil parties, the Democrats opposed to the Kansas-Nebraska Bill, and some Whigs united, secured a majority in the legislature, and elected Lyman Trumbull United States senator. Two years later these elements formally organized as the Republican Party, though that name had been used locally in 1854, and elected their candidates for state offices. This was the first time that the Democratic Party had been defeated, its organization having been in control since the admission of Illinois to the Union. An important influence in this political revolution was a change in the character of the population. Until 1848 the Southern element predominated in the population, but after that year the immigration from the Northern states was greater than that from the South, and the foreign element also increased.<sup>1</sup> The opposition to slavery continued to be political and economic rather than philanthropic. The constitution of 1848, which abolished slavery, also forbade the immigration of slaves into the state.<sup>2</sup> In 1858 occurred the famous contest for the office of United States senator between Stephen A. Douglas (Democrat) and Abraham Lincoln (Republican). Douglas was elected, but the vote showed that Illinois was becoming more Northern in sympathy, and two years later Lincoln, then candidate for the presidency, carried the state.

The policy of Illinois in the early period of secession was one of marked loyalty to the Union; even in the S. part of the state, where there was a strong feeling against national interference with slavery, the majority of the people had no sympathy with the pro-slavery men in their efforts to dissolve the Union. The legislature of 1861 provided for a war fund of \$2,000,000; and Capt. James H. Stokes (1814-1890) of Chicago transferred a large amount of munitions of war from St. Louis, where the secession sentiment was strong, to Alton. The state contributed 255,002 men to the Federal armies. From 1862-1864, however, there was considerable opposition to a continuance of the war. This was at first political; the legislature of 1862 was Democratic, and for political purposes that body adopted resolutions against further conflict, and recommended an armistice, and a national convention to conclude peace. The same year a convention, whose duty was to revise the constitution, met. It declared that the law which called it into being was no longer binding, and that it was supreme in all matters incident to amending the constitution. Among its acts was the assumption of the right of ratifying a proposed amendment to the constitution of the United States which prohibited Congress from interfering with the institution of slavery within a state, although the right of ratification belonged to the legislature. The convention also inserted clauses preventing negroes and mulattoes from immigrating into the state and from voting and holding office; and although the constitution as a whole was rejected by the people, these clauses were ratified. In 1863 more pronounced opposition to the policy of the National Government developed. A mass meeting, which met at Springfield in July, at the instance of-

<sup>1</sup> The influence of immigration and sectionalism upon Illinois politics is well illustrated by the fact that the first six governors (1818-1838) were born in the Southern states, six of the eight United States senators of that period were also Southern born, and all of the representatives, with one exception, also came to Illinois from the Southern states. After 1838 the Eastern states began to be represented among the governors, but until 1901 no governor was elected who was a native of Illinois. See E. B. Greene, *Sectional Forces in the History of Illinois* (Publications of the Historical Library of Illinois, No. 8, 1903).

<sup>2</sup> In the slavery issue of 1848 the sentiment for abolition centred in the northern counties, the opposition in the southern.

the Democratic Party, adopted resolutions that condemned the suspension of the writ of Habeas Corpus, endorsed the doctrine of state sovereignty, demanded a national assembly to determine terms of peace, and asked President Lincoln to withdraw the proclamation that emancipated the slaves, and so to permit the people of Illinois to fight only for "Union, the Constitution and the enforcement of the laws." The Knights of the Golden Circle, and other secret societies, whose aims were the promulgation of state sovereignty and the extension of aid to the Confederate states, began to flourish, and it is said that in 1864 there were 50,000 members of the Sons of Liberty in the state. Captain T. Henry Hines, of the Confederate army, was appointed by Jefferson Davis to co-operate with these societies. For a time his headquarters were in Chicago, and an elaborate attempt to liberate Confederate prisoners in Chicago (known as the Camp Douglas Conspiracy) was thwarted by a discovery of the plans. In the elections of 1864 the Republicans and Union Democrats united, and after an exciting campaign they were successful. The new legislature was the first among the legislatures of the states to ratify (on the 1st of February 1865) the Thirteenth Amendment.

From the close of the Civil War until the end of the 19th century the Republican Party was generally dominant, but the trend of political development was not without interest. In 1872 many prominent men of the state joined the Liberal Republican Party, among them Governor John M. Palmer, Senator Lyman Trumbull and Gustavus Koerner (1800-1896), one of the most prominent representatives of the German element in Illinois. The organization united locally, as in national politics, with the Democratic Party, with equally ineffective results. Economic depression gave the Granger Movement considerable popularity, and an outgrowth of the Granger organization was the Independent Reform Party, of 1874, which advocated retrenchment of expenses, the state regulation of railways and a tariff for revenue only. A Democratic Liberal Party was organized in the same year, one of its leaders being Governor Palmer; consequently no party had a majority in the legislature elected in 1874. In 1876 the Greenback Party, the successor in Illinois of the Independent Reform Party, secured a strong following; although its candidate for governor was endorsed by the Democrats, the Republicans regained control of the state administration.

The relations between capital and labour have resulted in serious conditions, the number of strikes from 1880-1901 having been 2640, and the number of lock-outs 95. In 1883 the governor found it necessary to use the state militia to suppress riots in Will and Cook counties occasioned by the strikes of quarrymen, and the following year the militia was again called out to suppress riots in St Clair and Cook counties caused by the widespread strike of railway employees. The most noted instance of military interference was in 1894, when President Grover Cleveland sent United States troops to Chicago to prevent strikers and rioters from interfering with the transmission of the United States mails.

Municipal problems have also reacted upon state politics. From 1897 to 1903 the efforts of the Street Railway Companies of Chicago to extend their franchise, and of the city of Chicago to secure municipal control of its street railway system, resulted in the statute of 1903, which provided for municipal ownership. But the proposed issue under this law of bonds with which Chicago was to purchase or construct railways would have increased the city's bonded indebtedness beyond its constitutional limit, and was therefore declared unconstitutional in April 1907 by the supreme court of the state.

A law of 1901 provided for a system of initiative whereby any question of public policy might be submitted to popular vote upon the signature of a written petition therefor by one-tenth of the registered voters of the state; such a petition must be filed at least 60 days before the election day when it is to be voted upon, and not more than three questions by initiative may be voted on at the same election; to become operative a measure must receive a majority of all votes cast in the election.

Under this act, in 1902, there was a favourable vote (451,310 to 76,975) for the adoption of measures requisite to securing the election of United States senators by popular and direct vote, and in 1903 the legislature of the state (which in 1891 had asked Congress to submit such an amendment) adopted a joint resolution asking Congress to call a convention to propose such an amendment to the Federal Constitution; in 1904 there was a majority of all the votes cast in the election for an amendment to the primary laws providing that voters may vote at state primaries under the Australian ballot. The direct primary law, however, which was passed immediately afterwards by the legislature, was declared unconstitutional by the supreme court of the state, as were a second law of the same sort passed soon afterwards and a third law of 1908, which provided for direct nominations of all officers and an "advisory" nomination of United States senators.

#### AMERICAN GOVERNORS OF ILLINOIS Territorial.

Ninian Edwards	1809-1818	
<i>State.</i>		
Shadrach Bond	1818-1822	Democrat
Edward Coles	1822-1826	"
Ninian Edwards	1826-1830	"
John Reynolds	1830-1834	"
Wm. L. D. Ewing (acting)	1834	"
Joseph Duncan	1834-1838	"
Thomas Carlin	1838-1842	"
Thomas Ford	1842-1846	"
Augustus C. French	1846-1851 <sup>1</sup>	"
Joel A. Matteson	1853-1857	"
William H. Bissell	1857-1860	Republican
John Wood (acting)	1860-1861	"
Richard Yates	1861-1865	"
Richard J. Oglesby	1865-1869	"
John M. Palmer	1869-1873	"
Richard J. Oglesby	1873	"
John L. Beveridge (acting)	1873-1877	"
Shelby M. Cullom	1877-1883	"
John M. Hamilton (acting)	1883-1885	"
Richard J. Oglesby	1885-1889	"
Joseph W. Filer	1889-1893	"
John P. Altgeld	1893-1897	Democrat
John R. Tanner	1897-1901	Republican
Richard Yates	1901-1905	"
Charles S. Deneen	1905-	"

**BIBLIOGRAPHY.**—There is no complete bibliography of the varied and extensive literature relating to Illinois; but Richard Bowker's *State Publications*, part ii. (New York, 1902), and the chapters of E. B. Greene's *The Government of Illinois* (New York, 1904) contain useful lists of documents, monographs and books. Physiography is well described in *The Illinois Glacial Lobe* (U.S. Geological Survey, Monograph, xxxviii.) and *The Water Resources of Illinois* (U.S. Geological Survey, Annual Report, xviii.). The Illinois State Laboratory of Natural History, connected with the State University, has published S. A. Forbes and R. E. Richardson's *Fishes of Illinois* (Urbana, 1909). Information concerning economic conditions may be derived from the volumes of the *Twelfth Census of the United States*, which treat of Agriculture, Manufactures and Mines and Quarries; a summary of agricultural conditions may be found in *Census Bulletin No. 213*. Constitutional and administrative problems are discussed in Elliott Anthony's *Constitutional History of Illinois*; Greene's *The Government of Illinois*, and H. P. Judson's *The Government of Illinois* (New York, 1900). Among the reports of the state officials, those of the Railroad and Ware House Commission, of the Bureau of Labor Statistics, and of the Commissioners of Charity are especially valuable. There is an historical study of the problem of taxation, entitled, "History of the Struggle in Illinois to realize Equality in Taxation," by H. B. Hurd, in the *Publications of the Michigan Political Science Association* (1901). Local government is described by Albert Shaw, *Local Government in Illinois* (Johns Hopkins University Studies, vol. i. No. 10). *The Blue Book of the State of Illinois* (Springfield, 1903); H. B. Hurd's *Revised Statutes of Illinois* (Chicago, 1903), and Starr and Curtis, *Annotated Statutes of the State of Illinois* (Chicago, 1896), are also of value.

The standard histories of the state are J. Moses, *Illinois, Historical and Statistical* (2 vols., Chicago, 1889); and H. Davidson and B. Stuvé, *Complete History of Illinois* (Springfield, 1874). Edward G. Mason's *Chapters from Illinois History* (Chicago, 1901) is of interest.

<sup>1</sup> Mr French's service of seven years is due to the fact that the Constitutional Convention of 1848 ordered a new election of state officials. French was re-elected Governor, beginning his new term in 1849.

for the French explorations and the colonial period. C. E. Boyd in "The County of Illinois" (*American Hist. Rev.* vol. iv.), "Record Book and Papers of John Todd" (*Chicago Historical Society, Collections*, iv.), C. E. Carter, *Great Britain and the Illinois Country, 1763-1774* (Washington, 1910), R. L. Schuyler, *The Transition of Illinois to American Government* (New York, 1909), and W. H. Smith in *The St. Clair Papers* (Cincinnati, 1882), and the *Territorial Records of Illinois* ("Publications of the State Historical Library," No. 3) are important for the period until 1818. Governor Thomas Ford's *History of Illinois* (Chicago, 1854), and Governor John Reynolds's *My Own Times* (1855), are contemporary sources for 1818-1846; they should be supplemented by N. V. Edwards's *History of Illinois, 1763-1833* (Washington, 1910), R. L. Schuyler, *The Transition of Illinois to American Government* (New York, 1909), E. B. Washburne's *Edwards Papers* (Chicago, 1884), C. H. Gannett's *State Banks of Issue in Illinois* (Univ. of Ill., 1898), and N. G. Harris's *History of Negro Servitude in Illinois* (Chicago, 1904). C. E. Carr's *The Illini* (Chicago, 1904) is a study of conditions in Illinois from 1850-1860. W. W. Lusk's *Politics and Politicians of Illinois, the Illinois Constitutional Convention (1862), the Granger Movement in Illinois, and Illinois Railway Legislation and Common Control* (University of Illinois Studies), *Street Railway Legislation in Illinois* (*Atlantic Monthly*, vol. xciii.), are of value for conditions after 1860. The publications of the Chicago Historical Society, of the "Fergus Historical" series, of the State Historical Library, of the Wisconsin Historical Society, also the Michigan Pioneer Collections, contain valuable documents and essays.

**ILLORIN**, a province of British West Africa in the protectorate of Nigeria. It has an area of 6300 sq. m., with an estimated population of about 250,000. It is inhabited are of various tribes, among which the Yoruba now predominate. There are two minor emirates, Shonga and Lafagi in this province, and a number of semi-independent towns of which the chief are Awton, Ajassa, Offa and Patiji. Under British administration the province is divided into three divisions, Illorin (central), Offa (southern) and Patiji (northern). The province is rich in agricultural and sylvan products. Among the former are tobacco, cotton, rice, peppers, ground-nuts and kolas. The latter include great quantities of shea as well as palm-oil and rubber. The capital is a town of the same name as the province. It is 160 m. in a direct line N.N.E. of Lagos, and 50 m. S.S.W. of Jebba, a port on the Niger, being connected with both places by railway. The town is surrounded by a mud wall partly in ruins, which has a circuit of some 10 m. Illorin is a great trading centre, Hausa caravans bringing goods from central Africa, and merchandise from the coasts of the Mediterranean, which is distributed from Illorin to Dahomey, Benin and the Lagos hinterland, while from the Guinea coast the trade is in the hands of the Yoruba and comes chiefly through Lagos. A variety of manufactures are carried on, including the making of leather goods, carved wooden vessels, finely plaited mats, embroidered work, shoes of yellow and red leather and pottery of various kinds. Before the establishment of British administration traders from the south, with a few selected exceptions, were prohibited from entering the city. Illorin middlemen transacted all business between the traders from the north, who were not allowed to pass to the south, and those from the south. Since the establishment of British authority the town has been thrown open, crowds of petty traders from Lagos have flocked into Illorin, and between 4000 and 5000 trade licences are issued yearly. The British resident estimated in 1904 that at least 3000 loads of British cotton goods, which he valued at £5 a load, were imported. The population of the town is estimated at from 60,000 to 70,000. The chief buildings are the palace of the emir and the houses of the *baloguns* (war chiefs). From the centre of the town roads radiate like spokes of a wheel to the various gates. Baobabs and other shade trees are numerous. There are a number of mosques in the town, and the Mohammedans are the dominant power, but the Yoruba, who constitute the bulk of the people, are pagans.

The town of Illorin was founded, towards the close of the 18th century, by Yoruba, and rose to be the capital of one of the Yoruba kingdoms. About 1825 the kingdom, which had come under Mahomedan influence, ceased its connexion with the Yoruba states and became an emirate of the Sokoto empire. The Fula, however, maintained the Yoruba system of government, which places the chief power in a council of elders.

In 1897 Illorin was occupied by the forces of the Royal Niger Company, and the emir placed himself "entirely under the protection and power of the company." After the assumption of authority by the British government in 1900, Illorin was organized for administration on the same system as the remainder of northern Nigeria. The emir took the oath of allegiance to the sovereign of Great Britain. A resident was placed at his court. Courts of justice have been established and British garrisons quartered at various places in the province. (See also NIGERIA and LAGOS.)

**ILLUMINATED MSS.**—"Illumination," in art, is a term used to signify the embellishment of written or printed text or design with colours and gold, rarely also with silver. The old form of the verb "to illuminate" was "to enlume" (O. Fr. *enluminer*; Lat. *illuminare*, "to throw light on," "to brighten"), as used by Chaucer (*A.B.C.*, 73), "kalendres enlumed ben they," and other medieval writers. Joinville likens the action of St Louis in adorning his kingdom with monastic foundations to a writer "qui a fait son livre qui l'enlume d'or et d'azur"; while Dante (*Purgat.* xi. 79) alludes to this kind of decoration as "quell' arte che alluminare chiamata è in Parisi." But while the term should be strictly applied to the brilliant book-ornamentation which was developed in the later middle ages, it has been extended, by usage, to the illustration and decoration of early MSS. in general.

From remote times the practice of illustrating texts by means of pictorial representations was in vogue. The survival of papyrus rolls containing the text of the Egyptian *Egypty* ritten known as *The Book of the Dead*, dating back fifteen centuries B.C., and accompanied with numerous scenes painted in brilliant colours, proves how ancient was this very natural method of elucidating a written text by means of pictures. There are many passages in the writings of Latin authors showing that illustrated books were not uncommon in Rome at least in the early period of the empire; and the oldest extant paintings in ancient classical MSS. may with little hesitation be accepted as representative of the style of illustration which was practised very much earlier. But such paintings are rather illustrative than decorative, and the only strictly ornamental adjuncts are the frames in which they are set. Yet independent decoration appears in a primitive form in the papyri and the earliest vellum MSS. At the head or at the end of the text designs composed of cross-hatchings, cables, dotted patterns and scrolls, sometimes with birds or simple domestic objects, are found. The early practice of writing the initial lines or even the entire text of a volume in gold or coloured inks, and of staining with purple and of gilding the vellum, while it undoubtedly enhanced the decorative aspect, does not properly fall within the scope of this article; it concerns the material rather than the artistic element of the MS. (See MANUSCRIPTS, PALAEOGRAPHY.)

It will be seen, then, that in the earliest examples of book decorations we find the germs of the two lines on which that decoration was destined to develop in the illuminated MSS. of the middle ages: the illustrative picture was the precursor of the medieval miniature (the technical term for a picture in an illuminated MS.); and the independent simple ornament was to expand into the brilliant initial letters and borders of illumination. And yet, while the miniature has a career of its own in artistic development which may be more conveniently dealt with under a separate heading (see MINIATURE), its decorative qualities are so closely bound up with those of the initial and border that an historical description of illumination must give full recognition to its prominent position in the general scheme of book-ornamentation of the middle ages.

The first examples to come under consideration are the few surviving MSS. of early origin which, preserving as they do the classical tradition, form the connecting link between the art of the Roman empire and that of the middle ages. The most ancient of these, it is now agreed, is the fragmentary copy of the *Iliad*, on vellum, in the Ambrosian Library of Milan, which consists of cuttings of the coloured drawings with which the volume was adorned in illustration of the various scenes of the



THE LINDISFARNE GOSPELS.—ABOUT A.D. 700.  
(British Museum. Cotton MS., Nero D. iv. f. 211.)

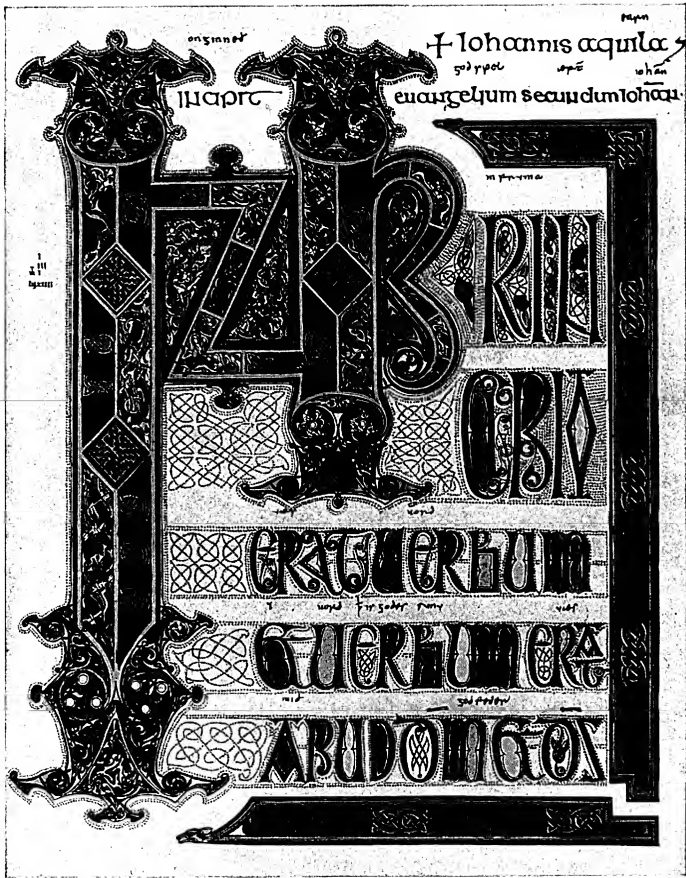

THE LINDISFARNE GOSPELS.—ABOUT A.D. 700  
(British Museum. Cotton MS., Nero D. iv. f. 211.)



poem. The MS. may have been executed in Italy, and there is good reason to assign the fragments to the 3rd century. The character of the art is quite classical, bearing comparison with that of the wall-paintings of Pompeii and the catacombs. Equally classical in their style are the fifty illustrative pictures of the Vatican Virgil, known as the *Schedae Vaticanae*, of the 4th century; but in these we find an advance on the Homeric fragments in the direction of decoration, for gilt shading is here employed to heighten the lights, and the frames in which the pictures are set are ornamented with gilt lozenges. A second famous MS. of Virgil in the Vatican library is the *Codex Romanus*, a curious instance of rough and clumsy art, with its series of illustrations copied by an unskilful hand from earlier classical models. And a still later example of persistence of the classical tradition is seen in the long roll of the book of Joshua, also in the Vatican, perhaps of the 10th century, which is filled with a series of outline drawings of considerable merit, copied from an earlier MS. But all such MSS. exhibit little tendency to decoration, and if the book ornamentation of the early middle ages had been practised only in the western empire and not also at Constantinople, it is very doubtful if the brilliant illumination which was afterwards developed would have ever existed.

When the centre of government passed eastward, Roman art came under Oriental influence with its sense of splendour, and developed the style known as Byzantine which, in its earlier stages, and until it became stereotyped in character, was broad in its drawing, on classical lines, and brilliant in its colouring, and which introduced a profuse application of gold in the details of ornament. Reacting on the art of the west, the influence of the Byzantine or Greek school is not only prominent in such early works as the mosaics of Ravenna, but it has also left its mark in the peculiar character of Italian pictorial art of the middle ages.

Very few examples of early Byzantine work in MSS. have survived; but two fragmentary leaves (Brit. Mus., Add. MS. 5111) of tables of the Eusebian canons, which must have stood at the beginning of a copy of the Gospels, executed no doubt in the Eastern capital in the 6th century, are sufficient to exemplify the splendour of ornament which might be lavished on book decoration at that date. The surface of the vellum is entirely gilt, and the ornamental designs are in classical style and painted in bright colours. Two well-known MSS., the Genesis of the Imperial Library of Vienna, of the latter part of the 6th century, and the Gospels of Rossano in southern Italy, of the same period, both containing series of illustrative paintings of a semi-classical type, are very interesting specimens of Byzantine art; but they depend on their purple vellum and their silver-written texts to claim a place among highly ornamented MSS., for the paintings themselves are devoid of gold. On the other hand, the Greek MS. of Genesis, of the 5th or 6th century, which once formed part of the Cottonian collection in the British Museum, but which was almost totally destroyed by fire, was of a more artistic character: the drawing of its miniatures was of great merit and classical in style, and gold shading was largely employed in the details. The famous MS. of Dioscorides at Vienna, executed in the year 472, is another excellent example of the early Byzantine school, its series of paintings at the beginning of the volume well maintaining the classical sentiment.

From such early examples Byzantine art advanced to a maturer style in the 8th and 10th centuries, two MSS. in the Bibliothèque Nationale of Paris being types of the best work of this time. These are: the copy of the sermons of Gregory Nazianzen (MS. *Grec.* 510), executed about the year 880 and containing a series of large miniatures, some being of the highest excellence; and a psalter of the 10th century (MS. *Grec.* 139), among whose miniatures are examples which still maintain the old sentiment of classical art in a remarkable degree, one in particular, representing David as the psalmist, being an adapted copy of a classical scene of Orpheus and the Muses. The same scene is repeated in a later Psalter in the Vatican: an instance of the repetition of favourite subjects from one century to

another which is common throughout the history of medieval art. At the period of the full maturity of the Byzantine school great skill is displayed in the best examples of figure-drawing, and a fine type of head and features is found in the miniatures of such MSS. as the *Homilies of Chrysostom* at Paris, which belonged to the emperor Nicephorus III., 1078-1081, and in the best copies of the Gospels and Saints' Lives of that period, some of them being of exquisite finish. By this time also the scheme of decoration was established. Brilliant gilded backgrounds give lustre to the miniatures. Initial letters in gold and colours are in ordinary use; but, it is to be observed, they never become very florid, but are rather meagre in outline, nor do they develop the pendants and borders which are afterwards so characteristic of the illuminated MSS. of the west. By way of general decoration, the rectangular head-pieces, which are such prominent features in Greek MSS. from the 10th to the 13th centuries, flourish in flowered and tessellated and geometric patterns in bright colours and gold. These are palpably of Oriental design, and may very well have been suggested by the woven fabrics of western Asia.

But Byzantine art was not destined to have a great history. Too self-contained and, under ecclesiastical influence, too much secluded from the contact with other ideas and other influences which are vitally necessary for healthy growth and expansion, it fell into stereotyped and formal convention and ran in narrow grooves. A general tendency was set up to paint the flesh tints in swarthy hues, to elongate and emaciate the limbs, to stiffen the gait, and generally to employ sombre colours in the miniatures, the depressing effect of which the artist seems to have felt himself compelled to relieve by rather startling contrasts of bright vermilion and lavish employment of gold. Still the initials and head-pieces continued to retain their brilliancy, of which they could scarcely be deprived without losing their *raison d'être* as decorative adjuncts. But, with all faults, fine and delicate drawing, with technical finish in the applied colours, is still characteristic of the best Greek miniatures of the 10th to 12th centuries, and the fine type of head and features of the older time remains a tradition. For example, in the Gospel lectionary, Harleian MS. 2870, in the British Museum, of the 12th century, there is a series of scenes from the life of Christ which are more than usually free from the contemporary conventionalism and which contain many figures of noble design. After the 12th century there is little in the art of Greek MSS. to detain us. The later examples, as far as they exist, are decadent and are generally lifeless copies of the earlier MSS.

Byzantine art, as seen in Greek MSS., stands apart as a thing of itself. But we shall have to consider how far and in what manner it had an influence on western art. Its reaction and influence on Italian art have been mentioned. That that influence was direct is manifest both in the style of such works as the mosaics of Italy and in the character of the paintings of the early Italian masters, and eventually in the earliest examples of the illuminated MSS. of central and southern Italy. But it is not so obvious how the influence which the eastern art of the Greek school undoubtedly exercised on the illuminated MSS. of the Frankish empire was conveyed. All things considered, however, it seems more probable that it passed westward through the medium of Italian art rather than by actual contact, except perhaps in accidental instances.

We turn to the west of Europe, and we shall see how in the elaborately ornamented Frankish MSS. of the Carolingian school was combined the lingering tradition of the classical style with a new and independent element which had grown up spontaneously in the north. This new factor was the Celtic art which had its origin and was brought to perfection in the illuminated MSS. of Ireland and afterwards of Britain. It will therefore be convenient to trace the history of that school of book ornamentation. But before doing so we must dispose, in few words, of the more primitive style which preceded the Carolingian development in western continental Europe. This primitive style, which we may call the native style, as distinguished from the more artificially

compounded art of the revival under Charlemagne, seems to have been widely extended throughout the Frankish empire and to have been common in Lombardy, and to some degree in Spain, as well as in France, and is known as Merovingian and Franco-Lombardic. This kind of ornamentation appears chiefly in the form of initial letters composed of birds, fishes and animals contorted into the shapes of the alphabetical letters; and in a less degree of head-pieces and borders filled with interlacings, or bands, or geometrical patterns, and even details of animal life. In these patterns, barbarous as they usually are, the influence of such artistic objects as mosaics and enamels is evident. The prevailing colours are crude green, red, orange and yellow, which hold their place with persistence through successive generations of MSS. This native style also, in course of time, came under Celtic influence, and adopted into its scheme the interlaced designs of animal forms and other details of the ornament of the north. It is therefore necessary to bear in mind that, side by side with the great series of Carolingian MSS., executed with all possible magnificence, there was existent this native school producing its examples of a more rustic character, which must be taken into account when studying the development of the later national style in France, in the 10th and succeeding centuries.

To turn now to the Celtic style of ornament in MSS. This we find in full development in Ireland as early as the 7th century. **Celtic.** The Irish school of book ornamentation was essentially a native school working out its own ideas, created and fostered by the early civilization of the country and destined to have a profound influence on the art of Britain and eventually on that of the continent. It may be described as a mechanical art brought to the highest pitch of perfection by the most skilful and patient elaboration. Initials, borders and full-page designs are made up of interlaced ribbons, interlaced and entangled zoomorphic creatures, intricate knots, spirals, zig-zag ornaments, and delicate interwoven patterns, together with all kinds of designs worked out in red dots—all arranged and combined together with mathematical accuracy and with exquisite precision of touch; and painted in harmonious colours in thick pigments, which lend to the whole design the appearance of enamel. Gold is never used. In the production of his designs the Irish artist evidently took for his models the objects of early metal work in which the Celtic race was so skilled, and probably, too, the classical enamels and mosaics and jewelry which had been imported and copied in the country. The finest example of early Celtic book ornamentation is the famous copy of the Gospels known as the *Book of Kells*, of the latter part of the 7th century, preserved in Trinity College, Dublin: a miracle of minute and accurate workmanship, combining in its brilliant pages an endless variety of design.

But, with all his artistic excellence, the Irish artist failed completely in figure drawing; in fact he can hardly be said to have seriously attempted it. When we contemplate, for example, the rude figures intended to represent the evangelists in early copies of the Gospels, their limbs contorted and often composed of extraordinary interlacings and convolutions, we wonder that the sense of beauty which the Irish artist indubitably possessed in an eminent degree was not shocked by such barbarous productions. The explanation is probably to be found in tradition. These figures in course of time had come to be regarded rather as details to be worked into the general scheme of the ornament of the pages in which they occur than representations of the human form, and were accordingly treated by the artist as subjects on which to exercise his ingenuity in knotting them into fantastic shapes.

Passing from Ireland, the Celtic style of book ornamentation was naturally practised in the monastic settlements of Scotland, and especially in St Columba's foundation in the island of Iona. Thence it spread to other houses in Britain. In the year 635, at the request of Oswald, king of Northumbria, Aidan, a monk of Iona, was sent to preach Christianity in that kingdom, and became the founder of the abbey and see of Lindisfarne in Holy Isle off the

Northumbrian coast. Here was established by the brethren who accompanied the missionary the famous school of Lindisfarne, from which issued a wonderful series of finely written and finely ornamented MSS. in the Celtic style, some of which still survive. The most perfect is the *Lindisfarne Gospels* or *St Cuthbert's Gospels* or the *Durham Book*, as it is more commonly called from the fact of its having rested for some time at Durham after early wanderings. This MS., written in honour of St Cuthbert and completed early in the 8th century, is in the Cottonian collection in the British Museum—a beautiful example of writing, and of the Celtic style of ornament, and in perfect condition. The contact with foreign influences, unknown in Ireland, is manifested in this volume by the use of gold, but in very sparing quantity, in some of the details. An interesting point in the artistic treatment of the MS. is the style in which the figures of the four evangelists are portrayed. Here the conventional Irish method, noticed above, is abandoned; the figures are mechanical copies from Byzantine models. The artist was unskilled in such drawing and has indicated the folds of the draperies, not by shading, but by streaks of paint of contrasting colours. Explanations of such instances of the unexpected adoption of a foreign style are rarely forthcoming; but in this case there is one. The sections of the text have been identified as following the Neapolitan use. The Greek Theodore, archbishop of Canterbury, arrived in Britain in the year 688 and was accompanied by Adrian, abbot of a monastery in the island of Nisita near Naples; and they both visited Lindisfarne. There can therefore be little doubt that the Neapolitan MS. from which the text of the *Durham Book* was derived, was one which Abbot Adrian had brought with him; and it may also be assumed that his MS. also contained paintings of the evangelists in the Byzantine style, which served as models to the Northumbrian artist.

The Celtic style was thus established through the north of England, and thence it spread to the southern parts of the country. But, for the moment, the account of its further development in Britain must be suspended **Caro-**  
**lingia.** in order to resume the thread of the story of the later classical influence on the illumination of MSS. of the Frankish empire. Under Charlemagne, who became emperor of the West in the year 800, art revived in many branches, and particularly in that of the writing and the illumination of MSS. During the reigns of this monarch and his immediate successors was produced a series of magnificent volumes, mostly biblical and liturgical, made resplendent by a lavish use of gold. The character of the decoration runs still, as of old, in the two lines of illustration and of pure ornament. We find a certain amount of general illustration, usually of the biblical narrative, in pictorial scenes drawn in freehand in the later classical style, and undoubtedly inspired by the western art of Rome. But those illustrations are small in number compared with the numerous examples of pure ornament. Such ornament was employed in the tables of the Eusebian canons, in the accessories of the traditional pictures of the evangelists, in the full-page designs which introduced the opening words of the several books of Bibles or Gospels, in the large initial letters profusely scattered through the volumes, in the infinite variety of borders which, in some MSS., adorned page after page. In all this ornament the debased classical element is prominently in evidence, Columns and arches of variegated marbles, and leaf mouldings and other architectural details are borrowed from the Roman basilicas, to serve as decorations for text and miniature. The conventional portrait-figures of the evangelists are modelled on the Byzantine pattern, but with differences which appear to indicate an intervening influence, such as would be exercised on the eastern art by its transmission through Italy. Such figures, which indeed become, in course of time, so formal as almost to be decorative details along with their settings, grew stereotyped and passed on monotonously from artist to artist, always subject to deterioration, and were perpetuated especially in MSS. of German origin down to the 11th and 12th centuries.

But it is not the debased classical decoration alone which



PSALTER OF WESTMINSTER ABBEY.—LATE TWELFTH CENTURY.

pinguentio porte ci-  
 uitatis: ecce defunc-  
 tus efferebatur filius  
 unicus matris sue.  
 Et hec uidua erat:  
 et turba ciuitatis  
 multa cum illa. Et  
 cum uidisset ihesus:  
 m̄ia motus sc̄ illa  
 dixit illi. Noli flere.  
 ⁊ accessit: et tetigit  
 loculū. Hī autē qui  
 portabant: steterūt.  
 Et ait adoleſcētia.  
 Tibi dico surge. ⁊ re-  
 cedit q̄ erat mortuus  
 et cepit loqui: ⁊ dedit  
 illum matri sue. Ac  
 cepit autem omnes  
 timorē ⁊ magnifica-  
 bant deum dicētes.  
 Quia p̄pha magnū  
 surrexit in nobis: ⁊  
 quia deus uisitauit  
 plebem suam. *fs̄.*

vi. Scdm̄ Johem.

Nullo Ex:

Hic  
 quidā  
 languēs  
 lazarus  
 a betha-  
 nia de ca-  
 stello qua-  
 ter age-  
 tr̄ sororis  
 eius. Qua-  
 n̄a autē  
 erat que  
 unctō  
 minū  
 unguē  
 to ⁊ ext̄  
 sit capil-  
 lis suis  
 pedes ei:  
 cuius sc̄  
 lazarus  
 ī firma-  
 batur

marks the illumination of the Carolingian school. The influence of the Celtic art, which has been described, imposed itself and combined with it. This combination was due to the Englishman, Alcuin of York, who became abbot of the Benedictine house of St Martin of Tours, and who did so much to aid Charlemagne in the revival of letters. Thus, in the finest examples of the Carolingian illuminated MSS., Celtic interlaced patterns stand side by side with the designs of classical origin; and, at the same time, it is interesting to observe that the older native Merovingian style of ornament makes its presence felt, now and again, in this or that detail. But with all the artistic effort bestowed upon it, it must be conceded that Carolingian illumination, as presented in the MSS., is not always pleasing. Indeed, it is often coarse and monotonous, and there is a tendency to conceal inferiority under a dazzling abundance of gold. The leading idea of the ornament of the great MSS. was splendour. Gold was used in profusion even in the writing of the text, and silver also in a minor degree; and the vellum, stained or painted purple, enhanced the gorgeous effect of the illumination. But undoubtedly the purer style of the Celtic school balanced and restrained the tendency to coarseness; and this foreign influence naturally was stronger in some centres than in others. For example, in the abbey of Saint-Denis, near Paris, if we may draw conclusions from surviving examples, the Celtic style was in great favour. Another peculiarity in the decoration of the Carolingian MSS. is the tendency of the artist to mix his styles, and to attach details on a small scale, such as delicate sprays and flourishes, and minute objects, to large-scale initial letters, as though he felt that grossness required a corrective contrast. The art became more refined under the immediate successors of Charlemagne, and under Charles the Bald it culminated. The most famous MSS. of the Carolingian school are the *Evangeliarium*, written and illuminated by the scribe Godescalc for Charlemagne in the year 787; the *Sacramentarium* written for Drogon, son of Charlemagne and bishop of Metz; the Gospels of the emperor Lothair, once at Tours; the first Bible of Charles the Bald, presented by Count Vivien, abbot of St Martin of Tours; the second Bible, called the Bible of Saint Denis, in Franco-Saxon style; and the so-called Gospels of Francis II. There are also in the British Museum (Harleian MS. 2788) an *Evangeliarium* written in gold and known as the *Codex aureus*, of this school; and a Bible of Alcuin's recension, probably executed at Tours in the middle of the 9th century, with illustrative miniatures and initial letters, but of a less elaborate degree of ornament.

After this brilliant period decadence sets in; and in the course of the 11th century Frankish illumination sinks to its lowest point, the miniatures being for the most part coarse and clumsy copies of earlier models. The colours become harsh, often assuming an unpleasant chalky appearance.

We have now to trace the development of another kind of book decoration, quite different from the florid style of gold and colours just now described, which had a lasting influence on the early art of England, where it was specially cultivated, and where it developed a character which at length became distinctively national. This is the style of outline drawing which fills so large a space in the Anglo-Saxon MSS. of the 10th and 11th centuries.

We have already seen how the Celtic style of ornamentation was introduced into the north of England. Thence it appears to have spread rapidly southward. As early as the beginning of the 8th century it was practised at Canterbury, as is testified by a famous psalter in the British Museum (Cott. MS. Vespasian A. 1), in which much of the ornament is of Celtic type. But the same MS. is also witness to the presence of another influence in English art, that of the classical style of Rome, certain details of the ornament being of that character and a miniature in the MS. being altogether of the classical type. With little hesitation this element may be ascribed to MSS. brought from Rome, in the first instance by St Augustine, and afterwards by the incoming missionaries who succeeded him, and deposited in such centres as Canterbury

and Winchester. But this importation of MSS. from Italy was not confined to the south. We have distinct evidence that they were brought into northern monasteries, such as those of Jarrow and Wearmouth and York. Thus the English artists of both south and north were in a position to take advantage of material from two sources; and they naturally did so. Thus we find that mingling of the Celtic and classical styles just noticed. In this way, early grown accustomed to take classical models for their drawings, the Anglo-Saxon artists were the more susceptible to the later development of the classical style of outline drawing which was next introduced into the country from the continent. The earliest MS. in which this style of drawing is exhibited in fullest detail is the volume known as the *Utrecht Psalter*, once in the Cottonian Library, in which the text of the psalms is profusely illustrated with minute pen-sketches remarkably full of detail. The period of the MS. is about the year 800; and it was probably executed in the north or north-east of France. But the special interest of the drawings is that they are evidently copies of much older models and provide a valuable link with the late classical art of some two or three centuries earlier. The work is very sketchy, the movement of the draperies indicated by lightly scribbled strokes of the pen, the limbs elongated, the shoulders humped—all characteristic features which are repeated in the later Anglo-Saxon work. The drawings of the *Utrecht Psalter* are clearly typical examples of a style which, founded on Roman models, must at one time have been widely practised in western Europe. For instance, there are traces of it in such a centre as St Gallen in Switzerland, and there are extant MSS. of the *Psychomachia* of Prudentius (a favourite work) with drawings of this character which were executed in France in the 10th century. But the style does not appear to have taken much hold on the fancy of continental artists. It was reserved for England to welcome and to make this free drawing her own, and to develop it especially in the great school of illumination at Winchester. Introduced probably in such examples as the *Utrecht Psalter* and copies of the *Psychomachia*, this free drawing of semi-classical origin had fully established itself here in the course of the 10th century, and by that time had assumed a national character. A fair number of MSS. of the 10th and 11th centuries which issued from the Winchester school are still to be seen among the collections of the British Museum, in most of which the light style of outline drawing with the characteristic fluttering drapery is more or less predominant, although body colours were also freely employed in many examples. But the most elaborate specimen of Anglo-Saxon illumination of the 10th century is one belonging to the duke of Devonshire: the *Benedictional* of the see of Winchester, executed under the direction of Æthelwold, bishop from 963 to 984, which contains a series of miniatures, in this instance in body colours, but drawn in the unmistakable style of the new school. In the scheme of decoration, however, another influence is at work. As England had sent forth its early Celtic designs to modify the art of the Frankish empire, so the Carolingian style of ornament now, in its turn, makes its way into this country, and appears in the purely ornamental details of the Anglo-Saxon illuminated volumes. The frames of the miniatures are chiefly composed of conventional foliage, and the same architectural leaf-mouldings of classical origin which are seen in the foreign MSS. are here repeated. Profuse gilding also, which is frequently applied, sometimes with silver, is due to foreign influence. But this character of decoration soon assumed a national cast. Under the hands of the Anglo-Saxon artist the conventional foliage flourished with greater freedom; and the colouring which he applied was generally softer and more harmonious than that which was employed abroad. Examples of outline drawing of the best type exist in the Harleian *Psalter* (No. 2904), of the same period as the Æthelwold *Benedictional*; in the register of New Minster (Stowe MS. 944), A.D. 1016-1020; and in the Prudentius (Cotton MS. Cleop. C. viii.), executed early in the 11th century.

With the Norman Conquest naturally great changes were effected in the illumination of English MSS., as in other

branches of art; no doubt to the ultimate improvement of English draughtsmanship. Left to itself the outline drawing of the Anglo-Saxons, inclining as it did to affectation, would probably have sunk into fantastic exaggeration and feebleness. Brought more directly under Norman domination it resulted in the fine, bold freehand style which is conspicuous in MSS. executed in England in the next three centuries. Then we come to the period when the art of illumination is brought into line in the countries of western Europe, in England and in France, in Flanders and in western Germany, by the splendid outburst of artistic sentiment of the 12th century. This century is the period of large folios providing ample space in their pages for the magnificent initial letters drawn on a grand scale which are to be seen in the great Bibles and psalters of the time. The leading feature is a wealth of foliage with twining and interlacing branches, among which human and animal life is freely introduced, the whole design being thrown into relief by brilliant colours and a generous use of gold. The figure drawing both in miniatures and initials is stiff, the figures elongated but bold, and with sweeping lines in the draperies; and a tendency to represent the latter clinging closely to the limbs is a legacy of the tradition of the later classical style. In England the school of Winchester appears to have maintained the same excellence after the Norman Conquest as before it. A remarkable MS. (Cotton, Nero C. iv.), a psalter of about the year 1160, with a series of fine miniatures, is a good example of its work. In France, Flanders and western Germany we find the same energy in producing boldly ornamented volumes, as in England; a certain heaviness of outline distinguishing the work of the Flemish and German artists from that of the English and French schools. Such MSS. as the Stavelot Bible (Brit. Mus., Add. MS. 28,107), of the close of the 11th century, the Bible of Floreffe (Add. MS. 17,737-17,738), of about the year 1160, and the Worms Bible (Harl. MS. 2803-2804), of the same time, are fine specimens of Flemish and German work.

It is towards the close of the 12th century and in the beginning of the 13th century that the character of illumination settles down on more conventional lines. Hitherto gold had been applied in a liquid state; now it is laid on in leaf and is highly burnished, a process which lends a brilliant effect to initial and miniature. A great change passes over the face of things. The large, bold style gives place to the minute. Volumes decrease in size; the texts are written in close-packed characters; the large and simple is superseded by the small and decorated. The period has arrived when book ornamentation becomes more settled and accurately defined within limits, and starts on the course of regulated expansion which was to run for three hundred years down to the close of the 13th century. In the 13th century the historiated or miniature initial, that is, the initial letter containing within its limits a miniature illustrating the subject of the immediate text, is established as a favourite detail of ornamentation, in addition to the regular independent miniature. Such initials form a prominent feature in the pretty little Bibles which were produced in hundreds at this period. But a still more interesting subject for study is the development of the border which was to have such a luxuriant growth in the 13th, 14th and 15th centuries. Commencing as a pendant from the initial, with terminal in form of bud or cusp, it gradually pushes its way along the margins, unfolding foliage as it proceeds, and in course of time envelopes the entire page of text in a complete framework formulating in each country a national style.

In the miniatures of the 13th century the art of England, of France, and of the Low Countries runs very much in one channel. The Flemish art, however, may be generally distinguished from the others by the heavier outline already noticed. The French art is exquisitely exact and clean-cut, and in its best examples it is the perfection of neat-handedness. English art is perhaps less exact, but makes up for any deficiency in this direction by its gracefulness. However, there is often little to choose between the productions of the three countries, and they are hard to distinguish. As an aid for such distinction, among small

differences, we may notice the copper tone of French gold contrasting with the purer metal in English MSS.; and the favour shown to deep ultramarine appears to mark French work. But, besides actual illuminated miniature painting, there is also a not inconsiderable amount of freehand illustrative drawing in the MSS. In this particular the English artist maintains the excellence of work which distinguished his ancestors. Such series of delicate drawings, slightly tinted, as those to be seen in the famous Queen Mary's Psalter (Royal MS. 2 B. vii.), and in other MSS. of the 13th and 14th centuries in the British Museum, are not surpassed by any similar drawings done at the same period in any other country. In the 13th century also comes into vogue the highly decorated diaper-work, generally of lozenges or chequered patterns in brilliant colours and brightly burnished gold. These fill the backgrounds of miniatures and initials, together with other forms of decoration, such as sheets of gold stippled or surface-drawn in various designs. Diapering continued to be practised in all three countries down into the 15th century; and in particular it is applied with exquisite effect in many of the highly-finished MSS. of the artists of Paris.

To return to the growth of the borders: these continue to be generally of one style in both England and France and in Flanders during the 13th century; but, when with the opening of the 14th century the conventional foliage begins to expand, a divergence ensues. In France and Flanders the three-pointed leaf, or ivy leaf, appears, which soon becomes fixed and flourishes as a typical detail of ornament in French illumination of the 14th and 15th centuries. In England there is less convention, and along with formal branches and leafage, natural growths, such as daisy-buds, acorns, oak leaves, nuts, &c., are also represented.

Meanwhile German illumination, which in the large MSS. of the 12th century had given high promise, in the following centuries falls away and becomes detached from the western schools, and is, as a general rule, of inferior quality, although in the 13th century fine examples are still to be met with. Dark outlines and backgrounds of highly-burnished gold are in favour. At present, however, there is not sufficient published material to enable us to pass a definite judgment on the value of German illumination in the later middle ages. But the researches of scholars are beginning to localize particular styles in certain centres. For example, in Bohemia there was a school of illumination of a higher class, which seems later to have had an influence on English art, as will be noticed presently.

We must now turn to Italy, which has been left on one side during our examination of the art of the more western countries. In attempting to bridge the gap which severs the later classical style of Rome from the medieval art of Italy, much must be left to conjecture. That a debased classical style of drawing was employed in the earlier centuries of the middle ages we cannot doubt. Such a MS. as the Ashburnham Genesis of the 7th century, which contains pictures of a somewhat rude character but based apparently upon a recollection of the classical drawing of earlier times, and which appears to be of Italian origin, serves as a link, however slight. Coming down to a later period, the primitive native art of the Frankish empire, as we have seen, extended into northern Italy under the name of Franco-Lombardic ornamentation; and we have also seen how the art of the Byzantine school reacted on the art of the southern portion of the country. Hence, in the middle ages, the ornamentation of Italian MSS. appears to move on two leading lines. The first, which we owe to the Byzantine influence, in which figure-drawing is the leading idea, follows the old classical method and, showing a distinctly Greek impress, leads to the style which we recognize as Italian *par excellence*, and which is seen most effectively manifested in the works of Cimabue and Giotto and of allied schools. In this style the colouring is generally opaque: the flesh tints being laid over a foundation of deep olive green, which imparts a swarthy complexion to the features—a practice also common in Byzantine art. The other line is that of the Lombardic style which, like

altaris altarissecus siue altarium  
ofculantur eo qd omis aplos bmos et  
bmos misit ad poyandam dicens eis  
in quacuoq domu intraueritis dicit  
par huc domus. qui regni sunt ad p  
sicut dyacony restant ad epim. De chu  
nificatione. rca.

**Q**uod tunc  
ofculi ep  
seu sacra  
accipiens  
demanu  
dyaconi  
et chunbuli  
sacrum in  
centar alta  
re. quia ip  
corpus af

umens regne pparatum factus esse  
nunc caput fm carne suis oratioib  
fouit ecclesiam fm qd orat in eua glie  
pater sic ego peccat rogo q peccat tm si p  
albe tm si poulus qui credunt sunt  
pribum cor. Quod aut dyaconus pr  
modum chunbulum accipit ut icon  
fer epim ut faceret modum instru  
it qd sitone notamus incensum ex  
tione offere chunbulum mannan  
omnes tenet redemus. nam sine fine  
meditatus homines ad place no pos  
sunt. si ut ibum pmissionis ipius  
siquis petierit in ordine grecoes i  
accipient. P chunbulum enim ubi  
accipitur in canatum. nam sic i chu  
nbulis pure supior i inferos mbo ca  
chunulis uniuersur ita unq tres sic  
uniones quib diuinitas humanita  
unioat unio carnis ad animam. un  
o diuinitatis ad carnem. i unio diuini  
tatis ad animam. Quam autem quar  
tam unione assignant. uidebitur diu  
nitatis ad copositum exantima simul  
i carne. un q quecum chunbula qua  
tuor catenulas hnt. Et hoc chunbu  
lo moyses inquit spaliat ad aaron.  
tote chunbulum q hausto igne real  
tan mitte incensum resp. Et ita  
inchunbulo cofideratio. pur in. reat  
cessu ponti. ad alt. rcaum est. Purius  
td chunficato altan ep ut faceret  
chunficatur. ad significandum quas  
fiat ex alt. altare i thofia. sic et ponti  
fer. et factos. au est orationis facti

cum offerendum. quia uo. rcaur  
no solum in quantum teus si etiam  
inquantu ho. rca in quibda ecclesie  
pontificat chunficato. altare. rca  
no a rcaia chunficatur. un in fr. d  
crauo altare tuu dnt. Et hinc chun  
bulu. aurei signat sapiam. quia os  
thofum sapientie. rcaie uo mea fu  
erit abscondit. un thear anglis. iuf  
aram templi. hnt chunbulum aure  
um ima. su. id est the. resurgens carne  
habui in potate argentei significat  
carnem abonu late mram q mudi  
tia renitentem. q sapientiam fragilem q  
mortalis. ferrem resurgens fori  
uadine. Et. iij. hnt catenulas. rca  
stiat ei cyquatior elemas. rcaie. ul  
iij. ut rcaia. punitia foenitudine.  
i iustitia rcaia. quia q peccat uadit  
aiam designat. que se amote in illo.  
rcauo separuit. Quis tres hnt catenu  
las figurat aia. carne. i rcaia. i una  
o uerit psona. quarta que peccat sepat  
pccatas e qua aiām suā posuit pon  
bus suis. Si una tm catenula fult  
caur. rca signat qd solus ueritigne ge  
nerat. qd solus e int mortuo liber.  
q urulius cui hoiā i nocitur e dca  
q nullo timo clauit. a qua hoiā  
rcaur. rca pnt. Pccat misticā crea  
tione ob hoc incensat altare. ur ois  
ab eo nequitiā uenoni. pccat. fu  
mus est i censi uale cor. rca rcaos  
effugant. rca cu thofias i rca gaffi  
angim qd remedii hnt ei q cepti  
fca iustat obfuan. rcaur cordis ei  
pccatū si sup catenones ponas sum  
eius omē uenoni. gen extricat. i  
Bother. pp. statuit ne mortuo incensu  
cra. al. gna ferit. Quai. ep ut fa  
ccos. i mistic altare hnt rcaie.

**P**urificatio  
p  
acca ep  
seu sacra  
rca rcaia  
rca rcaia  
p  
tem fe rca  
fert. i bi u  
na ai mi  
nistris pla  
ne offia  
rca rca

cccc  
facit

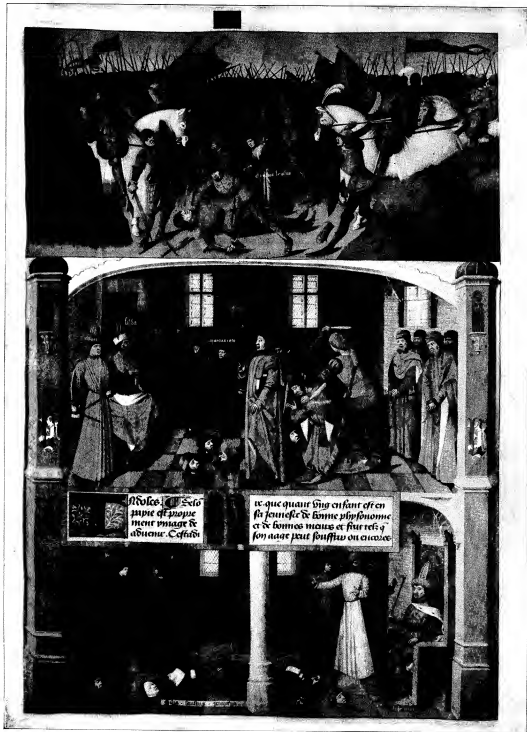

N'olles. **C**este  
 pape est propre  
 ment ymage de  
 aduene. C'est adu

re que quant vng cilfant est en  
 sa seigneurie de bonne physionomie  
 et de bonnes manes et fuit refs q  
 son naire peut souffrir ou encoire

VALERIUS MAXIMUS. ABOUT A. D. 1475. Executed for Philippe de Comines. (British Museum. Harley M.S. 4374.)



the Celtic school of the British Isles, was an art almost exclusively of pure ornament, of intricate interlacings of arabesques and animal forms, with bright colouring and ample use of gold. The Lombardic style was employed in certain centres, as, for example, at Monte Cassino, where in the 11th, 12th and 13th centuries brilliant examples were produced. But it was not destined to stand before the other, stronger and inherently more artistic, style which was to become national. Still, its scheme of brighter colouring and of general ornament seems to have had an effect upon later productions, if we are not mistaken in recognizing something of its influence in such designs as the interlaced white vine-branch borders which are so conspicuous in Italian MSS. of the period of the Renaissance.

The progress of Italian illumination in the style influenced by the Byzantine element is of particular interest in the general history of art, on account of the rapidity with which it grew to maturity, and the splendour to which it attained in the 15th century. Of the earlier centuries the existing examples are not many. That Italian artists were capable of great things as far back as the 12th century is evident from their frescoes. We may notice the curious occurrence of two very masterly paintings, the death of the Virgin and the Virgin enthroned, drawn with remarkable breadth in the Italian style, in the *Winchester Psalter* (Cottonian MS. Nero C. iv.) of the middle of that century, as a token of the possibilities of Italian illumination at that date; but generally there is little to show. Even at the beginning of the 14th century most of the specimens are of an ordinary character and betray a want of skill in striking contrast with the highly artistic productions of the Northern schools of England and France at the same period. But, though inferior artistically, Italian book ornamentation had by this time been so far influenced by the methods of those schools as to fall into line with them in the general system of decoration. The miniature, the initial, the miniature-letter and the border—all have their place and are subject to the same laws of development as in the other schools. But, once started, Italian illumination in the 14th century, especially in Florence, expanded with extraordinary energy. We may cite the Royal MS. 6. E. ix., containing an address to Robert of Anjou, king of Sicily, 1334-1342, and the Add. MS. 27,428 of legends of the saints, of about the year 1370, as instances of very fine miniature-work of the Florentine type. As the century advances, Italian illumination becomes more prolific and is extended to all classes of MSS., the large volumes of the Decretals and other law books, and still more the great folio choral books, in particular affording ample space for the artist to exercise his fancy. As was natural from the contiguity of the two countries, as well as from political causes, France and Italy influenced each other in the art. In many MSS. of the Florentine school the French influence is very marked, and on the other hand, Italian influence is exercised especially in MSS. of the southern provinces of France. Italian art of this period also in some degree affected the illumination of southern German MSS.

We have also to note the occurrence in Italy in the 14th century of good illustrative outline drawings, generally tinted in light colours and occasionally we meet with a wonderfully bright style of illumination of a lighter cast of colouring than usually prevails in Italian art: such as may be seen in a MS. of Durandus *De divinis officiis* (Brit. Mus., Add. MS. 31,032) containing an exquisite series of initials and borders.

Taking a general view of the character of European illumination in the 14th century, it may be described as an art of great invention and flexibility. The rigid exactness of the 13th century is replaced by flowing lines, just as the stiff, formal strokes of the handwriting of that century was exchanged for a more cursive and easy style. The art of each individual country now developed a national type of its own, which again branched off into the different styles of provincial schools. For example, in the eastern counties of England a very fine school of illumination, the East Anglian, was established in the first half of the century and produced a series of beautiful MSS., such as the *Arundel Psalter* (No. 83) in the British Museum.

By the end of the century the borders had developed on national lines so fully as to become, more than any other detail in the general scheme, the readiest means of identifying the country of origin. First as to the English border: the favour shown to the introduction of natural growths among the conventional foliage thrown out from the frame into which the border had by this time expanded has already been noticed. But now a new feature is introduced. The frame up to this time had consisted generally of conventional branches with bosses at the corners. Now it is divided more into compartments within which twining coils of ornament resembling cut feather-work are common details; and feathery scrolls fill the corner-bosses and are attached to other parts of the frame; while the foliage thrown out into the margin takes the form of sprays of curious lobe- or spoon-shaped and lozenge-shaped leaves or flowers, with others resembling curled feathers, and with cup- and trumpet-shaped flowers. This new style of border is contemporaneous with the appearance of a remarkably brilliant style in the miniatures, good in drawing and rich in colouring; and an explanation for the change has been sought in foreign influence. It has been suggested, with some plausibility, that this influence comes from the school of Prague, through the marriage of Richard II. with Anne of Bohemia in 1382. However this may be, there certainly is a decidedly German sentiment in the feathery scrolls just described.

Turning to the French border, we find towards the close of the 14th century that the early ivy-leaf pendant has now invaded all the margins and that the page is set in a conventional frame throwing off on every side sprigs and waving scrolls of the conventional ivy foliage, often also accompanied with very delicate compact tracery of minute flower-work filling the background of the frame. Nothing can be more charming than the effect of such borders, in which the general design is under perfect control. The character, too, of the French miniature of this period harmonizes thoroughly with the brilliant border, composed as it is very largely of decorative elements, such as diapered patterns and details of burnished gold. In the Low Countries, as was natural, the influence of French art continued to have great weight, at least in the western provinces where the style of illumination followed the French lead.

The Italian border in its ordinary form was of independent character, although following the methods of the West. Thrown out from the initial, it first took the form of pendants of a peculiarly heavy conventional curling foliage, associated, as progress was made, with slender rods jointed at intervals with bud-like ornaments and extending along the margins; at length expanding into a frame. The employment of gilt spots or pellets to fill spaces in the pendants and borders becomes very marked as the century advances. They are at first in a simple form, but they gradually throw out rays, and in the latter shape they become the chief constituents of one kind of border of the 15th century.

Illumination in the 15th century enters on a new phase. The balance is no longer evenly maintained between the relative values of the miniature and the border as factors in the general scheme of decoration. The influence of a new settlement in art makes itself felt more and more; the flat treatment of the miniature gradually gives place to true laws of perspective and of figure-drawing, and to the depth and atmospheric effects of modern painting. Miniature painting in the decoration of MSS. now became more of a trade; what in old times had been done in the cloister was now done in the shop; and the professional miniaturist, working for his own fame, took the place of the nameless monk who worked for the credit of his house. Henceforth the miniature occupies a more important place than ever in the illuminated MS.; while the border, with certain important exceptions, is apt to recede into an inferior position and to become rather an ornamental adjunct to set off the miniature than a work of art claiming equality with it.

Continuing the survey of the several national styles, we shall have to witness the final supersession of the older styles of

England and France by the later developments of Italy and Flanders. We left English illumination at the close of the 14th century strengthened by a fresh infusion of apparently a foreign, perhaps Bohemian, source. The style thus evolved marks a brilliant but short-lived epoch in English art. It is not confined to MSS., but appears also in the paintings of the time, as, for example, in the portrait of Richard II. in Westminster Abbey and in that in the Wilton triptych belonging to the earl of Pembroke. Delicate but brilliant colouring, gold worked in stippled patterns and a careful modelling of the human features are its characteristics. In MSS. also the decorative borders, of the new pattern already described, are of exceptional richness. Brilliant examples of the style, probably executed for Richard himself, may be seen in a magnificent Bible (Royal MS. 1, E. ix.), and in a series of cuttings from a missal (Add. MS. 29,704-29,705) in the British Museum. But the promise of this new school was not to be fulfilled. The same style of border decoration was carried into the 15th century, and good examples are found down to the middle of it, but a general deterioration soon sets in. Two MSS. must, however, be specially mentioned as surviving instances of the fine type of work which could still be turned out early in the century; and, curiously, they are both the productions of one and the same illuminator, the Dominican, John Siferwas. The first is a fragmentary Lectionary (Brit. Mus., Harl. MS., 7026) executed for John, Lord Lovel of Tichmersh, who died in 1408; the other is the famous Sherborne Missal, the property of the duke of Northumberland, a large volume completed about the same time for the Benedictine abbey of Sherborne in Dorsetshire. Certainly other MSS. of equal excellence must have existed; but they have now perished. After the middle of the 15th century English illumination may be said to have ceased, for the native style disappears before foreign imported art. This failure is sufficiently accounted for by the political state of the country and the distractions of the War of the Roses.

In France the 15th century opened more auspiciously for the art of illumination. Brilliant colouring and the diapered background glittering with gold, the legacy of the previous century, still continue in favour for some time; but the border, too, of ivy-leaf tracery still holds its own. But in actual drawing there are signs, as time advances, of growing carelessness, and the artist appears to think more of the effect of colour than of draughtsmanship. This was only natural at a time when the real landscape began to replace the background of diaper and conventional rocks and trees. In the first quarter of the century the school of Paris comes prominently to the front with such magnificent volumes as the Book of Hours of the regent, John Plantagenet, duke of Bedford, now in the British Museum; and the companion MS. known as the Sobieski Hours, at Windsor. In these examples, as is always the case with masterpieces, we see a great advance upon earlier methods. The miniatures are generally exquisitely painted in brilliant colours and the drawing is of a high standard; and in the borders now appear natural flowers intermingled with the conventional tracery—a new idea which was to be carried further as the century advanced. The Psalter executed at Paris for the boy-king Henry VI. (Cotton MS. Domitian A. xviii.) is another example of this school, rather of earlier type than the Bedford MS., but beautifully painted. In all three MSS. the borders show no lack of finish; they are of a high standard and are worthy of the miniatures. But perhaps the very finest miniature-work to be found in any MS. of French origin of this period is the breviary (Harl. MS. 2897) illuminated for John the Fearless, duke of Burgundy, who was assassinated in 1419. It could hardly be surpassed in refinement and minuteness of detail.

Development towards the modern methods of painting moves on rapidly with the century. First, the border in the middle period grows florid; the simpler ivy-sparg design, which had held its position so long, is gradually pushed away by a growth of flowering scrolls, with flowers, birds and animal and insect life introduced in more or less profusion. But henceforward deterioration increases, and the border becomes sub-

siidiary. In the case of miniatures following the old patterns of the devotional and liturgical books, a certain restraint still prevails; but with those in other works, histories and romances and general literature, where the paintings are devised by the fancy of the artist, the advance is rapid. The recognition of the natural landscape, the perception of atmospheric effects now guide the artist's brush, and the modern French school of the second half of the 15th century is fairly established. The most celebrated leaders of this school were Jean Fouquet of Tours and his sons, many of whose works still bear witness to their skill. In the MSS. of this school the influence of the Flemish contemporary art is very obvious; and before the advance of that art French illumination receded. A certain hardness of surface and want of depth characterize the French work of this time, as well as the practice of employing gilt hatching to obtain the high lights. This practice is carried to excess in the latest examples of French illumination in the early part of the 16th century, when the art became mechanical and overloaded with ornament, and thus expired.

It has been seen that the Flemish school of illumination in the 13th and 14th centuries followed the French model. In the 15th century, while the old tradition continued in force for a while, the art developed on an independent line; and in the second half of the century it exercised a widespread influence on the neighbouring countries, on France, on Holland and on Germany. This development was one of the results of the industrial and artistic activity of the Low Countries at this period, when the school of the Van Eycks and their followers, and of other artists of the great and wealthy cities, such as Bruges, Antwerp, Ghent, were so prolific. The Flemish miniatures naturally followed on the lines of painting. The new style was essentially modern, freeing itself from the traditions of medieval illumination and copying nature. Under the hand of the Flemish artist the landscape attained to great perfection, softness and depth of colouring, the leading attribute of the school, lending a particular charm and sense of reality to his out-door scenes. His closer observation of nature is testified also in the purely decorative part of his work. Flowers, insects, birds and other natural objects now frequent the border, the origin of which is finally forgotten. It ceases to be a connected growth wandering round the page; it becomes a flat frame of dull gold or colour, over which isolated objects, flowers, fruits, insects, butterflies, are strewn, painted with naturalistic accuracy and often made, by means of strong shadows, to stand out in relief against the background. This practice was soon carried to florid excess, and all kinds of objects, including jewels and personal ornaments, were pressed into the service of the border, in addition to the details copied from nature. The soft beauty of the later Flemish style proved very attractive to the taste of the day, with the result that it maintained a high standard well on into the 16th century, the only rivals being the MSS. of Italian art. The names of celebrated miniaturists, such as Memling, Simon Bening of Ghent, Gerard of Bruges, are associated with its productions; and many famous extant examples bear witness to the excellence to which it attained. The Grimani Breviary at Venice is one of the best known MSS. of the school; but almost every national library has specimens to boast of. Among those in the British Museum may be mentioned the breviary of Queen Isabella of Spain (Add. MS. 18,851); the Book of Hours of Juana of Castille (Add. MS. 18,852); a very beautiful Book of Hours executed at Bruges (Egerton MS. 2125); another exquisite but fragmentary MS. of the same type (Add. MS. 24,098) and cuttings from a calendar of the finest execution (Add. MS. 18,855) ascribed to Bening of Ghent; a series of large sheets of genealogies of the royal houses of Portugal and Spain (Add. MS. 12,531) by the same master and others; and late additions to the Sforza Book of Hours (Add. MS. 34,294).

But, besides the brilliantly coloured style of Flemish illumination which has been described, there was another which was practised with great effect in the 15th century. This was the simpler style of drawing in white delicately shaded to indicate

the contour of figures and the folds of drapery, &c., known as *grisaille* or *cameau gris*. It was not indeed confined to the Flemish schools, but was practised also to some extent and to good effect in northern France, and also in Holland and other countries; but the centre of its activity appears to have been in the Low Countries. The excellence to which it attained may be seen in the MSS. of the *Miracles de Notre Dame* now in Paris and the Bodelean Library, which were executed for Philip the Good, duke of Burgundy, in the middle of the 15th century.

Of the Dutch school of illumination, which was connected with that of Flanders, there is little to be said. Judging from existing examples, the art was generally of a more rustic and coarser type. There are, however, exceptions. A MS. in the British Museum (King's MS. 5) of the beginning of the 15th century contains scenes from the life of Christ in which the features are carefully modelled, very much after the style of English work of the same time; and some of the specimens of Dutch work in *cameau gris* are excellent.

German illumination in the 15th century appears to have largely copied the Flemish style; but it lost the finer qualities of its pattern, and in decoration it inclined to extravagance. Where the Flemish artist was content with single flowers gracefully placed, the German filled his borders with straggling plants and foliage and with large flourished scrolls.

Italian illumination, which had developed so rapidly in the 14th century, now advanced with accelerated pace and expanded into a variety of styles, more or less local, culminating in the exquisite productions of the classical renaissance in the latter half of the 15th century. As in the other national styles of France and Flanders, the Italian miniaturist quickly abandoned the conventional for the natural landscape; but with more character both in the figure-drawing and in the actual representation of scenery. The colouring is brilliant, not of the softness of the Flemish school, but of stronger and harder body; the outlines are firm and crisp and details well delineated. The Florentine, the Lombard, the Venetian, the Neapolitan and other schools flourished; and, though they borrowed details from each other, each had something distinctive in its scheme of colouring. The border developed on several lines. The rayed gold spots or studs or pellets, which were noticed in the 14th century, are now grouped in profusion along the margins and in the interstices of delicate flowering and other designs. Another favourite detail in the composition of both initials and borders was the twining vine tendrils, generally in white or gold upon a coloured ground, apparently a revival of the interlacing Lombardic work of the 11th and 12th centuries. At first, restrained and not too complex, it fills the body of initials and short borders; then it rapidly expands, and the convolutions and interlacings become more and more elaborate. Lastly came the completed solid frame into which are introduced arabesques, vignettes, candelabras, trophies, vases, medallions, antique gems, cupids, fawns, birds, &c., and all that the fancy led by the spirit of classical renaissance could suggest. Among the principal Italian MSS. of the 15th century in the British Museum there are: a copy of *Plutarch's Lives*, with miniatures in a remarkable style (Add. MS. 22,318); Aristotle's *Ethics*, translated into Spanish by Charles, prince of Viana, probably executed in Sicily about 1458 (Add. MS. 21,120); a breviary of Santa Croce at Florence, late in the century (Add. MS. 29,735); Livy's *History of the Macedonian War*, of the Neapolitan school, late in the century (Harl. MS. 3694); and, above all, the remarkable Book of Hours of Bona Sforza of Savoy of about the year 1490 (Add. MS. 34,291); besides a fair number of MSS. exhibiting the rich colouring of the Venetian school.

Like that of the French and Flemish schools, Italian illumination survived into the 16th century, and for a time showed vigour. Very elaborate borders of the classical type and of good design were still produced. But, as in other countries, it was then a dying art. The attempt to graft illumination on to books produced by the printing press, which we now displacing the hand-written volumes with which the art had

always been associated, proved, except in a few rare instances, a failure. The experiment did not succeed; and the art was dead.

It remains to say a few words respecting the book ornamentation of the Peninsula. In the earlier centuries of the middle ages there appears to have been scarcely anything worthy of note. The Mozarabic liturgies and biblical MSS. of the 9th to 12th centuries are adorned with initial letters closely allied to the primitive specimens of the Merovingian and Franco-Lombardic pattern, and coloured with the same crude tints; the larger letters also being partly composed of interlaced designs. But the style is barbaric. Such illustrative drawings as are to be found are also of a most primitive character. Moorish influence is apparent in the colours, particularly in the yellows, reds and blacks. In the later middle ages no national school of illumination was developed, owing to political conditions. When in the 15th century a demand arose for illuminated MSS., recourse was had to foreign artists. Flemish art naturally was imported, and French art on the one side and Italian art on the other accompanied it. In the breviary executed for Queen Isabella of Spain about the year 1497 (Brit. Mus., Add. MS. 18,851) we find a curious random association of miniatures and borders in both the French and the Flemish styles, the national taste for black, however, asserting itself in the borders where, in many instances, the usual coloured designs are replaced by black-tinted foliage and scrolls.

In other outlying countries of Europe the art of illumination can scarcely be said to have existed. In Slavonic countries a recollection of the Byzantine school lingered in book ornamentation, but chiefly in a degraded and extravagant system of fantastic interlacings. In the 16th century there was a revival in Russia of the Byzantine style, and the head-pieces and other ornamental details of the 11th and 12th centuries were successively imitated.

The consideration of oriental art does not come within the scope of this article. It may, however, be noted that in Arabic and Persian MSS. of the 13th to 16th centuries there are many examples of exquisitely drawn title-pages and other ornament of intricate detail, resplendent with colour and gold, which may be ranked with western illuminations.

**AUTHORITIES.**—Medieval and later works dealing in part with the technicalities of illumination are collected by Mrs Merrifield, *Original Treatises dating from the 12th to 18th Centuries on the Art of Printing* (1849); see also Theophilus, *De diversis Artibus*, ed. R. Hendrie (1847). Text-books and collections of facsimiles are Count A. de Bastard, *Peintures et ornements des manuscrits*, a magnificent series of facsimiles, chiefly from Carolingian MSS. (1832-1869); Shaw and Madden, *Illuminated Ornaments from MSS. and early Printed Books* (1833); Noel Humphreys and Jones, *The Illuminated Books of the Middle Ages* (1849); H. Shaw, *Handbook of Medieval Alphabets* (1853), and *The Art of Illumination* (1870); Tymms and Digby Wyatt, *The Art of Illumination* (1860); Birch and Jenner, *Early Drawings and Illuminations*, with a dictionary of subjects in MSS. in the British Museum (1879); J. H. Middleton, *Illuminated MSS. in Classical and Medieval Times* (1892); G. F. Warner, *Illuminated MSS. in the British Museum* (official publication, 1903); H. Omont, *Facsimilés des miniatures des plus anciens MSS. grecs de la Bibl. Nationale* (1902); V. de Boutovskij, *Histoire de l'ornement russe du X<sup>e</sup> au XVI<sup>e</sup> siècle*, including facsimiles from Byzantine MSS. (1870); J. O. Westwood, *Facsimiles of Miniatures and Ornaments of Anglo-Saxon and Irish MSS.* (1868); E. M. Thompson, *English Illuminated MSS.* (1895); *Palaeografia artistica di Montecassino (1876-1884)*; *Le miniature nei codici Cassinesi (1887)*; A. Haseloff, *Die illuminierten-sächsischen Malerschule des 13. Jahrhunderts* (1897); G. Schwarzenksi, *Die Regensburger Buchmalerer des 10. und 11. Jahrhunderts* (1901); Sauerland and Haseloff, *Der Psalter Erzbischof Egberts von Trier* (1901).

Several of the most ancient illustrated or illuminated MSS. have been issued wholly or partially in facsimile, viz. *The Ambrosian Homer*, by A. Ceriani; the *Schedae Vaticanae* and the *Codex Romanus* of Virgil, by the Vatican Library; the Vienna Dioscorides, in the Leiden series of facsimiles; the Vienna Genesis, by Hartel and Wickhoff; the Greek Gospels of Rossano, by A. Haseloff; the Ashburnham Pentateuch, by B. von Gebhart; the Utrecht Psalter, by the Palaeographical Society.

Facsimiles from illuminated MSS. are also included in large palaeographical works such as Silvestre, *Universal Palaeography*, ed. Madden (1850); the *Facsimiles of the Palaeographical Society* (1873-1894) and of the New Palaeographical Society (1903, &c.);

and the *Collezione paleografia Vaticana*, the issue of which was commenced in 1905. Excellent photographic reproductions on a reduced scale are being issued by the British Museum and by the Bibliothèque Nationale in Paris. (E. M. T.)

**ILLUMINATI** (Lat. *illuminare*), a designation in use from the 15th century, and applied to, or assumed by, enthusiasts of types distinct from each other, according as the "light" claimed was viewed as directly communicated from a higher source, or as due to a clarified and exalted condition of the human intelligence. To the former class belong the *alumbrados* of Spain. Menendez Pelayo first finds the name about 1402 (in the form *aluminados*, 1408), but traces them back to a Gnostic origin, and thinks their views were promoted in Spain through influences from Italy. One of their earliest leaders, born in Salamanca, a labourer's daughter, known as La Beata de Piedrahíta, came under the notice of the Inquisition in 1511, as claiming to hold colloquies with our Lord and the Virgin; having high patrons, no decision was taken against her (*Los Heterodoxos Españoles*, 1881, lib. v.). Ignatius Loyola, while studying at Salamanca (1527) was brought before an ecclesiastical commission on a charge of sympathy with the *alumbrados*, but escaped with an admonition. Others were not so fortunate. In 1529 a congregation of unlettered adherents at Toledo was visited with scourging and imprisonment. Greater rigours followed, and for about a century the *alumbrados* afforded many victims to the Inquisition, especially at Cordova. The movement (under the name of *Iluminés*) seems to have reached France from Seville in 1623, and attained some proportions in Picardy when joined (1634) by Pierre Guérin, curé of Saint-Georges de Roye, whose followers, known as Guérinets, were suppressed in 1635 (Hermant, *Hist. des hérésies*, 1717). Another and obscure body of *Iluminés* came to light in the south of France in 1722, and appears to have lingered till 1704, having affinities with those known contemporaneously in this country as "French Prophets," an offshoot of the Camisards. Of different class were the so-called Illuminati, better known as Rosicrucians, who claimed to originate in 1422, but rose into notice in 1537; a secret society, combining with the mysteries of alchemy the possession of esoteric principles of religion. Their positions are embodied in three anonymous treatises of 1614 (Richard et Giraud, *Dict. de la théol. cath.*). A short-lived movement of republican freethought, to whose adherents the name Illuminati was given, was founded on May-day 1776 by Adam Weishaupt (d. 1830), professor of Canon Law at Ingolstadt, an ex-Jesuit. The chosen title of this Order or Society was Perfectibilists (*Perfektibilisten*). Its members, pledged to obedience to their superiors, were divided into three main classes; the first including "novices," "minervals" and "lesser illuminati"; the second consisting of freemasons, "ordinary," "Scottish" and "Scottish knights"; the third or "mystery" class comprising two grades of "priest" and "regent" and of "magus" and "king." Relations with masonic lodges were established at Munich and Freising in 1780. The order had its branches in most countries of the European continent, but its total numbers never seem to have exceeded two thousand. The scheme had its attraction for literary men, such as Goethe and Herder, and even for the reigning dukes of Gotha and Weimar. Internal rupture preceded its downfall, which was effected by an edict of the Bavarian government in 1785. Later, the title Illuminati was given to the French Martinists, founded in 1754 by Martinez Pasqualis, and to their imitators, the Russian Martinists, headed about 1790 by Professor Schwartz of Moscow; both were Cabalists and allegorists, imbibing ideas from Jakob Boehme and Emmanuel Swedenborg (Bergier, *Dict. de théol.*).

See (especially for details of the movement of Weishaupt.) P. Tschackert, in Hauck's *Realencyclopädie* (1901). (A. Go.)\*

**ILLUMINATION**, in optics, the falling of the light falling upon a surface. The measurement of the illumination is termed photometry (*q.v.*). The fundamental law of illumination is that if the medium be transparent the intensity of illumination which a luminous point can produce on a surface directly exposed to it is inversely as the square of the distance. The word trans-

parent implies that no light is absorbed or stopped. Whatever, therefore, leaves the source of light must in succession pass through each of a series of spherical surfaces described round the source as centre. The same amount of light falls perpendicularly on all these surfaces in succession. The amount received in a given time by a unit of surface on each is therefore inversely as the number of such units in each. But the surfaces of spheres are as the squares of their radii,—whence the proposition. (We assume here that the velocity of light is constant, and that the source gives out its light uniformly.) When the rays fall otherwise than perpendicularly on the surface, the illumination produced is proportional to the cosine of the angle of obliquity; for the area seen under a given spherical angle increases as the secant of the obliquity, the distance remaining the same.

As a corollary to this we have the further proposition that the apparent brightness of a luminous surface (seen through a transparent homogeneous medium) is the same at all distances.

The word brightness is here taken as a measure of the amount of light falling on the pupil per unit of spherical angle subtended by the luminous surface. The spherical angle subtended by any small surface whose plane is at right angles to the line of sight is inversely as the square of the distance. So also is the light received from it. Hence the brightness is the same at all distances.

The word brightness is often used (even scientifically) in another sense from that just defined. Thus we speak of a bright star, of the question—When is Venus at its brightest? &c. Strictly, such expressions are not defensible except for sources of light which (like a star) have no apparent surface, so that we cannot tell from what amount of spherical angle their light appears to come. In that case the spherical angle is, for want of knowledge, assumed to be the same for all, and therefore the brightness of each is now estimated in terms of the whole quantity of light we receive from it.

The function of a telescope is to increase the "apparent magnitude" of distant objects; it does not increase the "apparent brightness." If we put out of account the loss of light by reflection at glass surfaces (or by imperfect reflection at metallic surfaces) and by absorption, and suppose that the magnifying power does not exceed the ratio of the aperture of the object-glass to that of the pupil, under which condition the pupil will be filled with light, we may say that the "apparent brightness" is absolutely unchanged by the use of a telescope. In this statement, however, two reservations must be admitted. If the object under examination, like a fixed star, have no sensible apparent magnitude, the conception of "apparent brightness" is altogether inapplicable, and we are concerned only with the total quantity of light reaching the eye. Again, it is found that the visibility of an object seen against a black background depends not only upon the "apparent brightness" but also upon the apparent magnitude. If two or three crosses of different sizes be cut out of the same piece of white paper, and be erected against a black background on the further side of a nearly dark room, the smaller ones become invisible in a light still sufficient to show the larger. Under these circumstances a suitable telescope may of course bring also the smaller objects into view. The explanation is probably to be sought in imperfect action of the lens of the eye when the pupil is dilated to the utmost. Lord Rayleigh found that in a nearly dark room he became distinctly short-sighted, a defect of which there is no trace whatever in a moderate light. If this view be correct, the brightness of the image on the retina is really less in the case of a small than in the case of a large object, although the so-called apparent brightnesses may be the same. However this may be, the utility of a night-glass is beyond dispute.

The general law that (apart from the accidental losses mentioned above) the "apparent brightness" depends only upon the area of the pupil filled with light, though often ill understood, has been established for a long time, as the following quotation from Smith's *Optics* (Cambridge, 1738), p. 113, will show:—

"Since the magnitude of the pupil is subject to be varied by various degrees of light, let NO be its semi-diameter when the object PL is viewed by the naked eye from the distance OP; and upon a plane that touches the eye at O, let OK be the semi-diameter of the greatest area, visible through all the glasses to another eye at P, to be found as PL was; or, which is the same thing, let OK be the semi-diameter of the greatest area enlightened by a pencil of rays flowing from P through all the glasses; and when this area is not less than the area of the pupil, the point K will appear just as bright through all the glasses as it would do if they were removed; but if the enlightened area be less than the area of the pupil, the point P will appear less bright through the glasses than if they were removed in the same proportion as the enlightened area is less than the pupil. And these proportions of apparent brightness would be accurate if all the incident rays were transmitted through the glasses to the eye, or if only an insensible part of them were stopt."

A very important fact connected with our present subject is: The brightness of a self-luminous surface does not depend upon its inclination to the line of sight. Thus a red-hot ball of iron, free from scales of oxide, &c., appears flat in the dark; so, also, the sun, seen through mist, appears as a flat disk. This fact, however, depends ultimately upon the second law of thermodynamics (see RADIATION). It may be stated, however, in another form, in which its connexion with what precedes is more obvious—The amount of radiation, in any direction, from a luminous surface is proportional to the cosine of the obliquity.

The flow of light (if we may so call it) in straight lines from the luminous point, with constant velocity, leads, as we have seen, to the expression  $\mu r^{-2}$  (where  $r$  is the distance from the luminous point) for the quantity of light which passes through unit of surface perpendicular to the ray in unit of time,  $\mu$  being a quantity indicating the rate at which light is emitted by the source. This represents the illumination of the surface on which it falls. The flow through unit of surface whose normal is inclined at an angle  $\theta$  to the ray is of course  $\mu r^{-2} \cos \theta$ , again representing the illumination. These are precisely the expressions for the gravitation force exerted by a particle of mass  $\mu$  on a unit of matter at distance  $r$ , and for its resolved part in a given direction. Hence we may employ an expression  $V = \Sigma \mu r^{-1}$ , which is exactly analogous to the gravitation or electric potential, for the purpose of calculating the effect due to any number of separate sources of light.

And the fundamental proposition in potentials, viz. that, if  $\mu$  be the external normal at any point of a closed surface, the integral  $\iint (dV/dn) dS$ , taken over the whole surface, has the value  $-4\pi\mu$ , where  $\mu$  is the sum of the values of  $\mu$  for each source lying within the surface, follows almost intuitively from the mere consideration of what it means as regards light. For every source external to the closed surface sends in light which goes out again. But the light from an internal source goes wholly out; and the amount per second from each unit source is  $4\pi$ , the total area of the unit sphere surrounding the source.

It is well to observe, however, that the analogy is not quite complete. To make it so, all the sources must lie on the same side of the surface whose illumination we are dealing with. This is due to the fact that, in order that a surface may be illuminated at all, it must be capable of scattering light, i.e. it must be to some extent opaque. Hence the illumination depends mainly upon those sources which are on the same side as that from which it is regarded.

Though this process bears some resemblance to the heat analogy employed by Lord Kelvin (Sir W. Thomson) for investigations in statical electricity and to Clerk Maxwell's device of an incompressible fluid without mass, it is by no means identical with them. Each method deals with a substance, real or imaginary, which flows in conical streams from a source so that the same amount of it passes per second through every section of the cone. But in the present process the velocity is constant and the density variable, while in the others the density is virtually constant and the velocity variable. There is a curious reciprocity in formulae such as we have just given. For instance, it is easily seen that the light received from a uniformly illuminated surface is represented by  $\iint r^{-2} \cos \theta dS$ .

As we have seen that this integral vanishes for a closed surface which has no source inside, its value is the same for all shells of equal uniform brightness whose edges lie on the same cone.

**ILLUSTRATION.** In a general sense, illustration (or the art of representing pictorially some idea which has been expressed in words) is as old as Art itself. There has never been a time since civilization began when artists were not prompted to pictorial themes from legendary, historical or literary sources. But the art of illustration, as now understood, is a comparatively modern product. The tendency of modern culture has been to make the interests of the different arts overlap. The theory of Wagner, as applied to opera, for making a combined appeal

to the artistic emotions, has been also the underlying principle in the development of that great body of artistic production which in painting gives us the picture containing "literary" elements, and in actual association with literature in its printed form, becomes what we call "illustration." The illustrator's work is the complement of expression in some other medium. A poem can hardly exist which does not awaken in the mind at some moment a suggestion either of picture or music. The sensitive temperament of the artist or the musician is able to realize out of words some parallel idea which can only be conveyed, or can be best conveyed, through his own medium of music or painting. Similarly, music or painting may, and often does, suggest poetry. It is from this inter-relation of the emotions governing the different arts that illustration may be said to spring. The success of illustration lies, then, in the instinctive transference of an idea from one medium to another; the more spontaneous it be and the less laboured in application, the better.

Leaving on one side the illuminated manuscripts of the middle ages (see ILLUMINATED MSS.) we start with the fact that illustration was coincident with the invention of printing. Italian art produced many fine examples, notably the outline illustrations to the *Poliphili Hypnerotomachia*, printed by Aldus at Venice in the last year of the 15th century. Other early works exist, the products of unnamed artists of the French, German, Spanish and Italian schools; while of more singular importance, though not then brought into book form, were the illustrations to Dante's *Divine Comedy* made by Botticelli at about the same period. The sudden development of engraving on metal and wood drew many painters of the Renaissance towards illustration as a further opportunity for the exercise of their powers; and the line-work, either original or engraved by others, of Pollajuolo, Mantegna, Michelangelo and Titian has its place in the gradual enlargement of illustrative art. The German school of the 16th century committed its energies even more vigorously to illustration; and many of its artists are now known chiefly through their engravings on wood or copper, a good proportion of which were done to the accompaniment of printed matter. The names of Dürer, Burgmaier, Altdorfer and Holbein represent a school whose engraved illustrations possess qualities which have never been rivalled, and remain an invaluable aid to imitators of the present day.

Illustration has generally flourished in any particular age in proportion to the health and vigour of the artistic productions in other kinds. No evident revival in painting has come about, no great school has existed during the last four centuries, which has not set its mark upon the illustration of the period and quickened it into a medium for true artistic expression. The etchers of the Low Countries during the 17th century, with Rembrandt at their head, were to a great extent illustrators in their choice of subjects. In France the period of Watteau and Fragonard gave rise to a school of delicately engraved illustration, exquisite in detail and invention. In England Hogarth came to be the founder of many new conditions, both in painting and illustration, and was followed by men of genius so distinct as Reynolds on the one side and Bewick on the other. With Reynolds one connects the illustrators and engravers for whom now Bartolozzi supplies a surviving name and an embodiment in his graceful but never quite English art. But it is from Thomas Bewick that the wonderfully consistent development of English illustration begins to date. Bewick marks an important period in the technical history of wood-engraving as the practical inventor of the "tint" and "white line" method of wood-cutting; but he also happened to be an artist. His artistic device was to give local colour and texture without shadow, securing thereby a precision of outline which allowed no form to be lost. And though, in consequence, many of his best designs have somewhat the air of a specimen plate, he succeeded in bringing into black-and-white illustration an element of colour which had been wholly absent from it in the work of the 15th and 16th century German and Italian schools. Bewick's method started a new school; but the more racy qualities

of his woodcuts were entirely dependent on the designer being his own cutter; and the same happy relationship gave distinct characteristics to the nearly contemporary work of William Blake and of Calvert. Blake's wonderful *Illustrations to the Book of Job*, while magnificent in their conventional rendering of light and shade, still retain the colourlessness of the old masters, as do also the more broadly handled designs to his own books of prophecy and verse; but in his woodcuts to Philips's *Pastorals* the modern tendency towards local colour makes itself strongly felt. So wonderfully, indeed, have colour and tone been expressed in these rough wood-blocks, that more vivid impressions of darkness and twilight falling across quiet landscape have never been produced through the same materials. The pastoral designs made by Edward Calvert on similar lines can hardly be over-praised. Technically these engravings are far more able than those from which they drew their inspiration.

With the exception of the two artists named, and in a minor degree of Thomas Stothard and John Flaxman, who also produced original illustrations, the period from the end of the 18th century till about the middle of the 19th was less notable for the work of the designer than of the engraver. The delicate plates to Rogers's *Italy* were done from drawings which Turner had not produced for purposes of illustration; and the admirable lithographs of Samuel Prout and Richard Bonington were merely studies of architecture and landscape made in a material that admitted of indefinite multiplication. It is true that Géricault came over to England about the year 1830 to draw the English race-horse and other studies of country life, which were published in London in 1831, and that other fine work in lithography was done by James Ward, G. Cattermole, and somewhat later by J. F. Lewis. But illustration proper, subject-illustration applied to literature, was mainly in the hands of the wood-engravers; and these, forming a really fine school founded on the lines which Bewick had laid down, had for about thirty years to content themselves with rendering the works of ephemeral artists, among whom Benjamin R. Haydon and John Martin stand out as the chief lights. It must not be forgotten, however, that while the day of a serious English school of illustration had not yet come, Great Britain possessed an indigenous tradition of gross and lively caricature; a tradition of such robust force and vulgarity that, by the side of some choicer specimens of James Gillray and Henry W. Bunbury, the art of Rowlandson appears almost refined. This was the school in which George Cruikshank, John Leech, and the Dickens illustrators had their training, from which they drew more and more away; until, with the help of *Punch*, just before the middle of the 19th century, English caricaturists had learned the secret of how to be apposite and amusing without scurrility and without libel. (See CARICATURE.)

Under NEWSPAPERS will be found some account of the rise of *illustrated journalism*. It was in about the year 1832 that the illustrated weekly paper started on its career in England, and almost by accident determined under what form a great national art was to develop itself. While in France the illustrators were making their triumphs by means of lithography, English illustration was becoming more and more identified with wood-engraving. The demand for a method of illustration, easy to produce and easy to print, for books and magazines of large circulation and moderate price, forced the artist before long into drawing upon the wood itself; and so soon as the artist had asserted his preference for facsimile over "tint," the school which came to be called "of the 'sixties" was in embryo, and waited only for artistic power to give it distinction. The engraver's translation of the artist's painting or wash-drawing into "tint" had largely exalted the individuality of the engraver at the expense of the artist. But from the moment when the designer began to put his own lines upon the wood, new conditions shaped themselves; and though the artist at times might make demands which the engraver could not follow, or the engraver inadequately fulfil the expectation of the artist, the general tendency was to bring designer and engraver into almost ideal relations—an ideal which nothing short of the artist being his own engraver could

have equalled. Out of an alliance cemented by their common use and understanding of the material on which they worked came the school of facsimile or partial-facsimile engraving which flourished during the 'sixties, and lasted just so long as its conditions were unimpaired—losing its flavour only at the moment when "improved" mechanical appliances enabled the artist once more to dissociate himself from the conditions which bound the engraver in his craft.

Before the fortunate circumstances which governed the work of the 'sixties became decisive, illustrations of a transitional character, but tending to the same end, had been produced by John Tenniel, John Gilbert, Birket Foster, Harrison Weir, T. Creswick, W. Mulready and others; but their methods were too vague and diffuse to bear as yet the mark of a school; no single influence gave a unity to their efforts. On some of them Adolf von Menzel's illustrations to Kügler's *Frederick the Great*, published in England in 1844, may have left a mark; Gilbert certainly shows traces of the influence of Delacroix and Bonington in the free, loose method of his draughtsmanship, independent of accurate modelling, and with here and there a paint-like dab of black to relieve a generally colourless effect; while Tenniel, with cold, precise lines of wire-drawn hardness, remained the representative of the past academic style, influencing others by the dignity of his fine technique, but with his own feeling quite untouched by the Pre-Raphaelite and romantic movement which was soon to occupy the world of illustration. In greater or less degree it may be said of the work of all these artists that, as it antedates, so to the end does it stand somewhat removed in character from, the school with which for a time it became contemporary. The year which decisively marked the beginning of new things in illustration was 1857, the year of the Moxon *Tennyson* and of Wilmott's *Poets of the Nineteenth Century*, with illustrations by Rossetti, Millais, Holman Hunt and Ford Madox Brown. In these artists we get the germ of the movement which afterwards came to have so wide a popularity. At the beginning, Pre-Raphaelite in name, poetic and literary in its choice of subjects, the school quickly expanded to an acceptance of those open-air and everyday subjects which one connects with the names of Frederick Walker, Arthur B. Houghton, G. F. Pinwell and M. North. The illustrations of the Pre-Raphaelites were eminently thoughtful, full of symbolism, and with a certain pressure of interest to which the epithet of "intense" came to be applied. As an example of their method of thought-transference from word to form, Madox Brown's drawing for the Dalziel Bible of "Elijah and the Widow's Son" may be taken. The restoration of life to a dead body, of a child to its mother, is there conveyed with many illustrative touches and asides, which become clumsy when stated in words. The hen bearing her chicken between her wings is a perfectly direct and appropriate pictorial symbol, but a far more imaginative stroke is the shadow on the wall of a swallow flying back to the clay bottle where it has made its nest. Here is illustration full of literary symbolism, yet wholly pictorial in its means; and in this it is entirely characteristic of Pre-Raphaelite feeling, with its method of suggesting, through externals, consideration as opposed to mere outlook. Of this phase Rossetti must be accounted the leader, but it was Millais who, by the sheer weight of his personality, carried English illustration along with him from Pre-Raphaelitism to the freer romanticism and naturalistic tendencies of the 'sixties. Rossetti, with his poetic enthusiasm, his strong personal magnetism and dramatic power of composition, may be said to have brought about the awakening; it was Millais who, by his rapid development of style, his original and daring technique, turned it into a movement. When he started, there were many influences behind him and his fellow-workers—among older foreign contemporaries, those of Menzel and Rethel; and behind these again something of the old masters. But through a transitional period, represented by his twelve drawings of "The Parables," which appeared first in *Good Words*, Millais emerged in to the perfect independence of his illustrations to Trollope's novels, *Framley Parsonage* and *The*

Pre-Raphaelite movement.

Influence of Wood-engraving

Influence of Millais.

*Small House at Allington*, his own master and the master of a new school. Depicting the ugly fashions of his day with grave dignity and distinction, and with a broad power of rendering type in work which had the aspect of genre, he drew the picture of his age in a summary so embracing that his illustrations attain the rank almost of historical art. For art of this sort the symbolism of the Pre-Raphaelites lost its use: the realization in form of a character conveyed by an author's words, the happy suggestion of a locality helping to fix the writer's description, the verisimilitudes of ordinary life, even to trivial detail, carried out with real pictorial conviction, were the things most to be aimed at. Pictorial conviction was the great mark of the illustrative school of the 'sixties. The work of its artists has absorbed so completely the interest and reality of the letterpress that the results are a model of what faithful yet imaginative illustration should be. In the illustrated magazines of this period, *Once a Week*, *Good Words*, *Cornhill*, *London Society*, *The Argosy*, *The Leisure Hour*, *Sunday at Home*, *The Quiver* and *The Churchman's Family Magazine*, as well as others, is to be found the best work of this new school of illustrators; and with the greater number of them it cannot be mistaken that Millais is the prevailing force.

By their side other men were working, more deeply influenced by the old masters, and by the minuteness and hard, definite treatment of form which the Pre-Raphaelites had inculcated. Foremost of these was Frederick Sandys. His illustrations, scattered through nearly all the magazines which have been named, show always a decorative power of design and are full of fine drawing and fine invention, but remain resolutely cold in handling and lacking in imaginative ardour. The few illustrations done by Burne-Jones at this period show a whole-hearted following of Rossetti, but a somewhat struggling technique; and the same qualities are to be found in the work of Arthur Hughes, whose illustrations in *Good Words for the Young* (1869) have a charm of tender poetic invention showing through the faults and persistent uncertainty of his draughtsmanship. The illustrations of Frederick Shields to Defoe's *History of the Plague* have a certain affinity to the work of Sandys; but, with less power over form, they show a more dramatic sense of light and shade, and at their best can claim real and original beauty. The formality of feeling and composition, and the strained, stiff quality of line in Lord Leighton's designs to *Romola* (1863), do a good deal to mar one's enjoyment of their admirable draughtsmanship. Many fine drawings done at this period by Leighton, Poynter, Henry Armstead and Burne-Jones did not appear until the year 1880 in the "Dallziel Bible Gallery," when the methods of which they were the outcome had fallen almost out of use.

Deeply influenced by the broad later phases of Millais's black-and-white work these artists whose tendency lay in the direction of idyllic naturalism and popular romance, the men to whom more particularly is given the name of the period and school "the 'sixties," and whose more immediate leader, as far as popular estimation goes, was Frederick Walker. With his, one may roughly group the names of Pinwell, Houghton, North, Charles Keene, Lawless, Matthew J. Mahoney, Morten and, with a certain reservation, W. Small and G. du Maurier. In no very separate category stand two other artists whose contributions to illustration were but incidental, John Pettie and J. McNeill Whistler. The broad characteristics of this variously related group were a loose, easy line suggestive of movement, a general fondness for white spaces and open-air effects, and in the best of them a thorough sense of the serious beauty of domestic and rural life. They treated the present with a feeling rather idyllic than realistic; when they touched the past it was with a courteous sort of realism, and a wonderful inventiveness of detail which carried with it a charm of conviction. Walker's method shows a broad and vivid use of black and white, with a fine sense of balance, but very little preoccupation for decorative effect. Pinwell had a more delicate fancy, but less freedom in his technique—less ease, but more originality of composition. In Houghton's work one sees

a swift, masterful technique, full of audacity, noble in its economy of means, sometimes rough and careless. His temperament was dramatic, passionate, satiric and witty. Some of his best work, his "Scenes from American Life," appeared in the pages of the *Graphic* as late as the years 1873-1874. There are indications in the work of Lawless that he might have come close to Millais in his power of infusing distinction into the barest materials of everyday life, but he died too soon for his work to reach its full accomplishment. North was essentially a landscape illustrator. The delicate sense of beauty in du Maurier's early work became lost in the formal but graceful conventions of his later *Punch* drawings. It was in the pages of *Punch* that Keene secured his chief triumphs. The two last-named artists outstayed the day which saw the break-up of the school of which these are the leading names. It ran its course through a period when illustrated magazines formed the staple of popular consumption, before the illustrated newspapers, with their hungry rush for the record of latest events, became a weekly feature. Its waning influence may be plainly traced through the early years of the *Graphic*, which started in 1869 with some really fine work, done under transitional conditions before the engraver's rendering of tone-drawings once more ousted facsimile from its high place in illustration.

In connexion with this transitional period, drawings for the *Graphic* by Houghton, Pinwell, Sir Hubert von Herkomer, E. J. Gregory, H. Woods, Charles Green, H. Paterson (Mrs Allingham) and William Small deserve honourable mention. Yet it was the last-named who was mainly instrumental in bringing about the change from line-work to pigment, which depressed the artistic value of illustration during the 'seventies and the 'eighties to almost absolute mediocrity. Several artists of great ability practised illustration during this period: in addition to those *Graphic* artists already mentioned there were Luke Fildes, Frank Holl, S. P. Hall, Paul Renouard and a few others of smaller merit. But the interest was for the time shifting from black-and-white work and turning to colour. Kate Greenaway began to produce her charming idyllic renderings of children in mob-caps and long skirts. Walter Crane on somewhat similar lines designed his illustrated nursery rhymes; while Randolph Caldecott took the field with his fresh and breezy scenes of hunting life and carousal in the times most typical of the English squirearchy. Working with a broad outline, suggestive of the brush by its easy freedom, and adding washes of conventional colour for embellishment, he was one of the first in England to show the beginnings of Japanese influence. Even more dependent upon colour were his illustrated books for children; while in black and white, in his illustrations to *Bracebridge Hall* (1876), for instance, pen and ink began to replace the pencil, and to produce a new and more independent style of draughtsmanship. This style was taken up and followed by many artists of ability, by Harry Furniss, Hugh Thomson and others, till the influence of E. A. Abbey's more mobile and more elaborate penmanship came to produce a still further development in the direction of fineness and illusion, and that of Phil May, with Linley Sambourne for his teacher, to simplify and make broad for those who aimed rather at a journalistic and shorthand method of illustration. (See also CARICATURE and CARTOON.)

Under the absolutely liberating conditions of "process reproduction" (see PROCESS) the latest developments in illustration on its lighter and more popular side are full of French influences, or ready to follow the wind in any fresh direction, whether to America or Japan; but on the graver side they show a strong leaning towards the older traditions of the 'sixties and of Pre-Raphaelitism. The founding by William Morris of the Kelmscott Press in 1891, through which were produced a series of decorated and illustrated books, aimed frankly at a revival of medieval taste. In Morris's books decorative effect and sense of material claimed mastery over the whole scheme, and subdued the illustrations to a sort of glorious captivity into which no breath of modern spirit could be breathed. The illustrations of Burne-Jones filled with a happy touch of archaism the decorative borders of William Morris; and only a little less happy, apart from their imaginative inferiority, were the serious efforts of Walter Crane and one or two others. Directly under the Morris influence arose the "Birmingham school," with an entire devotion to decorative methods and still archaic effects which

tended sometimes to rather naive technical results. Among its leaders may be named Arthur Gaskin, C. M. Gere and E. H. New; while work not dissimilar but more independent in spirit had already been done by Selwyn Image and H. P. Horne in the *Century Guild Hobby-Horse*. But far greater originality and force belonged to the work of a group, known for a time as the neo-Fre-Raphaelites, which joined to an earnest study of the past a scrupulously open mind towards more modern influences. Its early expression of existence was the publication of an occasional periodical, the *Dial* (1889-1897), but before long its influence became felt outside its first narrow limits. The technical influence of Abbey, but still more the emotional and intellectual teaching of Rossetti and Millais, together with side-influences from the few great French symbolists, were, apart from their own originality, the forces which gave distinction to the work of C. S. Kicketts, C. H. Shannon, R. Savage and their imitators, to mention but a few. Long afterwards, symbolism full of literary allusions, and a fondness for the life of any age but the present, are the characteristics of the school. Their influence fell very much in the same quarters where Morris found a welcome; but an affinity for the Italian rather than the German masters (shown especially in the "Vale Press" publications), and a studied note of world-weariness, kept them somewhat apart from the sturdy medievalism of Morris, and linked them intellectually with the decadent school initiated by the wayward genius of Aubrey Beardsley. In matters of method, however, the group, as groupings will supply a formula for all the noteworthy work produced when men are drawn this way and that by current influences. Among artists resolutely independent of contemporary coteries may be named W. Strang, whose grave, rugged work shows him a pupil, through Legros, of Dürer and others of the old masters; T. Sturge Moore, an original engraver of designs which have an equal affinity for Blake, Calvert and Hokusai; W. Nicholson, whose style shows a dignified return to the best part of the Rowlandson tradition; and E. J. Sullivan. In the closing years of the 19th century Aubrey Beardsley became the creator of an entirely novel style of decorative illustration. Drawing inspiration from all sources of European and Japanese art, he produced, by the force of a vivid personality and extraordinary technical skill, a result which was highly original and impressive. To a genuine liking for analysis of repulsive and vicious types of humanity he added an exquisite sense of line, balance and mass; and partly by *succès de scandale*, partly by genuine artistic brilliance, he gathered round him a host of admirers. To a small number, for the most part, he was able to impart only his more mediocre qualities.

In America, until a comparatively recent date, illustration bowed the knee to the superior excellence of the engraver over the artist. Not until the brilliant pen-drawing of E. A. Abbey carried the day with the black-and-white artists of England did any work of real moment emanate from the United States, unless that of Elihu Vedder be regarded as an exception. Howard Pyle is a brilliant imitator of Dürer; he has also the ability to adapt himself to the requirements of modern tendency. C. S. Reinhart was an artist of directness and force, in a style based upon modern French and German examples; while of greater originality as a whole, though derivative in detail, is the fanciful penmanship of Alfred Brennan. Other artists who stand in the front rank of American illustrators, and whose works appear chiefly in the pages of *Scribner's*, *Harper's* and the *Century Magazine*, are W. T. Smedley, F. S. Church, R. Blum, Wenzell, A. B. Frost, and in particular C. Dana Gibson, the last of whom gained a reputation in England as an American du Maurier.

The record of modern French illustration goes back to the day when political caricature and the Napoleonic legend divided between them the triumphs of early lithography. The *France*. Illustrators of France at that period were also her greatest artists. Of the historical and romantic school were D. Raifet, Nicholas J. Charlet, Géricault, Delacroix, J. B. Isabey and Achille Devéria, many of whose works appeared in *L'Artiste*, a paper founded in 1831 as the official organ of the romanticists; while the realists were to be distinguished by the direction of such enormous force as Gavarni and Honoré Daumier, whose works, appearing in *La Lithographie Mensuelle*, *Le Charivari* and *La Caricature*, ran the gauntlet of political interference and suppression during a troubled period of French politics—which was the very cause of their prosperity. Behind these men lay the influence of the great Spanish realist Goya. Following upon the harsh satire and venomous realism of this famous school of pictorial invective, the influence of the Barbizon school came as a milder force; but the power of its artists did not show in the direction of original lithography, and far more value attaches to the few woodcuts of J. F. Millet's studies of peasant life. In these we see clearly the tendency of French illustrative art to keep as far as possible the authentic and sketch-like touch of the artist; and it was no doubt from this tendency that so many of the great French illustrators retained lithography rather than commit themselves to the middleman engraver. Nevertheless, from about the year 1830 many French artists produced illustrations which were interpreted upon the wood for the most part by English engravers. Currier's designs of *Paul et Virginie* and *La Chaumière Indienne*, illustrated by Huet, Jacque, Isabey, Johannot and Meissonier, were followed by

Meissonier's more famous illustrations to *Contes vémois*. After Meissonier came J. B. E. Detaille and Alphonse M. de Neuville and, with a voluminous style of his own, L. A. G. Doré. By the majority of these artists the drawing for the engraver seems to have been done with the pen; and the tendency to penmanship was still more accentuated when from Spain came the influence of M. J. Fortuny's brilliant technique; while after him, again, came Daniel Wierzbicki, to make, as it were, the point of the pen still more pointed. During the middle period of the 19th century the best French illustration was serious in character; but among the later men, when we have recognized the grave beauty of Grasset's *Les Quatre Fils d'Aymon* (in spite of his vicious treatment of the page by flooding washes of colour through the type itself), and the delicate grace of Boutet de Monvel's *Jeanne d'Arc*, also in colours, it is to the illustrators of the comic papers that we have to go for the most typical and most audacious specimens of French art. In the pages of *Gil Blas*, *Le Pierrot*, *L'Écho de Paris*, *Le Figaro Illustré*, *Le Courrier Français*, and similar publications, are to be found, reproduced with a dexterity of process unsurpassed in England, the designs of J. L. Forain, C. L. Léandre, L. A. Willette and T. A. Steinlen, the leaders of a school enterprising in technique, and with a mixture of subtlety and grossness in its humour. Caran d'Ache also became celebrated as a draughtsman of comic drama in outline.

Among illustrators of Teutonic race the one artist who seems worthy of comparison with the great Menzel is Hans Tegner, if, indeed, he be not in some respects his technical superior; but apart from these two, the illustrators respectively of *Germany*, Kügler's *Frederick the Great* and Holberg's *Comedies*, there is no German, Danish or Dutch illustrator who can lay claim to first rank. Max Klinger, A. Böcklin, W. Trübner, Franz Stuck and Hans Thoma are all symbolists who combine in a singular degree force with brutality; the imaginative quality in their work is for the most part ruined by the hard, braggart way in which it is driven home. The achievements and tendency of the later school of illustration in Germany are best seen in the weekly illustrated journal, *Jugend*, of Munich. Typical of an older German school is the work of Adolf Oberländer, a solid, scientific sort of caricaturist, whose illustrations are at times so monumental that the humour in them seems crushed out of life. Others who command high qualities of technique are W. Dietz, L. von Nagel, Hermann Vogel, H. Lüders and Robert Haug. Behind all these men in greater or less degree lies the influence of Menzel's coldly balanced and dry-lighted realism; but whenever the influence of Menzel ceases, the merit of German illustration for the most part tends to disappear or become mediocre.

**AUTHORITIES.**—W. J. Linton, *The Masters of Wood Engraving* (London, 1889); C. G. Harper, *English Pen Artists of To-day* (London, 1892); Joseph Pennell, *Pen Drawing and Pen Draughtsmen* (London, 1894); *Modern Illustration* (London, 1895); Walter Crane, *The Decorative Illustration of Books* (London, 1896); Gleeson White, *English Illustration: The Sixties: 1835-1870* (Westminster, 1907); W. Chatto, *A Treatise on Wood Engraving* (London, n.d.); Barle-Duc, *Les Illustrations du XIX<sup>e</sup> siècle* (Paris, 1882); T. Kutschmann, *Geschichte der deutschen Illustration vom ersten Auftreten des Formschneites bis auf die Gegenwart* (Berlin, 1899). (L. Ho.)

#### Technical Developments.

The history of illustration, apart from the merits of individual artists, during the period since the year 1875, is mainly that of the development of what is called Process (*q.v.*), the term applied to methods of reproducing a drawing or photograph which depend on the use of some mechanical agency in the making of the block, as distinguished from such products of manual skill as steel or wood-engraving, lithography and the like. There is good reason to believe that the art of stereotyping—the multiplication of an already existing block by means of moulds and casts—is as old as the 15th century; and the early processes were, in a measure, a refinement upon this: with the difference that they aimed at the making of a metal block by means of a cast of the lines of the drawing itself, the background of which had been cut away so as to leave the design in a definite relief. Experiments of this nature may be said to have assumed practical shape from the time of the invention of Palmer's process called at first *Glyphography*, about the year 1844; this was afterwards perfected and used to a considerable extent under the name of *Dawson's Typographic Etching*, and its results were in many cases quite admirable, and often appear in books and periodicals of the first part of the period with which we are now concerned. *The Graphic*, for instance, published its first process block in 1876, and the *Illustrated London News* also made similar experiments at about the same time.

From this time begins the gradual application of photography to the uses of illustration, the first successful line blocks made by



its help being probably those of Gillot, at Paris, in the early 'eighties. The next stage was to be the invention of some means of reproducing wash drawings. To do this it was necessary for the surface of the block to be so broken up that every tone of the drawing should be represented thereon by a grain holding ink enough to reproduce it. This was finally accomplished by the insertion of a screen, in the camera, between the lens and the plate—the effect of which was to break up the whole surface of the negative into dots, and so secure, when printed on a zinc plate and etched, an approximation to the desired result. Half-tone blocks (as they were called) of this nature (see PROCESS) were used in the *Graphic* from 1884 and the *Illustrated London News* from 1885 onwards, the methods at first in favour being those of Meisenbach and Boussod Valadon and Co.'s phototype. Lemerier and Petit of Paris, Angerer and Göschel of Vienna, and F. Ives of Philadelphia also perfected processes giving a similar result, a block by the latter appearing in the *Century* magazine as early as 1882. Processes of this description had, however, been used for some years before by Henry Blackburn in his *Academy Notes*.

During the decade 1875–1885, however, the main body of work was accomplished by wood-engraving, which a few years earlier had achieved such splendid results. Its artistic qualities were now at a rather low ebb, although good facsimile engravings of pen-drawings were not infrequent. The two great illustrated periodicals already referred to during this period related to the general history of the events of the day was certainly shown, but the whole purpose of the journal was not, as at present, subordinated thereto. The chief illustrated magazines of the time, *Harper's*, the *Century*, the *English Illustrated*, were also content with the older methods, and are filled with wood-engravings, in which, if the value of the simple line forming the chief quality of the earlier work has disappeared, a most astonishing delicacy and success were obtained in the reproduction of tone.

Perhaps the most notable and most characteristic production of the time in England was colour-printing. The *Graphic* and the *Illustrated London News* published full-page supplements of high technical merit printed from wood-blocks in conjunction with metal plates, the latter sometimes having a relief aquatint surface which produced an effect of stipple upon the shading; metal was also used in preference to wood for the printing of certain colours. The children's books illustrated by Randolph Kneller, Walter Crane, and Kate Greenaway at this time are among the finest specimens of colour-printing yet seen outside of Japan; in them the use of flat masses of pleasant colour in connexion with a bold and simple outline was carried to a very high pitch of excellence. These plates were generally printed by Edmund Evans. In 1887 the use of process was becoming still more general; but its future was by no means adequately foreseen, and the blocks of this and the next few years are anything but satisfactory. This, it soon appeared, was due to inefficient printing on the one hand, and, on the other, to a want of recognition by artists of the special qualities of drawing most suitable for photographic reproduction. The publication of Quevedo's *Pablo de Segovia* with illustrations by Daniel Vierge in 1882, although hardly noticed at the time, was to be a revelation of the possibilities of the new development; and a serious study of pen-drawing from this point of view was soon inaugurated by the issue of Joseph Pennell's *Pen Drawing and Pen Draftsmen* in 1889, followed in 1892 by C. G. Harper's *English Pen Artists of the Nineteenth Century* and in 1896 by Walter Crane's *Decorative Illustration of Books*. At this time also the influence of Aubrey Beardsley made itself strongly felt, not merely as a matter of style, but, by the use of simple line or mass of solid black, as an almost perfect type of the work most suitable to the needs of process. Wider experience of printing requirements, and finer workmanship in the actual making of the blocks, in Paris, Vienna, New York, and London, soon brought the half-tone process into vogue. This, it soon appeared, was due to the fact that the increased demand for ephemeral literature, more especially that which lends itself to pictorial illustration; and the photograph or drawing in wash reproduced in half-tone has of late to a great extent ousted line work from the better class of both books and periodicals.

Improvements in machinery have made it possible to print illustrations at a very high speed; and the facility with which photographs can now be taken of scenes such as the public sight of the hand of artists who promoted it against the unintelligent book-making now being prevalent. Much more effective and far-reaching in the same direction was the influence of William Morris, as shown in the publications of the Kelmscott Press (dating from 1891). In these volumes the aim was to produce illustrations and ornaments which were of their own nature akin to, and thus able to harmonize with the type, and to do this by pure handicraft

work. As a result, a distinct improvement is to be found in the mere book-making of Great Britain; and although the main force of the movement soon spent itself in somewhat uninspired imitations, there can be no doubt of the survival of a taste for well-produced volumes, in which the relationship of type, paper, illustration and binding has been a matter of careful and artistic consideration. Under this influence, a notable feature has been the re-issue, in an excellent form, of illustrated editions of the works of most of the famous writers.

In France the general movement has proceeded upon lines on the whole very similar. Process—especially what was called "Gillotage"—was adopted earlier, and used at first with greater liberality than in England, although wood-engraving has persisted effectively even up to our own time. In the various types of periodicals of which the *Revue Illustrée*, *Figaro Illustré* and *Gil Blas Illustré* may be taken as examples, the most noticeable feature is a use of colour-printing, which is far in advance of anything generally attempted in Great Britain. A favourite and effective process is that employed for the reproduction of chalk drawings (as by Steinen), which consists of the application of a surface-tint of colour from a metal plate to a print from an ordinary process block.

In Germany, *Jugend*, *Simplicissimus*, and other publications devoted to humour and caricature, employ colour-printing to a great extent with success. The organ of the artists of the younger German schools, *Pan* (1895), makes use of every means of illustration, and has especially cultivated lithography and wood-cuts, using these arts effectively but with some eccentricity. Holland has also employed colour lithography for a remarkable series of children's books illustrated by van Hoytema and others. The Viennese *Kunst und Kunsthandwerk* is an art publication which is exceptionally well produced and printed.

Illustration in the United States has some few characteristics which differentiate it from that of other countries. The later school of fine wood-engraving is even yet in existence. American artists also introduced an effective use of the process block, namely, the engraving or working over of the whole or certain portions of it by hand. This is generally done by an engraver, but in certain cases it has been the work of the original draughtsman, and its possibilities have been foreseen by him in making his drawing. The only other variant of note is the use of half-tone blocks superimposed for various colours. (E. F. S.)

**ILLUSTRES**, the Latin name given to the highest magistracies of the later Roman Empire. The designation was at first informal, and not strictly differentiated from other marks of honour. From the time of Valentinian I. it became an official title of the consuls, the chief prefects or ministers, and of the commanders-in-chief of the army. Its usage was eventually extended to lower grades of the imperial service, and to pensionaries from the order of the *spectabiles*. The *Illustres* were privileged to be tried in criminal cases by none but the emperor or his deputy, and to delegate procurators to represent them in the courts.

See O. Hirschfeld in *Sitzungsberichte der Berliner Akademie* (1901), p. 594 sqq.; and T. Hodgkin, *Italy and her Invaders* (Oxford, 1892), p. 603-617.

**ILLYRIA**, a name applied to part of the Balkan Peninsula extending along the eastern shore of the Adriatic from Fiume to Durazzo, and inland as far as the Danube and the Servian Moravia. This region comprises the modern provinces or states of Dalmatia, Bosnia and Herzegovina, and Montenegro, with the southern half of Croatia-Slavonia, part of western Servia, the sanjak of Novibazar, and the extreme north of Albania. As the inhabitants of Illyria never attained complete political unity its landward boundaries were never clearly defined. Indeed, the very name seems originally to have been an ethnological rather than a geographical term; the older Greek historians usually wrote of "the Illyrians" (*oi Ἰλλυριοί*), while the names *Illyria* (*Ἰλλυρία*) or less commonly *Illyria* (*Ἰλλυρία*) came subsequently to be used of the indeterminate area inhabited by the Illyrian tribes, i.e. a region extending eastward from the Adriatic between Liburnia on the N. and Epirus on the S., and gradually shading off into the territories of kindred peoples towards Thrace. The Latin name *Illyricum* was not, unless at a very early period, synonymous with *Illyria*; it also may originally have signified the land inhabited by the Illyrians, but it became a political expression, and was applied to various divisions of the Roman Empire, the boundaries of which were frequently changed and often included an area far larger than *Illyria* properly so called. Vienna and Athens at different times formed part of *Illyricum*, but no geographer would ever have included these cities in *Illyria*.

*Ethnology.*—Little can be learned from written sources of the origin and character of the Illyrians. The Greek legend that Cadmus and Harmonia settled in Illyria and became the parents of Illyrius, the eponymous ancestor of the whole Illyrian people, has been interpreted as an indication that the Greeks recognized some affinity between themselves and the Illyrians; but this inference is based on insufficient data. Herodotus and other Greek historians represent the Illyrians as a barbarous people, who resembled the ruder tribes of Thrace. Both are described as tattooing their persons and offering human sacrifices to their gods. The women of Illyria seem to have occupied a high position socially and even to have exercised political power. Queens are mentioned among their rulers. Fuller and more trustworthy information can be obtained from archaeological evidence. In Bosnia the lake-dwellings at Butmir, the cemeteries of Jezerine and Glasinac and other sites have yielded numerous stone and horn implements, iron and bronze ornaments, weapons, &c., and objects of more recent date fashioned in silver, tin, amber and even glass. These illustrate various stages in the development of primitive Illyrian civilization, from the neolithic age onward. The Hallstatt and La Tène cultures are especially well represented. (See W. Ridgeway, *The Early Age of Greece*, 1901; R. Munro, *Bosnia-Herzegovina and Dalmatia*, Edinburgh, 1900; and W. Radimský, *Die neolithische Station von Butmir*, Vienna, 1895-1898.) Similar discoveries have been made in Dalmatia, as among the tumuli on the Sabinocello promontory, and in Croatia-Slavonia. H. Kiepert ("Über den Volkstamm der Leleges," in *Monatsber. Berl. Akad.*, 1861, p. 114) sought to prove that the Illyrians were akin to the Leleges; his theory was supported by E. Schrader, but is not generally accepted. In Dalmatia there appears to have been a large Celtic element, and Celtic place-names are common. The ancient Illyrian languages fall into two groups, the northern, closely connected with Venetic, and the southern, perhaps allied to Messapian and now probably represented by Albanian.

See K. Brugmann, *Kurze vergleichende Grammatik der Indogermanischen Sprachen* (Strassburg, 1904); and his larger *Grundriss der vergleichenden Grammatik* (2nd ed., Strassburg, 1897), with the authorities there quoted, especially P. Kretschmer, *Einleitung in die Geschichte der Griechischen Sprachen* (Göttingen, 1896): see also ALBANIA.

*History.*—Greek colonization on the Illyrian seaboard probably began late in the 7th century B.C. or early in the 6th century. The most important settlements appear to have been at Epidamnus (Durazzo), Targurium (Traù), Rhizon (near Cattaro), Salona (near Spalato), Epidaurum (Ragusavecchia), Zara and on the islands of Curzola, Lesina and Lissa. There is a collection of Greek coins from Illyria in the museum at Agram, and the researches of Professor F. Buljić and others at Salona (see SPALATO) have brought to light Greek inscriptions, Greek pottery, &c. dating from 600 B.C. But Greek influence seems never to have penetrated far into the interior, and even on the coast it was rapidly superseded by Latin civilization after the 3rd century B.C. Until then the Illyrian tribes appear to have lived in a state of intermittent warfare with their neighbours and one another. They are said by Herodotus (ix. 43) to have attacked the temple of Delphi. Brasidas with his small army of Spartans was assaulted by them on his march (424 B.C.) across Thessaly and Macedonia to attack the Athenian colonies in Thrace. The earlier history of the Macedonian kings is one constant struggle against the Illyrian tribes. The migrations of the Celts at the beginning of the 4th century disturbed the country between the Danube and the Adriatic. The Scordisci and other Celtic tribes settled there, and forced the Illyrians towards the south. The necessities of defence seem to have united the Illyrians under a chief Bardylis (about 383 B.C.) and his son Clitus. Bardylis nearly succeeded in destroying the rising kingdom of Macedonia; King Amyntas II. was defeated, and a few years later Perdiccas was defeated and slain (359). But the great Philip crushed the Illyrians completely, and annexed part of their country. During the next century we hear of them as pirates. Issuing from the secluded harbours of the coast, they ravaged the shores of Italy and Greece, and preyed on the

commerce of the Adriatic. The Greeks applied to Rome for help. Teuta, the Illyrian queen, rejected the Roman demands for redress, and murdered the ambassadors; but the two Illyrian Wars (229 and 219 B.C.) ended in the submission of the Illyrians, a considerable part of their territory being annexed by the conquerors. Illyria, however, remained a powerful kingdom with its capital at Scodra (Scutari in Albania), until 180 B.C., when the Dalmatians declared themselves independent of Gentius or Genthius, the king of Illyria, and founded a republic with its capital at Delminium (see DALMATIA: *History*, on the site of Delminium). In 168 Gentius came into conflict with the Romans, who conquered and annexed his country. Dalmatia was invaded by a Roman army under Gaius Marcius Figulus in 156, but Figulus was driven back to the Roman frontier, and in Dalmatia the Illyrians were not finally subdued until 165 years afterwards. Publius Scipio Nasica, who succeeded Figulus, captured Delminium, and in 119 L. Caecilius Metellus overran the country and received a triumph and the surname *Dalmaticus*. But in 51 a Dalmatian raid on Liburnia led to a renewal of hostilities; the Roman armies were often worsted, and although in 39 Asinius Pollio gained some successes (see HORACE, *Odes* ii. 2. 15) these appear to have been exaggerated, and it was not until Octavian took the field in person that the Dalmatians submitted in 33. (For an account of the war see Appian, *Illyria*, 24-28; Dio Cassius *xix.* 38; Livy, *Epit.* 131, 132.) They again revolted in 16 and 11, and in A.D. 6-9 joined the rebel Pannonians. Suetonius (*Tiberius*, 16) declares that they were the most formidable enemies with whom the Romans had had to contend since the Punic Wars. In A.D. 9, however, Tiberius entirely subdued them, for which he was awarded a triumph in 12 (Dio Cass. *iv.* 23-29, *lvi.* 11-17; Vell. *pat.* ii. 110-115). Thenceforward Dalmatia, Iapydia and Liburnia were united as the province of Illyricum.

Latin civilization spread rapidly, the cultivation of the vine was introduced, gold-mining was carried on in Bosnia, and flourishing commercial cities arose along the coast. Illyria became one of the best recruiting grounds for the Roman legions; and in troubled times many Illyrian soldiers fought their way up from the ranks to the imperial purple. Claudius, Aurelianus, Probus, Diocletian and Maximian were all sons of Illyrian peasants. It is probable, however, that most of the highland tribes now represented by the Albanians remained almost unaffected by Roman influence. The importance of Illyricum caused its name to be extended to many neighbouring districts; in the 2nd century A.D. the *Illyricus Limes* included Noricum, Pannonia, Moesia, Dacia and Thrace. In the reorganization of the empire by Diocletian (285) the diocese of Illyricum was created; it comprised Pannonia, Noricum and Dalmatia, while Dacia and Macedonia, together called Eastern Illyricum, were added later. Either Diocletian or after him Constantine made Illyricum one of the four prefectures, each governed by a *praefectus praetorio*, into which the empire was divided. This prefecture included Pannonia, Noricum, Crete and the entire Balkan peninsula except Thrace, which was attached by Constantine to the prefecture of the East. From the partition of the empire in 285 until 379 Illyricum was included in the Western Empire, but thenceforward Eastern Illyricum was annexed to the Eastern Empire; its frontier was almost identical with the line of demarcation between Latin-speaking and Greek-speaking peoples, and roughly corresponded to the boundary which now severs Latin from Greek Christianity in the Balkan peninsula. The whole peninsula except Thrace was still known as Illyricum, but was subdivided into Illyris Barbara or Romana and Illyris Graeca (Eastern Illyricum with Greece and Crete). The Via Egnatia, the great line of road which connected Rome with Constantinople and the East, led across Illyricum from Dyrrachium to Thessalonica.

In the 5th century began a series of invasions which profoundly modified the ethnical character and the civilization of the Illyrians. In 441 and 447 their country was ravaged by the Huns. In 481 Dalmatia was added to the Ostrogothic kingdom, which already included the more northerly parts of Illyricum,

46. Pannonia and Noricum. Dalmatia was partially reconquered by Justinian in 536, but after 565 it was devastated by the Avars, and throughout the century bands of Slavonic invaders had been gradually establishing themselves in Illyria, where, unlike the earlier barbarian conquerors, they formed permanent settlements. Between 600 and 650 the main body of the immigrants occupied Illyria (see *SERVIA: History*; and *SLAVS*). It consisted of Croats and Serbs, two groups of tribes who spoke a single language and were so closely related that the origin of the distinction between them is obscure. The Croats settled in the western half of Illyria, the Serbs in the eastern; thus the former came gradually under the influence of Italy and Roman Catholicism, the latter under the influence of Byzantium and the Greek Church. Hence the distinction between them became a marked difference of civilization and creed, which has always tended to keep the Illyrian Slavs politically disunited.

The Croats and Serbs rapidly absorbed most of the Latinized Illyrians. But the wealthy and powerful city-states on the coast were strong enough to maintain their independence and their distinctively Italian character. Other Roman provincials took refuge in the mountains of the interior; these Mavrovlachi, as they were called (see *DALMATIA: Population*; and *VLACHS*), preserved their language and nationality for many centuries. The Illyrian tribes which had withstood the attraction of Roman civilization remained unconquered among the mountains of Albania and were never Slavonized. With these exceptions Illyria became entirely Serbo-Croatian in population, language and culture.

The name of Illyria had by this time disappeared from history. In literature it was preserved, and the scene of Shakespeare's comedy, *Twelfth Night*, is laid in Illyria. Politically the name was revived in 1809, when the name Illyrian Provinces was given to Carniola, Dalmatia, Istria, Fiume, Görz and Gradisca, and Trieste, with parts of Carinthia and Croatia; these territories were ceded by Austria to Italy at the peace of Schönbrunn (14th Oct. 1809). The Illyrian Provinces were occupied by French troops and governed in the interest of Napoleon; the republic of Ragusa was annexed to them in 1811, but about the end of 1813 the French occupation ceased to be effective and the provinces reverted to Austria. The kingdom of Illyria, which was constituted in 1816 out of the crown-lands of Carinthia, Carniola, Istria, Görz and Gradisca, and Trieste, formed until 1849 a kingdom of the Austrian crown. For the political propaganda known as Illyrism, see *CROATIA-SLAVONIA: History*.

**BIBLIOGRAPHY.**—In addition to the authorities quoted above, see G. Zippel, *Die römische Herrschaft in Illyrien bis auf Augustus* (Leipzig, 1871); P. O. Bahn, *Der Ursprung der römischen Provinz Illyrien* (Grimma, 1876); J. Marquardt, *Römische Staatsverwaltung*, i. (1881), p. 295; E. A. Freeman, "The Illyrian Emperors and their Land" (*Historical Essays*, series 3, 1879); C. Patsch in Pauly-Wissowa's *Realencyclopädie*, iv. pt. 2 (1901); Th. Mommsen, *The Provinces of the Roman Empire* (ed. F. Havelfield, 1909).

**ILMENAU**, a town and summer resort of Germany, in the grand-duchy of Saxe-Weimar, at the north foot of the Thuringian Forest, on the river Ilm, 30 m. by rail south of Erfurt. Pop. (1905) 11,222. The town, which stands picturesquely among wooded hills, is much frequented by visitors in the summer. It was a favourite resort of Goethe, who wrote here his *Iphigenie*, and often stayed at Gabelbach in the neighbourhood. It has a grand-ducal palace, a Roman Catholic and two Evangelical churches, a sanatorium for nervous disorders, and several educational establishments. Its chief manufactures are glass and porcelain, toys, gloves and chemicals, and the town has tanneries and saw-mills. Formerly a part of the county of Henneberg, Ilmenau came in 1631 into the possession of electoral Saxony, afterwards passing to Saxe-Weimar.

See R. Springer, *Die klassischen Stätten von Jena und Ilmenau* (Berlin, 1869); Patsch, *Goethe und Ilmenau* (Land ed., Weimar, 1902); and Fils, *Bad Ilmenau und seine Umgebung* (Hildburghausen, 1886).

**ILMENITE**, a mineral known also as titanite iron, formerly regarded as an iron and titanium sesquioxide (Fe,Ti)<sub>2</sub>O<sub>3</sub> isomorphous with haematite (Fe<sub>2</sub>O<sub>3</sub>), but now generally considered to be an iron titanate FeTiO<sub>3</sub> isomorphous with pyrophanite (MnTiO<sub>3</sub>) and geikielite (MgTiO<sub>3</sub>). It crystallizes in the parallel-

facied hemihedral class of the rhombohedral system, thus having the same degree of symmetry as phenacite and pyrophanite, but differing from that of haematite. The angles between the faces are very nearly the same as between the corresponding faces of haematite; but it is to be noted that the rhombohedral angle (94° 29') of ilmenite is not intermediate between that of haematite (94° 0') and of the artificially prepared crystals of titanium sesquioxide (92° 40'), which should be the case if the three substances were isomorphous.

Analyses show wide variations in chemical composition, and there is a gradation from normal ilmenite FeTiO<sub>3</sub> (with titanium dioxide 52.7, and ferrous oxide 47.3%) to titaniferous haematite and titaniferous magnetite. Frequently also, magnesia and manganese oxide are present in small amounts, the former reaching 16%. The formula (Fe,Mg)TiO<sub>3</sub> is then analogous to those of geikielite and pyrophanite. Many analyses show the presence of TiO<sub>2</sub> and (Fe,Mg)O in this ratio of 1:1, yet there is often an excess of ferric oxide to be accounted for; this may perhaps be explained by the regular intergrowth on a minute scale of ilmenite with haematite, like the intergrowth of such substances as calcite and sodium nitrate, which are similar crystallographically but not chemically.

In many of its external characters ilmenite is very similar to haematite; the crystals often have the same tabular or lamellar habit; the twin-laws are the same, giving rise to twin-lamellae and planes of parting parallel to the basal plane and the primitive rhombohedron; the colour is iron-black with a submetallic lustre; finally, the conchoidal fracture is the same in both minerals. Ilmenite has a black streak; it is opaque, but in very thin scales sometimes transparent with a clove-brown colour. It is slightly magnetic, but without polarity. The hardness is 5½, and the specific gravity varies with the chemical composition from 4.3 to 5.0.

Owing to the wide variations in composition, which even yet are not properly understood, several varieties of the mineral have been distinguished by special names. Crichtonite occurs as small and brilliant crystals of acute rhombohedral habit on quartz at Le Bourg d'Oisans in Dauphiné; it agrees closely in composition with the formula FeTiO<sub>3</sub> and has a specific gravity of 4.7. Manaccanite (or Menaccanite) is a black sandy material, first found in 1791 in a stream at Manaccan near Helston in Cornwall. Iserite, from Iserwiese in the Iser Mountains, Bohemia, is a similar sand, but containing some octahedral crystals, possibly of titaniferous magnetite. Washingtonite is found as large tabular crystals at Washington, Connecticut. Uddevalite is from Uddevalle in Sweden. Picrotitanite or picroilmenite (Gr. *πικρός*, "bitter") is the name given to varieties containing a considerable amount of magnesia. Other varieties are kibelophane, hystatite, &c. The name ilmenite, proposed by the A. T. Kupfer in 1827, is after the Ilmen Mountains in the southern Ural, whence come the best crystals of the mineral. The largest crystals, sometimes as much as 16 lb in weight, are from Kragerø and Arendal in Norway.

Ilmenite occurs, often in association with magnetite, in gneisses and schists, sometimes forming beds of considerable extent, but of little or no economic value. It is a common accessory constituent of igneous rocks of all kinds, more especially basic rocks such as gabbro, diabase and basalt. In these rocks it occurs as platy crystals, and is frequently represented by a white, opaque alteration product known as leucoxene. (L. J. S.)

**ILOILO**, a town, port of entry and the capital of the province of Iloilo, Panay, Philippine Islands, at the mouth of Iloilo river, on the S.E. coast. Pop. (1903) 19,054. In 1903, after the census had been taken, the population of the town was more than doubled by the addition of the municipalities of La Paz (pop. 5724), Mandurriao (pop. 4482), Molo (pop. 8557) and Jaro (pop. 10,681); in 1908 Jaro again became a separate town. The town is built on low sandy ground, is irregularly laid out,



and its streets are not paved. It has a good government house and a fine church. The harbour, suitable for ships of 15 ft. draught, is well protected by the island of Guimaras, and oceangoing vessels can lie in the channel. The surrounding country, which is traversed by gravel roads leading to the principal towns of the province, is fertile and well cultivated, producing sugar, tobacco and rice in abundance. In commercial importance Iloilo ranks next to Manila among Philippine cities; it has manufactures of piña, jusi, coconut oil, lime, vinegar and various articles made from palm wood. Much of the town was burned by Filipino insurgents soon after its capture by American troops in February 1899.

**ILSENBURG**, a village and health resort of Germany, in Prussian Saxony, romantically situated under the north foot of the Harz Mountains, at the entrance to the Ilsenthal, 6 m. N.W. from Wernigerode by the railway to Goslar. Pop. (1900) 3868. It has an Evangelical church, a modern chateau of the princes of Stolberg, with pretty grounds, and a high grade school, and manufactures metal wares, machines and iron screws and bolts.

Owing to its charming surroundings and its central position in the range, Ilseburg is one of the most frequented tourist resorts in the Harz Mountains, being visited annually by some 6000 persons. The old castle, Schloss Ilseburg, lying on a high crag above the town, was originally an imperial stronghold and was probably built by the German king Henry I. The emperor Otto III. resided here in 995, Henry II. bestowed it in 1003 upon the bishop of Halberstadt, who converted it into a Benedictine monastery, and the school attached to it enjoyed a great reputation towards the end of the 11th century. After the Reformation the castle passed to the counts of Wernigerode, who restored it and made it their residence until 1710. Higher still, on the edge of the plateau rises the Isenstein, a granite peak standing about 500 ft. above the valley, crowned by an iron cross erected by Count Anton von Stolberg-Wernigerode in memory of his friends who fell in the wars of 1813-1815. Around this rock cluster numerous legends.

See Jacobs, *Urkundenbuch des Klosters Ilseburg* (Halle, 1875); Brandes, *Ilseburg als Sommeraufenthalt* (Wernigerode, 1885); and H. Herr, *Ilseburger Annalen* (Leipzig, 1890).

**IMAGE** (Lat. *imago*, perhaps from the same root as *imitari*, copy, imitate), in general, a copy, representation, exact counterpart of something else. Thus the reflection of a person in a mirror is known as his "image"; in popular usage one person is similarly described as "the very image" of another; so in entomology the term is applied in its Latin form *imago* to an insect which, having passed through its larval stages, has achieved its full typical development. The term is in fact susceptible of two opposite connotations; on the one hand, it implies that the thing to which it is applied is only a copy; on the other that as a copy it is faithful and accurate.

Psychology (*q.v.*) recognizes two uses of the term. The simplest is for the impression made by an observed object on the retina, the eye; in this connexion the term "after-image" (better "after-sensation") is used for an image which remains when the eye is withdrawn from a brilliantly lighted object; it is called positive when the colour remains the same, negative when the complementary colours are seen. The strict psychological use of the term "image" is by analogy from the physiological for a purely mental idea which is taken as being observed by the eye of the mind. These images are created or produced not by an external stimulus, such as is necessary for a visual image (even the after-image is due to the continued excitement of the same organ), but by a mental act of reproduction. The simplest ideational image, which has been described as the primary memory-image, is "the peculiarly vivid and definite ideal representation of an object which we can maintain or recall by a suitable effort of attention immediately after perceiving it" (Stout). For this no external stimulus is required, and as compared with the after-image it represents the objects in perspective just as they might be seen in perception. This is characteristic of all mental images. The essential requisite for this primary

image is that the attention should have been fixed upon the impressions.

The relation between sense-impressions and mental images is a highly complicated one. Difference in intensity is not a wholly satisfactory ground of distinction; abnormal physical conditions apart, an image may have an intensity far greater than that of a sense-given impression. On the other hand, Hume is certainly right in holding that the distinctive character of a percept as compared with an image is in all ordinary cases the force and liveliness with which it strikes the mind—the distinction, therefore, being one of quality, not of degree. A distinction of some importance is found in the "superior steadiness" (Ward) of impressions; while looking at any set of surroundings, images of many different scenes may pass through the mind, each one of which is immediately distinguished from the impression of the actual scene before the eyes. This arises partly, no doubt, from the fact that the perception has clear localization, which the image has not. In many cases indeed an image even of a most familiar scene is exceedingly vague and inaccurate.

In Art the term is used for a representation or likeness of an animate or inanimate object, particularly of the figure of a person in sculpture or painting. The most general application of the word is to such a representation when used as an object of religious worship or adoration, or as a decorative or architectural ornament in places of religious worship. The worship of images, or idolatry, from the point of view of comparative religion, is treated in the article *IMAGE-WORSHIP*, and the history of the attitude of the Christian church, outside the post-Reformation church of England, towards the use of images as objects of worship and religion in the article *ICONOCLASTS*. With regard to the Pre-Reformation period in England, it is of interest to note that by the constitutions of Archbishop Winchelsea, 1305, it was the duty of the parish to provide for the parish church, among other objects, the images of Christ on the Cross, of the saint to whom the church was dedicated, to be placed in the chancel, and of other saints. The injunctions of Edward VI., 1547, ordered the destruction of all images that had been the objects of superstitious use, and the act of 1549 (3 & 4 Edw. VI. c. 10) declared all such images illegal. This act, repeated in Mary's reign, was revived in 1604 (1 James I. c. 25) and is still in force. The present effect of this unrepealed act, as stated in *Boyd v. Philpotts* (L.R. 6 P.C. 440), is that it only referred to the images then subject to abuse, which had been ordered to be removed, and did not refer to the subsequent use or abuse of other images. In Article XXII. of the Articles of Religion it is laid down that "the Romish Doctrine concerning . . . Worshipping and Adoration as well of Images as of Reliques . . . is a fond thing mainly invented and grounded on no warranty of Scripture, but rather repugnant to the Word of God." The law in regard to images, which in this connexion include pictures and stained-glass windows, but not sculptured effigies on monuments or merely ornamental work, is contained in various judicial decisions, and is not defined by statute. The effect of these decisions is thus summarized in the report of the Royal Commission on Ecclesiastical Discipline, 1906: "Such images are lawful as objects of decoration in a church, but are unlawful if they are made, or are in danger of being made, objects of superstitious reverence, contrary to Article XXII. against the worshipping and adoration of images. In accordance with this view, crosses, if not placed on the Holy Table, and also crucifixes, if part only of a sculptured design or architectural decoration, have been declared lawful. The question whether a crucifix or rood standing alone or combined with figures of the Blessed Virgin and St John can, in any circumstances, be regarded as merely decorative, has given rise to a difference of judicial opinion and appears to be unsettled." Speaking generally, articles of decoration and embellishment not used in the services cannot lawfully be introduced into a church without the consent of the ordinary given by a faculty, the granting of which is subject to the judicial discretion of the chancellor or commissary, sitting as judge of the bishop's court.

By section 8 of the Public Worship Regulation Act 1874, complainants may take proceedings if it is considered that "any alteration in, or addition to, the fabric, ornaments or furniture has been made without legal authority, or that any decoration forbidden by law has been introduced into such church . . . provided that no proceedings shall be taken . . . if such alteration or addition has been completed five years before the commencement of such proceedings." The following are the principal cases on the subject: in *Boyd v. Philpotts*, 1874 (L.R., 4 *Ad. & Ec.* 297; 6 P.C. 433), the Exeter *heredes* case, the privy council, reversing the bishop's judgment, allowed the structure, which contained sculptures in high relief of the Ascension, Transfiguration and Descent of the Holy Ghost at Pentecost, together with a cross and angels; in *R. v. the Bishop of London*, 1889 (23 *Q.B.D.* 414, 24 *Q.B.D.* 213), the St Paul's *heredes* case, the bishop refused further proceedings against the legality of a structure containing sculptured figures of Christ on the Cross and the Virgin and Child. In *Clifton v. Ridsdale*, 1876 (1 *P. & D.*, 316), a metal crucifix on the centre of the chancel screen was declared illegal as being in danger of being used superstitiously, and in the same case pictures or rather coloured reliefs representing the "Stations of the Cross" were ordered to be removed on the ground that they had been erected without a faculty, and were also considered unlawful by Lord Penzance as connected with certain superstitious devotion authorized by the Roman church.

**IMAGE WORSHIP.** It is obvious that two religious votaries kneeling together before a statue may entertain widely different conceptions of what the image is and signifies, although their outward attitude is the same. The one may regard it as a mere image, picture or representation of the higher being, void in itself of value or power. It is to him, like the photograph hung on a wall of one we love, cherished as a picture and no more. But the other may regard it, as a little girl regards her doll, as an animated being, no mere picture, but as tenement and vehicle of the god and fraught with divine influence. The former is the attitude which the Latin Church officially inculcates towards sacred pictures and statues; they are intended to convey to the eyes of the faithful, especially to the illiterate among them, the history of Jesus, of the Virgin and of the saints. The other attitude, however, is that into which simple-minded Latin peasants actually lapse, as it is also that which characterizes other religions ancient or modern which use pictures or sculptures of gods, demons, men, brutes, or of particular parts and organs of the same. With the latter attitude alone does the present article deal, and it may conveniently be called idolatry or image worship. For the history of the use of images in Christian worship see **ICONOCLASTS**.

The image or idol differs from the fetish, charm, talisman, phylactery or miraculous relic, only in this, that either in the flat or the round it *resembles* the power adored; it has a prototype capable of being brought before the eye and visualized. This is not necessarily the case with the worshipper of *aniconic* or unshaped gods. The Semite or savage who sets up a sacred stone or Bethel believes indeed that a divine power or influence enters the stone and dwells in it, and he treats the stone as if it were the god, kisses it, anoints it with oil, feeds the god in it by pouring out over it the blood of victims slain. But he is not an idolater, for he has not "made unto himself any graven image, nor the likeness of anything that is in heaven above or in the water beneath or in the water under the earth."

The question arises: must the stage of aniconic gods historically precede and lead up to that of pictures and images? Are the latter a development of the former? In the history of human religions can we trace, as it were, a law of transition from sacred stock and stone up to picture and image? Is it true to say that the latter is characteristic of a later and higher stage of religious development? It was perhaps the facility with which a pillar of stone or wood can be turned into an image by painting or sculpturing on it eyes, ears, mouth, marks of sex and so on, which led anthropologists of an earlier generation to postulate such a law of development; but facts do not bear it out. In the

first place, what we are accustomed to call higher religions deliberately attach greater sanctity to aniconic gods than to iconic ones, and that from no artistic incapacity. The Jews were as well able as their neighbours to fashion golden calves, snakes and the minor idols called teraphim, when their legislator, in the words we have just cited, forbade the ancillary use of all plastic and pictorial art for religious purposes. And of our own Christianity, Robertson Smith remarks as follows: "The host in the Mass is artistically as much inferior to the Venus of Milo as a Semitic *Masyřba* was, but no one will say that medieval Christianity is a lower form of religion than Aphrodite worship."

Here then in the most marked manner the aniconic sacrament has ousted pictures and statues. It is the embodiment and home of divine personality and power, and not they. Equally contradictory of any such law of development is the circumstance that the Greeks of the 5th and 4th centuries B.C., although Pheidias and other artists were embodying their gods and goddesses in the most perfect of images, nevertheless continued to cherish the rude aniconic stocks and stones of their ancestors. If any such law ever operated in human religious development, how can we explain the following facts. In the shadowy age which preceded the Stone age and hardly ended later than 10,000 B.C., the cave-dwellers of the Dordogne could draw elks, bisons, elephants and other animals at rest or in movement, with a freshness and realism which to-day only a Landseer can rival. And yet in the European Stone age which followed, the age in which the great menhirs and cromlechs were erected, in which the domestication of animals began and the first corn was sown, we find in the strata no image of man or beast, big or little.

Whence this seeming blight and decay of art? Salomon Reinach, guided by the analogy of similar practices among the aborigines of Australia, and noticing that these primitive pictures represent none but animals that formed the staple food of the age and place, and that they are usually found in the deepest and darkest recesses of the caves where they could only be drawn and seen by torchlight, has argued that they were not intended for artistic gratification (a late motive in human art), but were magical representations destined to influence and perhaps attract the hunter's quarry. In a word this earliest art was ancillary to the chase. It is a common practice in the magic of all ages and countries to acquire control and influence over men and animals by making images of them. The prototype is believed to suffer whatever is done to the image. Reinach, therefore, supposes that in the Stone age which succeeded, pictorial art was banned because it had got into the hands of magicians and had come to be regarded as inevitably uncanny and malefic. This is certainly the secret of the ordinary Mahomedan prohibition of pictures and statues, which goes even to the length of denying to poor little Arab girls the enjoyment of having dolls. It is felt that if you have got a picture of any one, you have some power of harming him through it; you can bind or loose him, just as you can a Djinn whose name you have somehow learned. It is as dangerous for your enemy to have a picture of you as for him to know your name. The old Hebrew prohibition of graven images was surely based on a like superstition, so far as it was not merely due to the physical impossibility for nomads of heavy statues that do not admit of being carried from camp to camp and from pasture to pasture. Possessing no images of Yahweh the Jews were also not exposed to the same risk as were idolaters of having their gods stolen by their foes and used against them. Lastly, the restriction to aniconic worship saved them from much superstition, for there is nothing which so much stimulates the growth of a mythology as the manufacture of idols. The artist must indeed start with imaginative types, revealed to him in visions or borrowed from current myths. But the tendency of his art is to give rise to new tales of the gods. There is perpetual action and reaction between picture and myth; and a legislator desiring to purify and raise his countrymen's religion must devote no less attention to their plastic art than to their homology.

Motives drawn from ethnopsychic magic may thus explain the occasional disuse and prohibition of pictorial and plastic

art in cult; they may equally explain its genesis and rise in certain ages and countries. Prayer is much more hopeful and efficacious for a worshipper who has means of bringing near to himself, and even coercing the god he worships. An image fashioned like a god, and which has this advantage over a mere stock and stone that it declares itself and reveals at a glance to what god it is sacred, must surely attract and influence the god to choose it as his home and tenement. And having the god thus at hand and imprisoned in matter, the simple-minded worshipper can punish him if his prayers are left unanswered. Dr E. B. Tylor accordingly (in his chapter on "Idolatry" in *Primitive Culture*, ii. 170), reminds us of "the negro who feels ancestral images and brings them a share of his trade profits, but will beat an idol or fling it into the fire if it cannot give him luck or preserve him from sickness." So Augustus Caesar, having lost some ships in a storm, punished Neptune by forbidding his image to be carried in procession at the Circensian games (Sueton. *Aug.* 16).

In certain cases the wish to carry elsewhere the cult of a favourite or ancestral cult, may have dictated the manufacture of images that declare themselves and reveal at a glance whose they are. Thus a Phoenician colonist might desire to carry abroad the cult of a certain Baal or Astarte who lived in a conical stone or pillar. Pilgrims visiting Paphos, the original home and temple of Astarte, could of course be in no doubt about which of the heavenly powers inhabited the cone of stone in which she was there held to be immanent; nor was any Semite ever ignorant as to which Baal he stood before. It was necessarily the Baal or Lord of the region. But small portrait statues must surely have been made to be carried about or used in private worship. Meanwhile the shapeless cone remained the object of public adoration and pilgrimage.

The Egyptian writer Hermes Trismegistus (c. 250), in a work called *Asclepius* (cited by Augustine, *De civit. Dei*, viii. 26), claims that his ancestors discovered the art of making gods, and since they could not create souls, they called up the souls of demons or angels and introduced them into the holy images and divine mysteries, that through these souls the idols might possess powers of doing good and harm. This was the belief of the pagans; and the Christians for centuries shared it with them. Not a few Christian martyrs sought and won the palm by smashing the idols in order to dislodge the indwelling devil; occasionally their zeal was further gratified by beholding it pass away like smoke from its ruined home.

Image worship then is a sort of animism. It is a continuance by adults of their childish games with dolls. In the Roman religion, on a feast of thanksgiving for a great victory, couches were spread in the temples for the gods, whose images were taken down from their pedestals and laid on the couches, and tables set before them loaded with delicate viands. This was called a *Lectisternium*. So Marco Polo (i. chap. 53) relates how the Tatars had each a figure of Natigay, the god of the earth, who watched over their children, cattle and crops. The image was made of felt and cloth, and similar images of his wife and children were set on his left hand and in front of him. "And when they eat, they take the fat of the meat and grease the god's mouth withal, as well as the mouths of his wife and children." The old Greek statues moved of themselves, shook their spears, knelt down, spoke, walked, wept, laughed, winked, and even bled and sweated,—a mighty portent. Images of Christ, of the Virgin and saints have achieved many a similar miraculous portent. A figure of Christ has been known even to give its shoes to a poor man, and a Virgin to drop a ring off her finger to a suppliant. In Umbrian villages on Easter Sunday the images of Jesus and His Mother are carried in rival processions from their respective chapels, and are made to bow when they meet face to face. The spectators applaud or hiss according as they make their bow well or ill. In antiquity it was a common ceremony to arrange a holy marriage between male and female images, and such unions acted on the earth as a fertility charm. Much of a priest's time was given up to the toilet of the god or goddess. Thus Isis was dressed and coiffed every day by her special attendants

according to Apuleius (*Met.* xi. 9). Like the statue of St Agatha of Catania to-day, her image was loaded with jewels, and an inscription of Cadiz (*C.I.L.* ii. 3386) contains an inventory of the jewels with which Isis had been endowed by Spanish devotees.

Idolatrous cults repose so largely on make-believe and credulity that the priests who administered them, perhaps oftener than we know, fell into the kind of imposture and trickery of which the legend of Bel and the dragon represents a classical example. "Thinkest thou not," said King Astyages, "that Bel is a living god? Or seest thou not how much he eateth and drinketh every day? Then Daniel laughed, and said, O King, be not deceived: for this is but clay within, and brass without, and did never eat or drink anything." In the sequel Daniel proves to the king that the priests with their wives and children came in through privy doors and consumed the viands set before the god; and the king, angered at their trickery, slew them all and gave Bel over to Daniel for destruction.

The investives against idolatry of the early Jewish and Christian apologists, of Philo, Minucius Felix, Tertullian, Arnobius, Lactantius and others, are very good reading and throw much light on the question how an ancient pagan conceived of his idols. One capital argument of the Christians was the absurdity of a man making an idol and then being afraid of or adoring the work of his own hands. Lactantius preserves the answer of the pagans so attacked (*De origine Erroris*, ii. 2): We do not, they said, fear the images themselves, but those beings after whose likeness they were fashioned and by whose names they were consecrated. Few such rites of consecration remain, but they must have been similar to those used in India to-day. There the Brahmin invites the god to dwell within the image, specially made hollow to contain him, "performing the ceremony of *adhivāsa* or inhabitation, after which he puts in the eyes and the *prāna*, i.e. breath, life or soul."<sup>1</sup> Similarly Augustine (*De civ. Dei*, viii. 23) relates how, according to Hermes, the spirits entered by invitation (*spiritus invitatos*), so that the images became bodies of the gods (*corpore deorum*), thus the invisible spirits by a certain art are so joined unto the visible objects of corporeal matter that the latter become as it were animated bodies, images dedicated to those spirits and controlled by them (see CONSECRATION). Such statues were animated with sense and full of spirit, they foresaw the future, and foretold it by lot, through their priests, in dreams and in other ways.

See E. B. Tylor, *Primitive Culture*, ed. 1903 (list of authorities and sources vol., p. 171); L. R. Farnell, *The Evolution of Religion* (London, 1905); Jacob Grimm, *Teutonic Mythology*, translation by J. S. Stallybrass. (F. C. C.)

**IMAGINATION**, in general, the power or process of producing mental pictures or ideas. The term is technically used in psychology for the process of reviving in the mind percepts of objects formerly given in sense perception. Since this use of the term conflicts with that of ordinary language, some psychologists have preferred to describe this process as "imaging" or "imagery" or to speak of it as "reproductive" as opposed to "productive" or "constructive" imagination (see IMAGE and PSYCHOLOGY). The common use of the term is for the process of forming in the mind new images which have not been previously experienced, or at least only partially or in different combinations. Thus the image of a centaur is the result of combining the common percepts of man and horse; fairy tales and fiction generally are the result of this process of combination. Imagination in this sense, not being limited to the acquisition of exact knowledge by the requirements of practical necessity, is up to a certain point free from objective restraints. In various spheres, however, even imagination is in practice limited: thus a man whose imaginations do violence to the elementary laws of thought, or to the necessary principles of practical possibility, or to the reasonable probabilities of a given case is regarded as insane. The same limitations beset imagination in the field of scientific hypothesis.

<sup>1</sup> Tylor, *Prim. Culture*, ii. 178.

Progress in scientific research is due largely to provisional explanations which are constructed by imagination, but such hypotheses must be framed in relation to previously ascertained facts and in accordance with the principles of the particular science. In spite, however, of these broad practical considerations, imagination differs fundamentally from belief in that the latter involves "objective control of subjective activity" (Stout). The play of imagination, apart from the obvious limitations (e.g. of avoiding explicit self-contradiction), is conditioned only by the general trend of the mind at a given moment. Belief, on the other hand, is immediately related to practical activity: it is perfectly possible to imagine myself a millionaire, but unless I believe it I do not, therefore, act as such. Belief always endeavours to conform to objective conditions; though it is from one point of view subjective it is also objectively conditioned, whereas imagination as such is specifically free. The dividing line between imagination and belief varies widely in different stages of mental development. Thus a savage who is ill frames an ideal reconstruction of the causes of his illness, and attributes it to the hostile magic of an enemy. In ignorance of pathology he is satisfied with this explanation, and actually believes in it, whereas such a hypothesis in the mind of civilized man would be treated as a pure effort of imagination, or even as a hallucination. It follows that the distinction between imagination and belief depends in practice on knowledge, social environment, training and the like.

Although, however, the absence of objective restraint, i.e. a certain unreality, is characteristic of imagination, none the less it has great practical importance as a purely ideational activity. Its very freedom from objective limitation makes it a source of pleasure and pain. A person of vivid imagination suffers acutely from the imagination of perils besetting a friend. In fact in some cases the ideal construction is so "real" that specific physical manifestations occur, as though imagination had passed into belief or the events imagined were actually in progress.

**IMÂM**, an Arabic word, meaning "leader" or "guide" in the sense of a "pattern whose example is followed, whether for good or bad." Thus it is applied to the Koran, to a builder's level and plumb-line, to a road, to a school-boy's daily task, to a written record. It is used in several of these senses in the Koran, but specifically several times of leaders and (ii. 118) of Abraham, "Lo, I make thee a pattern for mankind." *Imâm* thus became the name of the head of the Moslem community, whose leadership and patternhood, as in the case of Mahomet himself, is to be regarded as of the widest description. His duty is to be the lieutenant, the Caliph (q.v.) of the Prophet, to guard the faith and maintain the government of the state. Round the origin and basis of his office all controversies as to the Moslem state centre. The Sunnites hold that it is for men to appoint and that the basis is obedience to the general usage of the Moslem peoples from the earliest times. The necessity for leaders has always been recognized, and a leader has always been appointed. The basis is thus agreement in the technical sense (see MAHOMMEDAN LAW), not Koran nor tradition from Mahomet nor analogy. The Shi'ites in general hold that the appointment lies with God, through the Prophet or otherwise, and that He always has appointed. The Khârijites theoretically recognize no absolute need of an Imâm; he is convenient and allowable. The Motazilites held that reason, not agreement, dictated the appointment. Another distinction between the Sunnites and the Shi'ites is that the Sunnites regard the Imâm as liable to err, and to be obeyed even though he personally errs, provided he maintains the ordinances of Islam. Effective leadership is the essential point. But the Shi'ites believe that the divinely appointed Imâm is also divinely illumined and preserved (*ma'sûm*) from sin. The above is called the greater Imânat. The lesser Imânat is the leadership in the Friday prayers. This was originally performed by the Imâm in the first sense, who not only led in prayers but delivered a sermon (*khutba*): but with the growth of the Moslem empire and the retirement of the caliph from public life, it was necessarily given

over to a deputy—part of a gradual process of putting the Imâmate or caliphate into commission. These deputy Imâms are, in Turkey, ministers of the state, each in charge of his own parish; they issue passports, &c., and perform the rites of circumcision, marriage and burial. In Persia among Shi'ites their position is more purely spiritual, and they are independent of the state. A few of their leaders are called *Mujtahids*, i.e. capable of giving an independent opinion on questions of religion and canon law. A third use of the term Imâm is as an honorary title. It is thus applied to leading theologians, e.g. to Abû Hânifa, ash-Shâfi'i, Malik ibn Anas, Ahmad ibn Hânbal (these are called "the four Imâms"), Ghazâlî.

See McC. de Slane's transl. of Ibn Khaldûn's *Prologomènes*, i. 384 seq., 402 seq., 426 seq., 445; iii. 35, 58 seq.; Ostrogorsky's transl. of Mâwardî's *Ahkâm* i. 89 seq.; Haarbrücker's transl. of Shahrastâni by index; Juybol's *De Mohammedanische Wet*, 316 seq.; Sell's *Faith of Islam*, 95 seq.; Macdonald's *Development of Muslim Theology*, 56 seq. (D. B. MA.)

**IMBECILE** (through the French from Lat. *imbecillus* or *imbecillus*, weak, feeble; of unknown origin), weak or feeble, particularly in mind. The term "imbecility" is used conventionally of a condition of mental degeneration less profound than "idiotcy" (see INSANITY).

**IMBEX** (Latin for "tile"), in architecture the term given to the covering tile of the ancient roof: the plain tile is turned up on each side and the imbex covers the joint. In the simpler type of roof the imbex is semicircular, but in some of the Greek temples it has vertical sides and an angular top. In the temple of Apollo at Bassae, where the tiles were in Parian marble, the imbex on one side of the tile and the tile were worked in one piece out of the solid marble.

**IMBROS**, a Turkish island in the Aegean, at the southern end of the Thracian Chersonese peninsula. It forms with Samothrace, about 17 m. distant, a caza (or canton) in the sanjak of Lemnos and province of the Archipelago Isles. Herodotus (v. 26) mentions it as an abode of the historic Pelasgians (q.v.). It was, like Samothrace, a seat of the worship of the Cabeiri (q.v.). The island is now the seat of a Greek bishopric. There is communication with the mainland by occasional vessels. The island is of great fertility—wheat, oats, barley, olives, sesame and valonia being the principal products, in addition to a variety of fruits. Pop. about 92,000, nearly all Turks.

**IMERETIA**, or IMERITIA a district in Russian Transcaucasia, extends from the left bank of the river Tskheniz-Tskhali to the Suram range, which separates it from Georgia on the east, and is bounded on the south by Akhaltsikh, and thus corresponds roughly to the eastern part of the modern government of Kutais. Anciently a part of Colchis, and included in Lazia during the Roman empire, Imeretia was nominally under the dominion of the Greek emperors. In the early part of the 6th century it became the theatre of wars between the Byzantine emperor Justinian and Chosroes, or Khosrau, king of Persia. Between 750 and 985 it was ruled by a dynasty (Apkhaz) of native princes, but was devastated by hostile incursions, reviving only after it became united to Georgia. It flourished until the reign of Queen Thamar, but after her death (1212) the country became impoverished through strife and internal dissensions. It was reunited with Georgia from 1318 to 1346, and again in 1424. But the union only lasted forty-five years; from 1469 until 1810 it was governed by a Bagratid dynasty, closely akin to that which ruled over Georgia. In 1621 it made the earliest appeal to Russia for aid; in 1650 it acknowledged Russian suzerainty and in 1760 a Russian force expelled the Turks. In 1803 the monarch declared himself a vassal of Russia, and in 1810 the little kingdom was definitively annexed to that empire. (See GEORGIA.)

**IMIDAZOLES**, or GLYOXALINES, organic chemical compounds containing the ring system  $\text{HN} < \begin{matrix} \text{CH}=\text{CH} \\ | \\ \text{CH}=\text{N} \end{matrix}$ . Imidazole itself was first prepared by H. Debus (*Ann.* 1858, 107, p. 254) by the action of ammonia on glyoxal,  $2\text{C}_2\text{H}_2\text{O}_2 + 2\text{NH}_3 = \text{C}_3\text{H}_3\text{N}_2 + \text{H}_2\text{CO}_2 + 2\text{H}_2\text{O}$ . The compounds of this series may be prepared by the condensation of ortho-diketones with ammonia and aldehydes

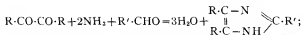

from thioimidazolones by oxidation with dilute nitric acid (W. Marckwald, *Ber.*, 1892, 25, p. 2361); by distillation of hydrobenzamide and similarly constituted bodies; and by the action of phosphorus pentachloride on symmetrical dimethylloxamide, a methylchlorglyoxaline being formed (O. Wallach, *Ann.*, 1877, 184, p. 500).

The glyoxalines are basic in character, and the imide hydrogen is replaceable by metals and alkyl groups. They are stable towards reducing agents, and acylidyl groups are only introduced with difficulty.

*Imidazole* (glyoxaline),  $C_4H_4N_2$ , crystallizes in thick prisms which melt at 88-89° C. and boil at 253° C., and are readily soluble in alcohol and in water. It is unaffacted by chromic acid, but potassium permanganate oxidizes it to formic acid. It forms salts with acids.

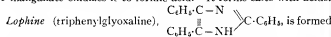

by the dry distillation of hydrobenzamide, or by saturating an alcoholic solution of benzil and benzaldehyde (at a temperature of 40° C.) with ammonia. It crystallizes in needles which melt at 275° C. It is a weak base. When heated to 300° C. with hydriodic acid and hydrochloric acid, in the presence of some red phosphorus, it yields benzoic acid.

The keto-glyoxalines are known as *imidazolones* and are prepared by the action of acids on acetylthioureas (W. Marckwald, *Ber.*, 1892, 25, p. 2357). *Benzimidazole*,  $C_8H_6N_2$ , is the simplest representative of the benzoglyoxalines and is prepared by the condensation of formic acid with ortho-phenylene diamine. It forms rhombic crystals which melt at 170° C. It is basic in character, and on oxidation with potassium permanganate yields a small amount of glyoxaline dicarboxylic acid.

(E. Bamberger, *Ann.*, 1893, 273, p. 338).

**IMITATION** (Lat. *imitatio*, from *imitari*, to imitate), the reproduction or repetition of an action or thought as observed in another person or in oneself, or the construction of one object in the likeness of another. By some writers (e.g. Preyer and Lloyd Morgan) the term "imitation" is limited to cases in which one person copies the action or thought of another; others have preferred a wider use of the term (i.e. including "self-imitation"), and have attempted to classify imitative action into various groupings, e.g. as cases of "conscious imitation," "imitative suggestion," "plastic imitation" (as when the members of a crowd subconsciously reproduce one another's modes of thought and action), and the like. The main distinction is that which takes into account the question of attention (*q.v.*). In *conscious* imitation, the attention is fixed on the act and its reproduction; in *unconscious* imitation the reproduction is entirely mechanical and the agent does not "attend" to the action or thought which he is copying; in *subconscious* imitation the action is not deliberate, though the necessary train of thought would immediately follow if the attention were turned upon it under normal conditions. Imitation plays an extremely important part in human and animal development, and a clear understanding of its character is important both for the study of primitive peoples, and also in the theories of education, art and sociology. The child's early development is in large measure imitative: thus the first articulate sounds and the first movements are mainly reproductions of the words and actions of parents, and even in the later stages that teacher is likely to achieve the best results who himself gives examples of how a word should be pronounced or an action done. The impulse to imitate is, however, not confined to children: there is among the majority of adults a tendency to assimilate themselves either to their society or to those whom they especially admire or respect; this tendency to shun the eccentric is rooted deeply in human psychology. Moreover, even among highly developed persons the imitative impulse frequently overrides the reason, as when an audience, a crowd, or even practically a whole community is carried away by a panic for which no adequate ground has been given, or when a cough or a yawn is imitated by a company of people. Such cases may be compared

with those of persons in mesmeric trances who mechanically copy a series of movements made by the mesmerist. The universality of the imitative impulse has led many psychologists to regard it as an instinct (so William James, *Principles of Psychology*, li. 408; cf. INSTINCT), and in that large class of imitative actions which have no obvious ulterior purpose the impulse certainly appears to be instinctive in character. On the other hand where the imitator recognizes the particular effect of a process and imitates with the deliberate intention of producing the same effect, his action can scarcely be classed as instinctive. A considerable number of psychologists have distinguished imitative from instinctive actions (e.g. Baldwin, and Sully). According to Darwin the imitative impulse begins in infants at the age of four months. It is to be noted, however, that the child imitates, not every action indiscriminately, but especially those towards which it has a congenital tendency. The same is true of animals: though different kinds of animals may live in close proximity, the young of each kind imitate primarily the actions of their own parents.

Among primitive man imitation plays a very important part. The savage believes that he can bring about events by imitating them. He makes, for instance, an image of his enemy and pierces it with darts or burns it, believing that by so doing he will cause his enemy's death: similarly sailors would whistle, or farmers would pour water on the ground, in the hope of producing wind or rain. This form of imitation is known as sympathetic magic (see MAGIC). The sociological importance of imitation is elaborately investigated by Gabriel Tarde (*Les Lois de l'imitation*, 2nd ed., 1895), who bases all social evolution on the imitative impulse. He distinguishes "custom imitations," i.e. imitations of ancient or even forgotten actions, and "mode imitations," i.e. imitations of current fashions. New discoveries are, in his scheme, the product of the conflict of imitations. This theory, though of great value, seems to neglect original natural similarities which, by the law of causation, produce similar consequences, where imitation is geographically or chronologically impossible.

The term "imitation" has also the following special uses:—  
1. *In Art-theory*.—According to Plato all artistic production is a form of imitation (*mimesis*). That which really exists is the idea or type created by God; of this type all concrete objects are representations, while the painter, the tragedian, the musician are merely imitators, thrice removed from the truth (*Rep.* x. 506 seq.). Such persons are represented by Plato as a menace to the moral fibre of the community (*Rep.* iii.), as performing no useful function, drawing men away from reality and pandering to the irrational side of the soul. All art should aim at moral improvement. Plato clearly intends by "imitation" more than is connoted by the modern word: though in general he associates with it all that is bad and second-rate, he in some passages admits the value of the imitation of that which is good, and thus assigns to it a certain symbolic significance. Aristotle, likewise regarding art as imitation, emphasizes its purely artistic value as purging the emotions (*katharsis*), and producing beautiful things as such (see AESTHETICS and FINE ARTS).

2. *In Biology*, the term is sometimes applied to the assimilation by one species of certain external characteristics (especially colour) which enable them to escape the notice of other species which would otherwise prey upon them. It is a form of protective resemblance and is generally known as mimicry (*q.v.*; see also COLOURS OF ANIMALS).

3. *In Music*, the term "imitation" is applied in contrapuntal composition to the repetition of a passage in one or more of the other voices or parts of a composition. When the repetition is note for note with all the intervals the same, the imitation is called "strict" and becomes a canon (*q.v.*); if not it is called "free," the latter being much the more common. There are many varieties of imitation, known as imitation "by inversion," "by inversion and reversion," "by augmentation," "by diminution" (see Grove's *Dictionary of Music*, s. v., and textbooks of musical theory).



**IMITATION OF CHRIST, THE** (*Imitatio Christi*), the title of a famous medieval Christian devotional work, much used still by both Catholics and Protestants and usually ascribed to Thomas à Kempis. The "Contestation" over the author of the *Imitation of Christ* is probably the most considerable and famous controversy that has ever been carried on concerning a purely literary question. It has been going on almost without flagging for three centuries, and nearly 200 combatants have entered the lists. In the present article nothing is said on the history of the controversy, but an attempt is made to summarize the results that may be looked on as definitely acquired.

Until quite recently there were three candidates in the field—Thomas à Kempis (1380-1471), a canon regular of Mount St Agnes in Zwolle, in the diocese of Utrecht, of the Windesheim Congregation of Augustinian Canons; John Gerson (1363-1429), chancellor of the University of Paris; and an abbot, John Gersen, said to have been abbot of a Benedictine monastery at Vercelli in the 12th century. Towards the end of the 15th century the *Imitation* circulated under the names of the first two; but Gerson is an impossible author, and his claims have never found defenders except in France, where they are no longer urged. The Benedictine abbot Gersen is an absolutely mythical personage, a mere "double" of the chancellor. Consequently at the present day the question is narrowed to the issue: Thomas à Kempis, or an unknown author.

The following is a statement of the facts that may be received as certain:—

1. The earliest-known dated MS. of the *Imitation* is of 1424—it contains only Bk. I.; the earliest MSS. of the whole work of certain date are of 1427. Probably some of the undated MSS. are older; but it is the verdict of the most competent modern expert opinion that there is no palaeographical reason for suspecting that any known MS. is earlier than the first quarter of the 15th century.

2. A Latin letter of a Dutch canon regular, named Johann van Schoonhoven, exhibits such a close connexion with Bk. I. that plagiarism on the one side or the other is the only possible explanation. It is capable of demonstration that the author of the *Imitation* was the borrower, and that the opposite hypothesis is inadmissible. Now, this letter can be shown to have been written after 1382. Therefore Bk. I. was beyond controversy written between the years 1382 and 1424.

3. It is not here assumed that the four treatises formed a single work, or even that they are all by the same author; and the date of the other three books cannot be fixed with the same certainty. But, on the one hand, before the beginning of the 15th century there is no trace whatever of their existence—a strong argument that they did not yet exist; and on the other hand, after 1424 nearly each year produces its quota of MSS. and other signs of the existence of these books become frequent. Moreover, as a matter of fact, the four treatises did commonly circulate together. The presumption is strong that Bks. II., III., IV., like Bk. I., were composed shortly before they were put into circulation.

It may then be taken as proved that the *Imitation* was composed between 1380 and 1425, and probably towards the end rather than the beginning of that period. Having ascertained the date, we must consider the birthplace.

4. A number of idioms and turns of expression throughout the book show that its author belonged to some branch of the Teutonic race. Further than this the argument does not lead; for when the dialects of the early 15th century are considered it cannot be said that the expressions in question are Netherlandic rather than German—as a matter of fact, they have all been paralleled out of High German dialects.

5. Of the 400 MSS. of the *Imitation* 340 come from the Teutonic countries—the another argument in favour of its Teutonic origin. Again, 100 of them, including the earliest, come from the Netherlands. This number is quite disproportionate to the relative size of the Netherlands, and so points to Holland as the country in which the *Imitation* was first most widely circulated and presumably composed.

6. There is a considerable body of early evidence, traceable before 1450, that the author was a canon regular.

7. Several of the MSS. were written in houses belonging to the Windesheim Congregation of canons regular, or in close touch with it. Moreover there is a specially intimate literary and spiritual relationship between the *Imitation* and writings that emanated from what has been called the "Windesheim Circle."

To sum up: the indirect evidence points clearly to the conclusion that the *Imitation* was written by a Teutonic canon regular, probably a Dutch canon regular of the Windesheim Congregation, in the first quarter of the 15th century. These data are satisfied by Thomas à Kempis.

We pass to the direct evidence, neglecting that of witnesses who had no special sources of information.

8. There can be no question that in the Windesheim Congregation itself there was already, during Thomas à Kempis's lifetime, a fixed tradition that he was the author of the *Imitation*. The most important witness to this tradition is Johann Busch. It is true that the crucial words are missing in one copy of his "Chronicle"; but it is clear there were two redactions of the work, and there are no grounds whatever for doubting that the second with its various enlargements came from the hands of Busch himself—a copy of it containing the passage exists written in 1464, while both Busch and Thomas à Kempis were still alive. Busch passed a great part of his life in Windesheim, only a few miles from Mount St Agnes where Thomas lived. It would be hard to find a more authentic witness. Another witness is Hermann Rhyd, a German member of the Windesheim Congregation, who also had personally known Thomas. Besides, two or three MSS. originating in the Windesheim Congregation state or imply the same tradition.

9. More than this: the tradition existed in Thomas à Kempis's own monastery shortly after his death. For John Mauburne became a canon in Mount St Agnes within a few years of Thomas's death, and he states more than once that Thomas wrote the *Imitation*.

10. The earliest biographer of Thomas à Kempis was an anonymous contemporary: the *Life* was printed in 1494, but it exists in a MS. of 1488. The biographer says he got his information from the brethren at Mount St Agnes, and he states in passing that Bk. III. was written by Thomas. Moreover, he appends a list of Thomas's writings, 38 in number, and 5-8 are the four books of the *Imitation*.

It is needless to point out that such a list must be of vastly greater authority than those given by St Jerome or Gennadius in their *De Viris Illustribus*, and its rejection must, in consistency, involve methods of criticism that would work havoc in the history of early literature of what king soever. The domestic tradition in the Windesheim Congregation, and in Mount St Agnes itself, has a weight that cannot be legitimately avoided or evaded. Indeed the external authority for Thomas's authorship is stronger than that for the authorship of most really anonymous books—such, that is, as neither themselves claim to be by a given author, nor have been claimed by any one as his own. A large proportion of ancient writings, both ecclesiastical and secular, are unquestionably assigned to writers on far less evidence than that for Thomas's authorship of the *Imitation*.

Internal arguments have been urged against Thomas's authorship. It has been said that his certainly authentic writings are so inferior that the *Imitation* could not have been written by the same author. But only if they were of the most certain and peremptory nature could such internal arguments be allowed to weigh against the clear array of facts that make up the external argument in favour of à Kempis. And it cannot be said that the internal difficulties are such as this. Let it be granted that Thomas was a prolific writer and that his writings vary very much in quality; let it be granted also that the *Imitation* surpasses all the rest, and that some are on a level very far below it; still, when at their best, some of the other works are not unworthy of the author of the *Imitation*.

In conclusion, it is the belief of the present writer that

the "Contestation" is over, and that Thomas à Kempis's claims to the authorship of the *Imitation* have been solidly established.

The best account in English of the Controversy is that given by F. R. Cruise in his *Thomas à Kempis* (1887). Works produced before 1880 are in general, with the exception of those of Eusebius Amort, superannuated, and deal in large measure with points no longer of any living interest. A pamphlet by Cruise, *Who was the author of the Imitation?* (1898) contains sufficient information on the subject for all ordinary needs; it has been translated into French and German, and may be regarded as the standard handbook.

It has been said that the *Imitation of Christ* has had a wider religious influence than any book except the Bible, and if the statement be limited to Christendom, it is probably true. The *Imitation* has been translated into over fifty languages, and is said to have run through more than 6000 editions. The other statement, often made, that it sums up all that is best of earlier Western mysticism—that in it "was gathered and centered all that was elevating, passionate, profoundly pious in all the older mystics" (Milman) is an exaggeration that is but partially true, for it depreciates unduly the elder mystics and fails to do justice to the originality of the *Imitation*. For its spiritual teaching is something quite different from the mysticism of Augustine in the *Confessions*, or of Bernard in the *Sermons on the Song of Songs*; it is different from the scholastic mysticism of the St Victor or Bonaventure; above all, it is different from the obscure mysticism, saturated with the pseudo-Dionysian Neoplatonism of the German school of Eckhart, Suso, Tauler and Ruysbroek. Again, it is quite different from the later school of St Teresa and St John of the Cross, and from the introspective methods of what may be called the modern school of spirituality. The *Imitation* stands apart, unique, as the principal and most representative utterance of a special phase of religious thought—non-scholastic, non-platonic, positive and merely religious in its scope—herein reflecting faithfully the spirit of the movement initiated by Gerhard Groot (*q.v.*), and carried forward by the circles in which Thomas à Kempis lived. In contrast with more mystical writings it is of limpid clearness, every sentence being easily understandable by all whose spiritual sense is in any degree awakened. No doubt it owes its universal power to this simplicity, to its freedom from intellectualism and its direct appeal to the religious sense and to the extraordinary religious genius of its author. Professor Harnack in his book *What is Christianity?* counts the *Imitation* as one of the chief spiritual forces in Catholicism; it "kindles independent religious life, and a fire which burns with a flame of its own" (p. 266).

The best Latin edition of the *Imitation* is that of Hirsche (1874), which follows closely the autograph of 1441 and reproduces the rhetorical character of the book. Of English translations the most interesting is that by John Wesley, under the title *The Christian's Pattern* (1735). (E. C. B.)

**IMMACULATE CONCEPTION, THE.** This dogma of the Roman Catholic Church was defined as "of faith" by Pope Pius IX. on the 8th of December 1854 in the following terms: "The doctrine which holds that the Blessed Virgin Mary, from the first instant of her conception, was, by a most singular grace and privilege of Almighty God, in view of the merits of Jesus Christ, the Redeemer of the human race, preserved from all stain of Original Sin, is a doctrine revealed by God, and therefore to be firmly and steadfastly believed by all the faithful."<sup>1</sup> These words presuppose the distinction between original, or racial, and actual, or personally incurred sin. There is no dispute that the Church has always held the Blessed Virgin to be sinless, in the sense of actual or personal sin. The question of the Immaculate Conception regards original or racial sin only. It is admitted that the doctrine as defined by Pius IX. was not explicitly mooted before the 12th century. But it is claimed that it is implicitly contained in the teaching of the Fathers. Their expressions on the subject of the sinlessness of Mary are, it is pointed out, so ample and so absolute that they must be taken to include original sin as well as actual. Thus we have in the first five centuries such epithets applied to her as "in every respect holy," "in all things unstained," "super-innocent" and "singularly holy"; she is compared to Eve before the fall, as ancestress of a redeemed people; she is "the earth before it was accused."<sup>2</sup> The well-known words of St Augustine (d. 430) may be cited: "As regards the mother of God," he says, "I will not allow any question whatever of sin."<sup>3</sup>

<sup>1</sup> From the Bull *Ineffabilis Deus*.

<sup>2</sup> See Passaglia's work, referred to below.

<sup>3</sup> *De natura et gratia*, cap. xxxvi.

It is true that he is here speaking directly of actual or personal sin. But his argument is that all men are sinners; that they are so through original depravity; that this original depravity may be overcome by the grace of God, and he adds that he does not know but that Mary may have had sufficient grace to overcome sin "of every sort" (*omni ex parte*).

It seems to have been St Bernard who, in the 12th century, explicitly raised the question of the Immaculate Conception. A feast of the Conception of the Blessed Virgin had already begun to be celebrated in some churches of the West. St Bernard blames the canons of the metropolitan church of Lyons for instituting such a festival without the permission of the Holy See. In doing so, he takes occasion to repudiate altogether the view that the Conception of Mary was sinless. It is doubtful, however, whether he was using the term "Conception" in the same sense in which it is used in the definition of Pius IX. In speaking of conception one of three things may be meant: (1) the mother's co-operation; (2) the formation of the body, or (3) the completion of the human being by the infusion of the rational or spiritual soul. In early times conception was very commonly used in the first sense—"active" conception as it was called. But it is in the second, or rather the third, sense that the word is employed in modern usage, and in the definition of Pope Pius IX. But St Bernard would seem to have been speaking of conception in the first sense, for in his argument he says, "How can there be absence of sin where there is concupiscence (*libido*)?" and stronger expressions follow, showing that he is speaking of the mother and not of the child.<sup>4</sup>

St Thomas Aquinas, the greatest of the medieval scholastics, refused to admit the Immaculate Conception, on the ground that, unless the Blessed Virgin had at one time or other been one of the sinful, she could not justly be said to have been redeemed by Christ.<sup>5</sup> St Bonaventura (d. 1274), second only to St Thomas in his influence on the Christian schools of his age, hesitated to accept it for a similar reason.<sup>6</sup> The celebrated John Duns Scotus (d. 1308), a Franciscan like St Bonaventura, argued, on the contrary, that from a rational point of view it was certainly as little derogatory to the merits of Christ to assert that Mary was by him preserved from all taint of sin, as to say that she first contracted it and then was delivered.<sup>7</sup> His arguments, combined with a better acquaintance with the language of the early Fathers, gradually prevailed in the schools of the Western Church. In 1387 the university of Paris strongly condemned the opposite view. In 1483 Pope Sixtus IV., who had already (1476) emphatically approved of the feast of the Conception, condemned those who ventured to assert that the doctrine of the Immaculate Conception was heretical, and forbade either side to claim a decisive victory until further action on the part of the Holy See. The council of Trent, after declaring that in its decrees on the subject of original sin it did not include "the blessed and immaculate Virgin Mary, Mother of God," renewed this prohibition.<sup>8</sup> Pope Paul V. (d. 1621) ordered that no one, under severe penalties, should dare to assent in public "acts" or disputations that the Blessed Virgin was conceived in original sin. Pope Gregory XV., shortly afterwards, extended this prohibition to private discussions, allowing, however, the Dominicans to argue on the subjects among themselves. Clement XI., in 1708, extended the feast of the Conception to the whole Church as a holy day of obligation. Long before the middle of the 19th century the doctrine was universally taught in the Roman Catholic Church. During the reign of Gregory XVI. the bishops in various countries began to press for a definition. Pius IX., at the beginning of his pontificate, and again after 1851, appointed commissions to investigate the whole subject, and he was advised that the doctrine was one

<sup>4</sup> S. Bernardi Epist. clxxv. 7.

<sup>5</sup> *Summa theologia*, part iii., quaest. 27, art. 3.

<sup>6</sup> In *librum III. sententiarum distinct.* 3 quaest. i. n. 2.

<sup>7</sup> In *librum III. sententiarum dist.* 3 quaest. i. n. 4; *Cfr. Distinct.* 18, n. 15. Also the *Summa theologia* of Scotus (compiled by a disciple), part. iii., quaest. 27, art. 2.

<sup>8</sup> *Sess. v. De peccato originale*.

which could be defined and that the time for a definition was opportune. On the 8th of December 1854 in a great assembly of bishops, in the basilica of St Peter's at Rome, he promulgated the Bull *Ineffabilis Deus*, in which the history of the doctrine is summarily traced, and which contains the definition as given above.

The festival of the Conception of the Blessed Virgin, as distinct from her Nativity, was certainly celebrated in the Greek Church in the 7th century, as we learn from one of the canons of St Andrew of Crete (or of Jerusalem) who died about A.D. 700.<sup>1</sup> There is some evidence that it was kept in Spain in the time of St Ildefonsus of Toledo (d. 667) and in southern Italy before A.D. 1000. In England it was known in the 12th century; a council of the province of Canterbury, in 1328, ascribes its introduction to St Anselm. It spread to France and Germany in the same century. It was extended to the whole church, as stated above, in 1708. It is kept, in the Western Church, on the 8th of December; the Greeks have always kept it one day later.

The chief repertoire of Patristic passages, both on the doctrine and on the festival, is Father Charles Pasaglia's great collection, entitled *De immaculato Deiparæ semper Virginis conceptu Caroli Passaglia sac. S.J. commentarius* (3 vols., Romæ, 1854-1855).

A useful statement of the doctrine with numerous references to the Fathers and scholastics is found in Hürter's *Theologia Dogmatica* (5th ed.), tom. i. tract. vii. cap. 6, p. 438.

The state of Catholic belief in the middle of the 19th century is well brought out in *La Croissance générale et constante de l'Eglise touchant l'immaculée conception de la bienheureuse Vierge Marie*, published in 1855 by Thomas M. J. Goussset (1792-1866), professor of moral theology at the grand seminary of Besançon, and successively archbishop of Besançon and cardinal archbishop of Reims.

For English readers the doctrine, and the history of its definition, is clearly stated by Archbishop Ullathorne in *The Immaculate Conception of the Mother of God* (2nd ed., London, 1904). Dr F. G. Lee, in *The Sinless Conception of the Mother of God; a Theological Essay* (London, 1891) argued that the doctrine of the Immaculate Conception is a legitimate development of early church teaching.

(\*J. C. H.)

**IMMANENCE** (from Lat. *in-manere* to dwell in, remain), in philosophy and theology a term applied in contradistinction to "transcendence," to the fact or condition of being entirely within something. Its most important use is for the theological conception of God as existing in and throughout the created world, as opposed, for example, to Deism (*q.v.*), which conceives Him as separate from and above the universe. This conception has been expressed in a great variety of forms (see THEISM, PANTHEISM). It should be observed that the immanence doctrine need not preclude the belief in the transcendence of God: thus God may be regarded as above the world (transcendent) and at the same time as present in and pervading it (immanent). The immanence doctrine has arisen from two main causes, the one metaphysical, the other religious. Metaphysical speculation on the relation of matter and mind has naturally led to a conviction of an underlying unity of all existence, and so to a metaphysical identification of God and the universe: when this identification proceeds to the length of expressing the universe as merely a mode or form of deity the result is pantheism (cf. the Eleatics): when it regards the deity as simply the sum of the forces of nature (cf. John Toland) the result is naturalism. In either case, but especially in the former, it frequently becomes pure mysticism (*q.v.*). Religious thinkers are faced by the problem of the Creator and the created, and the necessity for formulating a close relationship between God and man, the Infinite and Perfect with the finite and imperfect. The conception of God as wholly external to man, a purely mechanical theory of the creation, is throughout Christendom regarded as false to the teaching of the New Testament as also to Christian experience. The contrary view has gained ground in some quarters (cf. the so-called "New Theology" of Rev. R. J. Campbell) so far as to postulate a divine element in human beings, so definitely bridging over the gap between finite and infinite which was to some extent admitted by the bulk of early Christian teachers. In support of such a view are adduced not only the metaphysical difficulty of postulating any relationship between the infinite and the purely finite, but also the ethical

<sup>1</sup> P. G., tom. cxvii. p. 1305.

problems of the nature of human goodness—i.e. how a merely human being could appreciate the nature of or display divine goodness—and the epistemological problem of explaining how finite mind can cognize the infinite. The development of the immanence theory of God has coincided with the deeper recognition of the essentially spiritual nature of deity as contrasted with the older semi-pagan conception found very largely in the Old Testament of God as primarily a mighty ruler, obedience to whom is comparable with that of a subject to an absolute monarch: the idea of the dignity of man in virtue of his immediate relation with God may be traced in great measure to the humanist movement of the 14th and 15th centuries (cf. the Inner Light doctrine of Johann Tauler). In later times the conception of conscience as an inward monitor is symptomatic of the same movement of thought. In pure metaphysics the term "immanence-philosophy" is given to a doctrine held largely by German philosophers (Rehmknecht, Leclair, Schuppe and others) according to which all reality is reduced to elements immanent in consciousness. This doctrine is derived from Berkeley and Hume on the one hand and from Kantianism on the other, and embodies the principle that nothing can exist for the mind save itself. The natural consequence of this theory is that the individual consciousness alone exists (solipsism): this position is, however, open to the obvious criticism that in some cases individual consciousnesses agree in their content. Schuppe, therefore, postulates a general consciousness (*Bewusstsein überhaupt*).

**IMMANUEL BEN SOLOMON** (c. 1265-c. 1330), Hebrew poet, was born in Rome. He was a contemporary and friend of Dante, and his verse shows the influence of the "divine poet." Immanuel's early studies included science, mathematics and philosophy; and his commentaries on Proverbs, Psalms, Job and other Biblical books are good examples of the current symbolical methods which Dante so supremely used. Immanuel's fame chiefly rests on his poems, entitled the collection (in the manner of Harizi, *q.v.*) entitled *Mehabereth*, a series of 27 good-natured satires on Jewish life. Religious and secular topics are indiscriminately interwoven, and severe pietists were offended by Immanuel's erotic style. Most popular is an additional section numbered 28 (often printed by itself) called *Hell and Paradise* (*ha-Tophet ve-ha-Eden*). The poet is conducted by a certain Daniel (doubtfully identified with Dante) through the realms of torture and bliss, and Immanuel's pictures and comments are at once vivid and witty.

See J. Chotzner, *Hebrew Humour* (Lond., 1905), pp. 82-102. (I. A.)

**IMMERMANN, KARL LEBERECHE** (1796-1840), German dramatist and novelist, was born on the 24th of April 1796 at Magdeburg, the son of a government official. In 1813 he went to study law at Halle, where he remained, after the suppression of the university by Napoleon in the same year, until King Frederick William's "Summons to my people" on March 17th. He responded with alacrity, but was prevented by illness from taking part in the earlier campaign; he fought, however, in 1815 at Ligny and Waterloo, and marched into Paris with Blücher. At the conclusion of the war he resumed his studies at Halle, and after being *Referendar* in Magdeburg, was appointed in 1810 *Assessor* at Münster in Westphalia. Here he made the acquaintance of Elise von Litzow, Countess von Ahlefeldt, wife of the leader of the famous "free corps" (see LITZOW). This lady first inspired his pen, and their relationship is reflected in several dramas written about this time. In 1823 Immermann was appointed judge at Magdeburg, and in 1827 was transferred to Düsseldorf as *Landgerichtsrat* or district judge. Thither the countess, whose marriage had in the meantime been dissolved, followed him, and, though refusing his hand, shared his home until his marriage in 1830 with a granddaughter of August Hermann Niemeyer (1754-1828), chancellor and *rector perpetuus* of Halle university. In 1834 Immermann undertook the management of the Düsseldorf theatre, and, although his resources were small, succeeded for two years in raising it to a high level of excellence. The theatre, however, was insufficiently endowed to allow of him carrying on the work, and

in 1836 he returned to his official duties and literary pursuits. He died at Düsseldorf on the 25th of August 1840.

Immerrmann had considerable aptitude for the drama, but it was long before he found a congenial field for his talents. His early plays are imitations, partly of Kotzebue's, partly of the Romantic dramas of Tieck and Müllner, and are now forgotten. In 1826, however, appeared *Cardenio und Celinde*, a love tragedy of more promise; this, as well as the earlier productions, awakened the ill-will of Platen, who made Immerrmann the subject of his wittiest satire, *Der romantische Oedipus*. Between 1827 and 1832 Immerrmann redeemed his good name by a series of historical tragedies, *Das Trauerspiel in Tirol* (1827), *Kaiser Friedrich II.* (1828) and a trilogy from Russian history, *Alexis* (1832). His masterpiece is the poetic mystery, *Merlin* (1831), a noble poem, which, like its model, *Faust*, deals with the deeper problems of modern spiritual life. Immerrmann's important dramatic experiments in Düsseldorf are described in detail in *Düsseldorfer Anfänge* (1840). More significant is his position as a novelist. Here he clearly stands on the boundary line between Romanticism and modern literature; his *Epigonen* (1836) might be described as one of the last Romantic imitations of Goethe's *Wilhelm Meister*, while the satire and realism of his second novel, *Münchhausen* (1838), form a complete break with the older literature. As a prose-writer Immerrmann is perhaps best remembered to-day by the admirable story of village life, *Der Oberhof*, which is embedded in the formless mass of *Münchhausen*. His last work was an unfinished epic, *Tristan und Isolde* (1840).

Immerrmann's *Gesammelte Schriften* were published in 14 vols. in 1835-1843; a new edition, with biography and introduction by R. Boxberger, in 20 vols. (Berlin, 1883); selected works, edited by M. Koch, 14 vols., 1887-1888 and F. Müncker (6 vols., 1897). See G. zu Putlitz, *Karl Immerrmann, sein Leben und seine Werke* (2 vols., 1870); F. Freiligrath, *Karl Immerrmann, Blätter der Erinnerung an ihn* (1842); W. Müller, *K. Immerrmann und sein Kreis* (1860); R. Fellner, *Geschichte einer deutschen Musterbühne* (1888); K. Immerrmann: *eine Gedächtnisschrift* (1896).

**IMMERSION** (Lat. *immersio*, dipping), the act of being plunged into a fluid, or being overwhelmed by anything; in astronomy, the disappearance of a heavenly body in the shadow of another, especially of a satellite in the shadow of its primary.

**IMMIGRATION** (from Lat. *in*, into, and *migrare*, to depart), the movement of population, other than that of casual visitors or travellers, *into* one country *from* another (see MIGRATION).

**IMMORTALITY** (Lat. *in-*, not, *mortalis*, mortal, from *mors*, death), the condition or quality of being exempt from death or annihilation. This condition has been predicated of man, both body and soul, in many senses; and the term is used by analogy of those whose deeds or writings have made a lasting impression on the memory of man. The belief in human immortality in some form is almost universal; even in early animistic cults the germ of the idea is present, and in all the higher religions it is an important feature. This article is confined to summarizing the philosophical or scientific arguments for, and objections to, the doctrine of the persistence of the human soul after death. For the Christian doctrine, see ESCHATOLOGY; and for other religions see the separate articles.

In the Orphic mysteries "the soul was regarded as a part of the divine, a *particula aurae divinae*, for which the body in its limited and perishable condition was no fit organ, but a grave or prison (*τὸ σῶμα σῆμα*). The existence of the soul in the body was its punishment for sins in a previous condition; and the doom of its sins in the body was its descent into other bodies, and the postponement of its deliverance" (Salmond's *Christian Doctrine of Immortality*, p. 109). This deliverance was what the mysteries promised. A remarkable passage in Pindar (*Thren.* 2) is thus rendered by J. W. Donaldson (*Pindar's Epinician or Triumphal Odes*, p. 372). "By a happy lot, all persons travel to an end free of toil. And the body, indeed, is subject to the powerful influence of death; but a shadow of vitality is still left alive, and this alone is of divine origin; while

our limbs are in activity it sleeps; but, when we sleep, it discloses to the mind in many dreams the future judgment with regard to happiness and misery."

The belief of Socrates is uncertain. In the *Apology* he is represented as sure that "no evil can happen to a good man, either in life or after death," but as not knowing whether "death be a state of nothingness and utter unconsciousness, or a change or migration of the soul from this world to the next" (i. 40, 41). In the *Phaedo* a confident expectation is ascribed to him. He is not the body to be buried; he will not remain with his friends after he has drunk the poison, but he will go away to the happiness of the blessed. The silence of the *Memorabilia* of Xenophon must be admitted as an argument to the contrary; but the probability seems to be that Plato did not in the *Phaedo* altogether misrepresent the Master. In Plato's thought the belief held a prominent position. "It is noteworthy," says Professor D. G. Ritchie, "that, in the various dialogues in which Plato speaks of immortality, the arguments seem to be of different kinds, and most of them quite unconnected with one another. In the *Phaedrus* (245 C) the argument is, that the soul is self-moving, and, therefore, immortal; and this argument is repeated in the *Laws* (x. 894, 895). It is an argument that Plato probably inherited from Alcmaeon, the physician of Croton (Arist. *De An.* i. 2, § 17 405 A 29), whose views were closely connected with those of the Pythagoreans. In the *Phaedo* the main argument up to which all the others lead is that the soul participates in the idea of life. Recollection (*anamnesis*) alone would prove pre-existence, but not existence after death. In the tenth book of the *Republic* we find the curious argument that the soul does not perish like the body, because its characteristic evil, sin or wickedness does not kill it as the diseases of the body wear out the bodily life. In the *Timaeus* (41 A) the immortality even of the gods is made dependent on the will of the Supreme Creator; souls are not in their own nature indestructible, but persist because of His goodness. In the *Loves* (xii. 959 A) the notion of a future life seems to be treated as a salutary doctrine which is to be believed because the legislator enacts it (Plato, p. 146). The estimate to be formed of this reasoning has been well stated by Dr A. M. Fairbairn, "Plato's arguments for immortality, isolated, modernized, may be feeble, even valueless, but allowed to stand where and as he himself puts them, they have an altogether different worth. The ratiocinative parts of the *Phaedo* thrown into syllogisms may be easily demolished by a hostile logician; but in the dialogue as a whole there is a subtle spirit and cumulative force which logic can neither seize nor answer" (*Studies in the Philosophy of Religion*, p. 226, 1876).

Aristotle held that the *voûs* or active intelligence alone is immortal. The Stoics were not agreed upon the question. Cleanthes is said to have held that all survive to the great conflagration which closes the cycle, Chrysippus that only the wise will. Marcus Aurelius teaches that even if the spirit survive for a time it is at last "absorbed in the generative principle of the universe." Epicureanism thought that "the wise man fears not death, before which most men tremble; for, if we are, it is not; if it is, we are not." Death is extinction. Augustine adopts a Platonic thought when he teaches that the immortality of the soul follows from its participation in the eternal truths. The Apologists themselves welcomed, and commended to others, the Christian revelation as affording a certainty of immortality such as reason could not give. The Aristotelian school in Islam did not speak with one voice upon the question; Avicenna declared the soul immortal, but Averroes assumes only the eternity of the universal intellect. Albertus Magnus argued that the soul is immortal, as *ex se ipsâ causa*, and as independent of the body; Pietro Pomponazzi maintained that the soul's immortality could be neither proved nor disproved by any natural reasons. Spinoza, while consistently with his pantheism denying personal immortality, affirms that "the human mind cannot be absolutely destroyed with the body, but there remains of it something which is eternal" (*Eth.* v. prop. xxiii.). The reason he gives is that, as this something "appertains to the

essence of the mind," it is "conceived by a certain eternal necessity through the very essence of God."

Leibnitz, in accord with the distinctive principle of his philosophy, affirmed the absolute independence of mind and body as distinct monads, the parallelism of their functions in life being due to the pre-established harmony. For the soul, by its nature as a single monad indestructible and, therefore, immortal, death meant only the loss of the monads constituting the body and its return to the pre-existent state. The argument of Ernst Platner (*Philos. Aphor.* i. 1174, 1178) is similar. "If the human soul is a force in the narrower sense, a substance, and not a combination of substances, then, as in the nature of things there is no transition from existence to non-existence, we cannot naturally conceive the end of its existence, any more than we can anticipate a gradual annihilation of its existence." He adds a reason that recalls one of Plato's, "As manifestly as the human soul is by means of the senses linked to the present life, so manifestly it attaches itself by reason, and the conceptions, conclusions, anticipations and efforts to which reason leads it, to God and eternity."

Against the first kind of argument, as formulated by Moses Mendelssohn, Kant advances the objection that, although we may deny the soul extensive quantity, division into parts, yet we cannot refuse to it intensive quantity, degrees of reality; and consequently its existence may be terminated not by decomposition, but by gradual diminution of its powers (or to use the term he coined for the purpose, by *elanguescence*). This denial of any reasonable ground for belief in immortality in the *Critique of Pure Reason (Transcendental Dialectic, bk. ii. ch. i.)* is, however, not his last word on the subject. In the *Critique of the Practical Reason (Dialectic, ch. i. sec. iv)* the immortality of the soul is shown to be a postulate. *Holiness*, "the perfect accordance of the will with the moral law," demands an *endless progress*; and "this endless progress is only possible on the supposition of an *endless duration of the existence and personality of the same rational being (which is called the immortality of the soul)*." Not demonstrable as a theoretical proposition, the immortality of the soul "is an inseparable result of an unconditional a priori practical law." The moral interest, which is so decisive on this question in the case of Kant, dominates Bishop Butler also. A future life for him is important, because our happiness in it may depend on our present conduct; and therefore our action here should take into account the reward or punishment that it may bring on us hereafter. As he maintains that probability may and ought to be our guide in life, he is content with proving in the first chapter of the *Analogy* that "a future life is probable from similar changes (as death) already undergone in ourselves and in others, and from our present powers, which are likely to *continue* unless death destroy them." While we may fear this, "there is no proof that it will, either from the nature of death," of the effect of which on our powers we are altogether ignorant, "or from the analogy of nature, which shows only that the *sensible proof* of our powers (not the powers themselves) may be destroyed." The imagination that death will destroy these powers is unfounded, because (1) "this supposes we are compounded, and so discernible, but the contrary is probable" on *metaphysical grounds* (the indivisibility of the subject in which consciousness as indivisible inheres, and its distinction from the body) and also *experimental* (the persistence of the living being in spite of changes in the body or even losses of parts of the body); (2) this also assumes that "our present living powers of reflection" must be affected in the same way by death "as those of sensation," but this is disproved by their relative independence even in this life; (3) "even the suspension of our present powers of reflection" is not involved in "the idea of death, which is simply dissolution of the body," and which may even "be like birth, a continuation and perfecting of our powers." "Even if suspension were involved, we cannot infer destruction from it" (analysis of chapter i. in Angus's edition). He recognizes that "reason did, as it well might, conclude that it should finally, and upon the whole, be well with the righteous and ill with the wicked," but only "revelation teaches us that

the next state of things after the present is appointed for the execution of this justice" (ch. ii. note 10). He does not use this general anticipation of future judgment, as he might have done, as a positive argument for immortality.

Adam Ferguson (*Institutes of Moral Philosophy*, p. 119, new ed., 1800) argues that "the desire for immortality is an instinct, and can reasonably be regarded as an indication of that which the author of this desire wills to do." From the standpoint of modern science John Fiske confirms the validity of such an argument; for what he affirms in regard to belief in the divine is equally applicable to this belief in a future life. "If the relation thus established in the morning twilight of man's existence between the human soul and a world invisible and immaterial is a relation of which only the subjective term is real and the objective term is non-existent; then I say it is something utterly without precedent in the whole history of creation" (*Through Nature to God*, 1899, p. 188, 189). Whatever may have been Hegel's own belief in regard to personal immortality, the logical issue of his absolute idealism has been well stated by W. Windelband (*History of Philosophy*, p. 633). "It became clear that in the system of perpetual Becoming and of the dialectical passing over of all forms into one another, the finite personality could scarcely raise a plausible claim to the character of a substance and to immortality in the religious sense." F. D. Schleiermacher applies the phrase "the immortality of religion" to the religious emotion of oneness, amid finitude, with the infinite and, amid time, with the eternal; denies any necessary connexion between the belief in the continuance of personal existence and the consciousness of God; and rests his faith on immortality altogether on Christ's promise of living fellowship with His followers, as presupposing their as well as His personal immortality. A. Schopenhauer assigns immortality to the universal will to live; and Feuerbach declares spirit, consciousness eternal, but not any individual subject. R. H. Lotze for the decision of the question lays down the broad principle, "All that has once come to be will eternally continue so soon as for the organic unity of the world it has an unchangeable value, but it will obviously again cease to be, when that is not the case" (*Gr. der Psy.* p. 74).

Objections to the belief in immortality have been advanced from the standpoints of materialism, naturalism, pessimism and pantheism. *Materialism* argues that, as life depends on a material organism, thought is a function of the brain, and the soul is but the sum of mental states, to which, according to the theory of psychophysical parallelism, physical changes always correspond; therefore, the dissolution of the body carries with it necessarily the cessation of consciousness. That, as now constituted, mind does depend on brain, life on body, must be conceded, but that this dependence is so absolute that the function must cease with the organ has not been scientifically demonstrated; the connexion of the soul with the body is as yet too obscure to justify any such dogmatism. But against this inference the following considerations may be advanced: (1) Man does distinguish himself from his body; (2) he is conscious of his personal identity through all the changes of his body; (3) in the exercise of his will he knows himself not controlled by but controlling his body; (4) his consciousness warrants his denying the absolute identification of himself and his body. It may further be added that materialism can be shown to be an inadequate philosophy in its attempts to account even for the physical universe, for this is inexplicable without the assumption of mind distinct from, and directive of, matter. The theory of psychophysical parallelism has been subjected to a rigorous examination in James Ward's *Naturalism and Agnosticism*, part iii., in which the argument that mind cannot be derived from matter is convincingly presented. Sir Oliver Lodge in his reply to E. Haeckel's *Riddle of the Universe* maintains that "life may be something not only ultra-terrestrial, but even immaterial, something outside our present categories of matter and energy; as real as they are, but different, and utilizing them for its own purpose" (*Life and Matter*, 1906, p. 198). He rejects the attempt to explain human personality as "generated by

the material molecular aggregate of its own unaided latent power," and affirms that the "universe where the human spirit is more at home than it is among these temporary collocations of matter" is "a universe capable of infinite development, of noble contemplation, and of lofty joy, long after this planet—nay the whole solar system—shall have fulfilled its present spirit of destiny, and retired cold and lifeless upon its endless way" (pp. 109-200).

In his lecture on *Human Immortality* (3rd ed., 1906), Professor William James deals with "two supposed objections to the doctrine." The first is "the law that thought is a function of the brain." Accepting the law he distinguishes *productive* from *permissive* or *transmissive* function (p. 32), and, rejecting the view that brain products thought, he recognizes that in our present condition brain transmits thought, thought needs brain for its organ of expression; but this does not exclude the possibility of a condition in which thought will be no longer so dependent on brain. He quotes (p. 57) with approval Kant's words, "The death of the body may indeed be the end of the sensational use of our mind, but only the beginning of the intellectual use. The body would thus be not the cause of our thinking, but merely a condition restrictive thereof, and, although essential to our sensuous and animal consciousness, it may be regarded as an impediment of our pure spiritual life" (*Kritik der reinen Vernunft*, 2nd ed., p. 809).

Further arguments in the same direction are derived from the modern school of psychical research (see especially F. W. H. Myers' *Human Personality*, 1903).

Another objection is advanced from the standpoint of *naturalism*, which, whether it issues in materialism or not, seeks to explain man as but a product of the process of nature. The universe is so immeasurably vast in extension and duration, and man is so small, his home but a speck in space, and his history a span in time that it seems an arrogant assumption for him to claim exemption from the universal law of evolution and dissolution. This view ignores that man has ideals of absolute value, truth, beauty, goodness, that he consciously communes with the God who is in all, and through all, and over all, that it is his mind which recognizes the vastness of the universe and thinks its universal law, and that the mind which perceives and conceives cannot be less, but must be greater than the object of its knowledge and thought.

*Pessimism* suggests a third objection. The present life is so little worth living that its continuance is not to be desired. James Thomson ("B.V.") speaks "of the restful rapture of the inviolate grave," and sings the praises of *death* and of *oblivion*. We cannot admit that the history of mankind justifies his conclusion; for the great majority of men life is a good, and its continuance an object of hope.

For pantheism personal immortality appears a lesser good than reabsorption in the universal life; but against this objection we may confidently maintain that worthier of God and more blessed for man is the hope of a conscious communion in an eternal life of the Father of all with His whole family.

Lastly positivism teaches a corporate instead of an individual immortality; man should desire to live on as a beneficent influence in the race. This conception is expressed in George Eliot's lines:

"O, may I join the choir invisible  
Of those immortal dead who live again  
In minds made better by their presence: live  
In pulses stirred to generosity,  
In deeds of daring rectitude, in scorn  
For miserable aims that end with self,  
In thoughts sublime that pierce the night like stars,  
And with their mild persistence urge man's search  
To vaster issues."

But these possibilities are not mutually exclusive alternatives. A man may live on in the world by his teaching and example as a power for good, a factor of human progress, and he may also be continuing and completing his course under conditions still more favourable to all most worthy in him. Consciously to participate as a person in the progress of the race is surely a worthier hope than unconsciously to contribute to it as an

influence; ultimately to share the triumph as well as the struggle is a more inspiring anticipation.

In stating constructively the doctrine of immortality we must assign altogether secondary importance to the metaphysical arguments from the nature of the soul. It is sufficient to show, as has already been done, that the soul is not so absolutely dependent on the body, that the dissolution of the one must necessarily involve the cessation of the other. Such arguments as the indivisibility of the soul and its persistence can at most indicate the *possibility* of immortality.

The *juridical argument* has some force; the present life does not show that harmony of condition and character which our sense of justice leads us to expect; the wicked prosper and the righteous suffer; there is ground for the expectation that in the future life the anomalies of this life will be corrected. Although this argument has the support of such great names as Butler and Kant, yet it will repel many minds as an appeal to the motive of self-interest.

The *ethical argument* has greater value. Man's life here is incomplete, and the more lofty his aims, the more worthy his labours, the more incomplete will it appear to be. The man who lives for fame, wealth, power, may be satisfied in this life; but he who lives for the ideals of truth, beauty, goodness, lives not for time but for eternity, for his ideals cannot be realized, and so his life fulfilled on this side of the grave. Unless these ideals are mocking visions, man has a right to expect the continuance of his life for its completion. This is the line of argument developed by Professor Hugo Münsterberg in his lecture on *The Eternal Life* (1905), although he states it in the terms peculiar to his psychology, in which personality is conceived as primarily will. "No endless duration is our goal, but complete repose in the perfect satisfaction which the will finds when it has reached the significance, the influence, and the value at which it is aiming" (p. 83).

More general in its appeal still is the argument from the *affections*, which has been beautifully developed in Tennyson's *In Memoriam*. The heart protests against the severance of death, and claims the continuance of love's communion after death; and as man feels that love is what is most godlike in his nature, love's claim has supreme authority.

There is a *religious argument* for immortality. The saints of the Hebrew nation were sure that as God had entered into fellowship with them, death could not sever them from his presence. This is the argument in Psalms xvi. and xvii., if, as is probable, the closing verses do express the hope of a glorious and blessed immortality. This too is the proof Jesus himself offers when he declares God to be the God of the living and not of the dead (Matt. xxii. 32). God's companions cannot become death's victims.

Josiah Royce in his lecture on *The Conception of Immortality* (1900) combines this argument of the soul's union with God with the argument of the incompleteness of man's life here:—

"Just because God is One, all our lives have various and unique places in the harmony of the divine life. And just because God attains and wins and finds this uniqueness, all our lives win in our union with Him the individuality which is essential to their true meaning. And just because individuals whose lives have uniqueness of meaning are here only objects of pursuit, the attainment of this very individuality, since it is indeed real, occurs not in our present form of consciousness, but in a life that now we see not, yet in a world whose genuine meaning is continuous with our own human life, however far from our present flickering form of disappointed human consciousness that life of the final individuality may be. Of this our true individual life, our present life is a glimpse, a fragment; a hint, and in its best moments a visible beginning. That this individual life of all of us is not something limited in its temporal expression to the life that now we experience, follows from the very fact that here nothing final or individual is found expressed" (pp. 144-146).

R. W. Emerson declares that "the impulse to seek proof of immortality is itself the strongest proof of all." We expect immortality not merely because we desire it; but because the desire itself arises from all that is best and truest and worthiest in ourselves. The desire is reasonable, moral, social, religious; it has the same worth as the loftiest ideals, and worthiest aspirations

of the soul of man. The loss of the belief casts a dark shadow over the present life. "No sooner do we try to get rid of the idea of Immortality—than Pessimism raises its head... Human griefs seem little worth assuaging; human happiness too paltry (at the best) to be worth increasing. The whole moral world is reduced to a point. Good and evil, right and wrong, become infinitesimal, ephemeral matters. The affections die away—die of their own conscious feebleness and uselessness. A moral paralysis creeps over us" (*Natural Religion*, Post-script). The belief exercises a potent moral influence. "The day," says Ernest Renan, "in which the belief in an after-life shall vanish from the earth will witness a terrific moral and spiritual decadence. Some of us perhaps might do without it, provided only that others held it fast. But there is no lever capable of raising an entire people if once they have lost their faith in the immortality of the soul" (quoted by A. W. Momerie, *Immortality*, p. 9). To this belief, many and good as are the arguments which can be advanced for it, a confident certainty is given by Christian faith in the Risen Lord, and the life and immortality which he has brought to light in his Gospel.

In addition to the works referred to above, see R. K. Gaye, *The Platonic Conception of Immortality and its Connexion with the Theory of Ideas* (1904); R. H. Charles, *A Critical History of the Doctrine of a Future Life in Israel, in Judaism and in Christianity* (1896); E. Pétau, *The Problem of Immortality* (Eng. trans. by F. A. Freer, 1892); J. Fiske, *The Destiny of Man, viewed in the Light of his Origin* (1884); G. A. Gordon, *Immortality and the New Theology* (1897); Henry Buckle, *The After Life* (1907). (A. E. G.\*)

**IMMUNITY** (from Lat. *immunis*, not subject to a *munus* or public service), a general term for exemption from liability, principally used in the legal sense discussed below, but also in recent times in pathology (for which see BACTERIOLOGY). In international law the term ("not serving," "not subject") implies exemption from the jurisdiction of the state which otherwise exercises jurisdiction where the immunity arises. It is thus applied to the exceptional position granted to sovereigns and chiefs of states generally, and their direct representatives in the states to which they are accredited.

Under EXTERIORITY is treated the inviolability of embassies and legations and the application of the material side of the doctrine of immunity. As a right appertaining to the persons of those who enjoy it, the doctrine has grown out of the necessity for sovereigns of respecting each other's persons in their common interest. To be able to negotiate without danger of arrest or interference of any kind with their persons was the only condition upon which sovereigns would have been able to meet and discuss their joint interests. With the development of states as independent entities and of intercourse between them and their "nationals," the work of diplomatic missions increased to such an extent that instead of having merely occasional ambassadors as at the beginning, states found it expedient to have resident representatives with a permanent residence. Hence the sovereign's inviolability becomes vested in the person of the sovereign's delegate, and with it as a necessary corollary the exteriority of his residence. Out of the further expansion of the work of diplomatic missions came duplication of the *personnel* and classes of diplomatic secretaries, who as forming part of the embassy or legation also had to be covered by the diplomatic immunity.

In no branch of international intercourse have states shown so laudable a respect for tradition as in the case of this immunity, and this in spite of the hardship which frequently arises for private citizens through unavoidable dealings with members of embassies and legations. The Institute of International Law (see PEACE) at their Cambridge session in 1895 drew up the following rules,<sup>1</sup> which may be taken to be the only precise statement of theory on the subject, for the guidance of foreign offices in dealing with it:—

ART. 1.—Public ministers are inviolable. They also enjoy "exteriority," in the sense and to the extent hereinafter mentioned and a certain number of immunities.

ART. 2.—The privilege of inviolability extends: (r) To all classes

of public ministers who regularly represent their sovereign or their country; (2) To all persons forming part of the official staff of a diplomatic mission; (3) To all persons forming part of its non-official staff, under reserve, that if they belong to the country where the mission resides they only enjoy it within the official residence.

ART. 3.—The government to which the minister is accredited must abstain from all offence, insult or violence against the persons entitled to the privilege, must set an example in the respect which is due to them, and must protect them by specially rigorous penalties from all offence, insult or violence on the part of the inhabitants of the country, so that they may devote themselves to their duties in perfect freedom.

ART. 4.—Immunity applies to everything necessary for the fulfilment by ministers of their duties, especially to personal effects, papers, archives and correspondence.

ART. 5.—It lasts during the whole time which the minister or diplomatic official spends, in his official capacity, in the country to which he has been sent.

It continues even at a time of war between the two powers during the period necessary to enable the minister to leave the country with his staff and effects.

ART. 6.—Inviolability cannot be claimed: (1) In case of legitimate defence on the part of private persons against acts committed by the persons who enjoy the privilege; (2) In case of risks incurred by any of the persons in question voluntarily or needlessly; (3) In case of improper acts committed by them, provoking on the part of the state to which the minister is accredited measures of defence or precaution; but, except in a case of extreme urgency, this state should confine itself to reporting the facts to the minister's government, requesting the punishment or the recall of the guilty agent and, if necessary, to surrounding the official residence to prevent unlawful communications or manifestations.

*Immunity with Respect to Taxes.*

ART. 11.—A public minister in a foreign country, functionaries officially attached to his mission and the members of their families residing with them, are exempt from paying: (1) Personal direct taxes and sumptuary taxes; (2) General taxes on property, whether on capital or income; (3) War contributions; (4) Customs duties in respect of articles for their personal use.

Each government shall indicate the grounds (*justifications*) to which these exemptions from taxation shall be subordinated.

*Immunity from Jurisdiction.*

ART. 12.—A public minister in a foreign country, functionaries officially attached to his mission and the members of their families residing with them, are exempt from all jurisdiction, civil or criminal, of the state to which they are accredited; in principle, they are only subject to the civil and criminal jurisdiction of their own country. A claimant may apply to the courts of the capital of the country of the minister, subject to the right of the minister to prove that he has a different domicile in his country.

ART. 13.—With respect to crimes, persons indicated in the preceding article remain subject to the penal law of their own country, as if they had committed the acts in their own country.

ART. 14.—The immunity attaches to the function in respect of acts connected with the function. As regards acts done not in connexion with the function, immunity can only be claimed so long as the function lasts.

ART. 15.—Persons of the nationality of the country to the government of which they are accredited cannot claim the privilege of immunity.

ART. 16.—Immunity from jurisdiction cannot be invoked: (1) In case of proceedings taken by reason of engagements entered into by the exempt person, before a territorial court of his own country, but in the exercise of a profession carried on by him in the country concurrently with his diplomatic functions; (2) In respect of real actions, including possessory actions, relating to anything movable or immovable in the country.

It exists even in case of a breach of the law which may endanger public order or safety, or of crime against the safety of the state, without prejudice to such steps as the territorial government may take for its own protection.

ART. 17.—Persons entitled to immunity from jurisdiction may refuse to appear as witness, before a territorial court, on condition that, if required by diplomatic intervention, they shall give their testimony in the official residence to a magistrate of the country appointed for the purpose.

Further questions connected with Immunity and Exteriority (*q.v.*) arise out of the different industrial enterprises undertaken by states, such as posts, telegraphs, telephones, railways, steamships, &c., which require regulation to prevent conflicts of interest between the state owners and the private interests involved in these enterprises. (T. BA.)

**IMOLA** (anc. *Forum Cornelii*), a town and episcopal see of Emilia, Italy, in the province of Bologna, from which it is 21 m. S.E. by rail, 140 ft. above sea-level. Pop. (1001) 12,058 (town); 33,144 (commune). The cathedral of S. Cassiano has been

<sup>1</sup> The rules were drawn up in French. The author of this article is responsible for the translation of them.

modernized; it possesses interesting reliquaries, and contains the tomb of Petrus Chrysologus, archbishop of Ravenna (d. 451), a native of Imola. S. Domenico has a fine Gothic portal and S. Maria in Regola an old campanile. The town also contains some fine palaces. The communal library has some MSS., including a psalter with miniatures, that once belonged to Sir Thomas More. The citadel is square with round towers at the angles; it dates from 1304, and is now used as a prison. Imola has a large lunatic asylum with over 1200 inmates. Innocenzo Francucci (Innocenzo da Imola), a painter of the Bolognese school (1494-1540), was a native of Imola, and two of his works are preserved in the Palazzo del Comune. The Madonna del Piratello, 2 m. outside the town to the N.W., is in the early Renaissance style (1488); the campanile was probably built from Bramante's plans in 1506.

The ancient Forum Cornelli, a station on the Via Aemilia, is said by Prudentius, writing in the 5th century A.D., to have been founded by Sulla; but the fact that it belonged to the *Tribus Pollia* shows that it already possessed Roman citizenship before the Social war. In later times we hear little of it; Martial published his third book of epigrams while he was there. In the Lombard period the name Imola begins to appear. In 1480, after a queried history, the town came into the possession of Girolamo Riario, lord of Forlì, as the dowry of his wife Caterina Sforza, and was incorporated with the States of the Church by Caesar Borgia in 1500.

**IMP** (O. Eng. *impa*, a graft, shoot; the verb *impian* is cognate with Ger. *impfen*, to graft, inoculate, and the Fr. *enter*; the ultimate origin is probably the Gr. *ἐμβένειν*, to implant, cf. *ἐμψύρος*, engrafted), originally a slip or shoot of a plant or tree used for grafting. This use is seen in Chaucer (*Prologue to the Monk's Tale*, 68) "Of fieble trees ther comen wretched ympe." The verb "to imp" in the sense of "to graft" was especially used of the grafting of feathers on to the wing of a falcon or hawk to replace broken or damaged plumage, and is frequently used metaphorically. Like "scion," "imp" was till the 17th century used of a member of a family, especially of high rank, hence often used as equivalent to "child." The *New English Dictionary* quotes an epitaph (1584) in the Beauchamp chapel at Warwick, "Heere resteth the body of the noble Impe Robert of Dudley . . . sonne of Robert Erle of Lyncester." The current use of the word for a small devil or mischievous sprite is due to the expressions "imp of Satan, or of the devil or of hell," in the sense of "child of evil." It was thus particularly applied to the demons supposed to be the "familiar" spirits of witches.

**IMPATIENS**, in botany, a genus of annual or biennial herbs, sometimes becoming shrubby, chiefly natives of the mountains of tropical Asia and Africa, but also found widely distributed in the north temperate zone and in South Africa. The flowers, which are purple, yellow, pink or white and often showy, are spurred and irregular in form and borne in the leaf-axils. The name is derived from the fact that the seed-pod when ripe discharges the seeds by the elastic separation and coiling of the valves. *Impatiens Noli-me-tangere*, touch-me-not, an annual succulent herb with yellow flowers, is probably wild in moist mountainous districts in north Wales, Lancashire and Westmorland. *I. Roylei*, a tall hardy succulent annual with rose-purple flowers, a Himalayan species, is common in England as a self-sown garden plant or garden escape. *I. Balsamina*, the common balsam of gardens, a well-known annual, is a native of India; it is one of the showiest of summer and autumn flowers and of comparatively easy cultivation. *I. Sultanii*, a handsome plant, with scarlet flowers, a native of Zanibar, is easily grown in a greenhouse throughout the summer, but requires warmth in winter.

**IMPEACHMENT** (O. Fr. *empechement*, *empechement*, from *empescher* or *empescher*, to hinder, Late Lat. *impedicare*, to entangle, *pedica*, letter, *pes*, foot), the English form of judicial parliamentary procedure against criminals, in which the House of Commons are the prosecutors and the House of Lords the judges. It differs from bills of attainder (*q.v.*) in being strictly judicial. When the House of Commons has accepted a motion for impeach-

ment, the mover is ordered to proceed to the bar of the House of Lords, and there impeach the accused "in the name of the House of Commons, and of all the Commons of the United Kingdom." The charges are formulated in articles, to each of which the accused may deliver a written answer. The prosecution must confine itself to the charges contained in the articles, though further articles may be admitted from time to time. The Commons appoint managers to conduct the prosecution, but the whole House in committee attends the trial. The defendant may appear by counsel. The president of the House of Lords is the lord high steward, in the case of peers impeached for high treason; in other cases the lord chancellor. The hearing takes place as in an ordinary trial, the defence being allowed to call witnesses if necessary, and the prosecution having a right of reply. At the end of the case the president "puts to each peer, beginning with the junior baron, the questions upon the first article, whether the accused be guilty of the crimes charged therein. Each peer in succession rises in his place when the question is put, and standing uncovered, and laying his right hand upon his breast, answers, 'Guilty' or 'Not guilty,' as the case may be, 'upon my honour.' Each article is proceeded with separately in the same manner, the lord high steward giving his own opinion the last" (*May's Parliamentary Practice*, c. xxiii.). Should the accused be found guilty, judgment follows if the Commons move for it, but not otherwise. The Commons thus retain the power of pardon in their own hands, and this right they have in several cases expressly claimed by resolution, declaring that it is not parliamentary for their lordships to give judgment "until the same be first demanded by this House." Spiritual peers occupy an anomalous position in the trial of peers, as not being themselves ennobled in blood; on the impeachment of Danby it was declared by the Lords that Spiritual peers have the right to stay and sit during proceedings for impeachment, but it is customary for them to withdraw before judgment is given, entering a protest "saving to themselves and their successors all such rights in judicature as they have by law, and by right ought to have." An impeachment, unlike other parliamentary proceedings, is not interrupted by prorogation, nor even by dissolution. Proceedings in the House of Commons preliminary to an impeachment are subject to the ordinary rules, and in the Warren Hastings case an act was passed to prevent the preliminary proceedings from discontinuance by prorogation and dissolution. A royal pardon cannot be pleaded in bar of an impeachment, though it is within the royal prerogative to pardon after the lords have pronounced judgment. The point was raised in the case of the earl of Danby in 1670, and the rule was finally settled by the Act of Settlement. Persons found guilty on impeachment may be revived or pardoned like other convicts. Impeachment will lie against all kinds of crimes and misdemeanours, and against offenders of all ranks. In the case of Simon de Beresford, tried before the House of Lords in 1330, the House declared "that the judgment be not drawn into example or consequence in time to come, whereby the said peers may be charged hereafter to judge others than their peers," from which Blackstone and others have inferred that "a commoner cannot be impeached before the Lords for any capital offence, but only for high misdemeanours." In the case of Edward Fitzharris in 1681, the House of Commons in answer to a resolution of the Lords suspending the impeachment, declared it to be their undoubted right "to impeach any peer or commoner for treason or any other crime or misdemeanour." And the House of Lords has in practice recognized the right of the Commons to impeach whomsoever they will. The procedure has, however, been reserved for great political offenders whom the ordinary powers of the law might fail to reach. It has now fallen into desuetude. The last impeachments were those of Warren Hastings (1788-1795) and Lord Melville (1806), but an unsuccessful attempt was made by Thomas C. Anstey to impeach Lord Palmerston in 1848. The earliest recorded instances of impeachment are those of Lord Latimer in 1376 and of Pole, earl of Suffolk, in 1386. From the time of Edward IV. to Elizabeth it fell into disuse, "partly," says Hallam, "from the loss



of that control which the Commons had obtained under Richard II. and the Lancastrian kings, and partly from the preference the Tudor princes had given to bills of attainder or pains and penalties when they wished to turn the arm of parliament against an obnoxious subject." Revived in the reign of James I., it became an instrument of parliamentary resistance to the crown, and it was not infrequently resorted to in the first three reigns after the Revolution.

In the United States the procedure of impeachment both in the national and in almost all of the state governments is very similar to that described above. The national constitution prescribes that the House of Representatives "shall have the sole power of impeachment" and that "the Senate shall have the sole power to try all impeachments." The House appoints managers to conduct the prosecution at the bar of the Senate, and the vote of the Senate is taken by putting the question separately to each member, who, during the trial, must be on oath or affirmation. In ordinary cases the president or president *pro tempore* of the Senate presides, but when the president of the United States is on trial the presiding officer must be the chief justice of the United States Supreme Court. A two-thirds vote is necessary for conviction. The president, vice-president or any civil officer of the United States may be impeached for "treason, bribery or other high crimes and misdemeanours," and if convicted, is removed from office and may be disqualified for holding any office under the government in future. The officer after removal is also "liable and subject to indictment, trial, judgment and punishment, according to law." The term "civil officers of the United States" has been construed as being inapplicable to members of the Senate and the House of Representatives. The president's pardoning power does not extend to officers convicted, on impeachment, of offences against the United States. Since the organization of the Federal government there have been only eight impeachment trials before the United States Senate, and of these only two—the trials of Judge John Pickens, a Federal District judge for the District of New Hampshire, in 1803, on a charge of making decisions contrary to law and of drunkenness and profanity on the bench, and of Judge W. H. Humphreys, Judge of the Federal District Court of Tennessee, in 1863, on a charge of making a secession speech and of accepting a judicial position under the Confederate Government—resulted in convictions. The two most famous cases are those of Justice Samuel Chase of the United States Supreme Court in 1805, and of President Andrew Johnson, the only chief of the executive who has been impeached, in 1868. There is a conflict of opinion with regard to the power of the House to impeach a Federal officer who has resigned his office, and also with regard to the kind of offences for which an officer can be impeached, some authorities maintaining that only indictable offences warrant impeachment, and others that impeachment is warranted by any act highly prejudicial to the public welfare or subversive of any essential principle of government. The latter view was adopted by the House of Representatives when it impeached President Johnson.

**IMPERIAL CHAMBER** (*Reichskammergericht*), the supreme judicial court of the Holy Roman Empire, during the period between 1405 and the dissolution of the Empire in 1806. From the early middle ages there had been a supreme court of justice for the Empire—the *Hofgericht* (or *curia imperatoris*, as it were), in which the emperor himself presided. By his side sat a body of assessors (*Urtheilsfinder*), who must be at least seven in number, and who might, in solemn cases, be far more numerous,<sup>1</sup> the assessors who acted varying from time to time and from case to case. The *Hofgericht* was connected with the person of the emperor; it ceased to act when he was abroad; it died with his death. Upon him it depended for its efficiency; and when, in the 15th century, the emperor ceased to command respect, his court lost the confidence of his subjects. The dreary reign of Frederick III. administered its deathblow and after 1450 it ceased to sit. Its place was taken by the *Kammergericht*,

which appeared side by side with the *Hofgericht* from 1415, and after 1450 replaced it altogether. The king (or his deputy) still presided in the *Kammergericht* and it was still his personal court; but the members of the court were now officials—the *consiliarii* of the imperial *aula* (or *Kammer*, whence the name of the court). It was generally the legal members of the council who sat in the *Kammergericht* (see under *AULIC COUNCIL*); and as they were generally doctors of civil law, the court which they composed tended to act according to that law, and thus contributed to the "Reception" of Roman law into Germany towards the end of the 15th century. The old *Hofgericht* had been filled, as it were, by amateurs (provided they knew some law, and were peers of the person under trial), and it had acted by old customary law; the *Kammergericht*, on the contrary, was composed of lawyers, and it acted by the written law of Rome. Even the *Kammergericht*, however, fell into disuse in the later years of the reign of Frederick III.; and the creation of a new and efficient court became a matter of pressing necessity, and was one of the most urgent of the reforms which were mooted in the reign of Maximilian I.

This new court was eventually created in 1495; and it bore the name of *Reichskammergericht*, or Imperial Chamber. It was distinguished from the old *Kammergericht* by the essential fact that it was not the personal court of the emperor, but the official court of the Empire (or *Reich*—whence its name). This change was a natural result of the peculiar character of the movement of reform which was at this time attempted by the electors, under the guidance of Bertold, elector of Mainz. Their aim was to substitute for the old and personal council and court appointed and controlled by the emperor a new and official council, and a new and official court, appointed and controlled by the diet (or rather, in the ultimate resort, by the electors). The members of the Imperial Chamber, which was created by the diet in 1495 in order to serve as such a court,<sup>2</sup> were therefore the agents of the Empire, and not of the emperor. The emperor appointed the president; the Empire nominated the assessors, or judges.<sup>3</sup> There were originally sixteen assessors (afterwards, as a rule, eighteen): half of these were to be doctors of Roman law, while half were to be knights; but after 1555 it became necessary that the latter should be learned in Roman law, even if they had not actually taken their doctorate.

Thus the Empire at last was possessed of a court, a court resting on the enactment of the diet, and not on the emperor's will; a court paid by the Empire, and not by the emperor; a court resident in a fixed place (until 1693, Spire, and afterwards, from 1693 to 1806, Wetzlar), and not attached to the emperor's person. The original intention of the court was that it should replace private war (*Fehde*), and maintain the public peace (*Landfriede*). The great result which in the issue it served to achieve was the final "Reception" of Roman law as the common law of Germany. That the Imperial Chamber should itself administer Roman law was an inevitable result of its composition; and it was equally inevitable that the composition and procedure of the supreme imperial court should be imitated in the various states which composed the Empire, and that Roman law should thus become the local, as it was already the central, law of the land.

The province of the Imperial Chamber, as it came to be gradually defined by statute and use, extended to breaches of the public peace, cases of arbitrary restraint or imprisonment, pleas which concerned the treasury, violations of the emperor's decrees or the laws passed by the diet, disputes about property between immediate tenants of the Empire or the subjects of different rulers, and finally suits against immediate tenants of the Empire (with the exception of criminal charges and matters relating to imperial fiefs, which went to the *Aulic Council*). It

<sup>1</sup> The attempt to create a new and official council ultimately failed.

<sup>2</sup> More exactly, the emperor nominates, according to the regular usage of later times, a certain number of members, partly as emperor, and partly as the sovereign of his hereditary estates; while the rest, who form the majority, are nominated partly by the electors and partly by the six ancient circles.

<sup>3</sup> For instance, all the members of the diet might serve as *Urtheilsfinder* in a case like the condemnation of Henry the Lion, duke of Saxony, in the 12th century.

had also cognizance in cases of refusal to do justice; and it acted as a court of appeal from territorial courts in civil and, to a small extent, in criminal cases, though it lost its competence as a court of appeal in all territories which enjoyed a *privilegium de non appellando* (such as, e.g. the territories of the electors). The business of the court was, however, badly done; the delay was interminable, thanks, in large measure, to the want of funds, which prevented the maintenance of the proper number of judges. In all its business it suffered from the competition of the Aulic Council (*q.v.*); for that body, having lost all executive competence after the 16th century, had also devoted itself exclusively to judicial work. Composed of the personal advisers of the emperor, the Aulic Council did justice on his behalf (the erection of a court to do justice for the Empire having left the emperor still possessed of the right to do justice for himself through his *consilarii*); and it may thus be said to be the descendant of the old Kammergericht. The competition between the Aulic Council and the Imperial Chamber was finally regulated by the treaty of Westphalia, which laid it down that the court which first dealt with a case should alone have competence to pursue it.

See R. Schröder, *Lehrbuch der deutschen Rechtsgeschichte* (Leipzig, 1904); J. N. Harpprecht, *Staatsarchiv des Reichskammergerichts (1757-1785)*; and G. Stobbe, *Reichshofgericht und Reichskammergericht* (Leipzig, 1878). (E. B.K.)

**IMPERIAL CITIES OR TOWNS**, the usual English translation of *Reichsstädte*, an expression of frequent occurrence in German history. These were cities and towns subject to no authority except that of the emperor, or German king, in other words they were immediate; the earliest of them stood on the demesne land of their sovereign, and they often grew up around his palaces. A distinction was thus made between a *Reichsstadt* and a *Landstadt*, the latter being dependent upon some prince, not upon the emperor direct. The term *Freie Reichsstadt*, which is sometimes used in the same sense as *Reichsstadt*, is rightly only applicable to seven cities, Basel, Strassburg, Spire, Worms, Mainz, Cologne and Regensburg. Having freed themselves from the domination of their ecclesiastical lords these called themselves *Freistädte* and in practice their position was indistinguishable from that of the *Reichsstädte*.

In the middle ages many other places won the coveted position of a *Reichsstadt*. Some gained it by gift and others by purchase; some won it by force of arms, others usurped it during times of anarchy, while a number secured it through the extinction of dominant families, like the Hohenstaufen. There were many more free towns in southern than in northern Germany, but their number was continually fluctuating, for their liberties were lost much more quickly than they were gained. Mainz was conquered and subjected to the archbishop in 1462. Some free towns fell into the hands of various princes of the Empire and others placed themselves voluntarily under such protection. Some, like Donauwörth in 1607, were deprived of their privileges by the emperor on account of real, or supposed, offences, while others were separated from the Empire by conquest. In 1648 Besançon passed into the possession of Spain, Basel had already thrown in its lot with the Swiss confederation, while Strassburg, Colmar, Hagenau and others were seized by Louis XIV.

Meanwhile the free towns had been winning valuable privileges in addition to those which they already possessed, and the wealthier among them, like Lübeck and Augsburg, were practically *imperii in imperio*, waging war and making peace, and ruling their people without any outside interference. But they had also learned that union is strength. They formed alliances among themselves, both for offence and for defence, and these *Städtebünde* had an important influence on the course of German history in the 14th and 15th centuries. These leagues were frequently at war with the ecclesiastical and secular potentates of their district and in general they were quite able to hold their own in these quarrels. The right of the free towns to be represented in the imperial diet was formally recognized in 1489, and about the same time they divided themselves into two groups,

or benches, the Rhenish and the Swabian. By the peace of Westphalia in 1648 they were formally constituted as the third college of the diet. A list drawn up in 1422 mentions 75 free cities, another drawn up in 1521 mentions 84, but at the time of the French Revolution the number had decreased to 51. At this time the Rhenish free cities were: Cologne, Aix-la-Chapelle, Lübeck, Worms, Spire, Frankfort-on-the-Main, Goslar, Bremen, Hamburg, Mühlhausen, Nordhausen, Dortmund, Friedberg and Wetzlar. The Swabian free cities were: Regensburg, Augsburg, Nuremberg, Ulm, Esslingen, Reutlingen, Nördlingen, Rothenburg-on-the-Tauber, Schwäbisch-Hall, Rottweil, Ueberlingen, Heilbronn, Memmingen, Gmünd, Dinkelsbühl, Lindau, Biberach, Ravensburg, Schweinfurt, Kempten, Windsheim, Kaufbeuren, Weil, Wangen, Isny, Pfülfendorf, Offenburg, Leutkirch, Wimpfen, Weissenburg, Giengen, Gengenbach, Zell, Buchorn, Aalen, Buchau and Bopfingen. But a large proportion of them had as little claim to their exceptional positions as the pocket boroughs of Great Britain and Ireland had before the passing of the Reform Bill of 1832.

By the peace of Lunéville in 1801 Cologne, Aix-la-Chapelle, Worms and Spire were taken by France, and by the decision of the imperial deputation of 1803 six cities only: Hamburg, Lübeck, Bremen, Augsburg, Frankfort-on-Main and Nuremberg, were allowed to keep their *Reichsfreiheit*, or in other words to hold directly of the Empire. This number was soon further reduced. On the dissolution of the Empire in 1806 Augsburg and Nuremberg passed under the sovereignty of Bavaria, and Frankfort was made the seat of a duchy for Karl Theodor von Dalberg, elector and archbishop of Mainz, who was appointed prince primate of the Confederation of the Rhine. When the German Confederation was established in 1815 Hamburg, Lübeck, Bremen and Frankfort were recognized as free cities, and the first three hold that position in the modern German empire; but Frankfort, in consequence of the part it took in the war of 1866, lost its independence and was annexed by Prussia.

In the earlier years of their existence the free cities were under the jurisdiction of an imperial officer, who was called the *Reichsvogt* or imperial advocate, or sometimes the *Reichsschultheiss* or imperial procurator. As time went on many of the cities purchased the right of filling these offices with their own nominees; and in several instances the imperial authority fell practically into desuetude except when it was stirred into action by peculiar circumstances. The internal constitution of the free cities was organized after no common model, although several of them had a constitution drawn up in imitation of that of Cologne, which was one of the first to assert its independence.

For the history of the free cities, see J. J. Moser, *Reichsstädtisches Handbuch* (Tübingen, 1732); D. Hanleut, *Anmerkungen über die Geschichte der Reichsstädte* (Ulm, 1775); A. Wendt, *Beschreibung der kaiserlichen freien Reichsstädte* (Leipzig, 1804); G. W. Hugo, *Die Mediatisirung der deutschen Reichsstädte* (Carlsruhe, 1838); G. Waitz, *Deutsche Verfassungsgeschichte* (Kiel, 1844 fol.); G. L. von Maurer, *Geschichte der Städteverfassung in Deutschland* (Erlangen, 1869-1871); W. Arnold, *Verfassungsgeschichte der deutschen Freistädte* (Gotha, 1854); P. Brilleke, *Die Entwicklung der Reichsständchaft der Städte* (Hamburg, 1881); A. M. Ehrentraut, *Untersuchungen über die Frage der Frei- und Reichsstädte* (Leipzig, 1902); and S. Rietschel, *Untersuchungen zur Geschichte der deutschen Städteverfassung* (Leipzig, 1905). See also the article COMMUNE. (A. W. H. \*)

**IMPEY, SIR ELIJAH** (1732-1809), chief justice of Bengal, was born on the 13th of June 1732, and educated at Westminster with Warren Hastings, who was his intimate friend throughout life. In 1773 he was appointed the first chief justice of the new supreme court at Calcutta, and in 1775 presided at the trial of Nuncomar (*q.v.*) for forgery, with which his name has been chiefly connected in history. His impeachment was unsuccessfully attempted in the House of Commons in 1787, and he is accused by Macaulay of conspiring with Hastings to commit a judicial murder; but the whole question of the trial of Nuncomar has been examined in detail by Sir James Fitzjames Stephen, who states that "no man ever had, or could have, a fairer trial than Nuncomar, and Impey in particular behaved

with absolute fairness and as much indulgence as was compatible with his duty."

See E. B. Impey, *Sir Elijah Impey* (1846); and Sir James Stephen, *The Story of Nuncomar and the Impeachment of Sir Elijah Impey* (1885).

**IMPHAL**, the capital of the state of Manipur (*q.v.*) in eastern Bengal and Assam, on the north-east frontier of India, situated at the confluence of three rivers. Pop. (1901) 67,903. It is really only a collection of villages buried amid trees, with a clearing containing the palace of the raja, the cantonments, and the houses of the few European residents.

**IMPLEMENT** (Lat. *implementum*, a filling up, from *implere*, to fill), in ordinary usage, a tool, especially in the plural for the set of tools necessary for a particular trade or for completing a particular piece of work (see **TOOLS**). It is also the most general term applied to the weapons and tools that remain of those used by primitive man. The Late Lat. *implementum*, more usually in the plural, *implementa*, was used for all the objects necessary to stock or "fill up" a house, farm, &c.; it was thus applied to furniture of a house, the vestments and sacred vessels of a church, and to articles of clothing, &c. The transition to the necessary outfit of a trade, &c., is easy. In its original Latin sense of "filling up," the term survives in Scots law, meaning full performance or "fulfilment" of a contract, agreement, &c.; "to implement" is thus also used in Scots law for to carry out, perform.

**IMPLUVIUM**, the Latin term for the sunk part of the floor in the atrium of a Greek or Roman house, which was contrived to receive the water passing through the compluvium (*q.v.*) of the roof. The impluvium was generally in marble and sunk about a foot below the floor of the atrium.

**IMPOSITION** (from Lat. *imponere*, to place or lay upon), in ecclesiastical usage, the "laying on" of hands by a bishop at the services of confirmation and ordination as a sign that some special spiritual gift is conferred, or that the recipient is set apart for some special service or work. The word is also used of the levying of a burdensome or unfair tax or duty, and of a penalty, and hence is applied to a punishment task given to a schoolboy. From "impose" in the sense of "to pass off" on some one, imposition means also a trick or deception. In the printing trade the term is used of the arrangement of pages of type in the "forme," being one of the stages between composing and printing.

**IMPOST** (through the O. Fr. from Lat. *impositum*, a thing laid upon another; the modern French is *impôt*), a tax or tribute, and particularly a duty levied on imported or exported merchandise (see **TAXATION**, **CUSTOMS DUTIES**, **EXCISE**, &c.). In architecture, "impost" (in German *Kaempfer*) is a term applied in Italian to the doorpost, but in English restricted to the upper member of the same, from which the arch springs. This may either be in the same plane as the arch mould or projecting and forming a plain band or elaborately moulded, in which case the mouldings are known as impost mouldings. Sometimes the complete entablature of a smaller order is employed, as in the case of the Venetian or Palladian window, where the central opening has an arch resting on the entablature of the pilasters which flank the smaller window on each side. In Romanesque and Gothic work the capitals with their abaci take the place of the impost mouldings.

**IMPOTENCE** (Lat. *impotentia*, want of power), the term used in law for the inability of a husband or wife to have marital intercourse. In English matrimonial law if impotence exists in either of the parties to a marriage at the time of its solemnization the marriage is voidable *ab initio*. A suit for nullity on the ground of impotence can only be brought by the party who suffers the injury. Third persons—however great their interest—cannot sue for a decree on this ground, nor can a marriage be impeached after the death of one of the parties. The old rule of the ecclesiastical courts was to require a triennial cohabitation between the parties prior to the institution of the suit, but this has been practically abrogated (*G. v. G.*, 1871, L.R. 2 P.C.D. 287). In suits for nullity on the ground of impotence, medical evidence

as to the condition of the parties is necessary and a commission of two medical inspectors is usually appointed by the registrar of the court for the purpose of examining the parties; such cases are heard *in camera*. In the United States impotence is a ground for nullity in most states. In Germany it is recognized as a ground for annulment, but not so in France.

**IMPRESSIONISM**. The word "Impressionist" has come to have a more general application in England than in France, where it took currency as the nickname of a definite group of painters exhibiting together, and was adopted by themselves during the conflict of opinion which the novelty of their art excited. The word therefore belongs to the class of nicknames or battle-names, like "Romanticist," "Naturalist," "Realist," which preceded it, words into which the acuteness of controversy infuses more of theoretical purport than the work of the artists denoted suggests to later times. The painters included in such a "school" differ so much among themselves, and so little from their predecessors compared with the points of likeness, that we may well see in these recurring effervescences of official and popular distaste rather the shock of individual force in the artist measured against contemporary mediocrity than the disturbance of a new doctrine. The "Olympia" of Manet, hooted at the Salon of 1865 as subversive of all tradition, decency and beauty, strikes the visitor to the Luxembourg rather as the reversion to a theme of Titian by an artist of ruder vision than as the demonstration of a revolutionary in painting. Later developments of the school do appear to us revolutionary. With this warning in a matter still too near us for final judgment, we may give some account of the Impressionists proper, and then turn to the wider significance sometimes given to the name.

The words *Impressioniste*, *Impressionisme*, are said to have arisen from a phrase in the preface to Manet's catalogue of his pictures exhibited in 1867 during the Exposition Universelle, from which he was excluded. "It is the effect," he wrote, "of sincerity to give to a painter's works a character that makes them resemble a protest, whereas the painter has only thought of rendering his impression." An alternative origin is a catalogue in which Claude Monet entitled a picture of sunrise at sea "Une Impression." The word was probably much used in the discussions of the group, and was caught up by the critics as characteristic.<sup>1</sup> At the earlier date the only meaning of the word was a claim for individual liberty of subject and treatment. So far as subject went, most, though not all of Manet's pictures were modern and actual of his Paris, for his power lay in the representation of the thing before his eye, and not in fanciful invention. His simplicity in this respect brought him into collision with popular prejudice when, in the "Déjeuner sur l'herbe" (1863), he painted a modern *fête champêtre*. The actual characters of his painting at this period, so fancifully reproached and praised, may be grouped under two heads. (1) The expression of the object by a few carefully chosen values in flattish patches. Those patches are placed side by side with little attenuation of their sharp collision. This simplification of colour and tone recalls by its broad effects of light and silhouette on the one hand Velasquez, on the other the extreme simplification made by the Japanese for the purposes of colour-printing. Manet, like the other painters of his group, was influenced by these newly-discovered works of art. The image, thus treated, has remarkable hardness and vigour, and also great decorative breadth. Its vividness and intensity of aspect is gained by the sacrifice of many minor gradations, and by the judgment with which the leading values have been determined. This matching of values produces, technically, a "solid" painting, without glazing or elaborate transparency in shadows. (2) During this period Manet makes constant progress towards a fair, clear colour. In his early work the patches of blond colour are relieved against black shadows; later these shadows clear up, and in place of an indeterminate brown sauce we find

<sup>1</sup> Mr H. P. Hain Friswell has pointed out that the word "impression" occurs frequently in Chevreul's book on colour; but it is also current among the critics. See Ruskin's chapter on Turner's composition—"impression on the mind."

shadows that are colours. A typical picture of this period is the "Musique aux Tuileries," refused by the Salon of 1863. In this we have an actual out-of-doors scene rendered with a frankness and sharp taste of contemporary life surprising to contemporaries, with an elision of detail in the treatment of a crowd and a seizing on the chief colour note and patch that characterize each figure equally surprising, an effort finally to render the total high-pitched gaiety of the spectacle as a banquet of sunlight and colour rather than a collection of separate dramatic groups.

For life of Edouard Manet (1832-1883) see Edmond Bazire, *Manet* (Paris, 1884). An idea of the state of popular feeling may be gained by reading Zola's eloquent defence in *Mon Salon*, which appeared in *L'Écriteur* (1866) and *Edouard Manet* (1867), both reprinted in *Mes Haines* (Paris, 1880). The same author has embodied many of the impressionist ideals in Claude Lantier, the fictitious hero of *L'Œuvre*. Other writers belonging to Manet's group are Théodore Duret, author of *Les Peintres français en 1867* and *Critique d'avant-garde*, articles and catalogue-prefaces reprinted 1885. See also, for Manet and others, J. K. Huysman's *L'Art moderne* (1883) and *Certaines*. Summaries of the literature of the whole period will be found in R. Muther, *The History of Modern Painting* (tr. London, 1896), not always trustworthy in detail, and Miss R. G. Kingsley, *A History of French Art* (1899). For an interesting critical account see W. C. Brownell, *French Art* (1892).

The second period, to which the name is sometimes limited, is complicated by the emergence of new figures, and it is difficult as yet, and perhaps will always remain difficult, to say how much of originality belongs to each artist in the group. The main features are an intenser study of illumination, a greater variety of illuminations, and a revolution in *facture* with a view to pressing closer to a high pitch of light. Manet plays his part in this development, but we shall not be wrong probably in giving to Claude Monet (b. 1840) the chief rôle as the instinctive artist of the period, and to Camille Pissarro (b. 1839) a very large part as a painter, curious in theory and experiment. Monet at the early date of 1866 had painted a picture as daring in its naïve brutality of out-of-door illumination as the "Déjeuner sur l'herbe." But this picture has the breadth of patch, solidity and suavity of paste of Manet's practice. During the siege of Paris (1870-71) Monet and Pissarro were in London, and there the study of Turner's pictures enlarged their ideas of the pitch in lighting and range of effect possible in painting, and also suggested a new handling of colour, by small broken touches in place of the large flowing touches characteristic of Manet. This method of painting occupied much of the discussion of the group that centred round Manet at the Café Guerbois, in the Batignolles quarter (hence called *L'École de Batignolles*). The ideas were: (1) Abolition of conventional brown tonality. But all browns, in the fervour of this revolt, went the way of conventional brown, and all ready-made mixtures like the umbers, ochres, siennas were banished from the palette. Black itself was condemned. (2) The idea of the spectrum, as exhibiting the series of "primary" or "pure" colours, directed the reformed palette. Six colours, besides white, were admitted to represent the chief hues of the spectrum. (3) These colours were laid on the canvas with as little previous mixture on the palette as possible to maintain a maximum of luminosity, and were fused by touch on the canvas as little as possible, for the same reason. Hence the "broken" character of the touch in this painting, and the subordination of delicacies of form and suave continuity of texture to the one aim of glittering light-and-colour notation. Justification of these procedures was sought in occasional features of the practice of E. Delacroix, of Watteau, of J. B. Chardin, in the hatchings of pastel, the stipple of water-colour. With the ferment of theory went a *parti pris* for translating all effects into the upper registers of tone (cf. Ruskin's chapter on Turner's practice in *Modern Painters*), and for emphasizing the colour of shadows at the expense of their tone. The characteristic work of this period is landscape, as the subject of illumination strictly observed and followed through the round of the day and of the seasons. Other pictorial motives were subordinated to this research of effect, and Manet, with a haystack, group of poplars, or church front, has demonstrated the variety of lighting that the day and the season bring to a single scene. Besides

Pissarro, Alfred Sisley (1840-1890) is a member of the group, and Manet continues his progress, influenced by the new ideas in pictures like "Le Linge" and "Chez le Père Lathuille."

Edmond Degas (b. 1834), a severe and learned draughtsman, is associated with this landscape group by his curiosity in the expression of momentary action and the effects of artificial illumination, and by his experiments in broken colour, more particularly in pastel. The novelty of his matter, taken from unexplored corners of modern life, still more the daring and irony of his observation and points of view, and the strangeness of his composition, strongly influenced by Japanese art, enriched the associations now gathering about the word "impressionist." Another name, that of Auguste Renoir (b. 1841), completes the leading figures of the group. Any "school" programme would be strained to breaking-point to admit this painter, unless on the very general grounds of love of bright colour, sunlit places and independence of vision. He has no science of drawing or of tone, but wins a precarious charm of colour and expression.

The landscape, out-of-doors line, which unites in this period with Manet's work, may be represented by the names of P. Corot, J. B. Jongkind, Boudin, Monet. Monet's real teacher was Eugène Boudin (1824-1898). (See Gustave Cahen's *Eugène Boudin*, Paris, 1900). They, and others of the group, worked together in a painters' colony at Saint Simeon, near Honfleur. It is usual to date the origin of *plein-air* painting, i.e. painting out-of-doors, in an out-of-doors key of tone, from a picture Manet painted in the garden of de Nittis, just before the outbreak of war in 1870. This dates only Manet's change to the lighter key and looser handling. It was Monet who carried the practice to a logical extreme, working on his canvas only during the effect and in its presence. The method of Degas is altogether different, viz., a combination in the studio from innumerable notes and observations. It will be evident from what has been said above that impressionistic painting is an artistic ferment, corresponding to the scientific research into the principles of light and colour, just as earlier movements in painting coincided with the scientific study of perspective and anatomy. Chevreul's famous book, already referred to, *De la loi du contraste simultané des couleurs* (1838), established certain laws of interaction for colours adjacent to one another. He also, however, referred the sensations of colour to the three impossible "primaries" of Brewster—red, blue and yellow. The Young-Helmholtz theory affected the palette of the Impressionists, and the work of Ogden Rood, *Colour* (Internat. Scientific Series, 1879-1881), published in English, French and German, furnished the theorists with formulae measuring the degradation of pitch suffered by pigments in mixture.

The Impressionist group (with the exception of Manet, who still fought for his place in the Salon) exhibited together for the first time at L'Exposition des Impressionistes at Nadar's, Boulevard des Capucines, in 1874. They were then taken up by the dealer Durand-Ruel, and the succeeding exhibitions in 1876, 1877, 1879, 1880, 1881, 1882 and 1886 were held by him in various galleries. The full history of these exhibitions, with the names of the painters, will be found in two works: Félix-Fénéon, *Les Impressionistes en 1886* (Paris, 1886), and G. Geoffroy, *La Vie artistique* ("Histoire de l'impressionisme," in vol. for 1894). See also G. Lecomte, *L'Art impressionniste d'après la collection privée de M. Durand-Ruel* (Paris, 1892); Duranty, *La Peinture nouvelle* (1876). Besides the names already cited, some others may be added: Madame Berthe Morisot, sister-in-law of Manet; Paul Cézanne, belonging to the Manet-Pissarro group; and, later, Gauguin. J. F. Raffaelli applied a "characteristic" drawing, to use his word, to scenes in the dismal suburbs of Paris: Forain, the satiric draughtsman, was a disciple of Degas, as also Zandomenighi. Miss Mary Cassatt was his pupil. Caillebotte, who bequeathed the collection of Impressionist paintings now in the Luxembourg, was also an exhibitor; and Boudin, who linked the movement to the earlier schools.

The first exhibitions of the Impressionists in London were in 1882 and 1883, but their fortunes there cannot be pursued in the present article, nor the history of the movement beyond its originators. This excludes notable figures, of which M. Besnard may be chosen as a type.

In Manet's painting, even in the final steps he took towards "la peinture claire," there is nothing of the "decomposition of tones" that logically followed from the theories of his followers. He recognized the existence in certain illuminations of the violet shadow, and he adopted in open-air work a looser and more broken touch. The nature of his subjects encouraged such a handling, for the painter who attempts to note from nature the colour values of an elusive effect must treat form in a summary fashion, still more so when the material is in constant movement like water. Moreover, in the river-side subjects

near Paris there was a great deal that was only pictorially tolerable when its tone was subtracted from the details of its form. Monet's painting carries the shorthand of form and broken colour to extremity; the flowing touch of Manet is chopped up into harsher, smaller notes of tone, and the pitch pushed up till all values approach the iridescent end of the register. It was in 1886 that the *doctrinaire* ferment came to a head, and what was supposed to be a scientific method of colour was formulated. This was *pointillisme*, the resolution of the colours of nature back into six bands of the rainbow or spectrum, and their representation on the canvas by *dots* of unmixed pigment. These dots, at a sufficient distance, combine their hues in the eye with the effect of a mixture of coloured *lights*, not of pigments, so that the result is an increase instead of a loss of luminosity. There are several fallacies, however, theoretical and practical, in this "spectral palette" and pointillist method. If we depart from the three primaries of the Helmholtz hypothesis, there is no reason why we should stop at six hues instead of six hundred. But pigments follow the spectrum series so imperfectly that the three primaries, even if we could exactly locate them, limit the palette considerably in its upper range. The sacrifice of black is quite illogical, and the lower ranges suffer accordingly. Moreover, it is doubtful whether many painters have followed the laws of mixture of lights in their dotting, e.g. dotting green and red together to produce yellow. It may be added that dotting with oil pigment is in practice too coarse and inaccurate a method. This innovation of *pointillisme* is generally ascribed to George Seurat (d. 1890), whose picture, "La Grande Jatte," was exhibited at the Rue Laffitte in 1886. Pissarro experimented in the new method, but abandoned it, and other names among the *Pointillistes* are Paul Signac, Vincent van Gogh, and van Rysselberghe. The theory opened the way for endless casuistics, and its extravagances died out in the later exhibition of the *Independants* or were domesticated in the Salon by painters like M. Henri Martin.

The first modern painter to concern himself scientifically with the reactions of complementary colours appears to have been Delacroix (J. Leonardo, it should be remembered, left some notes on the subject). It is claimed for Delacroix that as early as 1825 he observed and made use of these reactions, anticipating the complete exposition of Chevreul. He certainly studied the treatise, and his biographers describe a dial-face he constructed for reference. He had quantities of little wafers of each colour, with which he tried colour effects, a curious anticipation of pointillist technique. The pointillists claim him as their grandfather. See Paul Signac, "D'Eugène Delacroix au Néo-Impressionisme" (*Revue Blanche*, 1898). For a fuller discussion of the spectral palette see the *Saturday Review*, 2nd, 9th and 23rd February and 23rd March 1901.

In England the ideas connected with the word Impressionism have been refracted through the circumstances of the British schools. The questions of pitch of light and iridescent colour had already arisen over the work of Turner, of the Pre-Raphaelites, and also of G. F. Watts, but less isolated and narrowed, because the art of none of these limited itself to the pursuit of light. *Pointillisme*, after a fashion, existed in British water-colour practice. But the Pre-Raphaelite school had accustomed the English eye to extreme definition in painting and to elaboration of detail, and it happened that the painting of James McNeill Whistler (Grosvenor Gallery, 1878) brought the battle-name Impressionism into England and gave it a different colour. Whistler's method of painting was in no way revolutionary, and he preferred to transpose values into a lower key rather than compete with natural pitch, but his vision, like that of Manet under the same influences, Spanish and Japanese, simplified tone and subordinated detail. These characteristics raised the whole question of the *science and art of aspect in modern painting*, and the field of controversy was extended backwards to Velasquez as the chief master of the moderns. "Impressionism" at first had meant individualism of vision, later the notation of fugitive aspects of light and of movement; now it came to mean breadth in pictorial vision, all the simplifications that arise from the modern analysis of aspect, and especially the effect produced upon the parts of a picture-field by attending to the *impression of the whole*. Ancient

painting analyses aspect into three separate acts as form, tone and colour. All forms are made out with equal clearness by a conventional outline; over this system of outlines a second system of light and shade is passed, and over this again a system of colours. Tone is conceived as a difference of black or white added to the tints, and the colours are the definite local tints of the objects (a blue, a red, a yellow, and so forth). In fully developed modern painting, instead of an object analysed into sharp outlines covered with a uniform colour darkened or lightened in places, we find an object analysed into a number of surfaces or planes set at different angles. On each of these facets the character of the object and of the illumination, with accidents of reflection, produces a patch called by modern painters a "value," because it is colour of a particular value or tone. (With each difference of tone, "value" implies a difference of hue also, so that when we speak of a different tone of the same colour we are using the word "same" in a loose or approximate sense.) These planes or facets define themselves one against another with greater or less sharpness. Modern technique follows this modern analysis of vision, and in one act instead of three renders by a "touch" of paint the shape and value of these facets, and instead of imposing a uniform ideal outline at all their junctions, allows these patches to define themselves against one another with variable sharpness.

Blurred definition, then, as it exists in our natural view of things, is admitted into painting; a blurring that may arise from distance, from vapour or smoke, from brilliant light, from obscurity, or simply from the nearness in value of adjacent objects. Similarly, much detail that in primitive art is elaborated is absorbed by rendering the aspect instead of the facts known to make up that aspect. Thus hair and fur, the texture of stuffs, the blades of grass at a little distance, become patches of tone showing only their larger constructive markings. But the blurring of definitions and the elimination of detail that we find in modern pictorial art are not all of this ready-made character. We have so far only the scientific analysis of a field of view. If the painter were a scientific reporter he would have to pursue the systems of planes, with their shapes and values, to infinity. Impressionism is the art that surveys the field and determines which of the shapes and tones are of chief importance to the *interested eye*, enforces these, and sacrifices the rest. Construction, the logic of the object rendered, determines partly this action of the eye, and also decoration, the effects of rhythm in line and harmony in fields of colour. These motives belong to all art, but the specially impressionist motive is the act of *attention* as it affects the aspect of the field. We are familiar, in the ordinary use of the eye, with two features of its structure that limit clearness of vision. There is, first, the spot of clear vision on the retina, outside of which all falls away into blur; there is, secondly, the action of *focus*. As the former limits clear definition to one spot in the field extended vertically and laterally, so focus limits clear definition to one plane in the third dimension, viz. depth. If three objects, A, B and C, stand at different depths before the eye, we can at will fix A, whereupon B and C must fall out of focus, or B, whereupon A and C must be blurred, or C, sacrificing the clearness of A and B. All this apparatus makes it impossible to see everything at once with equal clearness, enables us, and forces us for the uses of real life, to frame and limit our picture, according to the immediate interest of the eye, whatever it may be. The painter instinctively uses these means to arrive at the emphasis and neglect that his choice requires. If he is engaged on a face he will now screw his attention to a part and now relax it, distributing the attention over the whole so as to restore the bigger relations of aspect. Sir Joshua Reynolds describes this process as seeing the whole "with the dilated eye"; the commoner pretext of the studios is "to look with the eyes half closed"; a third way is to throw the whole voluntarily out of focus. In any case the result is that minor planes are swamped in bigger, that smaller patches of colour are swept up into broader, that markings are blurred. The final result of these tentative reviews records, in what is blurred and what is clear, the attention that has been distributed

to different parts, and to parts measured against the whole. The Impressionist painter does not allot so much detail to a face in a full-length portrait as to a head alone, nor to twenty figures on a canvas as to one. Again, he indicates by his treatment of planes and definitions whether the main subject of his picture is in the foreground or the distance. He persuades the eye to slip over hosts of near objects so that, as in life, it may hit a distant target, or concentrate its attack on what is near, while the distance falls away into a dim curtain. All those devices by which attention is directed and distributed, and the importance in space of an object established, affect impressionistic composition.

It is an inevitable misunderstanding of painting which plays the game of art so closely up to the real aspects of nature that its aim is that of mere exact copying. Painting like Manet's, accused of being realistic in this sense, sufficiently disproves the accusation when examined. Never did painting show a *parti pris* more pronounced, even more violent. The elisions and assertions by which Manet selects what he finds significant and beautiful in the complete natural image are startling to the stupid realist, and the Impressionist may best be described as the painter who out of the completed contents of vision constructs an image moulded upon his own interest in the thing seen and not on that of any imaginary schoolmaster. Accepting the most complex terms of nature with their special emotions, he uses the same freedom of sacrifice as the man who at the other end of the scale expresses his interest in things by a few scratches of outline. The perpetual enemy of both is the eclectic, who works for possible interests not his own.

Some of the points touched on above will be found amplified in articles by the writer in *The Albemarle* (September 1892), the *Fortnightly Review* (June 1894), and *The Artist* (March-July 1896). An admirable exposition of Impressionism in this sense is R. A. M. Stevenson's *The Art of Velasquez* (1895). Mr. Stevenson was trained in the school of Carlus Duran, where impressionist painting was reduced to a system. Mr. Sargent's painting is a brilliant example of the system. (D. S. M.)

**IMPRESSMENT**, the name given in English to the exercise of the authority of the state to "press"<sup>1</sup> or compel the service of the subject for the defence of the realm. Every sovereign state must claim and at times exercise this power. The "drafting" of men for service in the American Civil War was a form of impressment. All the monarchical, or republican, governments of Europe have employed the press at one time or another. All forms of conscription, including the English ballot for the militia, are but regulations of this sovereign right. In England impressment may be looked upon as an erratic, and often oppressive, way of enforcing the common obligation to serve in "the host" or in the *posse comitatus* (power of the county). In Scotland, where the feudal organization was very complete in the Lowlands, and the tribal organization no less complete in the Highlands, and where the state was weak, impressment was originally little known. After the union of the two parliaments in 1707, no distinction was made between the two divisions of Great Britain. In England the kings of the Plantagenet dynasty caused Welshmen to be pressed by the Lords Marchers, and Irish kerns to be pressed by the Lords Deputy, for their wars in France. Complaints were made by parliament of the oppressive use of this power as early as the reign of Edward III., but it continued to be exercised. Readers of Shakespeare will remember Sir John Falstaff's commission to press soldiers, and the manner, justified no doubt by many and familiar examples of the way in which the duty was performed. A small sum

<sup>1</sup> It is now accepted generally that "to press" is a corruption of "prest," as "impress" is of "imprest," but the word was quite early connected with "press," to squeeze, crush, hence to compel or force. The "prest" was a sum of money advanced (O. Fr. *prestre*, modern *prêter*, to lend, Lat. *praestare*, to stand before, provide, become surety for, &c.) to a person to enable him to perform some undertaking, hence used of earnest money given to soldiers on enlistment, or as the "coat and conduct" money alluded to in this article. The methods of compulsion used to get men for military service naturally connected the word with "to press" (Lat. *praestare*, frequentative of *præmere*) to force, and all reference to the money advanced was lost (see Skeat, *Etym. Dict.*, 1898, and the quotation from H. Wedgwood, *Dict. of Eng. Etym.*).

called *imprest-money*, or *coat and conduct money*, was given to the men when pressed to enable them to reach the appointed rendezvous. Soldiers were secured in this way by Queen Elizabeth, by King Charles I., and by the parliament itself in the Civil War. The famous New Model Army of Cromwell was largely raised by impressment. Parliament ordered the county committees to select recruits of "years meet for their employment and well clothed." After the Revolution of 1688 parliament occasionally made use of this resource. In 1770 a general press of all rogues and vagabonds in London to be drafted into the regiments was ordered. It is said that all who were not too lame to run away or too destitute to bribe the parish constable were swept into the net. As they were encouraged to desert by the undisguised connivance of the officers and men who were disgusted with their company, no further attempt to use the press for the army was made.

A distinction between the liability of sailors and of other men dates from the 16th century. From an act of Philip and Mary (1556) it appears that the watermen of the Thames claimed exemption from the press as a privileged body. They were declared liable, and the liability was clearly meant to extend to service as a soldier on shore. In the fifth year of Queen Elizabeth (1563) an act was passed to define the liability of the sailors. It is known as "an Act touching politick considerations for the maintenance of the Navy." By its term all fishermen and mariners were protected from being compelled "to serve as any soldiers upon the Land or upon the Sea, otherwise than as a mariner, except it shall be to serve under any Captain of some ship or vessel, for landing to do some special exploit which mariners have been used to do." The operation of the act was limited to ten years, but it was renewed repeatedly, and was at last indefinitely prolonged in the sixteenth year of the reign of Charles I. (1631). By the Vagrancy Act of the close of Queen Elizabeth's reign (1597), disorderly serving-men and other disreputable characters, of whom a formidable list is given, were declared to be liable to be impressed for service in the fleet. The "Takers," as they were called in early times, the Press Gang of later days, were ordered to present their commission to two justices of the peace, who were bound to pick out "such sufficient number of able men, as in the said commission shall be contained, to serve Her Majesty as aforesaid." The justices of the peace in the coast districts, who were often themselves concerned in the shipping trade, were not always zealous in enforcing the press. The pressed sailors often deserted with the "imprest money" given them. Loud complaints were made by the naval officers of the bad quality of the men sent up to serve in the king's ships. On the other hand, the Press Gangs were accused of extorting money, and of making illegal arrests. In the reign of Queen Anne (1703) an act was passed "for the increase of Seamen and the better encouragement of navigation, and the protection of the Coal Trade." The act which gave parish authorities power to apprentice boys to the sea exempted the apprentices from the press for three years, and until the age of eighteen. It especially reaffirmed the part of the Vagrancy Act of Elizabeth's reign which left rogues and vagabonds subject to be pressed for the sea service. By the act for the "Increase of Mariners and Seamen to navigate Merchant Ships and other trading ships or vessels," passed in the reign of George II. (1740), all men over fifty-five were exempted from the press together with lads under eighteen, foreigners serving in British ships (always numerous in war time), and landsmen who had gone to sea during their first two years. The act for "the better supplying of the cities of London and Westminster with fish" gave exemption to all masters of fishing-boats, to four apprentices and one mariner to each boat, and all landsmen for two years, except in case of actual invasion. By the act for the encouragement of insurance passed in 1774, the fire insurance companies in London were entitled to secure exemption for thirty watermen each in their employment. Masters and mates of merchant vessels, and a proportion of men per ship in the colliers trading from the north to London, were also exempt.

Subject to such limitations as these, all seafaring men, and

watermen on rivers, were liable to be pressed between the ages of eighteen and fifty-five, and might be pressed repeatedly for so long as their liability lasted. The rogue and vagabond element were at the mercy of the justices of the peace. The frightful epidemics of fever which desolated the navy till late in the 18th century were largely due to the infection brought by the prisoners drafted from the ill-kept jails of the time. As service in the fleet was most unpopular with the sailors, the press could often only be enforced by making a parade of strength and employing troops. The men had many friends who were always willing to conceal them, and they themselves became expert in avoiding capture. There was, however, one way of procuring them which gave them no chance of evasion. The merchant ships were stopped at sea and the sailors taken out. This was done to a great extent, more especially in the case of homeward-bound vessels. On one occasion, in 1802, an East Indiaman on her way home was deprived of so many of her crew by a man of war in the Bay of Biscay that she was unable to resist a small French privateer, and was carried off as a prize with a valuable cargo. The press and the jails failed to supply the number of men required. In 1795 it was found necessary to impose on the counties the obligation to provide "a quota" of men, at their own expense. The local authorities provided the recruits by offering high bounties, often to debtors confined in the prisons. These desperate men were a very bad element in the navy. In 1797 they combined with the United Irishmen, of whom large numbers had been drafted into the fleet as vagabonds, to give a very dangerous political character to the mutinies at the Nore and on the south of Ireland. After the conclusion of the great Napoleonic wars in 1815 the power of the press was not again exercised. In 1835 an act was passed during Sir James Graham's tenure of office as first lord of the admiralty, by which men who had once been pressed and had served for a period of five years were to be exempt from impressment in future. Sir James, however, emphatically reaffirmed the right of the crown to enforce the service of the subject, and therefore to impress the seamen. The introduction of engagements for a term of five years in 1853, and then of long service, has produced so large a body of voluntary recruits, and service in the navy is so popular, that the question has no longer any interest save an historical one. If compulsory service in the fleet should again become necessary it will not be in the form of the old system of impressment, which left the sailor subject to compulsory service from the age of eighteen to fifty-five, and flooded the navy with the scum of the jails and the workhouse.

**AUTHORITIES.**—Grose's *Military Antiquities*, for the general subject of impressment, vol. ii. p. 73 et seq. S. R. Gardiner gives many details in his history of James I. and Charles I., and in *The Civil War*. The acts relating to the navy are quoted in *A Collection of the Statutes relating to the Admiralty*, &c., published in 1840. Some curious information is in the papers relating to the Great Blockade edited by John Leyland for the Navy Record Society. Sir James Graham's speech is in Hansard for 1835.

**IMPROMPTU** (from *in promptu*, on the spur of the moment), a short literary composition which has not been, or is not supposed to have been, prepared beforehand, but owes its merit to the ready skill which produces it without premeditation. The word seems to have been introduced from the French language in the middle of the 17th century. Without question, the poets have, from earliest ages, made impromptus, and the very art of poetry, in its lyric form, is of the nature of a modified improvisation. It is supposed that many of the epigrams of the Greeks, and still more probably those of the Roman satirists, particularly Martial, were delivered on the moment, and gained a great part, at least, of their success from the evidence which they gave of rapidity of invention. But it must have been difficult then, as it has been since, to be convinced of the value of that evidence. Who is to be sure that, like Mascarille in *Les Précieuses ridicules*, the impromptu-writer has not received his leisure in sharpening his arrows? James Smith recognised the highest praise for his compliment to Miss Tree, the cantatrice:—

On this tree when a nightingale settles and sings,  
The Tree will return him as good as he brings.

This was extremely neat, but who is to say that James Smith had not polished it as he dressed for dinner? One writer owed all his fame, and a seat among the Forty Immortals of the French Academy, to the reputation of his impromptus. This was the Marquis François Joseph de St Aulaire (1643-1742). The piece which threw open the doors of the Academy to him in 1706 was composed at Sceaux, where he was staying with the duchess of Maine, who was guessing secrets, and who called him Apollo. St Aulaire instantly responded:—

La divinité qui s'amuse  
À me demander mon secret,  
Si j'étais Apollon, ne serait pas ma muse,  
Elle serait Thétis—et le jour finirait.

This is undoubtedly as neat as it is impertinent, and if the duchess had given him no ground for preparation, this is typical of the impromptu at its best. Voltaire was celebrated for the savage wit of his impromptus, and was himself the subject of a famous one by Young. Less well known but more certainly extemporaneous is the couplet by the last-mentioned poet, who being asked to put something amusing in an album, and being obliged to borrow from Lord Chesterfield a pencil for the purpose, wrote:—

Accept a miracle instead of wit,—

See two dull lines with Stanhope's pencil writ.

The word "impromptu" is sometimes used to designate a short dramatic sketch, the type of which is Molière's famous *Impromptu du Versailles* (1663), a miniature comedy in prose.

**IMPROVISATORE**, a word used to describe a poet who recites verses which he composes on the spur of the moment, without previous preparation. The term is purely Italian, although in that language it would be more correctly spent *improvvisatore*. It became recognized as an English word in the middle of the eighteenth century, and is so used by Smollett in his *Travels* (1766); he defines an improvisatore as "an individual who has the surprising talent of reciting verses extempore, on any subject you propose." In speaking of a woman, the female form *improvisatrice* is sometimes used in English.

Improvisation is a gift which properly belongs to those languages in which a great variety of grammatical inflections, wedded to simplicity of rhythm and abundance of rhyme, enable a poet to slur over difficulties in such a way as to satisfy the ear of his audience. In ancient times the greater part of the popular poetry with which the leisure of listeners was beguiled was of this rhapsodical nature. But in modern Europe it was the troubadours, owing to the extreme flexibility of the languages of Provence, who distinguished themselves above all others as improvisators. It is difficult to believe, however, that the elaborate compositions of these poets, which have come down to us, in which every exquisite artifice of versification is taken advantage of, can have been poured forth without premeditation. These poets, we must rather suppose, took a pride in the ostentation of a prodigious memory, most carefully trained, and poured forth in public what they had laboriously learned by heart in private. The Italians, however, in the 16th century, cultivated what seems to have been a genuine improvisation, in which the bards rhapsodized, not as they themselves pleased, but on subjects which were unexpected by them, and which were chosen on the spot by their patrons. Of these, the most extraordinary is said to have been Silvio Antoniano (1540-1603), who from the age of ten was able to pour out melodious verse on any subject which was suggested to him. He was brought to Rome, where successive popes so delighted in his talent that in 1598 he was made a cardinal. In the 17th century the celebrated Metastasio first attracted attention by his skill as an improvisator. But he was excelled by Bernardino Peretti (1681-1747), who was perhaps the most extraordinary genius of this class who has ever lived. He was seized, in his moments of composition, with a transport which transfigured his whole person, and under this excitement he poured forth verses in a miraculous flow. It was his custom to be attended by a guitarist, who played a recitative accompaniment. In this way Peretti made a triumphal procession through the cities of Italy, ending

up with the Capitol of Rome, where Pope Benedict XIII. crowned him with laurel, and created him a Roman citizen. One of the most remarkable improvisators of modern times appeared in Sweden, in the person of Karl Mikael Bellman (1740-1795), who used to take up a position in the public gardens and parks of Stockholm, accompanying himself on a guitar, and treating metre and rhythm with a virtuosity and originality which place him among the leading poets of Swedish literature. In England, somewhat later, Theodore Hook (1788-1841) developed a surprising talent for this kind, but his verses were rarely of the serious or sentimental character of which we have hitherto spoken. Hook's animal spirits were unfortunately mingled with vulgarity, and his clever *jeu d'esprit* had little but their smartness to recommend them. A similar talent, exercised in a somewhat more literary direction, made Joseph Méry (1798-1865) a delightful companion in the Parisian society of his day. It is rare indeed that the productions of the improvisator, taken down in shorthand, and read in the cold light of criticism, are found to justify the impression which the author produced on his original audience. Imperfections of every kind become patent when we read these transcripts, and the reader cannot avoid perceiving weaknesses of style and grammar. The eye and voice of the improvisator so hypnotize his auditors as to make them incapable of forming a sober judgment on matters of mere literature.

**IN-ANTIS**, the architectural term given to those temples the entrance part of which consisted of two columns placed between the antae or pilasters (see TEMPLE).

**INAUDI, JACQUES** (1867- ), Italian calculating prodigy, was born at Onorato, Piedmont, on the 15th of October 1867. When between seven and eight years old, at which time he was employed in herding sheep, he already exhibited an extraordinary aptitude for mental calculation. His powers attracted the notice of various showmen, and he commenced to give exhibitions. He was carefully examined by leading French scientists, including Charcot, from the physiological, psychological and mathematical point of view. The secret of his arithmetical powers appeared to reside in his extraordinary memory, improved by continuous practice. It appeared to depend upon hearing rather than sight, more remarkable results being achieved when figures were read out than when they were written.

**INCANTATION**, the use of words, spoken, sung or chanted, usually as a set formula, for the purpose of obtaining a result by their supposed magical power. The word is derived from the Latin *incantare*, to chant a magical formula; cf. the use of *carmen*, for such a formula of words. The Latin use is very early; thus it appears in a fragment of the XII. Tables quoted in Pliny (*N.H.* xxviii. 2, 4, 17), "Qui malum carmen incantasset." From the O. Fr. derivative of *incantare*, *enchanter*, comes "enchant," "enchantment," &c., properly of the exercise of magical powers, hence to charm, to fascinate, words which also by origin are of magical significance. The early magi of Assyria and Babylonia were adepts at this art, as is evident from the examples of Akkadian incantations that have been discovered. Daniel (v. 11) is spoken of as "master of the enchanters" of Babylon. In Egypt and in India many formulas of religious magic were in use, witness especially the Vedic *mantras*, which are closely akin to the Maori *karakias* and the North American *matamancas*. Among the holy men presented by the king of Korea to the mikado of Japan in A.D. 577 was a reciter of *mantras*, who would find himself at home with the *majinahi* or incantation practised by the ancient Japanese for dissipating evil influences. One of the most common, widespread and persistent uses of incantation was in healing wounds, instances of which are found in the *Odyssey* and the *Kalkvala*, and in the traditional folk-lore of almost every European country. Similar songs were sung to win back a faithless lover (cf. the second *Idyll* of Theocritus).

See further MAGIC.

**INCE, WILLIAM**, English 18th century furniture designer and cabinetmaker. He was one of the most successful imitators of Chippendale, although his work was in many respects lighter. He helped, indeed, to build the bridge between the massive and

often florid style of Chippendale and the more boudoir-like forms of Hepplewhite. Although many of his designs were poor and extravagant, his best work was very good indeed. His chairs are sometimes mistaken for those of Chippendale, to which, however, they are much inferior. He greatly affected the Chinese and Gothic tastes of the second half of the 18th century. He was for many years in partnership in Broad Street, Golden Square, London, with Thomas Mayhew (q.v.), in collaboration with whom he published a folio volume of ninety-five plates, with letterpress in English and French under the title of *The Universal System of Household Furniture* (undated, but probably about 1762).

**INCE-IN-MAKERFIELD**, an urban district in the Ince parliamentary division of Lancashire, England, adjoining the borough of Wigan. Pop. (1901) 21,262. The Leeds and Liverpool Canal intersects the township. There are large collieries, iron-works, forges, railway wagon works, and cotton mills. There is preserved here the Old Hall, a beautiful example of half-timbered architecture.

**INCENDIARISM** (*Lat. incendere*, to set on fire, burn), in law, the willful or malicious burning of the house or property of another, and punishable as arson (q.v.). It may be noted that in North Carolina it is provided in case of fires that there is to be a preliminary investigation by local authorities; all towns and cities have to make an annual inspection of buildings and a quarterly inspection within fire limits and report to the state insurance commissioner; all expenses so incurred are met by a tax of  $\frac{1}{4}$ % on the gross receipts of the insurance companies (L. 1903, ch. 719).

**INCENSE**,<sup>1</sup> the perfume (fumigation) arising from certain resins and gum-resins, barks, woods, dried flowers, fruits and seeds, when burnt, and also the substances so burnt. In its literal meaning the word "incense" is one with the word "perfume," the aroma given off with the smoke (*per fumum*)<sup>2</sup> of any odiferous substance when burnt. But, in use, while the meaning of the word "perfume" has been extended so as to include everything sweet in smell, from smoking incense to the invisible fresh fragrance of fruits and exquisite scent of flowers, that of the word "incense," in all the languages of modern Europe in which it occurs, has, by an opposite process of limitation, been gradually restricted almost exclusively to frankincense (see FRANKINCENSE). Frankincense has always been obtainable in Europe in greater quantity than any other of the aromatics imported from the East; it has therefore gradually come to be the only incense used in the religious rites and domestic fumigations of many countries of the West, and at last to be properly regarded as the only "true" or "genuine" (i.e. "franc") incense (see Littré's *Fr. Dict.* and Skeat's *Etym. Dict. of Engl. Lang.*).<sup>3</sup>

The following is probably an exhaustive list of the substances available for incense or perfume mentioned in the Hebrew Scriptures:—Alum or alum wood (alum in 1 Kings x. 11, 12; alum

<sup>1</sup> *Incensum* (or *incensum thuris*) from *incendere*; Ital. and Port. *incenso*; Span. *incienso*; Fr. *encens*. The substantive occurs in an inscription of the Arvalian brotherhood (Marini, *Gli Atti e Monumenti de' fratelli Arvali*, p. 639), but is frequent only in ecclesiastical Latin. Compare the classical *suffimentum* and *suffilus* from *suffio*. For "incense" Ulfila (Luke i. 10, 11) has retained the Greek *θυμίανα* (*thymiamata*); all the Teutonic names (Ger. *Weirach*; Old Saxon *Wird*; Icecl. *Reykels*; Dan. *Røgelse*) seem to belong to the Christian period (*Grundr. Deutsche Mythologie*, i. 50).

<sup>2</sup> The etymological affinities of *thus*, *thous*, *thus*, *suffio*, *funus*, and the Sans. *dhuma* are well known. See Max Müller, *Chips*, i. 99.

<sup>3</sup> Classical Latin has but one word (*thus* or *tus*) for all sorts of incense. *Libanus*, for frankincense, occurs only in the Vulgate. Even the "ground frankincense" or "ground pine" (*Ajuga chamaepitys*) was known to the Romans as *Tus terrae* (Pliny), although they called some plant, from its smelling like frankincense, *Libanotis*, and a kind of Thasian wine, also from its fragrance, *Libanotis*. The Latino-barbaric word *Olibanum* (quasi *Oleum Libani*), the common name for frankincense in modern commerce, is used in a bull of Pope Benedict IX. (1033). It may here be remarked that the name "European frankincense" is applied to *Pinus Tæda*, and to the resinous exudation ("Burgundy pitch") of the Norwegian spruce fir (*Abies excelsa*). The "incense tree" of America is the *Irica guianensis*, and the "incense wood" of the same continent *I. heptaphylla*.



in 2 Chron. ii. 8, and ix. 10, 11), generally identified with sandalwood (*Santalum album*), a native of Malabar and Malaya; aloes, or lign aloes (Heb. *ahālim*, *ahālišk*), produced by the *Aloexylon Agalochum* (Loureiro), a native of Cochinchina, and *Aquilaria Agallocha* (Roxburgh), a native of India beyond the Ganges; balsam (Heb. *tsori*), the oleo-resin of *Balsamodendron opobalsamum* and *B. gileadense*; bdellium (Heb. *bdōlak*), the resin produced by *Balsamodendron roxburghii*, *B. Mukul* and *B. pubescens*, all natives of Upper India (Lassus of Homburg identifies *bdōlak* with musk); *calamus* (Heb. *kaneh*; sweet calamus, *kaneh bosem*, Ex. xxx. 23; Ezek. xxvii. 19; sweet cane, *kaneh hattob*, Jer. vi. 20; Isa. xliii. 24), identified by Royle with the *Andropogon Calamus aromaticus* or roosa grass of India; cassia (Heb. *kiddah*) the *Cinnamomum Cassia* of China; cinnamon (Heb. *kinamon*), the *Cinnamomum zeylanicum* of the Somali country, but cultivated largely in Ceylon, where also it runs wild, and in Java; *costus* (Heb. *ketsiakh*), the root of the *Aucklandia Costus* (Falconer), native of Kashmir; frankincense (Heb. *lebōnah*), the gum-resin of *Boswellia Frereana* and *B. Bhan-Dajiana* of the Somali country, and of *B. Carterii* of the Somali country and of the opposite coast of Arabia (see "The Genus Boswellia" by Sir George Birdwood, *Transactions of the Linnean Society*, xxi. 1871); galbanum (Heb. *kelbenah*), yielded by *Opodia galbanifera* (Royle) of Khorassan, and *Galbanum officinale* (Don) of Syria and other *Ferulas*; *ladanum* (Heb. *lōt*, translated "myrrh" in Gen. xxxvii. 25, xliii. 11), the resinous exudation of *Cistus creticus*, *C. ladaniferus* and other species of "rock rose" or "rose of Sharon"; myrrh (Heb. *mōr*), the gum-resin of the *Balsamodendron Myrrha* of the Somali country and opposite shore of Arabia; *onycha* (Heb. *shepeleth*), the celebrated odoriferous shell of the "writing shell," the operculum of "snail" (a species of *Succinea* or "wink shell" formerly known in Europe under the name of *Blatta byzantina*; it is still imported into Bombay to burn with frankincense and other incense to bring out their odours more strongly; saffron (Heb. *karkēm*), the stigmata of *Crocus sativus*, a native originally of Kashmir; *spikenard* (Heb. *nerd*), the root of the *Nardostachys Jatamansi* of Nepal and Bhutan; *stacte* (Heb. *natsaf*), generally referred to the *Styrax officinalis* of the Levant, but Hanbury has shown that no stacte or storax is now derived from *S. officinalis*, and that all that is found in modern commerce is the product of the *Liquidambar orientalis* of Cyprus and Anatolia. Besides these aromatic substances named in the Bible, the following must also be enumerated on account of their common use as incense in the East; benzoin or gum benjamin, first mentioned among Western writers by Ibn Batuta (1325-1349) under the name of *luānā d' Jati* (i.e. oilbanum of Java), corrupted in the parlance of Europe into benjamin and benzoin; camphor, produced by *Cinnamomum Camphora*, the "camphor laurel" of China and Japan, and by *Dryobalanops aromatica*, a native of the Indian Archipelago, and widely used as incense throughout the East, particularly in China; elemi, the resin of an unknown tree of the Philippine Islands, the oleum of old writers being the resin of *Boswellia Dalmanii*; gundarcion or dragon's blood, obtained from *Calamus Draco*, one of the ratan palms of the Indian Archipelago, *Dracaena Draco*, a biliateous plant of the Canary Island, and *Pterocarpus Draco*, a leguminous tree of the island of Socotra; rose-maloes, a corruption of the Javanese *rasamala*, or liquid storax, the resinous exudation of *Liquidambar Altingia*, a native of the Indian Archipelago (an American *Liquidambar* also produces a rose-maloes-like exudation); star anise, the starlike fruit of the *Illicium anisatum* of Yunnan and south-western China, burnt as incense in the temples of Japan; sweet flag, the root of *Acorus Calamus*, the *bach* of the Hindus, much used for incense in India. An aromatic earth, found on the coast of Dutch, is used as incense in the temples of western India. The animal excreta, musk and civet, also enter into the composition of modern European pastils and *clous fumants*. Balsam of Tolu, produced by *Myroxylon toluiferum*, a native of Venezuela and New Granada; balsam of Peru, derived from *Myroxylon Ptericeae*, a native of San Salvador in Central America; Mexican and Brazilian elemi, produced by various species of *Teica* or "incense trees," and the liquid exudation of an American species of *Liquidambar*, are all used as incense in America. Hanbury quotes a faculty granted by Pope Pius V. (August 2, 1571) to the bishops of the West Indies permitting the institution of a "Santo Sacrament" of Peru balsam of Peru in the preparation of the chrisam to be used by the Catholic Church in America. The *Sangre del drago* of the Mexicans is a resin resembling dragon's blood obtained from a euphorbiaceous tree, *Croton Draco*.

Probably nowhere can the actual historical progress from the primitive use of animal sacrifices to the later refinement of burning incense be more clearly traced than in the pages of the Old Testament, where no mention of the latter rite occurs before the period of the Mosaic legislation; but in the monuments of ancient Egypt the authentic traces of the use of incense that still exist carry us back to a much earlier date. From Meroe to Memphis the commonest subject carved or painted in the interiors of the temples is that of some contemporary Pharaoh or Pharaoh worshipping the presiding deity with oblations of

gold and silver vessels, rich vestments, gems, the firstlings of the flock and herd, cakes, fruits, flowers, wine, anointing oil and incense. Generally he holds in one hand the censer, and with the other casts the pastils or osselets of incense into it: sometimes he offers incense in one hand and makes the libation of wine with the other. One of the best known of these representations is that carved on the memorial stone placed by Tethmosis (Thothmes IV. (1533 B.C.) on the breast of the Sphinx at Gizeh.<sup>1</sup> The tablet represents Tethmosis before his guardian deity, the sun-god Rē, pouring a libation of wine on one side and offering incense on the other. The ancient Egyptians used various substances as incense. They worshipped Rē at sunrise with resin, at mid-day with myrrh and at sunset with an elaborate confection called *kuphi*, compounded of no fewer than sixteen ingredients, among which were honey, wine, raisins, resin, myrrh and sweet calamus. While it was being mixed, holy writings were read to those engaged in the operation. According to Plutarch, apart from its mystic virtues arising from the magical combination of 4X4, its sweet odour had a benign physiological effect on those who offered it.<sup>2</sup> The censer used was a hemispherical cup or bowl of bronze, supported by a long handle, fashioned at one end like an open hand, in which the bowl was, as it were, held, while the other end within which the pastils of incense were kept was shaped into the hawk's head crowned with a disk, as the symbol of Rē.<sup>3</sup> In embalming their dead the Egyptians filled the cavity of the belly with every sort of spicery except frankincense (Herod. ii. 86), for it was regarded as specially consecrated to the worship of the gods. In the burnt-offerings of male kine to Isis, the carcass of the steer, after evisceration, was filled with fine bread, honey, raisins, figs, frankincense, myrrh and other aromatics, and thus stuffed was roasted, being basted all the while by pouring over it large quantities of sweet oil, and then eaten with great festivity.

How important the consumption of frankincense in the worship of the gods became in Egypt is shown by two of its monuments, both of the greatest interest and value for the light they throw on the early history of the commerce of the Indian Ocean. One is an inscription in the rocky valley of Hammamat, through which the desert road from the Red Sea to the valley of Egypt opens on the green fields and palm groves of the river Nile near Coptos. It was cut on the rocks by an Egyptian nobleman named Hannu, who states that he was sent by Pharaoh Sankhkere, Menthoth IV., with a force gathered out of the Thebaid, from Coptos to the Red Sea, there to take command of a naval expedition to the Holy Land of Punt (Pooni), "to bring back odoriferous gums." Punt is identified with the Somali country, now known to be the native country of the trees that yield the bulk of the frankincense of commerce. The other bears the record of a second expedition to the same land of Punt, undertaken by command of Queen Hatshepsut, 1600 B.C. It is preserved in the vividly chiselled and richly coloured decorations portraying the history of the reign of this famous Pharaoh on the walls of the "Stage Temple" at Thebes. The temple is now in ruins, but the entire series of gorgeous pictures recording the expedition to "the balsam land of Punt," from its leaving to its returning to Thebes, still remains intact and undefaced.<sup>4</sup> These are the only authenticated instances of the export of incense trees from the Somali country until Colonel Playfair, then political agent at Aden, in 1862-1864, collected and sent to Bombay the specimens from which Sir George Birdwood prepared his descriptions of them for the Linnean Society in 1868. King Antigonos is said to have had a branch of the true frankincense tree sent to him.

Homer tells us that the Egyptians of his time were emphatically a nation of druggists (*Od. iv. 220, 230*). This characteristic, in which, as in many others, they so remarkably resemble the

<sup>1</sup> Brugsch, *Egypt under the Pharaohs*, i. 77-81, 414-419.

<sup>2</sup> Plutarch, *De Iside et Osiride*, c. 52. In Parthey's edition (Berlin, 1850) other recipes for the manufacture of *kuphi*, by Galen and Dioscorides, are given; also some results of the editor's own experiments.

<sup>3</sup> Wilkinson, *Ancient Egyptians*, i. 493; ii. 49, 398-400, 414-416.

<sup>4</sup> Brugsch, *Egypt under the Pharaohs*, i. 303-312.

Hindus, the Egyptians have maintained to the present day; and, although they have changed their religion, the use of incense among them continues to be as familiar and formal as ever. The *kohl* or black powder with which the modern, like the ancient, Egyptian ladies paint their languishing eyelids, is nothing but the smelt of charred frankincense, or other odoriferous resin brought with frankincense, and phials of water, from the well of Zem-zem, by the pilgrims returning from Mecca. They also melt frankincense as a depilatory, and smear their hands with a paste into the composition of which frankincense enters, for the purpose of communicating to them an attractive perfume. Herodotus (iv. 75) describes a similar artifice as practised by the women of Scythia (compare also Judith x. 3, 4). In cold weather the Egyptians warm their rooms by placing in them a brazier, "chafing-dish," or "standing-dish," filled with charcoal, whereon incense is burnt; and in hot weather they refresh them by occasionally swinging a hand censer by a chain through them—frankincense, benzoin and aloe wood being chiefly used for the purpose.<sup>1</sup>

In the authorized version of the Bible, the word "incense" translates two wholly distinct Hebrew words. In various passages in the latter portion of Isaiah (xl.-lxvi.), in Jeremiah and in Chronicles, it represents the Hebrew *lebānah*, more usually rendered "frankincense"; elsewhere the original word is *ketoreth* (Ex. xxx. 8, 9; Lev. x. 1; Num. vii. 14, &c.), a derivative of the verb *kittir* (Pi.) or *hikkir* (Hiph.), which verb is used, not only in Ex. xxx. 7, but also in Lev. i. 9, iii. 11, ix. 13, and many other passages, to denote the process by which the "savour of satisfaction" in any burnt-offering, whether of flesh or of incense, is produced. Sometimes in the authorized version (as in 1 Kings iii. 3; 1 Sam. ii. 28) it is made to mean explicitly the burning of incense with only doubtful propriety. The expression "incense (*ketoreth*) of rams" in Ps. lxxvi. 15 and the allusion in Ps. cxli. 2 ought both to be understood, most probably, of ordinary burnt-offerings.<sup>2</sup> The "incense" (*ketoreth*), or "incense of sweet scents" (*ketoreth sammim*), called, in Ex. xxx. 35, "a confection after the art of the apothecary," or rather "a perfume after the art of the perfumer," which was to be regarded as most holy, and the imitation of which was prohibited under the severest penalties, was compounded of four "sweet scents" (*sammim*),<sup>3</sup> namely stacte (*nataph*), onycha (*shehelek*), galbanum (*helbanah*) and "pure" or "fine" frankincense (*lebānah zaccah*), pounded together in equal proportions, with (perhaps) an admixture of salt (*memulāh*).<sup>4</sup> It was then to be "put before the testimony" in the "tent of meeting." It was burnt on the altar of incense by the priest every morning when the lamps were trimmed in the Holy Place, and every evening when they were lighted or "set up" (Ex. xxx. 7, 8). A handful of it was also burnt once a year in the Holy of Holies by the high priest on a pan of burning coals taken from the altar of burnt-offering (Lev. xvi. 12, 13). Pure frankincense (*lebānah*) formed part of the meat-offering (Lev. ii. 16, vi. 15), and was also presented along with the shew bread (Lev. xxiv. 7) every Sabbath day (probably on two golden saucers; see Jos. Ant. iii. 10, 7). The religious significance of the use of incense, or at least of its use in the Holy of Holies, is distinctly set forth in Lev. xvi. 12, 13.

The Jews were also in the habit of using odoriferous substances in connexion with the funeral obsequies of distinguished persons (see 2 Chron. xvi. 14, xxi. 19; Jer. xxxiv. 5). In Amos vi. 10 "he that burneth him" probably means "he that burns perfumes in his honour." References to the domestic use of incense occur in Cant. iii. 6; Prov. xxvii. 9; cf. vii. 17.

The "marbles" of Nineveh furnish frequent examples of the offering of incense to the sun-god and his consort (2 Kings

xxiii. 5). The kings of Assyria united in themselves the royal and priestly offices, and on the monuments they erected they are generally represented as offering incense and pouring out wine to the Tree of Life. They probably carried the incense in the sacred bag so frequently seen in their hands and in those also of the common priests. According to Herodotus (i. 183), frankincense to the amount of 1000 talents' weight was offered every year, during the feast of Bel, on the great altar of his temple in Babylon.

The monuments of Persepolis and the coins of the Sassanians show that the religious use of incense was as common in ancient Persia as in Babylonia and Assyria. Five times a day the priests of the Persians (Zoroastrians) burnt incense on their sacred fire altars. In the Avesta (*Vendidad*, Fargard xix. 24, 40), the incense they used is named *vohu gaono*. It has been identified with benzoin, but was probably frankincense. Herodotus (iii. 97) states that the Arabs brought every year to Darius as tribute 1000 talents of frankincense. The Parsees still preserve in western India the pure tradition of the ritual of incense as followed by their race from probably the most ancient times.

The *Ramayana* and *Mahabharata* afford evidence of the employment of incense by the Hindus, in the worship of the gods and the burning of the dead, from the remotest antiquity. Its use was obviously continued by the Buddhists during the prevalence of their religion in India, for it is still used by them in Nepal, Tibet, Ceylon, Burma, China and Japan. These countries all received Buddhism from India, and a large proportion of the porcelain and earthenware articles imported from China and Japan into Europe consists of innumerable forms of censers. The Jains all over India burn sticks of incense before their Jina. The commonest incense in ancient India was probably frankincense. The Indian frankincense tree, *Boswellia thurifera*, Colebrooke (which certainly includes *B. glabra*, Roxburgh), is a doubtful native of India. It is found chiefly where the Buddhist religion prevailed in ancient times, in Bihar and along the foot of the Himalayas and in western India, where it particularly flourishes in the neighbourhood of the Buddhist caves at Ajanta. It is quite possible therefore that, in the course of their widely extended commerce during the one thousand years of their ascendancy, the Buddhists imported the true frankincense trees from Africa and Arabia into India, and that the accepted Indian species are merely varieties of them. Now, however, the incense in commonest use in India is benzoin. But the consumption of all manner of odoriferous resins, gum resins, roots, woods, dried leaves, flowers, fruits and seeds in India, in social as well as religious observances, is enormous. The grateful perfumed powder *abir* or *randa* is composed either of rice, flour, mango bark or deodar wood, camphor and aniseed, or of sandalwood or wood aloes, and zerumbet, zedoary, rose flowers, camphor and civet. The incense sticks and pastils known all over India under the names of *ud-butī* ("benzoin-light") or *aggar-ki-butī* ("wood aloes light") are composed of benzoin, wood aloes, sandalwood, rock lichen, patchouli, rose-maloes, *laisispāt* (the leaf of *Fiacourtia Cataphracta* of Roxburgh), mastic and sugar-candy or gum. The *abir* and *aggar butis* made at the Mahomedan city of Bijapur in the Mahratta country are celebrated all over western India. The Indian Mussulmans indeed were rapidly degenerating into a mere sect of Hindus before the Wahabi revival, and the more recent political propaganda in support of the false caliphate of the sultans of Turkey; and we therefore find the religious use of incense among them more general than among the Mahomedans of any other country. They use it at the ceremonies of circumcision, *bismillah* (teaching the child "the name of God"), virginity and marriage. At marriage they burn benzoin with *nim* seeds (*Media Azadirachta*, Roxburgh) to keep off evil spirits, and prepare the bride-cakes by putting a quantity of benzoin between layers of wheat dough, closed all round, and frying them in clarified butter. For days the bride is fed on little else. In their funeral ceremonies, the moment the spirit has fled incense is burnt before the corpse until it is carried out to be buried. The begging fakirs also go

<sup>1</sup> See Lane, *Mod. Egyptians*, pp. 34, 41, 139, 187, 438 (ed. 1860).

<sup>2</sup> See Wellhausen, *Gesch. Israels*, i. 70 sqq., who from philological and other data infers the late date of the introduction of incense into the Jewish ritual.

<sup>3</sup> According to Philo (*Opera*, i. 504, ed. Mangey), they symbolized respectively water, earth, air and fire.

<sup>4</sup> Other accounts of its composition, drawn from Rabbinical sources, will be found in various works on Jewish antiquities; see, for example, Reland, *Antiq. Sacr. vcl. Hebr.* pp. 39-41 (1712).

about with a lighted stick of incense in one hand, and holding out with the other an incense-holder (literally, "incense chariot"), into which the coins of the pious are thrown. Large "incense trees" resembling our Christmas trees, formed of incense-sticks and pastils and osselets, and alight all over, are borne by the Shah Mussulmans in the solemn procession of the Mohurrum, in commemoration of the martyrdom of the sons of Ali. The worship of the *tulsi* plant, or holy basil (*Ocymum sanctum*, Don), by the Hindus is popularly explained by its consecration to Vishnu and Krishna. It grows on the four-horned altar before the house, or in a pot placed in one of the front windows, and is worshipped every morning by all the female members of every Hindu household. It is possible that its adoration has survived from the times when the Hindus buried their dead in their houses, beneath the family hearth. When they came into a hot climate the fire of the sacrifices and domestic cookery was removed out of the house; but the dead were probably still for a while buried in or near it, and the *tulsi* was planted over their graves, at once for the salubrious fragrance it diffuses and to represent the burning of incense on the altar of the family Lar. The rich land round about the holy city of Pandharpur, sacred to Vitthoba the national Mahattrata form of (Krishna)-Vishnu, is wholly restricted to the cultivation of the *tulsi* plant.

As to the *thuya* mentioned in Homer (*Il.* ix. 499, and elsewhere) and in Hesiod (*Works and Days*, 338), there is some uncertainty whether they were incense offerings at all, and if so, whether they were ever offered alone, and not always in conjunction with animal sacrifices. That the domestic use, however, of the fragrant wood *thyon* (the *Arbor vitee* or *Callitris quadrivalvis* of botanists, the source of the resin sandarach) was known in the Homeric age, is shown by the case of Calypso (*Od.* v. 60), and the very similarity of the word *thyon* to *thyon* may be taken as almost conclusively proving that by that time the same wood was also employed for religious purposes. It is not probable that the sweet-smelling gums and resins of the countries of the Indian Ocean began to be introduced into Greece before the 8th or 7th century B.C., and doubtless *λίβανος* or *λίβανωρίς* first became an article of extensive commerce only after the Mediterranean trade with the East had been opened up by the Egyptian king Psammetichus (c. 664-610 B.C.). The new Oriental word is frequently employed by Herodotus; and there are abundant references to the use of the thing among the writers of the golden age of Attic literature (see, for example, Aristophanes, *Plut.* 1114; *Frogs*, 871, 888; *Clouds*, 426; *Wasps*, 96, 861). Frankincense, however, though the most common, never became the only kind of incense offered to the gods among the Greeks. Thus the Orphic hymns are careful to specify, in connexion with the several deities celebrated, a great variety of substances appropriate to the service of each; in the case of many of these the selection seems to have been determined not at all by their fragrance but by some occult considerations which it is now difficult to divine.

Among the Romans the use of religious fumigations long preceded the introduction of foreign substances for the purpose (see, for example, Ovid, *Fast.* i. 337 seq., "Et non exiguo laurus adusta sono"). Latterly the use of frankincense ("mascula thura," *Virg. Ecl.* viii. 65) became very prevalent, not only in religious ceremonies, but also on various state occasions, such as in triumphs (Ovid, *Trist.* iv. 2, 4), and also in connexion with certain occurrences of domestic life. In private it was daily offered by the devout to the *Lar familiaris* (Plaut. *Aulul.* prof. 23); and in public sacrifices it was not only sprinkled on the head of the victim by the pontifex before its slaughter, and afterwards mingled with its blood, but was also thrown upon the flames over which it was roasted.

No perfectly satisfactory traces can be found of the use of incense in the ritual of the Christian Church during the first four centuries.<sup>1</sup> It obviously was not contemplated by the

author of the epistle to the Hebrews; its use was foreign to the synagogue services on which, and not on those of the temple, the worship of the primitive Christians is well known to have been originally modelled; and its associations with heathen solemnities, and with the evil repute of those who were known as "thurificati," would still further militate against its employment. Various authors of the ante-Nicene period have expressed themselves as distinctly unfavourable to its religious, though not of course to its domestic, use. Thus Tertullian, while (*De Cor. Mil.* 10) ready to acknowledge its utility in countering unpleasant smells ("si me odor alicujus loci offenderit, Arabiæ aliquid incendio"), is careful to say that he scorns to offer it as an accompaniment to his heartfelt prayers (*Apol.* 30; cf. 42). Athenagoras also (*Legat.* 13) gives distinct expression to his sense of the needlessness of any such ritual ("the Creator and Father of the universe does not require blood, nor smoke, nor even the sweet smell of flowers and incense"); and Arnobius (*Adv. Gent.* vii. 26) seeks to justify the Christian neglect of it by the fact, for which he vouches, that among the Romans themselves incense was unknown in the time of Numa, while the Etruscans had always continued to be strangers to it. Cyril of Jerusalem, Augustine and the Apostolic Constitutions make no reference to any such feature either in the public or private worship of the Christians of that time. The earliest mention, it would seem, occurs in the Apostolic Canons (can. 3), where the *θυμία* is spoken of as one of the requisites of the eucharistic service. It is easy to perceive how it should inevitably have come in along with the whole circle of ideas involved in such words as "temple," "altar," "priest," which about this time came to be so generally applied in ecclesiastical connexions. Evagrius (vi. 21) mentions the gift of a *θεοσπάρθιον* by the contemporary Chosroes of Persia to the church of Jerusalem; and all the Oriental liturgies of this period provide special prayers for the thurification of the eucharistic elements. The oldest *Ordo Romanus*, which perhaps takes us back to within a century of Gregory the Great, enjoins that in pontifical masses a sub-deacon, with a golden censer, shall go before the bishop as he leaves the secretarium for the choir, and two, with censers, before the deacon gospeller as he proceeds with the gospel to the ambo. And less than two centuries afterwards we read an order in one of the capitularies of Hincmar of Reims, to the effect that every priest ought to be provided with a censer and incense. That in this portion of their ritual, however, the Christians of that period were not universally conscious of its direct descent from Mosaic institutions may be inferred perhaps from the "benediction of the incense" used in the days of Charlemagne, which runs as follows: "May the Lord bless this incense to the extinction of every noxious smell, and kindle it to the odour of its sweetness." Even Thomas Aquinas (p. iii. qu. 83, art. 5) gives prominence to this idea.

The character and order of these historical notices of incense would certainly, were there nothing else to be considered, justify the conclusion hitherto generally adopted, that its use was wholly unknown in the worship of the Christian Church before the 5th century. On the other hand, we know that in the first Christian services held in the catacombs under the city of Rome, incense was burnt as a sanitary fumigation at least. Tertullian also distinctly alludes to the use of aromatics in Christian burial: "the Sabeans will testify that more of their merchandise, and that more costly, is lavished on the burial of Christians, than in burning incense to the gods." And the whole argument from analogy is in favour of the presumption of the ceremonial use of incense by the Christians from the first. It is natural that little should be said of so obvious a practice until the fuller development of ritual in a later age. The slighting references to it by the Christian fathers are no more an argument against its existence in the primitive church than the similar denunciations by the Jewish prophets of burnt-offerings and sacrifices are any proof that there were no such rites as the offering of incense, and of the blood of bulls and fat of rams, in the worship of the temple at Jerusalem. There could be no real offence to Christians in the burning of incense. Malachi (i. 11) had already

<sup>1</sup>This guarded statement still holds good. Compare Duchesne, *Christian Worship* (Eng. trans., 1904), ch. ii., "The Mass in the East," v. "The Books of the Latin Rite," and xii. "The Dedication of Churches."

foretold the time when among the Gentiles, in every place, incense should be offered to God. Gold, with myrrh and frankincense were offered by the Persian Magi to the infant Jesus at his birth; and in Revelation viii. 3, 4, the image of the offering of incense with the prayers of the saints, before the throne of God, is not without its significance. If also the passage in Ambrose of Milan (on Luke i. 11), where he speaks of "us" as "adolentes altaria" is to be translated "incensing the altars," and taken literally, it is a testimony to the use of incense by the Christian Church in, at least, the 4th century. But the earliest express mention of the censuring of the altar by Christian priests is in "the works," first quoted in the 6th century, attributed to "Dionysius the Areopagite," the contemporary of St Paul (Acts xvii. 34).

The Missal of the Roman Church now enjoins incensation before the introit, at the gospel and again at the offertory, and at the elevation, in every high mass; the use of incense also occurs at the exposition of the sacrament, at consecrations of churches and the like, in processions, in the office for the burial of the dead and at the exhibition of relics. On high festivals the altar is censured at vespers and lauds.

In the Church of England the use of incense was gradually abandoned after the reign of Edward VI., until the ritualistic revival of the present day. Its use, however, has never been abolished by law. A "Form for the Consecration of a Censer" occurs in Sancroft's *Form of Dedication and Consecration of a Church or Chapel* (1685). In various works of reference (as, for example, in *Notes and Queries*, 3rd ser. vol. viii. p. 11) numerous sporadic cases are mentioned in which incense appears to have been burnt in churches; the evidence, however, does not go so far as to show that it was used during divine service, least of all that it was used during the communion office. At the coronation of George III., one of the king's grooms appeared "in a scarlet dress, holding a perfuming pan, burning perfumes, as at previous coronations."

In 1890, on the appeal of the Rev. H. Westall, St Cuthbert's, London, and the Rev. E. Ram, St John's, Norwich, against the use of incense in the Church of England, the archbishops of Canterbury (Dr Temple) and York (Dr MacLagan) supported the appeal. Their decision was reviewed by Chancellor L. T. Dibdin in the 10th edition of the *Encyclopaedia Britannica*, and the exposition given by Sir Lewis Dibdin of the whole question of the use of incense in the Church of England may here be interpolated. (G. B.)

*Incense in the Church of England.*—Mr Scudamore (*Notitia Eucharistica*, 2nd ed. pp. 141-142) thus describes the method and extent of the employment of incense at the mass prior to the Reformation:—

"According to the use of Sarum (and Bangor) the priest, after being himself censured by the deacon, censured the altar before the Introit began. The York rubric directed him to do it immediately after the first saying of the Introit, which in England was thrice said. The Hereford missal gives no direction for censuring the altar at that time. The middle of the altar was censured, according to Sarum, Bangor and Hereford, before the reading of the Gospel. According to Sarum and Bangor, the thurible, as well as the lights, attended the Gospel to the lectern. Perhaps the York rubric implies that this was done when it orders (which the others do not) the thurible to be carried round the choir with the Gospel while the Creed was being sung. In the Sarum and Bangor, the priest censured the oblations after offering them; then the space between himself and the altar. He was then, at Sarum, censured by the deacon, and an acolyte censured the choir; at Bangor the *Singistrum Cornu* of the altar and the relics were censured instead. York and Hereford ordered no censuring at the offertory. There is reason to think that, notwithstanding the order for the use of incense at every celebration, it was in practice burnt only on high festivals, and then only in rich churches, down to the period of the Reformation. In most parishes its costliness alone would preclude its daily use, while the want of an assistant minister would be a very common reason for omitting the rite almost everywhere. Incense was not burnt in private masses, so that the clergy were accustomed to celebrations without it, and would naturally forego it on any plausible ground.

The ritual of the mass remained unchanged until the death of Henry VIII. (Jan. 28, 1547). In March 1548 the *Order of the Communion* was published and commanded to be used

by royal proclamation in the name of Edward VI. It was the precursor of the Prayer Book, and supplemented the accustomed Latin service by additions in English to provide for the communion of the people in both kinds. But it was expressly stated in a rubric that the old service of the mass was to proceed without variation of any rite or ceremony until after the priest had received the sacrament, that is, until long after the last of the three occasions for the use of incense explained above. But on Whitsunday 1540 the first Prayer Book of Edward VI. came into use under an Act of Parliament (2 and 3 Ed. VI. ch. 1, the first Act of Uniformity) which required its exclusive use in public worship so as to supersede all other forms of service. Another Act, 3 and 4 Ed. VI. ch. 10, required the old service books to be delivered up to be destroyed. The first Prayer Book does not contain any direction to use or any mention of incense. It has been and still is a keenly controverted question whether incense did or did not continue to be in ceremonial use under the first Prayer Book or during the rest of Edward VI.'s reign. No evidence has hitherto been discovered which justifies us in answering this question in the affirmative. The second Prayer Book of Edward VI. (1552), published under the authority of the second Act of Uniformity (5 and 6 Ed. VI. ch. 1), contains no reference to incense. Edward VI. died on the 6th July 1553. Queen Mary by statute (1 Mary, sess. 2, ch. 2) abolished the Prayer Book, repealed the Acts of Uniformity and restored "divine service and administration of sacraments as were most commonly used in England in the last year of Henry VIII." The ceremonial use of incense thus became again an undoubted part of the communion service in the Church of England. A proclamation issued (December 6, 1553) directed the churchwardens to obtain the proper ornaments for the churches; and the bishops (at any rate Bishop Bonner, see *Visitation Articles 1554*, Cardwell's *Doc. Ann.* i. 149-153) in their visitations inquired whether censers had been furnished for use. Mary died on the 17th of November 1558. On the 24th of June 1559 the second Prayer Book of Edward VI. (with a few alterations having no reference to incense) was again established, under the authority of the third Act of Uniformity (1 Eliz. ch. 2), as the exclusive service book for public service. There is no evidence of the ceremonial use of incense under Elizabeth's Prayer Book, or under the present Prayer Book of 1662 (established by the fourth Act of Uniformity, 13 and 14 Charles II. ch. 4) until the middle of the 19th century; and there is no doubt that as a ceremony of divine worship, whether at the Holy Communion or at other services, it was entirely disused. There are, however, a good many instances recorded of what has been called a fumigatory use of frankincense in churches, by which it was sought to purify the air, in times of public sickness, or to dispel the foulness caused by large congregations, or poisonous gases arising from ill-constructed vaults under the church floor. It seems also to have been used for the purpose of creating an agreeable perfume on great occasions, e.g. the great ecclesiastical feasts. But this use of incense must be carefully distinguished from its ceremonial use. It was utilitarian and not symbolical, and from the nature of the purpose in view must have taken place before, rather than during, service. Of the same character is the use of incense carried in a perfuming pan before the sovereign at his coronation in the procession from Westminster Hall to the Abbey. This observance was maintained from James II.'s coronation to that of George III. In the general revival of church ceremonial which accompanied and followed the Oxford Movement incense was not forgotten, and its ceremonial use in the pre-Reformation method has been adopted in a few extreme churches since 1850. Its use has been condemned as an illegal ceremony by the ecclesiastical courts. In 1868 Sir Robert Phillimore (Dean of the Arches) pronounced the ceremonial use of incense to be illegal in the suit of *Martin v. Mackonochie* (2 A. and E. L.R. 116). The case was carried to the Privy Council on appeal, but there was no appeal on the question of incense. Again, in 1870, the ceremonial use of incense was condemned by Sir Robert Phillimore in the suit of *Sumner v. Wix* (3 A. and E. L.R. 58).

Notwithstanding these decisions, it was insisted by those who defended the revival of the ceremonial use of incense that it was a legal custom of the Church of England. The question was once more elaborately argued in May 1809 before an informal tribunal consisting of the archbishop of Canterbury (Dr. Temple) and the archbishop of York (Dr. Maclagan), at Lambeth Palace. On the 31st of July 1809 the archbishops decided that the liturgical use of incense was illegal. The Lambeth "opinion," as it was called, failed to convince the clergy against whom it was directed any better than the judgments of the ecclesiastical courts, but at first a considerable degree of obedience to the archbishops' view was shown. Various expedients were adopted, as, e.g., the use of incense just before the beginning of service, by which it was sought to retain incense without infringing the law as laid down by the archbishops. There remained, nevertheless, a tendency on the part of the clergy who used incense, or desired to do so, to revert to the position they occupied before the Lambeth hearing—that is, to insist on the ceremonial use of incense as a part of the Catholic practice of the Church of England which it is the duty of the clergy to maintain, notwithstanding the decisions of ecclesiastical judges or the opinions of archbishops to the contrary. (L. T. D.)

*Manufacture.*—For the manufacture of the incense now used in the Christian churches of Europe there is no fixed rule. The books of ritual are agreed that Ex. xxx. 34 should be taken as a guide as much as possible. It is recommended that frankincense should enter as largely as possible into its composition, and that if inferior materials be employed at all they should not be allowed to preponderate. In Rome olibanum alone is employed; in other places benzoin, storax, lign, aloes, cascarilla bark, cinnamon, cloves and musk are all said to be occasionally used. In the Russian Church, benzoin is chiefly employed. The Armenian liturgy, in its benediction of the incense, speaks of "this perfume prepared from myrrh and cinnamon."

The preparation of pastils of incense has probably come down in a continuous tradition from ancient Egypt, Babylonia and Phoenicia. Cyprus was for centuries famous for their manufacture, and they were still known in the middle ages by the names of pastils or osselets of Cyprus.

Maimonides, in his *More Nevochim*, states that the use of incense in the worship of the Jews originated as a corrective of the disagreeable odours arising from the slaughter and burning of the animals offered in sacrifice. There can be no doubt that its use throughout the East is based on sanitary considerations; and in Europe even, in the time when the dead were buried in the churches, it was recognized that the burning of incense served essentially to preserve their salubrity. But evidently the idea that the odour of a burnt-offering (cf. the *κωστής ἡδίστος ἀνθρώπου* of *Odys.* xii. 369) is grateful to the deity, being indeed the most essential part of the sacrifice, or at least the vehicle by which alone it can successfully be conveyed to its destination, is also a very early one, if not absolutely primitive; and survivals of it are possibly to be met with even among the most highly cultured peoples where the purely symbolical nature of all religious ritual is most clearly understood and maintained. Some such idea plainly underlies the familiar phrase "a sweet savour," more literally "a savour of satisfaction," whereby an acceptable offering by fire is so often denoted in the Bible (*Gen.* viii. 21; *Lev.* i. 9, *et passim*; cf. *Eph.* v. 2). It is easy to imagine how, as men grew in sensuous appreciation of pleasant perfumes, and in empirical knowledge of the sources from which these could be derived, this advance would naturally express itself, not only in their domestic habits, but also in the details of their religious ceremonial, so that the custom of adding some kind of incense to their animal sacrifices, and at length that of offering a pure and simple, would inevitably arise. Ultimately, with the development of the spiritual discernment of men, the "offering of incense" became a mere symbolical phrase for prayer (see *Rev.* v. 8, viii. 3, 4). Clement of Alexandria expresses this in his well-known words: "The true altar of incense is the just soul, and the perfume from it is holy prayer." (So also Origen, *Cont. Cels.* viii. 17, 20.) The ancients were familiar with

the sanitary efficacy of fumigations. The energy with which Ulysses, after the slaughter of the suitors, calls to Euryclea for "fire and sulphur" to purge (literally "fumigate") the dining-hall from the pollution of their blood (*Od.* xxii. 481, 482) would startle those who imagine that sanitation is a peculiarly modern science. There is not the slightest doubt that the censuring of things and persons was first practised as an act of purification, and thus became symbolical of consecration, and finally of the sanctification of the soul. The Egyptians understood the use of incense as symbolical of the purification of the soul by prayer. Catholic writers generally treat it as typifying contrition, the preaching of the Gospel, the prayers of the faithful and the virtues of the saints. (G. B.)

**INCEST** (Lat. *incestus*, unchaste), sexual intercourse between persons so related by kindred or affinity that legal marriage cannot take place between them (see MARRIAGE, especially the section *Canon Law*). In England incest formerly was not generally treated as a crime, although, along with other offences against morals, it was made punishable by death in 1650. Since the Restoration it had, to use Blackstone's phrase, been left to the "feeble coercion of the spiritual courts," but bills to make it a criminal offence have at various times been unsuccessfully introduced in Parliament. In 1908 however, an act (The Punishment of Incest Act 1908) was passed, under which sexual intercourse of a male with his grand-daughter, daughter, sister or mother is made punishable with penal servitude for not less than 3 or more than 7 years, or with imprisonment for not more than two years with or without hard labour. It is immaterial that the sexual intercourse was had with the consent of the female; indeed, by s. 2 a female who consents is on conviction liable to the same punishment as the male. The act also makes an attempt to commit the offence of incest a misdemeanour, punishable by imprisonment for not more than two years with or without hard labour. The terms "brother" and "sister" include half-brother and half-sister, whether the relationship is or is not traced through lawful wedlock. All proceedings under the act are held *in camera* (s. 5). The act does not apply to Scotland, incest being punishable in Scots law. Under the Matrimonial Causes Act 1857, s. 27, incestuous adultery is *per se* sufficient ground to entitle a wife to divorce her husband. The Deceased Wife's Sister's Marriage Act 1907, s. 3, retained wives' sisters in the class of persons with whom adultery is incestuous. In the law of Scotland, it was, until the Criminal Procedure (Scotland) Act 1887, a crime nominally punishable with death, but the penalty usually inflicted was penal servitude for life. This sentence was actually pronounced on a man in 1855. In the United States incest is not an indictable offence at common law, but, generally speaking, it has been made punishable by fine and imprisonment by state legislation. It is also a punishable offence in some European countries, notably Germany, Austria and Italy.

**INCH** (O. Eng. *ynce* from Lat. *uncia*, a twelfth part; cf. "ounce," and see AS), the twelfth part of a linear foot. As a measure of rainfall an "inch of rain" is equivalent to a fall of a gallon of water spread over a surface of about 2 sq. ft., or 100 tons to an acre.

**INCHBALD, MRS ELIZABETH** (1753-1821), English novelist, playwright and actress, was born on the 15th of October 1753 at Standingfield, Suffolk, the daughter of John Simpson, a farmer. Her father died when she was eight years old. She and her sisters never enjoyed the advantages of school or of any regular supervision in their studies, but they seem to have acquired refined and literary tastes at an early age. Ambitious to become an actress, a career for which an impediment in her speech hardly seemed to qualify her, she applied in vain for an engagement; and finally, in 1772, she abruptly left home to seek her fortune in London. Here she married Joseph Inchbald (d. 1779), an actor, and on the 4th of September made her debut in Bristol as Cordelia, to his Lear. For several years she continued to act with him in the provinces. Her rôles included Anne Boleyn, Jane Shore, Calista, Calpurnia, Lady Anne in *Richard III.*, Lady Percy, Lady Elizabeth Grey, Fanny in

*The Clandestine Marriage*, Desdemona, Aspasia in *Tamerlane*, Juliet and Imogen; but notwithstanding her great beauty and her natural aptitude for acting, her inability to acquire rapid and easy utterance prevented her from attaining to more than very moderate success. After the death of her husband she continued for some time on the stage; making her first London appearance at Covent Garden as Bellario in *Philostratus* on the 3rd of October 1780. Her success, however, as an author led her to retire in 1789. She died at Kensington House on the 1st of August 1821.

Mrs. Inchbald wrote or adapted nineteen plays, and some of them, especially *Wives as They Were and Maids as They Are* (1797), were for a time very successful. Among the others may be mentioned *I'll tell you What* (translated into German, Leipzig, 1798); *Such Things Are* (1788); *The Married Man*; *The Wedding Day*; *The Midnight Hour*; *Everyone has his Fault*; and *Lover's Vows*. She also edited a collection of the *British Theatre*, with biographical and critical remarks (25 vols., 1806-1809); a *Collection of Farces* (7 vols., 1809); and *The Modern Theatre* (10 vols., 1809). Her fame, however, rests chiefly on her two novels: *A Simple Story* (1791), and *Nature and Art* (1796). These works possess many minor faults and inaccuracies, but on the whole their style is easy, natural and graceful; and if they are tainted in some degree by a morbid and exaggerated sentiment, and display none of that faculty of creation possessed by the best writers of fiction, the pathetic situations, and the deep and pure feeling pervading them, secured for them a wide popularity.

Mrs. Inchbald destroyed an autobiography for which she had been offered £1000 by Phillips the publisher; but her *Memoirs*, compiled by J. Boaden, chiefly from her private journal, appeared in 1833 in two volumes. An interesting account of Mrs. Inchbald is contained in *Records of a Girlhood*, by Frances Ann Kemble (1878). Her portrait was painted by Sir Thomas Lawrence.

**INCHQUIN, MURROUGH O'BRIEN, 1ST EARL OF** (c. 1614-1674), Irish soldier and statesman, was the son of Dermot O'Brien, 5th Baron Inchiquin (d. 1624). He belonged to a great family which traced its descent to Brian Boroiimhe, king of Ireland, and members of which were always to the forefront in Irish public life. The first baron of Inchiquin was another Murrough O'Brien (d. 1551) who, after having made his submission to Henry VIII., was created baron of Inchiquin and earl of Thomond in 1543. When Murrough died in November 1557 by a curious arrangement his earldom passed to his nephew Donogh, son of Conor O'Brien (d. 1539), the last independent prince of Thomond (see THOMOND, EARLS OF), leaving only his barony to be inherited by his son Dermot (d. 1557), the ancestor of the later barons of Inchiquin.

Murrough O'Brien, who became 6th baron of Inchiquin in 1624, gained some military experience in Italy, and then in 1640 was appointed vice-president of Munster. He took an active and leading part in suppressing the great Irish rebellion which broke out in the following year, and during the Civil War the English parliament made him president of Munster. Early in 1648, however, he declared for his former master Charles I., and for about two years he sought to uphold the royalist cause in Ireland. In 1654 Charles II. made him an earl. His later years were partly spent in France and in Spain, but he had returned to Ireland when he died on the 9th of September 1674.

His son William, the 2nd earl (c. 1638-1692), served under his father in France and Spain, and for six years was governor of Tangier. He was a partisan of William III. in Ireland, and in 1690 he became governor of Jamaica where he died in January 1692. In 1800 his descendant Murrough, the 5th earl (d. 1808), was created marquis of Thomond, but on the death of James, the 3rd marquis, in July 1855 both the marquessate and the earldom became extinct. The barony of Inchiquin, however, passed to a kinsman, Sir Lucius O'Brien, Bart. (1800-1872), a descendant of the first baron and a brother of William Smith O'Brien (q.v.).

**INCLEDON, CHARLES BENJAMIN** (1763-1826), English singer, son of a doctor in Cornwall, began as a choir-boy at Exeter, but then went into the navy. His fine tenor voice,

however, attracted general attention, and in 1783 he determined to seek his fortune on the stage. After various provincial appearances he made a great success in 1790 at Covent Garden, and thenceforth was the principal English tenor of his day. He sang both in opera and in oratorio, but his chief popularity lay in his delivery of ballads, such as "Sally in our Alley," "Black-eyed Susan," "The Arethusa," and anything of a bold and manly type. He toured in America in 1817; and on retiring in 1822 from the operatic stage, he travelled through the provinces with an entertainment called "The Wandering Melodist." He died of paralysis at Worcester on the 11th of February 1826.

**INCLINOMETER (DIP CIRCLE).** Two distinct classes of instruments are used for measuring the dip (see MAGNETISM, TERRESTRIAL) or inclination of the earth's magnetic field to the horizontal, namely (1) dip circles, and (2) induction inclinometers or earth inductors.

*Dip Circles.*—In the case of the dip circle the direction of the earth's magnetic field is obtained by observing the position of the axis of a magnetized needle so supported as to be free to turn about a horizontal axis passing through its centre of

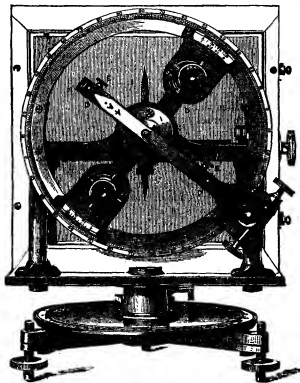

gravity. The needles now used consist of flat lozenge-shaped pieces of steel about 9 cm. long and 0.1 cm. thick, and weigh about 4.1 grams. The axle, which is made of hard steel, projects on either side of the needle and has a diameter of about 0.05 cm. Needles considerably larger than the above have been used, but experience showed that the values for the dip observed with needles 23 cm. long, was about 1° less than with the 9 cm. needles, and A. Schuster (*Phil. Mag.*, 1891 [5], 31, p. 275) has shown that the difference is due to the appreciable bending of the longer needles owing to their weight.

When in use the dip needle is supported on two agate knife-edges, so that its axle is on the axis of a vertical divided circle, on which the positions of the ends of the needle are either directly observed by means of two reading lenses, in which case the circle is generally divided into thirds of a degree so that it can be estimated by read to about two minutes, or a cross arm carries two small microscopes and two verniers, the cross wires of each microscope being adjusted so as to bisect the image of the corresponding end of the needle. Two V-shaped lifters actuated by a handle serve to raise the needle from the agates, and when lowered assure the axle being at the centre of the vertical circle.

The supports for the needle, and a box to protect the needle from draughts, as well as the vertical circle, can be rotated about a vertical axis, and their azimuth read off on a horizontal divided circle. There are also two adjustable stops which can be set in any position, and allow the upper part of the instrument to be rotated through exactly  $180^\circ$  without the necessity of reading the horizontal circle.

When making a determination of the dip with the dip circle, a number of separate readings have to be made in order to eliminate various instrumental defects. Thus, that side of the needle on which the number is engraved being called the face of the needle, and that side of the protecting box next the vertical circle the face of the instrument, both ends of the needle are observed in the following relative positions, the instrument being in every case so adjusted in azimuth that the axle of the needle points magnetic east and west:—

- i. Face of instrument east and face of needle next to face of instrument;
- ii. Face of instrument west and face of needle next to face of instrument;
- iii. Face of instrument west and face of needle away from face of instrument;
- iv. Face of instrument east and face of needle away from face of instrument.

Next the direction of magnetization of the needle is reversed by stroking it a number of times with two strong permanent magnets, when the other end of the needle dips and the above four sets of readings are repeated. The object in reading both ends of the needle is to avoid error if the prolongation of the axle of the needle does not pass through the centre of the vertical circle, as also to avoid error due to the eccentricity of the arm which carries the reading microscopes and verniers. The reversal of the instrument between (i.) and (ii.) and between (iii.) and (iv.) is to eliminate errors due to (a) the line joining the zeros of the vertical circle not being exactly horizontal, and (b) the agate knife-edges which support the needle not being exactly horizontal. The reversal of the needle between (ii.) and (iii.) is to eliminate errors due to (a) the magnetic axis of the needle not coinciding with the line joining the two points of the needle, and (b) to the centre of gravity of the needle being displaced from the centre of the axle in a direction at right angles to the length of the needle. The reversal of the poles of the needle is to counteract any error produced by the centre of gravity of the needle being displaced from the centre of the axle in a direction parallel to the length of the needle.

For use at sea the dip circle was modified by Robert Were Fox (*Annals of Electricity*, 1839, 3, p. 288), who used a needle having pointed axles, the points resting in jewelled holes carried by two uprights, so that the movement of the ship does not cause the axle of the needle to change its position with reference to the vertical divided circle. To counteract the tendency of the axle to stick in the bearings, the instrument is fitted with a knob on the top of the box protecting the needle, and when a reading is being taken this knob is rubbed with an ivory or horn disk, the surface of which is corrugated. In this way a tremor is caused which is found to assist the needle in overcoming the effects of friction, so that it takes up its true position. In the Creak modification of the Fox dip circle, the upper halves of the jewels which form the bearings are cut away so that the needle can be easily removed, and thus the reversals necessary when making a complete observation can be performed (see also MAGNETO-METER).

*Induction Inclinerometers.*—The principle on which induction inclinometers depend is that if a coil of insulated wire is spun about a diameter there will be an alternating current induced in the coil, unless the axis about which it turns is parallel to the lines of force of the earth's field. Hence if the axis about which such a coil spins is adjusted till a sensitive galvanometer connected to the coil through a commutator, by which the alternating current is converted into a direct current, is undeflected, then the axis must be parallel to the lines of force of the earth's field, and hence the inclination of the axis to the horizontal is dip. The introduction and perfection of this type of inclinometer

is almost entirely due to H. Wild. His form of instrument for field observations<sup>1</sup> consists of a coil 10 cm. in diameter, containing about 1000 turns of silk-covered copper wire, the resistance being about 40 ohms, which is pivoted inside a metal ring. This ring can itself rotate about a horizontal axle in its own plane, this axle being at right angles to that about which the coil can rotate. Attached to the axle of the ring is a divided circle, by means of which and two reading microscopes the inclination of the axis of rotation of the coil to the horizontal can be read. The bearings which support the horizontal axle of the ring are mounted on a horizontal annulus which can be rotated in a groove attached to the base of the instrument, as so to allow the azimuth of the axle of the ring, and hence also that of the plane in which the axis of the coil can move, to be adjusted. The coil is rotated by means of a flexible shaft worked by a small cranked handle and a train of gear wheels. The terminals of the coil are taken to a two-part commutator of the ordinary pattern on which rest two copper brushes which are connected by flexible leads to a sensitive galvanometer. The inclination of the axis of the coil can be roughly adjusted by hand by rotating the supporting ring. The final adjustment is made by means of a micrometer screw attached to an arm which is clamped on the axle of the ring.

When making a measurement the azimuth circle is first set horizontal, a striding level placed on the trunnions which carry the ring being used to indicate when the adjustment is complete. The striding level is then placed on the axle which carries the coil, and when the bubble is at the centre of the scale the microscopes are adjusted to the zeros of the vertical circle. A box containing a long compass needle and having two feet with inverted V's is placed to rest on the axle of the coil, and the instrument is turned in azimuth till the compass needle points to a lubber line on the box. By this means the axis of the coil is brought into the magnetic meridian. The commutator being connected to a sensitive galvanometer, the coil is rotated, and the ring adjusted till the galvanometer is undeflected. The reading on the vertical circle then gives the dip. By a system of reversals slight faults in the adjustment of the instrument can be eliminated as in the case of the dip circle. With such an instrument it is claimed that readings of dip can be made accurate to  $\pm 0.1$  minutes of arc.

The form of Wild inductor for use in a fixed observatory differs from the above in that the coil consists of a drum-wound armature, but without iron, of which the length is about three times the diameter. This armature has its axle mounted in a frame attached to the sloping side of a stone pillar, so that the axis of rotation is approximately parallel to the lines of force of the earth's field. By means of two micrometer screws the inclination of the axis to the magnetic meridian and to the horizontal can be adjusted. The armature is fitted with a commutator and a system of gear wheels by means of which it can be rapidly rotated. The upper end of the axle carries a plane mirror, the normal to which is adjusted parallel to the axis of rotation of the armature. A theodolite is placed on the top of the pillar and the telescope is turned so that the image of the cross-wires, seen by reflection in the mirror, coincides with the wires themselves. In this way the axis of the theodolite telescope is placed parallel to the axis of the armature, and hence the dip can be read off on the altitude circle of the theodolite.

**AUTHORITIES.**—In addition to the references already given the following papers may be consulted: (1) *Admiralty Manual of Scientific Inquiry*, which contains directions for making observations with a dip circle; (2) Stewart and Gee, *Elementary Practical Physics*, which contains a full description of the dip circle and instructions for making a set of observations; (3) L. A. Bauer, *Terrestrial Magnetism* (1901), 6, p. 31, a memoir which contains the results of a comparison of the values for the dip obtained with a number of different circles; (4) E. Leyst, *Reportorium für Meteorologie der kaiserl. Akad. der Wiss.* (St Petersburg, 1887), to No. 5, containing a discussion of the errors of dip circles; (5) H. Wild, *Bull. de l'Acad. Imp. des Sci. de St Petersburg* (March 1895), a paper which considers the accuracy obtainable with the earth inductor. (W. Wn.)

<sup>1</sup> *Reportorium für Meteorologie der kaiserl. Akad. der Wiss.* (St Petersburg, 1892), 16, No. 2, or *Meteorolog. Zeits.* (1895), 12, p. 41.

**INCLOSURE**, or **ENCLOSURE**, in law, the fencing in of waste or common lands by the lord of the manor for the purpose of cultivation. For the history of the inclosure of such lands, and the legislation, dating from 1235, which deals with it, see **COMMONS**.

**IN COENA DOMINI**, a papal bull, so called from its opening words, formerly issued annually on Holy Thursday (in Holy Week), or later on Easter Monday. Its first publication was in 1363. It was a statement of ecclesiastical censure against heresies, schisms, sacrilege, infringement of papal and ecclesiastical privileges, attacks on person and property, piracy, forgery and other crimes. For two thousand years it was varied from time to time, receiving its final form from Pope Urban VIII. in 1627. Owing to the opposition of the sovereigns of Europe both Protestant and Catholic, who regarded the bull as an infringement of their rights, its publication was discontinued by Pope Clement XIV. in 1770.

**INCOME TAX**, in the United Kingdom a general tax on income derived from every source. Although a graduated tax on income from certain fixed sources was levied in 1435 and again in 1450, it may be said that the income tax in its present form dates in England from its introduction by W. Pitt in 1798 "granting to His Majesty an aid and contribution for the prosecution of the war." This act of 1798 merely increased the duties of certain assessed taxes, which were regulated by the amount of income of the person assessed, provided his income amounted to £60 or upwards. These duties were repealed by an act of 1799 (39 Geo. III. c. 13), which imposed a duty of 10% on all incomes from whatever sources derived, incomes under £60 a year being exempt, and reduced rates charged on incomes between that amount and £200 a year. The produce of this tax was £6,046,624 for the first year, as compared with £1,855,996, the produce of the earlier tax. This income tax was repealed after the peace of Amiens, but the renewal of the war in 1803 caused its revival. At the same time was introduced the principle of "collection at the source" (*i.e.* collection before the income reaches the person to whom it belongs), which is still retained in the English Revenue system, and which, it has been said, is mainly responsible for the present development of income tax and the ease with which it is collected. The act of 1803 (43 Geo. III. c. 122) distributed the various descriptions of income under different schedules, known as A, B, C, D and E. A rate of 5% was imposed on all incomes of £150 a year and over, with graduation on incomes between £60 and £150. This income tax of 5% collected at the source yielded almost as much as the previous tax of 10% collected direct from each taxpayer. The tax was continued from year to year with the principle unchanged but with variations in the rate until the close of the war in 1815, when it was repealed. It was, during its first imposition, regarded as essentially a war tax, and in later days, when it was reimposed, it was always considered as an emergency tax, to be levied only to relieve considerable financial strain, but it has now taken its place as a permanent source of national income, and is the most productive single tax in the British financial system. The income tax was revived in 1842 by Sir R. Peel, not as a war tax, but to enable him to effect important financial reforms (see **TAXATION**). Variations both in the rate levied and the amount of income exempted have taken place from time to time, the most important, probably, being found in the Finance Acts of 1804, 1807, 1808, 1809 and 1810.

It will be useful to review the income tax as it existed before the important changes introduced in 1909. It was, speaking broadly, a tax levied on all incomes derived from sources within the United Kingdom, or received by residents in the United Kingdom from other sources. Incomes under £160 were exempt; an abatement allowed of £160 on those between £160 and £400; of £150 on those between £400 and £500; of £120 on those between £500 and £600, and of £70 on those between £600 and £700. An abatement was also allowed on account of any premiums paid for life insurance, provided they did not exceed one-sixth of the total income. The limit of total exemption was fixed in 1894, when it was raised from £150; and the scale of abatements was revised in 1898 by admitting incomes between £500 and £700; the Finance Act 1907 distinguished between "earned" and "unearned" income, granting relief to the former over the latter by 3d. in the pound, where the income from all

sources did not exceed £2000. The tax was assessed as mentioned above, under five different schedules, known as A, B, C, D and E. Under schedule A was charged the income derived from landed property, including houses, the annual value or rent being the basis of the assessment. The owner is the person taxed, whether he is or is not in occupation. In England the tax under this schedule is obtained from the occupier, who, if he is not the owner, recovers from the latter by deducting the tax from the rent. In Scotland this tax is usually paid by the owner as a matter of convenience, but in Ireland it is by law chargeable to him. All real property is subject to the tax, with certain exceptions:—(a) crown property, such as public offices, prisons, &c.; (b) certain properties belonging to charitable and educational bodies, as hospitals, public schools, colleges, almshouses, &c.; (c) public parks or recreation grounds; (d) certain realities of companies such as mines, quarries, canals, &c., from which no profit is derived beyond the general profit of the concern in which they belong. Under schedule B were charged the profits arising from the occupation of land, the amount of such profits being assumed to be one-third of the annual value of the land as fixed for the purposes of schedule A. This applies principally to farmers who might, if they chose, be assessed on schedule D on their actual profits. Schedule C included income derived from interest, &c., payable out of the public funds of the United Kingdom or any other country. Schedule D, the most important branch of the income tax and the one which is assessed on the assessor out of their own trade, from professional or other employment, and from foreign property, the assessment in most cases being made on an average of the receipts for three years. Schedule E covered the salaries and pensions of persons in the employment of the state or of public bodies, and of the officials of public companies, &c. The method of assessment and collection of the tax is uniformly the same. Under schedules A, B and D it is in the hands of local authorities known as the General or District Commissioners of Taxes. They are appointed by the Land Tax Commissioners out of their own body, and, as regards assessment, are not in any way controlled by the executive government. They appoint a clerk, who is their principal officer and legal adviser, assessors for each parish and collectors. There is an appeal from their decisions to the High Court of Justice on points of law, but not on questions of fact. Assessments under schedules A and B are usually made every five years, and under schedule D every year. The interests of the revenue are looked after by officers of the Board of Inland Revenue, styled surveyors of taxes, who are stationed in different parts of the country. They are in constant communication with the Board, and with the public on all matters relating to the assessment and collection of the tax; they attend the meetings of the local commissioners, examine the assessments and the taxpayers' returns, and watch the progress of the collection. There are also certain officers, known as special commissioners, who are appointed by the crown, and receive fixed salaries from public funds. For the purpose of schedule D, any taxpayer may elect to be assessed by them instead of by the local commissioners; and those who object to their being assessed by persons from their own neighbourhood may thus have their assessments made without any risk of publicity. The special commissioners also assess the profits of railway companies under schedule D, and profits arising from foreign or colonial sources under schedules C and D. The greater part of the incomes under schedule E is assessed by the commissioners for public offices, appointed by the several departments of the government.

Previously to 1909 the rate of income tax has been as high as 16d. (in 1855–1857), and as low as 2d. (in 1874–1876). Each penny of the tax was estimated to produce in 1906–1907 a revenue of £2,666,867<sup>1</sup>.

It had long been felt that there were certain inequalities in the income tax which could be adjusted without any considerable difficulty, and from time to time committees have met and reported upon the subject. Select committees reported in 1851–1852 and in 1861, and a Departmental Committee in 1905. In 1906 a select committee was appointed to inquire into and report upon the practicability of graduating the income tax, and of differentiating, for the purpose of the tax, between permanent and precarious incomes. The summary of the conclusions contained in their *Report* (365 of 1906) was:—

1. Graduation of the income tax by an extension of the existing system of abatements is practicable. But it could not be applied to all incomes from the highest to the lowest, with satisfactory results. The limits of prudent extension would be reached when a large increase in the rate of tax to be collected at the source was necessitated, and the total amount which was collected in excess of what was ultimately retained became so large as to cause serious inconvenience to trade and commerce and to individual taxpayers. Those limits

<sup>1</sup> Full statistics of the yield of income tax and other information pertaining thereto will be found in the *Reports of the Commissioners of His Majesty's Inland Revenue* (published annually); those issued in 1870 and in 1885 are especially interesting.



would not be exceeded by raising the amount of income on which an abatement would be allowed to £1000 or even more.

2. Graduation by a super-tax is practicable. If it be desired to levy a much higher rate of tax upon large incomes (say of £5000 and upwards) than has hitherto been charged, a super-tax based on personal declaration would be a practicable method.

3. Abandonment of the system of "collection at the source" and adoption of the principle of direct personal assessment of the whole of each person's income would be inexpedient.

4. Differentiation between earned and unearned incomes is practicable, especially if it be limited to earned incomes not exceeding £3000 a year, and effect be given to it by charging a lower rate of tax upon them.

5. A compulsory personal declaration from each individual of total net income in respect of which tax is payable is expedient, and would do much to prevent the evasion and avoidance of income tax which at present prevail.

Acting upon the report of this committee the Finance Bill of 1909 was framed to give effect to the principles of graduation and differentiation. The rate upon the earned portion of incomes of persons whose total income did not exceed £3000 was left unchanged, viz. 9d. in the pound up to £2000, and 1s. in the pound between £2000 and £3000. But the rate of 1s. in the pound on all unearned incomes and on the earned portion of incomes over £2000 from all sources was raised to 1s. 2d. In addition to the ordinary tax of 1s. 2d. in the pound, a super-tax of 6d. in the pound was levied on all incomes exceeding £5000 a year, the super-tax being paid upon the amount by which the incomes exceed £3000 a year. A special abatement of £10 a child for every child under the age of sixteen was allowed upon all incomes under £500 a year. No abatements or exemptions were allowed to persons not resident in the United Kingdom, except in the case of crown servants and persons residing abroad on account of their health. Certain abatements for improvements were also allowed to the owners of land or houses.

The estimated increased yield of the income tax for 1909-1910 on these lines was £2,500,000, which excluded the abatements allowed for improvements. The super-tax was estimated to yield a sum of £500,000, which would be raised ultimately to £2,500,000, when all returns and assessments were made.

The following accounts show the operation of the same system of taxation in other countries:—

**Austria.**—The income tax dates from 1849, but the existing tax, which is arranged on a progressive system, came into force on the 1st of January 1898. The tax is levied on net income, deductions from the gross income being allowed for upkeep of business, houses and lands, for premiums paid for insurance against injuries, for interest on business and private debts, and for payment of taxes other than income tax. Incomes under £50 a year are exempt, the rate of taxation at the first stage (£52) being 0.6 of the income; at the twelfth stage (£100) the rate is 1% at the twenty-seventh stage (£300) it rises to 2% at the forty-third stage (£1000) it is 3% and at the fifty-sixth (£2500) it is 3½%; an income of £4000 pays 4%; from £4000 up to £8333 per annum progression rises at £166 a step, and for every step £8, 6s. 8d. taxation is assessed. Incomes between £8333 and £8750 pay £87, 10s.; incomes over £8750 are taxed £2, 8s. 8d. at each successive stage of £417, 10s. Certain persons are exempt from the tax, viz.:—(a) the emperor; (b) members of the imperial family, as far as regards such sums as they receive as allowances; (c) the diplomatic corps, the consular corps who are not Austrian citizens, and the official staffs and foreign servants of the embassies, legations and consulates; (d) such people as are exempted by treaty or by the law of nations; (e) people in possession of pensions from the Order of Maria Theresa, and those who receive pensions on account of wounds or the pension attached to the medal for bravery, are exempted as far as the pensions are concerned; (f) officers, chaplains and men of the army and navy have no tax levied on their pay; (g) all other military persons, and such people as are included in the scheme of mobilization are exempted from any tax on their pay. Special allowances are made for incomes derived from labour, either physical or mental, as well as for a family with several children. There are also special exemptions in certain cases where the annual income does not exceed £4167, 10s., viz.:—(a) special charges for bringing children or the pension attached to the medal for bravery; (b) expense in maintaining poor relations; (c) perpetual illness; (d) debts; (e) special misfortunes caused by fire or floods; (f) being called out for military service. The tax is assessed usually on a direct return from the individual taxpayer, except in the cases of fixed

salaries and wages, on which the tax is collected from the employer, who either deducts it from the salary of the employee or pays it out of his own pocket. The tax, which is assessed on the income of the previous year, is paid direct to the collector's office in two instalments—one on the 1st of June and the other on the 1st of December.

**Belgium.**—No income tax proper exists in Belgium, but there is a state tax of 2% on the dividend of—first stock companies and

**Denmark.**—Income tax is levied under a law of the 15th of May 1903. Incomes under 2000 kroner pay a tax of 1.3%; under 3000 kroner, 1.4%; under 4000 kroner, 1.5%; under 6000 kroner, 1.6%; under 8000 kroner, 1.7%; under 10,000 kroner, 1.8%; under 15,000 kroner, 1.9%; under 20,000 kroner, 2.0%; and for every additional 10,000 kroner up to 100,000 kroner 1%, incomes of 100,000 kroner and upwards paying 2.5%. Exempt from the duty are—the king, members of the royal family and the civil list; the legations, staffs and consular officers of foreign powers, not being Danish subjects; foreigners temporarily resident in the country; mortgage societies, credit institutions, savings and loan banks. The increase in capital resulting from an increase in value of properties is not deemed income—on the other hand no deduction in income is made if such properties decrease in value—nor are daily payments and travelling expenses received for the transaction of business on public service, if the person has thereby been obliged to reside outside his own parish. Certain deductions can be made in calculating income—such as—wages and expenses for office expenses, pensions and other burthens amounting to rates for direct taxation, duties on land and church, tithe, tenant and farming charges, heirs' allowances and similar burthens; interest on mortgages and other debts, and what has been spent for necessary maintenance or insurance of the property of the taxpayer. There are also certain exemptions with respect to companies not having an establishment in the country.

**France.**—There is no income tax in France corresponding exactly to that levied in the United Kingdom. There are certain direct taxes not as the taxes on buildings, *personnelle mobilière*, and doors and windows *impôts de répartition*—the tax levied on incomes from land and from all trades and professions (*impôts de quotité*) which bear a certain resemblance to portions of the British income tax (see FRANCE: Finance). From time to time a graduated income tax has been under discussion in the French Chambers, the proposal being to substitute such a tax for the existing (*personnelle mobilière*) and doors and windows taxes, but no agreement on the matter has been reached.

**German Empire.**—In Prussia the income tax is levied under a law of the 24th of July 1891. All persons with incomes of over £150 per annum are required to submit an annual declaration of their full income, divided according to four main sources—(a) capital; (b) landed property; (c) trade and industry; (d) employment bringing gain, this latter including the salary or wages of workmen, servants and industrial assistants, military persons and officials; also the receipts of authors, artists, scientists, teachers and tutors. Liability for income tax, however, begins with an income of £45, and rises by a regular system of progression, the rate being about 3% of the income. Thus an income of more than £45, but under £52, 10s. pays tax of 6s. and so on up to £475, an income over that sum but under £525 paying a tax of 15s. Incomes over £525 rise by steps of £50 up to £1525, for every step £1, 10s. being paid. Incomes between £1526 and £1600 rise by steps of £75, £13 being paid for every step. Between £1601 and £3900, the steps are £100, and the tax £4 a step; from £3901 to £5000 the steps are the same (£100), but the tax is £5 a step. There is also a supplementary tax on property of about ½% of the assessed value. This supplementary tax is not levied on those whose taxable property does not exceed a total value of £1000, or on those whose annual income does not exceed £45, if the total value of their taxable property does not exceed £1000, nor on women who have members of their own family under age to maintain, nor on orphans under age, nor on persons incapable of earning incomes if their taxable property does not exceed £1000 nor their income £60. There are a number of exemptions from the income tax, some of the more important being—(a) the military incomes of non-commissioned officers and privates, also of all persons on the active list of the army or navy as long as they belong to a unit in war formation; (b) extraordinary receipts from inheritances, presents, insurance, from the sale of real estate not undertaken for purposes of industry or speculation, and similar profits (all of which are reckoned as increases of capital); (c) expenses incurred for the purpose of acquiring, assuring and maintaining income; (d) interest on debts; (e) the regular annual depreciation arising from wear of buildings, machines, tools, &c., in so far as they are not included under working expenses; (f) the contributions which taxpayers are compelled by law or agreement to pay to invalid, accident, old age and death insurance, and to life insurance, and to annuity premiums. Moreover, persons liable to taxation with an income of not more than £150 may deduct from that income £2, 10s. for every member of their family under fourteen years of age, and abatement is also allowed to persons with incomes up to £475 whose solvency has been unfavourably affected by adverse economic circumstances. The income tax is both levied at the source (as in the case of companies) and assessed on a direct return by the taxpayer of his income from all sources. Salaries are not taxed before payment. Fixed receipts are assessed according to their amount for the taxation year in which the assessment is made, and variable incomes on an

<sup>1</sup> In Appendix No. 4 to the Report from the Select Committee on Income Tax (1906), will be found a valuable list (prepared in the Library of the House of Commons) of references to the graduation of the income tax and the distribution of incomes both in the United Kingdom and in other countries.

average of the three years immediately preceding the assessment. The income tax and the supplementary tax are collected in the first half of the second month of each quarter by the communities (*Gemeinden*) who bear the whole cost.

In Saxony a graduated tax is in force on all incomes of £20 per annum and upwards. All corporate bodies and individuals who derive their income or any portion of it from Saxony are liable to the extent of that income, except those serving religious, charitable or public purposes. Incomes below £20 and £500 are divided into 118 classes, in which the rate rises progressively. From £500 to £5000 the classes rise by £50, and above £5000 by £100. The rate of income tax begins at 1%, i.e. 1s. on an income of £20. An abatement is allowed to those whose incomes do not exceed £155 of £2, 10s. for each child between the ages of six and fourteen years, provided such abatements do not reduce the income by more than one class. In the case of persons with incomes not exceeding £290 abatement (not exceeding three classes) is allowed—(a) when the support of children or indigent relations involves a burden of such a nature as to affect the general standard of living; (b) on account of long-continued illness, involving heavy expense; and, on restoration to health, temporary decrease of wage-earning power; (c) in the case of accidents which have had the same effect.

In Bavaria the existing system of income tax came into force on the 1st of January 1900. The rate on earned income varies according to a scale laid down in article 5 of the law, beginning at 1% for incomes up to £37, 10s. (1s.), being .66% (£2, 5s.), for incomes between £230 and £250; 1.03% (£4) for incomes between £350 and £375; 1.30% (£6, 16s.), for incomes between £475 and £500 and 1.38% (£10) for incomes between £650 and £700. Incomes exceeding £700 and not exceeding £1100 pay £1 on every £50; those between £1100 and £1700, £1, 10s., on every £50, between £1700 and £2050, £2 on every £50; between £2050 and £2500, £2, 10s. on every £50 and £2500 to 3% on every £50. Exemptions from earned income tax are similar to those already mentioned in the case of Prussia. Special abatement in the case of incomes not exceeding £250 from all sources is given in consideration of education of children, protracted illness, maintenance of poor relations, serious accidents, &c. The tax on unearned income is at the rate of 1½% on incomes from £3, 10s. to £5; from £6 to £20, 2% from £21 to £35, 2½%; from £36 to £50, 3%; from £51 to £150, 3½%; from £151 to £500, 3½%, and over £500, 4%. There is a differentiation in assessment on fluctuating and fixed incomes. Fluctuating incomes (e.g. those derived from literary, scientific or artistic work) are assessed at the average receipts of the two past years. Fixed income is returned at the actual amount at the time of assessment, and the assessment for earned income, both fixed and fluctuating, takes place every four years. Income tax is not levied at the source, where a person's yearly unearned income does not exceed £100 and he has no other or only an insignificant additional income, he is required to pay only half the assessed tax. Also in the case where a total income, earned and unearned, does not exceed £250 it may, by claiming abatement on such grounds as the education of children, maintenance of indigent relations, &c., be assessed at the lowest rate but one, or be entirely exempt.

In Württemberg the General Income Tax Act came into force on the 1st of April 1905. Article 18 provides a graduated scale of rates on incomes from £25 upwards. Abatements are allowed for the education and support of children, support of indigent relatives, active service in the army and navy, protracted illness and severe accidents or reverses. There is a supplementary tax of 2% on unearned income of certain kinds of property, such as interest or other income derived from invested capital, dividends, &c., from joint-stock companies and annuities of all kinds. The income tax is not levied at the source, but on a direct return by the ratepayers; assessments are made on the current year, except in the case of fluctuating incomes, when they are made on the income of the preceding year.

*Hungary.*—There is no income tax in Hungary at all corresponding to that of the United Kingdom, although proposals for such a tax have from time to time been made.

*Italy.*—Graduated income tax in Italy dates from 1864. Incomes are classified according to their characters, and the rate of the tax varies accordingly. In class A are placed incomes derived from interests on capital, and perpetual revenues owned by the state, interests and premiums on communal and provincial loans, dividends of shares issued by companies guaranteed or subsidized by the state lottery prizes. These incomes are assessed at their integral value and pay the full tax of 20%. In class A<sup>2</sup> are placed incomes derived from capital alone and all perpetual revenues. The assessments on these are reduced to 30/40ths of the actual income and taxed at a rate of 5%. In class B are incomes derived from the co-operation of labour and capital, and the profits made by industries and commerce. The assessments of these are reduced to 20/40ths and taxed at 10%. In class C are placed incomes derived from labour alone (private employment) and those represented by temporary revenues or life annuities. Assessments on these are reduced to 18/40ths and taxed at a rate of 9%. In class D are placed incomes from salaries, pensions and all personal allowances made by the state, the provinces and communes. Assessments on these are reduced to 15/40ths and taxed

at 7½%. Certain abatements are allowed on small incomes in classes B, C and D. Incomes are assessed (1) on the average of the two preceding years in the case of private industries, professions or companies in which liability is unlimited; (2) on the income of the current year in the case of incomes from dividends, salaries, pensions and fixed allowances, as well as in the case of incomes of communes, provinces and corporations; (3) on the basis of the account closed before the previous July of the current year in the case of incomes of limited liability companies, banks and savings banks.

*Netherlands.*—In the Netherlands there is a property tax imposed upon income derived from capital, as well as a tax on income earned by labour.

*Norway.*—In Norway under the state income tax incomes under 1000 kroner are exempt, those between 1000 and 4000 kroner pay 2% on that part liable to taxation; those between 4000 and 7000 kroner pay 3%; those between 7000 and 10,000 kroner pay 4%, and those above 10,000 kroner 5%. Persons liable to taxation are divided into (a) those who have no one to support, as companies and the like; (b) those who have from one to three persons to support; (c) those who have from four to six persons to support; (d) those who have seven or more persons to support. Those who are counted as dependent upon the taxpayer are his children, own or adopted, his parents, brothers and sisters, and other relations and connexions by marriage who might have reasonable claim to his support. A certain part of the income liable to taxation is abated by a graduated scale according to the class into which the ratepayer falls.

*Spain.*—In Spain the income tax is divided into (a) that derived from personal exertion and (b) that derived from property. Directors, managers and representatives of banks, companies and societies pay 10%; those employed in banks, &c., commercial houses, and those in private employment, as well as actors, bull-fighters, professional pelota-players, acrobats, conjurers, &c., pay 5%. Those employed by the day or those whose salary is under £45 are exempt, as are also masters in primary schools. Income derived from property is taxed according to the source from which the income is derived, e.g. income from shares in public works is rated at 20%; income from shares in ordinary companies, railways, tramways or canals at 3% from dividends on bank shares at 5% from mining shares at only 2%. There is also an industry tax, 4% on the exercise of industrial, commercial and professional enterprises, which tax is divided into five different tariffs, of which I. applies to commerce (vendors), II. also to commerce (middlemen), III. to industry (machinery), IV. to professions and V. to licences (retail and itinerant vendors). Tariff I. is differentiated according to the importance of the business and of the locality in which it is carried on, the rate being fixed by a consideration of the two combined. Tariff II. is differentiated according to the character of the enterprise, its importance and the importance of the locality. Tariff III. is differentiated according to either motive power, output, method, product or locality; Tariff IV. according to the character of the profession and the importance of the locality; Tariff V. is also differentiated according to the locality and the importance of the business.

*Switzerland.*—The system of income tax varies in the different cantons. Broadly speaking, these may be divided into four different kinds: (1) a graduated property tax, in which the rate applicable to each class of fortune is definitely fixed; (2) a proportional tax, under which property and income are chargeable, each at a fixed rate, while the total amount of the tax is liable to a proportionate increase according to scale if it exceeds certain specified amounts; (3) a system by which property and income are divided into three classes, the rate of the tax being assessed by a graduated rise, according to the class to which the property or income belongs, and (4) a uniform rate of tax, with progression in the amount of income liable to taxation.

*United States.*—One of the means adopted by the Federal Government for meeting its expenses during the Civil War was the levying of an income tax. By the Act of Congress of the 5th of August 1861 a tax of 3% was imposed on all incomes, with an exemption of \$800, and was made payable on or before the 30th of June 1862. No tax, however, was assessed under the law. In March 1862 a new income tax bill was introduced into the House of Representatives. This act, which was signed on the 1st of July 1862, imposed a tax of 3% on all incomes not over \$10,000, and 5% on all incomes above that sum, with an exemption of \$600. It was also provided that dividends of banks, insurance companies and railways should be assessed directly; but the bond-holder was allowed to deduct the dividend so assessed from his taxable income. In the case of government salaries, the tax was deducted before the salaries were paid. The income tax was first levied in 1863. The rate was changed by act of Congress in 1865, 1867 and 1870, and a joint resolution in 1864 imposed a special additional tax of 5% for that year. The tax was finally abolished in 1872. The total amount produced by the tax from the beginning was \$376,150,209. The constitutionality of the act was subsequently brought into question, but was upheld by a unanimous decision of the Supreme Court in 1880, which held that the tax was not a direct tax but an excise tax, and that Congress had a right to impose it so long as it was made uniform throughout the United States. On the 27th of August 1894 an income tax act was passed as part of the Wilson Bill. By this act it was provided that a tax of

2% on all incomes should be levied from the 1st of January 1895 to the 1st of January 1900, with an exemption of \$4000. The legality of the tax was assailed, chiefly on the ground that it was a direct tax, and not apportioned among the several States in proportion to their population. On the 20th of May 1895 the Supreme Court, by a vote of five to four, declared the tax to be unconstitutional. Accordingly, before any federal income tax could be imposed, there was needed an amendment of the constitution, and a movement in this direction gradually began. In the first year of the presidency of Mr W. H. Taft both Houses of Congress passed by the necessary two-thirds majority a resolution to submit the proposal to the 46 States, the wording of the amendment being "That Congress shall have power to lay and collect taxes on incomes from whatever source derived, without apportionment among the several States, and without regard to any census enumeration."

**Cape Colony.**—Cape Colony was the only South African colony which, prior to the Union in 1910, had a system of income tax, which was first imposed by an act of the 31st of May 1904. Incomes not exceeding £1000 per annum were exempt from taxation; incomes exceeding £1000 but not exceeding £2000 were taxed 6d. in the pound on the excess beyond £1000; those between £2000 and £5000 were exempt for the first £1000, paid 6d. in the pound on the next £1000 and 9d. in the pound on the remainder; those exceeding £5000 paid 6d. in the pound on the second £1000, 9d. in the pound on the next £3000 and 1s. in the pound on the remainder.

**New South Wales.**—Income tax in New South Wales first came into operation on the 1st of January 1896. It is complementary with a family tax, assessed on the estimated value of the household lands, with certain exemptions and deductions. Incomes of £200 per annum and under are exempt, and all other incomes (except those of companies) are entitled to a reduction of £200 in their assessments. The rate of tax is 6d. in the pound. There are certain incomes, revenues and funds which are exempt from taxation, such as those of municipal corporations or other local authorities, of mutual life insurance societies and of other companies or societies not carrying on business for purposes of profit or gain, and of educational, ecclesiastical and charitable institutions of a public character, &c.

**New Zealand.**—In New Zealand the income tax is also complementary with a land tax. Incomes up to £300 per annum are exempt; incomes up to £1000 per annum are taxed 6d. in the pound, with an exemption of £300 and life insurance premiums up to £50; incomes over £1300 pay 1s. in the pound, which is also the tax on the income of trading companies, to whom no exemption is allowed. The income of friendly societies, savings-banks, co-operative dairy companies, public societies not carrying on business for profit, &c., are exempt from income tax.

**Queensland.**—In Queensland an income tax is levied on (a) income derived from property such as rents, interest, income from companies, royalties, &c., and (b) on income derived from personal exertion. On income derived from property all incomes not exceeding £100 are exempt; incomes between £100 and £120 pay 1s. tax; those over £120 but under £300 have £100 exempt and pay 1s. in each and every pound over £100, while incomes over £300 pay 1s. in each and every pound. Incomes from personal exertion pay 10s. between £100 and £125; 1s. between £125 and £150; between £151 and £300 have £100 exempt and pay 6d. in each and every pound over £100; between £301 and £500 6d. in every pound; between £501 and £1000 6d. in every pound of the first £500 and 7d. in every pound over £500, between £1001 and £1500 7d. in every pound of the first £1000, and 8d. in every pound over £1000; incomes over £1500 pay 8d. in every pound; 1s. in every pound is charged on the incomes of all companies and of all absentees.

**South Australia.**—The income tax dates from 1884 and is levied on all incomes arising, accruing in or derived from South Australia, except in municipal corporations, or in respect of any company, &c., not carrying on business for the purpose of gain, and all friendly societies. Where the income is derived from personal exertion the rate of tax is 4d. in the pound up to £800, and 7d. in the pound over £800. For income derived from property the rate is 9d. in the pound up to £800, and 1s. 1d. in the pound over £800. There is an exemption of £150 on incomes up to £400, but no exemption over that limit.

**Tasmania.**—In Tasmania there is (a) an income tax proper, and (b) a non-inquisitorial ability tax, one complementary to the other. The income tax proper is levied on the net income of any company, at the rate of 1s. for every pound of the taxable amount, on all incomes of any person, at the rate of 1s. for every pound of the taxable amount derived from property, and on every dividend at the same rate. Personal incomes of £400 and over are assessed at the full amount, but an abatement of £10 for every £50 of income is allowed on incomes below £400 down to incomes of £150, which thus have £50 deducted; incomes between £120 and £150 have £50 deducted; incomes between £110 and £120, £70, and incomes between £100 and £110, £30. The ability tax is levied on all incomes and on occupiers of property and (b) by lodgers. The amount of tax paid by occupiers or sub-occupiers is calculated upon the assessed annual value of the property occupied, and that of lodgers from the assessed annual value of their board and lodging. A detailed account of both taxes will be found in House of Commons Papers, No. 282 of 1905.

**Victoria.**—In Victoria the rate of income tax is fixed annually by act. The rate charged on income derived from property is exactly

double that charged on income derived from personal exertion, the rate for which for 1905 was: on the first £500 or fractional part thereof, 3d. in the pound; on the second £500 or fractional part thereof, 4d. in the pound; on the third £500 or fractional part thereof, 5d. in the pound; on all incomes in excess of £1500, 6d. in the pound. All companies, except life insurance companies, were charged 7d. in the pound on their incomes; life insurance companies were charged 8d. in the pound.

**BIBLIOGRAPHY.**—The Annual Reports of the Commissioners of Inland Revenue, the Reports of Committees and other references mentioned in the article, as well as Dowell's *History of Taxation in England* (1884); Dowell's *Acts relating to the Income Tax* (6th ed., 1908), and Robinson's *Law relating to Income Tax* (2nd ed., 1908).

**INCORPORATION** (from Lat. *incorporare*, to form into a body), in law, the embodying or formation of a legal corporation, brought about either by a general rule contained in such laws, e.g. as the Companies acts, and applicable wherever its conditions are satisfied; or by a special act of sovereign power, e.g. an incorporating statute or charter. The word is used also in the sense of uniting, e.g. a will may incorporate by reference other papers, which may be then taken as part of the will, as much as if they were set out at length in it.

**INCUBATION AND INCUBATORS.** The subject of "incubation" (Lat. *incubare*, to brood; *in-cum-bere*, to lie on), a term which, while strictly signifying the action of a hen in sitting on her eggs to hatch them, is also used in pathology for the development within the body of the germs of disease, is especially associated with the artificial means, or "incubators," devised for hatching eggs, or for analogous purposes of an artificial foster-mother nature, or for use in bacteriological laboratories.

Life is dependent, alike for its awakening and its maintenance, upon the influence of certain physical and chemical factors, among which heat and moisture may be regarded as the chief. It is therefore obvious that any method of incubation must provide for a due degree of temperature and moisture. And this degree must be one within limits, for while all organisms are plastic and can attune themselves to a greater or less range of variation in their physical environment, there is a given degree at which the processes of life in each species proceed most favourably. It is this particular degree, which differs for different species, which must be attained, if artificial incubation is to be successfully conducted. In other words, the degree of temperature and moisture within the incubation drawer must remain uniform throughout the period of incubation if the best results are to be reached. It is not easy to attain these conditions, for there are many disturbing factors. We may therefore next consider the more important of them.

The chief causes which operate to make the temperature within the incubator drawer variable are the changes of the temperature of the outer air, fluctuations in the pressure of the gas when that is used as the source of heat, or the gradual diminution of the oxidizing power of the flame and wick when an oil lamp is substituted for gas. Also, the necessary opening of the incubator drawer, either for airing or for sprinkling the eggs with water when that is necessary, tends to reduce the temperature. But there is another equally important though less obvious source of disturbance, and this resides within the organism undergoing incubation. In the case of the chick, at about the ninth or tenth days of incubation important changes are occurring. Between this period and the fourteenth day the chick becomes relatively large and bulky, and the temporary respiratory organ, the allantois, together with its veins, increases greatly in size and extent. As a consequence, the respiratory processes are enabled to proceed with greater activity, and the chemical processes of oxidation thus enhanced necessarily largely increase the amount of heat which the chick itself produces. Thus an incubator, to be successful, must be capable of automatically adjusting itself to this heightened temperature.

The drawer of an incubator is a confined space and is usually packed as closely as possible with the contained eggs. The eggs are living structures and consequently need air. This necessitates some method of direct ventilation, and this in its turn necessarily increases the evaporation of water vapour from the surface of the egg. Unless, therefore, this evaporation is checked, the eggs will be too dry at the period—from the tenth day onwards—

when moisture is more than ever an important factor. There is, according to some poultry authorities, reason to believe that the sitting hen secretes some oily substance which, becoming diffused over the surface of the egg, prevents or retards evaporation from within; presumably, this oil is permeable to oxygen. In nature, with the sitting hen, and in the "Mamal" artificial incubating establishments of the Egyptians, direct air currents do not exist, owing to the large size of the chambers, and consequently incubation can be successfully achieved without any special provision for the supply of moisture.

Artificial incubation has been known to the Egyptians and the Chinese from almost time immemorial. In Egypt, at Berme on the Delta, the trade of artificial hatching is traditionally transmitted from father to son, and is consequently confined to particular families. The secrets of the process are guarded with a religious zeal, and the individuals who practise it are held under plighted word not to divulge them. It is highly probable that the process of artificial incubation as practised by the Egyptians is not so simple as it is believed to be. But as far as the structures and processes involved have been ascertained by travellers, it appears that the "Mamal" is a brick building, consisting of four large ovens, each of such a size that several men could be contained within it. These ovens are in pairs, in each pair one oven being above the other, on each side of a long passage, into which they open by a circular aperture, just large enough for a man to obtain access to each. The eggs are placed in the middle of the floor of the oven, and in the gutters round the sides the fire is lighted. The material for this latter, according to one account, consists of camels' dung and chopped hay, and according to another of horses' dung. The attainment of the right degree of heat is apparently reached wholly by the skill of the persons employed. When this has been attained, they plug the entrance hole with coarse tow. On the tenth to twelfth days they cease to light the fires.

Each "Mamal" may contain from 40,000 to 80,000 eggs. There are 386 "Mamals" in the country, which are only worked for six months of the year, and produce in that time eight broods. Many more than two-thirds of the eggs put in are successfully hatched. It is estimated that 90,000,000 eggs are annually hatched by the Bermeans.

A method of incubating that appears to have been altogether overlooked in England—or at least never to have been practised—is that carried on by the *Couveurs* or professional hatchers in France. They make use of hen-turkeys for the purpose, and each bird can be made to sit continuously for from three to six months. The *modus operandi* is as follows: a dark room which is kept at a constant temperature throughout the year contains a number of boxes, just large enough to accommodate a turkey. The bottom of the box is filled with some vegetable material, bracken, hay, heather, straw or cocoa-fibres. Each box is covered in with lattice-work wire, so arranged that the freedom of the sitting bird is limited and its escape prevented. Dummy eggs, made by emptying addled ones and filling with plaster of Paris, are then placed in the nest and a bird put in. At first it endeavours to escape, but after an interval of a few days it becomes quiet, and the dummy eggs being then removed, fresh ones are inserted. As soon as the chickens are hatched, they are withdrawn and fresh eggs substituted. The hen turkeys are also used successfully as foster-mothers. Each bird can adequately cover about two dozen eggs.

Incubation as an industry in Europe and America is of recent development. The growing scarcity of game birds of all kinds, coincident with the increase of population, and the introduction of the breech-loading gun, together with the marked revival of interest in fancy poultry about the year 1870, led, however, to the production of a great variety of appliances designed to render artificial incubation successful.

Previously to this, several interesting attempts had been made. As long ago as 1824, Walthew constructed an incubator designed to be used by farmers' wives with the aid of no more than ordinary household conditions. It consisted of a double-walled metal box, with several pipes opening into the walled space round the

sides, bottom and top of the incubator. These pipes were connected with an ordinary kitchen boiler. Walthew, however, constructed a fire grate, with a special boiler adapted to the requirements of the incubator. Into the walled space of the incubator, steam from the kitchen boiler passed; the excess steam escaped from an aperture in the roof, and the condensed steam through one in the floor. Ventilating holes and also plugs, into which thermometers were placed, pierced the door of the incubator.

In 1827, J. H. Barlow successfully reared hens and other birds by means of steam at Drayton Green, Ealing. He constructed very large rooms and rearing houses, expending many thousands of pounds upon the work. He reared some 64,000 game birds annually. The celebrated physician Harvey, and the famous anatomist Hunter were much interested in his results.

To John Champion, Berwick-on-Tweed, in 1870, belongs, however, the credit of instituting a system which, when extended, may become the system of the future, and will rival the ancient "Mamals" in the success of the incubation and in the largeness of the numbers of eggs incubated. He used a large room through which passed two heated flues, the eggs being placed upon a table in the centre. The flues opened out into an adjoining space. The temperature of the room was adjusted by personal supervision of the fire. This system, more elaborated and refined, is now in use in some parts of America.

#### *Bird Incubators.*

Owing to the great variety in the details of construction, it is difficult to arrange a classification of incubators which shall include them all. They may, however, be classified in one of two ways. We may either consider the method by which they are heated or the method by which their temperature is regulated.

In the former case we may divide them into "hot-air" incubators and into "hot-water" or "tank" incubators. In the latter case we may classify them according as their thermostat or temperature-regulator is actuated by a liquid expanding with rising temperature, or by solids, usually metals.

In America incubators of the hot-air type with solid and metallic thermostats are most used, while in Europe the "tank" type, with a thermostat of expandible liquid, prevails.

For the purpose of more adequately considering the various forms which have been in use, or are still used, we shall here divide them into the "hot-air" and "hot-water" (or "tank") classes.

In the hot-air types the incubator chamber is heated by columns of hot air, while in the tank system this chamber is heated by a tank of warmed water.

(a) *Hot-Water Incubators.*—In 1866 Colonel Stuart Wortley described in *The Field* an incubator constructed upon a novel principle, but which appears never to have been adopted by breeders. The descriptive article is illustrated with a sketch. Essentially the incubator consists of four pipes which extend across the egg chamber some little distance above the eggs. The pipes pass through holes in the side of the incubator, which are furnished with pads, so as to render their passage air-tight. Externally they are connected with a boiler. This is provided with a dome through which steam escapes, and also with a glass gauge to show the height of the water within the boiler. The water in the boiler is kept at the boiling point, and the temperature of the incubator is regulated by adjustment of the length of the hot-water pipes within the egg chamber. To raise the temperature, a greater length of the pipes is pushed into the chamber, and to reduce it, more of their length is pulled outwards. It is claimed for this instrument that since the temperature of boiling water at any particular locality remains practically constant, the disadvantages due to fluctuations in the activity of a lamp flame or the size of a gas flame are obviated. But it has the serious disadvantage that there is no automatic adjustment to compensate for fluctuations of atmospheric temperature. And experiments by C. Hearson have shown that even if the temperature of the tank or source of heat be constant, that of the incubator drawer will nevertheless vary with fluctuations of external temperature. Probably if the mechanical difficulties of providing a self-regulator were overcome, it would prove an efficient and reliable incubator. The difficulties do not seem to be insuperable, and it appears possible that a thermostatic bar could be so arranged as to automatically increase or decrease the length of hot-water pipes within the incubator, and therefore the incubator temperature.

Another early form of incubator is Brindley's, which was first in

use about 1845, and in his hands it appeared occasionally to act successfully, but it never became generally used. The egg chamber was lined with felt, and was placed beneath a heated air chamber, the floor and roof of which were composed of glass. The air chamber was heated by a number of hot-water pipes which were connected with a copper boiler. This latter was heated by means of a lamp so constructed as to burn steadily. The temperature of the air chamber was regulated within certain limits by means of a balanced valve, which could be so adjusted that it would open at any desired temperature.

In Colonel Stuart Wortley's incubator the hot-water tubes passed directly into the egg chamber, and in Brindley's into a chamber above it. But in other forms of incubators in which the principle of an external boiler connected with water tubes is adopted, the latter pass not into the egg chamber nor into an air chamber, but open into a tank of water. The floor of this tank forms the roof of the egg chamber, so that the eggs are heated from above. This device of warming the eggs from above was adopted in imitation of the processes that presumably occur with the sitting hen; for it is generally assumed that the surface of the eggs in contact with the hen is warmer than that in contact with the damp soil or with the material of the nest.

One of the earliest of this form of incubator is that invented by F. Schröder, manager of the now extinct British National Poultry Company. In this incubator the form is circular, and there are four egg drawers, so that each one occupied the quadrant of a circle, and the inner corner of each drawer meets in the middle of the incubator. From the centre of the incubator a vertical chimney passes upwards and opens out from the inner corners of the four egg drawers. This chimney acts as a ventilator to the incubating chambers. These latter are open above, but their floors are made of perforated zinc, and when in use they are partially filled with chaff or similar material. Under them is a tank containing cold water and common to all four drawers; the slight vapour rising from the surface of the water diffuses through the egg drawers and thus insures a sufficient degree of humidity to the air within. Above the egg drawers is a circular tank containing warm water. The floor of this tank constitutes the roof of the egg drawers, while the roof forms the floor of a circular chamber above it, the side wall of which is composed of perforated zinc. This upper chamber is used to dry the chicks when they are just hatched and to rear them until they are strong enough for removal. It is partially filled with sand, which serves the double purpose of retaining the heat in the warm-water tank beneath and of forming a bed for the chicks. The water in the warm-water tank is heated by means of a boiler which is external to the incubator, and in communication with the tank by means of an inlet and an outlet pipe. There is no valve to regulate the temperature, and the latter is measured by means of a thermometer, the bulb of which is situated not in the incubator drawers, but in the warm-water tank. This is a wrong position for the thermometer, since it is now known that the temperature of the water tank may be different by several degrees to that of the egg drawer; for with a fall of external temperature that of the latter necessarily tends to fall more rapidly than the former. But, none the less, in skilful hands this incubator gave good results.

T. Christy's incubator, which we shall describe next, has passed through several forms. We shall consider the most recent one (1894). The incubator (fig. 1) is double walled, and the space between the two walls is packed with a non-conducting material. In the upper

ventilating shaft (V) is closed externally by a cap (C), which can be raised from or lowered down upon its orifice by the horizontal arm (H) working upon pivot joints at (P). This arm is operated by the thermostat (R), through the agency of a vertical rod. The water in the tank is heated by an external boiler (B) through two pipes, one of which (T) serves as an inlet, and the other (L) as an outlet channel for the tank. These two pipes do not open directly into the tank, but into an outer vessel (O) in communication with it. Communication between this vessel and the tank may be made or broken by means of a sliding valve (S), which is pierced by an aperture that corresponds in position with the upper of the two in the wall of the tank when the valve is up. When this valve is in its upper position, the tank (T) communicates with the outer vessel (O) by two apertures (A and A'), the top one being the inlet and the lower one the outlet. These coincide in position with the tubes from the boiler. This latter (B) is a conical vessel containing two spaces. The heated water is contained in the outer of these spaces, while the central space is an air shaft heated by a lamp flame. This particular form of the boiler results in the water at its top part being more heated than that in its lower. As a consequence of this, a continual circulation of water through the tank ensues. The more heated water, being specifically lighter, passes into the outer vessel, where it remains among the higher strata, and therefore enters the tank through the upper aperture. In passing along the upper division of the tank it becomes slightly cooled and sinks therefore into the lower compartment, passes along it, and out through the lower aperture. Hence it passes into the lower portion of the boiler, where it becomes warmed and specifically lighter; in consequence it becomes pushed upwards in the boiler by the cooler and heavier water coming in behind and below it.

Should the temperature in the incubator drawer rise, the bimetallic thermostat (R) opens out its coil and pulls down the vertical rod. This simultaneously effects two things: it raises the cap (C) over the ventilating shaft and allows of a more rapid flow of fresh air through the incubator drawer, and it also lowers the slide-valve (S) so that the tank becomes cut off from communication with the outer vessel (O) and therefore with the boiler. The temperature thereupon begins to fall and the thermostat, coiling closer, raises the vertical rod, closes the ventilating shaft, and once more places the tank in communication with the boiler.

The structure of the thermostat is given below. The Chantry Incubator (Sheffield) is also an incubator with a hot-water tank, the circulation of which is maintained by an outside boiler. Its temperature is regulated by a metal regulator.

In Schröder's and Christy's incubators the hot-water pipes from the boiler do not enter the warm-water tank but did not traverse it. In the two incubators to be next described the hot-water pipes are made to pass through the water in the tank, and are so arranged as to minimize the possibility that the outside of the tank may become colder than the centre. Both of them are also fitted with an ingenious though slightly complex valve for maintaining an approximately constant temperature.

Halsted's incubator was the earliest of this type. Since his original form was constructed he has designed an improved one, and it is this latter which will be described.

The egg drawer (E, fig. 2) lies beneath the warm-water tank (T), and above this is a nursery (N). The egg drawer is ventilated by two tubular shafts (V), of which only one is represented in the illustration; the tubes are about 2½ in. in diameter, and each one is fitted at its upper end, where it opens into the nursery, with a swing-valve (V') which turns upon a horizontal axis (A), in its turn connected, by means of cranks (C) and shafts (S), with the heat regulating apparatus (R). A space of about 2 in. between the top of the incubating drawer and the warm-water tank is necessary for the insertion of this apparatus. The water in the tank (T) is heated by means of the boiler (B); the tank and boiler are connected by the two pipes (I) and (O), of which one is the inlet and the other the outlet channel.

The boiler consists of an inner and an outer (O) division in communication with each other below. The latter is cylindrical in form, while the outer wall of the former is cylindrical and its inner wall conical. The conical wall of the inner boiler is the surface which is heated by the lamp (L). The arrangement of the inlet and outlet tubes is important. In the illustration, for the sake of clearness, they are represented as one above the other. In reality they lie in the same plane, and the fork (F) of the inlet pipe similarly lies in the horizontal plane and not vertically as represented. The inlet pipe not only differs from the outlet pipe in the

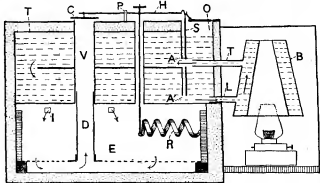

FIG. 1.—Christy's Improved Incubator.

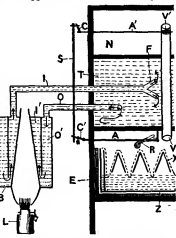

FIG. 2.—Halsted's Incubator.

part of the incubator there is a water tank (T) divided by a horizontal partition into two chambers, communicating with each other at the left-hand side. Below the tank is the incubation drawer (E), which contains the eggs and also a temperature regulator or thermostat (R). The tank is traversed by a ventilating shaft (V), and inserted into this is a smaller sliding tube passing up to it from a hole in the bottom of the incubation drawer. The floor of the incubation drawer is perforated, and beneath it is an enclosed air space which opens into the sliding air shaft just described. Fresh air is let into the incubator drawer from a few apertures (I) at its top. The

possession of a forked end, but it is carried to the farther end (not shown in the diagram) of the water tank, while the outlet pipe opens from about the middle of the tank. The inlet pipe is connected with the inner portion of the boiler and the outlet one with the outer portion. The result of this adjustment of the parts is that the warmer water of the inner boiler, being specifically lighter than the cooler water of the outer boiler, rises up and passes through the inlet pipe (I) and is discharged into the tank through the two divergent orifices of the fork (F). Here the water strikes the side wall of the farther end of the tank and is reflected back along the back and front walls towards the nearer side. Hence it is again reflected, but in the opposite direction, and now forms a centre current which is directed towards the centrally situated orifice of the outlet tube (O). Through this it passes to the outer boiler, and sinking towards the bottom, reaches the base of the inner boiler. Here it becomes heated and lighter and consequently rises to the top, and once more passes through the inlet pipe to the water tank. The warm water thus travels round the outer walls of the tank and the cooled water is conducted away along the middle portion. A more equable distribution of temperature over the roof of the incubating chamber is thus ensured than would be the case if the heated water were discharged either into the centre or at any other single point only of the tank.

To a very large extent, the efficiency of this apparatus depends upon the approximately perfect performance of the lamp. A good, steadily burning one should be employed, and only the best oil used; for, should the wick become fouled the flame cannot freely burn. For this reason it is better to use gas, whenever obtainable.

The maintenance of an approximately uniform temperature is obtained by allowing the heated air of the egg-drawer to escape through the two ventilating shafts (V). The swing-valves of these are opened or closed by means of the regulator (R). This latter consists of a glass bowl prolonged into a tube, about 8 in. long and three-eighths of an inch in diameter. The glass tube swings upon an axis (A) which is situated as near as possible to the bowl of the regulator. The axis is connected with a crank (C) which is disposed so as to act as a lever upon the vertical shaft (S), which in its turn is connected with the upper crank (C'); this works the axis (A') of the swing-valves, and so can open or close the apertures of the ventilating pipes. The bowl of the regulator is filled with mercury to such an extent that at the temperature of  $100^{\circ}$  F., and when the tube is slightly inclined upwards from the horizontal it just flows slightly into the tube from the bowl. On the lever-crank (C') a weight is slung by a sliding adjustment, and is so placed that when the temperature of the egg-drawer is  $103^{\circ}$  it just balances the tube of the regulator when it is slightly inclined upwards. Should the temperature of the drawer now rise higher the mercury flows towards the distant end of the tube and, causing it to fall down, brings about a rotation of the regulator, and as a consequence the opening of the ventilating valves. A transverse stay prevents the limb of the regulator from quite reaching the horizontal when it falls. As the temperature cools down the mercury contracts and retraces to the nearer end of the tube and to the bowl, and consequently results in the upward inclination of the limb; the valves are thus closed again.

The egg-drawer (E) is specially constructed so as to imitate as nearly as possible the natural conditions that exist under a sitting hen. The drawer is of wood and contains a zinc tray (Z) into which cold water is placed. Fitting into the zinc tray is another zinc compartment, the floor of which is made of a number of zinc strips (X) transversely arranged and placed in relation to each other like the limbs of an inverted A. The limbs are so disposed that those of one series do not touch the adjacent ones, and in fact a space is left between them. Thus a number of parallel troughs are formed, each of which opens below into the moist air chamber of the cold water tray beneath. In practice these troughs are covered with flannel which is allowed to dip into the water of the tray. Thus the eggs lie in a series of damp troughs and their lower surfaces are therefore damper and colder than their upper ones. This incubator, if carefully worked and the necessary practical details observed, has the reputation of being an efficient machine.

Somewhat similar to the Halsted incubator, but differing from it in the nature of the boiler and in the temperature regulator, is the Graves incubator, made in Boston, U.S.A. The incubator itself (fig. 3) consists of an incubating or egg-drawer (E) heated from above by a warm-water tank (T). Below the egg-drawer is a tank containing cold water, the vapour of which passes through the perforated floor of the former and keeps the air of the egg-chamber slightly humid. Above the warm-water tank is an air chamber (AC) to serve as a non-conducting medium and to prevent there being undue loss of heat. Above this is a nursery or drying chamber (N), closed in, with a movable lid.

The warm-water tank is heated by means of a simple boiler (B) from which an inlet tube (I) carries heated water to the tank; the tube traverses the length of the tank and discharges at its farther end (not shown in the diagram). From the nearer end of the tank an outlet tube (O) passes out and opens into the boiler at a slightly higher level than the inlet one. The boiler is heated by an evenly burning lamp below, of special construction. The rectangular tube through which the wick passes is bevelled at its outer end, and upon this bevelled edge a metal flap (F) is allowed to rest more or less

closely, according as the flame is to be smaller or larger respectively. The wick is, of course, bevelled to correspond to the form of its tube. The metal flap is raised or depressed by means of levers connected with the heat-regulator. When it is depressed upon the wick the flame is lessened; and it becomes proportionately bigger as the flap is raised more and more.

The heat-regulator consists of a glass tube (T) which runs the whole width of the incubation chamber and lies in contact with the floor of the warm-water tank; it is filled with alcohol.

Externally to the incubator this tube is connected with a U-shaped one containing mercury. The free limb of the U-tube contains a piston (P) which rests upon the surface of the mercury in that limb. From the piston a piston rod (PR) passes vertically upwards and is connected with a lever (L) which operates, through the agency of a second lever (L'), the movements of the ventilating valve (V) in set over the orifice of the ventilating shaft (A) which opens from the roof of the incubator drawer. The lever (L) is further connected with a spiral spring (S) which works the metal flap of the lamp already described. The height of the piston in the U tube can be so adjusted, by varying the quantity of mercury in the tube, that when the temperature of the incubation drawer is  $103^{\circ}$  F., the ventilating valves are closed and the wick is burning to its full extent. Should the temperature rise, the alcohol in the glass tube (T) expands and causes the mercury in the free limb of the U tube to rise. This carries with it the piston, and this movement brings about the opening of the ventilating valves, and at the same time, through the agency of the lever (L) and the spiral spring (S) the metal flap is brought down upon the wick, cutting off more or less of the flame. Should the temperature then fall to  $103^{\circ}$  or lower, the contraction of the alcohol reverses these movements, the valve closes, and the wick once more burns to its full extent.

In practice, the boiler and the temperature regulator are duplicated, there being a set on both sides of the incubator. Any slight irregularity on the one side may be thus compensated for by the other side. Graves's incubator has the reputation of being a good machine.

Among the most recent type of incubators made in England is that of Charles Hearson. This differs from any of those described

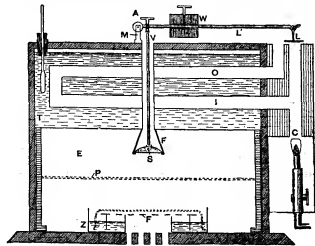

FIG. 4.—Hearson's Incubator.

in the simplicity and ingenuity of the heat regulator, and in that the tubes which traverse the water tank are hot-air flues, carrying the air heated by the flame and not warm water. Consequently a further simplification is introduced inasmuch as no boiler is required.

The essential features of this incubator are shown in fig. 4. The internal parts of the incubator are insulated by a double wall, the interspace being packed by a non-conducting material, which is not shown in the figure. The incubation or egg-drawer (E) is heated by the warm-water tank (T). Beneath the egg-drawer is a zinc tray (Z), so constructed that in the central part the floor is raised up into a short cylinder. Around the raised part the floor is raised up into a wide trough containing water and into this dips a canvas cloth which is stretched out over a perforated zinc support (F). By this means an extended moistened surface is produced which allows of a rapid evaporation.

The floor of the incubator, which is raised by short feet from the table on which it stands, is perforated in the central portion by a number of holes, and which are so situated that they lie beneath the raised cylinder of the cold-water tank (Z). The incubation-drawer is thus supplied continuously by a slow current of moistened air because the air in the upper part of the drawer, i.e. in contact with the floor of the warm-water tank, is the warmest and lightest. It therefore tends to diffuse or pass through the narrow gaps between the drawer and the walls of the incubator, and also through a thermometer is placed in the bottom of the incubator, and on its way must pass through the pores of the damp canvas which dips into the water in the zinc tray (Z).

The warm-water tank is heated by an inlet (I) and outlet (O) flue which are, however, continuous. The inlet flue opens out from a vertical chimney (C) the air in which is heated either by a gas flame or that of an oil lamp. The outlet or return flue passes back through the width of the tank and opens independently to the exterior. The vertical chimney (C) is capped by a lid (L) capable of being raised or lowered upon its orifice by the lever (L'). When the cap is resting upon the chimney all the heated air from within the latter passes through the flues and heats the water in the tank. If the cap is widely raised, practically all the heated air passes directly upwards through the chimney and none goes through the flues. If the cap is but slightly raised, part of the heated air goes through the flues and part directly escapes through the aperture of the chimney. The movement of the lever (L') which raises the cap (L) is determined by the thermostatic capsule (S), situated within the egg-drawer.

The principle upon which this capsule is designed is that the boiling point of a liquid depends not only upon temperature but also upon pressure. A given liquid at ordinary atmospheric pressure will boil at a certain degree of temperature, which varies for different substances. But if the pressure be increased the boiling point of the liquid is raised to a higher degree of temperature. A liquid when it boils passes into a gaseous condition and in this state will occupy a very much larger volume—some two or three hundred times than in the liquid condition. If, therefore, a hermetically sealed capsule with flexible sides be filled with some liquid which boils at a given temperature, the sides of the capsule will distend when the temperature of the air round the capsule has been raised to the boiling point of the liquid within it. The distension of this capsule can be used to raise the lever (L'). The thermostatic capsule is placed on a metallic plate (P) and is filled with a mixture of ether and alcohol, the proportions being such that the boiling point of the mixed liquid is 100° F. Between the capsule and the lever (L') is a vertical rod (V), articulating with the lever as possible to its fulcrum (M). The articulation with the lever is by means of a screw, so that the necessary nice adjustment between the height of the rod (V), the thickness of the capsule and the position of rest of the damper (L) upon the chimney, can be accurately made. The temperature at which it is desired that the liquid in the capsule shall boil can be determined by sliding the weight (W) nearer or farther to the fulcrum of the lever (L'). The farther it is moved outwards, the greater is the pressure upon the thermostatic capsule and consequently the higher will be the boiling point of the liquid. By means of the milled-head screw (A), the height of the cover at its outer end can be so adjusted that when the liquid of the capsule is not boiling the damper (L) closes the chimney, but that when it does boil the damper will be raised sufficiently high from it. If the weight is pushed as far as it will go towards the fulcrum end of the lever, the temperature of the egg-drawer will never rise more than 100° F, because at this temperature and under the pressure to which it is then subjected, the liquid in the capsule boils, and consequently brings about the raising of the damper. It matters not, therefore, how high the flame of the gas or lamp be turned, the temperature of the egg-drawer will not increase, because the extra heat of the enlarged flame is passing directly outwards through the chimney, and is not going through the flues in the tank. In order to raise the temperature within the incubation chamber to 102° or 103°, or any other desired degree, the weight (W) must be moved outwards along the lever (L'), about 1 in. for every degree of temperature increase desired. The thermostatic capsule works admirably, and the incubator will work for months at a time and requires no adjustment, however much, within the limits of our climate, the external temperature may vary. The capsule, like all other thermostats in which the expandible substance is a liquid, is, however, dependent upon external pressure for the point at which its contained liquid boils and therefore, for the degree of temperature prevailing within the incubator drawer. It is therefore responsive to variations in atmospheric pressure, and as the barometer may fall 1 or 2 in., this may possibly make a difference of two or three degrees in the fluctuation of temperature within the egg-drawer. It is not, of course, often that such large oscillations of the barometer occur, and as a matter of practical experience, under ordinary conditions, this incubator will work for months together without attention with only half a degree variation round the point at which it was set.

Greenwood's incubator (fig. 5), named the Bedford, resembles Hearson's in that hot-air flues (F and F') and not hot-water pipes,

traverse the water tank (T). And the method of regulation of the temperature is much the same, i.e. a thermostat (V) operating upon a lever which raises a cap (C) from off the aperture of the main flue (F) and thus allows all the heat of the flame to pass directly outwards, without passing through the series of flues (F) which horizontally

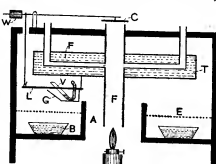

FIG. 5.—The Bedford (Greenwood's) Incubator.

From this, four horizontal flues pass outwards through the water and open into small vertical flues, which in their turn communicate with the exterior.

The thermostat (V) consists of a glass tube of peculiar form. This is closed at the end of its short limb and open at its other extremity on the long limb. The bent portion of the tube is filled with mercury and between the mercury column and the closed end is a small quantity of ether. The thermostat is lodged in a box (C), which forms part of the lever (L). At one end this lever is pivoted to a fixed arm, and at the other to the vertical rod which operates the ventilating cap (C). If the temperature should rise, the ether in the thermostat expands and pushes the mercury column up along the inclined long limb. This disturbs the equilibrium of the lever (L), and it descends downwards, pulling with it the vertical rod, and thus raising the cap over the main flue. If the temperature falls the reverse series of changes occur. The temperature at which the cap will be raised can be adjusted within limits by the position of the weight (W) and by the adjustment of the degree of inclination of the thermostat.

The Proctor incubator, made at Otley, is apparently, in its main features, similar to the Greenwood.

Somewhat similar, in certain features, to the Greenwood is the Winchcombe. Its improved form, in which metal replaces the wood casing, is named the Gladstone. In it there is a combination of the hot-air and the water-tank systems of warming the incubation chamber. The wall of the incubator is double, and the space between the outer and inner wall is packed with a non-conducting material. The incubation chamber is heated above by a water-tank (fig. 6 T)

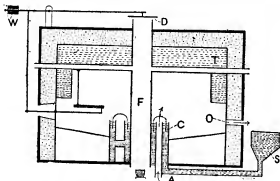

FIG. 6.—The Winchcombe Incubator.

which is traversed by a main vertical flue (F) and four subsidiary horizontal ones which discharge externally. The main flue, however, in passing up to enter the water tank traverses the egg-chamber, and therefore serves to warm it, as in the hot-air type of incubator, by the heat of the flue itself. Around the lower half of the flue is a water vessel consisting of two concentric containers (C), holding a water. In the space between these concentric containers, fresh air passes in through the aperture (A), and before it reaches the egg-chamber it passes through coarse canvas which dips into the water in the containers, and is therefore kept permanently moist. The temperature is regulated by a bimetallic thermostat (see below), which operates two levers, that by their arrangement can raise or depress the cap (D) over the main flue (F). The temperature at which this occurs will be determined, within limits, by the position of the adjustable weight (W).

Tomlinson's incubator, designed in 1880, is novel in principle.

It possesses a very large water tank, holding 15 gallons for every hundred eggs. Through this tank there pass two hot-air horizontal flues, lying in the same plane. The novelty of the construction lies in the great volume of water used and in the disposition of the flues towards the top of the tank. It is said that very little circulation of water takes place beneath the flues, because warmed water rises instead of falling. The great body of water below the flues will therefore only take up heat relatively slowly and will be warmed on account of its bulk and its physical properties, but slowly lose it. Should the flame fall in power, or even go out for ten or twelve hours, it is claimed that no serious loss of efficiency of the apparatus will result.

Regulation of the temperature is by means of an air tube, the air in which expanding bulges out an inradiant diaphragm and this moves a lever. The lever operates a valve which allows more or less of the heated air to escape from the egg-drawer.

(b) *Hot-air Incubators*.—W. H. Hillier's Incubator (fig. 7) is circular in form and is constructed of a double-walled metal case. The space between the two walls is packed with a non-conducting material.

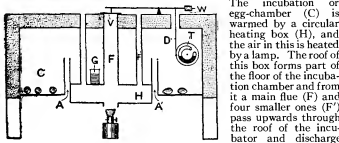

FIG. 7.—Hillier's Incubator.

to the incubator through two tubular channels (A and A') on either side of the heating box and escapes through a hole in the roof, which serves at the same time as a passage for one of the rods (D) in connexion with the temperature regulating apparatus.

This apparatus (T) consists of a glass tube of  $\frac{1}{2}$  in. bore, and which is bent into the form of a circle of 5 in. diameter. The tube is fastened to a wooden disk, which rotates upon a pivot and in so doing operates a vertical rod (D), which in its turn works the cap (V) which covers the orifice of the main flue. The tube is partly filled with mercury and is closed at one end. At this end there is contained some spirit. As the temperature rises, this expands and pushes the mercury column farther along the tube. The equilibrium of the position of spirit is thus disturbed, and the wooden disk consequently rotates, carrying with it the vertical arm, the downward movement of which raises the cap (V) of the flue. The temperature at which it is desired that this valve shall uncover the flue, can be adjusted within the necessary limits by sliding the weight (W) along the horizontal arm and by the amount of mercury present in the bent tube. The air of the incubation chamber is rendered sufficiently moist by the evaporation of water in the vessel (G).

In the Cornell incubator (New York) more personal attention is required than in other forms, since the ventilation of the egg-chamber is not wholly automatic, but is regulated according to the results of observation. The great difficulty in ventilation is the proper combination of fresh air and moisture. The Cornell Incubator Company has endeavoured to obviate this difficulty by carrying out a series of observations on the rate at which evaporation occurs in incubating eggs under natural conditions. The rate of evaporation is measured by the size of the air-space within the egg-shell at successive days. This they have ascertained, and with their incubators they furnish a book of instructions, in which diagrams showing the size of the air space on the 1st, 5th, 10th, 14th and 18th days are given. Examination of the eggs should therefore be made every two or three days, and the result compared with the diagrams. The incubator is provided with an adjustable ventilator and this should be so arranged that evaporation is neither too great nor too little. The ventilator should never be wholly closed, and if when closed to its minimum evaporation is still too great, then water should be placed in the moisture pans. In all cases lukewarm water should be placed in these on the 18th day and the ventilating slide opened wide.

It will thus be seen that in this machine there is an attempt to do away with the addition of water to the incubator drawer during the greater part of the period of incubation, and to rely on the aqueous vapour naturally present in the atmosphere. This attempt is based upon the fact that water vapour is lighter than air, and will therefore rise to the top in any enclosed volume of air. If the direction of the ventilating current is downwards in the incubation chamber, and if it is slow enough, it is thought that the water vapour will be sifted out and tend to accumulate to a sufficient extent in the chamber. In the Cornell incubator consequently the ventilating current passes first upward through an external heater in order to warm it, whence it is then deflected downwards into the egg-chamber and diffuses through its perforated bottom. Then it passes along a space beneath the chamber into a space in the left-hand wall of the incubator and

out to the exterior through an adjustable and graduated ventilating slide.

These incubators are hot-air machines, and the hot-air chamber is situated above the egg-drawer and is traversed by several flues opening out from a main one. The temperature regulating apparatus appears to be similar to that of Hearson's machine and operates by a thermostat, which through the agency of levers opens or closes a valve over the main flue.

The Westermar incubators (Leighton Buzzard) are of two patterns. One type is built on the hot-air principle and the other on the hot-water system. In both forms the heated air from the heating surfaces is deflected down on the eggs and escapes through the perforated bottom of the egg-drawer. The inlet air is first warmed by contact with the main flue. The thermostat is similar to that in the Hillier machine (fig. 7) and consists of a coil mounted on an axis, round which it can rotate. The coil is filled with mercury and is closed at one end. Between this end and the mercury column is a short column of air.

By expansion of the air under a rising temperature, the mercury column is displaced and brings about a rotation of the disk to which the coiled tube containing it is attached. This rotation raises the cap over the main flue.

All the incubators so far described have been constructed with the idea of obtaining as nearly as possible a uniform temperature. But in E. S. Renwick's incubator (America) no attempt is made to obtain uniformity in temperature. On the other hand, it is designed to give a periodical oscillation from one extreme to the other of a limited range, about  $3^{\circ}$  of temperature. This is accomplished by means of a thermostat, made of a mixture of brass and vulcanite fastened together. This is connected with a clockwork and detent arrangement, which simultaneously opens a valve and actuates the lamp flame. The temperature falls to the lower limit of its range before the thermostatic bar is sufficiently bent to set the clockwork arrangement operating in the reverse direction, by which the valve is closed and the lamp flame increased. The temperature then rises to the higher limit, when the bending of the thermostatic bar again releases the detent and the clockwork opens the valve and reduces the flame.

The incubator is said to succeed well. It also possesses a mechanical arrangement by which all the eggs can be periodically turned on rollers at once.

*Size*.—The incubators which have been described are of relatively small size, and the numbers of eggs which they can incubate are strictly limited. For commercial purposes, however, operations of a much larger magnitude are desirable and necessary. And there can be no doubt that for these purposes the incubators of the future will be of great size and will contain from 15,000 to 30,000 eggs or more at a time. Already, at Aratoma Farm, Stamford, New York State, there is established a large incubation room, containing several thousand eggs, and in which the heat regulations are controlled in part by the personal efforts of attendants. It constitutes almost a complete return, with added accessories, to the methods of the Egyptians, and to those of John Channon.

#### Bacteriological Incubators.

These differ from bird incubators in that the heating surface of the incubation chamber generally surrounds all sides of it and there is, as a rule, no special arrangement for bringing about a more or less humid condition of the contained air. In some forms there is an arrangement to ensure a continuous supply of fresh and moist air, but in the majority the incubation chamber obtains its supply of fresh air vicariously. In some forms the chamber of the incubator is heated by a warm water tank of a simple kind, which extends round all its sides. But in other forms a series of tubes or flues passes through the water in this tank and thus simulates in principle the tube boiler. This latter form utilizes the heat of the flame to a greater degree than the former kind. In yet other forms the incubation chamber is heated by warm air chambers which surround it or flues which traverse it. Most bacteriological incubators are square or rectangular in form, but some bacteriologists prefer cylindrical forms, presumably on account of the ratio of volume to surface in connexion with the water tank.

One of the best known and most generally used of the cylindrical and water-tank kind is that of Dr d'Arsonval. It consists of two copper cylinders (fig. 8 C and C'), each terminating in a cone below. Between the cylinders is a wide interspace, in order that a large volume of water may be contained. This interspace therefore constitutes the water-tank of the incubator. The upper orifice of the inner cylinder is closed by a movable double lid, which contains an interspace filled with water. The outer cylinder has an oblique form at its upper end and is permanently closed. The result attained by this slope of the lid of the outer cylinder is that the water tank, which is fed from the highest point, becomes completely filled. The aperture at the highest point of the outer cylinder is plugged with a caoutchouc plug and through a perforation in this a glass tube (T) is placed. In,



the side of the outer cylinder below this, there is a wide and rimmed aperture, to which a gas regulator of special construction is fixed.

This regulator was designed by Théophile Schloesing, and consists of a brass box, supplied with a rim (L) which fits on to the corresponding rim (L') on the aperture of the incubator. Stretching across the orifice thus connecting the brass box of the regulator with

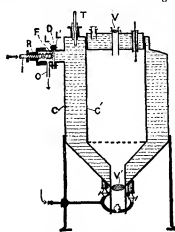

FIG. 8.—D'Arsonval Incubator.

the water-tank of the incubator is a thin india-rubber diaphragm (D). At its outer end a perforated cap (R) screws on to the brass box. Through the perforation the inlet gas tube passes (I); the outlet gas tube (O) leaves the brass box below and passes direct to the gas burners. The inlet gas tube is fitted at its inner end with a sliding flanged collar (F), which is kept pressed against the rubber diaphragm by a spiral spring. Just behind the collar the inlet tube is perforated by a small hole, so that the gas supply is never wholly cut off, even though the rubber diaphragm completely occludes the inner aperture of the pipe. The mode of working of the regulator is as follows: when the water tank of the incubator is filled with distilled or rain water at the temperature required, it presses upon the india-rubber diaphragm with a certain degree of pressure. By screwing the inlet pipe in or out, as required, it can be so adjusted that the diaphragm does not occlude its inner aperture, and consequently the full volume of gas can pass through to the burners below. The temperature of the water in the water-tank therefore begins to rise, and in consequence the volume of the water to increase. This results in the water rising up into the tube (T), and therefore the dynamical pressure which is exercised by the water upon every part of the two cylinders of the incubator and consequently also upon the india-rubber diaphragm of the regulator is increased. As this pressure increases, the diaphragm becomes bulged outwardly and reduces the volume of gas passing through the aperture of the inlet pipe. At a certain point, of course, the diaphragm completely occludes the aperture, and the gas supply is wholly cut off, except for the very small hole, forming a by-pass, in the pipe, behind the collar. This hole is just sufficiently big to allow the minimum amount of gas requisite to keep the flames burning to pass through. The temperature will, therefore, begin to fall, the volume of water to decrease with its resulting descent from the glass tube (T) and consequent decrease in the dynamical pressure of the water upon the diaphragm. The latter therefore retracts away from the aperture of the inlet tube, and more gas consequently passes through; the flames again increase in size and the temperature rises once more. And as soon as the volume of water, owing to the rising temperature, has increased to the extent correlated with the temperature at which the apparatus has been set to work, it will have risen once more in the tube (T), and the gas will be again cut off. The three burners are placed upon a support that can be moved vertically up or down along one of the legs of the incubator. The flames are protected from draughts by mica chimneys. Ventilation is provided by an adjustable valve (V) in the cylindrical termination of the incubator at its lower end, and by tubular orifices, also fitted with valves (V) in the lid above.

The incubator is very reliable and may be worked within very narrow limits of variation, provided that the gas-supply be regulated by a gas-pressure regulator, that the height of the water in the tube (T) is maintained by daily additions of a few drops of distilled water, and that the incubator itself be protected from draughts.

Another form of d'Arsonval incubator has a glass door in the side of it and a slightly modified form of the heat regulator.

Other cylindrical forms of incubators are made by Lequeux of Paris. In one of these the heat regulator is a bimetallic thermostat, the movements of which are enlarged by a series of levers, so that a valve can be automatically adjusted to allow more or less heat from the flame to pass through the heating flue.

In another form there is a movable interior, and an arrangement for keeping the air in the incubation chamber saturated. It is governed by a bimetallic thermostat of the Roux type.

In Dr Hüppe's improved form of his incubator, which is approximately square in form, the double-walled water tank is completely surrounded externally by an air chamber, which is heated by the passage through it of the products of combustion of two flames. The heated gases escape through an adjustable aperture at the top. In the earlier form the water tank was traversed by a number of hot-air flues, and there was consequently no external hot-air chamber. There is an arrangement of tubes for ventilation, which allow fresh air to enter the lower part of the incubation chamber and to leave it at the top. The incoming air is warmed before it enters. The walls are made of lead-coated steel, and externally the incubator is covered

with linoleum. In the more expensive forms the inner chamber is of copper. The temperature may be controlled by any of the simpler mercury thermostats described below.

Dr Babes' incubator is somewhat similar, but the water tank is not surrounded by a hot-air chamber. Instead it is traversed by a number of vertical flues through which the heated gases from the flames pass. Ventilation is provided for and there is an apparatus for controlling the humidity of the air in the incubation chamber. As in Hüppe's incubator, the bottom is conical in form. The walls of the incubator are of lead-coated steel, and externally they are covered with linoleum; there are two doors, an inner one of glass and an outer one of metal. The temperature may be controlled as in Hüppe's incubator.

Hearson has designed several forms of bacteriological (biological) incubators, made by Chas. Hearson & Co., Ltd. Some are heated by a petroleum lamp and others by a gas flame. In the form heated by a lamp, for which, however, gas can be substituted, the incubation chamber is surrounded by a water tank (fig. 9, A) and the lowest part

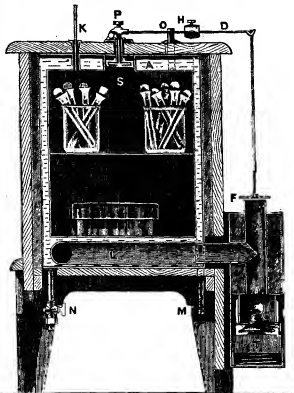

FIG. 9.—Hearson's Bacteriological Incubator. (Heated by a petroleum lamp.)

of this is traversed by an in-going (L) and an out-going flue. The mode of regulation of the temperature is by means of a thermostat which operates the movements of a cap (F) over the main flue (V), and it is identical in his chief features with the method employed in the chicken incubator. The thermostat (S) is situated in the upper part of the incubation chamber.

In the other form (fig. 10) for which gas is used exclusively, there are no flues traversing the water tank. This latter is heated from its conical floor by a burner beneath the incubator. The heat regulation is controlled by a thermostat of the same nature as in the form of incubator just described, but instead of operating by lowering or raising a cap over a main flue, so as to direct the heated gases either through the water tank if the temperature is falling, or through the main flue directly to the exterior if it is rising, it actuates a gas-governor, so that the flame itself is increased or diminished in size according to the needs of the incubator. The gas-governor (fig. 11) is fixed to the roof of the incubator. The horizontal arm (D) is the same that raises the cap (fig. 9, F) over the flue in the other form of incubator, but in this case it simply acts as the bearer of the sliding weight. Beyond its fulcrum (fig. 11, G) it is continued into a detent-like spur (B) which pushes down upon a button attached to a rubber diaphragm, when the thermostat within the incubator is expanded by a rise in temperature. The button thus forced down, more or less completely closes the inlet gas aperture, and so reduces or cuts off the gas supply to the flame. There is a by-pass to prevent the flame from going out completely, and the size of this can be adjusted by the screw (S). Hearson's incubators have the reputation of very accurate performance and practically need no attention for months, or even years.

Schreibaux's incubator is a hot-air form. Its walls are of metal,

but it is cased externally with wood, which serves as the insulating material. Against the inner metal wall of the incubator, and upon its internal surface, there are disposed a number of vertical tubes,

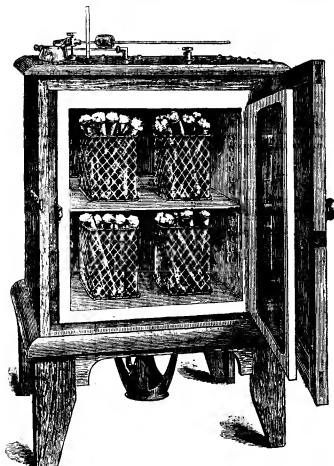

FIG. 10.—Hearson's Bacteriological Incubator (heated by a gas flame).

which open through the roof above into a common discharging funnel. Below, at the bottom of the incubator they receive the heated gases of several burners, which as they pass through them radiate their heat evenly throughout the incubation chamber.

In each side wall, at the bottom of the chamber, is an adjustable ventilating valve.

Inside the incubation chamber, and situated against its left-hand wall, is a U-shaped bi-metallic thermostat of the Roux design, described below. This very accurately controls the temperature of the incubator.

(c) *Cool Incubators.*—In bacteriological laboratories there are two standards of temperature, one chiefly for the culture of non-pathogenic organisms and the other for the pathogenic forms. The first standard of temperature lies between 18° and 20° C., and the second between 35° and 38° C. But in hot countries, and ever in temperate regions during the summer, the external temperature is much higher than the former of these two standards, with the result that many cultures, especially the gelatine ones, are spoiled. The difficulty is often partially overcome by running cold water through the incubator.

Hearson, however, has constructed a "cool biological incubator," in which by an ingenious device the expansion or contraction of the thermostatic capsule deflects a horizontal pipe (C) (fig. 12), through which cold water from an ordinary tap is kept running in one of two directions. If it is deflected so as to open into the tube (D), the cold water passes into the tank (F), where it is warmed by a gas flame, and thence it passes into the water-jacket of the incubator. If it is deflected so as to open into the pipe (E), it then runs through the ice tank (B), containing broken ice, before passing through the water-

jacket of the incubator. If it poured into neither of these pipes it then simply passes out through the pipe (H) to the waste pipe (N). By this device the temperature of the incubator can be kept constant at any desired point, even though it may be some 30° to 40° C. below that of the external air.

Dr Roux has also designed an incubator which can be maintained at a constant temperature below that of the surrounding air. This also depends upon the principle of carrying water through an ice-safe, which then traverses a pipe within the incubator chamber before passing into the water-jacket of the machine. The heat-regulating apparatus is a bimetallic thermostat. The incubator is made by Lequeux of Paris.

The most recent forms of all kinds of incubators, made by Hearson of London, Lequeux of Paris and Lautenschläger of Berlin are both heated and regulated by electricity. The heating is accomplished by electric radiators.

In Hearson's machines the regulation of the temperature is brought about by the breaking or making of the electric current, through the

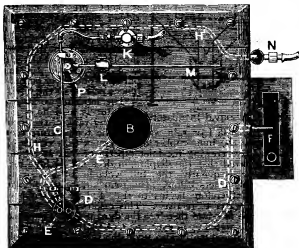

FIG. 12.—Hearson's Cool Biological Incubator.

lifting or depression of a platinum contact, actuated by the expansion or contraction of the thermostatic capsule.

In Roux's apparatus, made by Lequeux, the make and break is attained by the movement of one limb of a bimetallic thermostat, and in some forms a resistance coil and rheostat are placed in the circuit.

At the Pasteur Institute in Paris, and at other large laboratories in France, the bacteriological incubator is raised to the dimensions of a room. In the centre of this room is a large boiler heated by gas-burners, the fumes from which pass through a large flue to the outside. The flame of the burners is regulated by a bimetallic thermostat. The gas by-pass can be regulated by an attendant. The cultures are contained in vessels placed on shelves, which are ranged round the side of the room.

#### Human Incubators.

The first incubator designed for rearing children who are too weak to survive under normal conditions, or who are prematurely born, is that of Dr Tarnier. It was constructed in 1880 and was first used at the Paris Maternity Hospital. Its form is that of a rectangular box measuring 65×30×50 centimetres (fig. 13). It is divided into an upper and lower chamber; the former contains the infant, while the latter serves as a heating chamber, and in reality is simply a modified water-tank. The partition (P) which divides the incubator into two chambers does not extend the whole length of it, so that the upper and lower chambers are at one end of the apparatus in communication with each other. It is through this passage that the heated air from the lower chamber passes into the upper one containing the infant. The narrow bottom chamber C serves to prevent loss of heat from the base of the water-bottles. The

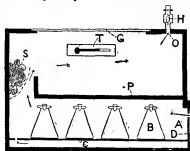

FIG. 13.—Tarnier's Incubator.

outside air is admitted into the lower chamber at the opposite end, through an aperture (A), and passing over a series of bottles (B) containing warm water, becomes heated. The air is rendered adequately moist by means of a wetted sponge (S) which is placed at the entrance of the lower chamber into the upper. The warmed and moistened air is determined in its direction by the position of the outlet aperture (O), which is situated above and just behind the head of the infant. It contains a helix valve (H) and the rotation of this is an indication that the air is circulating within the incubator.

The child is kept under observation by means of a sliding glass door (G) situated in the upper or roof wall of the incubator. Immediately beneath this, and attached to one of the side walls, is a thermometer (T) which records the temperature of the air in the infant-chamber. The temperature should be maintained at 31° to 32° C. The precise limit of temperature must of course be determined by the condition of the child; the smaller and weaker it is, the higher the temperature must be.

The warm water vessels contain three-quarters of a pint of water and four of them are sufficient to maintain the required temperature, provided that the external air does not fall below 16° C. The vessels are withdrawn and replaced through an entrance to the lower chamber, and which can be opened or closed by a sliding door (D).

The walls of the incubator, with the exception of the glass sliding door, are made of wood 25 millimetres thick.

The apparatus appears to have been successful, if by success is understood the indiscriminate saving of life apart from all other considerations, since the mortality of infants under 2000 grammes has been reduced by about 30%, and about 45% of children who are prematurely born are saved.

Dr Tarnier's apparatus requires constant attention, and the water in the warm water vessels needs renewing sufficiently often. It is not provided with a temperature regulator and consequently fluctuations of internal temperature, due to external thermal variations, are liable to occur.

In Hearson's Thermostatic Nurse these drawbacks are to a large extent obviated. This "Nurse" consists fundamentally of an application of the arrangements for heating and moistening the air and for regulating the temperature of Hearson's chick incubator to Dr Tarnier's human incubator. As in this latter form, there are two chambers (fig. 14), an upper (A) and a lower (B), connected with each other in the same way as in Tarnier's

to the infant chamber and ultimately leaves this through a series of perforations round the top. The air in both chambers is heated by a warm-water tank. This tank forms the partition which divides the incubator into upper and lower chambers and is made of metal. Through the water contained in it, an incoming (R) and an outgoing (R) to the left flue, continuous with each other, pass. These two flues are related to each other as in the chick incubator (see above) and the inlet flue is heated in the same way and the outlet flue discharges similarly. The heat-regulating apparatus is identical with that in the chick incubator, and the thermostatic capsule (S) is placed in the upper chamber, near the head of the infant.

The child is placed in a basket which has perforated walls, and is open above. The basket rests upon two shallow supports (D) situated on the upper surface of the water-tank partition. The child is kept under observation through a glass door in the upper or roof-wall of the incubator.

In Great Britain this apparatus is in use at various hospitals and workhouses throughout the country, and provided there is no great fluctuation of barometric pressure, it maintains a uniform temperature.

*Thermo-Regulators or Thermostats.*

Certain special forms of thermo-regulators, adapted to the requirements of the particular incubators to which they are attached, have already been described. It remains now to describe other forms which are of more general application. Only those kinds will be described which are applicable to incubators. The special forms used for investigations in physical-chemistry are not described. There are various types of thermo-regulators, all of which fall into one of two classes. Either they act through the expansion of a solid, or through that of a liquid. They are so adjusted, that, at a certain temperature, the expansion of the material chosen causes the gas supply to be nearly completely cut off. The gas flame is prevented from being wholly extinguished by means of a small by-pass.

We will first describe those which act through the expansion of a liquid. A very efficient and cheap form is that described by F. J. M. Page in the *Journal of the Chemical Society* for 1876. The regulator consists of a glass bulb (fig. 15 B), continuous above with a tubular limb (L). At the upper part of the regulator is a lateral tubular arm (A) which bends downwards and constitutes the outlet pipe. At the upper extremity of the limb there is a short and much wider tube (T), the lower end of which slides upwards or downwards along it.

The upper end of this wider tube is closed by a cork and through a perforation in this a very small glass tube (G) passes downwards into the limb of the regulator to a point a short distance below the exit of the outlet tube. The exact height of the lower aperture of the small tube can be varied by sliding the wider tube up or down along the limb. The by-pass (P) consists of a transverse connexion between the inlet and outlet gas pipes, and the amount of gas which travels through the short circuit thus formed is regulated by means of a stopcock. The by-pass, however, can be formed, as suggested by Schäfer (*Practical Histology*, 1877, p. 80), by making an extremely small hole in the small inlet tube, a little way above its lower extremity. Too much gas will be allowed to pass, and a sufficiently low temperature therefore unattainable. The regulator is filled with mercury until the top of the column reaches within 1/4 in. of the exit of the outlet tube, the bulb is placed in the incubator chamber, and gas is allowed to pass through it.

By pushing down the inner inlet tube (G) until its aperture is immersed beneath the mercury, the gas supply is cut off, with the exception of that passing through the by-pass. The stopcock is now turned until only the smallest flame exists. The inlet pipe is then raised again above the mercury, and the flame consequently increases in size. As the temperature of the incubator gradually rises, and when the desired degree is reached, the inlet tube is pushed down until the end is just beneath the surface of the mercury. The



FIG. 14.—Hearson's "Thermostatic Nurse."

apparatus. The upper chamber contains the infant, but the lower is not a heating but a moistening chamber. Through apertures (M) in the bottom of the lower chamber, the external air passes through, and as in the chick incubator it then passes through perforations in the inner cylinder of a water tray (O) and thence over the surface of the water in the way through a sheet of wet canvas, to the chamber itself. Hence it passes

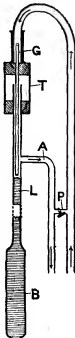

FIG. 15.—Page's Thermostat.

gas supply is thus cut off at the desired temperature. If the temperature of the incubator falls, the mercury contracts, the aperture of the inlet tube is uncovered, the gas supply is renewed and the flame increased. The temperature will then rise until the required point is reached, when the gas supply will again be cut off. A uniform temperature which oscillates within a range of half a degree is thus attained.

Reichert's Thermo-regulator (fig. 16) is another simple and also an earlier form. The stem (S) of the regulator is enlarged above and receives a hollow T-piece (P), the vertical limb of which fits accurately into the enlarged end of the stem, and one end of the cross-limb receives the inlet gas pipe; the other end is closed. The vertical limb of the T-piece is narrowed down at its lower extremity and opens by a small aperture.

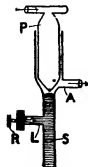

FIG. 16.—Reichert's Thermo-Regulator.

There are several modifications of Reichert's original form. In one of these the screw arrangement in the lower arm is replaced by a piston rod working in a narrow bore of a vertically bent limb of the arm. In another form, the other end of the cross bar of the T-piece is open and leads through a stopcock to a third arm, which opens into the enlarged upper end of the stem opposite to the outlet arm (A); this modification acts as an adjustable by-pass and replaces the minute aperture in the side of the vertical limb of the T-piece.

In Babes' modification the gas supply is cut off, not by the occlusion by the rising mercury of the aperture of the T-piece, but by a floating beaded wire-valve. The aperture of the vertical limb of the T-piece (P) is traversed by a fine wire which is enlarged at both ends into a bead-like knob. The wire fits loosely in the aperture and not only therefore works easily in it, but allows gas to freely pass. When the lower bead-like knob, however, is raised by the expansion of the mercury, the gas supply is cut off by the bead being carried up against the orifice.

Cuccatti's thermo-regulator (fig. 17) is an exceedingly simple and ingenious form. The stem (S) of the regulator is enlarged below into a bulb, while above it divides into a V. The two limbs of the V are of course traversed by a canal and they are connected above by a tubular cross bar (C). In the middle of this there is a stopcock situated between the two points where the bar joins the limbs of the V. One end of the cross-tube serves as an inlet and the other as an outlet for the gas. The stopcock serves as an adjustable by-pass. About an inch below the point where the two limbs of the V join the stem, the bore of the latter is enlarged, and it leads into a lateral arm (A), containing a screw (R), similar to the corresponding arm in Reichert's regulator. When the mercury rises, and reaching the point when the two limbs of the V meet occludes the orifice to both and thus cuts off the gas supply, except that which is passing through the by-pass of the stopcock. The temperature at which this occlusion will take place can be determined by the screw in the lateral arm. The more this is screwed in, the lower will be the temperature at which the gas becomes cut off, and vice versa.

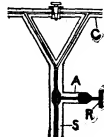

FIG. 17.—Cuccatti's Thermo-Regulator.

Bunsen's, Kemp's and Muenke's regulators are in reality of the nature of air-thermometers, and act by the expansion and contraction of air, which raises or lowers respectively a column of mercury; this in its turn results in the occlusion or opening of the gas aperture. Such forms, however, are subject to the influence of barometric pressure and an alteration of 0.5 in. of the barometer column may result in the variation of the temperature to as much as 2°.

Lothar Meyer's regulator is described in the *Berichte of the German Chemical Society*, 1883, p. 1080. It is essentially a liquid thermometer, the mercury column being raised by the expansion of a liquid of low boiling-point. The liquid replaces the air in Bunsen's and other similar forms. The boiling-point of this liquid must be below the temperature required as constant.

The solid forms of thermostats are constructed upon the same principle as the compensation balance of a watch or the compensation pendulum of a clock. This depends upon the fact that the

co-efficient of expansion is different for different metals. It therefore results that if two bars of different metals are fastened together along their lengths (fig. 18, Z and ST) with the same rise of temperature one of these will expand or lengthen more than the other.

And since both are fastened together and must therefore accommodate themselves within the same linear area, it follows that the compound rod must bend into a curved form, in order that the bar of greater expansion may occupy the surface of greater length, i.e. the convex one. Conversely, when the temperature falls, the greater degree of contraction will be in the same bar, and the surface occupied by it will tend to become the concave one. If, then, one end of this compound rod be fixed and the other free, the latter end will describe a backward and forward movement through an arc of a circle, which will correspond with the oscillations of temperature. This movement can be utilized by means of simple mechanical arrangements, to open or close the stopcock of a gas supply pipe.

In the construction of this type of thermostat it is obvious that the greater the difference in the co-efficient of expansion of the two metals used, the larger will be the amplitude of the movement obtained. Steel and zinc are two metals which satisfy this condition. The co-efficient of steel is the lowest of all metals and is comparable in its degree with that of glass. Substances which are not metals, such as vulcanite and porcelain, are sometimes used to replace steel, as the substance of low co-efficient of expansion.

The bimetallic thermostat most commonly employed is one of the two forms designed by Dr Roux. In one of these forms the compound bar is straight (fig. 18) and in the other it is U-shaped (fig. 19). In the former type the bar itself is enclosed in a tube (T) of metal, the wall of which is perforated. Towards the open end of this tube the gas box or case (C) is fixed. In the U-shape form it is attached to the outer surface (zinc) of one limb of the bar. The gas box is capable of adjustment with respect to its distance from the bar, by means of a screw (S) and a spiral spring (SP).

The bimetallic thermostat most commonly employed is one of the two forms designed by Dr Roux. In one of these forms the compound bar is straight (fig. 18) and in the other it is U-shaped (fig. 19). In the former type the bar itself is enclosed in a tube (T) of metal, the wall of which is perforated. Towards the open end of this tube the gas box or case (C) is fixed. In the U-shape form it is attached to the outer surface (zinc) of one limb of the bar. The gas box is capable of adjustment with respect to its distance from the bar, by means of a screw (S) and a spiral spring (SP), which moves the box outwards or inwards along a rod (R). This adjustment enables the degree of temperature at which it is desired that the gas shall be cut off to be fixed accurately, and within a certain more or less extended range. The inlet and the outlet pipe are disconnected from each other in the gas box by means of a piston-like rod (P) and valve (V), which slides backwards and forwards in the tubular part (T) of the box, from which the outlet pipe emerges. When the valve (V) rests upon the edge of this box, the gas is completely cut off from passing through the outlet pipe, with the exception of that which passes through an

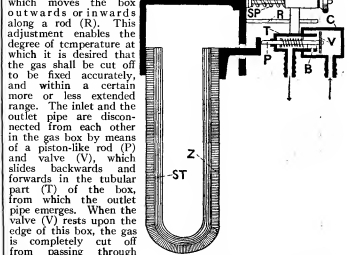

FIG. 19.—Dr Roux's Thermostat (U-shaped bar).

excessingly small aperture (B), serving as a by-pass. This is just large enough for sufficient gas to pass to maintain a small flame. The piston-like rod and valve, when free, is kept pressed outwards by means of a spiral spring. This ensures that the valve shall follow the movements of the compound bar. When this bar bends towards the gas box owing to a fall of temperature, the valve is pushed back away from the orifice and gas in increasing quantity passes through. The temperature of the incubator begins then to rise, and the zinc bar (Z) expanding more than the steel one (ST), the bar bends outwards and the valve once more cuts off the gas supply.

(c) Gas-Pressure Regulators.—The liquid form of thermo-regulators especially work with a greater degree of accuracy if they are combined with some apparatus which controls the variations in gas pressure. There are various forms of these regulators, most of which are figured and sometimes partially described in the catalogues of various

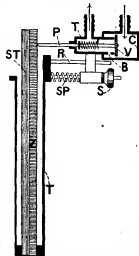

FIG. 18.—Dr Roux's Thermostat (straight bar).

makers of scientific instruments. It will suffice if we describe two forms, one of which (that of Buddicom) can be made by a laboratory attendant of average intelligence.

In R. A. Buddicom's gas regulator (fig. 20) the inlet (I) and outlet (O) gas pipe open into a metal bell (B), the lower and open end of which is immersed beneath water contained in a metal tray (T). The bell is suspended upon the arm of a balance (B) and the other arm is poised by a weight (W). This weight may be made of any convenient material. In the original apparatus a rest-tube partially filled with mercury was used. The weight dips into one limb of a U-shaped glass tube (U), which contains mercury. Into the other limb of this tube the gas from the meter enters through a glass tube (G) which is held in position by a well-fitting cork. The internal aperture of the tube (G) is very oblique, and it rests just above the level of the mercury when the instrument is finally adjusted. This adjustment is better made the morning when the gas pressure in the main is at its lowest. Just above the internal aperture of the tube (G), a lateral tube (L) passes out from the limb of the U and is connected with the inlet pipe (I) of the bell. If the gas pressure rises, the bell (B) is raised and the counter-poising weight (W) is proportionately lowered. This forces the mercury up in the other limb of the U-tube and consequently diminishes the size of the oblique orifice in the tube (G). Some of the gas is thus cut off and the pressure maintained constant. Should the pressure fall, the reverse processes occur, and more gas passes through the orifice of G and consequently to the burner by the outlet tube (O).

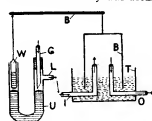

FIG. 20.—Buddicom's Gas Regulator.

connected with the inlet pipe (I) of the bell. If the gas pressure rises, the bell (B) is raised and the counter-poising weight (W) is proportionately lowered. This forces the mercury up in the other limb of the U-tube and consequently diminishes the size of the oblique orifice in the tube (G). Some of the gas is thus cut off and the pressure maintained constant. Should the pressure fall, the reverse processes occur, and more gas passes through the orifice of G and consequently to the burner by the outlet tube (O).

Moitessier's regulator (fig. 21) is more complex, and needs more skilled work in its construction. It consists of an outer and closed cylinder (O), which is filled about half-way up with a mixture of acid-free glycerine and distilled water in the proportion of two to one respectively. Within the cylinder is a bell (B), the lower and open end of which dips under the glycerine-water mixture. From the top of the bell a vertical rod (R) passes up through an aperture

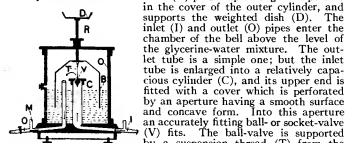

FIG. 21.—Moitessier's Gas Regulator.

in the cover of the outer cylinder, and supports the weighted dish (D). The inlet (I) and outlet (O) pipes enter the chamber of the bell above the level of the glycerine-water mixture. The outlet tube is a simple one; but the inlet tube is enlarged into a relatively capacious cylinder (C), and its upper end is fitted with a cover which is perforated by an aperture having a smooth surface and concave form. Into this aperture an accurately fitting ball- or socket-valve (V) fits. The ball-valve is supported by a suspension thread (T) from the roof of the bell. The apparatus should be adjusted in the morning when the pressure is low, and the dish (D) should be then so weighted that the full amount of gas passes through. The size of the flame should then be adjusted. Should the pressure increase, the bell (B) is raised and with it the ball-valve (V). The aperture in the cover of the inlet cylinder is consequently reduced and some of the gas cut off. When the pressure falls again, the ball-valve is lowered and more gas passes through. The relative pressure in the inlet and outlet pipes can be read off on the manometer (M) placed on each of these tubes.

Leveling screws adjust the apparatus being horizontally adjusted. The friction engendered by the working of the vertical rod (R) through the aperture in the collar of the cylinder cover is reduced to a minimum by the rod being made to slide upwards or downwards on three vertical knife-edge ridges within the aperture of the collar.

**AUTHORITIES.**—Charles A. Cyphers, *Incubation and its Natural Rearing* (1776); J. H. Barlow, *The Art and Method of Hatching and Rearing all Kinds of Domestic Poultry and Game Birds by Steam* (London, 1827); and *Daily Progress of the Chick in the Egg during Hatching in Steam Apparatus* (London, 1824); Walthew, *Artificial Incubation* (London, 1824); William Bucknell, *The Eccelesin. A Treatise on Artificial Incubation*, in 2 parts (published by the author, London, 1839); T. Christy, jun., *Hydro-Incubation* (London, 1877); L. Wright, *The Book of Poultry* (2nd ed. London, 1893); J. H. Sutcliffe, *Incubators and their Management* (Upcott Gill, London, 1896); H. H. Stoddard, *The New Egg Farm* (Orange Judd Co., New York, 1900); Edward Brown, *Poultry Keeping as an Industry* (5th ed., 1904); F. J. M. Page, "A Simple Form of Gas Regulator," *Journ. Chem. Soc.*, 1. 24 (London, 1876); V. Babes, "Über einige Apparate zur Bacterienuntersuchung," *Centralblatt für Bacteriologie*, iv. (1888); T. Hüppe, *Methoden der Bacterienforschungen* (Berlin, 1889). For further details of bacteriological incubators and accessories see catalogues of Gallenkamp, Baird & Tatlock, Hearson of London,

and of the Cambridge Scientific Instrument Company, Cambridge; of P. Lequeux of Paris; and of F. & M. Lautenschläger of Berlin. That of Lequeux and of the Cambridge Company are particularly useful, as in many instances they give a scientific explanation of the principles upon which the construction of the various pieces of apparatus is based. (G. P. M.)

**INCUBUS** (a Late Latin form of the classical *incubo*, a nightmare, from *incubare*, to lie upon, weigh down, brood), the name given in the middle ages to a male demon which was supposed to haunt women in their sleep, and to whose visits the birth of witches and demons was attributed. The female counterparts of these demons were called *succubae*. The word is also applied generally to an oppressive thing or person.

**INCUMBENT** (from Lat. *incumbere*, to lean, lie upon), a general term for the holder (rector, vicar, curate in charge) of an ecclesiastical benefice (see *BENEFICE*). In Scotland the title is generally confined to clergy of the Episcopal Church. The word in this application is peculiar to English. Du Cange (*Glossarium*, s.v. "Incumbens") says that the *Jurisconsulti* use *incumbere* in the sense of *obtinere, possidere*, but the sense may be transferred from the general one of that which rests or is laid on one as a duty which is also found in post-classical Latin; to be "diligently resident" in a parish or benefice, has also been suggested as the source of the meaning.

**INCUNABULA**, a Latin neuter-plural meaning "swaddling-clothes," a "cradle," "birthplace," and so the beginning of anything, now curiously specialized to denote books printed in the 15th century. Its use in this sense may have originated with the title of the first separately published list of 15th-century books, Cornelius a Beugheim's *Incunabula typographiae* (Amsterdam, 1688). The word is generally recognized all over Europe and has produced vernacular forms such as the French *incunables*, German *Incunabeln* (*Wiegendrucke*), Italian *incunabili*, though the anglicized *incunables* is not yet fully accepted. If its original meaning had been regarded the application of the word would have been confined to books printed before a much earlier date, such as 1475, or to the first few printed in any country or town. By the end of the 15th century book-production in the great centres of the trade, such as Venice, Lyons, Paris and Cologne, had already lost much of its primitive character, and in many countries there is no natural halting-place between 1490 and 1520 or later. The attractions of a round date have prevailed, however, over these considerations, and the year 1500 is taken as a halting-place, or more often a terminus, in all the chief works devoted to the registration and description of early printed books. The most important of these are (i) Panzer's *Annales typographici ab artis inventae origine ad annum MD.*, printed in five volumes at Nuremberg in 1793 and subsequently in 1803 carried on to 1536 by six additional volumes; (ii) Hain's *Repertorium bibliographicum in quo libri omnes ab arte typographica inventa usque ad annum MD. typis expressi ordine alphabetico vel simpliciter enumerantur vel adcuratius, recensentur* (Stuttgart, 1826-1838). In Panzer's *Annales* the first principle of division is that of the alphabetical order of the Latin names of towns in which incunabula were printed, the books being arranged under the towns by the years of publication. In Hain's *Repertorium* the books are arranged under their authors' names, and it was only in 1801 that an index of printers was added by Dr Konrad Pruter. In 1808 Robert Proctor published an *Index to the Early Printed Books in the British Museum: from the invention of printing to the year M.D., with notes of those in the Bodleian Library*. In this work the books were arranged as far as possible chronologically under their printers, the printers chronologically under the towns in which they worked, and the towns and countries chronologically in the order in which printing was introduced into them, the total number of books registered being nearly ten thousand. Between 1898 and 1902 Dr W. Copinger published a *Supplement to Hain's Repertorium*, described as a collection towards a new edition of that work, adding some seven thousand new entries to the sixteen thousand editions enumerated by Hain. From the total of about twenty-three thousand incunabula thus registered considerable deductions must be made for duplicate entries and undated editions which probably

belong to the 16th century. On the other hand Dr Copinger's *Supplement* had hardly appeared before additional lists began to be issued registering books unknown both to him and to Hain, and the new *Reperitorium*, begun in 1905, under the auspices of the German government, seemed likely to register, on its completion, not fewer than thirty thousand different incunabula as extant either in complete copies or fragments.

In any attempt to estimate the extent to which the incunabula still in existence represent the total output of the 15th-century presses, a sharp distinction must be drawn between the weightier and the more ephemeral literature. Owing to the great religious and intellectual upheaval in the 16th century much of the literature previously current went out of date, while the cumbersome early editions of books still read were superseded by handier ones. Before this happened the heavier works had found their way into countless libraries and here they reposed peacefully, only sharing the fate of the libraries themselves when these were pillaged, or by a happier fortune amalgamated with other collections in a larger library. The considerable number of copies of many books for whose preservation no special reason can be found encourages a belief that the proportion of serious works now completely lost is not very high, except in the case of books of devotion whose honourable destiny was to be worn to pieces by devout fingers. On the other hand, of the lighter literature in book-form, the cheap romances and catchpenny literature of all kinds, the destruction has been very great. Most of the broadsides and single sheets generally which have escaped have done so only by virtue of the 16th-century custom of using waste of this kind as a substitute for wooden boards to stiffen bindings. Excluding these broadsides, &c., the total output of the 15th-century presses in book form is not likely to have exceeded forty thousand editions. As to the size of the editions we know that the earliest printers at Rome favoured 225 copies, those at Venice 300. By the end of the century these numbers had increased, but the soft metal in use then for types probably wore badly enough to keep down the size of editions, and an average of 500 copies, giving a possible total of twenty million books put on the European market during the 15th century is probably as near an estimate as can be made.

Very many incunabula contain no information as to when, where or by whom they were printed, but the individuality of most of the early types as compared with modern ones has enabled typographical detectives (of whom Robert Proctor, who died in 1903, was by far the greatest) to track most of them down. To facilitate this work many volumes of facsimiles have been published, the most important being K. Burger's *Monumenta Germaniae et Italiae Typographica* (1892, &c.), J. W. Holtrop's *Monuments typographiques des Pays-Bas* (1868), O. Thierry-Poux's *Premiers monuments de l'imprimerie en France au XV<sup>e</sup> siècle* (1890), K. Haebler's *Typographie ibérique du quinzième siècle* (1901) and Gordon Duff's *Early English Printing* (1896), the publications of the Type Facsimile Society (1700, &c.) and the *Woolley Facsimiles*, a collection of five hundred photographs, privately printed.

In his *Index to the Early Printed Books at the British Museum* Proctor enumerated and described all the known types used by each printer, and his descriptions have been usefully extended and made more precise by Dr Haebler in his *Typenreperitorium der Wiegendrucke* (1905, &c.). With the aid of these descriptions and of the facsimiles already mentioned it is usually possible to assign a newly discovered book with some certainty to the press from which it was issued and often to specify within a few weeks, or even days, the date at which it was finished.

As a result of these researches it is literally true that the output of the 15th-century presses (excluding the ephemeral publications which have very largely disappeared) is better known to students than that of any other period. Of original literature of any importance the half-century 1450-1500 was singularly barren, and the zeal with which 15th-century books have been collected and studied has been criticized as excessive and misplaced. No doubt the minuteness with which it is possible to make an

old book yield up its secrets has encouraged students to pursue the game for its own sake without any great consideration of practical utility, but the materials which have thus been made available for the student of European culture are far from insignificant. The competition among the 15th-century printers was very great and they clearly set to press every book for which they could hope for a sale, undaunted by its bulk. Thus the great medieval encyclopaedia, the *Specula* (*Speculum naturale*, *Speculum historiale*, *Speculum morale*, *Speculum doctrinale*) of Vincent de Beauvais went through two editions at Strassburg and found publishers and translators elsewhere, although it must have represented an outlay from which many modern firms would shrink. It would almost seem, indeed, as if some publishers specially affected very bulky works which, while they remained famous, had grown scarce because the scribes were afraid to attempt them. Hence, more especially in Germany, it was not merely the output of a single generation which came to the press before 1500, but the whole of the medieval literature which remained alive, i.e. retained a reputation sufficient to attract buyers. A study of lists of incunabula enables a student to see just what works this included, and the degree of their popularity. On the other hand in Italy the influence of the classical renaissance is reflected in the enormous output of Latin classics, and the progress of Greek studies can be traced in the displacement of Latin translations by editions of the originals. The part which each country and city played in the struggle between the old ideals and the new can be determined in extraordinary detail by a study of the output of its presses, although some allowance must be made for the extent to which books were transported along the great trade routes. Thus the fact that the Venetian output nearly equalled that of the whole of the rest of Italy was no doubt mainly due to its export trade. Venetian books penetrated everywhere, and the skill of Venetian printers in liturgical books procured them commissions to print whole editions for the English market. From the almost complete absence of scholarly books in the lists of English incunabula it would be too much to conclude that there was no demand for such books in England. The demand existed and was met by importation, which a statute of Richard III.'s expressly facilitated. But that it was not commercially possible for a scholarly press to be worked in England, and that no man of means was ready to finance one, tells its own tale. The total number of incunabula printed in England was probably upwards of four hundred, of which Caxton produced fully one-fourth. Of the ten thousand different incunabula which the British Museum and Bodleian library possess between them, about 4100 are Italian, 3400 German, 1000 French, 700 from the Netherlands, 400 from Switzerland, 150 from Spain and Portugal, 50 from other parts of the continent of Europe and 200 English, the proportion of these last being about doubled by the special zeal with which they have been collected. The celebration in 1640 of the second centenary (as it was considered) of the invention of printing may be taken as the date from which incunabula began to be collected for their own sake, apart from their literary interest, and the publication of Beughem's *Incunabula typographiae* in 1688 marks the increased attention paid to them. But up to the end of the 17th century Caxtons could still be bought for a few shillings. The third centenary of the invention of printing in 1740 again stimulated enthusiasm, and by the end of the 18th century the really early books were eagerly competed for. Interest in books of the last ten or fifteen years of the century is a much more modern development, but with the considerable literature which has grown up round the subject is not likely to be easily checked.

The chief collections of incunabula are those of the Bibliothèque Nationale at Paris, Royal library, Munich, and British Museum, London, the number of separate editions in each library exceeding nine thousand, with numerous duplicates. The number of separate editions at the Bodleian library is about five thousand. Other important collections are at the University library, Cambridge, and the John Rylands library, Manchester, the latter being based on the famous Althrop library formed by Earl Spencer (see *BOOK-COLLECTING*).

**INDABA**, a Zulu-Bantu word, formed from the inflexional prefix *in* and *daba*, business, news, for an important conference held by the "indunas" or principal men of the Kaffir (Zulu-Xosa) tribes of South Africa. Such "indabas" may include only the "indunas" of a particular tribe, or may be held with the representatives of other tribes or peoples.

**INDAZOLES** (BENZOPYRAZOLES), organic substances containing the ring system . The parent substance

*indazole*,  $C_7H_6N_2$ , was obtained by E. Fischer (*Ann.* 1883, 221, p. 280) by heating ortho-hydroxy cinnamic acid,

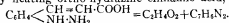

It has also been obtained by heating ortho-diazoaminotoluene with acetic acid and benzene (F. Heuser, *Ber.*, 1891, 24, p. 4161).

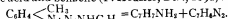

It crystallizes in needles (from hot water), which melt at  $146.5^\circ\text{C}$ . and boil at  $269.270^\circ\text{C}$ . It is readily soluble in hot water, alcohol and dilute hydrochloric acid. Nitrous acid converts it into nitrosoindazole; whilst on heating with the alkyl iodides it is converted into alkyl indazoles.

A series of compounds isomeric with these alkyl derivatives is known, and can be considered as derived from the ring system

. These isomers are called *isindazoles*, and may be prepared by the reduction of the nitroso-ortho-alkylaminoacetophenones with zinc dust and water or acetic acid. The indazoles are weak bases, which crystallize readily. Phenyl indazole, on reduction with sodium and absolute alcohol, gives a dihydro derivative (K. L. Paal, *Ber.*, 1891, 24, p. 963).

For other derivatives, see E. Fischer and J. Tafel, *Ann.* 1885, 227, p. 314.

**INDEMNITY** (through Fr. *indemnité*, Lat. *indemnis*, free from damage or loss; *in-*, negative, and *damnum*, loss), in law, an undertaking, either express or implied, to compensate another for loss or damage, or for trouble or expense incurred; also the sum so paid (see CONTRACT; and INSURANCE: *Marine*). An act of indemnity is a statute passed for the purpose either of relieving persons from disabilities and penalties to which they have rendered themselves liable or to make legal transactions which, when they took place, were illegal. An act or bill of indemnity used to be passed every session by the English parliament for the relief of those who had unwittingly neglected to qualify themselves in certain respects for the holding of offices, &c., as, for example, justices, without taking the necessary oaths. The Promissory Oaths Act 1868 rendered this unnecessary.

**INDENE**,  $C_9H_8$ , a hydrocarbon found in the fraction of the coal tar distillate boiling between  $176^\circ$  and  $182^\circ\text{C}$ ., and from which it may be extracted by means of its picrate (G. Kramer, *A. Spilker*, *Ber.*, 1890, 23, p. 3276). It may also be obtained by distilling the calcium salt of hydrindene carboxylic acid,  $C_9H_7(\text{CH}_2)_2\text{CH}\cdot\text{COOH}$ . It is an oil which boils at  $179.5^\circ$ – $180.5^\circ$ , and has a specific gravity 1.04 ( $15^\circ\text{C}$ .). Dilute nitric acid oxidizes it to phthalic acid, and sodium reduces it in alcoholic solution to *hydrindene*,  $C_9H_{10}$ . A. v. Baeyer and W. H. Perkin (*Ber.*, 1884, 17, p. 125) by the action of sodiamalonic ester on orthoxylylene bromide obtained a hydrindene dicarboxylic ester,  $C_6H_4(\text{CH}_2\text{Br})_2 + 2\text{CH}_2\text{Na}(\text{CO}_2\text{C}_2\text{H}_5) = 2\text{NaBr} + \text{CH}_2(\text{CO}_2\text{C}_2\text{H}_5)_2 + \text{C}_6\text{H}_4[\text{CH}_2]_2\text{C}(\text{CO}_2\text{C}_2\text{H}_5)_2$ ;

this ester on hydrolysis yields the corresponding acid, which on heating loses carbon dioxide and gives the monocarboxylic acid of hydrindene. The barium salt of this acid, when heated, yields indene and not hydrindene, hydrogen being liberated (W. H. Perkin, *Jour. Chem. Soc.*, 1894, 65, p. 228). Indene vapour when passed through a red hot tube yields chrysene. It combines with nitrosyl chloride to form indene nitrosate (M. Dennstedt and C. Ahrens, *Ber.*, 1895, 28, p. 1331) and it reacts with benzaldehyde, oxalic ester and formic ester (J. Thiele, *Ber.*, 1900, 33, p. 3395).

On the derivatives of indene see W. v. Miller, *Ber.*, 1890, 23, p. 1883; Th. Zincke, *Ber.*, 1887, 20, p. 2394, 1886, 19, p. 2493; and W. Roser and E. Haselhoff, *Ann.*, 1888, 247, p. 140.

**INDENTURE** (through O. Fr. *indenture* from a legal Latin term *indentura*, *indentare*, to cut into teeth, to give a jagged edge, *in modum dentium*, like teeth), a law term for a special form of deed executed between two or more parties, and having counterparts or copies equal to the number of parties. These copies were all drawn on one piece of vellum or paper divided by a toothed or "indented" line. The copies when separated along this waved line could then be identified as "tallies" when brought together. Deeds executed by one party only had a smooth or "polled" edge, whence the name "deed poll." By the Real Property Act 1845, § 5, all deeds purporting to be "indentures" have the effect of an "indenture," even though the indented line be absent. The name "chirograph" (Gr. *χρῆμα*, hand, γράφειν, to write) was also early applied to such a form of deed, and the word itself was often written along the indented line (see further DEED and DIPLOMATIC). The term "indenture" is now used generally of any sealed agreement between two or more parties, and specifically of a contract of apprenticeship, whence the phrase "to take up one's indentures," on completion of the term, and also of a contract by labourers to serve in a foreign country or colony (see COOLIE).

**INDEPENDENCE**, a city and the county-seat of Jackson county, Missouri, U.S.A., 3 m. S. of the Missouri river and 10 m. E. of Kansas City. Pop. (1890) 6380, (1900) 6974 (937 negroes); (1910) 9859. The city is served by the Missouri Pacific, the Chicago & Alton, and the Kansas City Southern railways, and by an electric line and fine boulevard to Kansas City. It is situated about 1000 ft. above the sea, and is surrounded by a fertile agricultural district. The city has a small public square (surrounding the court-house) and a public library, and is the seat of St Mary's Academy, under the control of the Sisters of Mercy. Among its manufactures are farming implements, flour and lumber. The municipality owns its electric lighting plant. Independence was laid out as a town and chosen as the county-seat in 1827, first chartered as a city in 1849 and made a city of the third-class in 1880. About 1500 Mormons, attracted by the "revelation" that this was to be a Zion, settled in and about Independence in 1831 and 1832. They contemplated building their chief temple about  $\frac{1}{2}$  m. W. of the site of the present court house, but in 1833 (partly because they invited free negroes to join them) were expelled by the "gentile" inhabitants of Independence. In 1867 a settlement of about 150 Hedrickites, or members of the "Church of Jesus Christ" (organized in Illinois in 1835), came here and secretly bought up parts of the "Temple Lot." The heirs of the settlers of 1831–1832 conveyed the lot by deed to the Reorganized Church of Jesus Christ of Latter Day Saints (with headquarters at Lamoni, Iowa), which brought suit against the Hedrickites, but in 1894 the U.S. Circuit Court of Appeals decided the case on the ground of laches in favour of the Hedrickites, who fifteen years afterwards had nearly died out. In 1867–1869 a few families belonging to the Reorganized Church of Jesus Christ of Latter Day Saints (monogamists) settled in Independence, and in 1908 their church here had about 2000 members. Besides a large church building, they have there a printing establishment, from which is issued the weekly *Zion's Ensign* (founded in 1891), and the "Independence Sanitarium" (completed in 1908). The faithful Mormons still look to Independence as the Zion of the church. In 1907 a number of Mormons from Utah settled here, moving the headquarters of the "Central States' Mission" from Kansas City to Independence, and founded a periodical called *Liahona*, the *Elder's Journal*. From about 1831 to 1844, when its river landing was destroyed by flood, Independence was the headquarters and outfitting point of the extensive caravan trains for the Santa Fe, Oregon and Old Salt Lake trails. During the Civil War about 300 Federals under Lieut.-Colonel D.H. Buel, occupying the town, were captured on the 16th of August 1862 by Colonel Hughes in command of 1500 Confederates, and on the 22nd of October 1864 a part of General Sterling Price's

Confederate army was defeated a few miles E. of Independence by General Alfred Pleasonton.

**INDEPENDENCE, DECLARATION OF**, in United States history, the act (or document) by which the thirteen original states of the Union broke their colonial allegiance to Great Britain in 1776. The controversy preceding the war (see AMERICAN INDEPENDENCE, WAR OF) gradually shifted from one primarily upon economic policy to one upon issues of pure politics and sovereignty, and the acts of Congress, as viewed to-day, seem to have been carrying it, from the beginning, inevitably into revolution; but there was apparently no general and conscious drift toward independence until near the close of 1775. The first notice to give official countenance to separation as a solution of colonial grievances was North Carolina, which, on the 12th of April 1776, authorized its delegates in Congress to join with others in a declaration to that end. The first colony to instruct its delegates to take the actual initiative was Virginia, in accordance with whose instructions—voted on the 15th of May—Richard Henry Lee, on the 7th of June, moved a resolution "that these United Colonies are, and of right ought to be, free and independent States." John Adams of Massachusetts seconded the motion. The conservatives could only plead the unpreparedness of public opinion, and the radicals conceded delay on condition that a committee be meanwhile at work on a declaration "to the effect of the said . . . resolution," to serve as a preamble thereto when adopted. This committee consisted of Thomas Jefferson, John Adams, Benjamin Franklin, Roger Sherman and Robert R. Livingston. To Jefferson the committee entrusted the actual preparation of the paper. On the 2nd of July, by a vote of 12 states—10 voting unanimously, New York not voting, and Pennsylvania and Delaware casting divided ballots (3 votes in the negative)—Congress adopted the resolution of independence; and on the 4th, Jefferson's "Declaration." The 4th has always been the day celebrated;<sup>1</sup> the decisive act of the 2nd being quite forgotten in the memory of the day on which that act was published to the world. It should also be noted that as Congress had already, on the 6th of December 1775, formally disavowed allegiance to parliament, the Declaration recites its array of grievances against the crown, and breaks allegiance to the crown. Moreover, on the 10th of May 1776, Congress had recommended to the people of the colonies that they form such new governments as their representatives should deem desirable; and in the accompanying statement of causes, formulated on the 15th of May, had declared it to be "absolutely irreconcilable to reason and good conscience for the people of these colonies now to take the oaths and affirmations necessary for the support of any government under the crown of Great Britain," whose authority ought to be "totally suppressed" and taken over by the people—a determination which, as John Adams said, inevitably involved a struggle for absolute independence, involving as it did the extinguishment of all authority, whether of crown, parliament or nation.

Though the Declaration reads as "In Congress, July 4, 1776. The unanimous Declaration of the thirteen united States of America," New York's adhesion was in fact not voted until the 9th, nor announced to Congress until the 15th—the Declaration being unanimous, however, when it was ordered, on the 19th, to be engrossed and signed under the above title.<sup>2</sup> Contrary to the inference naturally to be drawn from the form of the document, no signatures were attached on the 4th. As adopted by Congress, the Declaration differs only in details from the draft prepared by Jefferson; censures of the British *people* and a noble denunciation of slavery were omitted, appeals to Providence were inserted, and verbal improvements made in the interest of terseness and measured statement. The document is full of Jefferson's fervent spirit and personality, and its ideals were those to which his life was consecrated. It is the best known and the noblest of American state papers. Though open to

<sup>1</sup> Independence Day "is a holiday in all the states and territories of the United States.

<sup>2</sup> As read before the army meanwhile, it was headed "In Congress, July 4, 1776. A Declaration by the representatives of the United States of America in General Congress assembled."

controversy on some issues of historical fact, not flawless in logic, necessarily partisan in tone and purpose, it is a justificatory preamble, a party manifesto and appeal, reasoned enough to carry conviction, fervent enough to inspire enthusiasm. It mingles—as in all the controversy of the time, but with a literary skill and political address elsewhere unrivalled—stale disputation with philosophy. The rights of man lend dignity to the rights of Englishmen, and the broad outlook of a world-wide appeal, and the elevation of noble principles, relieve minute criticisms of an administrative system.

Jefferson's political theory was that of Locke, whose words the Declaration echoes. Uncritical critics have repeated John Adams's assertion that its arguments were hackneyed; so they undoubtedly were—in Congress, and probably little less so without,—but that is certainly pre-eminent among its great merits. As Madison said, "The object was to assert, not to discover truths." Others have echoed Rufus Choate's phrase, that the Declaration is made up of "glittering and sounding generalities of natural right." In truth, its long array of "facts . . . submitted to a candid world" had its basis in the whole development of the relations between England and the colonies; every charge had point in a definite reference to historical events, and appealed primarily to men's reason; but the history is to-day forgotten, while the fanciful basis of the "compact" theory does not appeal to a later age. It should be judged, however, by its purpose and success in its own time. The "compact" theory was always primarily a theory of political ethics, a revolutionary theory, and from the early middle ages to the French Revolution it worked with revolutionary power. It held up an ideal. Its ideal of "equality" was not realized in America in 1776—nor in England in 1688—but no man knew this better than Jefferson. Locke disclaimed for him in 1690<sup>3</sup> the shallower misunderstandings still daily put upon his words. Both Locke and Jefferson wrote simply of political equality, political freedom. Even within this limitation, the idealistic formulas of both were at variance with the actual conditions of their time. The variance would have been greater had their phrases been applied as humanitarian formulas to industrial and social conditions. The Lockian theory fitted beautifully the question of colonial dependence, and was applied to that by America with inexorable logic; it fitted the question of individual political rights, and was applied to them in 1776, but not in 1690; it did not apply to non-political conditions of individual liberty, a fact realized by many at the time—and it is true that such an application would have been more inconsistent in America in 1776 as regards the negroes than in England in 1690 as regarded freemen. Beyond this, there is no pertinence in the stricture that the Declaration is made up of glittering generalities of natural right. Its influence upon American legal and constitutional development has been profound. Locke, says Leslie Stephen, popularized "a convenient formula for enforcing the responsibility of governors"—but his theories were those of an individual philosopher—while by the Declaration a state, for the first time in history, founded its life on democratic idealism, pronouncing governments to exist for securing the happiness of the people, and to derive their just powers from the consent of the governed. It was a democratic instrument, and the revolution a democratic movement; in South Carolina and the Middle Colonies particularly, the cause of independence was bound up with popular movements against aristocratic elements. Congress was fond of appealing to "the purest maxims of representation"; it sedulously measured public opinion; took no great step without an explanatory address to the country; cast its influence with the people in local struggles as far as it could; appealed to them directly over the heads of conservative assemblies; and in general stirred up democracy. The Declaration gave the people recognition equivalent to promises, which, as fast as new governments were instituted, were converted by written constitutions into rights, which have since then steadily extended.

<sup>3</sup> *Two Treatises of Government*, No. ii. § 54, as to age, abilities, virtue, &c.



The original parchment of the Declaration, preserved in the Department of State (from 1841 to 1877 in the Patent Office, once a part of the Department of State), was injured—the injury was almost wholly to the signatures—in 1823 by the preparation of a facsimile copper-plate, and since 1894, when it was already partly illegible, it has been jealously guarded from light and air. The signers were as follows: John Hancock (1737-1792), of Massachusetts, president; Button Gwinnett (c. 1732-1777), Lyman Hall (1725-1790), George Walton (1740-1804), of Georgia; William Hooper (1742-1790), Joseph Hewes (1730-1779), John Penn (1741-1788), of North Carolina; Edward Rutledge (1749-1800), Thomas Heyward, Jr. (1746-1807), Thomas Lynch, Jr. (1749-1779), Arthur Middleton (1746-1787), of South Carolina; Samuel Chase (1747-1811), William Paca (1740-1799), Thomas Stone (1743-1781), Charles Carroll (1737-1832) of Carrollton, of Maryland; George Wythe (1726-1806), Richard Henry Lee (1732-1794), Thomas Jefferson (1743-1826), Benjamin Harrison (1740-1791), Thomas Nelson, Jr. (1738-1789), Francis Lightfoot Lee (1734-1797), Carter Braxton (1736-1797), of Virginia; Robert Morris (1734-1806), Benjamin Rush (1745-1813), Benjamin Franklin (1706-1790), John Morton (1724-1777), George Clymer (1730-1813), James Smith (c. 1710-1806), George Taylor (1716-1781), James Wilson (1742-1798), George Ross (1730-1779), of Pennsylvania; Caesar Rodney (1728-1784), of Delaware; William Floyd (1734-1821), Philip Livingston (1716-1778), Francis Lewis (1713-1803), Lewis Morris (1726-1798), of New York; Richard Stockton (1730-1781), John Witherspoon (1722-1794), Francis Hopkinson (1737-1791), John Hart (1708-1780), Abraham Clark (1726-1794), of New Jersey; Josiah Bartlett (1729-1795), William Whipple (1730-1785), Matthew Thornton (1714-1803), of New Hampshire; Samuel Adams (1722-1803), John Adams (1735-1826), Robert Treat Paine (1731-1814), Elbridge Gerry (1744-1814), of Massachusetts; Stephen Hopkins (1707-1785), William Ellery (1727-1820), of Rhode Island; Roger Sherman (1721-1793), Samuel Huntington (1732-1796), William Williams (1731-1811), Oliver Wolcott (1726-1797), of Connecticut. Not all the men who rendered the greatest services to independence were in Congress in July 1776; not all who voted for the Declaration ever signed it; not all who signed it were members when it was adopted. The greater part of the signatures were certainly attached on the 2nd of August; but at least six were attached later. With one exception—that of Thomas McKean, present on the 4th of July but not on the 2nd of August, and permitted to sign in 1781—all were added before printed copies with names attached were first authorized by Congress for public circulation in January 1777.

See H. Friedenwald, *The Declaration of Independence, An Interpretation and an Analysis* (New York, 1904); J. H. Hazleton, *The Declaration of Independence: its History* (New York, 1906); M. Chamberlain, *John Adams . . . with other Essays and Addresses* (Boston, 1898), containing, "The Authentication of the Declaration of Independence" (same in Massachusetts Historical Society, *Proceedings*, Nov. 1884); M. C. Tyler, *Literary History of the American Revolution*, vol. i. (New York, 1897), or same material in *North American Review*, vol. 163, 1896, p. 1; W. F. Dana in *Harvard Law Review*, vol. 13, 1900, p. 319; G. E. Ellis in J. Winsor, *Narrative and Critical History of America*, vol. vi. (Boston, 1888); K. Frothingham, *Rise of the Republic*, ch. ii. (Boston, 1872). There are various collected editions of biographies of the signers; probably the best are John Sanderson's *Biography of the Signers of the Declaration of Independence* (7 vols., Philadelphia, 1823-1827), and William Brodhead's *Book of the Signers* (Philadelphia, 1860, new ed., 1875). The Declaration itself is available in places. A facsimile of the original parchment in uninjured condition is inserted in P. Force's *American Archives*, 5th series, vol. i. at p. 1595 (Washington, 1848). The reader will find it interesting to compare a study of the French Declaration: G. Jellinek, *The Declaration of the Rights of Man and of Citizens* (New York, 1901; German edition, Leipzig, 1895; French translation preferable because of preface of Professor Lande).

(F. S. P.)

**INDEPENDENTS**, in religion, a name used in the 17th century for those holding to the autonomy of each several church or congregation, hence otherwise known as Congregationalists.

Down to the end of the 18th century the former title prevailed in England, though not in America; while since then "Congregationalist" has obtained generally in both. (See CONGREGATIONALISM.)

**INDEX**, a word that may be understood either specially as a table of references to a book or, more generally, as an indicator of the position of required information on any given subject. According to classical usage, the Latin word *index* denoted a discoverer, discloser or informer; a catalogue or list; an inscription; the title of a book; and the fore or index-finger. Cicero also used the word to express the table of contents to a book, and explained his meaning by the Greek form *syllabus*. Shakespeare used the word with the general meaning of a table of contents or preface—thus Nestor says (*Troilus and Cressida*, i. 3):—

"And in such indexes, although small prices  
To their subsequent volumes, there is seen  
The baby figure of the giant mass."

Table was the usual English word, and index was not thoroughly naturalized until the beginning of the 17th century, and even then it was usual to explain it as "index or table." By the present English usage, according to which the word "table" is reserved for the summary of the contents as they occur in a book, and the word "index" for the arranged analysis of the contents for the purpose of detailed reference, we obtain an advantage not enjoyed in other languages; for the French *table* is used for both kinds, as is *indice* in Italian and Spanish. There is a group of words each of which has its distinct meaning but finds its respective place under the general heading of index work; these are calendar, catalogue, digest, inventory, register, summary, syllabus and table.<sup>1</sup> The value of indexes was recognized in the earliest times, and many old books have full and admirably constructed ones. A good index has sometimes kept a dull book alive by reason of the value or amusing character of its contents. Carlyle referred to Prynne's *Histrio-Mastix* as "a book still extant, but never more to be read by mortal"; but the index must have given amusement to many from the curious character of its entries, and Attorney-General Noy particularly alluded to it in his speech at Prynne's trial. Indexes have sometimes been used as vehicles of satire, and the witty Dr William King was the first to use them as a weapon of attack. His earliest essay in this field was the index added to the second edition of the Hon. Charles Boyle's attack upon Bentley's *Dissertation on the Epistles of Phalaris* (1698).

To serve its purpose well, an index to a book must be compiled with care, the references being placed under the heading that the reader is most likely to seek. An index should be one and indivisible, and not broken up into several alphabets; thus every work, whether in one or more volumes, ought to have its complete index. The mode of arrangement calls for special attention; this may be either chronological, alphabetical or according to classes, but great confusion will be caused by uniting the three systems. The alphabetical arrangement is so simple, convenient and easily understood that it has naturally superseded the other forms, save in some exceptional cases. Much of the value of an index depends upon the mode in which it is printed, and every endeavour should be made to set it out with clearness. In old indexes the indexed word was not brought to the front, but was left in its place in the sentence, so that the alphabetical order was not made perceptible to the eye. There are few points in which the printer is more likely to go wrong than in the use of marks of repetition, and many otherwise good indexes are full of the most perplexing cases of misappreciation in this respect. The oft-quoted instance,

Mill on Liberty  
—on the Floss

actually occurred in a catalogue. But in modern times there

<sup>1</sup> Another old word occasionally used in the sense of an index is "pye." Sir T. Duffus Hardy, in some observations on the derivation of the word "Pye-Book" (which most probably comes from the Latin *pica*), remarks that the earliest use he had noted of pye in this sense is dated 1547—"A pye of all the names of such Balives as been to accompte pro anno regni regis Edwardi Sexti primo."

has been a great advance in the art of indexing, especially since the foundation in 1877 in England of the Index Society; and the growth of great libraries has given a stimulus to this method of making it easy for readers and researchers to find a ready reference to the facts or discussions they require. Not only has it become almost a *sine qua non* that any good book must have its own index, but the art of indexing has been applied to those books which are really collections of books (such as the *Encyclopaedia Britannica*), to a great newspaper like the *London Times*, and to the cataloguing of great libraries themselves. The work in these more elaborate cases has been enormously facilitated by the modern devices by means of which separate cards are used, arranged in drawers and cases, American enterprise in this direction having led the way. And the value of the work done in this respect by the Congressional Library at Washington, the British Museum and the London Library (notably by its Subject Index published in 1909) cannot well be exaggerated. (See also BIBLIOGRAPHY).

There are numerous books on Indexing, but the best for any one who wants to get a general idea is H. B. Wheatley's *How to make an Index* (1902).

**INDEX LIBRORUM PROHIBITORUM**, the title of the official list of those books which on doctrinal or moral grounds the Roman Catholic Church authoritatively forbids the members of her communion to read or to possess, irrespective of works forbidden by the general rules on the subject. Most governments, whether civil or ecclesiastical, have at all times in one way or another acted on the general principle that some control may and ought to be exercised over the literature circulated among those under their jurisdiction. If we set aside the heretical books condemned by the early councils, the earliest known instance of a list of proscribed books being issued with the authority of a bishop of Rome is the *Notitia librorum apocryphorum qui non recipiuntur*, the first redaction of which, by Pope Gelasius (404), was subsequently amplified on several occasions. The document is for the most part an enumeration of such apocryphal works as by their titles might be supposed to be part of Holy Scripture (the "Acts" of Philip, Thomas and Peter, and the Gospels of Thaddaeus, Matthias, Peter, James the Less and others).<sup>1</sup> Subsequent pontiffs continued to exhort the episcopate and the whole body of the faithful to be on their guard against heretical writings, whether old or new; and one of the functions of the Inquisition when it was established was to exercise a rigid censorship over books put in circulation. The majority of the condemnations were at that time of a specially theological character. With the discovery of the art of printing, and the wide and cheap diffusion of all sorts of books which ensued, the need for new precautions against heresy and immorality in literature made itself felt, and more than one pope (Sixtus IV. in 1479 and Alexander VI. in 1501) gave special directions to the archbishops of Cologne, Mainz, Trier and Magdeburg regarding the growing abuses of the printing press; in 1515 the Lateran council formulated the decree *De Impressione Librorum*, which required that no work should be printed without previous examination by the proper ecclesiastical authority, the penalty of unlicensed printing being excommunication of the culprit, and confiscation and destruction of the books. The council of Trent in its fourth session, 8th April 1546, forbade the sale or possession of any anonymous religious book which had not previously been seen and approved by the ordinary; in the same year the university of Louvain, at the command of Charles V., prepared an "Index" of pernicious and forbidden books, a second edition of which appeared in 1550. In 1557, and again in 1559, Pope Paul IV., through the Inquisition at Rome, published what may be regarded as the first Roman Index in the modern ecclesiastical use of that term (*Index auctoritatis et librorum qui tanquam haereticis aut suspecti aut perversi ab Officio S. R. Inquisitionis reprobantur et in universa Christiana republica interdicuntur*). In this we find the three

classes which were to be maintained in the Trent Index: authors condemned with all their writings; prohibited books, the authors of which are known; pernicious books by anonymous authors. An excessively severe general condemnation was applied to all anonymous books published since 1519; and a list of sixty-two printers of heretical books was appended. This excessive rigour was mitigated in 1561. At the 18th session of the council of Trent (26th February 1562), in consideration of the great increase in the number of suspect and pernicious books, and also of the inefficacy of the many previous "censures" which had proceeded from the provinces and from Rome itself, eighteen fathers with a certain number of theologians were appointed to inquire into these "censures," and to consider what ought to be done in the circumstances. At the 25th session (4th December 1563) this committee of the council was reported to have completed its work, but as the subject did not seem (on account of the great number and variety of the books) to admit of being properly discussed by the council, the result of its labours was handed over to the pope (Pius IV.) to deal with as he should think proper. In the following March accordingly were published, with papal approval, the *Index librorum prohibitorum*, which continued to be reprinted and brought down to date, and the "Ten Rules" which, supplemented and explained by Clement VIII., Sixtus V., Alexander VII., and finally by Benedict XIV. (10th July 1753), regulated the matter until the pontificate of Leo XIII. The business of condemning pernicious books and of correcting the Index to date has been since the time of Pope Sixtus V. in the hands of the "Congregation of the Index," which consists of several cardinals, one of whom is the prefect, and more or less numerous "consultors" and "examiners of books." An attempt has been made to publish separately the *Index Librorum Expurgandorum* or *Expurgatorius*, a catalogue of the works which may be read after the deletion or amending of specified passages; but this was soon abandoned.

With the alteration of social conditions, however, the Rules of Trent ceased to be entirely applicable. Their application to publications which had no concern with morals or religion was no longer conceivable; and, finally, the penalties called for modification. Already, at the Vatican Council, several bishops had submitted requests for a reform of the Index, but the Council was net able to deal with the question. The reform was accomplished by Leo XIII., who, on the 25th of January 1897, published the constitution *Officiorum*, in 49 articles. In this constitution, although the writings of heretics in support of heresy are condemned as before (No. 1), those of their books which contain nothing against Catholic doctrine or which treat other subjects are permitted (Nos. 2-3). Editions of the text of the Scriptures are permitted for purposes of study; translations of the Bible into the vulgar tongue have to be approved, while those published by non-Catholics are permitted for the use of scholars (Nos. 5-8). Obscene books are forbidden; the classics, however, are authorized for educational purposes (Nos. 9-10). Articles 11-14 forbid books which outrage God and sacred things, books which propagate magic and superstition, and books which are pernicious to industry. The ecclesiastical laws relating to sacred images, to indulgences, and to liturgical books and books of devotion are maintained (Nos. 15-20). Articles 21-22 condemn immoral and irreligious newspapers, and forbid writers to contribute to them. Articles 23-26 deal with permissions to read prohibited books; these are given by the bishop in particular cases, and in the ordinary course by the Congregation of the Index. In the second part of the constitution the pope deals with the censorship of books. After indicating the official publications for which the authorization of the divers Roman congregations is required, he goes on to say that the others are amenable to the ordinary of the editor and, in the case of regulars, to their superior (Nos. 30-37). The examination of the books is entrusted to censors, who have to study them without prejudice; if their report is favourable, the bishop gives the *imprimatur* (Nos. 38-40). All books concerned with the religious sciences and with ethics are submitted to preliminary censorship, and in

<sup>1</sup> Hardouin, *Conc.* ii. 940; Labbé, *Conc.* ii. 938-941. The whole document has also been reprinted in Smith's *Dict. of Chr. Antiq.*, art. "Prohibited Books."

addition to this ecclesiastics have to obtain a personal authorization for all their books and for the acceptance of the editorship of a periodical (Nos. 41-42). The penalty of excommunication *ipso facto* is only maintained for reading books written by heretics or apostates in defence of heresy, or books condemned by name under pain of excommunication by pontifical letters (not by decrees of the Index). By the same constitution Leo XIII. ordered the revision of the catalogue of the Index. The new Index, which omits works anterior to 1600 as well as a great number of others included in the old catalogue, appeared in 1900. The encyclical *Pascendi* of Pius X. (8th September 1907) made it obligatory for periodicals amenable to the ecclesiastical authority to be submitted to a censor, who subsequently makes useful observations. The legislation of Leo XIII. resulted in the better observance of the rules for the publication of books, but apparently did not modify the practice as regards the reading of prohibited books. It is to be regretted that the catalogue does not discriminate among the prohibited works according to the motive of their condemnation and the danger ascribed to reading them. The tendency of the practice among Catholics at large is to reduce these condemnations to the proportions of the moral law.

See H. Reusch, *Der Index der verbotenen Bücher* (Bonn, 1883); A. Arndt, *De Libris prohibitis commentarii* (Ratisbon, 1895); A. Boudinhon, *La Nouvelle Législation de l'Index* (Paris, 1899); J. Higers, *Der Index der verbotenen Bücher* (Freiburg in B., 1904); W. A. Vermaersch, *De prohibitione et censura librorum* (Louvain, 1907); T. Hurley, *Commentary on the Present Index Legislation* (Dublin, 1908). (A. Bo.\*)

**INDIA,** a great country and empire of Asia under British rule, inhabited by a congeries of different races, speaking upwards of fifty different languages. The whole Indian empire, including Burma, has an area of 1,766,000 sq. m., and a population of 294 million inhabitants, being about equal to the area and population of the whole of Europe without Russia. The population more than doubles Gibbon's estimate of 120 millions for all the races and nations which obeyed imperial Rome.

The natives of India can scarcely be said to have a word of their own by which to express their common country. In Sanskrit, it would be called "Bharata-varsha," from Bharata, a legendary monarch of the Lunar line; but Sanskrit is no more the vernacular of India than Latin is of Europe. The name "Hindustan," which was at one time adopted by European geographers, is of Persian origin, meaning "the land of the Hindus," as Afghanistan means "the land of the Afghans." According to native usage, however, "Hindustan" is limited either to that portion of the peninsula lying north of the Vindhya mountains, or yet more strictly to the upper basin of the Ganges where Hindi is the spoken language. The "East Indies," as opposed to the "West Indies," is an old-fashioned and inaccurate phrase, dating from the dawn of maritime discovery, and still lingering in certain parliamentary papers. "India," the abstract form of a word derived through the Greeks from the Persicized form of the Sanskrit *sindhu*, a "river," prominently the Indus, has become familiar since the British acquired the country, and is now officially recognized in the imperial title of the sovereign.

#### THE COUNTRY

India, as thus defined, is the middle of three irregularly shaped peninsulas which jut out southwards from the mainland of Asia, thus corresponding roughly to the peninsula of Italy in the map of Europe. Its form is that of a great triangle, with its base resting upon the Himalayan range and its apex running far into the ocean. The chief part of its western side is washed by the Arabian Sea, and the chief part of its eastern side by the Bay of Bengal. It extends from the 8th to the 37th degree of north latitude, that is to say, from the hottest regions of the equator to far within the temperate

zone. The capital, Calcutta, lies in 88° E., so that when the sun sets at six o'clock there, it is just past mid-day in England and early morning in New York. The length of India from north to south, and its greatest breadth from east to west, are both about 1900 m.; but the triangle tapers with a pear-shaped curve to a point at Cape Comorin, its southern extremity. To this compact dominion the British have added Burma, the strip of country on the eastern shores of the Bay of Bengal. But on the other hand the adjacent island of Ceylon has been administratively severed and placed under the Colonial Office. Two groups of islands in the Bay of Bengal, the Andamans and the Nicobars; one group in the Arabian Sea, the Laccadives; and the outlying station of Aden at the mouth of the Red Sea, with Perim, and protectorates over the island of Sokotra, along the southern coast of Arabia and in the Persian Gulf, are all politically included within the Indian empire; while on the coast of the peninsula itself, Portuguese and French settlements break at intervals the continuous line of British territory.

India is shut off from the rest of Asia on the north by a vast mountainous region, known in the aggregate as the Himalayas, amid which lie the independent states of Nepal and Bhutan, and with the great table-land of Tibet behind. The native principality of Kashmir occupies the north-western angle of India. At this north-western angle (in 35° N., 74° E.) the mountains curve southwards, and India is separated by the well-marked ranges of the Safed Koh and Suliman from Afghanistan; and by the southern continuation of lower hills from Baluchistan; still farther southwards, India is bounded along the W. and S.W. by the Arabian Sea and Indian Ocean. Turning northwards from the southern extremity at Cape Comorin (8° 4' 20" N., 77° 35' 35" E.), the long sea-line of the Bay of Bengal forms the main part of its eastern boundary. But on the north-east, as on the north-west, India has again a land frontier. The Himalayan ranges at the north-eastern angle (in about 28° N., 97° E.) throw off spurs and chains to the south-east, which separate Eastern Bengal from Assam and Burma. Stretching south-eastwards from the delta of the Irrawaddy, a confused succession of little explored ranges separates the Burmese division of Tenasserim from the native kingdom of Siam. The boundary line runs down to Point Victoria at the extremity of Tenasserim (9° 59' N., 98° 32' E.), following in a somewhat rough manner the watershed between the rivers of the British territory on the west and of Siam on the east.

The empire included within these boundaries is rich in varieties of scenery and climate, from the highest mountains in the world to vast river deltas raised only a few inches above the level of the sea. It practically forms a continent rather than a country. But if we could look down on the whole from a balloon, we should find that India (apart from Burma, for which see the separate article) consists of three separate and well-defined tracts.

The first of the three regions is the Himalaya (g.v.c.) mountains and their offshoots to the southward, comprising a system of stupendous ranges, the loftiest in the world. They are the *Emodus* *Himalayas* of Ptolemy (among other names), and extend in the shape of a scimitar, with its edge facing southwards, for a distance of 1500 m. along the northern frontier of India. At the north-eastern angle of that frontier, the Dihang river, the connecting link between the Tsampo of Tibet and the Brahmaputra of Assam, bursts through the main axis of the range. At the opposite or north-western angle, the Indus in like manner pierces the Himalayas, and turns southwards on its course through the Punjab. This wild region is in many parts impenetrable to man, and nowhere yields a passage for a modern army. Ancient and well-known trade routes exist, by means of which merchandise from the Punjab finds its way over heights of 18,000 ft. into Eastern Turkestan and Tibet. The Mtuztagh (Snowy Mountain), the Karakoram (Black Mountain), and the Changchenmo are the most famous of these passes.

The Himalayas not only form a double wall along the north of India, but to both their eastern and western extremities send out ranges to the south, which protect its north-eastern and north-western frontiers. On the north-east, these offshoots, under the name of the Naga and Patkoi mountains, &c., form a barrier between the civilized districts of Assam and the wild tribes of Upper Burma. On the opposite or north-western frontier of India, the mountainous offshoots run down the entire length of the British boundaries from the Himalayas to the sea. As they proceed southwards, their best marked ranges are in turn known as the Safed Koh, the Suliman and the Hala mountains. These massive barriers have peaks of great height, culminating in the Takht-i-Suliman or Throne of Solomon, 11,317 ft. above the level of the sea. But the mountain wall is pierced at the corner where it strikes southwards from the Himalayas by an opening through which the Kabul river flows into India. An adjacent opening in the Khyber Pass, which connects the south to the Gomal Pass near Dera Ismail Khan, the Tochi Pass between the two last-named, and the famous Bolan Pass

\* The spelling throughout all the articles dealing with India is that adopted by the government of India, modified in special instances with deference to long-established usage.

still farther south, furnish the gateways between India and Afghanistan. The Hala, Brahui and Pab mountains, forming the southern hills offshoots between India and Baluchistan, have a much less elevation.

The wide plains watered by the Himalayan rivers form the second of the three regions into which we have divided India. They extend from the Bay of Bengal on the east to the Afghan frontier and the Arabian Sea on the west, and contain the richest and most densely crowded provinces of the empire. One set of invaders after another has from prehistoric times entered by the passes at their eastern and north-western frontiers. They followed the courses of the rivers, and pushed the earlier comers southwards before them towards the sea. About 167 millions of people now live on and around these river plains, in the provinces known as the lieutenant-governorship of Bengal, Eastern Bengal and Assam, the United Provinces, the Punjab, Sind, Rajputana and other native states.

The vast level tract which thus covers northern India is watered by three distinct river systems. One of these systems takes its rise in the hollow trough beyond the Himalayas, and issues through their western ranges upon the Punjab as the **River systems.** Sutlej and Indus. The second of the three river systems also takes its rise beyond the double wall of the Himalayas, not very far from the sources of the Indus and the Sutlej. It turns, however, almost due east instead of west, enters India at the eastern extremity of the Himalayas, and becomes the Brahmaputra of Eastern Bengal and Assam. These rivers collect the drainage of the northern slopes of the Himalayas, and convey it, by long and tortuous although opposite routes into India. In view of the special feature of the Himalayas is that they send down the rainfall from their northern as well as from their southern slopes to the Indian plains. The third river system of northern India receives the drainage of their southern slopes, and eventually unites into the mighty stream of the Ganges. In this way the rainfall, alike from the northern and southern slopes of the Himalayas, pours down into the river plains of Bengal.

The third division of India comprises the three-sided table-land which covers the southern half or more strictly peninsular portion of the Indian continent, known in ancient times as the **Northern table-land.** Deccan (Dakshin), literally "the right hand or south," comprises the Central Provinces and Berar, the presidencies of Madras and Bombay, and the territories of Hyderabad, Mysore and other feudatory states. It had in 1901 an aggregate population of about 100 millions.

The northern side rests on confused ranges, running with a general direction of east to west, and known in the aggregate as the Vindhya mountains. The Vindhyas, however, are made up of several distinct hill systems. Two sacred peaks guard the flanks in the extreme east and west, with a succession of ranges stretching 800 m. between. At the western extremity, Mount Abu, famous for its exquisite Jain temples, rises, as a solitary outpost of the Aravalli hills 5650 ft. above the Rajputana plain, like an island out of the sea. On the extreme east, Mount Parasnath—like Mount Abu on the extreme west, sacred to Jain rites—rises to 4400 ft. above the level of the Gangetic plains. The various ranges of the Vindhyas, from 1500 to over 4000 ft. high, form, as it were, the northern wall and buttresses which support the central table-land. Though now pierced by road and railway, they stood in former times as a barrier of mountain and jungle between northern and southern India, and formed one of the main obstructions to the working of an empire. They consist of vast masses of forests, ridges and peaks, broken by cultivated valleys and broad high-lying plains.

The other two sides of the elevated southern triangle are known as the Eastern and Western Ghats. These start southwards from the eastern and western extremities of the Vindhya system, and run along the eastern and western coasts of India. The Eastern Ghats stretch in fragmentary spurs and ranges down the Madras presidency, here and there receding inland and leaving broad level tracts between their base and the coast. The Western Ghats form the great sea-wall of the Bombay presidency with only a narrow strip between them and the shore. In many parts they rise in magnificent precipices and headlands out of the ocean, and truly look like colossal "passes or landing-stairs" (*ghāts*) from the sea. The Eastern Ghats have an average elevation of 1500 ft. The Western Ghats ascend more abruptly from the sea to an average height of about 3000 ft. with peaks up to 4700, along the Bombay coast, rising to 7000 and even 8760 in the upheaved angle which they unite to form with the Eastern Ghats, towards their southern extremity.

The inner triangular plateau thus enclosed lies from 1000 to 3000 ft. above the level of the sea. But it is dotted with peaks and seamed with ranges exceeding 4000 ft. in height. Its best known hills are the Nilgiris, with the summer capital of Madras, Ootacamund, 7000 ft. above the sea. The highest point is Dodabetta Peak (8760 ft.), at the upheaved southern angle.

On the eastern side of India, the Ghats form a series of spurs and buttresses for the elevated inner plateau, rather than a continuous mountain wall. They are traversed by a number of broad and easy passages from the Madras coast. Through these openings the rainfall of the southern half of the inner plateau reaches the sea. The drainage from the northern or Vindhyan

edge of the three-sided table-land falls into the Ganges. The Nerbudda and Tapi carry the rainfall of the southern slopes of the Vindhyas and of the Satpura hills, in almost parallel lines, into the Gulf of Cambay. But from Surat, in  $21^{\circ} 9'$ , to Cape Comorin, in  $8^{\circ} 4'$ , no large river succeeds in reaching the western coast from the interior table-land. The Western Ghats form, in fact, a lofty unbroken barrier between the waters of the central plateau and the Indian Ocean. The drainage has therefore to make its way across India to the eastwards, now turning sharply round projecting ranges, now tumbling down ravines, or rushing along the valleys, until the rain which the Bombay sea-breeze has dropped upon the Western Ghats finally falls into the Bay of Bengal. In this way the three great rivers of the Madras Presidency, viz., the Godavari, the Kistna and the Cauvery, rise in the mountains overhanging the western coast, and traverse the whole breadth of the central table-land before they reach the sea on the eastern shores of India.

Of the three regions of India thus briefly surveyed, the first, or the Himalayas, lies for the most part beyond the British frontier, but a knowledge of it supplies the key to the ethnology and history of India. The second region, or the great river plains in the north, formed the theatre of the ancient race-movements which shaped the civilization and the political destinies of the whole Indian peninsula. The third region, or the triangular table-land in the south, has a character quite distinct from either of the other two divisions, and a population which is now working out a separate development of its own. Broadly speaking, the Himalayas are peopled by Mongoloid tribes; the great river plains of Hindustan are still the home of the Aryan race; the triangular table-land has formed an arena for a long struggle between the present races from the north and what is known as the Dravidian stock in the south.

### Geology.

Geologically, as well as physically, India consists of three distinct regions, the Himalayas, the Peninsula, and—between these two—the Indo-Gangetic plain with its covering of alluvium and wind-blown sands. The contrast between the Himalayas and the Peninsula is one of fundamental importance. The former, from the Tertiary period even to the present day, has been a region of compression; the latter, since the Carboniferous period at least, has been a region of equilibrium or of tension. In the former even the Pliocene beds are crumpled and folded, overfolded and overthrust in the most violent fashion; in the latter none but the oldest beds, certainly none so late as the Permian, have been crumpled or crushed—occasionally they are bent and frequently they are faulted, but the faults, though sometimes of considerable magnitude, are simple dislocations, unaccompanied by any serious disturbance of the strata. The greater part of the Himalayan region lay beneath the sea from the Permian to the Pliocene period, and the deposits are accordingly marine; the Peninsula, on the other hand, has been land since the Permian period at least—there is, indeed, no evidence that it was ever beneath the sea—only on its margins are any marine deposits to be found. It should, however, be mentioned that in the eastern part of the Himalayas some of the beds resemble those of the Peninsula, and it appears that a part of the old Indian continent has here been involved in the folds of the mountain chain.

The geology of the Himalayas being described elsewhere (see Himalayas), the following account deals only with the Indo-Gangetic plain and the Peninsula.

The **Indo-Gangetic Plain** covers an area of about 300,000 sq. m., and varies in width from 90 to nearly 300 m. It rises very gradually from the sea at either end; the lowest point of the watershed between the Punjab rivers and the Ganges is about 924 ft. above the sea. This point, by a line measured down the valley, but not following the winding of the river, is about 1050 m. from the mouth of the Ganges and 850 m. from the mouth of the Indus, so that the average inclination of the plain, from the central watershed to the sea, is only about 1 in 12,000. It is less near the sea, and the greater distances there is no fall at all. Near the watershed it is generally more; but there is here no ridge of high ground between the Indus and the Ganges, and a very trifling change of level would often turn the upper waters of one river into the other. It is not unlikely that such changes have in past time occurred; and if so an explanation is afforded of the occurrence of allied forms of freshwater dolphins (*Platanista*) and of many other animals in the two rivers and in the Brahmaputra.

The alluvial deposits of the plain, as made known by the boring at Calcutta, prove a gradual depression of the area in recent times. The area, and the beds, which must have grown quietly at the surface, alternating with deposits of gravel, sand and clay. The thickness of the delta deposit is unknown; 481 ft. was proved at the bore hole, but probably this represents only a small part of the deposit. Outside the delta, in the Bay of Bengal, is a deep depression known as the "swath of no ground"; all around it the soundings are only of 5 to 6 fathoms, but they very rapidly deepen to over 300 fathoms. Mr J. Ferguson has shown that the sediment is carried away from this area by the set of the currents; probably then it has remained free from siltment whilst the neighbouring sea-bottom has gradually become filled. If so, the thickness of the alluvium is at least 1800 ft., and may be much more. At Lucknow



a boring was driven through the Gangetic alluvium to a depth of 1336 ft. from the surface, or nearly 1000 ft. below sea-level. Even at this depth there was no indication of an approach to the base of the alluvial deposits.

The deposits of the Indo-Gangetic plain are of modern date and the formation of the depression which they fill is almost certainly connected with the elevation of the Himalayas. Both movements are probably still going on. The alluvial deposits prove depression in quite recent geological times; and within the Himalayan region earthquakes are still common, whilst in Peninsular India they are rare.

**Peninsular India.**—The oldest rocks of this region consist of gneiss, granite and other crystalline rocks. They cover a large area in Bengal and Madras and extend into Ceylon; and they are found

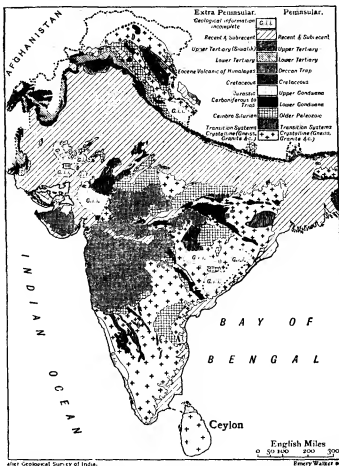

after Geological Survey of India.

also in Bundelkhand and in Gujarat. Upon them rest the unfoliated strata known to Indian geologists as the Transition and Vindhyan series. The Transition rocks are often violently folded and are frequently converted into schists. In the south, where they are known as the Dharwar series, they form long and narrow bands running from north-north-west to south-south-east across the ancient gneiss; and it is interesting to note that all the quartz-pegs which contain gold in paying quantities occur in the Dharwar series. The Transition rocks are of great but unknown age. The Vindhyan rocks which succeed them are also of ancient date. But long before the earliest Vindhyan rocks were laid down the Transition rocks had been altered and contorted. Occasionally the Vindhyan beds themselves are strongly folded, as in the east of the Cuddaph basin; but this was the last folding of any violence which has occurred in the Peninsula. In more recent times there have been local disturbances, and large faults have in places been formed; but the greater part of the Peninsular rocks are only slightly disturbed. The Vindhyan series is generally sharply marked off from older rocks; but in the Godavari valley there is no well-defined line between them and the Transition rocks. The Vindhyan beds are divided into two groups. The lower, with an estimated thickness of only 200 ft., or slightly more, cover a large area—extending, with but little change of character, from the Sone valley in one direction to Cuddaph, and in a diverging line to near Bijapur—in each case a distance of over 700 m. The upper Vindhyan cover a much smaller area, but attain a thickness of about 12,000 ft. The Vindhyan are well-stratified beds of sandstone and shale, with some limestones. As yet they have yielded no trace of fossils, and their exact age is consequently unknown. They are however certainly Pre-Permian, and it is most probable that they belong to the early

part of the Palaeozoic era. The total absence of fossils is a remarkable fact, and one for which it is difficult to account, as the beds are for the most part quite unaltered. Even if they are entirely of freshwater origin, we should expect that some traces of life from the waters or neighbouring land would be found.

The Gondwana series is in many respects the most interesting and important series of the Indian Peninsula. The beds are almost entirely of freshwater origin. Many subdivisions have been made, but here we need only note the main division into two great groups: Lower Gondwanas, 13,000 ft. thick; Upper Gondwanas, 11,000 ft. thick. The series is mainly confined to the area of country between the Nerbudda and the Sone on the north, and the Kistna on the south; but the western part of this region is in great part covered by newer beds. The lowest Gondwanas are very constant in character, wherever they are found; the upper members of the lower division show more variation, and this divergence of character in different districts becomes more marked in the Upper Gondwana series. Disturbances have occurred in the lower series before the formation of the upper.

The Gondwana beds contain fossils which are of very great interest. In large part these consist of plants which grew near the margins of the old rivers, and which were carried down by floods, and deposited in the alluvial plains, deltas and estuarine areas of the old Gondwana period. The plants of the Lower Gondwanas consist chiefly of acrogens (*Equisetaceae* and ferns) and gymnogens (cycads and conifers), the former being the more abundant. The same classes of plants occur in the Upper Gondwanas, but there the proportions are reversed, the conifers, and still more the cycads, being more numerous than the ferns, whilst the *Equisetaceae* are but sparingly found. But even within the limits of the Lower Gondwana series there are great diversities of vegetation, three distinct floras occurring in the three great divisions of that formation. In many respects the flora of the highest of these three divisions (the Panchet group) is more nearly related to that of the Upper Gondwanas than it is to the other Lower Gondwana floras. Although during the Gondwana period the flora of India differed greatly from that of Europe, it was strikingly similar to the contemporaneous floras of South America, South Africa, and Australia. It is somewhat remarkable that this characteristically southern flora, known as the Glossopteris Flora (from the name of one of the most characteristic genera), has also been found in the north of Russia.

One of the most interesting facts in the history of the Gondwana series is the occurrence near the base (in the Talchir group) of large striated boulders in a fine mud or silt, the boulders in one place resting upon rock (of Vindhyan age) which is also striated. These beds are the result of ice-action, and it is interesting to note that a similar boulder bed is associated with the Glossopteris-bearing deposits of Australia, South Africa and probably South America.

The Damuda series, the middle division of the Lower Gondwanas, is the chief source of coal in Peninsular India, yielding more of that mineral than all other formations taken together. The Karharbari group is the only other coal-bearing formation of any value. The Damudas are 8400 ft. thick in the Kanigan coal-field, and about 70,000 ft. thick in the Satpura basin. They consist of three divisions: coal occurs in the upper and lower, ironstone (without coal) in the middle division. The Raniganj coal-field is the most important in India. It covers an area of about 500 sq. m. and is traversed by the Damuda river, along which run the road from Calcutta to Benares and the East Indian railway. From its situation and importance this coal-field is better known than any other in India. The upper or Raniganj series (stated by the Geological Survey to be 5000 ft. thick) contains eleven seams, having a total thickness of 120 ft., in the eastern district, and thirteen seams, 106 ft. thick, in the western district. The eastern seam, which is the most largely worked, is from 12 to 18 ft., but occasionally a seam attains a great thickness—20 to 80 ft. The lower or Barakar series (2000 ft. thick) contains four seams, of a total thickness of 69 ft. Compared with English coals those of this coal-field are of but poor quality; they contain much ash, and are generally non-coking. The seams of the lower series are the best, and some of these at Santkoria, near the Barakar river, are fairly good for coke and gas. The best coal in India is in the small coal-field at Karharbari. The beds there are lower in the series than those of the Raniganj group; they belong to the upper part of the Talchir group, the lowest of the Gondwana series. The coal-bearing beds cover an area of only about 11 sq. m.; there are three seams, varying from 9 to 33 ft. thick. The lowest seam is the best, and this is as good as English steam coal. This coal-field, now largely worked, is the property of the East Indian railway, which is thus supplied with fuel at a cheaper rate than any other railway in the world. Indian coal usually contains phosphoric acid, which greatly lessens its value for iron-smelting.

The Damuda series, which, as we have seen, is the chief source of coal in India, is also one of the most important sources of iron. The best occurs in the middle division, coal in the highest and lowest. The ore is partly a calc ironstone, like that occurring in the Coal-measures of England, partly an oxide of iron or haematite, and it generally contains phosphorus. Excellent iron-ore occurs in the crystalline rocks south of the Damuda river as also in many other parts of India. Laterite (see below) is sometimes used as ore. It

is very earthy and of a low percentage; but it contains only a comparatively small proportion of phosphorus.

The want of limestone for flux, within easy reach, is generally a great drawback as regards iron-smelting in India. *Kankar* or *ghuñin* (concretionary carbonate of lime) is collected for this purpose from the river-beds and alluvial deposits. It sometimes contains as much as 70% of carbonate of lime; but generally the amount is much less and the fluxing value proportionally diminished. The real difficulty in India is to find the ore, the fuel, and the flux in sufficiently close proximity to yield a profit.

Contemporaneously with the formation of the upper part of the Gondwana series marine deposits of Jurassic age were laid down in Cutch. Cretaceous beds of marine origin are also found in Cutch, Kathiawar and the Nerbudda valley on the northern margin of the Peninsula, and near Pondicherry and Trichinopoly on its south-eastern margin. There is a striking difference between the Cretaceous faunas of the two areas, the north being closely allied to those of Europe, while those of the south (Pondicherry and Trichinopoly) are very different and are much more nearly related to those from the Cretaceous of Natal. It is now very generally believed that in Jurassic and Cretaceous times a great land-mass stretched from South Africa through Madagascar to India, and that the Cretaceous deposits of Cutch, &c., were laid down upon its northern shore, and those of Pondicherry and Trichinopoly upon its southern shore. The land probably extended as far as Assam, for the Cretaceous fossils of Assam are similar to those of the south. The enormous amount of basaltic lava which has been erupted. Trap is of great importance in the geological structure of the Indian Peninsula. It now covers about 200,000 sq. m., and formerly extended over a much wider area. Where thickest, the traps are at least 6000 ft. thick. They form some of the most striking physical features of the Peninsula, many of the most prominent hills ranges having been carved out of the basaltic flows. The great volcanic outbursts which produced this trap commenced in the Cretaceous period and lasted on into the Eocene period.

Laterite is a ferruginous and argillaceous rock, varying from 30 to 200 ft. thick, which often occurs under the trap area and also over the gneiss. As a rule it makes rather barren land; it is highly porous, and the rain rapidly sinks into it. Laterite may be roughly divided into two kinds, high-level and low-level laterites. It has usually been formed by the decomposition *in situ* of the rock on which it rests, but it is often broken up and re-deposited elsewhere.

#### Meteorology.

The great peninsula of India, with its lofty mountain ranges behind and its extensive seaboard exposed to the first violence of the winds of two oceans, forms an exceptionally valuable and interesting field for the study of meteorological phenomena.

From the gorge of the Indus to that of the Brahmaputra, a distance of 1400 m., the Himalayas form an unbroken watershed, the northern flank of which is drained by the upper valleys of these **Himalayas** two rivers; while the Sutlej, starting from the southern foot of the Kailas Peak, breaks through the watershed, dividing it into two very unequal portions, that to the north-west being the smaller. The average elevation of the Himalaya crest may be taken at not less than 19,000 ft., and therefore equal to the height of the lower half of the atmosphere; and indeed few of the passes are under 16,000 or 17,000 ft. Across this mountain barrier there appears to be a constant flow of air, more active in the day-time than at night, northwards to the arid plateau of Tibet. There is no reason to believe that any transfer of air takes place across the Himalayas in a southerly direction, unless indeed in those most elevated regions of the atmosphere which lie beyond the range of observation; but a nocturnal flow of cooled air, from the southern slopes, is felt as a strong wind where the rivers debouch on the plains, more especially in the early morning hours; and this probably contributes in some degree to lower the mean temperature of that belt of the plains which fringes the mountain zone.

At the foot of the great mountain barrier, and separating it from the more ancient land which now forms the highlands of the peninsula, a broad plain, for the most part alluvial, stretches from sea to sea. On the west, in the dry region, this is occupied

#### Indus plain.

partly by the alluvial deposits of the Indus and its tributaries and the saline swamps of Cutch, partly by the rolling sands and rocky surface of the desert of Jaisalmer and Bikomer, and at the more fertile tracts to the eastward watered by the Luni. Over the greater part of this region rain is of rare occurrence; and not infrequently more than a year passes without a drop falling on the parched surface. On its eastern margin, however, in the neighbourhood of the Aravalli hills, and again in the northern Punjab, rain is more frequent, occurring both in the south-west monsoon and also at the opposite season in the cold weather. As far south as Sira and Multan the average rainfall does not much exceed 7 in.

The alluvial plain of the Punjab passes into that of the Gangetic valley without visible interruption. Up to the plain, at the opposite seasons of the monsoon winds, in a direction at right angles to that of their nominal course; and thus vapour which has been brought by winds from the Bay of Bengal is discharged as snow and rain on the peaks and hillsides of the Western Himalayas. Nearly the whole surface is under cultiva-

tion, and it ranks among the most productive as well as the most densely populated regions of the world. The rainfall diminishes from 100 in. in the south-east corner of the Gangetic delta to less than 30 in. at Agra and Delhi, and there is an average difference of from 15 to 25 in. between the northern and southern borders of the plain.

Eastward from the Bengal delta, two alluvial plains stretch up between the hills which connect the Himalayan system with that of the Burmese peninsula. The first, or the valley of Assam and the Brahmaputra, is long and narrow, bordered on the north by the Himalayas, on the south by the lower plateau of the Garo, Khasi and Naga hills. The other, short and broad, and in great part occupied by swamps and *jhils*, separates the Garo, Khasi and Naga hills from those of Tippera and the Lushai country. The climate of these plains is damp and equable, and the rainfall is prolonged and generally heavy, especially on the southern slopes of the hills. A meteorological peculiarity of some interest has been noticed, more especially at the stations of Sibsagar and Silchar, viz. the great range of the diurnal variation of barometric pressure during the afternoon hours,—which is the more striking, since at Rurki, Lahore, and other stations near the foot of the Western Himalayas this range is less than in the open plains.

The highlands of the peninsula, which are cut off from the encircling ranges by the broad Indo-Gangetic plain, are divided into two unequal parts by an almost continuous chain of hills **Central table-land.** running across the country from west by south to east by north-west. The Tropic of Capricorn may be regarded as a single geographical feature, forming one of the principal watersheds of the peninsula, the waters to the north draining chiefly into the Nerbudda and the Ganges, those to the south into the Tapti, the Mahanadi, the Godavari and some smaller streams. In a meteorological point of view it is of considerable importance. Together with the two parallel valleys of the Nerbudda and Tapti, which drain the flanks of its western half, it gives, at opposite seasons of the year, a decided easterly and westerly direction to the winds of this part of India, and condenses a tolerably copious rainfall during the south-west monsoon.

Separated from this chain by the valley of the Nerbudda on the west, and that of the Sone on the east, the plateau of Malwa and Baghelkhand occupies the space intervening between these valleys and the Gangetic plain. On the western edge of the plateau are the Aravalli hills, which run from near Ahmedabad up to the neighbourhood of Delhi, and include one hill, Mount Abu, over 5000 ft. in height. This range exerts an important influence on the direction of the wind, and also on the rainfall. At Ajmer, an old meteorological station at the eastern foot of the range, the wind is predominantly south-west, and there and at Mount Abu the south-west monsoon rains are a regularly recurrent phenomenon,—which can hardly be said of the region of scanty and uncertain rainfall that extends from the western foot of the range and merges in the Bikaner desert.

The peninsula south of the Satpura range consists chiefly of the triangular plateau of the Deccan, terminating abruptly on the west in the Sahyadri range (Western Ghats), and shelving to the east (Eastern Ghats). This plateau is swept by the south-west monsoon, but not until it has surmounted the western barrier of the Ghats; and hence the rainfall is, as a rule, light at Poona and places similarly situated under the lee of the range, and but moderate over the more easterly parts of the plateau. The rains, however, are prolonged some three or four weeks later than in tracts to the north of the Satpuras, since they are also brought by the easterly winds which blow from the Bay of Bengal in October and the early part of November, when the recurved southerly wind ceases to blow up the Gangetic valley, and sets towards the south-east coast.

At the junction of the Eastern and Western Ghats rises the bold triangular plateau of the Nilgiris, and to the south of them come the Anamalais, the Palnis, and the hills of Travancore. These ranges are separated from the Nilgiris by a broad **Southera India.** depression or pass known as the Palghat Gap, some 25 m. wide, the highest point of which is only 1500 ft. above the sea. This gap affords a passage to the winds which elsewhere are barred by the hills of the Ghat chain. The country to the east of the gap receives

the rainfall of the south-west monsoon; and during the north-east monsoon ships passing Beypur meet with a stronger wind from the land than is felt elsewhere on the Malabar coast. In this strip of low country that fringes the peninsula below the Ghats the rainfall is heavy and the climate warm and damp, the vegetation being dense and characteristically tropical, and the steep slopes of the Ghats, where they have not been artificially cleared, thickly clothed with forest.

In Lower Burma the western face of the Arakan Yoma hills, like that of the Western Ghats in India, is exposed to the full force of the south-western monsoon, and receives a very heavy **Burma.** rainfall. At Sarsa this amounts to an annual mean of 212 in. It diminishes to the northwards, but even at Chittagong it is over 104 in. annually.

The country around Mandalay, as well as the hill country to the north, has suffered from severe earthquakes, one of which destroyed Awa in 1839. The general meridional direction of the ranges and

valleys determines the direction of the prevailing surface winds, this being, however, subject to many local modifications. But it would appear that throughout the year there is, with but slight interruption, a steady upper current from the south-west, such as has been already noticed over the Himalayas. The rainfall in the lower part of the Irrawaddy valley, the delta and the neighbouring part of the province of Pegu, is very heavy; and the climate is mild and equable at all seasons. But higher up the valley, and especially north of Pegu, the country is drier, and is characterized by a less luxuriant vegetation and a retarded and more scanty rainfall.

Within the boundaries of India almost any extreme of climate that is known to the tropics or the temperate zone can be found. It

**Climate.** is influenced from the sides by the Ganges and the Indus. On the north, the Himalayas, and the plateau of Afghanistan shut it off from the climate of central Asia, and give it a continental climate, the characteristics of which are the prevalence of land winds, great dryness of the air, large diurnal range of temperature, and little or no precipitation. On the south the ocean gives it an oceanic climate, the chief features of which are great uniformity of temperature, small diurnal range of temperature, great dampness of the air, and more or less frequent rain. The continental type of weather prevails over almost the whole of India from December to May, and the oceanic type from June to November, thus giving rise to the two great divisions of the year, the dry season or north-east monsoon, and the rainy season or south-west monsoon. India thus becomes the type of a tropical monsoon climate. For the origin of the monsoon currents and their distribution see MONSOON.

The two monsoon periods are divided by the change of temperature, due to solar action upon the earth's surface into two separate seasons; and thus the Indian year may be divided into four seasons: the cold season, including the months of January and February; the hot season, comprising the months of March, April and May; the south-west monsoon period, including the months of June, July, August, September and October; and the retreating monsoon period, including the months of November and December. The temperature is nearly constant in southern India the whole year round, but in northern India, at the extremes of both heat and cold are greatest, the variation is very large.

In the cold season the mean temperature averages about 30° lower in the Punjab than in southern India. In the Punjab, the United Provinces, and northern India generally the climate resembles that of the Riviera, with a brilliant cloudless sky and cool dry weather. This is the time for the tourist to visit India. In south India it is warmer on the west coast than on the east, and the greatest temperature is found in the head waters of the Krishna. Calcutta, Bombay and Madras all possess the equable climate that is induced by proximity to the sea, but Calcutta enjoys a cold season which is not to be found in the other presidency towns, while the hot season is more unendurable there.

The hot season begins officially in the Punjab on the 15th of March, and from that date there is a steady rise in the temperature, induced

**The hot weather.** by the fiery rays of the sun upon the baking earth, until the break of the rains in June. During this season the interior of the peninsula and northern India is greatly heated; and the contrast of temperature is not between northern and southern India, but between the interior of India and the coast districts and adjacent seas. The greater part of the Deccan and the Central Provinces are included within the hottest area, though in May the highest temperatures are found in Upper Sind, north-west Rajputana, and south-west Punjab. At Jacobabad the thermometer sometimes rises to 125° in the shade. In this season the south-west monsoon currents usually set in during the first fortnight of June on the Bombay and Bengal coasts, and give more or less general rain in every part of India during the next three months. But the distribution of the rainfall is very uneven. On the face of the Western Ghats, and on the Khasi hills, overlooking the Bay of Bengal, where the mountains catch the masses of vapour as it rises off the sea, the rainfall is enormous. At Cherra-punji in the Khasi hills it averages upwards of 500 inches a year. The Bombay monsoon, after surmounting the Ghats, blows across the peninsula as a west and sometimes in places a north-west wind; but it leaves with very little rain a strip 100 to 200 m. in width in the western Deccan parallel with the Ghats, and it is this part of the Deccan, together with the Mysore table-land and the Carnatic, that is most subject to drought. Similarly the Bengal monsoon passes by the Coromandel coast and the Carnatic with an occasional shower, taking a larger volume of moisture from the sea, and pours down on the Bengal, Assam and Cachar.

**The monsoon period.** The same current also supplies with rain the broad band across India, which includes the Satpura range, Chota Nagpur, the greater part of the Central Provinces and Central India, Orissa and Bengal. Rainfall rapidly diminishes to the north-west from that belt. A branch of the Bombay current blows pretty steadily through Rajputana to the Punjab, carrying some rain to the latter province. But the greater part of north-west India receives as a rule by cyclonic storms, between the months of July and September, the greater part of its monsoon begins rapidly to decline, and after about the middle of the month it ceases to carry rain to the greater part of north-western India. In its rear springs up a gentle steady north-east wind, which

gradually extends over the Bay of Bengal, and is known as the north-east monsoon. A wind similar in character, but rather more easterly in direction, simultaneously takes possession of the Arabian Sea. The months of November and December form a transition period between the monsoon and the cold season. The most unhealthful period of the year follows immediately after the rains, when malaria is prevalent, especially in northern India.

#### Flora.

Unlike many other large geographical areas, India is remarkable for having no distinctive botanical features peculiar to itself. It differs conspicuously in this respect from such countries as Australia or South Africa. Its vegetation is in point of fact of a composite character, and is constituted by the meeting and more or less blending of adjoining floras,—those of Persia, and the south-eastern Mediterranean area to the north-west, of Siberia to the north, of China to the east, and of Malaya to the south-east. Regarded broadly, four tolerably distinct types present themselves.

1. The upper levels of the Himalayas slope northwards gradually to the Tibetan uplands, over which the Siberian temperate vegetation ranges. This is part of the great temperate flora which, **Himalayas**, with locally individualized species, but often with identical genera, ranges over the whole of the temperate zone of the northern hemisphere. In the western Himalayas this upland flora is marked by a strong admixture of European species, such as the columbine (*Aquilegia*) and hawthorn (*Crataegus Oxycantha*). These disappear rapidly eastward, and are scarcely found beyond Kumaon. The base of the Himalayas is occupied by a narrow belt forming an extreme north-western extension of the Malayan type described below. Above that there is a rich temperate flora which in the eastern chain may be regarded as forming an extension of that of northern China, gradually assuming westwards more and more of a European type. *Magnolia*, *Aucuba*, *Abelia* and *Shimimia* may be mentioned as examples of Chinese genera found in the eastern Himalayas, and the tea-tree grows wild in Assam. The same coniferous trees are common to both parts of the range. *Pinus longifolia* extends to the Hindu-Kush; *P. excelsa* is found universally except in Sikkim, and has its European analogue *P. Pinus* in the mountains of Greece. *Abies smithiana* extends into Afghanistan; *Abies webbiana* forms dense forests at altitudes of 8000 to 12,000 ft., and ranges from Bhutan to Kashmir; several junipers and the common yew (*Taxus baccata*) also occur. The deodar (*Cedrus Deodara*), which is indigenous to the mountains of Afghanistan and the north-west Himalaya, is nearly allied to the Atlantic cedar and to the cedar of Lebanon, a form of which is found in Cyprus. A notable further instance of the connection of the western Himalayan flora with that of Europe is the horn oak (*Quercus Ilex*), which is characteristic of the Mediterranean region.

2. The north-western area is best marked in Sind and the Punjab, where the climate is very dry (the rainfall averaging less than 15 in.), and where the soil, though fertile, is wholly dependent on irrigation for its cultivation. The flora is a poor one in number of species, and is essentially identical with that of Persia, southern Arabia and Egypt. The low scattered jungle contains such characteristic species as *Capparis aphylla*, *Acacia arabica* (babul), *Populus euphratica* (the "willows" of Ps. cxxxvii. 2), *Salvadora persica* (erroneously identified by Royle with the mustard of Matt. xiii. 31), tamarisk, *Zizyphus*, *Lotus*, &c. The dry flora extends somewhat in a south-east direction, and then blends insensibly with that of the western peninsula; some species representing it are found in the upper Gangetic plain, and a few are widely distributed in dry parts of the country.

3. The Malaya area, which Joseph Hooker describes as forming "the bulk of the flora of the perennially humid regions of India, as of the whole Malayan peninsula, Upper Assam and Malayan peninsula." Assam and Malayan peninsula. the Himalaya from the Brahmaputra to Nepal, of the Malabar coast, and of Ceylon," see ASSAM, CEYLON and MALAY PENINSULA.

4. The western India type is difficult to characterize, and is in many respects intermediate between the two just preading. It occupies a comparatively dry area, with a rainfall under 75 in. In respect to positive affinities, Sir Joseph Hooker pointed out some relations with the flora of tropical Africa as evidenced by the prevalence of such genera as *Grewia* and *Impatiens*, and the absence, common to both countries, of oaks and pines which abound in the Malayan archipelago. The annual vegetation which springs up in the rainy season includes numerous genera, such as *Strobilanthus* and *Chromolaena*, which are rarely met with in Africa and Hindustan. Palms also in both countries are scanty, the most notable in southern India being the wild date (*Phoenix sylvestris*); *Borassus* and the coco-nut are cultivated. The forests, though occasionally very dense, as in the Western Ghats, are usually drier and more open than those of the Malayan type, and are often scrubby. The most important timber trees are the *lín* (*Cedrela Toona*), *sál* (*Shorea robusta*), the present area of which forms two belts, the western Ghats and the Eastern Ghats (*Chloroxylon*), *Santalinia*, common in the drier parts of the peninsula; sandalwood, especially characteristic of Mysore; iron-wood (*Mesua ferrea*), and teak (*Tectona grandis*).

**Western India.**



## Fauna.

**Mammals.**—First among the wild animals of India must be mentioned the lion (*Felis leo*), which is known to have been not uncommon within historical times in Hindustan proper and the Punjab. At present the lion is confined to the Gir, or rocky hills, east of Kathiawar. A peculiar variety is there found, marked by the absence of a mane; but whether this variety deserves to be classed as a distinct species, naturalists have not yet determined. These lions at one time were almost extinct, but after being preserved since about 1890 by the Nawab of Junagarh, they have once more become comparatively plentiful. A good lion measures from 9 to 9½ ft. in length.

The characteristic beast of prey in India is the tiger (*F. tigris*), which is found in every part of the country, from the slopes of the Himalayas to the Sunderbans swamps. The average length of a tiger from nose to tip of tail is 9 ft. to 10 ft. for tigers, and 8 ft. to 9 ft. for tigresses, but a tiger of 12 ft. 4 in. has been shot. The advance of cultivation, even more than the incessant attacks of sportsmen, has gradually caused the tiger to become a rare animal in large tracts of country; but it is scarcely probable that he will ever be exterminated from India. The malarius *larai* fringing the Himalayas, the uninhabitable swamps of the Gangetic delta, and the wide jungles of the central plateau are at present the chief home of the tiger. His usual prey appears to be deer, antelope and wild asses. When about to be killed he disregards domestic cattle. Indeed, the natives are disposed to consider him as in some sort their protector, as he saves their crops from destruction by the wild animals on which he feeds. But when once he develops a taste for human blood, then the slaughter he works becomes truly formidable. The confirmed man-eater, which is generally an old beast, disabled from overtaking his usual prey, seems to accumulate his tale of victims in sheer cruelty rather than for food. A single tiger is known to have killed 108 people in the course of three years. Another killed an average of about 80 persons per annum. A third caused thirteen villages to be abandoned, and 250 sq. m. of land to be thrown out of cultivation. A fourth, in 1869, killed 127 people, and stopped a public road for many weeks, until the opportune arrival of an English sportsman, who at last killed him. Such cases are, of course, exceptional, and generally refer to a period long past, but they explain and justify the superstitious awe with which the tiger is regarded by the natives. The favourite mode of shooting the tiger is from the back of elephants, or from elevated platforms (*machins*) of boughs in the jungle. In Central India they are shot on foot. In Assam they are sometimes speared from boats, and in the Himalayas they are said to be ensnared by bird-lime. Rewards are given by government to native *shikaris* for the heads of tigers, varying in time and place according to the need. In 1903 the number of persons killed by tigers in the whole of India was 866, while forty years previously 700 people were said to be killed annually in Bengal alone.

The leopard or panther (*F. pardus*) is far more common than the tiger in all parts of India, and at least equally destructive to life and property. The greatest length of the leopard is about 7 ft. 6 in. A black variety, as beautiful as it is rare, is sometimes found in the extreme south of the peninsula, and also in Java.

The cheetah or hunting leopard (*Cynaulerus jubatus*) must be carefully distinguished from the leopard proper. This animal appears to be a native only of the Deccan, where it is trained for hunting the antelope. In some respects it approaches the dog more nearly than the cat tribe. Its limbs are longer, its head is broader, its claws blunt and only partially retractile. The speed with which it bounds upon its prey, when loosed from the cart, exceeds the swiftness of any other mammal. If it misses its first attack, it scarcely ever attempts to follow, but returns to its master. Among other species of the family *Felidae* found in India may be mentioned the ounce or snow leopard (*F. uncia*), the clouded leopard (*F. nebulosa*), the marbled cat (*F. marmorata*), the jungle cat (*F. chaus*), and the viverrine cat (*F. viverrina*).

Three *Cynipidae* abound throughout the open country, but are rare in the wooded districts. Their favourite prey is sheep, but they are also said to run down antelopes and hares, or rather catch them by lying in ambush. Instances of their attacking man are not uncommon, and the story of Komulus and Remus has had its counterpart in India within comparatively recent times. The Indian wolf has a dingy reddish-white fur, some of the hairs being tipped with black. By some naturalists it is regarded as a distinct species, under the name of *Canis pallipes*. Three distinct varieties, the red, the black and the blue wolf, are found in the Tibetan Himalayas. The Indian fox (*Vulpes bengalensis*) is comparatively rare, but the jackal (*C. aureus*) abounds everywhere, making night hideous by its never-to-be-forgotten yells. The jackal, and not the fox, is usually the animal hunted by the packs of hounds occasionally kept by Europeans.

The wild dog, or dhole (*Cyon*), is found in all the wilder jungles of India, including Assam and Lower Burma. Its characteristic is that

it hunts in packs, sometimes containing thirty dogs, and does not give tongue. When once a pack of wild dogs has put up any animal, that animal's doom is sealed. They do not

leave it for days, and finally bring it to bay, or run it down exhausted. A peculiar variety of wild dog exists in the Karen hills of Burma, thus described from a specimen in confinement. It was black and white, as hairy as a slyke-terrier, and as large as a medium-sized spaniel. It had an invariable habit of digging a hole in the ground, into which it crawled backwards, remaining there all day with only its nose and keen eyes visible. Among other dogs of the Indian peninsula, which is merely a mongrel, run wild and half starved; the poligar dog, an immense creature peculiar to the south; the greyhound, used for coursing; and the mastiff of Tibet and Bhutan. The striped hyaena (*Hyaena striata*) is common, being found wherever the wolf is absent. Like the wolf, it is very destructive both to the flocks and to children.

Of bears, the common black or sloth bear (*Melursus ursinus*) is common throughout India wherever rocky hills and forests occur. It is distinguished by a white horse-shoe on its breast. Its food consists of ants, honey and fruit. When disturbed it will attack man, and it is a dangerous antagonist, for it always strikes at the face. The Himalayan or Tibetan sun bear (*Ursus torquatus*) is found along the north, from the Punjab to Assam. During the summer it remains high up in the mountains, near the limit of snow, but in the winter it descends to 5000 ft. and even lower. Its congener, the Malayan sun bear (*U. malayanus*), is found in Lower Burma.

The elephant (*Elephas indicus*) is found in many parts of India throughout the north-west. Contrary to what might be anticipated from its size and from the habits of its African cousin, the Indian elephant is now, at any rate, an inhabitant of the plains, but of the hills; and even on the hills it is usually found among the higher ridges and plateaus, and not in the valleys. From the peninsula of India the elephant has been gradually exterminated, being only found now in the primeval forests of Coorg, Mysore and Travancore, and in the tributary state of Orissa. It still exists in places along the *terai* or submontane fringe of the Himalayas. The main source of supply at the present time is the confused mass of hills which forms the north-east boundary of British India, from Assam to Burma. Two varieties are there distinguished, the *gunda* or tusker, and the *makna* or *hine*, which has no tusks. The reports of the height of the elephant, like those of its intelligence, seem to be exaggerated. The maximum is probably 12 ft. If hunted, the elephant must be attacked on foot, and the sport is therefore dangerous, especially as the animal has but few parts vulnerable to a bullet. The regular mode of catching elephants is by means of large, or insignificant, enclosures, into which a wild herd is driven, then starved into submission, and tamed by animals already domesticated. The practice of capturing them in pitfalls is discouraged as cruel and wasteful. Elephants now form a government monopoly everywhere in India. The shooting of them is prohibited, except when they become dangerous to man or destructive to the crops; and the right of capturing them is only leased out upon conditions. A special law, under the title of "The Elephants Preservation Act (No. VI, of 1879), regulates this licensing system. Whoever kills, captures or injures an elephant, or attempts to do so, without a licence, is punishable by a fine of 500 rupees for the first offence; and a similar fine, together with six months' imprisonment, for a second offence. Though the supply is decreasing, elephants continue to be in great demand. Their chief use is in the timber trade and for government transport. They are also brought up by native chiefs at high prices for purposes of ostentation.

Of the rhinoceros, three distinct varieties are enumerated, two with a single and one with a double horn. The most familiar is the *Rhinoceros unicornis*, commonly found in the Brahmaputra valley. It has but one horn, and is covered with massive folds of naked skin. It sometimes attains a height of 6 ft.; its horn, which is much prized by the natives for medicinal purposes, seldom exceeds 14 in. in length. It frequents swampy, shady spots, and wallows in mud like a pig. The traditional antipathy of the rhinoceros to the elephant seems to be mythical. The Javan rhinoceros (*R. sondaicus*) is found in the Sunderbans and also in Burma. It also has but one horn, and mainly differs from the foregoing in being smaller, and having less prominent "saw-horns." Sumatran rhinoceros (*R. sumatrensis*) is found from Chittagong southwards through Burma. It has two horns and a bristly coat.

The wild hog (*Sus cristatus*) is well known as affording the most exciting sport in the world—"pig-sticking." It frequents cultivated situations, and is the most mischievous enemy of the Wild hog, villager. A rare animal, called the pigmy hog (*S. saltonensis*), exists in the *tarai* of Nepal and Sikkim, and has been shot in Assam. Its height is only 10 in., and its weight does not exceed 12 lb.

The wild ass (*Equus hemionus*) is confined to the sandy deserts of Sind and Cutch, where, from its speed and timidity, it is almost unapproachable.

Many wild species of the sheep and goat tribe are to be found in the Himalayan ranges. The *Ovis ammon* and *O. poli* are Tibetan rather than Indian species. The *arial* and the *shapu* are kindred species of wild sheep (*Ovis vignei*), found respectively in Ladakh and the Suleiman range. The former comes down to 2000 ft. above the sea, the latter never goes at altitudes lower than 12,000 ft. The *barhal*, or blue wild sheep

(*O. nāsura*), and the *markhor* and *tahr* (both wild goats), also inhabit the Himalayas. A variety of the ibex is also found there, as well as in the highest ranges of southern India. The *saruu* (*Nemorhaedus bubalinus*), allied to the chamois, has a wide range in the mountains of the north, from the Himalayas to Assam and Burma.

The antelope tribe is represented by comparatively few species, as compared with the great number peculiar to Africa. The antelope proper (*Antelope*), the "black buck" sportsmen, is very generally distributed. Its special habitat is salt plains, as on the coast-line of Gujarat and Orissa, where herds of fifty does may be seen, accompanied by a single buck. The doe is of a light fawn colour and has no horns. The colour of the buck is a deep brown-black above, sharply marked off from the white of the belly. His spiral horns, twisted for three or four turns like a corkscrew, often reach the length of 30 in. The flesh is dry and unsavoury, but is permitted meat food for Hindus, even of the Brahman caste. The *nilgai* or blue cow (*Boselaphus tragocamelus*) is also widely distributed, but specially abounds in Hindustan Proper and Gujarat. As with the antelope, the male alone has the dark-blue colour. The *nilgai* is held peculiarly sacred by Hindus, from its fancied kinship to the cow, and on this account its destructive inroads upon the crops are tolerated. The four-horned antelope (*Tetracerus quadricornis*) and the gazelle (*Gazella bennetti*), the chinkara or "ravine deer" of sportsmen, are also found in India.

The king of the deer tribe is the *sambhar* or *jarau* (*Cervus unicolor*), erroneously called "elk" by sportsmen. It is found on the forest-clad hills in all parts of the country. It is of a deep-brown colour, with hair on its neck almost like a mane; and it stands nearly 5 ft. high, with spreading antlers nearly 3 ft. in length.

Next in size is the swamp deer or *bara-singha*, signifying "twelve points" (*C. dussumeri*), which is common in Lower Bengal and Assam. The *chital* or spotted deer (*C. axis*) is generally admitted to be the most beautiful inhabitant of the Indian jungles. Other species include the hog deer (*C. porcinus*), the barking deer or muntjac (*Cervulus muntjac*), and the chevrotain or mouse deer (*Tragulus meminna*). The musk deer (*Moschus moschiferus*) is confined to Tibet.

The ox tribe is represented in India by some of its noblest species. The *gaur* (*Bos gaurus*), the "bison" of sportsmen, is found in all the hill jungles of the country, in the Western Ghats, in Central India, in Assam, and in Burma.

This animal sometimes attains the height of 20 hands (close on 7 ft.), measuring from the hump against the shoulder. Its horns are spirally and slender, and are enormously massive, the colour is dark chestnut, or coffee-brown. From the difficult nature of its habitat, and from the ferocity with which it charges an enemy, the pursuit of the bison is no less dangerous and no less exciting than that of the tiger or the elephant. Akin to the *gaur*, though not identical, are the *gayal* or *mithun* (*B. frontalis*), confined to the hills of the north-east frontier, where it is domesticated for sacrificial purposes by the aboriginal tribes, and the *taise* or *banting* (*B. sondaicus*), found in Burma. The wild buffalo (*Bos bubalus*) and *heros* form the tame and the larger of the two Indian buffaloes.

**Buffalo.**—The finest specimens come from Assam and Burma. The horns of the bull are thicker than those of the cow, but the horns of the cow are larger. A head has been known to measure 13 ft. 6 in. in circumference, and 6 ft. 6 in. between the tips. The greatest height is 6 ft. The colour is a slaty black; the hide is immensely thick, with scanty hairs. Alone perhaps of all wild animals in India, the buffalo will charge unprovoked. Even tame buffaloes seem to have an inveterate dislike to Europeans.

The rat and mouse family is only too numerous. Conspicuous in it is the loathsome bandicoot (*Nesocricet bandicota*), which sometimes measures 2 ft. in length, including its tail, and weighs 3 lb.

**Rat tribe.**—It burrows under houses, and is very destructive to plants, fruit and even poultry. More interesting is the tree mouse (*Vandelestia*), about 7 in. long, which makes its nest in palms and bamboos. The field rats (*Mus melitoda*) occasionally multiply so exceedingly as to diminish the out-turn of the local harvest, and to require special measures for their destruction.

**Birds.**—The ornithology of India, though it is not considered so rich in specimens of gorgeous and variegated plumage as that of other tropical regions, contains many splendid and curious varieties. Some are clothed in nature's gay attire, others distinguished by strength, size and fierceness. The parrot tribe is the most remarkable for beauty. Among birds of prey, four vultures are found, including the common scavengers (*Gyps indicus* and *G. bengalensis*). The eagles comprise many species, but none to surpass the golden eagle of Europe. Of falcons, there are the peregrine (*F. peregrinus*), the sharp (*F. peregrinator*), and the lesser (*F. jugger*), which are all trained by the natives for hawking of hawks, the *shikara* (*Accipiter badius*), the goshawk (*A. palumbarius*), and the sparrow-hawk (*Accipiter nisus*). Kingfishers of various kinds and herons are sought for their plumage. No bird is more popular with natives than the *maina* (*Acridothera tristis*), a member of the starling family, which lives contentedly in a cage, and can be taught to pronounce words, especially the name of the god Rama. Water-plovers are especially numerous. Of game-birds, the forken (*Syphleotis arista*) is valued as much for its rarity as for its delicious flesh. Snipe (*Gallinago*) are especially abundant at certain seasons.

Such numbers that one gun has been known to make a bag of one

hundred brace in a day. Pigeons, partridges, quail, plover, duck, teal, sheldrake, widgeon—all of many varieties—complete the list of small game. The red jungle fowl (*Gallus ferrugineus*), supposed to be the ancestor of our own poultry, is not good eating; and the same may be said of the peacock (*Pavo cristatus*), except when young. The pheasant does not occur in India Proper, though a white variety is found in Burma.

**Reptiles.**—The serpent tribe in India is numerous; they swarm in all the gardens, and intrude into the dwellings of the inhabitants, especially in the rainy season. Most are comparatively harmless, but the bite of others is speedily fatal. The cobra di capello (*Naja tripudians*)—the name given to it by the Portuguese, from the appearance of a hood which it produces by the expanded skin about the neck—is the most dreaded. It seldom exceeds 3 or 4 ft. in length, and is about 14 in. thick, with a single head covered on the top with large smooth scales; it is of a pale brown colour above, and the belly is of a bluish-white tinged with pale brown or yellow. The Russian snake (*Vipera russelli*), about 4 ft. in length, is of a pale yellowish-brown, beautifully variegated with large oval spots of deep brown, with a white edging. Its bite is extremely fatal. Itinerant showmen carry about these serpents, and cause them to assume a dancing motion for the amusement of the spectators. They also give out that they render snakes harmless by the use of charms or music,—in reality it is by extracting the venomous fangs. But, in India, from frequent accidents, which occur, they sometimes dispense with this precaution. All the salt-water snakes in India are poisonous, while the fresh-water forms are wholly innocuous.

The other reptiles include two species of crocodile (*C. porosus* and *C. palustris*) and the gharial (*Gavialis gangeticus*). These are more ugly in appearance than destructive to human life. Scorpions also abound.

**Fishes.**—All the waters of India—the sea, the rivers and the tanks—teem with a great variety of fishes, which are caught in every conceivable way, and furnish a considerable proportion of the food of the poorer classes. They are eaten fresh, or as nearly fresh as may be, for the art of curing them is not generally practised, owing to the exigencies of the salt monopoly.

In Burma the favourite relish of *nga-pi* is prepared from fish; and at Goa, and at the junction of the Brahmaputra with the Ganges, and along the Madras coast many establishments exist for salting fish in bond. The indiscriminate slaughter of fry, and the obstacles opposed by the venoous fish bar, are said to be causing a sensible diminution in the supply in certain rivers. Measures of conservatism have been suggested, but their execution would be almost impracticable. Among Indian fishes, the *Cyprinidae* or carp family and the *Siluridae* or cat-fishes are best represented. From the angler's point of view, by far the finest fish is the *mahseer* (*Barbus*), found in all hill streams, whether in Assam, the Punjab or the South. One has been caught weighing 60 lb, which gave play for more than seven hours. Though called the richest of India, the *mahseer* is really a species of barbel. One of the salmon, and most delicious of Indian fishes is the *hilsa* (*Clupea hilsa*), which tastes and looks like a fat white salmon. But the enhanced price of fish and the decreased supply throughout the country are matters of grave concern both to the government and the people.

**Insects.**—The insect tribes in India may be truly said to be innumerable. The heat and the rains give incredible activity to noxious or troublesome insects, and to others of a more showy class, whose large wings surpass in brilliancy the most splendid colours of art. Mosquitoes are innumerable, and moths and ants of the most destructive kind, as well as others equally noxious and disagreeable. Amongst those which are useful are the bee, the silk-worm, and the insect that produces lac. Clouds of locusts occasionally appear, which leave no trace of green behind them, and give the country over which they pass the appearance of a desert. Their size is about that of a man's finger, and their colour reddish. They are swept north by the wind till they strike upon the outer ranges of the Himalayas.

## POLITICAL DIVISIONS

India (including Burma) has a total area of 1,766,507 sq. m., and a population (1901) of 294,361,056. Of this total, 1,087,204 sq. m., with a population of 231,890,515, consists of British territory, administered directly by British officers; while the remaining 679,303 sq. m., with a population of 62,461,549, is divided up among various native states, all of which acknowledge the suzerainty of the paramount power, but are directly administered by semi-independent rulers, usually assisted by a British resident.

The British possessions are distributed into thirteen provinces of varying size, each with a separate head, but all under the supreme control of the governor-general in council.

These thirteen provinces or local governments are British India. Ajmer-Merwara, Andaman and Nicobar Islands, British Baluchistan, Bengal, Bombay, Burma, Central Provinces

with Berar, Coorg, Eastern Bengal and Assam, Madras, North-West Frontier Province, Punjab, and the United Provinces of Agra and Oudh. Each of these provinces is described under its separate name.

The native states are governed, as a rule, by native princes with the help of a political officer appointed by the British government and residing at their courts. Some of them administer the internal affairs of their states with almost complete independence; others require more assistance or a stricter control. These feudatory rulers possess revenues and armies of their own, and the more important exercise the power of life and death over their subjects; but the authority of each is limited by treaties or engagements, or recognized practice by which their subordinate dependence on the British government is determined. That government, as suzerain in India, does not allow its feudatories to form alliances with each other or with foreign states. It interferes when any chief misgoverns his people; rebukes, and if needful removes, the oppressor; protects the weak; and firmly imposes peace upon all. There are in all nearly 700 distinct units, which may be divided into the following groups.

The most important states are Hyderabad, Mysore, Baroda, Kashmir and Jammu, the Rajputana Agency, and the Central

India Agency. The first four of these are single units, each under its separate ruler; but Rajputana and Central India are political groups consisting of many states, enjoying different degrees of autonomy. Rajputana is the name of a great territorial circle, containing twenty states in all; while under the Central India Agency there are grouped 148 states and petty chiefs.

Amongst the minor states, subordinate to the various provincial governments, five are controlled by Madras; 354 by Bombay,

many of them being quite petty; 26 by Bengal, of which Kuch Behar is the chief; 34 by the Punjab, amongst which the Phulkian Sikh states and Bhalwalpur are the most important; 2 under Eastern Bengal and Assam; 15 under the Central Provinces; and 2 under the United Provinces. Burma contains a number of Shan states, which technically form part of British India, but are administered through their hereditary chiefs. All the most important of these native states are separately described.

In addition to the internal states, which have a fixed status, there are several frontier tracts of India, whose status is fluctuating or not strictly defined. In Baluchistan there are the native states of Kalat and Las Bela, and also tribal areas belonging to the Marri and Bugti tribes.

On the north-west frontier, in addition to the chiefships of Chitral and Dir, there are a number of independent tribes which reside within the political frontier of British India, but over which effective control has never been exercised. The territory belonging to these tribes, of whom the chief are the Waziris, Afridis, Orakzais, Mohmands, Swatis and Bajouris, is attached to, but is not strictly within, the North-West Frontier Province. Kashmir possesses as feudatories Gilgit and a number of petty states, of which the most important are Hunza-Nagar and Chilas, but effective control over these outlying states has only been asserted in comparatively recent years for political reasons. Nepal and Bhutan, though independent, are under various commercial and other agreements with the government of India. On the north-east frontier, as on the north-west, semi-independent tribes extend across the frontier into independent country. Similarly Karenni, on the Burmese border, is not included in British territory, but the superintendent of the Shan states exercises some judicial and other powers over it.

#### THE PEOPLE

According to the census of 1901 the population of India (including Burma) was 294,361,056. But this vast mass of people does not constitute a single nationality, neither is it divided into a number of different nations of distinct blood and distinct language. They are drawn, indeed, from four well-marked elements: the non-Aryan tribes or aborigines of the

country; the Aryan or Sanskrit-speaking race; the great mixed population which has grown out of a fusion of the two previous elements; and the Mahomedan invaders from the north-west. These four elements, however, have become inextricably mixed together, some predominating in one portion of the country, some in another, while all are found in every province and native state. The chief modern divisions of the population, therefore, do not follow the lines of blood and language, but of religion and caste.

Of the four elements already enumerated the oldest are the wild tribes of central India, such as the Bhils and Gonds, who probably represent the original inhabitants of the country. These number some 11,000,000. Second come the Dravidians of the south, amounting to about 54,000,000. Thirdly come the Aryans, inhabiting mainly that portion of India north of the Nerubda which is known as Hindustan proper. Of these only the Brahmans and Rajputs, about 20,000,000, are of pure Aryan blood. The remaining 135,000,000 Hindus represent the fusion of Aryan and non-Aryan elements. Fourthly come the Mahomedans, numbering some 62,000,000. Many of them are the descendants of Arab, Afghan, Mogul and Persian invaders, and the remainder are converts made to Islam in the course of the centuries of Mahomedan rule.

The census report of 1901 divided the population of India into seven distinct racial types: the Turko-Iranian type, represented by the Baluch, Brahui and Afghans of the Baluchistan Agency and the North-West Frontier Province; the **Racial type.** Indo-Aryan type, occupying the Punjab, Rajputana and Kashmir, and having as its characteristic members the Rajputs, Khattris and Jats; the Scytho-Dravidian type of western India, comprising the Maharrattas; the Kunbis, and the Coorgs, probably formed by a mixture of Scythian and Dravidian elements; the Aryo-Dravidian type found in the United Provinces, in parts of Rajputana, and in Behar, represented in its upper strata by the Hindustani Brahman, and in its lower by the Chamar. This type is probably the result of the intermixture, in varying proportions, of the Indo-Aryan and Dravidian types, the former element predominating in the higher groups and the latter in the lower. The fifth type is the Mongolo-Dravidian of Bengal and Orissa, comprising the Bengal Brahmans and Kayasths, the Mahomedans of Eastern Bengal, and other groups peculiar to this part of India. It is probably a blend of Dravidian and Mongoloid elements with a strain of Indo-Aryan blood in the higher groups. The sixth type is the Mongoloid of the Himalayas, Nepal, Assam and Burma, represented by the Kanets of Lahoul and Kulu, the Lepchas of Darjeeling, the Limbus, Murmis and Gurungs of Nepal, the Bedo of Assam, and the Burmese. Seventh and last comes the Dravidian type, extending from Ceylon to the valley of the Ganges, and pervading the whole of Madras and Mysore and most of Hyderabad, the Central Provinces, Central India and Chota Nagpur. Its most characteristic representatives are the Paniyans of the south Indian hills and the Santals of Chota Nagpur. This is probably the original type of the population of India, now modified to a varying extent by the admixture of Aryan, Scythian and Mongoloid elements.

It is apparently from the differences in civilization and political power resulting from these successive strata of conquerors over the conquered that the Hindu system of caste arose. A **Caste.** caste is defined in the census report of 1901 as a collection of families or groups of families bearing a common name, which usually denotes or is associated with a specific occupation; claiming common descent from a mythical ancestor, human or divine, professing to follow the same calling, and regarded by those who are competent to give an opinion as forming a single homogeneous community. A caste is almost invariably endogamous, in the sense that a member of the large circle denoted by the common name may not marry outside that circle, but within the circle there are usually a number of smaller circles, each of which is also endogamous. Thus it is not enough to say at the present day that a Brahman cannot marry any woman who is not a Brahman; his wife must not only be a Brahman, but must also belong to the same endogamous division of the Brahman caste. The origin of caste was described by Sir Denzil Ibbetson in the Punjab Census Report of 1881 in the following terms: "We have the following steps in the process by which caste has been evolved in the Punjab—(1) the tribal divisions common to all primitive societies; (2) the guilds based upon hereditary occupation common to the middle life of all communities; (3) the exaltation of the priestly office to a degree unexampled in other countries; (4) the exaltation of the Levitical blood by a special insistence upon the necessarily hereditary nature of occupation; (5) the preservation and support of this principle by the elaboration from the theories of the Hindu creed or cosmogony of a purely artificial set of rules regulating marriage and intermarriage, declaring certain occupations and foods to be impure and polluting, and

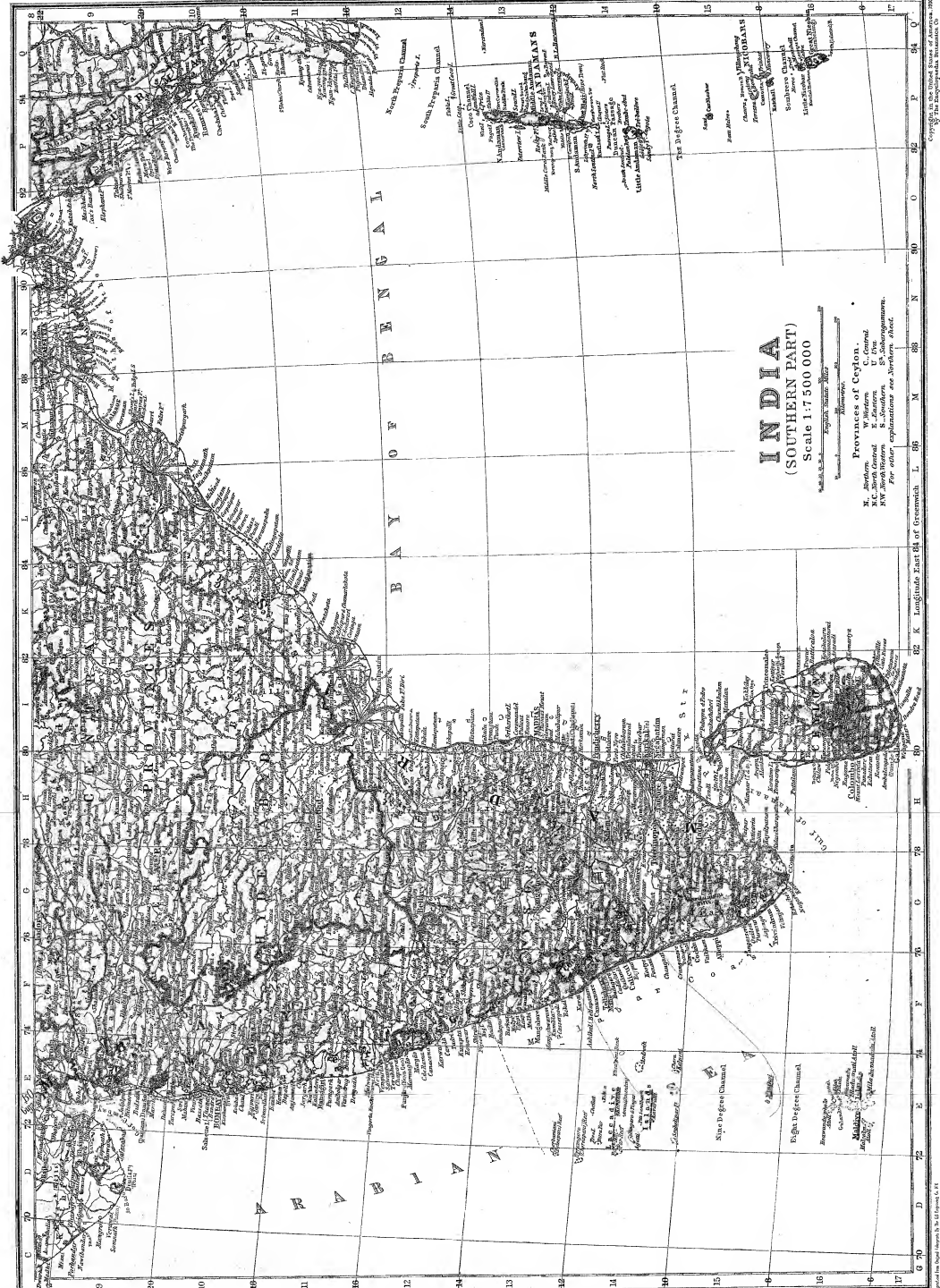

BAY OF BENGAL

# INDIA (SOUTHERN PART)

Scale 1:750 000

Provinces of Cepton.  
W. Western C. Central  
N.W. North Western S. Southern  
S.W. South Western  
For other explanations see Sailing Directions.

Copyrighted by the Hydrographic Department, London, 1914.

prescribing the conditions and degree of social intercourse permitted between the several castes. Add to these the pride of social rank and the pride of blood, which are natural to man, and which alone could reconcile a nation to restrictions at once irksome from a domestic and burdensome from a material point of view, and it is hardly to be wondered at that caste should have assumed the rigidity which distinguishes it in India." Caste has, in fact, come to be the chief dominating factor in the life of the ordinary native of India. All a man's actions from the cradle to the grave are regulated by it; and tendency in modern India is for tribes to turn into castes. So widespread is its influence that, though originally a purely Hindu institution, it has come to exercise considerable influence over their Mahomedan neighbours (see CASTE).

The chief Indian religions with the numbers of their followers according to the census of 1901 are: Hindu (2,07,147,026),

**Religion.** Mahomedan (62,458,977), Buddhist (4,947,675), Sikh (2,195,339), Jain (1,334,148), Christian (2,923,241), Parsee (92,190), and Animist (8,584,148). The oldest of these religions is Animism (*q.v.*), which represents the beginnings of religion in India, and is still professed by the more primitive tribes, such as Santals, Bhils and Gonds. The transition from this crude form of religion to popular Hinduism (*q.v.*) is comparatively easy. The most obvious characteristics of the ordinary Hindu are that he worships a plurality of gods, looks upon the cow as a sacred animal, and accepts the Brahmanical supremacy (see BRAHMANISM) and the caste system; and when it is a question whether one of the animistic tribes has or has not entered the fold of Hinduism, these two latter points seem to be the proper test to apply. On the other hand there are various offshoots from orthodox Hinduism, the distinguishing feature of which, in their earlier history at least, is the obliteration of caste distinctions and the rejection of the Brahmanical hierarchy. It is doubtful if Buddhism, and still more so if Jainism and Sikhism, all of which are commonly recognized as distinct religions, ever differed from Hinduism to a greater extent than did the tenets of the earlier followers of Chaitanya in Bengal or those of the Lingayats in Mysore; and yet these latter two are regarded only as sects of Hinduism. Considerations of their history and past political importance have led to the elevation of Buddhism, Jainism and Sikhism to the rank of independent religions, while the numerous other schismatic bodies are held to be only sects. But there is a marked tendency both on the part of the sects and of the distinct religions to lapse into the parent religion from which they sprang. In this way both Buddhism (*q.v.*) and Jains (*q.v.*) have almost been swallowed up by Hinduism; Sikhism (*q.v.*) is only preserved by the military requirements of the British, and even the antagonism between Hindu and Mahomedan is much less acute than it used to be. The bewildering diversity of religious beliefs collected under the name of Hinduism has no counterpart amongst the Mahomedans (see MAHOMMEDAN RELIGION), who are limited as to their main tenets by the teaching of a single book, the Koran. The two main sects are the Sunnis and the Shi'ahs. In India the Sunnis greatly preponderate, but they usually share with the Shi'ahs their veneration for Hasan and Husain and strictly observe the Mohurrum.

The Mahomedans of India may be divided into two classes, pure Mahomedans from the Mogul and Pathan conquering races, and Mahomedan converts, who differ very little from the surrounding Hindu population from which they originally sprang. The pure Mahomedans may again be subdivided into four sections: Moguls, or the descendants of the last conquering race, including Persians; Afghans or Pathans, who from their proximity to the frontier are much more strongly represented, chiefly in the Punjab and in the Rohilkhand division of the United Provinces; Sayads, who claim to be lineally descended from the Prophet; and Sheikh, which is a name often adopted by converts. The remainder are unspecified, but the following tribes or classes among Indian Mussulmans are worthy of notice. In Bengal the vast majority of the Mahomedans manifestly belong to the same race as the lowest castes of Hindus. They are themselves subdivided into many classes, which in their devotion to hereditary occupations are scarcely to be distinguished from Hindu castes. In the Punjab, besides the Pathan immigrants from across the frontier, Islam has taken a strong hold of the

native population. The census returned large numbers of Jats, Rajputs and Gujars among the Mussulmans. Here, again, the Mahomedans are not strongly distinguished from their Hindu brethren. Bombay possesses three peculiar classes of Mussulmans, each of which is specially devoted to maritime trade—the Memons, chiefly in Sind; the Borahs, mainly in Gujrat; and the Khojias, of whom half live in the island of Bombay. In southern India the majority are known as Deccani Mussulmans, being descendants of the armies led by the kings and nababs of the Deccan. But the two peculiar races of the south are the Moplahs and the Labbays, both of which are seated along the coast and follow a seafaring life. They are descended from the Arab traders who settled there in very early times, and were recruited partly by voluntary adhesions and partly by forcible conversions during the persecutions of Hyder Ali and Tippoo Sultan. The Moplahs of Malabar are notorious for repeated outbreaks of bloody fanaticism. In proportion to the total population Islam is most strongly represented in the North-West Frontier Province, where it is the religion of 92% of the inhabitants; then follow Kashmir and Sind with about 75% each. Eastern Bengal and Assam with 58%, the Punjab with 49%, Bengal with 18%, and the United Provinces with 14%. In the great Mahomedan state of Hyderabad the proportion is only 10%. It appears that the Mahomedans generally tend to increase at a faster rate than the Hindus.

The Sikh religion is almost entirely confined to the Punjab. Of the total number of 2,195,339 Sikhs all but 64,352 are found in the Punjab, and two-thirds of the remainder are in the United Provinces and Kashmir which adjoin it.

Buddhism had disappeared from India long before the East India Company gained a foothold in the country, and at the present day there are very few Buddhists in India proper. Of the 9,476,759 enumerated in the census of 1901 all but some three hundred thousand were in Burma. The greater part of the remainder are found in Bengal on the borders of Burma, on the borders of Nepal, Tibet and Bhutan, and in the Spiti, Lahul and Kananwar districts of the Punjab Himalayas, where many of the inhabitants are of Tibetan origin.

More than two-fifths of the Jains in India are found in Bombay and its native states, including Baroda. They are proportionally most numerous in central and western Rajputana and in Gujrat and Central India.

The Parsees, though influential and wealthy, are a very small community, numbering only 94,000, of whom all but 7000 are found in Bombay. The remainder are scattered all over India, but are most numerous in Hyderabad, the Central India Agency, and the Central Provinces.

The Christian community numbers 2,923,241, of whom, 2,664,313 are natives and the remainder Europeans and Eurasians. Of the native Christians about two-fifths are Roman Catholics and one-eighth Uniat Syrians; one-ninth belong to the Anglican communion, one-eleventh are Jacobite Syrians, and one-twelfth are Baptists; while Lutherans, Methodists and Presbyterians are also represented. Nearly two-thirds of the total number are found in the Madras Presidency, including its native states. In Cochín and Travancore, where the Syrian church has most of its adherents, nearly a quarter of the population profess the Christian faith. More than four-fifths of the Christians in Madras proper are found in the eight southernmost districts, the scene of the labours of St Francis Xavier and the Protestant missionary Schwarz. The adherents of the Syrian church, known as "Christians of St Thomas," in Malabar, Travancore and Cochín are the most ancient Christian community in the south. After these come the Roman Catholics, who trace their origin to the teaching of St Francis Xavier and the Madura Jesuits. The Protestants date only from about the beginning of the 19th century, but their progress since that time has been considerable. As is to be expected in the case of a religion with a strong proselytizing agency, the growth of Christianity is far more rapid than that of the general population. Taking native Christians alone, their numbers increased from 1,246,288 in 1872 to 2,664,313 in 1901, and the rate of increase in the thirty years was even greater than these figures would show, because they include the Syrian church, whose numbers are practically constant. The classes most receptive of Christianity are those who are outside the Hindu system, or whom Hinduism regards as degraded. Amongst the Hindu higher castes there are serious obstacles in the way of conversion, of which family influence and the caste system are the greatest.

**Languages.**—According to the linguistic survey of India no fewer than 147 distinct languages are recorded as vernacular in India. These are grouped according to the following system:—

## Vernaculars of India.

	Number of languages spoken.
Malayo-Polynesian Family—	
Malay Group (7831)	2
Mon-Khmer Family (427,760)	7
Tibeto-Chinese Family—	
Tibeto-Burman Sub-family (9,560,454)	49
Siamese-Chinese Sub-family (1,724,085)	9
Dravidian Family (56,514,524)	14
Munda Family (3,179,275)	10
Indo-European Family, Aryan Sub-family—	
Iranian Branch (1,377,023)	3
Indo-Aryan Branch (219,780,650)	22
Semitic Family (42,881)	1
Hamitic Family (55,301)	1
Unclassed Languages	2
Andamanese (1882)	
Gipsy Languages (344,143)	
Others (125)	
Total Vernaculars of India	147

The only representatives of the Malayo-Polynesian group in India are the Selungs of the Mergui Archipelago and the Nicobarese. The Mon-Khmer family, which is most numerous in Indo-China, is here represented by the Talings of southern Burma and the Khasis of Assam. Of the Tibeto-Chinese family, the Tibeto-Burman sub-family, as its name implies, is spoken from Tibet to Burma; while the Siamese-Chinese sub-family is represented by the Karens and Shans of Burma. The Munda or Kolarian family, which is now distinguished from the Dravidian, is almost confined to Chota Nagpur, its best-known tribe being the Santals. The Dravidian family includes the four literary languages of the south, as well as many dialects spoken by hill tribes in central India, and also the isolated Brahui in Baluchistan. Of the Indo-European family, the Iranian branch inhabits Persia, Afghanistan and Baluchistan; while the Indo-Aryan branch is spoken by the great mass of the people of northern India. The only Semitic language is Arabic, found at Aden, where also the Hamitic Somali was returned. Gipsy dialects are used by the nomadic tribes of India, while Andamanese has not been connected by philologists with any recognized family of speech.

All the chief languages of India are described under their separate names.

**Education.**—The existing system of education in India is mainly dependent upon the government, being directly organized by the state, at least in its higher departments, assisted throughout by grants-in-aid and under careful inspection. But at no period of its history has India been an altogether unenlightened country. The origin of the Deva-Nagari alphabet is lost in antiquity, though that is generally admitted not to be of indigenous invention. Inscriptions on stone and copper, the palm-leaf records of the temples, and in later days the widespread manufacture of paper, all alike indicate, not only the general knowledge, but also the common use, of the art of writing. From the earliest times the caste of Brahmans has preserved, by oral tradition as well as in MSS., a literature unrivalled alike in its antiquity and in the intellectual subtlety of its contents. The Mahomedan invaders introduced the profession of the historian, which reached a high degree of excellence, even as compared with contemporary Europe. Through all changes of government vernacular instruction in its simplest form has always been given, at least to the children of respectable classes, in every large village. On the one hand, the *tols* or seminaries for teaching Sanskrit philosophy at Benares and Nadiya recall the schools of Athens and Alexandria; on the other, the importance attached to instruction in accounts reminds us of the picture which Horace has left of a Roman education. Even at the present day knowledge of reading and writing is, owing to the teaching of Buddhist monks, as widely diffused throughout Burma as it is in some countries of Europe. English efforts to stimulate education have ever been most successful when based upon the existing indigenous institutions.

During the early days of the East India Company's rule the promotion of education was not recognized as a duty of government. The enlightened mind of Warren Hastings did indeed anticipate his age by founding the Calcutta *madrasa* for Mahomedan teaching, and by affording steady patronage alike to Hindu pundits and European students. But Wellesley's schemes of imperial dominion did not extend beyond the establishment

of a college for English officials. Of the Calcutta colleges, that of Sanskrit was founded in 1824, when Lord Amherst was governor-general, the medical college by Lord William Bentinck in 1835, the Hooghly *madrasa* by a wealthy native gentleman in 1836. The Sanskrit college at Benares had been established in 1791, the Agra college in 1823. Meanwhile the missionaries made the field of vernacular education their own. Discouraged by the official authorities, and ever liable to banishment or deportation, they not only devoted themselves with courage to their special work of evangelization, but were also the first to study the vernacular dialects spoken by the common people. Just as two centuries earlier the Jesuits at Madura, in the extreme south, composed works in Tamil, which are still acknowledged as classical by native authors, so did the Baptist mission at Serampur, near Calcutta, first raise Bengali to the rank of a literary dialect. The interest of the missionaries in education, which has never ceased to the present day, though now comparatively overshadowed by government activity, had two distinct aspects. They studied the vernacular, in order to reach the people by their preaching and to translate the Bible; and they taught English, as the channel of non-sectarian learning.

At last the government awoke to its own responsibility in the matter of education, after the long and acrimonious controversy between the advocates of English and vernacular teaching had worn itself out. The present system dates from 1854, being based upon a comprehensive despatch sent out by Sir C. Wood (afterwards Lord Halifax) in that year. At that time the three universities were founded at Calcutta, Madras and Bombay; English-teaching schools were established in every district; the benefit of grants-in-aid was extended to the lower vernacular institutions and to girls' schools; and public instruction was erected into a department of the administration in every province, under a director, with a staff of inspectors. In some respects this scheme may have been in advance of the time; but it supplied a definite outline, which has gradually been filled up with each succeeding year of progress. A network of schools has now been spread over the country, graduated from the indigenous village institutions up to the highest colleges. All alike receive some measure of pecuniary support, which is justified by the guarantee of regular inspection; and a series of scholarships at once stimulates efficiency and opens a path to the university for children of the poor.

During Lord Curzon's term of office the whole system of education in India was examined, reported upon and improved. The five universities of Calcutta, Madras, Bombay, Allahabad and Lahore, which were formerly merely examining bodies, had their senates reformed by the introduction of experts; while hostels or boarding-houses for the college students were founded, so as to approach more nearly to the English ideal of residential institutions. The schools for secondary education were found to be fairly prosperous, owing to the increasing demand for English education; but more teachers and more inspectors were provided. In the primary schools, however, which provide vernacular teaching for the masses, there were only 4½ million pupils to the 300 millions of India. In 1901 three out of every four country villages had no school, only 3,000,000 boys, or less than one-fifth of the total number of school-going age, were in receipt of primary education, and only one girl for every ten of the male sex, or 2½ of the female population of school-going age. In order to remedy these defects primary education was made a first charge upon provincial revenues, and a permanent annual grant of £213,000 was made from the central government, with the result that thousands of new primary schools have since been opened. The technical schools may be divided into two classes, technical colleges and schools and industrial schools. The former include colleges of engineering and agriculture, veterinary colleges, schools of art and similar institutions. Several of these, such as the Rurki and Sibpur engineering colleges, the college of science at Poona, the Victoria Jubilee Institute at Bombay and some of the schools of art, have shown excellent results. The agricultural colleges have been less successful. The industrial schools were largely engaged in

1901 in teaching carpentry and smithy-work to boys who never intended to be carpenters or smiths; but this misdirection of industry has since been remedied, and the industrial schools have been made the first stepping-stone towards a professional career. In addition a number of technical scholarships of £1,50 each have been founded tenable in Europe or America.

## ADMINISTRATION

By the act of parliament which transferred the government of India from the company to the crown, the administration in England is exercised by the sovereign through a secretary of state, who inherits all the powers formerly belonging to the Court of Directors and the Board of Control, and who, as a member of the cabinet, is responsible to parliament. In administrative details he is assisted by the Council of India, an advisory body, with special control over finance. This council consists of not more than fifteen and not fewer than ten members, appointed by the secretary of state for a term of seven years, of whom at least nine must have served or resided in India for ten years. A Hindu and a Mahomedan were for the first time appointed to the council in 1907.

At the head of the government in India is the governor-general, styled also viceroy, as representative of the sovereign.

**The Supreme Government.** He is appointed by the crown, and his tenure of office is five years. The supreme authority, civil and military, including control over all the local governments, is vested in the governor-general in council, commonly known as "the Government of India," which has its seat at Calcutta during the cold season from November to April, and migrates to Simla in the Punjab hills for the rest of the year. The executive council of the governor-general is composed of six ordinary members, likewise appointed by the crown for a term of five years, of whom three must have served for ten years in India and one must be a barrister, together with the commander-in-chief as an extraordinary member. A Hindu barrister was first appointed a member of council in 1909. The several departments of administration—Foreign, Home, Finance, Legislative, Army, Revenue and Agriculture (with Public Works), Commerce and Industry, Education (added in 1910)—are distributed among the council after the fashion of a European cabinet, the foreign portfolio being reserved by the viceroy; but all orders and resolutions are issued in the name of the governor-general in council and must be signed by a secretary.

For legislative purposes the executive council is enlarged into a legislative council by the addition of other members, *ex officio*, nominated and elected. In accordance with regulations made under the Indian Councils Act 1909, these additional members number 61, making 68 in all with the viceroy, so arranged as to give an official majority of three. The only *ex-officio* additional member is the lieutenant-governor of the province in which the legislative council may happen to meet; nominated members number 35, of whom not more than 28 may be officials; while 25 are elected, directly or indirectly, with special representation for Mahomedans and landholders. Apart from legislation, the members of the council enjoy the right to interpellate the government on all matters of public interest, including the putting of supplementary questions; the right to move and discuss general resolutions, which, if carried, have effect only as recommendations; and the right to discuss and criticize in detail the budget, or annual financial statement.

The local or provincial governments are fifteen in all, with varying degrees of responsibility. First stand the two presidencies of Madras (officially Fort St George) and Bombay, each of which is administered by a governor and council appointed by the crown. The governor is usually sent from England; the members of council may number four, of whom two must have served in India for ten years. Next follow the five lieutenant-governorships of Bengal, the United Provinces of Agra and Oudh, the Punjab, Burma, and Eastern Bengal and Assam, for each of which a council may be appointed, beginning with

Bengal. Last come the chief commissionerships, of which the Central Provinces (with Berar) rank scarcely below the lieutenant-governorships, while the rest—the North-West Frontier Province, British Baluchistan, Ajmer-Merwara, Coorg and the Andamans—are minor charges, generally associated with political supervision over native states or frontier tribes. The two presidencies and also the five lieutenant-governorships each possesses a legislative council, modelled on that of the governor-general, but so that in every case there shall be a majority of non-official members, varying from 13 to 3.

Within the separate provinces the administrative unit is the district, of which there are 249 in India. In every province except Madras there are divisions, consisting of three or more districts under a commissioner. **Districts.** The title of the district officer varies according to whether the province is "regulation" or "non-regulation." This is an old distinction, which now tends to become obsolete; but broadly speaking a larger measure of discretion is allowed in the non-regulation provinces, and the district officer may be a military officer, while in the regulation provinces he must be a member of the Indian civil service. In a regulation province the district officer is styled a collector, while in a non-regulation province he is called a deputy-commissioner. The chief non-regulation provinces are the Punjab, Central Provinces and Burma; but non-regulation districts are also to be found in Bengal, Eastern Bengal and Assam, the United Provinces and Sind.

The districts are partitioned out into lesser tracts, which are strictly units of administration, though subordinate ones. The system of partitioning, and also the nomenclature, vary in the different provinces; but generally it may be said that the subdivision or *tahsil* is the ultimate unit of administration. The double name indicates the twofold principle of separation: the subdivision is properly the charge of an assistant magistrate or executive officer, the *tahsil* is the charge of a deputy-collector or fiscal officer; and these two offices may or may not be in the same hands. Broadly speaking, the subdivision is characteristic of Bengal, where revenue duties are in the background, and the *tahsil* of Madras, where the land settlement requires attention year by year. There is no administrative unit below the subdivision or *tahsil*. The *thana*, or police division, only exists for police purposes. The *pargana*, or fiscal division, under native rule, has now but an historical interest. The village still remains as the agricultural unit, and preserves its independence for revenue purposes in most parts of the country. The township is peculiar to Burma.

Bengal (including Eastern Bengal and Assam), Madras, Bombay and the old North-Western Provinces each has a high court, established by charter under an act of parliament, with judges appointed by the crown. **The Judicial Service.** Of the other provinces the Punjab and Lower Burma have chief courts, and Oudh, the Central Provinces, Upper Burma, Sind and the North-West Frontier Province have judicial commissioners, all established by local legislation. From the high courts, chief courts and judicial commissioners an appeal lies to the judicial committee of the privy council in England. Below these courts come district and sessions judges, who perform the ordinary judicial work of the country, civil and criminal. Their jurisdictions coincide for the most part with the magisterial and fiscal boundaries. But, except in Madras, where the districts are large, a single civil and sessions judge sometimes exercises jurisdiction over more than one district. In the non-regulation territory judicial and executive functions are to a large extent combined in the same hands.

The law administered in the Indian courts is described in the article INDIAN LAW.

The chief of the Indian services is technically known as the Indian civil service. It is limited to about a thousand members, who are chosen by open competition in England between the ages of twenty-one and twenty-four. **Indian Services.** Nearly all the higher appointments, administrative and judicial, are appropriated by statute to this service, with

the exception of a few held by military officers on civil duty in the non-regulation provinces. Other services mainly or entirely recruited in England are the education department, police, engineering, public works, telegraph and forest services. In addition to the British officials employed in these services, there is a host of natives of India holding superior or subordinate appointments in the government service. According to a calculation made in 1904, out of 1370 appointments with a salary of £800 a year and upwards, 1263 were held by Europeans, 15 by Eurasians and 92 by natives of India. But below that line natives of India greatly preponderate; of 26,908 appointments ranging between £800 and £60 a year, only 5205 were held by Europeans, 5420 by Eurasians and 16,283 by natives.

These figures show that less than 6500 Englishmen are employed to rule over the 300 millions of India. On the other hand, natives manage the greater part of the administration of the revenue and land affairs and magisterial work. The subordinate courts throughout India are almost entirely manned by native judges, who sit also on the bench in each of the High Courts. Similarly in the other services. There are four engineering colleges in India, which furnish to natives access to the higher grades of the public works department; and the provincial education services are recruited solely in India.

Though the total strength of the army in India has undergone little change, important reforms of organization have been effected in recent years which have greatly improved its efficiency. In 1805, after long discussion, the

#### The Army.

old presidency system was abolished and the whole army was placed under one commander-in-chief, though it was not till 1904 that the native regiments of cavalry and infantry were re-numbered consecutively, and the Hyderabad contingent and a few local battalions were incorporated with the rest of the army. About the same time (1903) the designation of British officers serving with native troops was changed from "Indian Staff Corps" to "Indian Army." The entire force, British and native, is now subdivided into a Northern and a Southern Army, with Burma as an independent command attached to the latter. Each of these armies is organized in divisions, nine in number, based on the principles that the troops in peace should be trained in units of command similar to those in which they would take the field, and that much larger powers should be entrusted to the divisional commanders. At the same time large sums of money have been expended on strategic works along the north-west frontier, supply and transport has been reorganized, rifle, gun and ammunition factories have been established, and a Staff College at Quetta.

In 1907-1908 the actual strength of the army in India numbered 227,714 officers and men, of whom 73,947 were British troops; and the total military expenditure amounted to £17,625,000, of which £2,906,000 was for non-effective charges. In addition, the reserve of the native army numbered 34,846 men, the volunteers 34,962, the frontier militia (including the Khyber Rifles) about 6000, the levies (chiefly in Baluchistan) about 6000, and the military police (chiefly in Burma) about 22,000. These figures do not include the Imperial Service troops, consisting of cavalry, infantry and transport corps, about 18,000 in all, which are paid and officered by the native states furnishing them, though supervised by British inspectors. The military forces otherwise maintained by the several native states are estimated to number about 100,000 men, of varying degrees of efficiency.

The police, it is admitted, still form an unsatisfactory part of the administration, though important reforms have recently been introduced. The present system, which is modelled somewhat on that of the Irish constabulary, dates from shortly after the Mutiny, and is regulated for the greater part of the country by an act passed in 1861. It provides a regular force in each district, under a superintendent who is almost always a European, subordinate for general purposes to the district magistrate. For the preservation of order this force is by no means inefficient, but it fails as a detective agency and also in the prosecution of crime, being distrusted by the

people generally. As the result of a Commission appointed in 1902, a considerable addition has been made to the expenditure on police, which is being devoted to increasing the pay of all the lower grades and to augmenting the number of investigating officers. In 1901 the total strength of the civil police force was about 145,000 men, maintained at a total cost of about £2,200,000. In addition, the village watchmen or *chaskidars*, a primitive institution paid from local sources but to some extent incorporated in the general system, aggregated about 700,000; while a special force of military police, numbering about 20,000 under officers seconded from the army, is maintained along the frontier, more especially in Burma.

The administration of gaols in India can be described more favourably. As a rule, there is one gaol in each district, under the management of the civil surgeon. Discipline is well maintained, though separate confinement is practically unknown; and various industries (especially carpet-weaving) are profitably pursued wherever possible. So much attention has been directed to diet and sanitation that the death-rate compares well with that of the general working population: in 1907 it was as low as 18 per 1000. Convicts with more than six years to serve are transported to the Andaman Islands, where the penal settlement is organized on an elaborate system, permitting ultimately self-support on a ticket of leave and even marriage. In 1907 the daily average gaol population in India was 87,306, while the convicts in the Andamans numbered 14,235.

Local self-government, municipal and rural, in the form in which it now prevails in India, is essentially a product of British rule. Village communities and trade guilds in towns existed previously, but these were only rudimentary forms of self-government. The beginnings of municipal government occurred in the Presidency towns. Apart from these the act of 1850 respecting improvements in towns initiated consultative committees. In 1870 Lord Mayo delegated to local committees the control over these improvement funds. But the system at present in force is based upon legislation by Lord Ripon in 1882, providing for the establishment of municipal committees and local boards, whose members should be chosen by election with a preponderance of non-official members. The large towns of Calcutta, Bombay and Madras have municipalities of this character, and there are large numbers of municipal committees and local boards all over the country. There are also Port Trusts in the great maritime cities of Calcutta, Bombay, Madras, Karachi and Rangoon.

As the land furnishes the main source of Indian revenue, so the assessment of the land tax is the main work of Indian administration. No technical term is more familiar to Anglo-Indians, and none more strange to the English public, than that of land settlement. No subject has given rise to more voluminous controversy.

It will be enough in this place to explain the general principles upon which the system is based, and to indicate the chief differences of application in the several provinces. That the state should appropriate to itself a direct share in the produce of the soil is a fundamental maxim of Indian finance that has been recognized throughout the East from time immemorial. The germs of rival systems can be traced in the old military and other service tenures of Assam, and in the poll tax of Burma, &c. The exclusive development of the land system is due to two conditions,—a comparatively high state of agriculture and an organized plan of administration,—both of which are supplied by the primitive village community. During the lapse of untold generations, despite domestic anarchy and foreign conquest, the Hindu village has in many parts preserved its simple customs, written in the imperishable tablets of tradition. The land was not held by private owners but by occupiers under the petty corporation; the revenue was not due from individuals, but from the community represented by its head-man. The aggregate harvest of the village fields was thrown into a common fund, and before the general distribution the head-man was bound to set aside the share of the state. No other system of taxation could be theoretically more just, or in practice less obnoxious to the people. Such is an outline of the land system as it may be found at the present day throughout large portions of India both under British and native rule; and such we may

Gaols.

Municipalities.

Land Settlement.



fancy it to have been universally before the Mahomedan conquest. The Mussulmans brought with them the avarice of conquerors, and a stringent system of revenue collection. Under the Mogul empire, as organized by Akbar the Great, the share of the state was fixed at one-third of the gross produce of the soil; and a regular army of tax-collectors was permitted to intervene between the cultivator and the supreme government. The entire vocabulary of the present land system is borrowed from the Mogul administration. The zamindar himself is a creation of the Mahomedans, unknown to the early Hindu system. He was originally a mere tax-collector, or farmer of the land revenue, who agreed to furnish a lump sum from the tract of country assigned to him. If the Hindu village system may be praised for its justice, the Mogul farming system had at least the merit of efficiency. Shah Jahan and Aurangzeb extracted a larger land revenue than the British do. When the government was first undertaken by the East India Company, no attempt was made to understand the social system upon which the land revenue was based. The zamindar was conspicuous and useful; the village community and the cultivating ryot did not force themselves into notice. The zamindar seemed a solvent person, capable of keeping a contract; and his official position as tax-collector was confused with the proprietary rights of an English landlord. The superior stability of the village system was overlooked, and in the old provinces of Bengal and Madras the village organization has gradually been suffered to fall into decay. The consistent aim of the British authorities has been to establish private property in the soil, so far as is consistent with the punctual payment of the revenue. The annual government demand, like the succession duty in England, is universally the first liability on the land; when that is satisfied, the registered landholder has powers of sale or mortgage scarcely more restricted than those of a tenant in fee-simple. At the same time the possible hardships, as regards the cultivator, of this absolute right of property vested in the owner have been anticipated by the recognition of occupancy rights or fixity of tenure, under certain conditions. Legal rights are everywhere taking the place of unwritten customs. Land, which was before merely a source of livelihood to the cultivator and of revenue to the state, has now become the subject of commercial speculation. The fixing of the revenue demand has conferred upon the owner a credit which he never before possessed, by allowing him a certain share of the unearned increment. This credit he may use improvidently, but none the less has the land system of India been raised from a lower to a higher stage of civilization.

The means by which the land revenue is assessed is known as settlement, and the assessor is styled a settlement officer. In Bengal the assessment has been accomplished once and for all, but throughout the greater part of the rest of India the process is continually going on. The details vary in the different provinces; but, broadly speaking, a settlement may be described as the ascertainment of the agricultural capacity of the land. Prior to the settlement is the work of survey, which first determines the area of every village and frequently of every field also. Then comes the settlement officer, whose duty it is to estimate the character of the soil, the kind of crop, the opportunities for irrigation, the means of communication and their probable development in the future, and all other circumstances which tend to affect the value of the produce. With these facts before him, he proceeds to assess the government demand upon the land according to certain general principles, which may vary in the several provinces. The final result is a settlement report, which records, as in a Domesday Book, the entire mass of agricultural statistics concerning the district.

Lower Bengal and a few adjoining districts of the United Provinces and of Madras have a permanent settlement, i.e. the land revenue has been fixed in perpetuity. When the Company obtained the *diwani* or financial administration of Bengal in 1765, the theory of a settlement, as described above, was unknown. The existing Mahomedan system was adopted in its entirety. Engagements, sometimes yearly, sometimes for a term of years, were entered into with the zamindars to pay a lump sum for the area over which they exercised control.

If the offer of the zamindar was not deemed satisfactory, another contractor was substituted in his place. But no steps were

taken, and perhaps no steps were possible, to ascertain in detail the amount which the country could afford to pay. For more than twenty years these temporary engagements continued, and received the sanction of Warren Hastings, the first titular governor-general of India. Hasting's great rival, Francis, was among those who urged the superior advantages of a permanent assessment. At last, in 1789, a more accurate investigation into the agricultural resources of Bengal was commenced, and the settlement based upon this investigation was declared perpetual by Lord Cornwallis in 1793. The zamindars of that time were raised to the status of landlords, with rights of transfer and inheritance, subject always to the payment in perpetuity of a rent-charge. In default of due payment, their lands were liable to be sold to the highest bidder. The aggregate assessment was fixed at *sikká* Rs. 26,800,989, equivalent to Co.'s Rs. 28,587,722, or say 2½ millions sterling. While the claim of Government against the zamindars was thus fixed for ever, it was intended that the rights of the zamindars over their own tenants should be equally restricted. But no detailed record of tenant-right was inserted in the settlement papers, and, as a matter of fact, the cultivators lost rather than gained in security of tenure. The same English prejudice which made a landlord of the zamindar could recognize nothing but a tenant-at-will in the ryot. By two stringent regulations of 1799 and 1812 the tenant was practically put at the mercy of a rack-renting landlord. If he failed to pay his rent, however excessive, his property was rendered liable to distraint and his person to imprisonment. At the same time the operation of the revenue sale law had introduced a new race of zamindars, who were bound to their tenants by no traditions of hereditary sympathy, but whose sole object was to make a profit out of their newly purchased property. The rack-rented peasantry found no protection in the law courts until 1859, when an act was passed which restricted the landlord's powers of enhancement in certain specified cases. Later the Bengal Tenancy Act of 1885, since amended by an act of 1898, created various classes of privileged tenants, including one class known as "settled ryots," in which the qualifying condition is holding land, not necessarily the same land, for twelve years continuously in one village. Outside the privileged classes of tenants the act gives valuable protection to tenants-at-will. The progress in the acquisition of occupancy rights by tenants may be judged from the fact that, whereas in 1877 it was stated of the Champaran district that the cultivator had hardly acquired any permanent interest in the soil, the settlement officer in 1900 reported that 87% of the occupied area was in the possession of tenants with occupancy rights or holding at fixed rates. It is believed that the ryots will eventually be able to secure, and to hold against all comers, the strong legal position which the Bengal Tenancy Act has given them.

The permanent settlement was confined to the three provinces of Bengal, Behar and Orissa, according to their boundaries at that time. Orissa proper, which was conquered from the Maharrattas in 1803, is subject to a temporary settlement, which expired in 1897 and a re-settlement was made in 1900. The enhancement in the revenue amounted to 52% of the previous demand; but in estates in which the increase was specially large it was decided to introduce the new rates gradually.

The prevailing system throughout the Madras presidency is the ryotwari, which takes the cultivator or peasant proprietor as its rent-paying unit, somewhat as the Bengal system takes the zamindar. This system cannot be called indigenous to the country, any more than the zamindari of Bengal. If any system deserves that name, it is that of village assessment, which still lingers in the memories of the people in the south. When the British declared themselves heir to the nawab of the Carnatic at the opening of the 19th century, they had no adequate experience of revenue management. The authorities in England favoured the zamindari system already at work in Bengal, which appeared at least calculated to secure punctual payment. The Madras Government was accordingly instructed to enter into permanent engagements with zamindars, and, where no zamindars could be

**Ryotwari system.**

found, to create substitutes out of enterprising contractors. The attempt resulted in failure in every case, except where the zamindars happened to be the representatives of ancient lines of powerful chiefs. Several of such chiefs exist in the extreme south and in the north of the presidency. Their estates have been guaranteed to them on payment of a *peskash* or permanent tribute, and are saved by the custom of primogeniture from the usual fate of subdivision. Throughout the rest of Madras there are no zamindars either in name or fact. The influence of Sir Thomas Munro afterwards led to the adoption of the ryotwari system, which will always be associated with his name. According to this system, an assessment is made with the cultivating proprietor upon the land taken up for cultivation year by year. Neither zamindar nor village officer intervenes between the cultivator and the state, which takes directly upon its own shoulders all a landlord's responsibility. The early ryotwari settlements in Madras were based upon insufficient experience. They were preceded by no survey, but adopted the crude estimates of native officials. Since 1858 a department of revenue survey has been organized, and the old assessments have been everywhere revised.

Nothing can be more complete in theory and more difficult of execution than a Madras ryotwari settlement. First, the entire area of the district, whether cultivated or uncultivated, and of each field within the district is accurately measured. The next step is to calculate the estimated produce of each field, having regard to every kind of both natural and artificial advantage. Lastly, a rate is fixed upon every field, which may be regarded as roughly equal to one-third of the gross and one-half of the net produce. The elaborate nature of these inquiries and calculations may be inferred from the fact that as many as thirty-five different rates are sometimes struck for a single district, ranging from 6d. to £1, 4s. per acre. The rates thus ascertained are fixed for a term of thirty years; but during that period the aggregate rent-roll of a district is liable to be affected by several considerations. New land may be taken up for cultivation, or old land may be abandoned; and occasional re-assessments are permitted under no less than eighteen specified heads. Such matters are discussed and decided by the collector at the *jambandars* or court held every year for definitely ascertaining the amount of revenue to be paid by each ryot for the current season. This annual inquiry has sometimes been mistaken by careless passers-by for an annual reassessment of each ryot's holding. It is not, however, a change in the rates for the land which he already holds, but an inquiry into and record of the changes in his former holding or of any new land which he may wish to take up.

In the early days of British rule no system whatever prevailed throughout the Bombay presidency; and even at the present time there are tracts where something of the old confusion survives. The modern "survey tenure," as it is called, dates from 1838, when it was first introduced into one of the *talukas* of Poona district, and it has since been gradually extended over the greater part of the presidency. As its name implies, the settlement is preceded by survey. Each field is measured, and an assessment placed upon it according to the quality of the soil without any attempt to fix the actual average produce. This assessment holds good, without any possibility of modification, for a term of thirty years. The Famine Commission of 1901 suggested the following measures with a view to improving the position of the Bombay ryot: (1) A tenancy law to protect expropriated ryots, (2) a bankruptcy law, (3) the limitation of the right of transfer, in the interests of ryots who are still in possession of their land.

In the other provinces variations of the zamindari and ryotwari systems are found. In the United Provinces and the Punjab the ascertainment of the actual rents paid is the necessary preliminary to the land revenue demand. In the Central Provinces, where the landlords (*malguzars*) derive their title from the revenue settlements made under British rule, the rents are actually fixed by the settlement officer for varying periods. In addition nearly every province has its own laws regulating the subject of tenancy; the tenancy laws of the United Provinces and of the Central Provinces were revised and amended during the decade 1891-1901.

The principles of the land revenue settlement and administration were reviewed by the government of India in a resolution

presented to parliament in 1902, in which its policy is summarised as follows:—

"In the review of their land revenue policy which has now been brought to a close, the Government of India claim to have established the following propositions, which, for convenience' sake, it may be desirable to summarize before concluding this Resolution:—

**Land Tenure and Settlements.**

- (1) That a Permanent Settlement, whether in Bengal or elsewhere, is no protection against the incidence and consequences of famine.
- (2) That in areas where the State receives its land revenue from landlords, progressive moderation is the key-note of the policy of Government, and that the standard of 50% of the assets is one which is almost uniformly observed in practice, and is more often departed from on the side of deficiency than of excess.
- (3) That in the same areas the State has not objected, and does not hesitate, to interfere by legislation to protect the interests of the tenants against oppression at the hands of the landlord.
- (4) That in areas where the State takes the land revenue from the cultivators, the proposal to fix the assessment at one-fifth of the gross produce would result in the imposition of a greatly increased burden upon the people.
- (5) That the policy of long term settlements is gradually being extended, the exceptions being justified by conditions of local development.
- (6) That a simplification and cheapening of the proceedings connected with new settlements and an avoidance of the harassing invasion of an army of subordinate officials, are a part of the deliberate policy of Government.
- (7) That the principle of exempting or allowing for improvements is one of general acceptance, but may be capable of further extension.
- (8) That assessments have ceased to be made upon prospective assets.
- (9) That local taxation as a whole, though susceptible of some redistribution, is neither immoderate nor burdensome.
- (10) That over-assessment is not, as alleged, a general or widespread source of poverty and indebtedness in India, and that it cannot fairly be regarded as a contributory cause of famine.

The Government of India have further laid down liberal principles for future guidance and will be prepared, where the necessity is established, to make further advance in respect of:—

- (11) The progressive and graduated imposition of large enhancements.
- (12) Greater elasticity in the revenue collection, facilitating its adjustment to the variations of the seasons, and the circumstances of the people.
- (13) A more general resort to reduction of assessments in cases of local deterioration, where such reduction cannot be claimed under the terms of settlement."

In 1900-1901 the total land revenue realized from territory under British administration in India amounted to £17,325,000, the rate per cultivated acre varying from 3s. 1d. in Madras to 10d. in the Central Provinces. The general conclusion of the Famine Commission of 1901 was that "except in Bombay, where it is full, the incidence of land revenue is low to moderate in ordinary years, and it should in no way *per se* be the cause of indebtedness."

Prior to the successive reductions of the salt duty in 1903, 1905 and 1907, next to land, salt contributed the largest share to the Indian revenue; and, where salt is locally manufactured, its supervision becomes an important part of administrative duty. Up to within quite recent times the tax levied upon salt varied extremely in different parts of the country, and a strong preventive staff was required to be stationed along a continuous barrier hedge, which almost cut the peninsula into two fiscal sections. The reform of Sir J. Stacey in 1878, by which the higher rates were reduced and the lower rates raised, with a view to their ultimate equalization over the whole country, effectually abolished this old engine of oppression. Communication is now free; and it has been found that prices are absolutely lowered by thus bringing the consumer nearer to his market, even though the rate of taxation be increased. Broadly speaking the salt consumed in India is derived from four sources: (1) importation by sea, chiefly from England and the Red Sea and Aden; (2) solar evaporation in shallow tanks along the seaboard; (3) the salt lakes in Rajputana; (4) quarrying in the salt hills of the northern Punjab. The salt lakes in Rajputana have been leased by the government of India from the rulers of the native states in which they lie, and the huge salt deposits of the Salt Range

**Salt Administration.**

**The other Provinces.**

mines are worked under government control, as also are the brine works on the Runn of Cutch. At the Kohat mines, and in the salt evaporation works on the sea-coast, with the exception of a few of the Madras factories, the government does not come between the manufacturer and the merchant, except in so far as is necessary in order to levy the duty from the salt as it issues from the factory. The salt administration is in the hands of (1) the Northern India Salt Department, which is directly under the government of India, and controls the salt resources of Rajputana and the Punjab, and (2) the salt revenue authorities of Madras and Bombay.

The consumption of salt per head in India varies from 7 lb in Rajputana to 16·02 lb in Madras. The salt duty, which stood in 1888 at Rs. 2½ per maund, was reduced in 1903 to Rs. 2, in 1905 to Rs. 1½ and in 1907 to R. 1 per maund, the rate being uniform all over India. In 1907-1908 the gross yield of the salt duty was £3,339,000, of which more than one-fourth was derived from imported salt.

The heading *Opium* in the finance accounts represents the duty on the export of the drug. The duty on local consumption, which is included under excise, yielded 498,100 in 1907-1908. The opium revenue proper is derived from two sources: (1) a monopoly of production in the valley of the Ganges, and (2) a transit duty levied on opium grown in the native states of western India, known as Malwa opium. Throughout British territory the growth of the poppy is almost universally prohibited, except in a certain tract of Bengal and the United Provinces, where it is grown with the help of advances from government and under strict supervision. The opium, known as "provision opium," is manufactured in government factories at Patna and Ghazipur, and sold by auction at Calcutta for export to China. The net opium revenue represents the difference between the sum realized at these sales and the cost of production. Malwa opium is exported from Bombay, the duty having previously been levied on its passage into British territory. In 1907-1908 the net opium revenue from both sources amounted to £3,576,000. The Chinese government having issued an edict that the growth and consumption of opium in China should be entirely suppressed within ten years, the government of India accordingly agreed in 1908 that the export of opium from India should be reduced year by year, so that the opium revenue would henceforth rapidly decline and might be expected to cease altogether. In 1908 an international commission that met at Shanghai passed resolutions inviting all the states there represented to take measures for the gradual suppression of the manufacture, sale and distribution of opium, except for medicinal purposes.

*Excise.*—Excise, like salt, is not only a department of revenue collection, but also to a great extent a branch of the executive. In other words, excise duties in India are not a mere tax upon the consumer, levied for convenience through the manufacturer and retail dealer, but a species of government monopoly. The only excisable articles are intoxicants and drugs; and the avowed object of the state is to check consumption not less than to raise revenue. The limit of taxation and restriction is the point at which too great encouragement is given to smuggling. Details vary in the different provinces, but the general plan of administration is the same. The right to manufacture and the right to retail are both monopolies of government permitted to private individuals only upon terms. Distillation of country spirits is allowed according to two systems—either to the highest bidder under strict supervision, or only upon certain spots set apart for the purpose. The latter is known as the *sadr* or central distillery system. The right of sale is also usually farmed out to the highest bidder, subject to regulations fixing the minimum quantity of liquor that may be sold at one time. The brewing of beer from rice and other grains, which is universal among the hill tribes and other aboriginal races, is practically untaxed and unrestrained. The European breweries at several hill stations pay the same tax as imported beer. Apart from spirits, excise duties are levied upon the sale of a number of intoxicating or stimulant drugs, of which the most important are opium, bhang, ganja and charas. Opium is issued for local consumption in India from the government manufactories at Ghazipur and Patna in the Behar and Benares Agencies, and sold through private retailers at a monopoly price. Bhang, ganja and charas are three different narcotic drugs prepared from the hemp plant (*Cannabis sativa*, var. *indica*). Scientifically speaking, bhang consists of the dried leaves and small stalks, with a few fruits; ganja of the flowering and fruiting heads of

the female plant; while charas is the resin itself, collected in various ways as it naturally exudes. The plant grows wild in many parts of India; but the cultivation of it for ganja is practically confined to a limited area in the Rajshahi district of eastern Bengal, and charas is mainly imported from Central Asia. The use of bhang in moderation is comparatively harmless; ganja and charas when taken in excess are undoubtedly injurious, leading to crime and sometimes to insanity. In accordance with the recommendations of the Hemp Drugs Commission, the government of India passed an act in 1896 providing that, in regard to ganja and charas, cultivation of the plants should be restricted as much as possible, and that a direct quantitative duty should be levied on the drugs on issue from the warehouse in the province of consumption; while as regards bhang, cultivation of the hemp for its production should be prohibited or taxed, and collection of the drug from wild plants permitted only under licence, a moderate quantitative duty being levied in addition to vend fees. No duty whatever is now levied upon tobacco in any part of India. The plant is universally grown by the cultivators for their own smoking, and, like everything else, was subject to taxation under native rule; but the impossibility of accurate excise supervision has caused the British government to abandon the impost. In 1907-1908 the total gross revenue from excise amounted to £6,214,000, of which more than two-thirds was derived from spirits and toddy.

Since 1894 a uniform customs duty of 5% *ad valorem* has been levied generally on imported goods, certain classes being placed on the free list, of which the most important are food-grains, machinery, railway material, coal, and cotton twist and yarn (exempted in 1896). Most classes of iron and steel are admitted at the lower rate of 1%. Cotton goods are taxed at 3½%, whether imported or woven in Indian mills. Special duties are imposed on liquors, arms and ammunition and petroleum, while imported salt pays the same duty as salt manufactured locally. From 1899 to 1904 a counter-vailing duty was imposed on bounty-fed beet sugar. There is also a customs duty at the rate of about 3d. per 82 lb on exported rice. In 1907-1908 the total customs revenue amounted to £4,910,000, of which £664,000 was derived from the export duty on rice and £223,730 from the excise on cotton manufactures.

Since 1886 an assessed tax has been levied on all sources of income except that derived from land. The rate is a little more than 2½% on all incomes exceeding £133 a year, and a little more than 2% on incomes exceeding £66, the minimum income liable to assessment having been raised in 1903 from £33. The total number of persons assessed is only about 260,000. In 1907-1908 the gross receipts from income tax amounted to £1,100,000.

Other sources of revenue are stamps, levied on judicial proceedings and commercial documents; registration of mortgages and other instruments; and provincial rates, chiefly in Bengal and the United Provinces for public works or rural police. The rates levied at a certain percentage of the land revenue for local purposes are now excluded from the finance accounts. In 1907-1908 the gross receipts amounted to: from stamps, £4,259,000, of which more than two-thirds was derived from the sale of court fee stamps; from registration, £415,000; and from provincial rates, £526,000.

#### Commerce and Industries.

India may almost be said to be a country of a single industry, that industry being agriculture. According to the census of 1901 two-thirds of the total population were employed in occupations connected with the land, while not one-tenth of that proportion were supported by any other single industry. The prosperity of agriculture therefore is of overwhelming importance to the people of India, and all other industries are only subsidiary to this main occupation. This excessive dependence upon a single industry, which is in its turn dependent upon the accident of the seasons, upon a favourable or unfavourable monsoon, has been held to be one of the main causes of the frequent famines which ravage India.

*Agriculture.*—The cultivation of the soil is the occupation of the Indian people in a sense which is difficult to realize in England, and which cannot be adequately expressed by figures. As the land tax forms the mainstay of the imperial revenue, so the ryot or cultivator constitutes the unit of the social system. The organized village community contains many other members besides the cultivators; but they all exist for his benefit, and all alike are directly maintained from the produce of the village fields. Even in considerable towns, the traders and handicraftsmen almost always possess plots of land of their own, on which they raise sufficient grain to supply their families with food. The operations of rural life are familiar to every class. They are enveloped in a cloud of religious sanctions, and serve to mark out by their recurring periods the annual round of common life.

But though agriculture thus forms the staple industry of the country, its practice is pursued in different provinces with infinite variety of detail. Everywhere the same perpetual assiduity is found, but the inherited experience of generations has taught the cultivators

to adapt their simple methods to differing circumstances. For irrigation, native patience and ingenuity have devised means which compare not unfavourably with the colossal projects of government. Manure is copiously applied to the more valuable crops whenever manure is available, its use being limited by poverty and not by ignorance. The rotation of crops is not adopted as a principle of husbandry; but it is well known that the production of the exhausting crops cannot be taken in consecutive seasons from the same field, and the advantage of fallows is widely recognized. The periodicity of the seasons usually allows two, and sometimes three, harvests in the year, but not necessarily, nor indeed usually, from the same fields. For inexhaustible fertility, and for retentiveness of moisture in a dry year, no soil in the world can surpass the "black cotton-soil" of the Deccan. In the broad river basins the inundations deposit annually a fresh top-dressing of silt, thus superseding the necessity of manures.

**Wheat.**—Within recent years wheat has become one of the most important crops in India, more especially for export. The canal colonies of the Punjab have turned northern India into one of the great grain-fields of the British empire; and in 1904 India took the first place in supplying wheat to the United Kingdom, sending nearly 25½ million cwt. out of a total of 97½ millions. In 1905, however, it fell back again into the third place, being passed by Russia and Argentina. Wheat is grown chiefly in the Punjab, the United Provinces, and the Central Provinces. In 1905-1906 there were 23 million acres under wheat of the whole of India, of which 8½ million were in the Punjab alone.

**Rice.**—The name of rice has from time immemorial been so closely associated with Indian agriculture that it is difficult to realize how comparatively small an area is planted with this crop. With the exception of the deltas of the great rivers and the long strip of land fringing the western coast, rice may be called an occasional crop throughout the remainder of the peninsula. But where it is grown it is grown to the exclusion of all other crops. The rice crop is most important in Burma, Bengal and Madras, and there is an average of 20 million acres under rice in the other provinces of British India. In Bengal the area varies from 36 to 40 million acres according to the season. In Burma, where the large waste area is being gradually brought under cultivation, there has been an almost uninterrupted increase in the area of the rice crop, and the rice export is one of the main industries of the province. In ordinary years most of this rice goes either to Europe or to the Farther East; but in famine seasons a large part is diverted to peninsular India, and Burma is sometimes imported with rice from the other provinces of British India as well as supplemented. In 1905-1906 the export of rice from India was valued at 12½ millions sterling.

**Millets.**—Taking India as a whole, the staple food grain is neither rice nor wheat, but millets, which are probably the most prolific grain in the world, and the best adapted to the vicissitudes of a tropical climate. Excluding the special rice-growing tracts, different kinds of millet are grown more extensively than any other crop from Madras in the south at least as far as Rajputana in the north. The *sorghum* or great millet, generally known as *jowar* or *chobani*, is the principal millet grown in the outside sources from which the deficient crops are supplemented. In 1905-1906 the export of rice from India was valued at 12½ millions sterling. The spiked millet, known as *bajra* or *cumbu*, which yields a poorer food, is grown on dry sandy soil in the Deccan and the Punjab. A third sort of millet, *ragi* or *marua*, is cultivated chiefly in Madras and Bengal. There are also other kinds, which are included as a rule under the general head of "other food grains." Millet crops are grown for the most part on unirrigated land. In the Bombay Deccan districts they cover generally upwards of 60% of the grain area, or an even larger proportion in years of drought. In Gujarat about half the grain area under millet is maize, and in certain years the grain is consumed almost entirely in India, though a small amount is exported.

**Pulses.**—Among pulses gram covers in ordinary years more than to millions of acres, chiefly in the United Provinces, the Punjab and Bengal. Gram is largely eaten by the poorer classes, but it is also used as horse-food. Other pulses, lentils, &c., are extensively grown, but the area under these crops is liable to great contraction in years of drought, as it consists for the most part of unirrigated lands.

**Oil-seeds.**—Oil-seeds also form an important crop in all parts of the country, being perhaps more universally grown than any other, as oil is necessary, according to native custom, for application to the person, for food, and for burning in lamps. In recent years the cultivation of oil-seeds has received an extraordinary stimulus owing to the demand for export to Europe, especially to France; but as they can be grown after rice, &c., as a second crop, this increase has hardly at all tended to diminish the production of food grains. The four chief varieties grown are mustard or rapé seed, linseed, *til* or gingelly (sesamum), and castor-oil. Bengal and the United Provinces are at present the chief sources of supply for the foreign demand, but gingelly is largely exported from Madras, and, to a smaller extent, from Burma. These seeds are for the most part pressed in India either in bullock presses or in oil-mills. The refuse or cake is of great value to agriculturists, as it forms a food for cattle, and in the case of sesamum it is eaten by the people. But a very large quantity of the seeds is exported. The total value of oils and oil-seeds exported in 1905-1906 was over 7½ millions sterling.

**Vegetables.**—Vegetables are everywhere cultivated in garden plots

for household use, and also on a larger scale in the neighbourhood of great towns.—Among favourite native vegetables, the following may be mentioned:—the egg-plum, called *brinjal* or *baigan* (*Solanum Melongena*), potatoes, cabbages, cauliflower, radishes, onions, garlic, turnips, yams, and a great variety of cucurbitaceous plants, including *Cucumis sativus*, *Cucurbita maxima*, *Lagenaria vulgaris*, *Trichosanthes dioica*, and *Sesimoria triflora*. Of the potatoes, cabbages, and turnips are of comparatively recent introduction. Almost all English vegetables can be raised by a careful gardener. Potatoes thrive best on the higher elevations, such as the Khasi hills, the Nilgiris, the Mysore uplands, the Shan States, and the slopes of the Himalayas; but they are also grown even in lowland districts.

**Fruits.**—Among cultivated fruits are the following:—Mango (*Mangifera indica*), plantain (*Musa paradisiaca*), pine-apple (*Ananas sativa*), pomegranate (*Punica Granatum*), guava (*Psidium pomiferum*), and *P. pyrifera*, (Tamarind, *Tamarindus indica*), jack (*Artocarpus integrifolia*), custard-apple (*Annona squamosa*), papaw (*Carica Papaya*), shaddock (*Citrus decumana*), and several varieties of fig, melon, orange, lime and citron. According to the verdict of Europeans, no native fruits can compare with those of England. But the mangoes of Bombay, of Multan, and of Malda in Bengal, and the oranges of Nagpur and the Khasi hills, enjoy a high reputation; while the guavas of Madras are made into an excellent preserve.

**Spices.**—Among spices, for the preparation of curry and other hot dishes, turmeric and chillies hold the first place, being very generally cultivated in the most extensive comparative quantities. Anniseed, black cummin, and fenugreek. Pepper proper is confined to the Malabar coast, from Kanara to Travancore. Cardamoms are a valuable crop in the same locality, and also in the Nepalese Himalayas. *Pan* or betel-leaf is grown by a special caste in most parts of the country. Its cultivation requires constant care, but is highly remunerative. The betel-nut or areca palm is chiefly grown in certain favoured localities, such as the deltaic districts of Bengal and the highlands of southern India.

**Palms.**—Besides betel (*Areca Catechu*), the palms of India include the coco-nut (*Cocos nucifera*), the bastard date (*Phoenix sylvestris*), the palmyra (*Borassus flabellifer*), and the true date (*Phoenix dactylifera*). The coco-nut, which loves a sandy soil and a moist climate, is found in greatest perfection along the strip of coast-line that fringes the west of the peninsula, where it ranks next to rice as the staple product. The bastard date, grown chiefly in the country round Calcutta and in the north-east of the Madras presidency, supplies both the jaggery sugar of commerce and intoxicating liquors for local consumption. Spirit is also distilled from the palmyra, especially in the neighbourhood of Bombay and in the south-east of Madras. The true date is almost confined to Sind.

**Sugar.**—Sugar is manufactured both from the sugar-cane and from the bastard date-palm, but the total production is inadequate to the local demand. The best cane is grown in the United Provinces, on irrigated land. It is an expensive crop, requiring much attention, and not yielding a return within the year; but the profits are proportionately large. The normal area under sugar-cane in India is generally about 3 million acres, chiefly in the United Provinces, Bengal, and the Punjab. A large share of the produce is consumed in the form of *gur* or unrefined sugar, and the market for this preparation is independent of foreign competition. The total import of sugar in 1905-1906 was valued at £5,182,000, chiefly from Java and Mauritius.

**Indigo.**—Owing to the manufacture of synthetic indigo by German chemists the export trade in indigo, which was formerly the most important business carried on by European capital in India, has been almost entirely ruined. In the early years of the 19th century the over-ventures of English planters in many districts of Bengal, and it was calculated that the planters of North Behar alone had a turnover of a million sterling. The industry suffered depression owing to the indigo riots of 1860 and the emancipation of the peasantry by the Land Act of 1859; but in the closing decade of the century it received a much more disastrous blow from the invention of the German chemists. In 1895-1896 the area under indigo was 1,570,000 acres, and the value of the exports £3,569,700, while in 1905-1906 the area had sunk to 383,000 acres, and the value of the exports to £390,879. The only hope of rescuing the industry from total disappearance lies in the fact that the natural indigo gives a faster dye than the manufactured product, while an effort has also been made to introduce the Java-Natal seed into India, which gives a much heavier yield, and so may be better able to compete in price with synthetic indigo.

**Tea.**—The cultivation of tea in India began within the memory of men still living, and now has replaced indigo as the chief article for European capital, more particularly in Assam. Unlike coffee-planting, which is a monopoly, tea is open to all, and has never attracted the attention of the natives. Early travellers reported that the tea-plant was indigenous to the southern valleys of the Himalayas; but they were mistaken in the identity of the shrub, which was the *Ostrya nepalensis*. The real tea (*Thea viridis*), a plant akin to the camellia, grows wild in Assam, being commonly found throughout the hilly tract between the valleys of the Brahmaputra and the Barak. There it sometimes attains the dimensions of a large tree; and from that, as well as from other indications, it has been plausibly inferred that Assam is the original home of the plant,

which was thence introduced at a prehistoric date into China. The real progress of tea-planting in Assam dates from about 1851, and was greatly assisted by the promulgation of the Waste-land Rules of 1854. By 1859 there were already fifty-one gardens in existence, owned by private individuals; and the enterprise had extended from its original headquarters in Lakhimpur and Sibsagar as far down the Brahmaputra as Kamrup. In 1856 the tea-plant was discovered wild in the hills in the Barak valley, and European capital was at once directed to that quarter. At about the same time tea-planting was introduced into the neighbourhood of the sanatorium of Darjeeling, among the Sikkim Himalayas. The success of these undertakings engendered a wild spirit of speculation in tea companies both in India and at home, which reached its climax in 1865. The industry recovered but slowly from the effects of this disastrous crisis, and did not again reach a stable position until 1869. Since that date it has rapidly but steadily progressed, and has been ever opening new fields of enterprise. At the head of the Bay of Bengal in Chittagong district, side by side with coffee on the Nilgiri hills, on the forest-clad slopes of Kumaon and Kangra, amid the low-lying jungle of the Bhutan Dwarfs, and even in Arakan, the energetic pioneers of tea-planting have established their industry. Different degrees of success may have rewarded them, but in no case have they abandoned the struggle. The area under tea, of which nine-tenths lies in the new province of Eastern Bengal and Assam, expanded by 85% during the sixteen years from 1885 to 1901, while the production increased by 167%. This great rise in the supply, unaccompanied by an equal expansion of the market for Indian tea, involved the industry in great difficulties, to which it has been obliged to resort to various expedients, such as the raising of duties, and to necessary to restrict the area under tea as far as possible, and to reduce the quantity of leaf taken from the plant, thus at the same time improving the quality of the tea. The area under tea in 1885 was 283,925 acres and the yield 71,525,977 lb, while in 1905 the area had increased to 527,290 acres and the yield to 222,360,132 lb, while the export alone was 214,223,728 lb. As much as 92% of the export goes to the United Kingdom, where China tea has been gradually ousted by tea from India and Ceylon. The other chief countries that afford a market for Indian tea are Canada, Russia, Australia, Turkey in the Peninsula, and the United States. India's production is computed to average 81 million pounds, of which 54 millions are Indian and the remainder Chinese. There should therefore be considerable room for expansion in the home market. In 1905 there were 134 tea-planting companies registered in India, about 80% of the capital being held by shareholders in London.

**Coffee.**—The cultivation of coffee is confined to southern India, though attempts have been made to introduce the plant both into Lower Burma and into the Eastern Bengal district of Chittagong. The coffee tract may be roughly defined as a section of the landward slope of the Western Ghats, extending from the Arabian coast to Travancore in the extreme south. That tract includes almost the whole of Coorg, the districts of Kador and Hassan in Mysore, the Nilgiri hills, and the Wynaad. The cultivation has also extended to the Shevaroy hills in Salem district and to the Palni hills in Madurai.

Unlike tea, coffee was not introduced into India by European enterprise; and even to the present day its cultivation is largely followed by the natives. The Malabar coast has always enjoyed a direct commerce with Arabia, and at an early date gave many converts to Islam. One of these converts, Baba Budan by name, is said to have gone on his pilgrimage to Mecca, and to have brought back with him the coffee berry, which he planted on the hill range in Mysore still called after him. According to local tradition this happened more than two centuries ago. The shrubs thus sown lived on, but the cultivation did not spread until the beginning of the 19th century. The state of Mysore and the Baba Budan range also witnessed the first opening of a coffee-garden by an English planter about 1840. The success of this experiment led to the extension of coffee cultivation into the neighbouring tract of Manjarabad, also in Mysore, and into the Wynaad subdivision of the Madras district of Malabar. Up to 1840, the enterprise made slow progress; but since the latter date it has spread with great rapidity along the whole line of the Western Ghats, clearing away the primeval forest, and opening a new era of prosperity to the labouring classes. The export of coffee in 1905 was 360,000 cwt., being the highest for sixteen years. The over-supply of cheap Brazilian coffee in the consuming markets caused a heavy fall in prices at the beginning of the decade, the average price in London in 1901 being 47s. per cwt. compared with 101s. in 1894. The United Kingdom and France are the chief consumers. An agreement with France at the beginning of the same century secured an indulgence imported, and to obtain the benefits of the minimum tariff, thus protecting the coffee industry from taxation in French ports on a scale which would have seriously hampered the trade. There is practically no local market for coffee in India.

**Cinchona.**—The cultivation of cinchona was introduced into India in the year 1860 under the auspices of government, owing to the efforts of Sir Clements Markham, and a stock of plants was prepared and distributed to planters in the Nilgiris and in Coorg. At the same time governmental plantations were established in the Nilgiri hills and at Darjeeling, and the enterprise made slow progress for some time. A considerable amount of the bark from private plantations is bought by the government and treated at the government factories,

The sulphate of quinine and the cinchona febrifuge thus produced are issued for the most part to medical officers in the various provinces, to goals, and to the authorities of native states; but a large and increasing amount is disposed of in the form of 5-grain packets, costing a farthing each, through the medium of the post-offices. This system brings the drug easily within the reach of the people.

**Cattle.**—Throughout the whole of India, except in Sind and the western districts of the Punjab, horned cattle are the only beasts used for ploughing. The well-known humped species of cattle predominates everywhere, being divided into many varieties. Owing partly to unfavourable conditions of climate and soil, partly to the insufficiency of grazing ground, and partly to the want of selection in breeding, the general condition of the cattle is miserably poor. As cultivation advances, the area of waste land available for grazing steadily diminishes, and the prospects of the poor beasts are becoming worse rather than better. Their only hope lies in the introduction of fodder crops as a regular stage in the agricultural course. There are, however, some fine breeds in existence. In Mysore the *amrit* military, a breed said to have been introduced by Hyder Ali for military purposes, is still kept up by the state. In the Madras districts of Nellore and Kurnool the indigenous breed has been greatly improved under the stimulus of cattle shows and prizes founded by British officials. In the Central Provinces there is a peculiar breed of trotting bullocks which is in great demand for wheeled carriages. The large and handsome oxen of Gujarat in Bombay and of Hariana in the Punjab are excellently adapted for drawing heavy loads in a sandy soil. The fodder famines that accompanied the great famines of 1876-78 were more mortally felt in the arid districts of the south-east Punjab than elsewhere, and the arid plains of the south-east Punjab the renowned herds almost disappeared. In the affected districts of the Punjab the loss of cattle averaged from 17 to 45% of the whole. In Rajputana more than half of its thirteen or fourteen millions of stock is said to have perished in 1900 alone. In one state the loss amounted to 90%, and in four others to 70%. In Gujarat half of its 13 million cattle perished in spite of the utmost efforts to obtain fodder. The worst cattle are to be found always in the deltaic tracts, but there their place is to a large extent taken by buffaloes. These are more numerous than any other cattle, their character is maintained by crossing the cows with wild bulls, and their milk yields the best *ghee* or clarified butter. Along the valley of the Indus, and in the sandy desert which stretches into Rajputana, camels supersede cattle for agricultural operations. The breed of horses has generally deteriorated since the demand for military purposes has declined with the establishment of British supremacy. In Bengal Proper, and also in Madras, it may be broadly said that horses are not bred. But horses are still required for the Indian army, the native cavalry, and the police; and in order to maintain the supply of remounts a civil department was organized in 1873, and transferred in 1883 to the army remount department. Horse-breeding is carried on chiefly in the Punjab, the United Provinces, and Baluchistan, and government keep a number of stallions in the various provinces. Formerly Norfolk trotters held the first place in point of number, but their place has been taken in recent years by English thoroughbreds, Arabs, and especially Australians. For the supply of ordnance, baggage, and transport mules a large number of donkey stallions have been imported by the government annually from various European and other sources. But the supply of suitable animals is not good, by the government is large, so that the breeding of donkeys has been undertaken at the Hissar farm in the Punjab.

**Forests.**—The forests of India, both as a source of natural wealth and as a department of the administration, are beginning to receive their proper share of attention. Up to the middle of the 19th century the destruction of forests by timber-cutters, by charcoal-burners, and above all by shifting cultivation, was allowed to go on everywhere unchecked. The extension of cultivation was considered as the chief care of government, and no regard was paid to the improvident waste going on on all sides. But as the pressure of population upon the soil became more dense, and the construction of railways increased the demand for fuel, the question of forest conservation forced itself into notice. It was recognized that the inheritance of future generations was being recklessly sacrificed to satisfy the immoderate desire for profit. And at the same time the importance of forests as affecting the general meteorology of a country was being learned from bitter experience in Europe. On many grounds, therefore, it became necessary to preserve what remained of the forests in India, and to repair the mischief of previous neglect even at considerable expense. In 1844 and 1847 the subject was actively taken up by the government of Bombay and Madras. In 1864 Dr Brandis was appointed inspector-general of forests to the government of India, and in the following year an act of the legislature was passed (No. VII. of 1865). The regular training of candidates for the Forest Department in the schools of France and Germany dates from 1867. In the interval that has since elapsed, sound principles of forest administration have been gradually extended. Indiscriminate timber-cutting has been prohibited, the burning of the jungle by the hill tribes has been confined within bounds, large areas have been surveyed and demarcated, plantations have been laid out, and, especially in forest reserves, the most judiciously. Systematic conservation of the Indian forests received a great impetus from the passing of the Forest Law in 1878, which gave to the government

powers of dealing with private rights in the forests of which the chief proprietary right is vested in the state. The Famine Commission of 1878 urged the importance of forest conservancy as a safeguard to agriculture, pointing out that a supply of wood for fuel was necessary if cattle manure was to be used to any extent for the fields, and also that forest growth served to retain the moisture in the subsoil. They also advised the protection and extension of communal rights of pasture, and the planting of the higher slopes with forest, with a view to the possible increase of the water-supply. These recommendations embody the principle upon which the management of the state forests is based. In 1864 the government divided forests into four classes: forests the preservation of which is essential on climatic or physical grounds, forests which supply valuable timber for commercial purposes, minor forests, and pasture lands. In the first class the special purpose of the forests, such as the protection of the plains from devastation by torrents, must come before any smaller interests. The second class includes tracts of teak, *sal* or *deodar* timber and the like, where private or village rights of user are few. In these forests every reasonable facility is afforded to the people concerned for the most easy satisfaction of their needs, which are generally for small timber for building or fuel, fodder and grazing for their cattle, and edible products for themselves; and considerations of forest income are subordinated to those purposes. Restrictions necessary for the proper conservancy of the forests are, however, imposed, and the system of shifting cultivation, which denudes a large area of forest growth in order to place a small area under crops, is held to cost more to the community than it is worth, and is only permitted, under due regulation, where forest tribes depend on it for their subsistence. In the third place, there are minor forests, which produce inferior or smaller timber. These are managed mainly in the interests of the surrounding population, and supply grazing or fuel to them at moderate rates, higher charges being levied on consumers who are not inhabitants of the locality. The fourth class includes pastures and grazing grounds. In these even more than in the third class the interests of the local community stand first. The state forests, which are under the control of the forest department, amounted in 1901-1902 to about 217,500 sq. m., or more than one-fifth of the total area of British India, varying from 61% in Burma to 4% in the United Provinces.

**Timbers.**—A large part of the reserved forests, where the control of the forest department is most complete, consists of valuable timber, in which the first place is held by teak, found at its best in Burma, especially in the upper division, and on the south-west coast of India, in Kanara and Malabar. It is also the most prevalent and valuable product of the forests at the foot of the Ghats in Bombay, and along the Satpura and Vindhya ranges, as far as the middle of the Central Provinces. Here it meets the *sal*, which however is more especially found in the sub-Himalayan tracts of the United Provinces and Eastern Bengal and Assam. In the Himalayas themselves the *deodar* and other conifers form the bulk of the timber, while in the lower ranges, such as the Khasi in Assam, and those of Burma, the various pines are prominent. In the north-east of Assam and in the north of Upper Burma the *Ficus elastica*, a species of india-rubber tree, is found. The sandal-wood flourishes all along the southern portion of the Ghats, especially about Mysore and Coorg; and in the same regions, as well as in Upper India, the blackwood occurs. A valuable tree, known as the padouk, is at present restricted almost entirely to the Andaman Islands, with a scattering in Lower Burma. There are many other timber trees that are in general demand in different parts of India, but the above are the best known outside that country. There is also the universal bamboo, and in the north-western tracts the equally useful rattan. The annual timber yield of the Indian forest is about fifty millions of cubic feet, excluding what is used for local purposes. About half of this quantity comes from the forests of Burma, where large amounts of teak and other woods are annually extracted, chiefly through the agency of private firms. It is, however, only the more valuable of the woods, such as teak, sandal-wood, ebony and the like, which find a market abroad. The total value of the export trade in forest produce averages between 1½ and 2 millions annually.

#### Manufactures.

Manufacturing industries are being slowly developed in India, though their growth has not yet materially affected the pressure on the land. Next to agriculture, weaving is the most important industry in the country, the cotton-mills of Bombay and the jute mills of Bengal having increased greatly of recent years. On the other hand, the old indigenous industries of India decayed greatly during the latter part of the 19th century. The colonies of hand-workers in silk, cotton, carpets, brass and silver ware, wood and ivory, and other skilled craftsmen, which formerly existed in various parts of India, have fallen off both in the extent of their output and in the artistic excellence of their work. An attempt has been made to remedy the evil by means of schools of art, but with little result.

**Cotton.**—Cotton is the staple article of clothing in Eastern countries, and Indian cotton and other piece goods used to find a ready market in Europe before the English cotton manufacturer had arisen. When European adventurers found the way to India, cotton and silk always formed part of the rich cargoes that they brought home, and the early settlers were always careful to fix their abode amid a weaving population, at Surat, Calicut, Masulipatam or Hugli. But now the larger part of the cotton goods used in India is manufactured in mills in that country or in England, and the handloom weavers' output is confined to the coarsest cloth, or to certain special kinds of goods, such as the turbans and "saris" of Bombay, or the muslins of Arni, Cuddapah, and Madura in Madras, and of Dacca in Bengal. The extent to which village industries still survive is shown by the fact that according to the census of 1901 there were 5,800,000 handloom weavers in India against only 350,000 workers in cotton mills.

The present importance of the cotton crop dates only from the crisis in Lancashire caused by the American War. Prior to 1860 the exports of raw cotton from India used to average less than 3 millions sterling a year, mostly to China; but after that date they rose by leaps, until in 1866 they reached the enormous total of 37 millions. Then came the crash, caused by the restoration of peace in the United States, and the exports fell, until they now average little more than 8 millions a year. The fact is that Indian cotton has a short staple, and cannot compete with the best American cotton for spinning the finer qualities of yarn. But while the cotton famine was at its height, the cultivators were intelligent enough to make the most of their opportunity. The area under cotton increased enormously, and the growers managed to retain in their own hands a fair share of the profit. The principal cotton-growing tracts are the plains of Gujrat and Kathiawar, where Indian cotton has been raised in the Liverpool market the historic name of "Surat" the highlands of the Deccan, and the valleys of the Central Provinces and Berar. The total area under cotton in 1905-1906 was 20½ million acres, and the export was 7,396,000 cwt.

It was estimated in 1905 that the world's output of cotton was 19,000,000 bales, of which 13½ millions were produced in the United States, 3 millions in India, and nearly 1½ millions in Egypt, Japan and China being India's best customers for the raw article. At the same time the total number of spindles employed in working up the world's raw cotton was 116 millions, of which 48 millions were in the United States, 24 in India, 12 in Egypt, 6 in Japan, and a little over 5 millions in India. There were 203 cotton mills in India, employing a daily average of 196,360 persons. The Bombay Presidency possessed 70% of the mills and much the same percentage of spindles and looms. The industry dates from 1851, when the first mill was started. But though India has special advantages in home-grown cotton and cheap labour, the labour is so inefficient as to make competition with Europe difficult. It is calculated that an Indian power-loom weaver working 72 hours a week can turn out 70 lb of cloth, while a European working 54 hours can turn out 468 lb, and that one Lancashire weaver can do the work of six Indian power-loom weavers and nine hand-loomers. While these figures are high, good goods cannot be a serious competitor with Europe in the cotton industry.

**Jute.**—Next to cotton, jute is the most important and prosperous of Indian manufactures. With the advance of commerce it is more and more required for its best-known use, as sacking for produce. Australia and Argentina need it for wool and wheat, Chili and Brazil for nitrates and coffee, Asiatic countries for rice, and the world as a whole for its increased output of produce. The supply has not kept pace with the demand, and the consequence was a steady appreciation in price from 1901 onwards. The cultivation of jute is confined to a comparatively restricted area, the greater part of the total acreage being in eastern Bengal and Assam, while nearly the whole of the remaining fourth is in Bengal. In 1907, however, experiments were made towards growing it in other parts of India. In Behar it has begun to replace indigo, and some success was achieved in Orissa, Assam and Madras; but jute is a very exhausting crop, and requires to be planted in lands fertilized with silt or else with manure. About half the total crop is exported, and the remainder used in the jute mills centred round Calcutta, which supply cloth and bags for the grain export trade. The number of jute mills in 1904 was 38, employing 124,000 hands, and since then the number has tended constantly upwards. The export of jute in 1905-1906 was 14,480,000 cwt. with a value of £12,350,000.

**Silk.**—The silk industry in India has experienced many vicissitudes. Under the East India Company large quantities of mulberry silk were produced chiefly in Bengal, and exported to Europe; and Malda, Murshidabad, and other places in that province have long been famous for their silk manufactures. Other kinds of silk are native to certain parts of India, such as those produced by the "castor oil" and the *muga* silkworms of Assam; but the chief of the wild silk is the *terrace* silk, which is found in the jungles nearly throughout India. Large quantities of comparatively coarse silk are made from silk so produced. In Assam silk is still the national dress, and forms the common costume of the women, but the men are relinquishing it as an article of daily wear in favour of cotton. Amongst the Burmese, however, silk still holds its own. Owing to disease among the silk-worms the industry has declined of recent years; and in 1886 an inquiry was held, which resulted in putting the silk-rearing industry of Bengal on a better basis. The most hopeful

ground, however, for the industry is Kashmir, where Sir Thomas Wardle reported that the silk was of as high a quality as from any part of the world. The most important seat of the silk-weaving industry is Bengal, but there are few parts of India where some silk fabrics are not woven. The silk weavers of India possess the very highest skill in their craft, and with competent and energetic management and increased capital the industry could be revived and extended.

**Other Manufactures.**—The demand of the Indian population for woollen fabrics is very small in comparison with that for cotton, and although the manufacture of blankets is carried on in many parts of India, the chief part of the indigenous woollen industry was originally concerned with shawls. Kashmir shawls were at one time famous, but the industry is practically extinct. The chief seat of the woollen industry now is the Punjab, where a considerable number of weavers, thrown out of work by the decline of the shawl industry, have taken to carpet-making. The chief centre of this industry is Amritsar. The output of the woollen mills is chiefly used for the army and the police. In addition to these and the cotton and jute mills there are indigo factories, rice mills, timber mills, coffee works, oil mills, iron and brass foundries, tile factories, printing presses, lac factories, silk mills, and paper mills. There is a large trade in wood-carving, the material being generally Indian ebony in northern India, sandal-wood in southern India, and teak in Burma and elsewhere.

From an artistic point of view the metal manufactures are one of the most important products of India.

**Brass and Copper Work.**—The village brazier, like the village smith, manufactures the necessary vessels for domestic use. Chief among these vessels is the *lota*, or globular bowl, universally used in ceremonial ablutions. The form of the *lota*, and even the style of ornamentation, has been handed down unaltered from the earliest times. Benares enjoys the first reputation for work in brass and copper. In the south, Madras and Tanjore have a similar fame and in the west, Ahmedabad, Poona and Nasik. At Bombay itself large quantities of imported copper are wrought up by native braziers. The temple bells of India are well known for the depth and purity of their note. In many localities the braziers have a special repute either for a peculiar alloy or for a particular process of ornamentation. Silver is sometimes mixed with the brass, and in rarer cases gold. The brass or rather bell-metal ware of Murshidabad, known as *khagrai*, has more than a local reputation, owing to the large admixture of silver in it.

Pottery is made in almost every village, from the small vessels required in cooking to the large jars used for storing grain and

**Pottery.**—occasionally as floats to ferry persons across a swollen stream. But, though the industry is universal, it has hardly anywhere risen to the dignity of a fine art. Sind is the only province of India where the potter's craft is pursued with any regard to artistic considerations; and there the industry is said to have been introduced by the Mahomedans. Sind pottery is of two kinds, encaustic tiles and vessels for domestic use. In both cases the colours are the same,—turquoise blue, copper green, dark purple or golden brown, under an exquisitely transparent glaze. The usual ornament is a conventional flower pattern, pricked in from paper and dusted along the pricking. The tiles, which are evidently of the same origin as those of Persia and Turkey, are chiefly to be found in the ruined mosques and tombs of the old Mussulman dynasties; but the industry still survives at the little towns of Saldpur and Buhri. Artistic pottery is made at Hyderabad, Karachi, Tatta and Hala, and also at Multan and Lahore in the Punjab. The Madura pottery deserves mention from the elegance of its form and the richness of its colour. The United Provinces have, among other specialties, an elegant black ware with designs in white metal worked into its surface.

#### Mineral Resources.

Putting aside salt, which has been already treated, the chief mining resources of India at the present day are the coal mines, the gold mines, the petroleum oil-fields, the ruby mines, manganese deposits, mica mines in Bengal, and the tin ores and jade of Burma. Other minerals which exist but have not yet been developed in paying quantities are copper ore, alum, gypsum and plumbago.

**Coal.**—Coal has been known to exist in India since 1774. The first mine at Raniganj dates from 1820, and has been regularly worked up to the present time. Coal of varying quality exists under a very extensive area in India, being found in almost every province and native state with the exception of Bombay and Mysore. In respect, however, of both the number and size of its mines Bengal comes easily first, with seven-eighths of the total output, the largest mine being Raniganj. Jherria and Goddard, which are the Singareen mine in Hyderabad, being next. Many of the Bengal mines, however, are very small. There are some important mines in Assam and the Central Provinces. The importance of the Indian coal production lies in the hope that it holds out for the development of Indian industries, especially in connexion with the nascent iron and steel industry. Coal and iron are found in conjunction in the Central Provinces, and the Tata Company has recently been formed

to work them on a large scale. The railways already use Indian coal almost exclusively, and Indian coal is being taken yearly in greater quantities by ships trading to Eastern ports. The total output in 1905-1906 was 8,417,739 tons; while there were 47 companies engaged in coal-mining, of which 46 were in Bengal.

**Gold.**—The production of gold in India is practically confined to the Kolar gold fields in Mysore. An uncertain but unimportant amount is annually procured by sand-washing in various tracts of northern India and Burma; and there have been many attempts, including the great boom of 1880, to work the mines in the Wynad district of the Madras Presidency. There are also mines in the Hyderabad state from which a small amount of gold is produced. But the output of gold in Mysore represents 99% of the annual Indian yield. Modern mining at Kolar dates from 1881, but there are extensive old workings showing that much gold had been extracted under native rule. The mines are worked under leases from the Mysore government, which secure to the state a royalty of 5% of the gold produced. Up to the end of 1903 the total output of the Kolar mines reached the value of £19,000,000.

**Iron.**—In purity of ore, and in antiquity of working, the iron deposits of India probably rank first in the world. They are to be found in almost every part of the country, from the mountains of Assam and Khasia to the southern tip of the Madras Presidency. Wherever there are hills, iron is found and worked to a greater or less extent. The indigenous methods of smelting the ore, which are everywhere the same, and have been handed down unchanged through countless generations, yield a metal of the finest quality in a form well suited to native wants. But they require an extravagant supply of charcoal; and even with the cheapness of native labour the product cannot compete in price with imported iron from England. European enterprise, attracted by the richness of the ore and the low rate of wages, has repeatedly tried to establish iron-works on a large scale; but hitherto every one of these attempts has ended in failure with the exception of the iron-works at Barrakur in Bengal, first started in 1861, which after many years of struggle seem to have turned the corner of success. The principal source of iron-stone at present are the Madras ores, chiefly at Salem, the Chanda ores in the Central Provinces, and the ores obtained at and near Raniganj in Bengal.

**Petroleum.**—The great oilfields of the Indian empire are in Burma, which supplies 98% of the total output. Of the remainder nearly all comes from Assam. In both provinces the growth of the yield has been very great, the total output in 1901 being six times as large as in 1892; but even so it has failed to keep pace with the demand. A regular service of steamers carries oil in bulk from Rangoon to Calcutta, and now Burma oil competes with the Russian product, which is already ready-driven the dearer American oil from the market (see BURMA).

**Other Ores.**—Manganese ore is found in very large quantities on a tract on the Madras coast about midway between Calcutta and Madras. Most of the ore goes to Great Britain. There are also valuable deposits of manganese in the Central Provinces and, it is believed, in Burma. The export of manganese, which had been only about ten years in existence in 1905-1906, amounted then to 316,694 tons, with a value of £250,000. Mica has long been obtained in Bengal, chiefly in the Hazaribagh district, and there is a ruby-coloured variety which is held in great estimation. In Madras also a mica industry has recently grown up. Tin is found in the Favo and Mergul districts of Lower Burma, and has for many years been worked in an unprogressive manner chiefly by Chinese labour. In 1900 tin of good quality was found in the Southern Shan States. Copper ore is found in many tracts throughout India, plumbago in Madras, and corundum in southern India.

**Precious Stones.**—Despite its legendary wealth, which is really due to the accumulations of ages, India cannot be said to be naturally rich in precious stones. Under the Mahomedan rule diamonds were a distinct source of state revenue; and Akbar is said to have received a royalty of £80,000 a year from the mines of Panna. But at the present day the search for them, if carried on anywhere in British territory, is an insignificant occupation. The name of Golconda has passed into literature; but that city, once the Mussulman capital of the Deccan, was rather the home of diamond-cutters than the source of supply. It is believed that the far-famed diamonds of Golconda actually came from the sandstone formation which extends across the south-east borders of the nizams' dominions into the Madras districts of Ganjam and Godavari. A few poor stones are still found in that region. Sambalpur, on the upper channel of the Mahanadi river in the Central Provinces, is another spot once famous for diamonds. So late as 1818 a stone is said to have been found there weighing 84 grains and valued at £500. The river-valleys of Chota Nagpur are also known to have yielded a tribute of diamonds to their Mahomedan conquerors. At the present day the only prospect of diamonds is as a regular industry in the native state of Panna in Bundelkhand. The stones are found by digging down through several strata of gravelly soil and washing the earth. Even there, however, the pursuit is understood to be unremunerative, and has failed to attract European capital. At the present day the only important industries are the rubies and jade of Burma. The former are worked by the Ruby Mines Company or by licensed native miners under the

company. The value of the rubies found has increased rapidly, and the company, which was for some time worked unprofitably under the lease granted in 1896, has now, with the aid of favourable treatment from the government, become more prosperous. Pearls are found off the southern coast of Madras and also in the Mergui archipelago.

#### Trade.

The trade of India with foreign countries is conducted partly by sea and partly across the land frontiers; but the frontier trade, though capable of much extension, is only a small fraction of the whole. The sea-borne trade is carried on chiefly through the four great ports of Calcutta, Bombay, Karachi, and Rangoon, of which Calcutta serves the fertile valley of the Ganges and Brahmputra. Bombay serves the cotton-trade of western India, Karachi exports the wheat crop of the Punjab, and Rangoon the rice crop of Burma. Madras, which has been supplied with an artificial harbour, serves southern India, and Chittagong is rising into prominence as the point of departure for the tea and jute of eastern Bengal and Assam. The land trade is carried on with Persia, Afghanistan, Nepal, Tibet and western China. The new caravan route to Persia from Quetta by way of the Nushki railway offers facilities to traders, of which increasing advantage has been taken, but the trade is still small. Afghanistan under Abdur Rahman imposed prohibitive imposts upon trade, and the present amir followed his father's policy, but his visit to India in 1907 may result in improved relations. The trade with the tribes lying north of the Malakand Pass has improved considerably since the frontier war of 1897-98, but they are a poor community. Nepal takes the largest share of the frontier trade. The trade with Tibet has slightly improved since the treaty of Lhasa of 1904, but it still amounts to only £90,000 annually. The trade with western China is about half a million annually, and shows signs of development.

A review of Indian trade by the director-general of the statistical department in India is annually presented to parliament, and therefore it is only necessary here to mention the main channels for it which has taken of recent years. The chief exports are raw cotton, cotton goods, opium, oil, oil-seed, jute, and jute manufactures, hides and skins, tea, opium and lac. In 1905-1906 there was great activity in both the cotton and jute industries. In Bombay new cotton mills were erected, and old ones extended, high-speed machinery was widely introduced, and 12,000 new looms were set up. Similarly the jute trade far surpassed all records. The crop was a record one, but the demand far exceeded the supply, the cultivators reaped profits of eight millions more than the previous year, and 2000 new looms were set up in Calcutta. The tea outlook was good, and the coffee industry was recovering from the effects of plant disease and Brazilian competition. But both the indigo and opium trades are declining industries, which mean a serious loss to the Indian exchequer. Indigo fell to about one-tenth of its value in the previous decade; and an agreement was come to with China in 1907, by which the area under opium is to be gradually reduced. The total exports for 1905-1906 were valued at £112,000,000.

The chief articles of import are cotton goods, cotton yarn, metals, sugar, mineral oils, machinery and mill-work, woollen manufactures, provisions, hardware and cutlery, silk, liquors, apparel, railway material and chemicals. Cotton manufactures and yarns are imported almost exclusively from the United Kingdom, and amount to about 40% of the total trade. Metals, including hardware and cutlery, railway material, &c., supply about a fifth. The only other important article of import is sugar, which came to about 5 millions in 1905-1906. The balance of trade is always against India, because she is a debtor country, and has to pay interest on borrowed capital, and the "home charges" for the upkeep of the civil and military services and of the secretary of state's establishment in London. The total imports for 1905-1906 were valued at 82½ millions sterling, including 14 millions of gold and silver, which are continually hoarded by the people of India.

Broadly speaking, the greater part of the internal trade remains in the hands of the natives. Europeans control the shipping business and have a share in the collection of some of the more valuable staples of exports, such as cotton, jute, oil-seeds and wheat. But the work of distribution and the adaptation of the supply to the demand of the consumer naturally fall to those who are best acquainted with native wants. The Vaisya, or trading caste of Manu, has no longer any separate existence; but its place is occupied by several well-marked classes. On the western coast the Parsees, by the boldness and extent of their operations, tread close upon the heels of the most prosperous English houses. In the interior of the Bombay presidency, business is mainly divided between

two classes, the Bunniahs of Gujrat and the Marwaris from Rajputana. Each of these profess a peculiar form of religion, the former being Vishnuvites of the Vallabachari sect, the latter Jain. In the Deccan their place is taken by Lingayats from the south, who again follow a peculiar form of Hinduism, which is an heretical species of Siva worship. Throughout Mysore, and in the north of Madras, Lingayats are still found, but along the eastern sea-board the predominating classes of traders are those named Chetties and Komatis. In Bengal many of the upper castes of Sudras have devoted themselves to general trade; but there again the Jain Marwaris from Rajputana occupy the front rank. Their headquarters are in Murshidabad district, and their agents are to be found throughout the valley of the Brahmaputra, as far up as the unexplored frontier of China.

Local trade is conducted either at the permanent bazaars of great towns, at weekly markets held in certain villages, at annual gatherings primarily held for religious purposes, or by means of travelling brokers and agents. The cultivator himself, who is the chief producer and also the chief customer, knows little of the great towns, and expects the dealer to come to his own door. Each village has at least one resident trader, who usually combines in his own person the functions of money-lender, grain dealer and cloth seller. The simple system of rural economy is entirely based upon the dealings of this man, whom it is the fashion sometimes to decry as a usurer, but who is really the one trustworthy person among an improvident population. Abolish the money-lender, and the general body of cultivators would have nothing to depend upon but the harvest of a single year. The money-lender deals chiefly in grain and in specie. In those districts where the staples of export are largely grown, the cultivators commonly sell their crops to travelling brokers, who re-sell to larger dealers, and so on until the commodities reach the hands of the agents of the great shipping houses. The wholesale trade thus rests ultimately with a comparatively small number of persons, who have agencies, or rather corresponding firms, at the great central marts. Buying and selling in their aspects most characteristic of India are to be seen, not at these great towns, nor even at the weekly markets, but at the fairs which are held periodically at certain spots in most districts. Religion is always the original pretext of these gatherings or *melés*, at some of which nothing is done beyond bathing in the river, or performing certain superstitious ceremonies. But in the majority of cases religion has become a mere excuse for secular business. Crowds of petty traders attend, bringing all those miscellaneous articles that can be packed into a pedlar's wallet; and the neighbouring villagers look forward to the occasion to satisfy alike their curiosity and their household wants.

The control of the revenues of India is vested by act of parliament in the secretary of state for India in council. Subject to his control the government of India enjoys a certain discretionary **Finance** power, but no new expenditure may be incurred without his sanction. There is a special member for finance in the governor-general's council, and all important matters are brought before the council. The central government keeps in its own hands certain revenues, such as salt, the post-office, telegraphs, railways, army and Indian Marine, in addition to the districts of Coorg, Ajmer and the North-West Frontier province. The other provinces raise and administer their own revenues, subject to the central control; they are allowed a certain proportion of the revenue to meet their own administrative charges, and so have an interest in economical expenditure. The apportionment of the revenue is set forth afresh every five years. In 1893 the Indian mints were closed to the free coinage of silver, and in 1899 the British sovereign was made legal tender at the rate of 1s. 4d. per rupee; so that since that year the finances of India have been practically upon a gold basis. The principal heads of revenue are land, opium, salt, stamps, excise, customs, assessed taxes, forests, registration and tributes from native states; and the chief heads of expenditure are charges of collection, interest, post-office, telegraph and mint, civil departments, famine relief and insurance, railways, irrigation, other public works and army. The point most frequently criticised in the finances of India is the "home charges" which amount on an average to about 18½ millions a year. Of this total about 9½ millions are for interest on railways and other public works, 5 millions for pensions and furlough pay for civil and military officers, 2½ millions for stores and 1½ millions miscellaneous. These charges constitute the home expenditure on revenue account, but there are also other remittances from India on capital account which bring up the total disbursements in England to an annual average of about 21½ millions.

#### Public Works.

Public works in India fall under three categories—railways, irrigation, and roads and buildings. The railways are managed in various ways, the other two classes of works are carried out through the agency of separate departments in Madras and Bombay, and of officers of the government of India public works department, either under local or central control, in other provinces.



Railways in India serve different purposes—the ordinary purpose of trade and passenger communication, and also the special purposes of the safeguarding the internal and external peace of the country, and of protecting special districts against famine by facilitating the movement of grain. For this reason the interest on capital expended on all the lines cannot be judged by a purely commercial standard. They are administered in three separate ways—as guaranteed, state or assisted lines. In the early days of railway enterprise the agency of private companies guaranteed by the state was exclusively employed, and nearly all the great trunk lines were made under this system, but the leases of the last three of these lines, the Great Indian Peninsula, the Bombay Baroda and Central India, and the Madras companies, fell in respectively in 1900, 1905 and 1907. In 1870 a new policy of railway development by the direct agency of the state was inaugurated; and in 1880 the system of encouraging private enterprise by state assistance was again resorted to. Both agencies are now employed side by side. The administration of railways was formerly under a secretary in the public works department; but since 1905 it has been placed in charge of a railway board, consisting of a president and two members, which is connected with, though not subordinate to, the department of commerce and industry. In 1908 the total length of railways open in India was 30,578, m., which carried 330 million passengers and 64 million tons of goods, and yielded a net profit exceeding 4%.

Facilities for irrigation (*q.v.*) vary widely, and irrigation works differ both in extent and in character. The main distinction arises from the fact that the rivers of northern India are fed by the Himalayan snows, and, therefore, afford a supply of water which surpasses in constancy and volume any of the rivers of the south. In Bombay and Madras almost all the irrigation systems, except in the deltas of the chief rivers, are dependent on reservoirs or "tanks," which collect the rainfall of the adjacent hills. In Sind and the Punjab there are many canals which act merely as distributaries of the overflow of the great rivers at the time of inundation; but where the utility of the canals has been increased by permanent headworks the supply of water is perennial and practically inexhaustible, thus contrasting favourably with the less certain protection given by tanks. The Irrigation Commission of 1901 advised an expenditure of 30 millions sterling, spread over a term of twenty years, and irrigating 64 million acres in addition to the 47 millions already irrigated at that time; but it was estimated that that programme would practically exhaust the irrigable land in India, and that some of the later works would be merely protective against the danger of famine, and would not be financially productive.

In addition to the provision and maintenance of roads and the construction of public buildings, the department of public works also provides all works of a public nature, such as water-supply, sanitation, embankments, lighthouses, ferries and bridges, which require technical skill. Road-making is an ordinary form of relief work in times of famine. In the famine of 1896-1897, for instance, 579 m. of new roads were made in the Central Provinces alone, and 819 m. were repaired. One of the finest roads in the world is the Grand Trunk Road which stretches across India from Calcutta to Peshawar, and which is metalled most of the way with *kanbar*, a hard limestone outgrowth. The great buildings of ancient India are described under the names of the different cities which contain them.

The post-office of India is under the control of a director-general, in subordination to the department of commerce and industry; and this officer has under him a postmaster-general or deputy postmaster-general in each province. In 1906 the district post, originally provided for local convenience and maintained by a local cess, was amalgamated with the imperial post. The mileage over which mails are carried by railway has been constantly increasing with the development of the railway system, but a far larger number are still carried by runners and boats. The total number of letters, &c., carried by the post exceeds 800 millions, and the service yields a small profit to the state. In connexion with the post-office there are inland money order and savings-bank businesses; and in addition the value-payable system, by which the post-office undertakes to recover from the addressee the value of an article sent by post and to remit the amount to the sender, has found great popularity.

Excluding the Indo-European telegraph wire, the whole telegraph

system of India forms an imperial charge, administered through a director-general. The total length of line is about 69,000 m., and the net profits of the service approximately pay for new expenditure on capital account.

Telegraphic communication with Europe is maintained by the cable of the Eastern Telegraph Company via Aden, and by the Indo-European system, of which the eastern portion from Teheran and Fao to Karachi belongs to the government of India. The administration of the Indo-European department is in London under the direct control of the secretary of state. The system comprises two sections. The first, called the Persian Gulf section, runs from Karachi to Bushire, from Jask to Muscat, and from Bushire to Fao, where a connexion is made with the Ottoman government line. It includes also the Makran coast lines, running from Jask to Guadur, and thence to Karachi. The second section, known as the Persian section, consists of land lines running from Bushire to Teheran. These land lines, as well as the Makran coast lines, are worked under a treaty with the Persian government. A connexion for extending the system through Persia was signed in 1901, the route to be followed being from Kashan near Teheran to the Baluchistan frontier via Yazd and Kerman.

**BIBLIOGRAPHY.**—*Imperial Gazetteer of India* (new edition, 1907-1909); *Census of India* (1901); *Statistical Atlas of India* (1895); G. A. Grierson, *Linguistic Survey of India* (1903); Sir Thomas Holdich, *India ("Regions of the World" series)* (1902); Sir John Strachey, *India* (1903); W. Crooke, *Natives of Northern India* (1907); W. S. Lilly, *India and its Problems* (1902); Sidney Low, *A Vision of India* (1906); R. D. Oldham, *Geology of India* (1893); W. T. Blanford, *Geology of India* (1880), and *Fauna of British India* (1888); R. Lydekker, *Great and Small Game of India* (1900); Sir J. D. Hooker, *Flora of British India* (1875); J. S. Gamble, *Manual of Indian Timbers* (1902); *Indian Land Revenue Policy* (Calcutta, 1902); B. H. Baden-Powell, *The Indian Village Community* (1896); Abdullah Yusuf Ali, *Life and Labour of the People of India* (1907); Theodore Morrison, *Industrial Organisation of an Indian Province* (1906); Professor Wyndham Dunstan, *Coal Resources of India* (Society of Arts, 1902); Sir George Watt, *Dictionary of Economic Products of India* (1908); Sir George Birdwood, *Industrial Arts of India* (1880); R. H. Mahon, *Iron and Steel in India* (1899); *Lord Curzon in India* (1906); *India Office List*; *The Statesman's Year-Book*; and the government of India's annual reports.

(W. W. H.; J. S. Co.)

## HISTORY

For an orthodox Hindu the history of India begins more than three thousand years before the Christian era with the events detailed in the great epic of the *Mahabharata*; but by the sober historian these can only be regarded as legends. See the article **INSCRIPTIONS**: section *Indian*, for a discussion of the scientific basis of the early history. It is needless to repeat here the analysis given in that article. The following account of the earlier period follows the main outlines of the traditional facts, corrected as far as possible by the inscriptional record; and further details will be found in the separate biographical, racial and linguistic articles, and those on the geographical areas into which India is administratively divided.

Our earliest glimpses of India disclose two races struggling for the soil, the Dravidians, a dark-skinned race of aborigines, and the Aryans, a fair-skinned people, descending from the north-western passes. Ultimately the Dravidians were driven back into the southern tableland, and the great plains of Hindustan were occupied by the Aryans, who dominated the history of India for many centuries thereafter.

The *Rig-Veda* forms the great literary memorial of the early Aryan settlements in the Punjab. The age of this primitive folk-song is unknown. The Hindus believe, without evidence, that it existed "from before all time," or at least 3000 years B.C.—nearly 5000 years ago. European scholars have inferred from astronomical dates that its composition was going on about 1400 B.C. But these dates are themselves given in writings of later origin, and might have been calculated backwards. We only know that the Vedic religion had been at work long before the rise of Buddhism in the 6th century B.C. Nevertheless, the antiquity of the *Rig-Veda*, although not to be expressed in figures, is abundantly established. The earlier hymns exhibit the Aryans on the north-western frontiers of India just starting on their long journey. They show us the Aryans on the banks of the Indus, divided into various tribes, sometimes at war with each other, sometimes united against the "black-skinned" aborigines. Caste, in its later sense, is unknown. Each father

of a family is the priest of his own household. The chieftain acts as father and priest to the tribe; but at the greater festivals he chooses some one specially learned in holy offerings to conduct the sacrifice in the name of the people. The chief himself seems to have been elected. Women enjoyed a high position, and some of the most beautiful hymns were composed by ladies and queens. Marriage was held sacred. Husband and wife were both "rulers of the house" (*dampai*), and drew near to the gods together in prayer. The burning of widows on their husbands' funeral-pile was unknown, and the verses in the *Veda* which the Brahmins afterwards distorted into a sanction for the practice have the very opposite meaning.

The Aryan tribes in the *Veda* are acquainted with most of the metals. They have blacksmiths, coppersmiths and goldsmiths among them, besides carpenters, barbers and other artisans. They fight from chariots, and freely use the horse, although not yet the elephant, in war. They have settled down as husbandmen, till their fields with the plough, and live in villages or towns. But they also cling to their old wandering life, with their herds and "cattle-pens." Cattle, indeed, still form their chief wealth, the coin (Lat. *pecunia*) in which payments of fines are made; and one of their words for war literally means "a desire for cows." They have learned to build "ships," perhaps large river-boats, and seem to have heard something of the sea. Unlike the modern Hindus, the Aryans of the *Veda* ate beef, used a fermented liquor or beer made from the *soma* plant, and offered the same strong meat and drink to their gods. Thus the stout Aryans spread eastwards through northern India, pushed on from behind by later arrivals of their own stock, and driving before them, or reducing to bondage, the earlier "black-skinned" races. They marched in whole communities from one river-valley to another, each house-father a warrior, husbandman and priest, with his wife and his little ones, and cattle.

About the beginning of the 6th century B.C. the settled country between the Himalaya mountains and the Nerbudda river was divided into sixteen independent states, some monarchies and some tribal republics, the most important of which were the four monarchies of

**Early states.** Kosala, Magadha, the Vamsas and Avanti. Kosala, the modern kingdom of Oudh, appears to have been the premier state of India in 600 B.C. Later the supremacy was reft from it by the kingdom of Magadha, the modern Behar (*q.v.*). South of Kosala lay the kingdom of the Vamsas, and south of that again the kingdom of Avanti. In the north-west was Gandhara, on the banks of the Indus, in the neighbourhood of Peshawar. The history of these early states is only a confused record of war and intermarriages, and is still semi-mythical. The list of the sixteen states ignores everything north of the Himalayas, south of the Vindhya, and east of the Ganges where it turns south.

The principal cities of India at this date were Ayōdhya, the capital of Kosala at the time of the Ramayana, though it afterwards gave place to Srāvasti, which was one of the six great cities of India in the time of Buddha; archaeological differ as to its position. Baranasi, the modern Benares, had in the time of Megasthenes a circuit of 25 m. Kosambi, the capital of the Vamsas, lay on the Jumna, 230 m. from Benares. Rajagriha (Rajgir), the capital of Magadha, was built by Bimbisara, the contemporary of Buddha. Roruka, the capital of Sovira, was an important centre of the coasting trade. Saketa was sometime the capital of Kosala. Ujjayini, the modern Ujjain, was the capital of Avanti. None of these great cities has as yet been properly excavated.

In those early days the Aryan tribes were divided into four social grades on a basis of colour: the Kshatriyas or nobles, who claimed descent from the early leaders; the Brahmins or sacrificing priests; the Vaisyas, the peasantry; and last of all the Sudras, the hewers of wood and drawers of water, of non-Aryan descent. Even below these there were low tribes and trades, aboriginal tribes and slaves. In later documents mention is made of eighteen guilds of work-people, whose names are nowhere given, but they

probably included workers in wood, workers in metal, workers in stone, weavers, leather-workers, potters, ivory-workers, dyers, fisher-folk, butchers, hunters, cooks, barbers, flower-sellers, sailors, basket-makers and painters.

It is supposed that sea-going merchants, mostly Draavidians, and not Aryans, availing themselves of the monsoons, traded in the 7th century B.C. from the south-west ports of India to Babylon, and that there they became acquainted with a Semitic alphabet, which they brought back with them, and from which all the alphabets now used in India, Burma, Siam and Ceylon have been gradually evolved. For the early inscriptional remains, see INSCRIPTIONS: India. The earliest written records in India, however, are Buddhist. The earliest written books are in Pali and Buddhist Sanskrit.

#### The Buddhist Period.

The systems called Jainism (see JAINS) and Buddhism (*q.v.*) had their roots in prehistoric philosophies, but were founded respectively by Vardhamana Mahavira and Gotama Buddha, both of whom were preaching in Magadha during the reign of Bimbisara (c. 520 B.C.).

During the next two hundred years Buddhism spread over northern India, perhaps receiving a new impulse from the Greek kingdoms in the Punjab. About the middle of the 3rd century B.C. Asoka, the king of Magadha or Behar, who reigned from 264 B.C. to 227 B.C., became a zealous convert to Buddhism. He is said to have supported 64,000 Buddhist priests; he founded many religious houses, and his kingdom is called the Land of the Monasteries (Vihara or Behar) to this day. He did for Buddhism what Constantine effected for Christianity; he organized it on the basis of a state religion. This he accomplished by five means—by a council to settle the faith, by edicts promulgating its principles, by a state department to watch over its purity, by missionaries to spread its doctrines, and by an authoritative collection of its sacred books. In 246 B.C. Asoka is said<sup>1</sup> to have convened at Pataliputra (Patna) the third Buddhist council of one thousand elders (the tradition that he actually convened it rests on no actual evidence that we possess). Evil men, taking on them the yellow robe of the order, had given forth their own opinions as the teaching of Buddha. Such heresies were now corrected; and the Buddhism of southern Asia practically dates from Asoka's council. In a number of edicts, both before and after the synod, he published throughout India the grand principles of the faith. Such edicts are still found grave deep upon pillars, in caves and on rocks, from the Yusufzai valley beyond Peshawar on the north-western frontier, through the heart of Hindustan, to Kathiawar and Mysore on the south and Orissa in the east. Tradition states that Asoka set up 64,000 memorial columns; and the thirty-five inscriptions extant in our own day show how widely these royal sermons were spread over India. In the year of the council, the king also founded a state department to watch over the purity and to direct the spread of the faith. A minister of justice and religion (Dharma Mahamatra) directed its operations; and, one of its first duties being to proselytize, he was specially charged with the welfare of the aborigines among whom his missionaries were sent. Asoka did not think it enough to convert the inferior races without looking after their material interests. Wells were to be dug and trees planted along the roads; a system of medical aid was established throughout his kingdom and the conquered provinces, as far as Ceylon, for both man and beast. Officers were appointed to watch over domestic life and public morality, and to promote instruction among the women as well as the youth.

Asoka recognized proselytism by peaceful means as a state duty. The rock inscriptions record how he sent forth missionaries "to the utmost limits of the barbarian countries," to "intermingle among all unbelievers" for the spread of religion. They shall mix equally with Brahmins and beggars, with the

<sup>1</sup> The historicity of this convention, not now usually admitted by scholars, is maintained by Bishop Copleston of Calcutta in his *Buddhism, Primitive and Present* (1908).

dreaded and the despised, both within the kingdom "and in foreign countries, teaching better things." Conversion is to be effected by persuasion, not by the sword. This character of a proselytizing faith which wins its victories by peaceful means has remained a prominent feature of Buddhism to the present day. Asoka, however, not only took measures to spread the religion; he also endeavoured to secure its orthodoxy. He collected the body of doctrine into an authoritative version, in the Magadhi language or dialect of his central kingdom in Behar—a version which for two thousand years has formed the canon (*piakas*) of the southern Buddhists.

The fourth and last of the great councils was held in Kashmir under the Kushan king Kanishka (see below). This council, which consisted of five hundred members, compiled three commentaries on the Buddhist faith. These commentaries supplied in part materials for the Tibetan or northern canon, drawn up at a subsequent period. The northern canon, or, as the Chinese proudly call it, the "greater vehicle of the law," includes many later corruptions or developments of the Indian faith as originally embodied by Asoka in the "lesser vehicle," or canon of the southern Buddhists.

The Kanishka commentaries were written in the Sanskrit language, perhaps because the Kashmir and northern priests who formed his council belonged to isolated Aryan colonies, which had been little influenced by the growth of the Indian vernacular dialects. In this way Kanishka and his Kashmir council became in some degree to the northern or Tibetan Buddhists what Asoka and his council had been to the Buddhists of Ceylon and the south.<sup>1</sup>

Buddhism never ousted Brahmanism from any large part of India. The two systems co-existed as popular religions during more than a thousand years (250 B.C. to about A.D. 800), and modern Hinduism is the joint product of both. Certain kings and certain eras were intensely Buddhist; but the continuous existence of Brahmanism is abundantly proved from the time of Alexander (327 B.C.) downwards. The historians who chronicled his march, and the Greek ambassador Megasthenes, who succeeded them (300 B.C.) in their literary labours, bear witness to the pre-eminence of the old faith in the period immediately preceding Asoka. Inscriptions, local legends, Sanskrit literature, and the drama disclose the survival of Brahman influence during the next six centuries (250 B.C.—A.D. 400). From A.D. 400 we have the evidence of the Chinese pilgrims, who toiled through Central Asia into India as the birthplace of their faith. Fa-Hien entered India from Afghanistan, and journeyed down the whole Gangetic valley to the Bay of Bengal in A.D. 399-413. He found Brahman priests equally honoured with Buddhist monks, and temples to the Indian gods side by side with the religious houses of his own faith. Hsüan Tsang also travelled to India from China by the Central Asia route, and has left a fuller record of the state of the two religions in the 7th century. His journey extended from A.D. 629 to 645, and everywhere throughout India he found the two faiths eagerly competing for the suffrages of the people. By that time, indeed, Brahmanism was beginning to assert itself at the expense of the other religion. The monuments of the great Buddhist monarchs, Asoka and Kanishka, confronted him from the time he neared the Punjab frontier; but so also did the temples of Siva and his "dread" queen Bhima. Throughout north-western India he found Buddhist convents and monks surrounded by "swarms of heretics." The political power was also divided, although Buddhist sovereigns predominated. A Buddhist monarch ruled over ten kingdoms in Afghanistan. At Peshawar the great monastery built by Kanishka was deserted, but the populace remained faithful. In Kashmir king and people were devout Buddhists, under the teaching of five hundred monasteries and five thousand monks. In the country identified with Jaipur, on the other hand, the inhabitants were devoted to heresy and war.

**Buddhism and Brahmanism.**

<sup>1</sup>In 1909 the excavation of a ruined stupa near Peshawar disclosed a casket, with an inscription of Kanishka, and containing fragments of bones believed to be those of Buddha himself.

During the next few centuries Brahmanism gradually became the ruling religion. There are legends of persecutions instigated by Brahman reformers, such as Kumarila Bhata and Sankar-Acharjya. But the downfall of Buddhism seems to have resulted from natural decay, and from new movements of religious thought, rather than from any general suppression by the sword. Its extinction is contemporaneous with the rise of Hinduism, and belongs to a subsequent part of this sketch. In the 11th century, only outlying states, such as Kashmir and Orissa, remained faithful; and before the Mohammedans fairly came upon the scene Buddhism as a popular faith had disappeared from India. During the last ten centuries Buddhism has been a banished religion from its native home. But it has won greater triumphs in its exile than it could ever have achieved in the land of its birth. It has created a literature and a religion for more than a third of the human race, and has profoundly affected the beliefs of the rest. Five hundred millions of men, or 35% of the inhabitants of the world, still follow the teaching of Buddha. Afghanistan, Nepal, Eastern Turkestan, Tibet, Mongolia, Manchuria, China, Japan, the Eastern Archipelago, Siam, Burma, Ceylon and India at one time marked the magnificent circumference of its conquests. Its shrines and monasteries stretched in a continuous line from the Caspian to the Pacific, and still extend from the confines of the Russian empire to the equatorial archipelago. During twenty-four centuries Buddhism has encountered and outlived a series of powerful rivals. At this day it forms one of the three great religions of the world, and is more numerous followed than either Christianity or Islam. In India its influence has survived its separate existence: it supplied a basis upon which Brahmanism finally developed from the creed of a caste into the religion of the people. The noblest survivals of Buddhism in India are to be found, not among any peculiar body, but in the religion of the people; in that principle of the brotherhood of man, with the reassertion of which each new revival of Hinduism starts; in the asylum which the great Hindu sects afford to women who have fallen victims to caste rules, to the widow and the out-caste; in the gentleness and charity to all men, which takes the place of a poor-law in India, and gives a high significance to the half satirical epithet of the "mild" Hindu.

**Decline of Buddhism.**

#### *Hindu Period.*

The external history of India may be considered to begin with the Greek invasion in 327 B.C. Some indirect trade between India and the Levant seems to have existed from very ancient times. Homer was acquainted with tin and other articles of Indian merchandise by their Sanskrit names; and a long list has been made of Indian products mentioned in the Bible. In the time of Darius (see PERSIA) the valley of the Indus was a Persian satrapy. But the first Greek historian who speaks clearly of India was Hecataeus of Miletus (549-486 B.C.); the knowledge of Herodotus (450 B.C.) ended at the Indus; and Ctesias, the physician (401 B.C.), brought back from his residence in Persia only a few facts about the products of India, its dyes and fabrics, its monkeys and parrots. India to the east of the Indus was first made known in Europe by the historians and men of science who accompanied Alexander the Great in 327 B.C. Their narratives, although now lost, are condensed in Strabo, Pliny and Arrian. Soon afterwards Megasthenes, as Greek ambassador resident at a court in Bengal (306-298 B.C.), had opportunities for the closest observation. The knowledge of the Greeks and Romans concerning India practically dates from his researches, 300 B.C.

Alexander the Great entered India early in 327 B.C. Crossing the lofty Khawak and Kaoshan passes of the Hindu Kush, he advanced by Alexandria, a city previously founded in the Koh-i-Daman, and Nicaea, another city to the west of Jalalabad, on the road from Kabul to India. Thence he turned eastwards through the Kunar valley and Bajour, and crossed the Gouraios (Panjkora) river. Here he laid siege to Mount Aornos, which is identified

**Alexander's march.**

by some authorities with the modern Mahaban, though this identification was rejected by Dr Stein after an exhaustive survey of Mount Mahaban in 1904. Alexander crossed the Indus at Ohind, 16 m. above Attock, receiving there the submission of the great city of Taxila, which is now represented by miles of ruins near the modern Rawalpindi. Crossing the Hydaspes (Jhelum) he defeated Porus in a great battle, and crossing the Acesines (Chenab) near the foot of the hills and the Hydraotes (Ravi), reached the Hyphasis (Beas). Here he was obliged by the temper of his army to retrace his steps, and retreat to the Jhelum, whence he sailed down the river to its confluence with the Indus, and thence to Patala, probably the modern Hyderabad. From Patala the admiral Nearchos was to sail round the coast to the Euphrates, while Alexander himself marched through the wilds of Gedrosia, or modern Makran. Ultimately, after suffering agonies of thirst in the desert, the army made its way back to the coast at the modern harbour of Pasin, whence the return to Susa in Persia was comparatively easy.

During his two years' campaign in the Punjab and Sind, Alexander captured no province, but he made alliances, founded cities and planted garrisons. He had transferred much territory to chiefs and confederacies devoted to his cause; every petty court had its Greek faction; and the detachments which he left behind at various positions, from the Afghan frontier to the Beas, and from near the base of the Himalaya to the Sind delta, were visible pledges of his return. At Taxila (Dehri-Shahan) and Nicaea (Mong) in the northern Punjab, at Alexandria (Uchch) in the southern Punjab, at Patala (Hyderabad) in Sind, and at other points along his route, he established military settlements of Greeks or allies. A large body of his troops remained in Bactria; and, in the partition of the empire which followed Alexander's death in 323 B.C., Bactria and India eventually fell to Seleucus Nicator, the founder of the Syrian monarchy (see SELEUCID).

Meanwhile a new power had arisen in India. Among the Indian adventurers who thronged Alexander's camp in the

Punjab, each with his plot for winning a kingdom or crushing a rival, Chandragupta Maurya, an exile from the Gangetic valley, seems to have played a somewhat ignominious part. He tried to tempt the wearied Greeks on the banks of the Beas with schemes of conquest in the rich south-eastern provinces; but, having personally offended their leader, he had to fly the camp (326 B.C.). In the confused years which followed, he managed with the aid of plundering bands to form a kingdom on the ruins of the Nanda dynasty in Magadha or Behar (321 B.C.). He seized the capital, Pataliputra, the modern Patna, established himself firmly in the Gangetic valley, and compelled the north-western principalities, Greeks and natives alike, to acknowledge his suzerainty. While, therefore, Seleucus was winning his way to the Syrian monarchy during the eleven years which followed Alexander's death, Chandragupta was building up an empire in northern India. Seleucus reigned in Syria from 312 to 280 B.C., Chandragupta in the Gangetic valley from 321 to 296 B.C. In 312 B.C. the power of both had been consolidated, and the two new sovereignties were brought face to face. In that year Seleucus, having recovered Babylon, proceeded to re-establish his authority in Bactria (*q.v.*) and the Punjab. In the latter province he found the Greek influence decayed. Alexander had left behind a mixed force of Greeks and Indians at Taxila. No sooner was he gone than the Indians rose and slew the Greek governor; the Macedonians massacred the Indians; a new governor, sent by Alexander, murdered the friendly Punjab prince, Porus, and was himself driven out of the country by the advance of Chandragupta from the Gangetic valley. Seleucus, after a war with Chandragupta, determined to ally himself with the new power in India rather than to oppose it. In return for five hundred elephants, he ceded the Greek settlements in the Punjab and the Kabul valley, gave his daughter to Chandragupta in marriage, and stationed an ambassador, Megasthenes, at the Gangetic court (302 B.C.). Chandragupta became familiar

to the Greeks as Sandrocottus, king of the Prasii; his capital, Pataliputra was called by them Palimbothra. On the other hand, the names of Greeks and kings of Grecian dynasties appear in the rock inscriptions, under Indian forms.

Previous to the time of Megasthenes the Greek idea of India was a very vague one. Their historians spoke of two classes of Indians—certain mountainous tribes who dwelt in northern Afghanistan under the Caucasus or Hindu Kush, and a maritime race living on the coast of Baluchistan. Of the India of modern geography lying beyond the Indus they practically knew nothing. It was this India to the east of the Indus that Megasthenes opened up to the western world. He describes the classification of the people, dividing them, however, into seven castes instead of four, namely, philosophers, husbandmen, shepherds, artisans, soldiers, inspectors and the counsellors of the king. The philosophers were the Brahmans, and the prescribed stages of their life are indicated. Megasthenes draws a distinction between the Brahmans (*Βραχμανες*) and the Sarmanae (*Σαρμαναι*), from which some scholars have inferred that the Buddhist Sarmanae were a recognized class fifty years before the council of Asoka. But the Sarmanae also include Brahmans in the first and third stages of their life as students and forest recluses. The inspectors or sixth class of Megasthenes have been identified with Asoka's *Mahamatra* and his Buddhist inspectors of morals.

The Greek ambassador observed with admiration the absence of slavery in India, the chastity of the women, and the courage of the men. In valour they excelled all other Asiatics; they required no locks to their doors; above all, no Indian was ever known to tell a lie. Sober and industrious, good farmers and skilful artisans, they scarcely ever had recourse to a lawsuit, and lived peaceably under their native chiefs. The kingly government is portrayed almost as described in Manu, with its hereditary castes of councillors and soldiers. Megasthenes mentions that India was divided into one hundred and eighteen kingdoms; some of which, such as that of the Prasii under Chandragupta, exercised suzerain powers. The village system is well described, each little rural unit seeming to be an independent republic. Megasthenes remarked the exemption of the husbandmen (*Vaisyas*) from war and public services, and enumerated the dyes, fibres, fabrics and products (animal, vegetable and mineral) of India. Husbandry depended on the periodical rains; and forecasts of the weather, with a view to "make adequate provision against a coming deficiency," formed a special duty of the Brahmans. "The philosopher who errs in his predictions observes silence for the rest of his life."

Before the year 300 B.C. two powerful monarchies had thus begun to act upon the Brahmanism of northern India, from the east and from the west. On the east, in the Gangetic valley, Chandragupta (320-296 B.C.) firmly consolidated the dynasty which during the next century produced Asoka (264-228 or 227 B.C.), and established Buddhism throughout India. On the west, the Seleucids diffused Greek influences, and sent forth Graeco-Bactrian expeditions to the Punjab. Antiochus Theos (grandson of Seleucus Nicator) and Asoka (grandson of Chandragupta), who ruled these two monarchies in the 3rd century B.C., made a treaty with each other (256). In the next century Eucratides, king of Bactria, conquered as far as Alexander's royal city of Patala, and possibly sent expeditions into Cutch and Gujarat, 181-161 B.C. Of the Graeco-Indian monarchs, Menander (*q.v.*) advanced farthest into north-western India, and his coins are found from Kabul, near which he probably had his capital, as far as Muttra on the Jumna. The Buddhist dynasty of Chandragupta profoundly modified the religion of northern India from the east; the Seleucid empire, with its Bactrian and later offshoots, deeply influenced the science and art of Hindustan from the west.

Brahman astronomy owed much to the Greeks, and what the Buddhists were to the architecture of northern India, that the Greeks were to its sculpture. Greek faces and profiles constantly occur in ancient Buddhist statuary, and enrich almost all the larger museums in India. The purest specimens have been found in the North-west frontier province (the ancient Gandhara) and the Punjab, where the Greeks settled in greatest force. As we proceed eastward from the Punjab, the Greek type begins to fade. Purity of outline gives place to lushness of form. In the

<sup>1</sup> In 1909 an inscription in Brahmi characters was discovered near Bhilsa in Central India recording the name of a Greek, Heliodorus. He describes himself as a worshipper of Bhagavata (= Vishnu), and states that he had come from Taxila in the name of the great king Antialcidas, who is known from his coins to have lived c. 170 B.C.

female figures, the artists trust more and more to swelling breasts and towering chignons, and load the neck with constantly accumulating jewels. Nevertheless, the Grecian type of countenance long survived in Indian art. It is entirely unlike the present coarse conventional ideal of sculptured beauty, and may even be traced in the delicate profiles on the so-called sun temple at Kanarak, built in the 12th century A.D. on the remote Orissa shore.

Chandragupta (*q.v.*) was one of the greatest of Indian kings. The dominions that he had won back from the Greeks he administered with equal power. He maintained an army of 600,000 infantry, 30,000 horsemen, 30,000 men with the elephants, and 24,000 men with the chariots, which was controlled by an elaborate war-office system. The account given of his reign by Megasthenes makes him better known to us than any other Indian monarch down to the time of Akbar. In 207 B.C. he was succeeded by his son, Bindusara, who is supposed to have extended his dominions down to Madras. In 272 B.C. he in turn was succeeded by Asoka, the Buddhist emperor, the religious side of whose reign has already been described. Asoka's empire included the greater part of Afghanistan, a large part of Baluchistan, Sind, Kashmir, Nepal, Bengal to the mouths of the Ganges, and peninsular India down to the Palur river. After Asoka the Mauryas dwindled away, and the last of them, Brihadratha, was treacherously assassinated in 184 B.C. by his commander-in-chief, Pushyamitra Sunga, who founded the Sunga dynasty.

During the 2nd century B.C. north-western India was invaded and partially conquered by Antiochus III. the Great, Demetrius (*q.v.*), Eucratides (*q.v.*) and Menander (*q.v.*). With the last of these Pushyamitra Sunga waged successful war, driving him from the Gangetic valley and confining him to his conquests in the west. Pushyamitra established his own paramountcy over northern India; but his reign is mainly memorable as marking the beginning of the Brahmanical reaction against Buddhism, a reaction which Pushyamitra is said to have forwarded not only by the peaceful revival of Hindu rites but by a savage persecution of the Buddhist monks. The Sunga dynasty, after lasting 112 years, was succeeded by the Kanva dynasty, which lasted 45 years, *i.e.* until about 27 B.C., when it was overthrown by an unknown king of the Andhra dynasty of the Satavahanas, whose power, originating in the deltas of the Godavari and Kistna rivers, by A.D. 200 had spread across India to Nasik and gradually pushed its way northwards.

About A.D. 100 there appeared in the west three foreign tribes from the north, who conquered the native population and established themselves in Malwa, Gujarat and Kathiawar. These tribes were the Sakas, a horde of pastoral nomads from Central Asia (see SAKA), the Pahlavas, whose name is supposed to be a corruption of "Parthiva" (*i.e.* Parthians of Persia), and the Yavanas (Ionians), *i.e.* foreigners from the old Indo-Greek kingdoms of the north west frontier, all of whom had been driven southwards by the Yue-chi (*q.v.*). Their rulers, of whom the first to be mentioned is Bhumaka, of the Kshaharata family, took the Persian title of satrap (Kshatrapa). They were hated by the Hindus as barbarians who disregarded the caste system and despised the holy law, and for centuries an intermittent struggle continued between the satraps and the Andhras, with varying fortune. Finally, however, about A.D. 236, the Andhra dynasty, after an existence of some 460 years, came to an end, under circumstances of which no record remains, and their place in western India was taken by the Kshaharata satraps, until the last of them was overthrown by Chandragupta Vikramaditya at the close of the 4th century.

Meanwhile, the Yue-chi had themselves crossed the Hindu Kush to the invasion of north-western India (see YUE-CHI). They were originally divided into five tribes, which were united under the rule of Kadphises I. (? A.D. 45-85), the founder of

the Kushan dynasty, who conquered the Kabul valley, annihilating what remained there of the Greek dominion, and swept away the petty Indo-Greek and Indo-Parthian principalities on the Indus. His successors completed the conquest of north-western India from the delta of the Indus eastwards probably as far as Benares.

One effect of the Yue-chi conquests was to open up a channel of commerce with the Roman empire by the northern trade routes; and the Indian embassy which, according to Dion. Cassius (ix. 58), visited Trajan after his arrival at Rome in A.D. 99, was probably<sup>2</sup> sent by Kadphises II. (Oeomokadphises) to announce his conquest of north-western India. The most celebrated of the Kushan kings, however, was Kanishka, whose date is still a matter of controversy.<sup>3</sup> From his capital at Purushapura (Peshawar) he not only maintained his hold on north-western India, but conquered Kashmir, attacked Pataliputra, carried on a successful war with the Parthians, and led an army across the appalling passes of the Taghdumbash Pamir to the conquest of Kashgar, Yarkand and Khotan. It is not, however, as a conqueror that Kanishka mainly lives on in tradition, but as a Buddhist monarch, second in reputation only to Asoka, and as the convener of the celebrated council of Kashmir already mentioned.

The dynasties of the Andhras in the centre and south and of the Kushans in the north came to an end almost at the same time (*c.* A.D. 236-225 respectively). The history of India during the remainder of the 3rd century is all but a blank, a confused record of meaningless names and disconnected events; and it is not until the opening of the 4th century that the veil is lifted, with the rise to supreme power in Magadha (A.D. 320) of Chandragupta I., the founder of the Gupta dynasty and empire (see GUPTA), the most extensive since the days of Asoka. He was succeeded by Chandragupta II. Vikramaditya, whose court and administration are described by the Chinese pilgrim Fa-hien, and who is supposed to have been the original of the mythical king Vikramaditya, who figures largely in Indian legends. The later Guptas were overwhelmed (*c.* 470) by the White Huns, or Ephthalites (*q.v.*), who after breaking the power of Persia and assailing the Kushan kingdom of Kabul, had poured into India, conquered Sind, and established their rule as far south as the Nerubudda. The dominion of the Huns in India, as elsewhere, was a mere organization for brigandage on an imperial scale and it did not long survive. It was shaken (*c.* 528) by the defeat, at the hands of tributary princes goaded to desperation, of Mihiragula, the most powerful and blood-thirsty of its rulers—the "Attila of India." It collapsed with the overthrow of the central power of the White Huns on the Oxus (*c.* 565) by the Turks. Though, however, this stopped the incursions of Asiatic hordes from the north-west, and India was to remain almost exempt from foreign invasion for some 500 years, the Ephthalite conquest added new and permanent elements to the Indian population. After the fall of the central power, the scattered Hunnish settlers, like so many before them, became rapidly Hinduized, and are probably the ancestors of some of the most famous Rajput clans.<sup>4</sup>

The last native monarch, prior to the Mahomedan conquest, to establish and maintain paramount power in the north was Harsha, or Harshavardhana (also known as Siladitya), for whose reign (606-648) full and trustworthy materials exist in the book of travels written by the Chinese pilgrim Hsüan Tsang and the *Harsha-charita* (Deeds of Harsha) composed by Bana, a Brahman who lived at the royal court. Harsha was the younger son of the raja of Thanesar, and gained his first experience of campaigning while still a boy in the successful wars

<sup>2</sup> V. A. Smith, *Early History of India*, p. 238.

<sup>3</sup> Smith, *op. cit.* pp. 239, &c., says that he probably succeeded Kadphises II. about A.D. 120. Dr. Fleet dates the beginning of Kanishka's reign 98 B.C. (see INSCRIPTIONS: *Indian*). Mr. Vincent Smith (*Imp. Geog. of India, The Indian Empire*, ed. 1908, vol. i, p. 289, note) dissents from this view, which is also held by Dr. Otto Franke of Berlin, stating that Dr. Stein's discoveries in Turkestan "strongly confirm the view" held by himself.

<sup>4</sup> See V. A. Smith, *op. cit.* p. 297, &c.

<sup>1</sup> This is the conventional European form of the name. For other forms see YUE-CHI.

waged by his father and brother against the Huns on the north-western frontier. After the treacherous murder of his brother by Sasanka, king of Central Bengal, he was confirmed as raja, though still very young, by the nobles of Thanesar in 606, though it would appear that his effective rule did not begin till six years later.<sup>1</sup> His first care was to revenge his brother's death, and though it seems that Sasanka escaped destruction for a while (he was still ruling in 610), Harsha's experience of warfare encouraged him to make preparations for bringing all India under his sway. By the end of five and a half years he had actually conquered the north-western regions and also, probably, part of Bengal. After this he reigned for 34½ years, devoting most of his energy to perfecting the administration of his vast dominions, which he did with such wisdom and liberality as to earn the commendation of Hsüan Tsang. In his campaigns he was almost uniformly successful; but in his attempt to conquer the Deccan he was repulsed (620) by the Chalukya king, Pulikesin II., who successfully prevented him from forcing the passes of the Nerbudda. Towards the end of his reign Harsha's empire embraced the whole basin of the Ganges from the Himalayas to the Nerbudda, including Nepal,<sup>2</sup> besides Malwa, Gujarat and Surashtra (Kathiawar); while even Assam (Kamarupa) was tributary to him. The empire, however, died with its founder. His benevolent despotism had healed the wounds inflicted by the barbarian invaders, and given to his subjects a false feeling of security. For he left no heir to carry on his work; his death "loosened the bonds which restrained the disruptive forces always ready to operate in India, and allowed them to produce their normal result, a medley of petty states, with ever-varying boundaries, and engaged in unceasing internecine war."<sup>3</sup>

In the Deccan the middle of the 6th century saw the rise of the Chalukya dynasty, founded by Pulikesin I. about A.D. 550.

The most famous monarch of this line was Pulikesin II., who repelled the inroads of Harsha (A.D. 620), and whose court was visited by Hsüan Tsang (A.D. 640); but in A.D. 642 he was defeated by the Pallavas of Conjeeveram; and though his son Vikramaditya I. restored the fallen fortunes of his family, the Chalukyas were finally superseded by the Rashtrakutas about A.D. 750. The Kailas temple at Ellora was built in the reign of Krishna I. (c. A.D. 760). The last of the Rashtrakutas was overthrown in A.D. 973 by Taila II., a scion of the old Chalukya stock, who founded a second dynasty known as the Chalukyas of Kalyani, which lasted like its predecessor for about two centuries and a quarter. About A.D. 1000 the Chalukya kingdom suffered severely from the invasion of the Chola king, Rajaraja the Great. Vikramanka, the hero of Bilhana's historical poem, came to the throne in A.D. 1076 and reigned for fifty years. After his death the Chalukya power declined. During the 12th and 13th centuries a family called Hoysala attained considerable prominence in the Mysore country, but they were overthrown by Malik Kafur in A.D. 1310. The Yadava kings of Deogiri were descendants of feudatory nobles of the Chalukya kingdom, but they, like the Hoysalas, were overthrown by Malik Kafur, and Ramachandra, the last of the line, was the last independent Hindu sovereign of the Deccan.

According to ancient tradition the kingdoms of the south were three—Pandya, Chola and Chera. Pandya occupied the extremity of the peninsula, south of Pudukottai, Chola extended northwards to Nellore, and Chera lay to the west, including Malabar, and is identified with the Kerala of Asoka. All three kingdoms were occupied by races speaking Dravidian languages. The authentic history of the south does not begin until the 9th and 10th centuries A.D., though the kingdoms are known to have existed in Asoka's time.

The most ancient mention of the name Pandya occurs in the 4th century B.C., and in Asoka's time the kingdom was inde-

pendent, but no early records survive, the inscriptions of the dynasty being of late date, while the long lists of kings in Tamil literature are untrustworthy. During the early centuries of the Christian era the Pandya and Chera kingdoms traded with Rome. The most ancient Pandya king to whom a definite date can be ascribed is Rajasimha (c. A.D. 920). Records begin towards the end of the 12th century, and the dynasty can be traced from then till the middle of the 16th century. The most conspicuous event in its history was the invasion by the Sinhalese armies of Parakramabahu, king of Ceylon (c. A.D. 1175). The early records of the Chera kingdom are still more meagre; and the authentic list of the rajas of Travancore does not begin till A.D. 1335, and the rajas of Cochín two centuries later.

The Chola kingdom, like the Pandya, is mentioned in the Sanskrit grammarian Katyayana in the 4th century B.C., and was recognized by Asoka as independent. The dynastic history of the Cholas begins about A.D. 860, and is known from then until its decline in the middle of the 13th century. During those four centuries their history is intertwined with that of the Pallavas, Chalukyas, Rashtrakutas and other minor dynasties. In A.D. 640 the Chola country was visited by Hsüan Tsang, but the country at that time was desolate, and the dynasty of small importance. In A.D. 985 Rajaraja the Great came to the throne, and after a reign of twenty-seven years died the paramount ruler of southern India. He conquered and annexed the island of Ceylon, and was succeeded by four equally vigorous members of the dynasty; but after the time of Vikrama (A.D. 1120) the Chola power gradually declined, and was practically extinguished by Malik Kafur.

The name of the Pallavas appears to be identical with that of the Pahlavas, a foreign tribe, frequently mentioned in inscriptions and Sanskrit literature. It is supposed, therefore, that the Pallavas came from the north, and gradually worked their way down to Malabar and the Coromandel coast. When first heard of in the 2nd century A.D. they are a ruling race. The Pallavas appear, like the Mah rattas in later times, to have imposed tribute on the territorial governments of the country. The first Pallava king about whom anything substantial is known was Siva-skanda-varman (c. A.D. 150), whose capital was Kanchi (Conjeeveram), his power extending into the Telugu country as far as the Kistna river. Two centuries later Samudragupta conquered eleven kings of the south, of whom three were Pallavas. It appears that in the 4th century three Pallava chiefs were established at Kanchi, Vengi and Palakkada, the latter two being subordinate to the first, and that Pallava rule extended from the Godavari on the north to the Southern Velluru river on the south, and stretched across Mysore from sea to sea. About A.D. 609 Pulikesin II., the Chalukya king, defeated Mahendra-varman, a Pallava chief, and drove him to take refuge behind the walls of Kanchi. About A.D. 620 a prince named Vishnuvardhana founded the Eastern Chalukya line in the province of Vengi, which was taken from the Pallavas. Hsüan Tsang visited Kanchi, the Pallava capital, in the year A.D. 640; the country was, according to his account, 1000 m. in circumference, and the capital was a large city 5 or 6 m. in circumference. In A.D. 642 the Pallavas defeated in turn Pulikesin II. The conflict became perennial, and when the Rashtrakutas supplanted the Chalukyas in the middle of the 8th century, they took up the old quarrel with the Pallavas. Towards the end of the 10th century the Pallava power, which had lasted for ten centuries, was destroyed by the Chola monarch, Rajaraja the Great. Pallava nobles existed to the end of the 17th century, and the raja of Pudukottai claims descent from the ancient royal family.

#### Mahommedan Period.

At the time that Buddhism was being crushed out of India by the Brahmanic reaction, a new faith was being born in Arabia, destined to supply a youthful fanaticism which should

<sup>1</sup> His era, however, is dated from 606.

<sup>2</sup> See V. A. Smith, *op. cit.* p. 314, who on this point differs from Sylvain Lévi and Ettinghausen.

<sup>3</sup> For Harsha's reign see Smith, *op. cit.* xiii. 311-331.

The  
Pandya  
Kingdom.

The  
Chola  
Kingdom.

The  
Pallava  
Con-  
federacy.

The  
Deccan.

The  
Kingdoms  
of the  
South.

sweep the country from the Himalayas to Cape Comorin, and from the western to the eastern sea. Mahomet, the founder of Islam, died at Medina in A.D. 632, while the Chinese pilgrim Hsüan Tsang was still on his travels. The first Mahomedan invasion of India is placed in 664, only thirty-two years after the death of the prophet. The Punjab is said to have been ravaged on this occasion with no permanent results. The first Mahomedan conquest was the outlying province of Sind. In 711, or seventy-nine years after the death of Mahomet, an Arab army under Mahomed b. Kasim invaded and conquered the Hindus of Sind in the name of Walid I., caliph of Damascus, of the Omayyad line. In the same year Roderic, the last of the Goths, fell before the victorious Saracens in Spain. But in India the bravery of the Rajputs and the devotion of the Brahmans seem to have afforded a stronger national bulwark than existed in western Europe. In 750 the Hindus rose in rebellion and drove out the Mussulman tyrant, and the land had rest for one hundred and fifty years.

The next Mahomedan invasion of India is associated with the name of Sultan Mahmud of Ghazni. Mahmud was the eldest son of Sabuktigin, surnamed Nasr-ud-din, in origin a Turkish slave, who had established his rule over the greater part of modern Afghanistan and Khorassan, with Ghazni as his capital. In 977 Sabuktigin is said to have defeated Jaipal, the Hindu raja of Lahore, and to have rendered the Punjab tributary. But his son Mahmud was the first of the great Mussulman conquerors whose names still ring through Asia. Mahmud succeeded to the throne in 997. During his reign of thirty-three years he extended the limits of his father's kingdom from Persia on the east to the Ganges on the west; and it is related that he led his armies into the plains of India no fewer than seventeen times. In 1001 he defeated Raja Jaipal a second time, and took him prisoner. But Anandpal, son of Jaipal, raised again the standard of national independence, and gathered an army of Rajput allies from the farthest corners of Hindustan. The decisive battle was fought in the valley of Peshawar. Mahmud won the day by the aid of his Turkish horsemen, and thenceforth the Punjab has been a Mahomedan province, except during the brief period of Sikh supremacy. The most famous of Mahmud's invasions of India was that undertaken in 1025-1026 against Gujarat. The goal of this expedition was the temple dedicated to Siva at Somnath, around which so many legends have gathered. It is reported that Mahmud marched through Ajmere to avoid the desert of Sind; that he found the Hindus gathered on the neck of the peninsula of Somnath in defence of their holy city; that the battle lasted for two days; that in the end the Rajput warriors fled to their boats, while the Brahman priests retired into the inmost shrine; that Mahmud, introduced into this shrine, rejected all entreaties by the Brahmans to spare their idol, and all offers of ransom; that he smote the image with his club, and forthwith a fountain of precious stones gushed out. Until the British invasion of Afghanistan in 1839, the club of Mahmud and the wood gates of Somnath were preserved at the tomb of the great conqueror near Ghazni. The club has now disappeared, and the gates brought back to India by Lord Ellenborough are recognized to be a clumsy forgery. To Mahomedans Mahmud is known, not only as a champion of the faith, but as a munificent patron of literature. The dynasty that he founded was not long-lived. Fourteen of his descendants occupied his throne within little more than a century, but none of them achieved greatness. A blood-feud arose between them and a line of Afghan princes who had established themselves among the mountains of Ghor. In 1155 Bahram, the last of the Ghaznvide Turks, was overthrown by Ala-ud-din of Ghor, and the wealthy and populous city of Ghazni was razed to the ground. But even the Ghoride conqueror spared the tomb of Mahmud.

Khusru, the son of Bahram, fled to Lahore, and there established the first Mahomedan dynasty within India. It speedily ended with his son, also called Khusru, whom Mahomed Ghor, the relentless enemy of the Ghaznvide house, carried away into captivity in 1186.

The Afghans of Ghor thus rose to power on the downfall of the Turks of Ghazni. The founder of the family is said to have been Izzud-din al Husain, whose son Ala-ud-din destroyed Ghazni, as already mentioned. Ala-ud-din had two nephews, Ghiyas-ud-din and Muiz-ud-din, the latter of whom, also called Shahab-ud-din by Mussulman chroniclers, and generally known in history as Mahomed Ghor, is the second of the great Mahomedan conquerors of India. In 1175 he took Multan and Uchch; in 1186 Lahore fell into his hands; in 1191 he was repulsed before Delhi, but soon afterwards he redeemed this disaster. Hindustan proper was at that period divided between the two Rajput kingdoms of Kanauj and Delhi. Mahomed Ghor achieved his object by playing off the rival kings against each other. By 1193 he had extended his conquests as far east as Benares, and the defeated Rajputs migrated in a body to the hills and deserts now known as Rajputana. In 1199 one of his lieutenants, named Bakhtiyar, advanced into Bengal, and expelled by an audacious stratagem the last Hindu raja of Nadia. The entire northern plain, from the Indus to the Brahmputra, thus lay under the Mahomedan yoke. But Mahomed Ghor never settled permanently in India. His favourite residence is said to have been the old capital of Ghazni, while he governed his Indian conquests through the agency of a favourite slave, Kutb-ud-din. Mahomed Ghor died in 1206, being assassinated by some Ghakkar tribesmen while sleeping in his tent by the bank of the Indus; and his death both Ghor and Ghazni drop out of history, and Delhi first appears as the Mahomedan capital of India.

On the death of Mahomed Ghor, Kutb-ud-din at once laid aside the title of viceroy, and proclaimed himself sultan of Delhi. He was the founder of what is known as the slave dynasty, which lasted for nearly a century (1206-1288). The name of Kutb is preserved in the *minar*, or pillar of victory, which still stands amid the ruins of ancient Delhi, towering high above all later structures. Kutb himself is said to have been successful as a general and an administrator, but none of his successors has left a mark in history.

In 1294 Ala-ud-din Khilji, the third of the great Mahomedan conquerors of India, raised himself to the throne of Delhi by the treacherous assassination of his uncle Feroz II. who had himself supplanted the last of the slave dynasty. Ala-ud-din had already won military renown by his expeditions into the yet unsubdued south. He had plundered the temples at Bhilsa in central India, which are admired to the present day as the most interesting examples of Buddhist architecture in the country. At the head of a small band of horsemen, he had ridden as far south as Deogiri (Daulatabad) in the Deccan (*q.v.*), and plundered the Yadava capital. When once established as sultan, he planned more extensive schemes of conquest. One army was sent to Gujarat under Alaf Khan, who conquered and expelled the last Rajput king of Anhalwar or Patan. Another army, led by the sultan in person, marched into the heart of Rajputana, and stormed the rock-fortress of Chitor, where the Rajputs had taken refuge with their women and children. A third army, commanded by Malik Kafur, a Hindu renegade and favourite of Ala-ud-din, penetrated to the extreme south of the peninsula, scattering the unwarlike Dravidian races, and stripping every Hindu temple of its accumulations of gold and jewels. To this day the name of Malik Kafur is remembered in the remote district of Madura, in association with irresistible fate and every form of sacrilege.

Ala-ud-din died in 1316, having subjected to Islam the Deccan and Gujarat. Three successors followed him upon the throne, but their united reigns extended over only five years. In 1321 a successful revolt was headed by Ghiyas-ud-din Tughlak, governor of the Punjab, who is said to have been of Turkish origin. The Tughlak dynasty lasted for about seventy years, until it was swept away by the invasion of Timur, the fourth Mahomedan conqueror of India, in 1398. Tughlak's son and successor, Mahomed b. Tughlak, who reigned

*Mahmud of Ghazni.*

*The Slave Dynasty.*

*Ala-ud-din.*

*Mahomed b. Tughlak.*

from 1325 to 1351, is described by Elphinstone as "one of the most accomplished princes and one of the most furious tyrants that ever adorned or disgraced human nature." He wasted the treasure accumulated by Ala-ud-din in purchasing the retirement of the Mogul hordes, who had already made their appearance in the Punjab. When the internal circulation failed, he issued a forced currency of copper, which is said to have deranged the whole commerce of the country. At one time he raised an army for the invasion of Persia. At another he actually despatched an expedition against China, which perished miserably in the Himalayan passes. When Hindustan was thus suffering from his misgovernment, he conceived the project of transferring the seat of empire to the Deccan, and compelled the inhabitants of Delhi to remove a distance of 700 m. to Deogiri or Daulatabad. And yet during the reign of this sultan both the Tughlak dynasty and the city of Delhi are said to have attained their utmost growth. - Mohammed was succeeded by his cousin Feroz, who likewise was not content without a new capital, which he placed a few miles north of Delhi, and called after his own name. He was a kind-hearted and popular, but weak, ruler. Meanwhile the remote provinces of the empire began to throw off their allegiance to the sultans of Delhi. The independence of the Afghan kings of Bengal is generally dated from 1336, when Mahommed Tughlak was yet on the throne. The commencement of the reign of Ala-ud-din, the founder of the Bahmani dynasty in the Deccan, is assigned to 1347. Zafar Khan, the first of the Ahmedabad kings, acted as an independent ruler from the time of his first appointment as governor of Gujarat in 1301. These and other revolts prepared the way for the fourth great invasion of India under Timur (Tamerlane).

Accordingly, when Timur invaded India in 1398, he encountered but little organized resistance. Mahmud, the last of

#### Timur's invasion.

the Tughlak dynasty, being defeated in a battle outside the walls of Delhi, fled into Gujarat. The city was sacked and the inhabitants massacred by the victorious Moguls. But the invasion of Timur left no permanent impress upon the history of India, except in so far as its memory fired the imagination of Baber, the founder of the Mogul dynasty. The details of the fighting and of the atrocities may be found related in cold blood by Timur himself in the *Malfuzat-i-Timuri*, which has been translated in Elliot's *History of India as told by its own Historians*, vol. iii. Timur marched back to Samarkand as he had come, by way of Kabul, and Mahmud Tughlak ventured to return to his desolate capital. He was succeeded by what is known as the Sayyid dynasty, which held Delhi and a few miles of surrounding country for about forty years. The Sayyids were in their turn expelled by Bahlol, an Afghan of the Lodi tribe, whose successors removed the seat of government to Agra, which thus for the first time became the imperial city. In 1526 Baber, the fifth in descent from Timur, and also the fifth Mahommedan conqueror, invaded India at the instigation of the governor of the Punjab, won the victory of Panipat over Ibrahim, the last of the Lodi dynasty, and founded the Mogul empire, which lasted, at least in name, until 1857.

In southern India at this time authentic history begins with the Hindu empire of Vijayanagar, which exercised an ill-defined sovereignty over the entire south from the 14th to the 16th century. The empire of Vijayanagar represents the last stand made by the national faith in India against conquering Islam. For at least two centuries its sway over the south was undisputed, and its rajahs waged wars and concluded treaties of peace with the sultans of the Deccan on equal terms.

The earliest of the Mahommedan dynasties in the Deccan was that founded by Ala-ud-din in 1347, which has received the name of the Bahmani dynasty. The capital was first at Gulbarga, and was afterwards removed to Bidar, both which places still possess magnificent palaces and mosques in ruins. Towards the close of the 14th century the Bahmani empire fell to pieces, and five independent kingdoms divided the Deccan among them. These were—(1) the Adil Shahi dynasty, with its capital at Bijapur,

founded in 1490 by a Turk; (2) the Kutb Shahi dynasty, with its capital at Golconda, founded in 1512 by a Turkoman adventurer; (3) the Nizam Shahi dynasty, with its capital at Ahmednagar, founded in 1490 by a Brahman renegade; (4) the Imad Shahi dynasty of Berar, with its capital at Ellichpur, founded in 1484 also by a Hindu from Vijayanagar; (5) the Barid Shahi dynasty, with its capital at Bidar, founded about 1492 by one who is variously described as a Turk and a Georgian slave. It is, of course, impossible here to trace in detail the history of these several dynasties. In 1565 they combined against the Hindu raja of Vijayanagar, who was defeated and slain in the decisive battle of Talikota. But, though the city was sacked and the supremacy of Vijayanagar for ever destroyed, the Mahommedan victors did not themselves advance far into the south. The Naiks or feudatories of Vijayanagar everywhere asserted their independence. From them are descended the well-known Palegars of the south, and also the present raja of Mysore. One of the blood-royal of Vijayanagar fled to Chandragiri, and founded a line which exercised a prerogative of its former sovereignty by granting the site of Madras to the English in 1639. Another scion claiming the same high descent lingers to the present day near the ruins of Vijayanagar, and is known as the raja of Anagundi, a feudatory of the nizam of Hyderabad. Despite frequent internal strife, the sultans of the Deccan retained their independence until conquered by the Mogul emperor Aurangzeb in the latter half of the 17th century. To complete this sketch of India at the time of Baber's invasion it remains to say that an independent Mahommedan dynasty reigned at Ahmedabad in Gujarat for nearly two centuries (from 1391 to 1573), until conquered by Akbar; and that Bengal was similarly independent, under a line of Afghan kings, with Gaur for their capital, from 1336 to 1573.

When, therefore, Baber invaded India in 1525, the greater part of the country was Mahommedan, but it did not recognize the authority of the Afghan sultan of the Lodi dynasty, who resided at Agra, and also ruled the historical capital of Delhi. After having won the battle of Panipat (1526) Baber was no more acknowledged as emperor of India than his ancestor Timur had been. Baber, however, unlike Timur, had resolved to settle in the plains of Hindustan, and carve out for himself a new empire with the help of his Mogul followers. His first task was to repel an attack by the Rajputs of Chitor, who seem to have attempted to re-establish at this time a Hindu empire. The battle was fought at Sikri near Agra, and is memorable for the vow made by the easy-living Baber that he would never again touch wine. Baber was again victorious, but died shortly afterwards in 1530. He was succeeded by his son Humayun, who is chiefly known as being the father of Akbar. In Humayun's reign the subject Afghans rose in revolt under Sher Shah, a native of Bengal, who for a short time established his authority over all Hindustan. Humayun was driven as an exile into Persia; and, while he was flying through the desert of Sind, his son Akbar was born to him in the petty fortress of Umakot. But Sher Shah was killed at the storming of the rock-fortress of Kalinjar, and Humayun, after many vicissitudes, succeeded in re-establishing his authority at Lahore and Delhi.

Humayun died by an accident in 1556, leaving but a circumscribed kingdom, surrounded on every side by active foes, to his son Akbar, then a boy of only fourteen years. Akbar, Akbar the Great, the real founder of the Mogul empire as it existed for two centuries, was the contemporary of Queen Elizabeth of England. He was born in 1542, and his reign lasted from 1556 to 1605. When his father died he was absent in the Punjab, fighting the revolted Afghans, under the guardianship of Bairam Khan, a native of Badakshan, whose military skill largely contributed to recover the throne for the Mogul line. For the first seven years of his reign Akbar was perpetually engaged in warfare. His first task was to establish his authority in the Punjab, and in the country around Delhi and Agra. In 1567 he stormed the Rajput stronghold of Chitor, and conquered Ajmere. In 1570 he obtained possession of Oudh and Gwalior,

#### The Mogul Dynasty.



In 1572 he marched in person into Gujarat, defeated the last of the independent sultans of Ahmedabad, and formed the province into a Mogul viceroyalty or subah. In the same year his generals drove out the Afghans from Bengal, and reunited the lower valley of the Ganges to Hindustan. Akbar was then the undisputed ruler of a larger portion of India than had ever before acknowledged the sway of one man. But he continued to extend his conquests throughout his lifetime. In 1578 Orissa was annexed to Bengal by his Hindu general Todar Mall, who forthwith organized a revenue survey of the whole province. Kabul submitted in 1581, Kashmir in 1587, Sind in 1592, and Kandahar in 1594. At last he turned his arms against the Mahommedan kings of the Deccan, and wrested from them Berar; but the permanent conquest of the south was reserved for Aurangzeb.

If the history of Akbar were confined to this long list of conquests, his name would on their account alone find a high place among those which mankind delights to remember. But it is as a civil administrator that his reputation is cherished in India to the present day. With regard to the land revenue, the essence of his procedure was to fix the amount which the cultivators should pay at one-third of the gross produce, leaving it to their option to pay in money or in kind. The total land revenue received by Akbar amounted to about 16½ millions sterling. Comparing the area of his empire with the corresponding area now under the British, it has been calculated that Akbar, three hundred years ago, obtained 15½ millions where they obtain only 13½ millions—an amount representing not more than one-half the purchasing power of Akbar's 15½ millions. The distinction between *khalisa* land, or the imperial demesne, and *jagir* lands, granted revenue free or at quit rent in reward for services, also dates from the time of Akbar. As regards his military system, Akbar invented a sort of feudal organization, by which every tributary raja took his place by the side of his own Mogul nobles. In theory it was an aristocracy based only upon military command; but practically it accomplished the object at which it aimed by incorporating the hereditary chiefships of Rajputana among the mushroom creations of a Mahommedan despotism. Mussulmans and Hindus were alike known only as *mansabdars* or commanders of so many horse, the highest title being that of *amir*, of which the plural is *umrah* or *omrah*. The third and last of Akbar's characteristic measures were those connected with religious innovation, about which it is difficult to speak with precision. The necessity of conciliating the proud warriors of Rajputana had taught him toleration from his earliest days. His favourite wife was a Rajput princess, and another wife is said to have been a Christian. Out of four hundred and fifteen of his *mansabdars* whose names are recorded, as many as fifty-one were Hindus. Starting from the broad ground of general toleration, Akbar was gradually led on by the stimulus of cosmopolitan discussion to question the truth of his inherited faith. The counsels of his friend Abul Fazl, coinciding with that sense of superhuman omnipotence which is bred of despotic power, led him at last to promulgate a new state religion, based upon natural theology, and comprising the best practices of all known creeds. In this strange faith Akbar himself was the prophet, or rather the head of the church. Every morning he worshipped the sun in public, as being the representative of the divine soul that animates the universe, while he was himself worshipped by the ignorant multitude.

Akbar died in 1605, in his sixty-third year. He lies buried beneath a plain slab in the magnificent mausoleum which he had reared at Sikandra, near his capital of Agra. As his name is still cherished in India, so his tomb is still honoured, being covered by a cloth presented by Lord Northbrook when viceroy in 1873.

The reign of Jahangir, his son, extended from 1605 to 1627. It is chiefly remarkable for the influence exercised over the emperor by his favourite wife, surnamed Nur Jahan. The currency was struck in her name, and in her hands centred all the intrigues that made up the work of administration. She lies buried by the side of her husband at Lahore, whither the

seat of government had been moved by Jahangir, just as Akbar had previously transferred it from Delhi to Agra. It was in the reign of Jahangir that the English first established themselves at Surat, and also sent their first embassy to the Mogul court.

Jahangir was succeeded by his son Shah Jahan, who had rebelled against his father, as Jahangir had rebelled against Akbar. Shah Jahan's reign is generally regarded as the period when the Mogul empire attained its greatest magnificence, though not its greatest extent of territory. He founded the existing city of Delhi, which is still known to its Mahommedan inhabitants as Shahjahanabad. At Delhi also he erected the celebrated peacock throne; but his favourite place of residence was Agra, where his name will ever be associated with the marvel of Indian architecture, the Taj Mahal. That most chaste and most ornamental of buildings was erected by Shah Jahan as the mausoleum of his favourite wife Mumtaz Mahal, and he himself lies by her side (see AGRA). Shah Jahan had four sons, whose fratricidal wars for the succession during their father's lifetime it would be tedious to dwell upon. Suffice it to say that Aurangzeb, by mingled treachery and violence, supplanted or overthrew his brothers and proclaimed himself emperor in 1658, while Shah Jahan was yet alive.

Aurangzeb's long reign, from 1658 to 1707, may be regarded as representing both the culminating point of Mogul power and the beginning of its decay. Unattractive as his character was, it contained at least some elements of greatness. None of his successors on the throne was any thing higher than a debauchee or a puppet. He was the first to conquer the independent sultans of the Deccan, and to extend his authority to the extreme south. But even during his lifetime two new Hindu nationalities were being formed in the Mahrattas and the Sikhs; while immediately after his death the nawabs of the Deccan, of Oudh, and of Bengal raised themselves to practical independence. Aurangzeb had indeed enlarged the empire, but he had not strengthened its foundations. During the reign of his father Shah Jahan he had been viceroy of the Deccan or rather of the northern portion only, which had been annexed to the Mogul empire since the reign of Akbar. His early ambition was to conquer the Mahommedan kings of Bijapur and Golconda, who, since the downfall of Vijayanagar, had been practically supreme over the south.

This object was not accomplished without many tedious campaigns, in which Sivaji, the founder of the Mahratta confederacy, first comes upon the scene. In name Sivaji was a feudatory of the house of Bijapur, on whose behalf he held the rock-forts of his native Ghats; but in fact he found his opportunity in playing off the Mahommedan powers against one another, and in rivalling Aurangzeb himself in the art of treachery. In 1680 Sivaji died, and his son and successor, Sambhaji, was betrayed to Aurangzeb and put to death. The rising Mahratta power was thus for a time checked, and the Mogul armies were set free to operate in the eastern Deccan. In 1686 the city of Bijapur was taken by Aurangzeb in person, and in the following year Golconda also fell. No independent power then remained in the south, though the numerous local chieftains, known as *palegars* and *naiks*, never formally submitted to the Mogul empire. During the early years of his reign Aurangzeb had fixed his capital at Delhi, while he kept his dethroned father, Shah Jahan, in close confinement at Agra. In 1682 he set out with his army on his victorious march into the Deccan, and from that time until his death in 1707 he never again returned to Delhi. In this camp life Aurangzeb may be taken as representative of one aspect of the Mogul rule, which has been picturesquely described by European travellers of that day. They agree in depicting the emperor as a peripatetic sovereign, and the empire as held together by its military highways no less than by the strength of its armies. The Grand Trunk road running across the north of the peninsula, is generally attributed to the Afghan usurper, Sher Shah: The other roads branching out southward from Agra, to Surat and Burhanpur and Golconda, were

Shah Jahan.

Aurangzeb.

Rise of Mahratta power.

undoubtedly the work of Mogul times. Each of these roads was laid out with avenues of trees, with wells of water, and with frequent *sarāis* or rest-houses. Constant communication between the capital and remote cities was maintained by a system of foot-runners, whose aggregate speed is said to have surpassed that of a horse. Commerce was conducted by means of a caste of bullock-drivers, whose occupation in India is hardly yet extinct.

On the death of Aurangzeb in 1707, the decline of the Mogul empire set in with extraordinary rapidity. Ten emperors after

Aurangzeb are enumerated in the chronicles, but none of them has left any mark on history. His son and successor was Bahadur Shah, who reigned only five years. Then followed in order three sons of Bahadur Shah, whose united reigns occupy only five years more. In 1739 Nadir Shah of Persia, the sixth and last of the great Mahomedan conquerors of India, swept like a whirlwind over Hindustan, and sacked the imperial city of Delhi. Thenceforth the Great Mogul became a mere name, though the hereditary succession continued unbroken down to the time of the Mutiny. Real power had passed into the hands of Mahomedan courtiers and Mahratta generals, both of whom were then carving for themselves kingdoms out of the dismembered empire, until at last British authority placed itself supreme over all. From the time of Aurangzeb no Mussulman, however powerful, dared to assume the title of sultan or emperor, with the single exception of Tippee's brief paroxysm of madness. The name of *nawāb*, corrupted by Europeans into "nabob," appears to be an invention of the Moguls to express delegated authority, and as such it is the highest title conferred upon Mahomedans at the present day, as *maharaja* is the highest title conferred upon Hindus. At first nawabs were only found in important cities, such as Surat and Dacca, with the special function of administering civil justice; criminal justice was in the hands of the *kotwal*. The corresponding officials at that time in a large tract of country were the *subahdar* and the *faujdar*. But the title of subahdar, or viceroy, gradually dropped into desuetude, as the paramount power was shaken off, and nawab became a territorial title with some distinguishing adjunct. During the troubled period of intrigue and assassination that followed on the death of Aurangzeb, two Mahomedan foreigners rose to high position as courtiers and generals, and succeeded in transmitting their power to their sons. The one was Chin Kulich Khan, also called Asaf Jah, and still more commonly Nizam-ul-Mulk, who was of Turkoman origin, and belonged to the Sunni sect. His independence at Hyderabad in the Deccan dates from 1712. The other was Saadat Ali Khan, a Persian, and therefore a Shiaah, who was appointed subahdar or nawab of Oudh about 1720. Thenceforth these two important provinces paid no more tribute to Delhi, though their hereditary rulers continued to seek formal recognition from the emperor on their succession. The Mahrattas were in possession of the entire west and great part of the centre of the peninsula; while the rich and unwarlike province of Bengal, though governed by an hereditary line of nawabs founded by Murshid Kuli Khan in 1704, still continued to pour its wealth into the imperial treasury. The central authority never recovered from the invasion of Nadir Shah in 1739, who carried off plunder variously estimated at from 8 to 30 millions sterling. The Mahrattas closed round Delhi from the south, and the Afghans from the west. The victory of Panipat, won by Ahmad Shah Durani over the united Mahrattā confederacy in 1761, gave the Mahomedans one more chance of rule. But Ahmad Shah had no ambition to found a dynasty of his own, nor were the British in Bengal yet ready for territorial conquest.

Shah Alam, the lineal heir of the Mogul line, was thus permitted to ascend the throne of Delhi, where he lived during the great part of a long life as a puppet in the hands of Mahadji Sindhia. He was succeeded by Akbar II., who lived similarly under the shadow of British protection. Last of all came Bahadur Shah, who atoned for his association with the mutineers in 1857 by banish-

ment to Burma. Thus ended the Mogul line, after a history which covers three hundred and thirty years. Mahomedan rule remodelled the revenue system, and has left behind fifty millions of Mussulmans in British India.

#### *Early European Settlements.*

Mahomedan invaders have always entered India from the north-west. Her new conquerors approached from the sea and from the south. From the time of Alexander to that of Vasco da Gama, Europe had enjoyed little direct intercourse with the East. An occasional traveller brought back stories of powerful kingdoms and of untold wealth; but the passage by sea was unthought of, and by land many wide deserts and warlike tribes lay between. Commerce, indeed, never ceased entirely, being carried on chiefly by the Italian cities on the Mediterranean, which traded to the ports of the Levant. But to the Europeans of the 15th century India was practically an unknown land, which powerfully attracted the imagination of spirits stimulated by the Renaissance and ardent for discovery. In 1492 Christopher Columbus set sail under the Spanish flag to seek India beyond the Atlantic, bearing with him a letter to the great khan of Tartary. The expedition under Vasco da Gama started from Lisbon five years later, and, doubling the Cape of Good Hope, cast anchor off the city of Calicut on the 20th of May 1498, after a prolonged voyage of nearly eleven months. From the first da Gama encountered hostility from the "Moors," or rather Arabs, who monopolized the sea-borne trade; but he seems to have found favour with the zamorin, or Hindu raja of Malabar. It may be worth while to recall the contemporary condition of India at that epoch. An Afghan of the Lodi dynasty was on the throne of Delhi, and another Afghan king was ruling over Bengal. Ahmedabad in Gujarat, Gulbarga, Bijapur, Ahmednagar and Ellichpur in the Deccan were each the capital of an independent Mahomedan kingdom; while the Hindu raja of Vijayanagar was recognized as paramount over the entire south. Neither Mogul nor Mahrattā had yet appeared above the political horizon.

After staying nearly six months on the Malabar coast, da Gama returned to Europe by the same route as he had come, bearing with him the following letter from the zamorin to the king of Portugal: "Vasco da Gama, a nobleman of your household, has visited my kingdom and has given me great pleasure. In my kingdom there is abundance of cinnamon, cloves, ginger, pepper, and precious stones. What I seek from thy country is gold, silver, coral, and scarlet." The arrival of da Gama at Lisbon was celebrated with national rejoicings scarcely less enthusiastic than had greeted the return of Columbus. If the West Indies belonged to Spain by priority of discovery, Portugal might claim the East Indies by the same right. Territorial ambition combined with the spirit of proselytism and with the greed of commerce to fill all Portuguese minds with the dream of a mighty Oriental empire. The early Portuguese discoverers were not traders or private adventurers, but admirals with a royal commission to conquer territory and promote the spread of Christianity. A second expedition, consisting of thirteen ships and twelve hundred soldiers, under the command of Cabral, was despatched in 1500. "The sum of his instructions was to begin with preaching, and, if that failed, to proceed to the sharp determination of the sword." On his outward voyage Cabral was driven by stress of weather to the coast of Brazil. Ultimately he reached Calicut, and established factories both there and at Cochin, in the face of active hostility from the natives. In 1502 the king of Portugal obtained from Pope Alexander VI. a bull constituting him "lord of the navigation, conquest, and trade of Ethiopia, Arabia, Persia, and India." In that year Vasco da Gama sailed again to the East, with a fleet numbering twenty vessels. He formed an alliance with the rajās of Cochin and Cannanore against the zamorin of Calicut, and bombarded the latter in his palace. In 1503 the great Alfonso d'Albuquerque is first heard of, as in command of one of three expeditions from Portugal. In 1505 a large fleet of twenty sail and fifteen hundred men was

*Decline of  
Mogul  
Empire.*

*Portu-  
guese  
expedi-  
tions.*

*End of  
Mogul  
line.*

sent under Francisco de Almeida, the first Portuguese viceroy of India. In 1509 Albuquerque succeeded as governor, and widely extended the area of Portuguese influence. Having failed in an attack upon Calicut, he seized Goa, which from 1530 became the capital of Portuguese India. Then, sailing round Ceylon, he captured Malacca, the key of the navigation of the Indian archipelago, and opened a trade with Siam and the Spice Islands (Moluccas). Lastly, he sailed back westwards, and, after penetrating into the Red Sea, and building a fortress at Ormuz in the Persian Gulf, returned to Goa only to die in 1515. In 1524 Vasco da Gama came out to the East for the third time, and he too died at Cochim.

For exactly a century, from 1500 to 1600, the Portuguese enjoyed a monopoly of Oriental trade.

Their three objects were conquest, commerce and conversion, and for all three their position on the Malabar coast strip was remarkably well adapted. Shut off by the line of the Ghats from Mahomedan India of that day, they were able to dominate the petty chiefs of Malabar, who welcomed maritime commerce, and allowed religious freedom in their domains. Their trade relations with Vijayanagar were very close, when that great empire was at the height of its power; but in 1564 Vijayanagar went down before the five Mahomedan states of southern India on the field of Talikota, and with its fall began the decline of Portugal. During the whole of the 16th century the Portuguese disputed with the Mahomedans the supremacy of the Indian seas, and the antagonism between Christianity and Islam became gradually more intense, until the Portuguese power assumed a purely religious aspect. In 1560 the Inquisition with all its horrors was introduced into Goa. But Portugal was too small a country to keep up the struggle for long. The drain of men told upon her vitality, their quality deteriorated, and their bigotry and intolerance raised even a fiercer opposition to them within the bounds of India; and as the Dutch and British came into prominence the Portuguese gradually faded away. In 1603 and 1639 the Dutch blockaded Goa; during the first half of the 17th century they routed the Portuguese everywhere in India, Ceylon and Java. Similarly in 1611 the British defeated them off Cambay and in 1615 won a great victory at Swally. After the middle of the 17th century the Asiatic trade of Portugal practically disappeared, and now only Goa, Daman and Diu are left to her as relics of her former greatness.

The Dutch were the first European nation to break through the Portuguese monopoly. During the 16th century Bruges, Antwerp and Amsterdam became the great emporia whence Indian produce, imported by the Portuguese, was distributed to Germany and even to England.

At first the Dutch, following in the track of the English, attempted to find their way to India by sailing round the north coasts of Europe and Asia. William Barents is honourably known as the leader of three of these arctic expeditions, in the last of which he perished. The first Dutchman to double the Cape of Good Hope was Cornelius Houtman, who reached Sumatra and Bantam in 1596. Forthwith private companies for trade with the East were formed in many parts of the United Provinces, but in 1602 they were all amalgamated by the states-general into "The United East India Company of the Netherlands." Within a few years the Dutch had established factories on the continent of India, in Ceylon, in Sumatra, on the Persian Gulf and on the Red Sea, besides having obtained exclusive possession of the Moluccas. In 1618 they laid the foundation of the city of Batavia in Java, to be the seat of the supreme government of the Dutch possessions in the East Indies. At about the same time they discovered the coast of Australia, and in North America founded the city of New Amsterdam or Manhattan, now New York. During the 17th century the Dutch maritime power was the first in the world. The massacre of Amboyna in 1623 led the English East India Company to retire from the Eastern seas to the continent of India, and thus, though indirectly, contributed to the foundation of the British Indian empire. The long naval wars and bloody battles between

the English and the Dutch within the narrow seas were not terminated until William of Orange united the two crowns in 1689. In the far East the Dutch ruled without a rival, and gradually expelled the Portuguese from almost all their territorial possessions. In 1635 they occupied Formosa; in 1641 they took Malacca, a blow from which the Portuguese never recovered; in 1652 they founded a colony at the Cape of Good Hope, as a half-way station to the East; in 1658 they captured Jaffna, the last stronghold of the Portuguese in Ceylon; by 1664 they had wrested from the Portuguese all their earlier settlements on the pepper-bearing coast of Malabar.

The rapid and signal downfall of the Dutch colonial empire is to be explained by its short-sighted commercial policy. It was deliberately based upon a monopoly of the trade in spices, and remained from first to last destitute of the true imperial spirit. Like the Phoenicians of old, the Dutch stopped short of no acts of cruelty towards their rivals in commerce; but, unlike the Phoenicians, they failed to introduce a respect for their own higher civilization among the natives with whom they came in contact. The knell of Dutch supremacy was sounded by Clive, when in 1758 he attacked the Dutch at Chinsura both by land and water, and forced them to an ignominious capitulation. In the great French war from 1781 to 1811 England wrested from Holland every one of her colonies, though Java was restored in 1816 and Sumatra in exchange for Malacca in 1824. At the present time the Dutch flag flies nowhere on the mainland of India, though the quaint houses and regular canals at Chinsura, Negapatam, Jaffna, and many petty ports on the Coromandel and Malabar coasts remind the traveller of familiar scenes in the Netherlands.

The earliest English attempts to reach the East were the expeditions under John Cabot in 1497 and 1498. Their objective was not so much India as Japan (Cipangu), of which they only knew vaguely as a land of spices and silks, and which they hoped to reach by sailing westward. They failed, but discovered Newfoundland, and sailed along the coast of America from Labrador to Virginia. In 1553 the ill-fated Sir Hugh Willoughby attempted to force a passage along the north of Europe and Asia. Sir Hugh himself perished miserably, but his second in command, Chancellor, reached a harbour on the White Sea, now Archangel. Thence he penetrated by land to the court of the grand-duke of Moscow, and laid the foundation of the Russia Company for carrying on the overland trade with India through Persia, Bokhara and Moscow. Many subsequent attempts were made at the North-West Passage from 1576 to 1616, which have left on our modern maps the imperishable names of Frobisher, Davis, Hudson and Baffin. Meanwhile, in 1577, Sir Francis Drake had circumnavigated the globe, and on his way home had touched at Ternate, one of the Moluccas, the king of which island agreed to supply the English nation with all the cloves it produced. The first Englishman who actually visited India was Thomas Stephens in 1579. He had been educated at Winchester, and became rector of the Jesuits' College in Goa. His letters to his father are said to have roused great enthusiasm in England to trade directly with India. In 1583 four English merchants, Ralph Fitch, John Newbery, William Leedes and James Story, went out to India overland as mercantile adventurers. The jealous Portuguese threw them into prison at Ormuz, and again at Goa. At length Story settled down as a shopkeeper at Goa, Leedes entered the service of the Great Mogul, Newbery died on his way home overland, and Fitch, after a lengthened peregrination in Bengal, Pegu, Siam and other parts of the East Indies, returned to England.

The defeat of the "Invincible Armada" in 1588, at which time the crowns of Spain and Portugal were united, gave a fresh stimulus to maritime enterprise in England; and the successful voyage of Cornelius Houtman in 1596 showed the way round the Cape of Good Hope into waters hitherto monopolized by the Portuguese. The "Governor and Company of Merchants of London trading into the East Indies" was founded by Queen Elizabeth

*Decline of the Portuguese.*

*Decline of the Dutch.*

*British expeditions.*

*Dutch settlements.*

*East India Company.*

on the 31st of December 1600, and the first expedition of four ships under James Lancaster left Torbay towards the end of April 1601, and reached Achin in Sumatra on the 5th of June 1602, returning with a cargo of spices. Between 1600 and 1612 there were twelve separate voyages, but in the latter year a joint-stock system began involving continual communication with the Indies. At first the trade was mainly with the Indian archipelago, but soon the English began to feel their way towards the mainland of India itself. In 1608 Captain Hawkins visited Jahangir at Agra, and obtained permission to build a factory at Surat, which was subsequently revoked, and in 1609 some English merchants obtained an unstable footing at Surat. Wherever the English went they were met by the hostility of the Portuguese; and on the 29th of November 1612 the Portuguese admiral with four ships attempted to capture the English vessels under Captain Best at Swally, off the mouth of the Tapti river; but the Portuguese were severely defeated, to the great astonishment of the natives, and that action formed the beginning of British maritime supremacy in Indian seas. The first fruits of the victory were the foundation of a factory at Surat and at other places round the Gulf of Cambay and in the interior. From the imperial firman of December 1612 dates the British settlement on the mainland of India. At this point begins the Indian history of the company, for the domestic history of which see EAST INDIA COMPANY.

The ten years that elapsed between the battle of Swally in 1612 and the British capture of Ormuz in 1622 sufficed to decide the issue in the struggle for supremacy between the British and the Portuguese. The latter, unwillingly linked to the dying power of Spain, were already decadent, and on the 20th of January 1615 a great Portuguese armada, consisting of six great galleons, three smaller ships, two galleys and sixty rowed barges, was defeated for the second time in Swally roads by Captain Nicholas Downton, in command of four British vessels. In 1618 the English opened trade between Surat and Jask in the Persian Gulf, and in 1620 gained a victory over the Portuguese fleet there. Early in 1622 the English fleet gained a second decisive victory, and captured Ormuz, the pearl of the Portuguese possessions in Asia. From this date onwards India and the Persian Gulf lay open to the English as far as Portugal was concerned, and before Portugal broke loose from Spain in 1640 her supremacy in Asiatic seas was hopelessly lost. In 1642 she partially and in 1654 finally accepted the situation, and opened all her Eastern possessions to English trade.

The struggle with the young and growing power of Holland was destined to be a much more serious affair than that with the exhausted power of Portugal. The Dutch had just emerged victorious from the struggle with Spain, and were pulsing with national life. In 1602 the Dutch routed the Portuguese near Bantam, and opened the road to the Spice Islands. In 1603 they threatened Goa, in 1610 they fixed their capital at Batavia, in 1638 they drove the Portuguese from Ceylon and in 1641 from Malacca. When Portugal emerged in 1640 from her sixty years' captivity to Spain, she found that her power in the Eastern seas had passed to the Dutch, and thenceforward the struggle lay between the Dutch and the English. The Dutch were already too strongly entrenched in the Indian archipelago for English competition to avail there, and the intense rivalry between the two nations led to the tragedy of Amboyna in 1623, when Governor Van Speult put to torture and death nine Englishmen on a charge of conspiring to take the Dutch forts. This outrage was not avenged until the time of Cromwell (1654), and in the meantime the English abandoned the struggle for the Spice Islands, and turned their attention entirely to the mainland of India. In 1616 the Dutch began to compete with the English at Surat, and their piracies against native vessels led to the Mogul governor seizing English warehouses; but soon the native authorities learnt to discriminate between the different European nations, and the unscrupulous methods of the Dutch cast them into disfavour.

*Rivalry with the Dutch.*

In 1611 Captain Hippon in the seventh separate voyage essayed a landing at Pulicat, but was driven off by the Dutch, who were already settled there, and sailed farther up the coast to Pettapatt, where he founded the first English settlement in the Bay of Bengal, which finally perished through pestilence in 1687. Captain Hippon, however, also touched at Masulipatam, the chief seaport of the kings of Golconda. In 1628 the Dutch won over the native governor there, and the English were compelled to retreat to Armagon, where they built the first English fort in India. In 1639 Francis Day, the chief at Armagon, founded Madras, building Fort St George (1649), and transferring thither the chief factory from Masulipatam. Here the English obtained their first grant of Indian soil, apart from the plots on which their factories were built. In 1653 Madras was raised to an independent presidency, and in 1658 all the settlements in Bengal and on the Coromandel coast were made subordinate to Fort St George.

*Madras settlements.*

In 1633 eight Englishmen from Masulipatam, under Ralph Cartwright, sailed northward to Harishpur near Cuttack on the mouth of the Mahanadi, and entered into negotiations to trade with the governor of Orissa; and in June 1633 Cartwright founded a factory at Balasore, which proved very unhealthy. In 1651 the English reached Hugli, which was at that time the chief port of Bengal; about that year Gabriel Boughton, a surgeon, obtained from the Mogul viceroy permission for the English to trade in Bengal. In 1657 Hugli became the head agency in Bengal, with Balasore and Cossimbazar in the Gangetic delta and Patna in Behar under its control. In that year the name of Job Charnock, the future founder of Calcutta, appeared in the lowest grade of the staff.

*Bengal settlements.*

The company had long fixed an eye on Bombay. Its position half way down the Indian seaboard gave it both strategic and commercial importance, while it lay beyond the authority of the Moguls, and so could be fortified without offending them. In 1626 the company joined with the Dutch under Van Speult in attacking Bombay, but could not retain possession. In 1661 Charles II. received Bombay from Portugal as part of the Infanta Catherine's dowry, but effective possession was not taken until 1665, and in 1668 Charles handed the island over to the company. At first the loss of life, owing to the unhealthiness of the climate, was appalling; but in spite of that fact it gradually prospered, until it reached its present position as the second port and city of India. In 1670 Gerald Aungier fortified the island, and so became the true founder of its prosperity. In 1674 a treaty was entered into with Sivaji. In 1682 Sir Josiah Child at home and Sir John Child in India formed a combination, which recognized that in the struggle between the Mogul and the Maharrattas the English must meet force with force; and in 1687 Bombay supplanted Surat as the chief seat of the English in India.

*Acquisition of Bombay.*

In 1664 Shaista Khan, the brother of the empress Nur Jahan, became viceroy of Bengal, and though a strong and just ruler from the native point of view, was not favourable to the foreign traders. In 1677 the president of Madras had to warn him that unless his exactions ceased, the company would be obliged to withdraw from Bengal. In 1679 the English obtained from the Mogul emperor a firman exempting them from dues everywhere except at Surat; but Shaista Khan refused to recognize the document, and on the 14th of January 1686 the court of directors resolved to have recourse to arms to effect what they could not obtain by treaty. This was the first formal repudiation of the doctrine of unarmed traffic laid down by Sir Thomas Roe in 1616. An expedition was despatched to India consisting of six companies of infantry and ten ships under Captain Nicholson. Two of the ships with 308 soldiers arrived at the Hugli river in the autumn of 1686. At this time Job Charnock was the chief of the Bengal council, and, owing to an affair with the Mogul troops at Hugli on the 28th of October 1686, he embarked the company's goods and servants on board light vessels and dropped down the

*The founding of Calcutta.*

river to Sutanati, the site of the modern Calcutta. At this place, about 70 m. from the sea and accessible at high tide to heavily armed ships, the stream had scooped for itself a long deep pool, now Calcutta harbour, while the position was well chosen to make a stand against the Bengal viceroy. On the 20th of December 1686 Charnock first settled at Calcutta, but in the following February Shaista Khan despatched an army against him, and he was forced to drop farther down the river to Hijili. In June Charnock was obliged to make an honourable capitulation, and returned to Ulubaria, 16 m. below Calcutta, thence moving in September to Calcutta for the second time. On the 8th of November 1688 Captain Heath arrived with orders from England, and took away Charnock against his will; but after peace was restored between the Mogul emperor and the company in February 1690, Charnock returned to Calcutta for the third and last time on the 24th of August of that year. It was thus by his courage and persistence that the modern capital of India was eventually founded. As the result of the war with the Mogul empire, which lasted from 1686 to 1690, the company perceived that a land war was beyond their strength, but their sea-power could obtain them terms by blockading the customs ports and threatening the pilgrim route to Mecca. From this time onwards they saw that they could no longer trust to defenceless factories. During this first period of their dealings with India the aims of the British were purely those of traders, without any aspirations to military power or territorial aggrandizement; but in the period that followed, the gradual decay of the Mogul empire from within, and the consequent anarchy, forced the English to take up arms in their own defence, and triumphing over one enemy after another they found themselves at last in the place of the Moguls.

#### *India under the Company.*

The political history of the British in India begins in the 18th century with the French wars in the Carnatic. The British at Fort St George and the French at Pondicherry for many years traded side by side without either active rivalry or territorial ambition. The British, especially, appear to have been submissive to the native powers at Madras no less than in Bengal. They paid their annual rent of 1200 pagodas (say £500) to the deputies of the Mogul empire when Aurangzeb annexed the south, and on two several occasions bought off a besieging army with a heavy bribe.

On the death of Aurangzeb in 1707, the whole of southern India became practically independent of Delhi. In the Deccan proper, the Nizam-ul-Mulk founded an independent dynasty, with Hyderabad for its capital, which exercised a nominal sovereignty over the entire south. The Carnatic, or the lowland tract between the central plateau and the eastern sea, was ruled by a deputy of the nizam, known as the nawab of Arcot, who in his turn asserted claims to hereditary sovereignty. Farther south, Trichinopoly was the capital of a Hindu raja, and Tanjore formed another Hindu kingdom under a degenerate descendant of the line of Sivaji. Inland, Mysore was gradually growing into a third Hindu state, while everywhere local chieftains, called *palegars* or *naiks*, were in semi-independent possession of citadels or hill-forts.

In that condition of affairs the flame of war was kindled between the British and the French in Europe in 1745. Dupleix was at that time governor of Pondicherry and Clive was a young writer at Madras. A British fleet first appeared on the Coromandel coast, but Dupleix by a judicious present induced the nawab of Arcot to interpose and prevent hostilities. In 1746 a French squadron arrived, under the command of La Bourdonnais. Madras surrendered almost without a blow, and the only settlement left to the British was Fort St David, a few miles south of Pondicherry, where Clive and a few other fugitives sought shelter. The nawab, faithful to his policy of impartiality, marched with 10,000 men to drive the French out of Madras, but he was signally defeated by a French force of only four hundred men and two guns. In 1748 a British fleet arrived

under Admiral Boscawen and attempted the siege of Pondicherry, while a land force co-operated under Major Stringer Lawrence, whose name afterwards became associated with that of Clive. The French successfully repulsed all attacks, and at last peace was restored by the treaty of Aix-la-Chapelle, which gave back Madras to the British (1748).

The first war with the French was merely an incident in the greater contest in Europe. The second war had its origin in Indian politics, while England and France were at *Clive*. peace. The easy success of the French arms had inspired Dupleix with the ambition of founding a French empire in India, under the shadow of the existing Mahomedan powers. Disputed successions at Hyderabad and at Arcot supplied his opportunity. On both thrones he placed nominees of his own, and for a short time posed as the supreme arbiter of the entire south. In boldness of conception, and in knowledge of Oriental diplomacy, Dupleix has had probably no rival. But he was no soldier, and he was destined in that sphere to encounter the "heaven-born genius" of Clive. For the British of Madras, under the instinct of self-preservation, were compelled to maintain the cause of another candidate to the throne of Arcot, in opposition to the nominee of Dupleix. This candidate was Mahomed Ali, afterwards known in history as Wala-Jah. The war that then ensued between the French and British, each with their native allies, has been exhaustively described in the pages of Orme. The one incident that stands out conspicuously is the capture and subsequent defence of Arcot by Clive in 1751. This heroic feat, even more than the battle of Plassey, established the reputation of the British for valour throughout India. Shortly afterwards Clive returned to England in ill-health, but the war continued fitfully for many years. On the whole, British influence predominated in the Carnatic, and their candidate, Mahomed Ali, maintained his position at Arcot. But the French were no less supreme in the Deccan, whence they were able to take possession of the coast tract called "the Northern Circars." The final struggle was postponed until 1760, when Colonel (afterwards Sir Eyre) Coote won the decisive victory of Wandiwash over the French general Lally, and proceeded to invest Pondicherry, which was starved into capitulation in January 1761. A few months later the hill-fortress of Gingee (Chenji) also surrendered. In the words of Orme, "That day terminated the long hostilities between the two rival European powers in Coromandel, and left not a single ensign of the French nation avowed by the authority of its Government in any part of India."

Meanwhile the interest of history shifts with Clive to Bengal. At the time of Aurangzeb's death in 1707 the nawab or governor of Bengal was Murshid Kuli Khan, known also as Jafar Khan. By birth a Brahman, and brought up as a slave in Persia, he united the administrative ability of a Hindu to the fanaticism of a renegade. Hitherto the capital of Bengal had been at Dacca on the eastern frontier of the empire, whence the piratical attacks of the Portuguese and of the Arakanese or Mughs could be most easily checked. Murshid Kuli Khan transferred his residence to Murshidabad, in the neighbourhood of Cossimbazar, the river port of all the Ganges trade. The British, the French and the Dutch had each factories at Cossimbazar, as well as at Dacca, Patna and Malda. But Calcutta was the headquarters of the British, Chandernagore of the French, and Chinsura of the Dutch, all three towns being situated close to each other in the lower reaches of the Hugli, where the river is navigable for large ships. Murshid Kuli Khan ruled over Bengal prosperously for twenty-one years, and left his power to a son-in-law and a grandson. The hereditary succession was broken in 1740 by Ali Vardi Khan, who was the last of the great nawabs of Bengal. In his days the Mahratta horsemen began to ravage the country, and the British at Calcutta obtained permission to erect an earth-work, which is known to the present day as the Mahratta ditch. Ali Vardi Khan died in 1756, and was succeeded by his grandson, Suraj-ud-Dowlah, a youth of only nineteen years, whose ungovernable temper led to a rupture

with the British within two months after his accession. In pursuit of one of his own family who had escaped from his vengeance, he marched upon Calcutta with a large army. Many of the British fled down the river in their ships. The remainder surrendered after a feeble resistance, and were thrown as prisoners into the "black hole" or military jail of Fort William, a room 18 ft. by 14 ft. 10 in. in size, with only two small windows barred with iron. It was the month of June, in which the tropical heat of Calcutta is most oppressive. When the door of the prison was opened in the morning, only twenty-three persons out of one hundred and forty-six were found alive.

The news of this disaster fortunately found Clive returned to Madras, where also was a squadron of king's ships under Admiral Watson. Clive and Watson promptly sailed to the mouth of the Ganges with all the troops that could be got together. Calcutta was recovered with little fighting, and the nawab consented to a peace which restored to the company all their privileges, and gave them compensation for their losses of property. It is possible that matters might have ended here if a fresh cause of hostilities had not suddenly arisen. War had just been declared between the British and French in Europe, and Clive, following the traditions of his early warfare in the Carnatic, attacked and captured Chandernagore. Suraj-ud-Dowlah, exasperated by this breach of neutrality within his own dominions, took the side of the French. But Clive, again acting upon the policy he had learned from Duplex, had provided himself with a rival candidate to the throne. Undaunted, he marched out to the battlefield of Plassey (Palasi), at the head of about 900 Europeans and 2000 sepoy, with 8 pieces of artillery. The Mahomedan army is said to have consisted of 35,000 foot, 15,000 horse and 50 pieces of cannon. But there was a traitor in the Mahomedan camp in the person of Mir Jafar, who had married a sister of the late nawab, Ali Vardi Khan. The battle was short but decisive. After a few rounds of artillery fire, Suraj-ud-Dowlah fled, and the road to Murshidabad was left open.

The battle of Plassey was fought on the 23rd of June 1757, an anniversary afterwards remembered when the mutiny was at its height in 1857. History has agreed to adopt this date as the beginning of the British empire in the East; but the immediate results of the victory were comparatively small, and several more hard-won fights were fought before even the Bengalis would admit the superiority of the British arms. For the moment, however, all opposition was at an end. Clive, again following in the steps of Duplex, placed his nominee, Mir Jafar, upon the *masnad* at Murshidabad, being careful to obtain a patent of investiture from the Mogul court. Enormous sums were exacted from Mir Jafar as the price of his elevation. The company claimed 10,000,000 rupees as compensation for losses; for the British, the Armenian and the Indian inhabitants of Calcutta there were demanded the sums of 5,000,000, 2,000,000 and 1,000,000 rupees; for the squadron 2,500,000 rupees, and an equal sum for the army. The members of the council received the following amounts: Mr Drake, the governor, and Colonel Clive 280,000 rupees each; and Mr Becher, Mr Watts and Major Kilpatrick 240,000 rupees each. The whole amounted to £2,340,000. The British, deluded by their avarice, still cherished extravagant ideas of Indian wealth; nor would they listen to the unwelcome truth. But it was found that there were no funds in the treasury to satisfy their inordinate demands, and they were obliged to be contented with one-half the stipulated sums, which, after many difficulties, were paid in specie and in jewels, with the exception of \$84,905 rupees. The shares of the council were, however, paid in full. At the same time the nawab made a grant to the company of the *samindari* rights over an extensive tract of country round Calcutta, now known as the district of the Twenty-four Parganas. The area of this tract was about 882 sq. m., and it paid a revenue or quit rent of about £23,000. The gross rental at first payable to the company was £53,000, but within a period of ten years it had risen to £146,000. Originally the company possessed only the *samindari* rights, i.e. revenue jurisdiction. The superior lordship, or right

to receive the quit rent, remained with the nawab; but in 1759 this also was parted with by the nawab in favour of Clive, who thus became the landlord of his own masters, the company. At that time also Clive was enrolled among the nobility of the Mogul empire, with the rank of commander of 6000 foot and 5000 horse. Clive's  *jagir*, as it was called, subsequently became a matter of inquiry in England, and on his death it passed to the company, thus merging the *samindari* in the proprietary rights.

In 1758 Clive was appointed by the court of directors to be governor of all the company's settlements in Bengal. From two quarters troubles threatened, which perhaps Clive alone was capable of overcoming. On the west the shahzada or imperial prince, known afterwards as the emperor Shah Alam, with a mixed army of Afghans and Maharrattas, and supported by the nawab wazir of Oudh, was advancing his own claims to the province of Bengal. In the south the influence of the French under Lally and Bussy was overshadowing the British at Madras. But the name of Clive exercised a decisive effect in both directions. Mir Jafar was anxious to buy off the shahzada, who had already invested Patna. But Clive in person marched to the rescue, with an army of only 450 Europeans and 2500 sepoy, and the Mogul army dispersed without striking a blow. In the same year Clive despatched a force southwards under Colonel Forde, which captured Masulipatam from the French, and permanently established British influence throughout the Northern Circars, and at the court of Hyderabad. He next attacked the Dutch, the sole European nation that might yet be a formidable rival to the English. He defeated them by both land and water; and from that time their settlement at Chinsura existed only on sufferance.

From 1760 to 1765, while Clive was at home, the history of the British in Bengal contains little that is creditable. Clive had left behind him no system of government, but merely the tradition that unlimited sums of money might be extracted from the natives by the mere terror of the British name. In 1761 it was found expedient and profitable to dethrone Mir Jafar, the nawab of Murshidabad, and substitute his son-in-law, Mir Kasim, in his place. On that occasion, besides private donations, the British received a grant of the three districts of Burdwan, Midnapur and Chittagong, estimated to yield a net revenue of half a million sterling. But Mir Kasim proved to possess a will of his own, and to cherish dreams of independence. He retired from Murshidabad to Monghyr, a strong position on the Ganges, which commanded the only means of communication with Upper India. There he proceeded to organize an army, drilled and equipped after European models, and to carry on intrigues with the nawab wazir of Oudh. The company's servants claimed the privilege of carrying on private trade throughout Bengal, free from inland dues and all other imposts. The assertion of this claim caused frequent affrays between the customs' officers of the nawab and those traders who, whether falsely or not, represented that they were acting on behalf of the servants of the company. The nawab alleged that his civil authority was everywhere being set at naught. The majority of the council at Calcutta would not listen to his statements. The governor, Mr Vansittart, and Warren Hastings, then a junior member of council, attempted to effect some compromise. But the controversy had become too hot. The nawab's officers fired upon a British boat, and forthwith all Bengal was in a blaze. A force of 2000 sepoy was cut to pieces at Patna, and about 200 Englishmen in various parts of the province fell into the hands of the Mahomedans, and were subsequently massacred. But as soon as regular warfare commenced Mir Kasim met with no more successes. His trained regiments were defeated in two pitched battles by Major Adams, at Gheria and at Udha-nala, and he himself took refuge with the nawab wazir of Oudh, who refused to deliver him up. This led to a prolongation of the war. Shah Alam, who had now succeeded his father as emperor, and Shuja-ud-Daula, the nawab wazir of Oudh, united their forces, and threatened Patna, which the British had recovered. A more

Massacre  
of Patna.

formidable danger appeared in the British camp, in the form of the first sepoy mutiny. This was quelled by Major (afterwards Sir Hector) Munro, who ordered twenty-four of the ringleaders to be blown from guns, an old Mogul punishment. In 1764 Major Munro won the decisive battle of Buxar, which laid Oudh at the feet of the conquerors, and brought the Mogul emperor as a suppliant to the British camp.

Meanwhile the council at Calcutta had twice found the opportunity they desired of selling the government of Bengal to a new nawab. But in 1765 Clive (now Baron Clive of Clive's reforms. Plassey, in the peerage of Ireland) arrived at Calcutta, as governor of Bengal for the second time, to settle the entire system of relations with the native powers. Two objects stand out conspicuously in his policy. First, he sought to acquire the substance, though not the name, of territorial power, by using the authority of the Mogul emperor for so much as he wished, and for no more; and, secondly, he desired to purify the company's service by prohibiting illicit gains, and at the same time guaranteeing a reasonable remuneration from honest sources. In neither respect were the details of his plans carried out by his successors. But the beginning of the British administration of India dates from this second governorship of Clive, just as the origin of the British empire in India dates from his victory at Plassey. Clive's first step was to hurry up from Calcutta to Allahabad, and there settle in person the fate of half northern India. Oudh was given back to the nawab wazir, on condition of his paying half a million sterling towards the expenses of the war. The provinces of Allahabad and Kora, forming the lower part of the Doab, were handed over to Shah Alam himself, who in his turn granted to the company the *diwani* or financial administration of Bengal, Behar and Orissa, together with the Northern Circars. A puppet nawab was still maintained at Murshidabad, who received an annual allowance of about half a million sterling; and half that amount was paid to the emperor as tribute from Bengal. Thus was constituted the dual system of government, by which the British received all the revenues and undertook to maintain an army for the defence of the frontier, while the criminal jurisdiction vested in the nawab. In Indian phraseology, the company was *diwan* and the nawab was *nazim*. As a matter of general administration, the actual collection of the revenues still remained for some years in the hands of native officials. In attempting to reorganize and purify the company's service, Clive undertook a task yet more difficult than to partition the valley of the Ganges. The officers, civil and military alike, were all tainted with the common corruption. Their legal salaries were absolutely insignificant, but they had been permitted to augment them ten and a hundred-fold by means of private trade and gifts from the native powers. Despite the united resistance of the civil servants, and an actual mutiny of two hundred military officers, Clive carried through his reforms. Both private trade and the receipt of presents were absolutely prohibited for the future, while a substantial increase of pay was provided out of the monopoly of salt.

Lord Clive quitted India for the third and last time in 1767. Between that date and the arrival of Warren Hastings in 1772 nothing of importance occurred in Bengal beyond the terrible famine of 1770, which is officially reported to have swept away one-third of the inhabitants. The dual system of government, however, established by Clive, had proved a failure. Warren Hastings, a tried servant of the company, distinguished alike for intelligence, for probity and for knowledge of oriental manners, was nominated governor by the court of directors, with express instructions to carry out a predetermined series of reforms. In their own words, the court had resolved to "stand forth as diwan, and to take upon themselves, by the agency of their own servants, the entire care and administration of the revenues." In the execution of this plan, Hastings removed the exchequer from Murshidabad to Calcutta, and for the first time appointed European officers, under the now familiar title of collectors, to superintend the revenue collections and preside in the civil courts. The urgency of foreign affairs, and subsequently internal strife at the council table, hindered

Hastings from developing farther the system of civil administration, a task finally accomplished by Lord Cornwallis.

Though Hastings always prided himself specially upon that reform, as well as upon the improvements he introduced into the collection of the revenues from salt and opium, his name will be remembered in history for the boldness and success of his foreign policy. From 1772 to 1774 he was governor of Bengal; from 1774 to 1785 he was the first titular governor-general of India, presiding over a council nominated, like himself, not by the company, but by an act of parliament, known as the Regulating Act. In his domestic policy he was greatly hampered by the opposition of Sir Philip Francis; but, so far as regards external relations with Oudh, with the Mahrattas, and with Hyder Ali, he was generally able to compel assent to his own measures. His treatment of Oudh may here be passed over as not being material to the general history of India, while the personal aspects of his rule are discussed in a separate article (see HASTINGS, WARREN). To explain his Mahratta policy, it will be necessary to give a short retrospective sketch of the history of that people.

Sivaji the Great, as already mentioned, died in 1680, while Aurangzeb was still on the throne. The family of Sivaji produced no great names, either among those who continued to be the nominal chiefs of the Mahratta confederacy, with their capital at Satara, or among the rajas of Kolhapur and Tanjore. All real power passed into the hands of the peshwa, or Brahman minister, who founded in his turn an hereditary dynasty at Poona, dating from the beginning of the 18th century. Next rose several Mahratta generals, who, though recognizing the suzerainty of the peshwa, carved out for themselves independent kingdoms in different parts of India, sometimes far from the original home of the Mahratta race. Chief among these generals were the gaikwar in Gujarat, Sindhia and Holkar in Malwa, and the Bhonsla raja of Berar and Nagpur. At one time it seemed probable that the Mahratta confederacy would expel the Mahomedans even from northern India; but the decisive battle of Panipat, won by the Afghans in 1761, gave a respite to the Delhi empire. The Mahratta chiefs never again united heartily for a common purpose, though they still continued to be the most formidable military power in India. In especial, they dominated over the British settlement of Bombay on the western coast, which was the last of the three presidencies to feel the lust of territorial ambition. For more than a hundred years, from its acquisition in 1661 to the outbreak of the first Mahratta war in 1775, the British on the west coast possessed no territory outside the island of Bombay and their fortified factory at Surat.

The Bombay government was naturally emulous to follow the example of Madras and Bengal, and to establish its influence at the court of Poona by placing its own nominee upon the throne. The attempt took form in 1775 in the treaty of Surat, by which Raghunath Rao, one of the claimants to the throne of the peshwa, agreed to cede Salsette and Bassein to the British, in consideration of being himself restored to Poona. The military operations that followed are known as the first Mahratta War. Warren Hastings, who in his capacity of governor-general claimed a right of control over the decisions of the Bombay government, strongly disapproved of the treaty of Surat, but, when war once broke out, he threw the whole force of the Bengal army into the scale. One of his favourite officers, General Goddard, marched across the peninsula, and conquered the rich province of Gujarat almost without a blow. Another, Captain Popham, stormed the rock-fortress of Gwalior, which was regarded as the key of Hindustan. These brilliant successes atoned for the disgrace of the convention of Wargaoon in 1779, when the Mahrattas dictated terms to a Bombay force, but the war was protracted until 1782. It was then closed by the treaty of Salbai, which practically restored the *status quo*. Raghunath Rao, the English claimant, was set aside; Gujarat was restored, and only Salsette and some other small islands were retained by the English.

First  
Governor-  
General.

Rise  
of the  
Mahrattas.

Warren  
Hastings.

First  
Mahratta  
War.

Meanwhile Warren Hastings had to deal with a more formidable enemy than the Mahratta confederacy. The reckless conduct

of the Madras government had roused the hostility both of Hyder Ali of Mysore and of the nizam of the Deccan, the two strongest Mussulman powers in India, who attempted to draw the Mahrattas into an alliance against the British. The diplomacy of Hastings won over the nizam and the Mahratta raja of Nagpur, but the army of Hyder Ali fell like a thunderbolt upon the British possessions in the Carnatic. A strong detachment under Colonel Baillie was cut to pieces at Perambakam, and the Mysore cavalry ravaged the country unchecked up to the walls of Madras. For the second time the Bengal army, stimulated by the energy of Hastings, saved the honour of the British name. Sir Eyre Coote, the victor of Wandiwash, was sent by sea to relieve Madras with all the men and money available, while Colonel Pearse marched south overland to overawe the raja of Berar and the nizam. The war was hotly contested, for Sir Eyre Coote was now an old man, and the Mysore army was well-disciplined and equipped, and also skilfully handled by Hyder and his son Tippon. Hyder died in 1782, and peace was finally concluded with Tippon in 1784, on the basis of a mutual restitution of all conquests.

It was Warren Hastings's merit to organize the empire which Clive founded. He was governor or governor-general for thirteen years, a longer period than any of his successors.

During that time the British lost the American colonies, but in India their reputation steadily rose to its highest pitch. Within a year Hastings was succeeded by Lord Cornwallis, the first English nobleman of rank who undertook the office of governor-general. His rule lasted from 1786 to 1793, and is celebrated for two events—the introduction of the permanent settlement into Bengal and the second Mysore war. If the foundations of the system of civil administration were laid by Hastings, the superstructure was erected by Cornwallis. It was he who first entrusted criminal jurisdiction to Europeans, and established the Nizamat Sadr Adalat, or appellate court of criminal judicature, at Calcutta; and it was he who separated the functions of collector and judge. The system thus organized in Bengal was afterwards extended to Madras and Bombay, when those presidencies also acquired territorial sovereignty. But the achievement most familiarly associated with the name of Cornwallis is the permanent settlement of the land revenue of Bengal. Up to this time the revenue had been collected pretty much according to the old Mogul system. *Zamindars*, or government farmers, whose office always tended to become hereditary, were recognized as having a right of some sort to collect the revenue from the actual cultivators. But no principle of assessment existed, and the amount actually realized varied greatly from year to year. Hastings had the reputation of bearing hard upon the *zamindars*, and was absorbed in other critical affairs of state or of war. On the whole he seems to have looked to experience, as acquired from a succession of quinquennial settlements, to furnish the standard rate of the future. Francis, on the other hand, Hastings's great rival, deserves the credit of being among the first to advocate a limitation of the state demand in perpetuity. The same view recommended itself to the authorities at home, partly because it would place their finances on a more stable basis, partly because it seemed to identify the *zamindar* with the more familiar landlord. Accordingly, Cornwallis took out with him in 1787 instructions to introduce a permanent settlement. The process of assessment began in 1789 and terminated in 1791. No attempt was made to measure the fields or calculate the out-turn, as had been done by Akbar, and is now done when occasion requires in the British provinces; but the amount payable was fixed by reference to what had been paid in the past. At first the settlement was called decennial, but in 1793 it was declared permanent for ever. The total assessment amounted to *sikka* Rs. 26,800,980, or about 2½ millions sterling. Though Lord Cornwallis carried the scheme into execution, all praise or blame, so far as details are concerned, must belong to Sir

John Shore, afterwards Lord Teignmouth, whose knowledge of the country was unsurpassed by that of any civilian of his time. Shore would have proceeded more cautiously than Cornwallis's preconceived idea of a proprietary body and the court of directors' haste after fixity permitted.

The second Mysore War of 1790-92 is noteworthy on two accounts: Lord Cornwallis, the governor-general, led the British army in person, with a pomp and lavishness of supplies that recalled the campaigns of Aurangzeb; and the two great native powers, the nizam of the Deccan and the Mahratta confederacy, co-operated as allies of the British. In the result, Tippon Sultan submitted when Lord Cornwallis had commenced to beleague his capital. He agreed to yield one-half of his dominions to be divided among the allies, and to pay three millions sterling towards the cost of the war. Those conditions he fulfilled, but ever afterwards he burned to be revenged upon his conquerors.

The period of Sir John Shore's rule as governor-general, from 1793 to 1798, was uneventful. In 1798 Lord Mornington, better known as the marquis Wellesley, arrived in India, Wellesley already inspired with imperial projects that were destined to change the map of the country. Mornington was the friend and favourite of Pitt, from whom he is thought to have derived the comprehensiveness of his political vision and his antipathy to the French name. From the first he laid down as his guiding principle that the British must be the one paramount power in the peninsula, and that the native princes could only retain the insignia of sovereignty by surrendering the substance of independence. The subsequent political history of India has been but the gradual development of this policy, which received its finishing touch when Queen Victoria was proclaimed empress of India in 1877.

To frustrate the possibility of a French invasion of India, led by Napoleon in person, was the governing idea of Wellesley's foreign policy; for France at this time, and for many years later, filled the place afterwards occupied by Russia in the imagination of British statesmen. Nor was the possibility so remote as might now be thought. French regiments guarded and overawed the nizam of Hyderabad. The soldiers of Sindbia, the military head of the Mahratta confederacy, were disciplined and led by French adventurers: Tippon Sultan carried on a secret correspondence with the French directorate, and allowed a tree of liberty to be planted in his dominions. The islands of Mauritius and Bourbon afforded a convenient half-way house both for French intrigue and for the assembling of a hostile expedition. Above all, Napoleon Buonaparte was then in Egypt, dreaming of the conquests of Alexander; and no man knew in what direction he might turn his hitherto unconquered legions. Wellesley first addressed himself to the nizam, where his policy prevailed without serious opposition. The French battalions at Hyderabad were disbanded and the nizam bound himself by treaty not to take any European into his service without the consent of the British government—a clause since inserted in every engagement entered into with native powers. Next, the whole weight of Wellesley's resources was turned against Tippon, whom Cornwallis had defeated but not subdued. His intrigues with the French were laid bare, and he was given an opportunity of adhering to the new subsidiary system. On his refusal war was declared, and Wellesley came down in state to Madras to organize the expedition in person and watch over the course of events. One British army marched into Mysore from Madras, accompanied by a contingent from the nizam. Another advanced from the western coast. Tippon, after offering but a feeble resistance in the field, retired into Seringapatam, and, when his capital was stormed, died fighting bravely in the breach (1799). Since the battle of Plassey no event so greatly impressed the native imagination as the capture of Seringapatam, which won for General Harris a peerage and for Wellesley an Irish marquissate. In dealing with the territories of Tippon, Wellesley acted with moderation. The central portion, forming the old state of Mysore, was restored to an infant representative of the Hindu rajah, whom Hyder Ali

First Mysore War.

Second Mysore War.

Permanent settlement of Bengal.

The French menace.



had dethroned, while the rest was partitioned between the nizam and the British. At about the same time the province of the Carnatic, or all that large portion of southern India ruled by the nabab of Arcot, and also the principality of Tanjore, were placed under direct British administration, thus constituting the Madras presidency almost as it has existed to the present day.

The Mahrattas had been the nominal allies of the British in both their wars with Tippoo, but they had never given active assistance, nor were they secured to the British side as the nizam now was. The Mahratta powers at this time were five in number. The recognized head of the confederacy was the peshwa of Poona, who ruled the hill country of the Western Ghats, the cradle of the Mahratta race. The fertile province of Gujarat was annually harried by the horsemen of the gaekwar of Baroda. In central India two military leaders, Sindhia of Gwalior and Holkar of Indore, alternately held the pre-eminence. Towards the east the Bhonsla raja of Nagpur reigned from Berar to the coast of Orissa. Wellesley tried assiduously to bring these several Mahratta powers within the net of his subsidiary system. At last, in 1802, the necessities of the peshwa, who had been defeated by Holkar, and driven as a fugitive into British territory, induced him to sign the treaty of Bassein, by which he pledged himself to hold communications with no other power, European or native, and ceded territory for the maintenance of a subsidiary force. This greatly extended the British territorial influence in western India, but led directly to the second Mahratta war, for neither Sindhia nor the raja of Nagpur would tolerate this abandonment of Mahratta independence. The campaigns that followed are perhaps the most glorious in the history of the British arms in India. The general plan and the adequate provision of resources were due to the marquis Wellesley, as also the indomitable spirit that could not anticipate defeat. The armies were led by General Arthur Wellesley (afterwards duke of Wellington) and General (afterwards Lord) Lake. Wellesley operated in the Deccan, where, in a few short months, he won the decisive victories of Assaye and Argaum. Lake's campaign in Hindustan was no less brilliant, though it has received less notice from historians. He won pitched battles at Aligarh and Laswari, and captured the cities of Delhi and Agra, thus scattering the French troops of Sindhia, and at the same time coming forward as the champion of the Mogul emperor in his hereditary capital. Before the year 1803 was out, both Sindhia and the Bhonsla raja were glad to sue for peace. Sindhia ceded all claims to the territory north of the Jumna, and left the blind old emperor Shah Alam once more under British protection. The Bhonsla raja forfeited Orissa to the English, who had already occupied it with a flying column, and Berar to the nizam, who gained a fresh addition by every act of complaisance to the British government. The freebooter, Jaswant Rao Holkar, alone remained in the field, supporting his troops by ravages through Malwa and Rajputana. The concluding years of Wellesley's rule were occupied with a series of operations against Holkar, which brought no credit to the British name. The disastrous retreat of Colonel Monson through Central India (1804) recalled memories of the convention of Warguam, and of the destruction of Colonel Baillie's force by Hyder Ali. The repulse of Lake in person at the siege of Bharatpur (Bhurtpore) (1805) is memorable as an instance of a British army in India having to turn back with its object unaccomplished.

The ambitious policy and the continuous wars of Lord Wellesley exhausted the patience of the court of directors at home. In 1804 Lord Cornwallis was sent out as governor-general a second time, with instructions to bring about peace at any price, while Holkar was still unsubdued, and Sindhia was threatening a fresh war. But Cornwallis was now an old man and broken down in health. Travelling up to the north-west during the rainy season, he sank and died at Ghazipur, before he had been ten weeks in the country. His immediate successor was Sir George Barlow, a civil servant of the company, who, as a *locum tenens*, had no alternative but to carry out

faithfully the orders of his employers. He is charged with being, under these orders, the only governor-general who diminished the area of British territory, and with violating engagements by abandoning the Rajput chiefs to the tender mercies of Holkar and Sindhia. During his administration also occurred the mutiny of the Madras sepoys at Vellore, which, though promptly suppressed, sent a shock of insecurity through the empire.

Lord Minto, governor-general from 1807 to 1813, consolidated the conquests which Wellesley had acquired. His only military exploits were the occupation of the island of Mauritius, and the conquest of Java by an expedition which he accompanied in person. The condition of central India continued to be disturbed, but Lord Minto succeeded in preventing any violent outbreaks without himself having recourse to the sword. The company had ordered him to follow a policy of non-intervention, and he managed to obey his orders without injuring the prestige of the British name. In his time the Indian government first opened relations with a new set of foreign powers by sending embassies to the Punjab, to Afghanistan and to Persia. The ambassadors were all trained in the school of Wellesley, and formed perhaps the most illustrious trio of "politicals" that the Indian service has produced. Sir Charles Metcalfe was the envoy to the court of Ranjit Singh at Lahore; Mountstuart Elphinstone met the shah of Afghanistan at Peshawar; and Sir John Malcolm was despatched to Persia. If it cannot be said that any of these missions were fruitful in permanent results, at least they introduced the English to a new set of diplomatic relations, and widened the sphere of their influence.

The successor of Lord Minto was Lord Moira, better known as the marquis of Hastings, who governed India for the long period of nine years, from 1814 to 1823. This period was marked by two wars of the first magnitude, the campaigns against the Gurkhas of Nepal, and the third and last Mahratta War. The Gurkhas, the present ruling race in Nepal, are Hindu immigrants who claim a Rajput origin. Their sovereignty dates only from 1767, in which year they overran the valley of Katmandu, and gradually extended their power over all the hills and valleys of Nepal. Organized upon a sort of military and feudal basis, they soon became a terror to all their neighbours, marching east into Sikkim, west into Kumaon, and south into the Gangetic plains. In the last quarter their victims were British subjects, and at last it became imperatively necessary to check their advance. Sir George Barlow and Lord Minto had remonstrated in vain, and nothing was left to Lord Moira but to take up arms. The campaign of 1814 was little short of disastrous. After overcoming the natural difficulties of a malarious climate and precipitous hills, the sepoys were on several occasions fairly worsted by the unexpected bravery of the little Gurkhas, whose heavy knives or *kukris* dealt terrible execution. But in 1815 General Ochterlony, who commanded the army operating by way of the Sutlej, stormed one by one the hill forts which still stud the Himalayan states now under the Punjab government, and compelled the Nepal *darbar* to sue for peace. In the following year the same general advanced from Patna into the valley of Katmandu, and finally dictated the terms which had before been rejected, within a few miles of the capital. By the treaty of Segauli, which defines the English relations with Nepal to the present day, the Gurkhas withdrew on the one hand from Sikkim, and on the other from those lower ranges of the western Himalayas which have supplied the health-giving stations of Naini Tal, Mussoorie and Simla.

Meanwhile the condition of central India was every year becoming more unsatisfactory. Though the great Mahratta chiefs were learning to live rather as peaceful princes than as leaders of predatory bands, the example of lawlessness they had set was being followed, and bettered in the following, by a new set of freebooters, known as the Pindaris. As opposed to the Mahrattas, who were at least a nationality bound by some traditions of a united government, the Pindaris were merely irregular soldiers, corresponding most nearly to the free companies of mediæval Europe. Of no common race and

Wars with  
Sindhia  
and  
Holkar.

Gurkha  
War.

Pindaris.

of no common religion, they welcomed to their ranks the outlaws and broken tribes of all India—Aghans, Mahrattas or Jats. Their headquarters were in Malwa, but their depredations were not confined to central India. In bands, sometimes numbering a few hundreds, sometimes many thousands, they rode out on their forays as far as the Coromandel coast. The most powerful of the Pindari captains, Amir Khan, had an organized army of many regiments, and several batteries of cannon. Two other leaders, known as Chitu and Karim, at one time paid a ransom to Sindhia of £100,000. To suppress the Pindari hordes, who were supported by the sympathy, more or less open, of all the Mahratta chiefs, Lord Hastings (1817) collected the strongest British army that had been seen in India, numbering nearly 120,000 men, half to operate from the north, half from the south. Sindhia was overawed, and remained quiet. Amir Khan consented to disband his army, on condition of being guaranteed the possession of what is now the principality of Tonk. The remaining bodies of Pindaris were attacked in their homes, surrounded, and cut to pieces. Karim threw himself upon the mercy of the conquerors. Chitu fled to the jungles, and was killed by a tiger.

In the same year (1817) as that in which the Pindaris were crushed, and almost in the same month (November), the three great Mahratta powers at Poona, Nagpur and Indore rose against the English. The peshwa; Baji Rao, had long been chafing under the terms imposed by the treaty of Bassein (1802), and the subsequent treaty of Poona (1817), which riveted yet closer the chains of dependence upon the paramount power. Elphinstone, then resident at his court, foresaw what was coming and ordered up a European regiment from Bombay. The next day the residency was burned down, and Kirkee was attacked by the whole army of the peshwa. The attack was bravely repulsed, and the peshwa immediately fled from his capital. Almost the same plot was enacted at Nagpur, where the honour of the British name was saved by the sepoys who defended the hill of Sitabaldi against enormous odds. The army of Holkar was defeated in the following month at the pitched battle of Mehidpur. All open resistance was now at an end. Nothing remained but to follow up the fugitives, and determine the conditions of the general pacification. In both these duties Sir John Malcolm played a prominent part. The peshwa himself surrendered, and was permitted to reside at Bithur, near Cawnpore, on a pension of £80,000 a year. His adopted son was the infamous Nana Sahib. To fill the peshwa's place to some extent at the head of the Mahratta confederacy, the lineal descendant of Sivaji was brought forth from obscurity, and placed upon the throne of Satara. The greater part of the peshwa's dominions was ultimately incorporated in the Bombay presidency, while the nucleus of the Central Provinces was formed out of territory taken from the peshwa and the raja of Nagpur. An infant was recognized as the heir of Holkar, and a second infant was proclaimed raja of Nagpur under British guardianship. At the same time the several states of Rajputana accepted the position of feudatories of the paramount power. The map of India, as thus drawn by Lord Hastings, remained substantially unchanged until the time of Lord Dalhousie. But the proudest boast of Lord Hastings and Sir John Malcolm was, not that they had advanced the *pomoerium*, but that they had conferred the blessings of peace and good government upon millions who had suffered unutterable things from Mahratta and Pindari tyranny.

The marquis of Hastings was succeeded by Lord Amherst, after the interval of a few months, during which Mr Adam, a civil servant, acted as governor-general. Lord Amherst's administration lasted for five years, from 1823 to 1828. It is known in history by two prominent events, the first Burmese War and the capture of Bharatpur. For some years past the north-east frontier had been disturbed by the restlessness of the Burmese. The successors of Alompra, after having subjugated all Burma, and over-run Assam, which was then an independent kingdom, began a series of encroachments upon British territory in Bengal.

As all peaceful proposals were scornfully rejected, Lord Amherst was compelled to declare war in 1824. Little military glory could be gained by beating the Burmese, who were formidable only from the pestilential character of their country. One expedition with gunboats proceeded up the Brahmaputra into Assam; another marched by land through Chittagong into Arakan, for the Bengal sepoys refused to go by sea; a third, and the strongest, sailed from Madras direct to the mouth of the Irrawaddy. The war was protracted over two years. At last, after the loss of about 20,000 lives and an expenditure of £14,000,000, the king of Ava consented to sign the treaty of Yandabu, by which he abandoned all claim to Assam, and ceded the provinces of Arakan and Tenasserim, which were already in the military occupation of the British. He retained all the valley of the Irrawaddy, down to the sea at Rangoon. The capture of Bharatpur in central India by Lord Combermere in 1826 wiped out the repulse which Lord Lake had received before that city in January 1805. A disputed succession necessitated British intervention. Artillery could make little impression upon the massive walls of mud, but at last a breach was effected by mining, and the city was taken by storm, thus losing its general reputation throughout India for impregnability, which had threatened to become a political danger.

The next governor-general was Lord William Bentinck, who had been governor of Madras twenty years earlier at the time of the mutiny of Vellore. His seven years' rule (from 1828 to 1835) is not signalized by any of those victories or extensions of territory by which chroniclers delight to measure the growth of empire. But it forms an epoch in administrative reform, and in the benign process by which the hearts of a subject population are won over to venerate as well as obey their alien rulers. The modern history of the British in India, as benevolent administrators ruling the country with an eye to the good of the natives, may be said to begin with Lord William Bentinck. According to the inscription upon his statue at Calcutta, from the pen of Macaulay: "He abolished cruel rites; he effaced humiliating distinctions; he gave liberty to the expression of public opinion; his constant study it was to elevate the intellectual and moral character of the nations committed to his charge." His first care on arrival in India was to restore equilibrium to the finances, which were tottering under the burden imposed upon them by the Burmese War. This he effected by reductions in permanent expenditure, amounting in the aggregate to 1½ millions sterling, as well as by augmenting the revenue from land that had escaped assessment, and from the opium of Malwa. He also widened the gates by which educated natives could enter the service of the company. Some of these reforms were distasteful to the covenanted service and to the officers of the army, but Lord William was always staunchly supported by the court of directors and by the Whig ministry at home.

His two most memorable acts are the abolition of suttee and the suppression of the Thugs. At this distance of time it is difficult to realize the degree to which these *Suttee*, two barbarous practices had corrupted the social system of the Hindus. European research has clearly proved that the text in the *Vedas* adduced to authorize the immolation of widows was a wilful mistranslation. But the practice had been engrained in Hindu opinion by the authority of centuries, and had acquired the sanctity of a religious rite. The emperor Akbar is said to have prohibited it by law, but the early British rulers did not dare so far to violate the religious customs of the people. In the year 1817 no fewer than seven hundred widows are said to have been burned alive in the Bengal presidency alone. To this day the most holy spots of Hindu pilgrimage are thickly dotted with little white pillars, each commemorating a suttee. In the teeth of strenuous opposition, from both Europeans and natives, Lord William carried the regulation in council on the 4th of December 1820, by which all who abetted suttee were declared guilty of "culpable homicide." The honour of suppressing Thuggism must be shared between Lord William and Captain Sleeman. Thuggism was an abnormal

Third  
Mahratta  
War.

Bentinck.

exorcism upon Hinduism, in so far as the bands of secret assassins were sworn together by an oath based on the rites of the bloody goddess Kali. Between 1826 and 1835 as many as 1562 Thugs were apprehended in different parts of British India, and by the evidence of approvers the moral plague spot was gradually stamped out.

Two other historical events are connected with the administration of Lord William Bentinck. In 1833 the charter of the East India Company was renewed for twenty years, but only upon the terms that it should abandon its trade and permit Europeans to settle freely in the country. At the same time a legal or fourth member was added to the governor-general's council, who might not be a servant of the company, and a commission was appointed to revise and codify the law. Macaulay was the first legal member of council, and the first president of the law commission. In 1830 it was found necessary to take the state of Mysore under British administration, where it continued until 1881, when it was restored to native rule; and in 1834 the frantic misrule of the raja of Coorg brought on a short and sharp war. The raja was permitted to retire to Benares, and the brave and proud inhabitants of that mountainous little territory decided to place themselves under the rule of the company; so that the only annexation effected by Lord William Bentinck was "in consideration of the unanimous wish of the people."

Sir Charles (afterwards Lord) Metcalfe succeeded Lord William as senior member of council. His short term of office is memorable for the measure which his predecessor had initiated, **Auckland**, but which he willingly carried into execution, for giving entire liberty to the press. Public opinion in India, as well as the express wish of the court of directors at home, pointed to Metcalfe as the most fit person to carry out the policy of Bentinck, not provisionally, but as governor-general for a full term. Party exigencies, however, led to the appointment of Lord Auckland. From that date commences a new era of war and conquest, which may be said to have lasted for twenty years. All looked peaceful until Lord Auckland, prompted by his evil genius, attempted by force to place Shah Shuja upon the throne of Kabul, an attempt which ended in gross mismanagement and the annihilation of the British garrison in that city. The disaster in Afghanistan was quickly followed by the conquest of Sind, the two wars in the Punjab, the second Burmese War, and last of all the Mutiny.

The attention of the British government had been directed to Afghan affairs ever since the time of Sir John Shore, who feared that Zaman Shah, then holding his court at Lahore, might follow in the path of Ahmed Shah, and overrun Hindustan. The growth of the powerful Sikh kingdom of Ranjit Singh effectually dispelled any such alarms for the future. Subsequently, in 1809, while a French invasion of India was still a possibility to be guarded against, Mountstuart Elphinstone was sent by Lord Minto on a mission to Shah Shuja to form a defensive alliance. Before the year was out Shah Shuja had been driven into exile, and a third brother, Mahmud Shah, was on the throne. In 1837, when the curtain rises upon the drama of British interference in Afghanistan, the usurper, Dost Mohammed Barakzai, was firmly established at Kabul. His great ambition was to recover Peshawar from the Sikhs; and when Captain Alexander Burnes arrived on a mission from Lord Auckland, with the ostensible object of opening trade, the Dost was willing to promise everything, if only he could get Peshawar. But Lord Auckland had another and more important object in view. At this time the Russians were advancing rapidly in Central Asia, and a Persian army, not without Russian support, was besieging Herat, the traditional bulwark of Afghanistan on the east. A Russian envoy was at Kabul at the same time as Burnes. The latter was unable to satisfy the demands of Dost Mohammed in the matter of Peshawar, and returned to India unsuccessful. Lord Auckland forthwith resolved upon the hazardous plan of placing a more subservient ruler upon the throne of Kabul. Shah Shuja, now in exile at Ludhiana, was selected for the

purpose. At this time both the Punjab and Sind were independent kingdoms. Sind was the less powerful of the two, and, therefore, a British army escorting Shah Shuja made its way by that route to enter Afghanistan through the Bolan Pass. Kandahar surrendered, Ghazni was taken by storm, Dost Mohammed fled across the Hindu Kush, and Shah Shuja was triumphantly led into the Bala Hissar at Kabul in August 1839. During the two years that followed Afghanistan remained in the military occupation of the British. The catastrophe occurred in November 1841, when Sir Alexander Burnes was assassinated in the city of Kabul. The troops in the cantonments were then under the command of General Elphinstone (not to be confounded with the civilian Mountstuart Elphinstone), with Sir William Macnaghten as chief political adviser. Elphinstone was an old man, unequal to the responsibilities of the position. Macnaghten was treacherously murdered at an interview with the Afghan chief, Akbar Khan, eldest son of Dost Mohammed. After lingering in their cantonments for two months, the British army set off in the depth of winter to find its way back to India through the passes. When they started they numbered 4000 fighting men, with 12,000 camp followers. A single survivor, Dr Brydon, reached the friendly walls of Jalalabad, where General Sale was gallantly holding out. The rest perished in the defiles of Khurd Kabul and Jagdalak, either from the knives and matchlocks of the Afghans or from the effects of cold. A few prisoners, mostly women, children and officers, were consistently treated by the orders of Akbar Khan. (See **AFGHANISTAN.**)

Within a month after the news reached Calcutta, Lord Auckland had been superseded by Lord Ellenborough, whose first impulse was to be satisfied with drawing off in safety the garrisons from Kandahar and Jalalabad. But bolder counsels prevailed. General Pollock, who was marching straight through the Punjab to relieve General Sale, was ordered to penetrate to Kabul, while General Nott was only too glad not to be forbidden to retire from Kandahar through Kabul. After a good deal of fighting, the two British forces met at their common destination in September 1842. The great *basar* at Kabul was blown up with gunpowder to fix a stigma upon the city; the prisoners were recovered; and all marched back to India, leaving Dost Mohammed to take undisputed possession of his throne. The drama closed with a bombastic proclamation from Lord Ellenborough, who had caused the gates from the tomb of Mahmud of Ghazni to be carried back as a memorial of "Somnath revenged."

Lord Ellenborough, who loved military display, had his tastes gratified by two more wars. In 1843 the Mahomedan rulers of Sind, known as the "meers" or amirs, whose only fault was that they would not surrender their independence, were crushed by Sir Charles Napier. **Annexion of Sind.** The victory of Meeanee, in which 3000 British troops defeated 20,000 Baluchis, is perhaps the most brilliant feat of arms in Indian history; but an honest excuse can scarcely be found for the annexation of the country. In the same year a disputed succession at Gwalior, fomented by feminine intrigue, resulted in an outbreak of the overgrown army which the Sindhia family had been allowed to maintain. Peace was restored by the battles of Maharajpur and Punniar, at the former of which Lord Ellenborough was present in person.

In 1844 Lord Ellenborough was recalled by the court of directors, who differed from him on many points of administration, and distrusted his erratic genius. He was succeeded by Sir Henry (afterwards Lord) Hardinge, **First Sikh War.** who had served through the Peninsular War and had lost a hand at Ligny. It was felt on all sides that a trial of strength between the British and the Sikhs was at hand. (For the origin of the Sikh power see **PUNJAB.**)

Ranjit Singh, the founder of the Sikh kingdom in the Punjab, had faithfully fulfilled all his obligations towards the British. But on his death in 1839 no successor was left to curb the ambition of the Sikh nationality.

In 1845 the *khalsa*, or Sikh army, numbering 60,000 men with

150 guns, crossed the Sutlej and invaded British territory. Sir Hugh Gough, the commander-in-chief, together with the governor-general, hurried up to the frontier. Within three weeks four pitched battles were fought, at Mudki, Ferozeshah, Aliwal and Sobraon. The British loss on each occasion was heavy; but by the last victory the Sikhs were fairly driven into and across the Sutlej, and Lahore surrendered to the British. By the terms of peace then dictated the infant son of Ranjit, Dhuleep Singh, was recognized as raja; the Jullundur Doab, or tract between the Sutlej and the Ravi, was annexed; the Sikh army was limited to a specified number; Major Henry Lawrence was appointed to be resident at Lahore; and a British force was detailed to garrison the Punjab for a period of eight years.

Lord Dalhousie succeeded Lord Hardinge, and his eight years' administration (from 1848 to 1856) was more pregnant of results

**Dalhousie.** than that of any governor-general since Wellesley. Though professedly a man of peace, he was compelled to fight two wars, in the Punjab and in Burma. These both ended in large acquisitions of territory, while Nagpur, Oudh and several minor states also came under British rule. But Dalhousie's own special interest lay in the advancement of the moral and material condition of the country. The system of administration carried out in the conquered Punjab by the two Lawrences and their assistants is probably the most successful piece of difficult work ever accomplished by Englishmen. Lower Burma prospered under their rule scarcely less than the Punjab. In both cases Lord Dalhousie deserves a large share of the credit. No branch of the administration escaped his reforming hand. He founded the public works department, to pay special attention to roads and canals. He opened the Ganges canal, still the largest work of the kind in the country, and he turned the sod of the first Indian railway. He promoted steam communication with England via the Red Sea, and introduced cheap postage and the electric telegraph. It is Lord Dalhousie's misfortune that these benefits are too often forgotten in the vivid recollections of the Mutiny, which avenged his policy of annexation.

Lord Dalhousie had not been six months in India before the second Sikh war broke out. Two British officers were treacherously assassinated at Multan. Unfortunately Henry Lawrence was at home on sick leave. The British army was not ready to act in the hot season, and, despite the single-handed exertions of Lieutenant (afterwards Sir Herbert) Edwards, this outbreak of fanaticism led to a general rising. The *khalsa* army again came together, and more than once fought on even terms with the British. On the fatal field of Chillianwalla, which patriotism prefers to call a drawn battle, the British lost 2400 officers and men, besides four guns and the colours of three regiments. Before reinforcements could come out from England, with Sir Charles Napier as commander-in-chief, Lord Gough had restored his own reputation by the crowning victory of Gujrat, which absolutely destroyed the Sikh army. Multan had previously fallen; and the Afghan horse under Dost Mahommed, who had forgotten their hereditary antipathy to the Sikhs in their greater hatred of the British name, were chased back with ignominy to their native hills. The Punjab henceforth became a British province, supplying a virgin field for the administrative talents of Dalhousie and the two Lawrences. Raja Dhuleep Singh received an allowance of £50,000 a year, on which he retired as a country gentleman to Norfolk in England. (See PUNJAB.)

The second Burmese war of 1852 was caused by the ill-treatment of European merchants at Rangoon, and the insolence offered to the captain of a frigate who had been sent to remonstrate. The whole valley of the Irrawaddy, from Rangoon to Prome, was occupied in a few months, and, as the king of Ava refused to treat, it was annexed, under the name of Pegu, to the provinces of Arakan and Tenasserim, which had been acquired in 1826.

Lord Dalhousie's dealings with the feudatory states of India, though actuated by the highest motives, seem now to have

proceeded upon mistaken lines. His policy of annexing each native state on the death of its ruler without natural heirs produced a general feeling of insecurity of tenure among the princes, and gave offence to the people of India. This policy was reversed when India was taken over by the crown after the Mutiny; and its reversal has led

The doctrine of lapse.

to the native princes being amongst the most loyal subjects of the British government. The first state to escheat to the British government was Satara, which had been reconstituted by Lord Hastings on the downfall of the peshwa Baji Rao in 1818. The last direct representative of Sivaji died without a male heir in 1848, and his deathbed adoption was set aside. In the same year the Rajput state of Karauli was saved by the interposition of the court of directors, who drew a fine distinction between a dependent principality and a protected ally. In 1853 Jhansi suffered the same fate as Satara. But the most conspicuous application of the doctrine of lapse was the case of Nagpur. The last of the Bhonslas, a dynasty older than the British government itself, died without a son, natural or adopted, in 1853. That year also saw British administration extended to the Berars, or the assigned districts which the nizam of Hyderabad was induced to cede as a territorial guarantee for the subsidies which he perpetually kept in arrear. Three more distinguished names likewise passed away in 1853, though without any attendant accretion to British territory. In the extreme south the titular nawab of the Carnatic and the titular raja of Tanjore both died without heirs. Their rank and their pensions died with them, though compassionate allowances were continued to their families. In the north of India, Baji Rao, the ex-peshwa who had been dethroned in 1818, lived on till 1853 in the enjoyment of his annual pension of £80,000. His adopted son, Nana Sahib, inherited his accumulated savings, but could obtain no further recognition.

The annexation of the province of Oudh was justifiable on the ground of morals, though not on that of policy. Ever since the nawab wazir, Shuja-ud-Dowla, received back his forfeited territories from the hands of Lord Clive in 1765, the very existence of Oudh as an independent state had depended only upon the protection of British bayonets. Thus, preserved alike from foreign invasion and from domestic rebellion, the long line of subsequent nawabs had given way to that neglect of public affairs and those private vices which naturally flow from irresponsible power. Their only redeeming virtue was steady loyalty to the British government. Warning after warning had been given to the nawabs, who had assumed the title of king since 1819, to put their house in order; but every warning was neglected, and Lord Dalhousie at last carried into effect what both the previous governors-general had threatened. In 1856, the last year of his rule, he issued orders to General (afterwards Sir James) Outram, then resident at the court of Lucknow, to assume the direct administration of Oudh, on the ground that "the British government would be guilty in the sight of God and man, if it were any longer to aid in sustaining by its countenance an administration fraught with suffering to millions." The king, Wajid Ali, bowed to irresistible force, though he ever refused to recognize the justice of his deposition. After a mission to England, by way of protest and appeal, he settled down in the pleasant suburb of Garden Reach near Calcutta, where he lived in the enjoyment of a pension of £120,000 a year. Oudh was thus annexed without a blow; but it may be doubted whether the one measure of Lord Dalhousie upon which he looked back himself with the clearest conscience was not the very one that most alarmed native public opinion.

Annexation of Oudh.

Lord Dalhousie was succeeded by his friend, Lord Canning, who, at the farewell banquet in England given to him by the court of directors, uttered these prophetic words: "I wish for a peaceful term of office. But I cannot forget that in the sky of India, serene as it is, a small cloud may arise, no larger than a man's hand, but which, growing larger and larger, may at last threaten to burst and overwhelm us with ruin." In the following year the sepoy of the Bengal

The Mutiny.

army mutinied, and all the valley of the Ganges from Patna to Delhi rose in open rebellion.

The various motives assigned for the Mutiny appear inadequate to the European mind. The truth seems to be that native opinion throughout India was in a ferment, predisposing men to believe the wildest stories, and to act precipitately upon their fears. The influence of panic in an Oriental population is greater than might be readily believed. In the first place, the policy of Lord Dalhousie, exactly in proportion as it had been dictated by the most honourable considerations, was utterly distasteful to the native mind. Repeated annexations, the spread of education, the appearance of the steam engine and the telegraph wire, all alike revealed a consistent determination to substitute an English for an Indian civilization. The Bengal sepoys, especially, thought that they could see into the future farther than the rest of their countrymen. Nearly all men of high caste, and many of them recruited from Oudh, they dreaded tendencies which they deemed to be denationalizing, and they knew at first hand what annexation meant. They believed it was by their prowess that the Punjab had been conquered, and all India was held quiet. The numerous dethroned princes, their heirs and their widows, were the first to take advantage of the spirit of disaffection that was abroad. They had heard of the Crimean War, and were told that Russia was the perpetual enemy of England. Owing to the silladar system, under which the native cavalry provided their own horses and accoutrements, many of the sowars were in debt, and were in favour of a change which would wipe out the existing régime and with it the money-lender.

But in addition to these general causes of unrest the condition of the native army had long given cause for uneasiness to acute observers. During the course of its history it had broken out into mutiny at recurrent intervals, the latest occasion being the winter of 1843-1844, when there were two separate mutinies in Sind and at Ferozepur. Moreover the spirit of the sepoys during the Sikh wars was unsatisfactory, and led to excessive casualties amongst the British officers and soldiers. Both General Jacob and Sir Charles Napier had prophesied that the Mutiny would take place. Sir Hugh Gough and other commanders-in-chief had petitioned for the removal of India's chief arsenal from Delhi to Umballa; and Lord Dalhousie himself had protested against the reduction of the British element in the army. But all these warnings were disregarded with a blindness as great as was the incapacity that allowed the Mutiny to gather head unchecked after its first outbreak at Meerut. Moreover the outbreak was immediately provoked by an unparalleled instance of carelessness. It has recently been proved by Mr G. W. Forrest's researches in the Government of India records that the sepoys' belief that their cartridges were greased with the fat of cows and pigs had some foundation in fact. Such a gross violation of their caste prejudices would alone be sufficient to account for the outbreak that followed. (For the military incidents of the Mutiny see *INDIAN MUTINY*.)

The Mutiny sealed the fate of the East India company, after a life of more than two and a half centuries. The Act for the

**Transfer to the Crown.** Better Government of India (1858), which finally transferred the entire administration from the company to the crown, was not passed without an eloquent protest from the directors, nor without acrimonious party discussion in parliament. It enacts that India shall be governed by, and in the name of, the sovereign of England through a principal secretary of state, assisted by a council. The governor-general received the new title of viceroy. The European troops of the company, numbering about 24,000 officers and men, were amalgamated with the royal service, and the Indian navy was abolished. By the Indian Councils Act 1861 the governor-general's council and also the councils at Madras and Bombay were augmented by the addition of non-official members, either natives or Europeans, for legislative purposes only; and by another act passed in the same year high courts of judicature were constituted out of the existing

supreme courts and company's courts at the presidency towns.

#### *India under the Crown.*

It fell to the lot of Lord Canning both to suppress the Mutiny and to introduce the peaceful revolution that followed. As regards his execution of the former part of his duties, it is sufficient to say that he preserved his equanimity undisturbed in the darkest hours of peril, and that the strict impartiality of his conduct incurred alternate praise and blame from the fanatics on either side. The epithet then scornfully applied to him of "Clemency" Canning is now remembered only to his honour. On November 1, 1858, at a grand durbar held at Allahabad the royal proclamation was published which announced that the queen had assumed the government of India. This document, which has been called the Magna Charta of the Indian people, went on to explain the policy of political justice and religious toleration which it was her royal pleasure to pursue, and granted an amnesty to all except those who had directly taken part in the murder of British subjects. Peace was proclaimed throughout India on the 8th of July 1859; and in the following cold season Lord Canning made a viceregal progress through the upper provinces, to receive the homage of loyal princes and chiefs, and to guarantee to them the right of adoption. The suppression of the Mutiny increased the debt of India by about 40 millions sterling, and the military changes that ensued augmented the annual expenditure by about 10 millions. To grapple with this deficit, James Wilson was sent out from the treasury as financial member of council. He reorganized the customs system, imposed an income tax and licence duty and created a state paper currency. The penal code, originally drawn up by Macaulay in 1837, passed into law in 1866, together with codes of civil and criminal procedure.

Lord Canning left India in March 1862, and died before he had been a month in England. His successor, Lord Elgin, only lived till November 1863, when he too fell a victim to the excessive work of the governor-generalship, dying at the Himalayan station of Dharmasala, where he lies buried. He was succeeded by Sir John Lawrence, the saviour of the Punjab. The chief incidents of his administration were the Bhutan war and the terrible Orissa famine of 1866. Lord Mayo, who succeeded him in 1869, carried on the permanent British policy of moral and material progress with a special degree of personal energy. The Umballa durbar, at which Shere Ali was recognized as amir of Afghanistan, though in one sense the completion of what Lord Lawrence had begun, owed much of its success to the personal influence of Lord Mayo himself. The same quality, combined with sympathy and firmness, stood him in good stead in all his dealings both with native chiefs and European officials. His example of hard work stimulated all to their best. While engaged in exploring with his own eyes the furthest corners of the empire, he fell by the hand of an assassin in the convict settlement of the Andaman islands in 1872. His successor was Lord Northbrook, whose ability showed itself chiefly in the department of finance. During the time of his administration a famine in Lower Bengal in 1874 was successfully obviated by government relief and public works, though at an enormous cost; the gaekwar of Baroda was dethroned in 1875 for misgovernment and disloyalty, while his dominions were continued to a nominated child of the family; and the prince of Wales (Edward VII.) visited the country in the cold season of 1875-1876. Lord Lytton followed Lord Northbrook in 1876. On the 1st of January 1877 Queen Victoria was proclaimed empress of India at a durbar of great magnificence, held on the historic "Ridge" overlooking the Mogul capital Delhi. But, while the princes and high officials of the country were flocking to this gorgeous scene, the shadow of famine was already darkening over the south of India. Both the monsoons of 1876 had failed to bring their due supply of rain, and the season of 1877 was little better. The consequences of this prolonged drought, which extended from Cape Comorin to the Deccan, and subsequently invaded northern India, were more disastrous than any similar calamity

up to that time from the introduction of British rule. Despite unparalleled importations of grain by sea and rail, despite the most strenuous exertions of the government, which incurred a total expenditure on this account of 11 millions sterling, the loss of life from actual starvation and its attendant train of diseases was lamentable. In the autumn of 1878 the affairs of Afghanistan again forced themselves into notice. Shere Ali, the amir, who had been hospitably entertained by Lord Mayo, was found to be favouring Russian intrigues. A British envoy was refused admittance to the country, while a Russian mission was received with honour. This led to a declaration of war. British armies advanced by three routes—the Khyber, the Kurram and the Bolan—and without much opposition occupied the inner entrances of the passes. Shere Ali fled to Afghan Turkestan, and there died. A treaty was entered into with his son, Yakub Khan, at Gandamak, by which the British frontier was advanced to the crests or farther sides of the passes and a British officer was admitted to reside at Kabul. Within a few months the British resident, Sir Louis Cavagnari, was treacherously attacked and massacred, together with his escort, and a second war became necessary. Yakub Khan abdicated, and was deported to India, while Kabul was occupied by force.

At this crisis of affairs a general election in England resulted in a change of government. Lord Lytton resigned with the Conservative ministry, and the marquis of Ripon was nominated as his successor in 1880. Shortly afterwards a British brigade was defeated at Maiwand by the Herati army of Ayub Khan, a defeat promptly and completely retrieved by the brilliant march of General Sir Frederick Roberts from Kabul to Kandahar, and by the total rout of Ayub Khan's army on the 1st of September 1880. Abdur Rahman Khan, the eldest male representative of the stock of Dost Mahomed, was then recognized as amir of Kabul. Lord Ripon was sent out to India by the Liberal ministry of 1880 for the purpose of reversing Lord Lytton's policy in Afghanistan, and of introducing a more sympathetic system into the administration of India. The disaster at Maiwand, and the Russian advance east of the Caspian, prevented the proposed withdrawal from Quetta; but Kandahar was evacuated, Abdur Rahman was left in complete control of his country and was given an annual subsidy of twelve lakhs of rupees in 1883. In the second purpose of his administration Lord Ripon's well-meant efforts only succeeded in setting Europeans and natives against each other. His term of office was chiefly notable for the agitation against the Ilbert Bill, which proposed to subject European offenders to trial by native magistrates. The measure aroused a storm of indignation amongst the European community which finally resulted in the bill being shorn of its most objectionable features. Lord Ripon's good intentions and personal sympathy were recognized by the natives, and on leaving Bombay he received the greatest ovation ever accorded to an Indian viceroy.

After the arrival of Lord Dufferin as governor-general the incident known as the Panjdeh Scare brought Britain to the verge of war with Russia. During the preceding decades Russia had gradually advanced her power from the Caspian across the Turkoman steppes to the border of Afghanistan, and Russian intrigue was largely responsible for the second Afghan war. In February 1884 Russia annexed Merv. This action led to an arrangement in August of the same year for a joint Anglo-Russian commission to delimit the Afghan frontier. In March 1885, while the commission was at work, Lord Dufferin was entertaining the amir Abdur Rahman at a durbar at Rawalpindi. The durbar was interrupted by the news that a Russian general had attacked and routed the Afghan force holding the bridge across the river Kushk, and the incident might possibly have resulted in war between Britain and Russia but for the slight importance that Abdur Rahman attributed to what he termed a border scuffle.

The incident, however, led to military measures being taken by the government of Lord Dufferin, which had far-reaching

effects on Indian finance. The total strength of the army was raised by 10,000 British and 20,000 native troops, at an annual cost of about two millions sterling; and the frontier post of Quetta, in the neighbourhood of Kandahar, was connected with the Indian railway system by a line that involved very expensive tunnelling.

*Increase  
in the  
Army.*

The Panjdeh incident was likewise the cause of the establishment of Imperial Service troops in India. At the moment when war seemed imminent, the leading native princes made offers of pecuniary aid. These offers were declined, but it was intimated to them at a later date that, if they would place a small military force in each state at the disposal of the British government, to be commanded by state officers, but drilled, disciplined and armed under the supervision of British officers and on British lines, the government would undertake to find the necessary supervising officer, arms and organization. The proposal was widely accepted, and the Imperial Service troops, as they are called, amount at present to some 20,000 cavalry, infantry and transport, whose efficiency is very highly thought of. They have rendered good service in the wars on the north-west frontier, and also in China and Somaliland. Later in the same year (1885) occurred the third Burmese war. For the causes of the dispute with King Thebaw, and a description of the military operations which ensued before the country was finally pacified, see BURMA.

*Imperial  
Service  
troops.*

From 1885 onwards the attention of the Indian government was increasingly devoted to the north-west frontier. Between the years 1885 and 1895 there were delimited at various times by joint commissions the Russo-Afghan frontier between the Oxus and Sarakhs on the Persian frontier, the Russo-Afghan frontier from Lake Victoria to the frontier of China and the Afghan-Indian frontier from the Kunar river to a point in the neighbourhood of the Nawa Kotal. To the westward, after various disagreements and two military expeditions, the territories comprising the Zhoob, Barhan and Bori valleys, occupied by Pathan tribes, were in 1890 finally incorporated in the general system of the Trans-Indus protectorate. About the same time in the extreme north the post of British resident in Gilgit was re-established, and the supremacy of Kashmir over the adjoining petty chiefships of Hunza-Nagar was enforced (1891-1892). In 1893 the frontiers of Afghanistan and British India were defined by a joint agreement between the two governments, known as the Durand agreement. There followed on the part of the British authorities, interference in Chitral, ending in an expedition in 1895 and the ejection of the local chiefs in favour of candidates amenable to British influence. A more formidable hostile combination, however, awaited the government of India. By the agreement of 1893 with the amir most of the Waziri clan and also the Afridis had been left outside the limits of the amir's influence and transferred to the British zone. Soon after that date the establishment by the British military authorities of posts within the Waziri country led to apprehension on the part of the local tribesmen. In 1895 the occupation of points within the Swat territory for the safety of the road from India to Chitral similarly roused the suspicion of the Swatis. The Waziris and Swatis successively rose in arms, in June and July 1897, and their example was followed by the Mohmands. Finally, in August the powerful Afridi tribe joined the combination and closed the Khyber Pass, which runs through their territory, and which was held by them, on conditions, in trust for the government of India. This led to the military operations known as the Tirah campaign, which proved very costly both in men and money.

Meanwhile considerable difficulties had been experienced with the Indian currency, which was on a purely silver basis. Before 1873 the fluctuations in the value of silver as compared with gold had been comparatively small, and the exchange value of the rupee was rarely less than two shillings. But after 1873, in consequence of changes in the monetary systems of France and Germany, and the increased production of silver, this stability of exchange no longer continued, and the rupee sank steadily in value, till it was worth

*The  
currency.*

*Lord  
Ripon.*

*The  
Panjdeh  
scare.*

little more than half its face value. This great shrinkage in exchange caused considerable loss to the Indian government in remitting to Europe, and entailed hardship upon Anglo-Indians who received pensions or other payments in rupees, while on the other hand it supplied an artificial stimulus to the export trade by increasing the purchasing power of gold. This advantage, however, was outweighed by the uncertainty as to what the exchange value of the rupee might be at any particular date, which imported a gambling element into commerce. Accordingly in June 1893 an act was passed closing the Indian mints to the free coinage of silver. Six years later, in 1899, the change was completed by an act making gold legal tender at the rate of £1 for Rs.15, or at the rate of 1s. 4d. per rupee, and both the government and the individual now know exactly what their obligations will be.

When Lord Curzon became viceroy in 1898, he reversed the policy on the north-west frontier which had given rise to the Tirah campaign, withdrew outlying garrisons in tribal country, substituted for them tribal militia, and created the new North-West Frontier province, for the purpose of introducing consistency of policy and firmness of control upon that disturbed border. In addition, after making careful inquiry through various commissions, he reformed the systems of education and police, laid down a comprehensive scheme of irrigation, improved the levee rules and the excessive report-writing of the civil service, encouraged the native princes by the formation of the Imperial Cadet Corps and introduced many other reforms. His term of office was also notable for the coronation durbar at Delhi in January 1903, the expedition to Lhasa in 1904, which first unveiled that forbidden city to European gaze, and the partition of Bengal in 1905. In December 1904 Lord Curzon entered upon a second term of office, which was unfortunately marred by a controversy with Lord Kitchener, the commander-in-chief, as to the position of the military member of council. Lord Curzon, finding himself at variance with the secretary of state, resigned before the end of the first year, and was succeeded by Lord Minto.

The new viceroy, who might have expected a tranquil time after the energetic reforms of his predecessor, soon found himself face to face with the most serious troubles, euphemistically called the "unrest," that British rule has had to encounter in India since the Mutiny. For many years the educated class among the natives had been claiming for themselves a larger share in the administration, and had organized a political party under the name of the National Congress, which held annual meetings at Christmas in one or other of the large cities of the peninsula. This class also exercised a wide influence through the press, printed both in the vernacular languages and in English, especially among young students. There is no doubt too that the adoption of Western civilization by the Japanese and their victorious war with Russia set in motion a current through all the peoples of the East. The occasion though not the cause of trouble arose from the partition of Bengal, which was represented by Bengali agitators as an insult to their mother country. While the first riots occurred in the Punjab and Madras, it is only in Bengal and eastern Bengal that the unrest has been bitter and continuous. This is the centre of the *swadeshi* movement for the boycott of English goods, of the most seditious speeches and writings and of conspiracies for the assassination of officials. At first the government attempted to quell the disaffection by means of the ordinary law, with fair success outside Bengal; but there, owing to the secret ramifications of the conspiracy, it has been found necessary to adopt special measures. Recourse has been had to a regulation of the year 1818, by which persons may be imprisoned or "deported" without reason assigned; and three acts of the legislature have been passed for dealing more directly with the prevalent classes of crime: (1) an Explosives Act, containing provisions similar to those in force in England; (2) a Prevention of Seditious Meetings Act, which can only be applied specially by proclamation; and (3) a Criminal Law Amendment Act, of which the two chief provisions

are—a magisterial inquiry in private (similar to the Scotch procedure) and a trial before three judges of the High Court without a jury.

While the law was thus sternly enforced, important acts of conciliation and measures of reform were carried out simultaneously. In 1907 two natives, a Hindu and a Mahomedan, were appointed to the secretary of state's council; and in 1909 another native, a Hindu barrister, was for the first time appointed, as legal member, to the council of the viceroy. Occasion was taken of the fiftieth anniversary of the assumption by the crown of the government of India to address a message (on November 2, 1908) by the king-emperor to the princes and peoples, reviewing in stately language the later development, and containing these memorable words:—

"From the first, the principle of representative institutions began to be gradually introduced, and the time has come when, in the judgment of my viceroy and governor-general and others of my counsellors, that principle may be prudently extended. Important classes among you, representing ideas that have been fostered and encouraged by British rule, claim equality of citizenship, and a greater share in legislation and government. The politic satisfaction of such a claim will strengthen, not impair, existing authority and power. Administration will be all the more efficient if the officers who conduct it have greater opportunities of regular contact with those whom it affects and with those who influence and reflect common opinion about it."

The policy here adumbrated was (at least partly) carried into effect by parliament in the Indian Councils Act 1909, which reconstituted all the legislative councils by the addition of members directly elected, and conferred upon these councils wider powers of discussion. It further authorized the addition of two members to the executive councils at Madras and Bombay, and the creation of an executive council in Bengal also (subject to conditions) in other provinces under a lieutenant-governor. Regulations for bringing the act into operation were issued by the governor-general in council, with the approval of the secretary of state, in November 1909. They provided (*inter alia*) for a non-official majority in all of the provincial councils, but not in that of the governor-general; for an elaborate system of election of members by organized constituencies; for nomination where direct election is not appropriate; and for the separate representation of Mahomedans and other special interests. They also contain provisions authorizing the asking of supplementary questions, the moving and discussion of resolutions on any matter of public interest and the annual consideration of the contents of the budget. In brief, the legislative councils were not only enlarged, but transformed into debating bodies, with the power of criticizing the executive. The first elections took place during December 1909, with results that showed wide-spread interest and were generally accepted as satisfactory. The new council of the governor-general met in the following month.

**AUTHORITIES.**—Vincent A. Smith, *The Early History of India* (Oxford, 1904, 2nd ed., 1908); and *Asoka* ("Rulers of India" series, Oxford, 1901); J. W. McCrindle, *Ancient India* (1901); T. W. Rhys Davids, *Buddhist India* (1903); *Imperial Gazetteer of India* (1907-1909); Sir J. Campbell, *Gazetteer of Bombay* (1896); Stanley Lane-Poole, *Medieval India* ("Story of the Nations" series, 1903); *The Mahomedan Dynasties* (1894) and *The Mogul Emperors* (1892); H. C. Fanshawe, *Delhi Past and Present* (1902); Sir H. M. Elliot, *History of India as told by its own Historians* (1867). For the "unrest," its causation and history, see the series of articles in *The Times*, beginning July 16, 1910. (W. W. H.; J. S. Co.)

#### INDIAN COSTUME

Personal attire in India so far resembles a uniform that a resident can tell from a garb alone the native place, religion and social standing of the wearer. This is still true, though the present facility of intercommunication has had its effect in tending to assimilate the appearance of natives. Together with costume it is necessary to study the methods of wearing the hair, for each race adopts a different method.

The population of India, of which the main divisions are religious, falls naturally into four groups, (1) Mahomedans, (2) Hindus, (3) Sikhs, (4) Parsees. To these may be added

aboriginal races such as Bhils, Sonthals, Gonds, &c., whose costume is chiefly noticeable from its absence.

**Mahomedan Men.**—Apart from the two sects, Sunnis and Shias, whose garb differs in some respects, there are four families of Moslems, viz. Pathans, Moguls, Syeds and Sheikhs. The first came to India with Sultan Mahmud Ghaznavi in A.D. 1002; the second are of Tatar origin and came to India with Baber; the Syeds claim descent from Mahomet, while Sheikhs comprise all other Mussulmans, including converted Hindus. It is now no longer possible to distinguish these families by their turbans as was formerly the case.

**Hair.**—In the *hadis*, or traditional sayings of Mahomet other than those to be found in the Koran, it is laid down that the head is to be shaved and the beard to be allowed to grow naturally to "a legal" length, i.e. 7 or 8 in. long. This is known as *fitrah* or the custom of prophets. The beard is frequently dyed with henna and indigo for much the same reasons as in Europe by elderly men; this is entirely optional. The wearing of whiskers while shaving the chin was a Mogul fashion of the 17th and 18th centuries and is now seldom seen except among Deccani Mahomedans. The mustachios must not grow below the line of the upper lip, which must be clearly seen; a division or parting is made below the nose.<sup>1</sup> The lower lip is also carefully kept clear. Hair under the arms or elsewhere on the body except the breast is always removed.

Mahomedan clothing for indoor wear consists of three pieces: (a) Head-dress, (b) body-covering, (c) covering for the legs.

**Head-dress.**—This is of two kinds: the turban and the cap. The former is chiefly worn in northern India, the latter in Oudh and the United Provinces. What is known in Europe as a turban (from the Persian *tarband*, a binding for the head) is in India divided into two classes. The first, made of a single piece of cloth 20 to 30 in. wide and from 6 to 9 yds. long, is bound round the head from right to left or from left to right indifferently and quite simply, so as to form narrow angles over the forehead and at the back. This form is called *amamah* (Arabic), *dastār* (Persian), *shimlā* or *shamlā*, *safa*, *lungi*, *selā*, *rumāl*, or *dopattā*. The terms *amamah* and *dastār* are used chiefly with reference to the turbans of priests and *ulema*, that is learned and religious persons. They are usually white; formerly Syeds wore them of green colour. They are never of bright hue. The *lungi* is made of cloth of a special kind manufactured mostly in Ludhiana. It is generally blue and has an ornamented border. In the case of Pathans and sometimes of Punjabi Moslems it is bound round a tall red conical cap called a *kullāh* (Plate I. fig. 1): The ends are frequently allowed to hang down over the shoulders, and are called *shimlā* or *shamlā*, terms which also apply to the whole head-dress. The names *safa*, *selā*, *rumāl* and *dopattā* are sometimes given to this form of turban. The *selā* is gaudier and more ornamental generally; it is worn by the nobles and wealthier classes.

The second form of the turban is known as the *pagri*.<sup>1</sup> This head-dress is of Hindu origin but is much worn by Mahomedans. It is a single piece of cloth 6 to 8 in. wide, and of any length from 10 to 50 yds. The methods of binding the *pagri* are innumerable, each method having a distinctive name as *arabi* (Arab fashion); *mansabi* (official fashion, much used in the Deccan); *mushakhi* (sheik fashion); *chakridar* (worn by *hadjis*, that is those who have made the pilgrimage to Mecca); *khirki-dār* (a fashion of piling the cloth high, adopted by retainers of great men); *latudār* (top-shaped, worn by *kāyashis* or writers); *jordār* (the cloth twisted into rope shape) (Plate I. fig. 6); *siparālī* (shield-shaped, worn by the Shia sect); *murassa*, or *nastālikh* (ornately bound), *latpālī* (carelessly bound) (Plate I. fig. 4). Many other fashions which it would be difficult to describe can best be learned by studying pictures with the help of a competent teacher. The *chirā* is a *pagri* of checked cloth. The *mandil* is of gold or highly ornamented cloth; it is worn by nobles and persons of distinction.

The cap or *topi* is not bound round the head, but is placed

<sup>1</sup> This has been Englished by Anglo-Indians into "pugaree" or "pugree" and applied to a scarf of white cotton or silk wound round a hat or helmet as a protection against the sun.

upon it. It is made of cut and sewn cloth. Some varieties are *dopālārī*, a skull-cap; *kishinūmā*, or boat-shaped cap; *goltōpi*, a round cap of the kind known in England as "pork-pie"; *beswī*, or egg-shaped cap; *sigōshīā*, or three-cornered cap; *chaugōshīā*, or four-cornered cap; *tājdar*, or crown-shaped cap; &c. Many other caps are named after the locality of manufacture or some peculiarity of make, e.g. *Kashmirā-khōpi*; *jhalardār*, fringed cap, &c.

A form of cap much worn in Bengal and western India is known as *Irānī kullāh*, or Persian cap. It is made of goatskin and is shaped like a *tārbāsh* but has no tassel. The cap worn in cold weather is called *top*, *lopa*, or *kantop* (ear-cover) (Plate I. fig. 2); these are sometimes padded with cotton. Caps are much worn by Mussulmans of Delhi, Agra, Lucknow and other cities of the United provinces.

The *tārbāsh* or *tārki-topi* was introduced into India by Sir Sayyid Ahmad (Plate I. fig. 3). It must not be confused with the Moorish "fez," which is skull-shaped. The *tārbāsh* is of Greek origin and was adopted by Sultan Mahmud of Turkey in the early part of the 19th century. To remove the head-dress of whatever kind is, in the East, an act of discourtesy; to strike it off is a deep insult.

**Clothing.**—The following rules from the *hadith* or traditional sayings of the prophet are noteworthy:—"Wear white garments, for verily they are full of cleanliness, and pleasant to the eye." "It is lawful for the woman of my people to clothe herself in silken garments, and to wear ornaments of gold; but it is forbidden to man: any man who shall wear silken garments in this world, shall not wear them in the next." "God will not be merciful to him who through vanity wears long trousers" (i.e. reaching below the ankle). The foregoing rules are now only observed by the ultra-orthodox, such as the Wāhābī sect and by *ulemas*, or learned elderly men. The Mogul court of Delhi, especially during the reign of Mahomed Shah, nicknamed *Kanglā* or the "dandy," greatly influenced change in these matters. Coloured clothing, gold ornaments and silken raiment began to be worn commonly by Mussulman men in his reign.

For the upper part of the body the principal article of clothing is the *kurtā*. The Persian name for this is *paīrahan* and the Arabic *kamis*, whence "chemise." This *kurtā* is the equivalent for the shirt of Europe. It is usually of white cotton, and has the opening or *galā* in front, at the back, or on either side indifferently. It was formerly fastened with strings, but now with the *ghundī* (the old form of button) and *tukmah* or loop. In southern India, Gujarat and in the United Provinces the *kurtā* is much the same as to length and fit as the English shirt; as the traveller goes northward from Delhi to the Afghan border he sees the *kurtā* becoming longer and looser till he finds the Pathan wearing it almost to his ankles, with very full wide sleeves. The sleeves are everywhere long and are sometimes fastened with one or two buttons at the wrist.

Mussulmans always wear some form of trousers. They are known as *isār* (Arabic) or *pa'ejāma*<sup>2</sup> (Persian). This article of clothing is sometimes loose, sometimes tight all the way, sometimes loose as far as the knee and tight below like Jodhpur riding breeches. They are fastened round the waist with a scarf or string called *kamārband* (waistband) or *isārband*, and are usually of white cotton. The varieties of cut are *sharāi* or canonical, orthodox, which reach to the ankles and fit as close to the leg as European trousers; *rumī* or *gharāredār*, which reach to the ankles but are much wider than European trousers (this pattern is much worn by the Shias); and *lang* or *chust*, reaching to the ankles, from which to the knee they fit quite close. When this last kind is "rucked" at the ankle it is called *churidār* (Plate I. fig. 4). They are sometimes buttoned at the ankle, especially in the Meerut district. The *shatwār* pattern,

<sup>2</sup> Anglicized as "pyjamas" (in America "pajamas"), the term is used of a form of night-wear for men which has now generally superseded the night-shirt. This consists of a loose coat and trousers of silk, wool or other material; the trousers are fastened by a cord round the waist.





FIG. 1.—Punjabi Mahomedan wearing *lungi* bound round a red or gold *kullak*.



FIG. 2.—Mahomedan Saint, *pir*, wearing the *kantiop*, ear-cap.



FIG. 3.—Student of the Aligarh College wearing the *turbush*.



FIG. 4.—Punjabi Mahomedan wearing *pagri* with *shimla*, *achkan izâr* or *pajamas*.



FIG. 5.—Bombay or Gujarati Bora wearing white and gold turban with red top.



FIG. 5.—Mahomedan Jat cultivators. Wife:—with *izâr*, *kurta*, and *ornhi* or *chadar*; husband:—with *majba*, *chodar*, and *joridar pagri*.



FIG. 7.—The Parsi *khoka*, a tall hat of glazed chintz



FIG. 8.—Parsi woman wearing Parsi *sari* and *methabana* or white hair cover.



FIG. 9.—Parsi schoolgirl.



FIG. 10.—Parsi *pâth* hat with felt brim.



FIG. 1.—Deccan Brahman wearing *pagri*, *dhoti* or *pitamber*, *angā* and *dupatta*.



FIG. 2.—Brahman wearing *dhoti* and *janeu* or sacred thread. This is the dining and sacrificial dress of most Hindus.



FIG. 3.—Rajput wearing *chapeau*, which is worn both by Mussulmans and Hindus, buttoning on different sides.



FIG. 4.—Hindu woman showing method of wearing the *sari*.



FIG. 5.—Bengali *Babū* wearing the most popular form of the embroidered cap.



FIG. 6.—Sikh devotee, *Akālī* or *Nihing*, vowed to the wearing of blue and steel, &c.

very large round the waist and hanging in folds, is worn by Pathans, Baluchis, Sindis, Multanis, &c.

The new fashion in vogue amongst the younger generation of Mussulman is called the *ikhārāh* or *patālānnumā*, which is like the European trousers. They are usually made of calico; they have no buttons but are fastened with string (*kamarband*). Bathing drawers are called *ghūlānāh* and reach to the knee. The tight drawers worn by wrestlers are called *janghiāh*.

Garments for outdoor wear are the *angā*, or *angarkhā*, the *chapkan*, the *achkan* or *sherwāni*; the *angā*, a coat with full sleeves, is made of any material, white or coloured. It is slit at the sides, has perpendicularly cut side-pockets, and is fastened with strings just below the breast. It is opened on the right or left side according to local custom. The *angā* is now considered old-fashioned, and is chiefly worn by elderly men or religious persons. It is still not uncommon in Delhi, Agra, Lucknow and at native courts, but is being superseded by the *achkan* (Plate I. fig. 4), which is buttoned straight down the front. Both *angā* and *achkan* reach to a little below the knee, as also does the *chapkan*, a relic of Mogul court dress, best known as the shield-like and highly adorned coat worn by government *chhaprasis* (Plate II. fig. 3). Over the *angā* is sometimes worn an overcoat called a *chogā*; this is made of any material, thick or thin, plain or ornamented; it has one or two fastenings only, loops below the breast whence it hangs loosely to below the knees. The *chogā* is sometimes known by its Arabic names *abā* or *kabā*, terms applied to it when worn by priests or ulema. In cold weather Pathans and other border residents wear *postens*, sleeved coats made of sheepskin with the woolly side in. In India farther south in cold weather an overcoat called *daglā* is worn; this is an *angā* padded with cotton wool. A padded *chogā* is called *labādā*; when very heavily padded *farghū*. Whereas the European wears his waistcoat under his coat, the Indian wears his over his *angā* or *chapkan* (not over the *achkan*). A sleeveless waistcoat generally made of silk is called a *sadari*; when it has half sleeves it is called *nimastīn*; the full-sleeved waistcoat worn in winter padded with cotton is called *mirzāi*. For ceremonial purposes a coat called *jāmā* is worn. This fits closely as to the upper part of the body, but flows loosely below the waist. It is generally white, and is fastened in front by strings.

In Gujarat and other parts of western India are to be found classes of Moslems who differ somewhat from those met with elsewhere, such as Memans, Borās and Khojās. The first are Sunnis: the two last Shias. Memans wear (1) a gold embroidered skull-cap, (2) a long *kamis* fastened at the neck with 3 or 4 buttons on a gold chain, (3) *sadariya*, i.e. a tight waistcoat without sleeves, fastened in front with small silk buttons and loops, (4) an over-waistcoat called *shayy-sadriya* instead of the *angā*, with sleeves, and slits at the sides (probably of Arab origin). When he does not wear a skull-cap his *amāmāh* is made after the arched Arab form, or is a Kashmir scarf wound round a skull-cap made of Java straw. The Borā adopts one of four forms of pagri; the *Ujjaini*, a small neatly bound one; the *Ahmaddādā*, a loose high one; the *Surat*, fuller and higher than the *Ujjaini* pattern (Plate I. fig. 5); or the *Kathiwādā*, a conical turban with a gold stripe in the middle of the cone. The Borā wears the *angā*, otherwise he resembles the Meman. The Khojā wears a *pagri* smaller than the Meman's, called a *Moghālāi pheitā*; this leaves a portion of the head bare at the back. The material is always of *kashida*, a kind of embroidered cloth. Amongst Mahomedans only Pathans wear ear-rings.

MAHOMMEDAN WOMEN. *Head-dress*.—The *rupatta* (also called *dopatta*), or veil, is of various colours and materials. Its length is about 3 yds., its width about 1½. It is worn over the head and thrown over the left shoulder. It is considered essential to modesty to cover the head. This head-dress is also known as *ornā*, *ornī*, *pochan*, *pochni* (Baluchistan and western India) *chundri*, *reo* (Sind), *sipatta*, *takrai* or *chadar* (Pathan). Among the poorer classes it is called *pacholi*. Farther south in India when of thicker material it is called *chadar* or *chaddar*. It is called *pacheti*, *potra* or *malayā* by Meman, Borā and Khojā women. As a rule married women wear brighter colours than

unmarried ones. In Kashmir a small round cap, *goltopi*, is worn. The *kassawa* is a handkerchief bound over the head and tied at the back, and is worn by Mohammedan women indoors to keep the hair tidy; Mahomedan women plait their hair and let it hang down behind (Plate I. fig. 6).

*Clothing*.—A short jacket fastened at the back and with short sleeves is worn. It may be of any material. In Sind, Gujarat and other parts of western India it is called a *choli*. It is also very generally known as *angiyā*. Other common names are *mahrām* and *sināband* (breast-cover). The *kūrtā* is a sort of sleeveless shirt, open in front and reaching to the waist. It may be of any material. When this is worn with the *angiyā* it is worn over it. This combination of dress is worn only by young married women. In Kashmir and northern India generally the *angiyā* is not worn, and the *kūrtā* is worn instead. This is like the *kamis* of the man, already described; it has full sleeves, is open at the front, which is embroidered, and reaches to the knee or lower. Among Pathans there are two kinds of *kūrtā* (*kamis* or *khat*); one worn by married women called *girādnā khat* is dark red or blue, embroidered with silk in front; the *jalānā khat* worn by unmarried women is less conspicuous for colour and ornament. A large pocket (*job*) is often seen on in front like the Highlander's sporran.

The *Pañjāmās*, also called *zār*, are cut like those of men, and known by the same names. They differ only in being of silk or other fine material and being coloured (Plate I. fig. 6). Among Pathans they are called *partog* or *partek* (*pardak*), and those of unmarried girls are of white, while married women wear them of *swsi*, a kind of coloured silk or cotton. As a general rule the wearing of *pañjāmās* is the chief distinction between Mussulman and Hindu women. In the Shahpur and other districts, however, where Mahomedans have followed Hindu customs, Moslem women wear the *majlā*, a cloth about 3 yds. long by 1½ wide tied tightly round the waist so as to fall in folds over the legs. Even Mahomedan men sometimes wear the *majlā* in these districts. This form of dress is known among Moslems as *lahband* [lower binding] (Plate I. fig. 6). In Rajputana, Gujarat and the southern Punjab, Mahomedan women sometimes wear a *lhengā* or *ghagra* skirt without trousers; in the Sirsa district and parts of Gujarat the *ghagra* is worn over the trousers. The *sadari* or waistcoat is worn by women as well as men. The *tillak* or *peshwas* is a dress or robe the skirt and bodice of which are made in one piece, usually of red or other coloured material; it is common in Gujarat, Rajputana and the Sirsa district, and is the style usually adopted by nautch girls when dancing. Meman women wear also the *abā*, or overcoat, which differs from that worn by men in that it has loose half sleeves, and fastens with two buttons at each side of the neck over the shoulders; it is embroidered on the breast, and adorned with gold lace on the skirts.

In Delhi, Lucknow, Agra and other towns in the Punjab and the United Provinces a special wedding dress is worn by the bride, called *rū-kōjārā*, the "dress of custom." It is worn on the wedding night only; and it is a rule that no scissors are employed in making it. The trouser string of this dress is not the usual *kamarband*, but is made of untwisted cotton thread called *kalwā*. Out of doors Mahomedan women wear the *būrkā*, a long loose white garment entirely covering the head and body. It has two holes for the eyes. Mahomedan women pencil the eyes with *kohl* or *sūrmā*, use *missi* for the teeth and colour the palms and nails of the hand with henna. A nose-ring is a sign of marriage.

HINDUS.—Caste does not influence dress amongst Hindus as much as might be expected. The garment distinctive of the Hindus of all castes, men and women, all over India, is the *dhoti* or loin cloth. It is a very ancient dress, and their gods are represented as clothed in it in old sculptures.

The general term used for clothing is *kaprā*, *latā* or *luḡā*. Under Mahomedan influence Hindu clothing developed into "suits," consisting of five pieces for men, hence called *pancho tuk kapra*—(1) head-dress, (2) *dhoti*, (3) coat, (4) *chaddor* or sheet, (5) bathing cloth; and three for women, hence called *tin tuk*—(1) *dhoti*, (2) jacket, (3) shawl.

**Men.**—The Hindu (except the Rajput) shaves his head, leaving only a top-knot on the point of the skull. He shaves the face (except the eye-brows) and his body. The Rajput wears a full beard and whiskers, usually parted in the middle. He sometimes draws the beard and whiskers to the side of the head, and to keep it tidy wraps round it a cloth called *dhātā* or *galmochā*.

**Head-dress.**—Hindus wear sometimes turbans and sometimes caps. When the turban is worn it is always of the *pagri* form, never the *amāmāh*. Hindus wind the *pagri* in various ways as described for Mussulmans, but the angles are formed over the ears and not from front to back. Mahrrattas wear flat red *pagris*, with a small conical peak variously shaped and placed. The *pagri* is known in different parts of India as *pāg*, *phentā*, *phag*, *phagdī* and many other names. In Bengal a sort of turban is worn which can be taken off like a hat. When Hindus wear caps or *topīs* they resemble those worn by Mahomedans, but they never wear the *ṣa*, *tārūsh* or *irānī topī*. In Gaya a peculiar cap made of *tāl* leaves is worn in rainy weather, called *ghungā*. Bengalis, whether Brahmans or of other castes, frequently go bareheaded.

**Body Clothing.**—The *dhōti* is a simple piece of cloth (cotton), generally white. It is wound round the loins, the end passed between the legs from front to back and tucked in at the waist behind (Plate II. fig. 2). The small form of *dhōti* worn by men of the lower class is called *lanḡoti*. It does not fall below mid-thigh. A Brahman's *dhōti*, as also that of some other castes, reaches to a little below the knee; a Rajput's to his ankles. The *dhōti* is known under many names, *dhūtīa*, *pitambar*, *luṅgi*, &c. In some parts of India half the *dhōti* only is wound round the loins, the other half being thrown over the left shoulder. Some upper classes of Hindus wear for coat the *kūrtā*; most wear the *anḡharkā* (Plate II. fig. 1), a short *anḡrā* reaching to the waist. It is also known as *kamri*, *baktari*, *badan* or *bandi*. Hindus wear the *anḡharkā* or *anḡrā* as Mahomedans do, but whereas the Mahomedan has the opening on the left the Hindu wears it on the right. When the *kūrtā* is worn it is worn under the *anḡrā*. The *chaddār* (*chaddar* or *dopatta*) is of various kinds. It is a piece of cotton cloth 3 yds. long by 1 yd. wide. It is worn across the shoulders, or wrapped round the body, but when bathing, round the loins. Hindus, both men and women, wear ear-rings.

The *Brahminical thread* (*janeu*) (Plate II. fig. 2) is a cord made of twisted cotton prepared with many ceremonies. It is worn over the left shoulder and hangs down to the right hip. It is of three strands till the wearer is married, when it becomes six or nine. It is 96 handbreadths in length, and is knotted. Rajputs also wear this thread, similar in make and length, but the knots are different.

Caste and sect marks also distinguish Hindus from each other. **Women.**—The hair is sometimes worn plaited (*chōli*), usually an odd number of thin plaits made into one large one, falling down the back and fastened at the end with ribbons. Another style is wearing it in a knot after the ancient Grecian fashion; it is always worn smooth in front and parted in the middle. Over the head is worn the *orina* or veil. The end is thrown over the left shoulder in such a manner as to conceal the breast. On the upper part of the body the *kūrtā* is sometimes worn. A bodice called *anḡiyā* is worn. This covers the breast and shoulder; it has half sleeves, is very short, and is fastened at the back with strings.

The skirt is called *lhenḡa* or *ghagra*. It is worn mostly in Rajputana hanging in full flounces to the knee or a little below. In Bengal, Madras and Bombay Presidencies women do not wear a skirt, only a *chōli* and *sāri*. This last is a long piece of cotton or silk cloth. Half is draped round the waist and hangs to the feet in folds; the remainder is passed over the head and thrown over the left shoulder (Plate II. fig. 4).

**Sikh.**—The Sikh does not shave or cut his hair. The beard is parted in the middle and carried up each side of the face to the top of the head. A piece of cloth called *dhātā* or *galmochā* is wound round the chin and head so as to keep the hair clean and tidy. The hair of the head is tied into a knot (*kes*) at the top of the head or at the back, a distinguishing mark of the

Sikh. His religion requires the Sikh to carry five articles—*kes*, the knot of hair on the head; the *kanga*, a comb; the *kard*, a knife; the *kach*, a pair of short trousers peculiar to the Sikh; and the *khurā*, an iron bangle on the wrist. It is de *rigueur* that he should carry some piece of iron on his person. His head-dress he calls a *pāg*; it is a turban of *amāmāh* shape but enormously large. The Sikh nobility and gentry wear two turbans, either both of *pagri* form or one of *pagri* and one of *amāmāh* form. Each is of a different colour.

The Sikh calls his *kūrtā jhaggā*; it is very large and loose, bound with a scarf round the waist. The *kach* is a sort of knickerbockers reaching to just below the knee, which they encircle tightly. Over all the Sikh wears the *choga*. In outlying villages he wears instead of the *kūrtā* a *chōdar* or cloth, which he calls *khes*, on the upper part of his body. Some village Sikhs wear a *labband* or waistcloth instead of the *kach*. Sikhs are fond of jewelry and wear ear-rings. The dress of Sikh women does not differ greatly from that of Hindu women; but in the Sirsa district and some other parts she wears the Mahomedan *sutan* or trousers, under the *lhenḡa* or skirt. There is a small sect of Sikh known as *Akālī* or *Nihang*. Their dress is entirely of dark blue colour, the turban being also blue, high and pointed; on it are fastened three steel galls. The quoit was the ancient weapon of the Sikh, who calls it *chakar*. Certain steel blades are stuck through the body of the turban. The Akālīs also wear large flat iron rings round the neck and arms (Plate II. fig. 6).

**PARSIS.**—When the Parsis were first admitted into India, certain conditions were imposed upon them by the Hindus; among others they were not to eat beef, and they were to follow the Hindu custom of wearing a top-knot of hair. Old-fashioned Parsis in country districts still follow these customs. To uncover the head is looked upon as a sin; hence Parsis of both sexes always wear some head covering whether indoors or out. In the house the man wears a skull cap; out of doors the older Parsis wear the *khōka*, a tall hat, higher in front than at the back, made of a stiff shiny material, with a diaper pattern (Plate I. fig. 7). The younger generation adopted a round pitch hat with a rolled edge of felt, but, under the influence of the *szadeshi* movement, they have generally reverted to the older form (Plate I. fig. 10). Next to the skin the Parsi wears a *sadra* or sacred shirt, with a girdle called *kastī*. Over the *sadra* a white cotton coat is worn, reaching to a little below the waist. The Parsi wears loose cotton trousers like a Mussulman. In country districts he wears a *jāmā*, and over the *jāmā* a *pechōdī* or shoulder cloth. The young Parsi in Bombay has adopted European dress to a great extent, except as to head-gear. The Parsi woman dresses her hair in the old Greek fashion with a knot behind. She also wears a *sadra* or sacred shirt. Country Parsis in villages wear a tight-fitting sleeveless bodice, and trousers of coloured cloth. Over all she winds a silken *sari* or sheet round the body; it is then passed between the legs and the end thrown over the right shoulder. Out of doors she covers her head and right temple (Plate I. fig. 8). In towns the *sari* is not passed between the legs, but hangs in loose folds so as to hide the trousers. The upper classes wear a sleeved *polka* jacket instead of the bodice. Parsi children up to the age of seven wear cotton frocks called *jabbān*. They wear long white trousers of early Victorian cut, with frills at the bottom. They wear a round cap like a smoking-cap. The little girls wear their hair flowing loose (Plate I. fig. 9).

**SHOES.**—There is no distinction between the shoes worn by Hindus, Moslems, Sikhs or Parsis, but Hindus will not wear them when made of cow's leather. Shoes are called *jūta*, *jūtī* or *jute* by Mahomedans, and *jore* or *zore* by Hindus. Shoes are usually distinguished by the name of the material, as *nārī kā jūta*, leather shoes, *banatī jūta*, felt shoes, and so on.

There are innumerable styles of cut of shoe, three being the commonest: (1) *Salmishahi*, these are shaped like English slippers, but are pointed at the toe, terminating in a thin wisp turned back and fastened to the instep. They are mostly made of thin red leather, plain in the case of poorer people and richly

embroidered in the case of rich people. This cut of shoe is most in vogue amongst Moslems. (2) *Gol panjē ki jūtī*, like English slippers, but rounded at the toes. (3) *Ghēlā or nāghāni* (snake's head) *jūtī*, the toe is turned up, while the back part is folded inwards and trodden under the heel. Ladies usually wear shoes of this fashion, known as *phiri jūtī*. Women's shoes differ only in size and in being made of finer material, and in being embroidered. Hindu women seldom wear shoes. On the northern frontier the pattern known as the *kaishī* is worn; this is a slipper having neither sides nor back; the sole towards the heel is narrow and raised by a small iron-shod heel. In the hills shoes resembling sandals, called *chāpīs*, made of wood, straw or grass are worn. The soles are very thick, and are secured with straps; there is generally a loop for the big toe. They are known as *phūkarrū* in Kashmir, and *pūta* in Kulu and Chamba.

Shoes are invariably removed on entering mosques or other holy places. It is also customary to remove them when entering a house. Orientals sit on the floor in preference to chairs; hence it is thought very necessary by them that the carpet should be kept clean, which could not be done were persons to keep their shoes on. While it would be considered a breach of good manners to enter a room with the shoes on, an exception has been made in favour of those natives who have adopted European boots or shoes. The babus of Bengal have taken to English-made shoes of patent leather worn over white socks or stockings.

**AUTHORITIES.**—The Indian section of the Victoria and Albert Museum (London) includes an exhibition of oriental dress; and the library of the India Office many prints and photographs. The following books may be consulted: *Coloured Drawings illustrating the Manners and Customs of Natives of India* (originally prepared by order of the marquis Wellesley, Governor-General; vide Council minute dated 16th August, 1866) (1 vol.); J. Forbes Watson and J. W. Kaye, *The People of India*; F. Baltazar Solovyns, *Les Hindous* (4 vols. illustrated, Paris, 1808); India Office Library, 3 small portfolios of pictures of Katch and Bombay men and women; *Costume of Bala Ghat* (Carnatic), S. E. India (large water-colours, India Office Library); Illustrations of various tribes in Kashmir, by Indian artists (India Office Library); R. H. Thalbot, *Portrait Gallery of Western India* (1886) (chiefly portraits of Parsi nobles); Edward Tuite Dalton, C.S.I., *Descriptive Ethnology of Bengal* (1 vol., 1872); Talboys Wheeler, *History of the Imperial Assembly at Delhi, 1st January 1877*; *Queen Victoria's Jubilee, 6th February 1887* (in Urdu, illustrated); T. H. Hendley, C.I.E., V.D., *Rulers of India and Chiefs of Rajputana* (London, 1897)—the last three are useful for the study of ceremonial dress; G. A. Grierson, *Bihar Peasant Life* (Calcutta, 1888; this is a most valuable work of learning and research; in division 2, subdivision 3, chapter 1, on clothes, will be found names and descriptions of every article of clothing used in south, central and eastern India); H. B. Baden-Powell, *Handbook of Manufactures and Arts of the Punjab* (Lahore, 1872); W. W. Hunter, *Statistical Account of Bengal* (1875); Hughes' *Dictionary of Islam* (London, 1895); Sir Denzil Ibbetson, *Outlines of Punjab Ethnography*; E. Thurston, *Castes and Tribes of Southern India*. It is to be hoped that steps will shortly be taken to arrange articles of costume now displayed at the Indian Section, Victoria and Albert Museum, in some systematic order so as to assist students in arriving at a scientific knowledge of the subject. (C. G.)

**INDIA, FRENCH**, a general name for the French possessions in India—on the Coromandel coast, Pondicherry, Karikal and Yanam; on the Malabar coast, Mahé; and in Bengal, Chandernagore. In addition there are a few "lodges" elsewhere, but they are merely nominal remnants of French factories. The total area amounts to 203 sq. m., of which 113 sq. m. belong to the territory of Pondicherry. In 1901 the total population amounted to 273,185. By decree of the 25th of January 1879 French India was provided with an elective general council and elective local councils. The results of this measure have not been very satisfactory, and the qualifications for and the classes of the franchise have been modified. The governor resides at Pondicherry, and is assisted by a council. There are two tribunals of first instance (at Pondicherry and Karikal), one court of appeal (at Pondicherry) and five justices of the peace. The agricultural produce consists of rice, earth-nuts, tobacco, betel nuts and vegetables.

**History.**—The first French expedition to India is believed to have taken place in the reign of Francis I., when two ships were fitted out by some merchants of Rouen to trade in eastern

seas; they sailed from Havre in that year and were never afterwards heard of. In 1604 a company was granted letters patent by Henry IV., but the project failed. Fresh letters patent were issued in 1615, and two ships went to India, only one returning. *La Compagnie des Indes* was formed under the auspices of Richelieu (1624) and reconstructed under Colbert (1664), sending an expedition to Madagascar. In 1667 the French India Company sent out another expedition, which reached Surat in 1668, where the first French factory in India was established. In 1672 Saint Thomé was taken, but the French were driven out by the Dutch and retired to Pondicherry (1674). In 1741 Duplex became governor of Pondicherry and in 1744 war broke out between France and England; for the remaining history of the French in India see INDIA.

See Haurigot, *French India* (Paris, 1887); Henrique, *Les Colonies françaises* (Paris, 1889); Lee, *French Colonies* (Foreign Office Report, 1900); *L'Année coloniale* (Paris, 1900); and F. C. Danvers, *Records of the India Office* (1887).

**INDIANA**, a north-central state of the United States of America, the second state to be erected from the old North-West Territory; popularly known as the "Hoosier State." It is located between latitudes 37° 41' and 41° 50' N. and longitudes 84° 49' and 88° 2' W. It is bounded on the N. by Michigan and Lake Michigan, on the E. by Ohio, on the S. by Kentucky from which it is separated by the Ohio river, and on the W. by Illinois. Its total area is 36,350 sq. m., of which 440 sq. m. are water surface.

**Physiography.**—Topographically, Indiana is similar to Ohio and Illinois, the greater part of its surface being undulating prairie land, with a range of sand-hills in the N. and a chain of picturesque and rocky hills, known as "Knobs," some of which rise to a height of 500 ft., in the southern counties along the Ohio river. This southern border of hills is the edge of the "Cumberland Plateau" physiographic province. In the northern portion of the state there are a number of lakes, of glacial origin, of which the largest are English Lake in Stark county, James Lake and Crooked Lake in Steuben county, Turkey Lake and Tippecanoe Lake in Kosciusko county and Lake Maxinkuckey in Marshall county. In the limestone region of the south the numerous caves, the most noted being the Crystal Cave in Crawford county, next to Mammoth Cave, the largest in the United States. In the southern and south-central part of the state, particularly in Orange county, there are many mineral springs, of which the best known are those at French Lick and West Baden. The larger streams flow in a general south-westerly direction, and the greater part of the state is drained into the Ohio through the Wabash river and its tributaries. The Wabash, which has a total length of more than 500 m., has its headwaters in the western part of Ohio, and flows in a north-west, south-west, and south direction across the state, emptying into the Ohio river and forming for a considerable distance the boundary between Indiana and Illinois. It is navigable for river steamboats at high water for about 350 m. of its course. Its principal tributaries are the Salamanie, Mississinewa, Wild Cat, Tippecanoe and White rivers. Of these the White river is by far the most important, being second only to the Wabash itself in extent of territory drained. It is formed by the confluence of its East and West Forks, almost 50 m. above its entrance into the Wabash, which it joins about 100 m. above the Ohio. Other portions of the state are drained by the Kanawake, a tributary of the Illinois; the St. Joseph and its principal branch, the Elkhart, which flow north through the western corner of Michigan and empty into Lake Michigan; the St. Mary's and another St. Joseph, whose confluence forms the Maumee, which empties into Lake Erie; and the White Water, which drains a considerable portion of the south-west part of the state into the Ohio.

**Flora and Fauna.**—The flora of the state is varied, between 1400 and 1500 species of flowering plants being found. Among its native fruits are the persimmon, the paw-paw, the goose plum and the fox grapes. Cultivated fruits, such as apples, pears, peaches, plums, grapes and berries, are raised in large quantities for the market. The economic value of the forests was originally great, but there has been reckless cutting, and the timber-bearing forests are rapidly disappearing. As late as 1880 Indiana was an important timber-producing state, but in 1900 less than 30 % of the total acreage of the state—only about 10,800 sq. m.—was woodland, and on very little of this land were there forests of commercial importance. There are about 110 species of trees in the state, the commonest being the oak. The bald cypress, a southern tree, seems to be an anomalous growth. Blue grass is valuable for grazing and hay-making. The principal crops include Indian corn, wheat, oats, potatoes, buckwheat, rye and clover.

The fauna originally included buffalo, elk, deer, wolves, bear, lynx, beaver, otter, porcupine and puma, but civilization has driven them all out entirely. Rattlesnakes and copperheads were formerly common in the south. The game birds include quail (Bob White), ruffed

grouse and a pine finned grouse (once very plentiful, then nearly exterminated, but now apparently reappearing under strict protection), and such water birds as the mallard duck, wood duck, blue- and green-winged teals, Wilson's snipe, and greater and lesser yellow legs (snipe). The song birds and insectivorous birds include the cardinal grosbeak, scarlet and summer tanagers, meadow lark, song sparrow, catbird, brown thrasher, wood thrush, house wren, robin, blue bird, goldfinch, red-headed woodpecker, flicker (golden-winged woodpecker), and several species of warblers. The game fish include the bass (small-mouth and large-mouth), brook trout, pike, pickerel, and muskallong, and there are many other large and small food fish.

**Climate.**—The climate of Indiana is unusually equable. The mean annual temperature is about 52° F., ranging from 49° F. in the north to 54° in the south. The mean monthly temperature varies from 25° in the months of December and January to 77°-79° in July and August. Cold winds from the Great Lakes region frequently cause a fall in temperature to an extreme of -25° F. in the north and north central parts of the state. The mean annual rainfall for the entire state is about 43 in., varying from 35 in. in the north to 46 in. in the Ohio Valley.

The soil of the greater part of the state consists of a drift deposit of loose calcareous loam, which extends to a considerable depth, and which is exceedingly fertile. In the Ohio and White Water river valleys, sandstone and limestone formation predominates. The north and north central portions of the state, formerly rather swampy, have become since the clearing of the forests as productive as the south central. The most fertile part of the state is the Wabash valley; the least fertile the sandy region, of small extent, immediately south of Lake Michigan.

**Industry and Manufactures.**—Agriculture has always been and still is the chief industry of the state of Indiana. According to the census of 1900, 94.1% of the land area was included in farms, and of this 77.2% was improved. The proportion of farms rented comprised 28.6% of the whole number, four-fifths of these being rented on a share basis. The average size of farms, which in 1850 was 136 acres, had decreased to 105 acres in 1880 and to 97.4 acres in 1900. The value of the farm property increased from \$726,781,857 in 1880 to \$978,616,471 in 1900. The farms are commonly cultivated on the three-crop rotation system. The proximity of such good markets as Chicago, Cincinnati, St. Louis and Louisville, in addition to the local markets, and the unusual opportunities afforded by the railways that traverse every portion of the state, have been important factors in the rapid agricultural advance which has enabled Indiana to keep pace with the newly developed states farther west. Indiana was ninth in the value of its agricultural products in 1880, and retained the same relative rank in 1899, although the value had become considerably more than doubled, increasing from \$64,758,000 in 1880 to \$204,450,106 in 1899. The principal crops in which the state has maintained a high relative rank are Indian corn, wheat and hay; the acreage devoted to each of these increased considerably in the decade 1890-1900. In 1907, according to the Department of Agriculture, the acreage of Indian corn was 4,600,000 acres (7th of the states), and the yield was 168,840,000 bushels (5th of the states); of wheat, 2,362,000 acres (6th of the states) was planted, and the crop was 34,013,000 bushels (7th of the states); and 2,328,000 acres of hay (the 8th largest acreage among the states of the United States) produced 3,143,000 tons (the 8th largest crop). Other important staple crops are oats, rye and potatoes, of which the crops in 1907 were respectively 36,683,000 bushels, 961,000 bushels, and 7,308,000 bushels. There are no well-defined crop belts, the production of the various crops being general throughout the state, except in the case of potatoes, most of which are raised in the sandy regions of the north. The value of the orchard products is large, and is steadily increasing; in the decade 1890-1900 the number of pear trees increased from 204,579 to 868,184, and between 1880 and 1899 the crop increased from 157,707 to 231,713 bushels. Of apple trees, which surpass all other orchard trees in number, there were more than 8,600,000 in 1900. The total value of the state's orchard products in 1899 was \$3,166,338, and the value of small fruits was \$1,113,527. The canning industry both for fruits and small vegetables has become one of much importance since 1890.

Stock-raising is an industry of growing importance, the value of the live stock in the state increasing from \$71,068,758 in 1880 to \$93,361,422 in 1890 and \$109,550,761 in 1900. Sheep-raising, however, which is confined largely to the north and east portions of the state, decreased slightly in importance between 1890 and 1900. The value of the dairy products sold in 1899 (census of 1900) was \$8,027,370, nearly one-half of which was represented by butter; and the total value of dairy products was \$15,739,504.

In the value, extent and producing power of her manufacturing industries Indiana has made remarkable advance since 1880. This increase, which more than kept pace with that of the country as a whole, was due largely to the advance among what may be termed the unusual shipping facilities afforded by the network of railways, the discovery and development of natural gas, and the proximity of coal fields, the gas and the coal together furnishing an ample supply of cheap fuel. The number of manufacturing establishments (under the "factory" system) within the state was 7128 in 1900, 7044 in 1905; their invested capital was \$219,321,080 in 1900 and \$312,071,234 in 1905, an increase of 42.3%; and the value of their

total product was \$337,071,630 in 1900 and \$393,954,405 in 1905, an increase of 16.9%. The most important manufactured products in 1905 were flour and grist mill products, valued at \$36,473,543; in 1900, when they were second in importance to slaughter-house products and packed meats, they were valued at \$29,037,843. Next in importance in 1905 was the slaughtering and meat-packing industry, of which the total product was valued at \$29,352,939; in 1900 it was valued at \$43,862,273. Other important manufactured products were: those of machine shops and foundries, the value of which increased from \$7,228,096 in 1900 to \$23,108,516 in 1905, or 321%; distilled liquors, the value of which had increased from \$16,961,098 in 1900 to \$20,520,261 in 1905, an increase of 21%; iron and steel, valued at \$19,338,481 in 1900 and at \$16,920,326 in 1905; carriages and wagons, valued at \$12,661,217 in 1900 and at \$15,228,337 in 1905; lumber and timber products, valued at \$19,979,971 in 1900 and at \$14,559,662 in 1905; and glass, valued at \$14,757,883 in 1900 and at \$14,706,929 in 1905—this being 3.7% of the product value of all manufactures in the state in 1905, and 18.5% of the value of glass produced in the United States in that year. The growth in the preceding decade of the iron and steel industry, the products of which increased in value from \$4,742,760 in 1890 to \$19,338,481 in 1900 (307.7%), and of the manufacture of glass, the value of which more than doubled from \$8,995,416 in 1890 to \$14,757,883 in 1900 (392.7%), is directly attributable to the development of natural gas as fuel; the decrease in the value of the products of these same industries in 1900-1905 is partly due to the growing scarcity of the natural gas supply. As compared with the other states of the United States in value of manufactured products, Indiana ranked second in 1900 and in 1905 in carriages and wagons, glass and distilled liquors; was seventh in 1900 and fourth in 1905 in furniture; was fourth in 1900 and seventh in 1905 in wholesale slaughtering and meat-packing; was fifth in 1900 and sixth in 1905 in agricultural implements; and in iron and steel and flour and grist mill products was fifth in 1900 and eighth in 1905. The most important manufacturing centres are Indianapolis, Terre Haute, Evansville, South Bend, Fort Wayne, Anderson, Hammond, Richmond, Muncie, Michigan City and Elwood, each having a gross annual product of more than \$6,000,000.

According to the annual report on *Mineral Resources of the United States for 1906*, Indiana ranked fifth in the Union in the value of natural gas produced, sixth in petroleum, and sixth in coal. Natural gas was discovered in 1886 in the east-central part of the state, and its general application to manufacturing purposes caused it an industrial revolution in the immediate region. Pipe lines carried it to various manufacturing centres within the state and to Chicago, Ill., and Dayton, Ohio. During the early years an enormous amount was wasted; this was soon prohibited by law, and a restriction that the supply was not unlimited resulted in a better appreciation of its great value. The gas, which is found in the Trenton limestone, had an initial pressure at the point of discovery of 325 lb.; this pressure had decreased in the field centre by January 1896 to 230 lb. and by January 1901 to 115 lb., the general average of pressure at the latter date being 80 lb. The gas field extends over Hancock, Henry, Hamilton, Tipton, Madison, Grant and Delaware counties. The value of the output fell from \$7,254,539 in 1900 to \$1,750,715 in 1906, when the state's product was only 4.2% of that of the entire country. On the 1st of January 1909 there were 323 wells in operation, some of which were 1200 ft. deep. It has been found that "dead" gas wells, if drilled somewhat deeper, will generally become active oil wells. The development of the petroleum field, which extends over Adams, Wells, Jay, Blackford and Grant counties, was rapid up to 1904. The annual output increased from 33,375 barrels in 1889 to 11,339,124 barrels in 1904, the latter amount being valued at \$12,235,674 and being 12.09% of the value of the product of the entire country. In 1906 there was an output of only 7,673,477 barrels, valued at \$6,770,066, being 7.3% of the product value of the entire country. The Indiana coal fields, which cover an area of between 7000 and 7500 sq. m. in the west and south-west, chiefly in Clay, Vigo, Sullivan, Vermilion and Greene counties, were in 1900 valued at \$18,399,660, in 1907, 13,985,713, and in 1909, 9,440,422; at \$15,144,300, the production more than doubled since 1890, when it was 5,005,779 tons. The deposits consist of workable veins, which are 50 to 220 ft. in depth, and averaging 80 ft. below the surface. It is a high grade block, or "splint" coal, remarkably free from sulphur and rich in carbon, peculiarly adapted to blast furnace use. The quarries and clay beds of the state are of great value. The quarries of sandstone and limestone are chiefly in the south and south-central portions of the state. The value of the limestone quarried in 1908 was \$3,643,261, as compared with \$2,553,502 in 1902. The Bedford oolitic limestone quarries in Owen, Monroe, Lawrence, Washington and Crawford counties furnish one of the most valuable and widely used building stones in the United States. The value of the product of these quarries was \$4,967,000 in 1903, \$3,475,000 in 1904, and \$4,300,000 in 1905. The quarries of sandstone and limestone and \$1,500,076 from Lawrence and Monroe counties. Beds of brick-clays and potters' clay are widely distributed throughout the state, the total value of pottery products in 1902 being \$5,283,733 and in 1906 \$7,158,234. Marls adapted to the manufacture of Port land cement are found along the Ohio river, and in the lake region in the north. In 1905 and 1906 Indiana ranked third among the states in the production of Portland cement, which in 1908 was 6,478,165

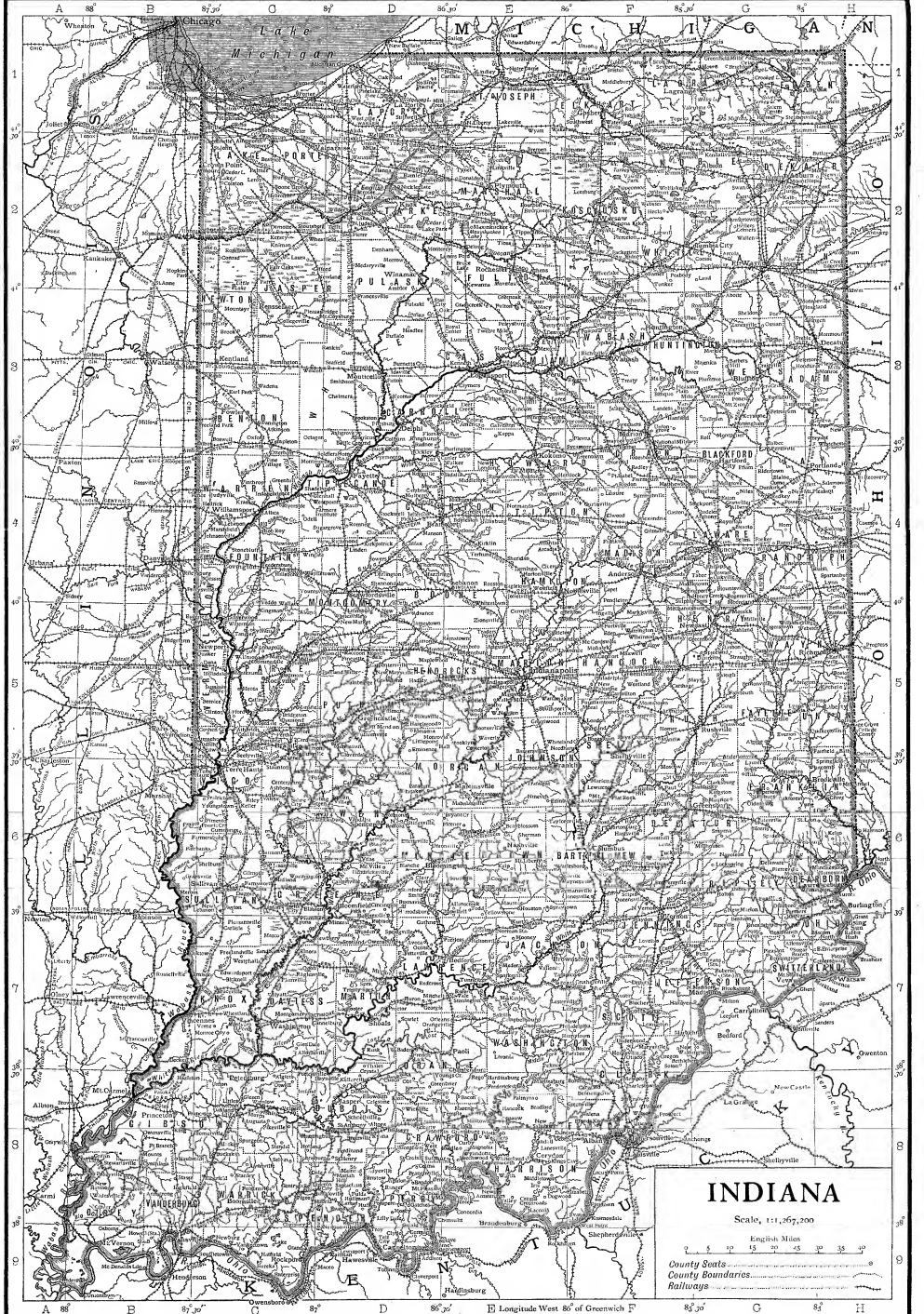

# INDIANA

Scale, 1:1,267,200

English Miles  
 0 5 10 15 20 25 30 35 40  
 County Seats  
 County Boundaries  
 Railways

barrels, valued at \$5,386,563—an enormous advance over 1903, when the product was 1,077,137 barrels, valued at \$1,347,797. The production of natural rock cement, chiefly in Clark county, is one of the two oldest industries in the state, but in Indiana as elsewhere it is falling off—from an output in 1903 of about 1,350,000 barrels to 212,901 barrels (valued at \$240,000) in 1908. There are many mineral springs in the state, and there are famous resorts at French Lick and West Baden in Orange county. A large part of the water is medicinal; hence the high average price per gallon (\$6.99 in 1907 when 514,366 gallons were sold, valued at \$507,746, only 2% being table waters). In 1907 19 springs were reported at which mineral waters were bottled and sold; they were in Allen, Hendricks, Pike, Bartholomew, Warren, Clark, Martin, Brown, Gibson, Wayne, Orange, Vigo and Dearborn counties. A law of 1909 prohibited the pumping of certain mineral waters if such pumping diminished the flow or injured the quality of the water of any spring.

**Communications.**—During the early period, the settlement of the northern and central portions of the state was greatly retarded by the lack of highways or navigable waterways. The Wabash and Erie canal (1843), which connected Lake Erie with the Ohio river, entering the state in Allen county, east of Fort Wayne, and following the Wabash river to Terre Haute and the western fork of the White river from Worthington, Greene county, to Petersburg, Pike county, whence it ran south-south-west to Evansville; and the White Water canal from Hagerstown, Wayne county, mostly along the course of the White Water river, to Lawrenceburg, on the Ohio river, in the south-eastern corner of the state, although now abandoned, served an important purpose in their day. The completion (about 1850) of the National Road, which traversed the state, still further aided the internal development. With the beginning of railway construction (about 1847), however, a new era was opened. Indiana is unusually well served with railways, which form a veritable network of track in every part of the state. It is traversed by nearly all the great transcontinental trunk line systems, and also by important north and south lines. The total railway mileage in January 1909 was 72,862.20 m. There has been a great development also in interurban electric lines, which have been adapted both to passenger and to light freight and express traffic; in 1908 there was 31 interurban electric lines within the state with a mileage of 1500 m. Indianapolis is the centre of this interurban network. The first trolley sleeping cars were those used on the Ohio and Indiana interurban railways. The deepening of the channel of the Wabash river was begun in 1872. Below Vincennes before 1885 boats of 3-ft. draft could navigate the river, but after work was concentrated in 1885 on the lock at Grand Rapids, near Mt. Carmel, Ill., the channel was soon clogged again, and in 1909 it was impossible for boats with a greater draft than 20 in. to go from Mt. Carmel to Vincennes, although up to June 1909 about \$810,000 had been spent by the Federal government on improving this river. In 1879 an appropriation was made for the improvement of the channel of the White river, but no work was done here between 1895 and 1909, and although the lower 13 m. of the river was navigable for boats with a draft of 3 ft. or less, there was practically no traffic up to 1909 on the White, because there was no outlet for it by the Wabash river.

**Population.**—The population of Indiana, according to the Federal Census of 1910, was 2,700,876, and the rank of the state in the Union as regards population was ninth. In 1810, the year following the erection of the western part of Indiana into Illinois Territory, the population was 24,520, in 1820 it had increased to 147,178, in 1850 to 988,416, in 1870 to 1,680,637, in 1890 to 2,192,404, and in 1900 to 2,516,462. In 1900 34.3% was urban, i. e. lived in places of 2500 inhabitants and over. The foreign-born population in the same year amounted to 142,121, or 5.6% of the whole, and the negro population to 57,505, or 2.3%. There were in 1900 five cities with a population of more than 35,000, viz. Indianapolis (169,164), Evansville (59,007), Fort Wayne (45,115), Terre Haute (36,673), and South Bend (35,999). In the same year there were 14 cities with a population of less than 35,000 (all less than 21,000) and more than 10,000; and there were 21 places with a population of less than 10,000 and more than 5000. In 1906 it was estimated that there were 938,405 members of different religious denominations; of this total 233,443 were Methodists (210,503 of the Northern Church), 174,849 were Roman Catholics, 108,188 were Disciples of Christ (10,259 members of the Churches of Christ), 62,705 were Baptists (60,203 of the Northern Convention, 13,526 of the National (Colored) Convention, 8132 Primitive Baptists, and 6671 General Baptists), 58,633 were Presbyterians (49,041 of the Northern Church, and 6376 of the Cumberland Church—since united with the Northern), 55,768 were Lutherans (34,028 of the Evangelical Lutheran Synodical Conference, 8310 of the

Evangelical Lutheran Joint Synod of Ohio and other states), 52,700 were United Brethren (48,050 of the Church of the United Brethren in Christ; the others of the "Old Constitution") and 21,624 of the German Evangelical Synod.

**Constitution.**—Indiana is governed under a constitution adopted in 1851, which superseded the original state constitution of 1816. An amendment to the constitution may be proposed by either branch of the General Assembly; if a majority of both houses votes in favour of an amendment and it is favourably voted upon by the General Assembly chosen by the next general election, the amendment is submitted to popular vote and a majority vote is necessary for its ratification. The constitution of 1816 had conferred the suffrage upon all "white male citizens of the United States of the age of twenty-one and upward," had prohibited slavery, and had provided that no alteration of the constitution should ever introduce it. The new constitution contained similar suffrage restrictions, and further by Article XIII., which was voted upon separately, prohibited the entrance of negroes or mulattoes into the state and made the encouragement of their immigration or employment an indictable offence. This prohibition was held by the United States Supreme Court in 1866 to be in conflict with the Federal Constitution and therefore null and void. It was not until 1881 that the restriction of the suffrage to "white" males, which was in conflict with the Fifteenth Amendment (1870) to the Federal Constitution, was removed by constitutional amendment. Since that date those who may vote have been all male citizens twenty-one years old and upward who have lived in Indiana six months immediately preceding the election, and every foreign-born male of the requisite age who has lived in the United States one year and in Indiana six months immediately preceding the election, and who has declared his intention of becoming a citizen of the United States; but the General Assembly has the power to deprive of the suffrage any person convicted of an infamous crime. The Australian ballot was adopted in 1889. The general state election (up to 1881, held in October) takes place on the first Tuesday after the first Monday in November of even-numbered years. The governor and lieutenant-governor (minimum age, 30 years) and the clerk of the Supreme Court are chosen in presidential years for a term of four years,<sup>1</sup> the other state officers—secretary of state, attorney-general, auditor, treasurer and superintendent of public instruction—every two years. The state legislature, known as the General Assembly, which meets biennially in odd-numbered years and in special session summoned by the governor, consists of a Senate of fifty members (minimum age, 25 years) elected for four years, and a House of Representatives of one hundred members (minimum age, 21 years) elected for two years. Two-thirds of each house constitute a quorum to do business. The governor has the veto power, but the provision that a bill may be passed over his veto by a majority of all elected members renders it little more than an expression of opinion.

**Law.**—The judiciary consists of a Supreme Court of five members elected for districts by the state at large for a term of six years, an appellate court (first constituted in 1891), and a system of circuit and minor criminal and county courts. The system of local government has undergone radical changes in recent years. A law of 1899, aimed to separate the legislative and executive functions, provided for the election of legislative bodies in every township and county. These bodies have control of the local expenditures and tax levies, and without their consent the local administrative officers cannot contract debts. In 1905 a new municipal code, probably the most elaborate and complete local government act in the United States, providing for a uniform system of government in all cities and towns, went into effect. It was constructed on the lines of the Indianapolis city charter, adopted in 1801, and repealed all individual charters and special corporation acts. Its controlling principle is the more complete separation of the executive, legislative and judicial powers. For this purpose all cities are divided into

<sup>1</sup> No man can serve as governor for more than four years in any period of eight years.



five classes according to population, the powers being concentrated and simplified by degrees in the case of the smaller cities, and reaching a maximum of separation and completeness in class 1, *i. e.* cities of 100,000 and over, which includes only Indianapolis. In all classes the executive officer is a mayor elected for four years and ineligible to succeed himself. There are six administrative departments (the number is often less in cities of the lower classes, where several departments may be combined under one head)—departments of public works, public safety, public health and charities, law, finance, and collection and assessment. There is a city court with elected judge or judges, and an elected common council, which may authorize the municipal ownership of public utilities by ordinance, and can pass legislation over the mayor's veto by a two-thirds vote. Communities under 2500 in population are regarded as towns, and have a separate form of government by a board of trustees.

Until 1908 the state had a prohibition law "by remonstrance," under which if a majority of the legal voters of a township or city ward remonstrated against the granting of licences for the sale of liquor, no licence could be granted by the county commissioners in that township or ward. Under this system 800 out of 1016 townships and more than 30 entire counties were in 1908 without saloons. In 1908, when the Republican party had declared in favour of county option and the Democratic party favoured township and ward option, a special session of the legislature, called by the Republican governor, passed the Cox Bill for county options.

**Education.**—Indiana has a well-organized free public school system. Provision was made for such a system in the first state constitution, to utilize the school lands set aside in all the North-West Territory by the Ordinance of 1787, but the existing system is of late growth. The first step toward such a system was a law of 1824 which provided for the election of school trustees in every township and for the erection of school buildings, but made no provision for support. Therefore, before 1850 what schools there were were not free. The constitution of 1851 made further and more complete provisions for a uniform system, and on that basis the general school law of 1852 erected the framework of the existing system. It provided for the organization of free schools, supported by a property tax, and for county and township control. The movement, however, was retarded in 1858 by a decision of the supreme court holding that under the law of 1852 the system was not "uniform" as provided for by the constitution. In 1865 a new and more satisfactory law was passed, which with supplemental legislation is still in force. Under the existing system supreme administrative control is vested in a state superintendent elected biennially. County superintendents, county boards, and township trustees are also chosen, the latter possessing the important power of issuing school bonds. Teachers' institutes are regularly held, and a state normal school, established in 1870, is maintained at Terre Haute. There are normal schools at Valparaiso, Angola, Marion and Danville, and a Teachers' College at Indianapolis, which are on the state's "accredited" list and belong to the normal school system. In 1807 a compulsory education law was enacted. In 1906-1907 the state school tax was increased from 11-6 cents per \$100 to 13-6 cents per \$100; an educational standard was provided, coming into effect in August 1908, for public school teachers, in addition to the previous requirement of a written test; a regular system of normal training was authorized; uniform courses were provided for the public high schools; and small township schools with twelve pupils or less were discontinued, and transportation supplied for pupils in such abandoned schools to central school houses. The proportion of illiterates is very small, in 1900, 95.4% of the population (of 10 years old or over) being able to read and write. The total school revenue from state and local sources in 1905 amounted to \$10,642,638, or \$13.85 per capita of enumeration (\$19.34 per capita of enrollment). In 1824 a state college was opened at Bloomington; it was re-chartered in 1838 as the State University. Purdue University (1874) at Lafayette,

maintained under state control, received the benefit of the Federal grant under the Morrill Act. Other educational institutions of college rank include Vincennes University (non-sectarian), at Vincennes; Hanover College (1833, Presbyterian), at Hanover; Wabash College (1832, non-sectarian), at Crawfordsville; Franklin College (1837, Baptist), at Franklin; De Pauw University (1837, Methodist Episcopal), at Greencastle; Butler University (1855, Christian), at Indianapolis; Earlham College (1847, Friends), at Richmond; Notre Dame University (1842, Roman Catholic), at Notre Dame; Moore's Hill College (1856, Methodist Episcopal), at Moore's Hill; the University of Indianapolis (non-sectarian), a loosely affiliated series of schools at Indianapolis, centring around Butler University; and Rose Polytechnic Institute (1883, non-sectarian), at Terre Haute.

The charitable and correctional institutions of Indiana are well administered in accordance with the most improved modern methods, and form one of the most complete and adequate systems possessed by any state in the Union. The state was one of the first to establish schools for the deaf and the blind. Its Institution for the Education of the Deaf was established in 1844, and its Institution for the Education of the Blind in 1847, both being in Indianapolis. The first State Hospital for the insane was opened in Indianapolis in 1848 and became the Central Indiana Hospital in 1883. There are other similar institutions as the Northern Indiana Hospital at Logansport (1888), the Eastern at Richmond (1890), the Southern at Evansville (1890), and the South-eastern at North Madison (1905). There are a Soldiers' and Sailors' Orphans' Home at Knightstown (1868), and a State Soldiers' Home at Lafayette (1896); a School for Feeble-Minded Youth (1879), removed from Knightstown to Fort Wayne in 1890; a village for epileptics at New Castle (1907); and a hospital for the treatment of tuberculosis, authorized in 1907, for which a site at Rockville was purchased in 1908. There are five state penal and correctional institutions: the Indiana Reformatory (1868-1883), the House of Refuge; 1883-1903, the Reform School for Boys at Plainfield; the Indiana Girls' School, established at Indianapolis (1873), and removed to Clermont in 1907; a woman's prison (the first in the United States, authorized in 1869 and opened in 1873 at Indianapolis), which is entirely under the control of women (as is also the Indiana Girls' School) and has a correctional department (1908), in reality a state workhouse for women, formed with a view to removing as far as possible sentenced women from the county jails; a reformatory (1897), at Jeffersonville, conducted upon a modification of the Elmira plan, formerly the State Prison (1822), later (1866) the State Prison, so called to distinguish it from the State Prison North (1860) at Michigan City; and the prison at Michigan City, which became the Indiana State Prison in 1897. The old State Prison at Jeffersonville was at first conducted on the lease system, but public opinion compelled the abandonment of that system some years before the Civil War. The prisoners of the reformatory work under a law providing for trade schools; the product of the work is sold to the state institutions and to the civil and political divisions of the state, the surplus being disposed of on the market. At the State Prison practically one half the prisoners are employed on contract. Not more than 100 may be employed on any one tract, and the day's work is limited to eight hours. The remainder of the population of the prison is employed on state account. The policy of indeterminate sentence and paroles was adopted in 1897 in the two prisons and the reformatory. Prisoners released upon parole are carefully supervised by state agents. Indiana has an habitual-criminal law, and a law providing for the sterilization of mental degenerates, confirmed criminals, and rapists. There are also an adult probation law and a juvenile court law, the latter applying to every county in the state. Each of the state institutions mentioned above is under the control of a separate bi-partisan board of four members. The whole system of public charities is under the supervision of a bi-partisan Board of State Charities (1889), which is appointed by the governor, and to which the excellent condition of state institutions is largely due. In the counties there are unsalaried boards of county charities and correction and county boards of children's guardians, appointed by the circuit judges. The township trustees, 1016 in number, are ex-officio overseers of the poor. They dispense official outdoor relief. Nowhere else have the principles of organized charities in the administration of public outdoor relief been applied to an entire state. Each county provides for the indoor care of the poor in poor asylums and children's homes, and for local prisoners in county jails. Provision is made for truant, dependent, neglected and delinquent children. No child can be made a public ward except upon order of the juvenile court, and all such children may be placed in family homes by agents of the Board of State Charities.

**Finance.**—The total true value of taxable property in the state was, according to the tax levy of 1907, \$1,767,815,487, and the total taxes, including delinquencies, in the same year amounted to \$38,880,257. The total net receipts for the fiscal year ending September 30, 1908, were \$4,771,628, and the total net expenditure \$5,259,002, the cash balance in the treasury for the year

ending September 30, 1907, amounted to \$1,096,459, leaving a cash balance on September 30, 1908, of \$609,085. The total state debt on September 30, 1908, was \$1,380,615.

**History.**—Of the prehistoric inhabitants of Indiana little is known, but extensive remains in the form of mounds and fortifications abound in every part of the state, being particularly numerous in Knox and Sullivan counties. Along the Ohio river are remnants of several interesting stone forts. Upon the earliest arrival of Europeans the state was inhabited chiefly by the various tribes of the Miami Confederacy, a league of Algonquian Indians formed to oppose the advance of the Iroquois. The first Europeans to visit the state were probably French *coureurs des bois* or Jesuit missionaries. La Salle, the explorer, it is contended, must have passed through parts of Indiana during his journeys of 1669 and the succeeding years. Apparently a French trading post was in existence on the St Joseph river of Michigan about 1672, but it was in no sense a permanent settlement and seems soon to have been abandoned. It seems probable that the Wabash-Maumee portage was known to Father Claude Jean Allouez as early as 1680. When, a few years later, this portage came to be generally used by traders, the necessity of establishing a base on the upper Wabash as a defence against the Carolina and Pennsylvania traders, who had already reached the lower Wabash and incited the Indians to hostility against the French, became evident; but it was not, apparently, until the second decade of the 18th century that any permanent settlement was made. About 1720 a French post was probably established at Ouiatenon (about 5 m. S.W. of the present city of Lafayette), the headquarters of the Wea branch of the Miami, on the upper Wabash. The military post at Vincennes was founded about 1731 by François Margane, Sieur de Vincennes (or Vincent), but it was not until about 1735 that eight French families were settled there. Vincennes, which thus became the first actual white settlement in Indiana, remained the only one until after the War of Independence, although military posts were maintained at Ouiatenon and at the head of the Maumee, the site of the present Fort Wayne, where there was a French trading post (1680) and later Fort Miami. After the fall of Quebec the British took possession of the other forts, but not at once of Vincennes, which remained for several years under the jurisdiction of New Orleans, both under French and Spanish rule. The British garrisons at Ouiatenon and Fort Miami (near the site of the later Fort Wayne) on the Maumee were captured by the Indians as a result of the Pontiac conspiracy. All Indiana was united with Canada by the Quebec Act (1774), but it was not until three years later that the forts and Vincennes were occupied by the British, who then realized the necessity of ensuring possession of the Mississippi Valley to prevent its falling into the hands of the rebellious colonies. Nevertheless, in 1778 Vincennes fell an easy prey to agents sent to occupy it by George Rogers Clark, and although again occupied a few months later by General Henry Hamilton, the lieutenant-governor at Detroit, it passed finally into American control in February 1779 as a result of Clark's remarkable march from Kaskaskia. Fort Miami remained in British hands until the close of the war.

The first American settlement was made at Clarksville, between the present cities of Jeffersonville and New Albany, at the Falls of the Ohio (opposite Louisville), in 1784. The decade following the close of the war was one of ceaseless Indian warfare. The disastrous defeats of General Josiah Harmar (1753-1813) in October 1790 on the Miami river in Ohio, and of Governor Arthur St Clair on the 4th of November 1791 near Fort Recovery, Ohio, were followed in 1792 by the appointment of General Anthony Wayne to the command of the frontier. By him the Indians were signally defeated in the Battle of Fallen Timbers (or Maumee Rapids) on the 20th of August 1794, and Fort Wayne, Indiana, was erected on the Maumee river. On the 3rd of August 1795, at Greenville, Ohio, a treaty was concluded between Wayne and twelve Indian tribes, and a narrow slice of the east-south-eastern part of the present state (the disputed lands in the valley of the Maumee) and various other small but not

unimportant tracts were ceded to the United States. Then came several years' respite from Indian war, and settlers began at once to pour into the region. The claims of Virginia (1784) and the other eastern states having been extinguished, a clear field existed for the establishment of Federal jurisdiction in the "Territory North-West of the Ohio," but it was not until 1787 that by the celebrated Ordinance of that year such jurisdiction became an actuality. The North-West Territory was governed by its first governor, Arthur St Clair, until 1799, when it was accorded a representative government. In 1800 it was divided, and from its western part (including the present states of Indiana, Illinois and Wisconsin, the north-east part of Minnesota, and a large part—from 1803 to 1805 all—of the present state of Michigan) Indiana Territory was erected, with General William Henry Harrison—who had been secretary of the North-West Territory since 1798—as its first governor, and with Vincennes as the seat of government. Harrison made many treaties with the Indians, the most important being that signed at Fort Wayne on the 7th of June 1803, defining the Vincennes tract transferred to the United States by the Treaty of Greenville; those signed at Vincennes on the 18th and the 27th of August 1804, transferring to the United States a strip north of the Ohio river and south of the Vincennes tract; that concluded at Grouseland on the 21st of August 1805, procuring from the Delawares and others a tract along the Ohio river between the parcels of 1795 and 1804; and the treaties of Fort Wayne, signed on the 30th of September 1809, and securing one tract immediately west of that of 1795 and another north of the Vincennes tract defined in 1803. In January 1805 Michigan Territory was erected from the northern part of Indiana Territory, and in July following the first General Assembly of Indiana Territory met at Vincennes. In March 1809 the Territory was again divided, Illinois Territory being established from its western portion; Indiana was then reduced to its present limits. In 1810 began the last great Indian war in Indiana, in which the confederated Indians were led by Tecumseh, the celebrated Shawnee chief; it terminated with their defeat at Tippecanoe (the present Battle Ground) by Governor Harrison on the 7th of November 1811. After the close of the second war with Great Britain, immigration began again to flow rapidly into the Territory, and, having attained a sufficient population, Indiana was admitted to the Union as a state by joint resolution of Congress on the 11th of December 1816. The seat of government was established at Corydon, whither it had been removed from Vincennes in 1813. In 1820 the site of the present Indianapolis was selected for a new capital, but the seat of government was not removed thither until 1825.

The first great political problem presenting itself was that of slavery, and for a decade or more the only party divisions were on pro-slavery and anti-slavery lines. Although the Ordinance of 1787 actually prohibited slavery, it did not abolish that already in existence. Slavery had been introduced by the French, and was readily accepted and perpetuated by the early American settlers, almost all of whom were natives of Virginia, Kentucky, Georgia or the Carolinas. According to the census of 1800 there were 175 slaves in the Territory. The population of settlers from slave states was considerably larger than in Illinois, the proportion being 20% as late as 1850. It was but natural, therefore, that efforts should at once have been made to establish the institution of slavery on Indiana soil, and as early as 1802 a convention called to consider the expediency of slavery asked Congress to suspend the prohibitory clause of the Ordinance for ten years, but a committee of which John Randolph of Virginia was chairman reported against such action. Within the Territory there were several attempts to escape, by means of legislation, the effects of the Ordinance. These efforts consisted in (1) a law regulating the status of "servants," by which it was sought to establish a legal relation between master and slave; (2) a law by which it was sought to establish practical slavery by a system of indenture. By 1808 the opponents of slavery, found chiefly among the Quaker settlers in the south-eastern counties, began to awake to the danger that confronted them, and in 1809 elected their candidate,

Jonathan Jennings (1776-1834) to Congress on an anti-slavery platform. In 1810, by which year the number of slaves had increased to 237, the anti-slavery party was strong enough to secure the repeal of the indenture law, which had received the unwilling acquiescence of Governor Harrison. Jennings was re-elected in 1811, and subsequently was chosen first governor of the state on the same issue, and the state constitution of 1816 pronounced strongly against slavery. The liberation of most of the slaves in the eastern counties followed; and some slave-holders removed to Kentucky. In 1830 there were only three slaves in the state, and the danger of the establishment of slavery as an institution on a large scale was long past.

The problem of "internal improvements" came to be of paramount importance in the decade 1820-1830. In 1827 Congress granted land to aid in the construction of a canal to connect Lake Erie and the Ohio river. This canal was completed from the St. Joseph river to the Wabash in 1835, opened in 1843, and later abandoned. In 1836 the state legislature passed a law providing for an elaborate system of public improvements, consisting largely of canals and railways. The state issued bonds to the value of \$10,000,000, a period of wild speculation followed, and the financial panic of 1837 forced the abandonment of the proposed plan and the sale to private persons of that part already completed. The legislature authorized the issue of \$1,500,000 in treasury bonds, which by 1842 had fallen in value to 40 or 50% of their face value. A new constitution was adopted in February 1851 by a vote of 109,319 against 26,755.

Despite its large Southern population, Indiana's answer to President Lincoln's first call for volunteers at the outbreak of the Civil War was prompt and spirited. From first to last the state furnished 20,800 officers and men for the Union armies besides a home legion of some 50,000, organized to protect the state against possible invasion. The efficiency of the state military organization, as well as that of the civil administration during the trying years of the war, was largely due to the extraordinary ability and energy of Governor Oliver P. Morton, one of the greatest of the "war governors" of the North. The problems met and solved by Governor Morton, however, were not only the comparatively simple ones of furnishing troops as required. The legislature of 1863 and the state officers were opposed to him politically, and did everything in their power to thwart him and deprive him of his control of the militia. The Republican members seceded, legislative appropriations were blocked, and Governor Morton was compelled to take the extraconstitutional step of arranging with a New York banking house for the payment of the interest on the state debt, of borrowing money for state expenditure on his own responsibility, and of constituting an unofficial financial bureau, which disbursed money in disregard of the state officers. Furthermore Indiana was the principal centre of activity of the disloyal association known as the Knights of the Golden Circle, or Sons of Liberty, which found a ready growth among the large Southern population. Prominent among Southern sympathisers was Senator Jesse D. Bright (1812-1875), who on the 5th of February 1862 was expelled from the United States Senate for writing a letter addressed to Jefferson Davis, as President of the Confederacy, in which he recommended a friend who had an improvement in fire-arms to dispose of. The Knights of the Golden Circle at first confined their activities to the encouragement of desertion, and resistance to the draft, but in 1864 a plot to overthrow the state government was discovered, and Governor Morton's prompt action resulted in the seizure of a large quantity of arms and ammunition, and the arrest, trial and conviction of several of the leaders. In June 1863 the state was invaded by Confederate cavalry under General John H. Morgan, but most of his men were captured in Indiana and he was taken in Ohio. There were other attempts at invasion, but the expected rising, on which the invaders had counted, did not take place, and in every case the home legion was able to capture or drive out the hostile bands.

Politically Indiana has been rather evenly divided between the great political parties. Before the Civil War, except when

William Henry Harrison was a candidate for the presidency, its electoral vote was generally given to the Democratic party, to which also most of its governors belonged. After the war the control of the state alternated with considerable regularity between the Republican and Democratic parties, until 1896, between which time and 1904 the former were continuously successful. In 1908 a Democratic governor was elected, but Republican presidential electors were chosen.

## GOVERNORS OF INDIANA

Territorial.			
Arthur St Clair (North-West Territory)		1787-1800	
John Gibson, Territorial Secretary (acting)		1800-1801	
William Henry Harrison		1801-1812	
John Gibson, Territorial Secretary (acting)		1812-1813	
Thomas Posey		1813-1816	
State.			
Jonathan Jennings		1816-1822	Democratic-Republican
Ratiff Boone (acting)		1822	"
William Hendricks		1822-1825	"
James B. Ray, President of Senate (acting)		1825	"
James B. Ray		1825-1831	"
Noah Noble		1831-1837	"
David Wallace		1837-1840	Whig
Samuel Bigger		1840-1843	"
James Whitcomb		1843-1848	Democrat
Paris C. Dunning, Lt.-Gov. (acting)		1848-1849	"
Joseph A. Wright		1849-1857	"
Ashbel P. Willard		1857-1860	"
Abram A. Hammond, Lt.-Gov. (acting)		1860-1861	"
Henry S. Lane		1861	Republican
Oliver P. Morton, Lt.-Gov. (acting)		1861-1865	"
Oliver P. Morton		1865-1867	"
Conrad Baker, Lt.-Gov. (acting)		1867-1869	"
Conrad Baker		1869-1873	"
Thomas A. Hendricks		1873-1877	Democrat
James D. Williams		1877-1880	"
Isaac P. Gray, Lt.-Gov. (acting)		1880-1881	"
Albert G. Porter		1881-1885	Republican
Isaac P. Gray		1885-1889	Democrat
Alvin P. Hovey		1889-1891	Republican
Ira J. Chase, Lt.-Gov. (acting)		1891-1893	"
Claude Matthews		1893-1897	Democrat
James A. Mount		1897-1901	Republican
Winfield T. Durbin		1901-1905	"
J. Frank Hanly		1905-1909	"
Thomas R. Marshall		1909-	Democrat

**BIBLIOGRAPHY.**—There is a bibliography of Indiana history, by Isaac S. Bradley, in the *Proceedings of the Wisconsin State Historical Society for 1897*. The *History of Indiana* by William Henry Smith (2 vols., Indianapolis, 1897) is the best general account of Indiana history and institutions. J. B. Dillon's *History of Indiana* (Indianapolis, 1859) is the most authoritative account of the early history to 1816. J. P. Dunn's *Indiana, a Redemption from Slavery* (Boston, 1888) is the "American Commonwealth" series, as its secondary title indicates, is devoted principally to the struggle over the provision in the Ordinance of 1787 prohibiting slavery. For the Civil War period consult J. A. Woodburn, "Party Politics in Indiana during the Civil War" in *Annual Report of the American Historical Association* (Washington, 1902); W. H. H. Terrell, "Indiana in the War of the Rebellion" (Official Report of the Adjutant-General Indianapolis, 1866); and E. B. Pittman, *Trials for Treason at Indianapolis* (Indianapolis, 1865). See also De W. C. Goodrich and C. R. Tuttle, *Illustrated History of the State of Indiana* (Chicago, 1875); the same, revised and enlarged by W. S. Hayward (Indianapolis, 1879); O. H. Smith, *Early Indiana Trials and Sketches* (Indianapolis, 1858); and Nathaniel Bolton, "Early History of Indianapolis and Central Indiana," in *Indiana Historical Society Publications*, No. 5. "The Executive Journal of Indiana Territory" has been reprinted in the *Indiana Historical Society's Publications*, vol. iii., 1900. For government and administration see E. L. Hendricks, *History and Government of Indiana* (New York, 1908); *The Legislature and State Manual of Indiana* (Indianapolis, published biennially by the State Librarian); *Constitutions of 1816 and 1851 of the State of Indiana with Amendments* (Indianapolis, 1897); *School Law of Indiana, with Annotations* (Indianapolis, 1904); and Wm. A. Rawles, *Centralizing Tendencies in the Administration of Indiana* (New York and London, 1903), Columbia Univ. Press. "The New Municipal Code of Indiana" is explained in an article by H. O. Stechhan in the *Forum* (October-December, 1905). For education see Fassett A. Cotton's *Education in Indiana* (Indianapolis, 1905), and James A. Woodburn, *Higher Education in Indiana* (Washington, 1891), U.S. Documents, Bureau of Education, Circulars

of Information, No. 1. For resources, industries, &c., consult the *Reports of the Chief of the Bureau of Statistics of Indiana* (biennial, Indianapolis, 1886 to date), *Annual Report of the Department of Geology and Natural Resources* (Indianapolis, 1869 to date), and *Reports of the State Agricultural Society*. See also the *Reports of the Twelfth Federal Census* for detailed statistical matter as to production, industries and population.

**INDIANAPOLIS**, the capital and largest city of Indiana, U.S.A., situated on the W. fork of the White river, in Marion county, of which it is the county-seat, and at almost the exact geographical centre of the state. It is 824 m. W. of New York by rail, and 183 m. S.E. of Chicago, and is about 710 ft. above sea-level, and about 138 ft. above Lake Erie. Its area is 30·77 sq. m., of which 29·95 sq. m. is land. Pop. (1880) 75,074; (1890) 105,436; (1900) 169,164, of whom 17,122 were foreign-born (83,62 being by birth German, 3765 Irish, and 1154 English) and 15,031 were negroes; (1910 census) 233,650. Indianapolis is near the centre of population of the United States. From 1847, when the first railway entered the city, Indianapolis has steadily grown in importance as a railway centre. It is served by the Chicago, Indianapolis & Louisville, the Cincinnati, Hamilton & Dayton, the Cleveland, Cincinnati, Chicago & St. Louis (New York Central System), the Lake Erie & Western (New York Central System), the Pittsburg, Cincinnati, Chicago & St. Louis (Pennsylvania System) and the Vandalia (Pennsylvania System) railways. At the Union Station more than 150 trains enter and depart daily, carrying more than 30,000 passengers. Outside the city there is a "belt line," 15½ m. long, connecting the several railways and carrying more than 1,000,000 freight cars annually; and an extensive electric street railway system, with more than 150 m. of track and with interurban connexions, serves every part of the city and its suburbs. The city has a large traction terminal station, and is the principal centre for the interurban electric lines of Indiana, which handle freight as well as passengers; in 1908 twenty-five interurban electric lines entered the city and operated about 400 cars every 24 hours.

Physically Indianapolis is one of the most attractive inland cities in America. It is built on a level plain surrounded by low, gently sloping and beautifully wooded hills. Four principal avenues radiate from points near a central circle to the four corners of the city. The other streets run at right angles to one another. Streets and avenues are 90 ft. wide, except Washington Street, which has a width of 120 ft. An excellent system of parks—8 within the city with an aggregate area of 1311 acres, and 3 with an aggregate area of 310 acres just outside the city limits—adds to the beauty of the city, among the most attractive being the Riverside, the St. Clair, the University, the Military, the Fair View, the Garfield and the Brookside. The city is lighted by gas and electricity,—it was one of the first cities in the United States to adopt electric lighting,—and has a good water-supply system, owned by a private corporation, with a 4½ acre filter plant of 18,000,000 gallons *per diem* capacity and an additional supply of water pumped from deep wells outside the city. The public buildings and business blocks are built mostly of Indiana building stone. The state capitol stands in a square 8 acres in extent, and has a central tower and dome 240 ft. high. It covers 2 acres of ground and cost \$2,000,000. The Marion county court-house cost \$1,750,000. Other noteworthy buildings are the Federal building (containing post-office, custom-house and Federal court-rooms; erected at a cost of \$3,000,000); Tomlinson Hall, capable of seating 3000 persons, given to the city by Daniel Tomlinson; the Propylaeum, a club-house for women; the Commercial club; Das Deutsche Haus, belonging to a German social club; the Maennerchor club-house; the Union railway station; the traction terminal building; the city hall, and the public library. Near the city is the important United States army post, Fort Benjamin Harrison, named in honour of President Benjamin Harrison, whose home was in Indianapolis. In or near the city are the Central Indiana Hospital for the Insane, the Indiana Institution for the Education of the Blind, the Indiana Institution for the Education of the Deaf, the Indiana Girls' School (included with

the Women's prison until 1899, and under the same management as the prison from 1899 to 1903, when it became a separate institution,—it was removed to Clermont, 10 m. from Indianapolis, in 1907), and a Women's prison (opened in 1873, the first in the United States), which is under female management. The public library, founded in 1871, contains more than 100,000 volumes. There are ten other libraries, the most important of which are the state law library (about 40,000 volumes) and the state library (about 46,000 volumes).

The city is an educational centre of considerable importance. The university of Indianapolis (1896) is a loose association of three really independent institutions—the Indiana Law School (1894), the Indiana Dental College (1879), and Butler University (chartered in 1849 and opened in 1855 as the North-western Christian University, and named Butler University in 1877 in honour of Ovid Butler, a benefactor). Other educational institutions are the Indianapolis College of Law (1897), the Indiana Medical College (the School of Medicine of Purdue University, formed in 1905 by the consolidation of the Medical College of Indiana, the Central College of Physicians and Surgeons and the Fort Wayne College of Medicine), the State College of Physicians and Surgeons (the medical school of Indiana University), the Indiana Veterinary College (1892), the Indianapolis Normal School, the Indiana Kindergarten and Primary Normal Training School (private), and the Winona Technical Institute. The last named was opened in 1904, and is controlled by the Winona Lake corporation, having official connexion with several national trade unions. It has departments of pharmacy, chemistry, electrical wiring, lithography, house-painting, printing, carpentry, moulding, tile-setting, bricklaying, machinery and applied science. The art association of Indianapolis was founded in 1883; and under its auspices is conducted an art school (1902) in accordance with the bequest of John Herron (1817–1895), the school and museum of the association being housed in the John Herron Art Institute, dedicated in 1906.

The city has several fine monuments, among which are statues of Oliver P. Morton, George Rogers Clark, William Henry Harrison, Benjamin Harrison, Thomas A. Hendricks and Major-General Henry W. Lawton. The Soldiers' and Sailors' Monument, erected by the state, stands in the circle in the centre of the city, rises to a height of 284·5 ft. above the street level, and is surmounted by a statue of Victory 38 ft. high. On the east and west faces of the base are two great stone groups of Peace and War respectively. The monument was erected after designs by Bruno Schmidt of Berlin, with fountains at the base said to be among the largest in the world, their capacity being 20,000 gallons per minute.

The city's central geographical position, its extensive railway connexions, and its proximity to important coal-fields have combined to make it one of the principal industrial centres of the Middle West. The value of its "factory" products was 17·6% of the state's total in 1900 and 20·0% of the total in 1905. The increase in the value of the "factory" product between 1900 and 1905 was from \$59,322,234 to \$82,227,050, or 38·6%. Indianapolis is the principal live stock centre of the Ohio Valley, and has extensive stock-yards covering more than 100 acres. Slaughtering and meat-packing is the most important industry, the value of the product amounting to \$24,458,810 in 1905; this industry dates from about 1835. Among other important manufactures are foundry and machine shop products (\$6,944,392 in 1905); flour and grist-mill products (\$4,428,664); cars and shop construction and repairs by steam railways (\$2,502,780); saws; waggons and carriages (\$2,049,207); printing and publishing (book and job, \$1,572,688; and newspapers and periodicals, \$2,715,666); starch; cotton and woollen goods; furniture (\$2,528,238); canned goods (\$1,693,818); lumber and timber (\$1,536,466); structural iron work (\$1,541,732); beer (\$1,300,764); and planing-mill products, sash, doors and blinds (\$1,111,264).

Indianapolis is governed under a form of government adopted originally in a special charter of 1891 and in 1905 incorporated in the new state municipal code, which was based upon it,

It provides for a mayor elected every four years, a single legislative chamber, a common council, and various administrative departments—of public safety, public health, &c. The guiding principle of the charter, which is generally accepted as a model of its kind, is that of the complete separation of powers and the absolute placing of responsibility.

On the admission of Indiana as a state, Congress gave to it four sections of public land as a site on which to establish a state capital. This was located in 1820 in almost the exact geographical centre of the state, where a small settlement had recently been made, and the town of Indianapolis was laid out in the following year. It was then in the midst of dense forests and was wholly unconnected by roads with other parts of the state. Upon its final acceptance as the capital, there was some activity in land speculation, but Indianapolis had only 600 inhabitants and a single street when the seat of government was removed thither in 1824. The legislature met here for the first time in 1825. Some impetus was given to the city's growth by the completion of the National Road, and later by the opening of railways, but until after the Civil War its advancement was slow. It was incorporated as a town in 1832, its population then being 1000. The first state capitol was completed in 1836. Indianapolis suffered severely from the business panic of 1837, and ten years later, when it received its first city charter, it had only about 6000 inhabitants; in the same year a free public school system was inaugurated.

**ATTRIBUTES.**—B. R. Sulgrove, *History of Indianapolis and Marion County* (Philadelphia, 1884); M. R. Hyman, *Handbook of Indianapolis* (Indianapolis, 1907); Nathaniel Bolton, "Early History of Indianapolis and Central Indiana" (*Indiana Historical Society's Publications*, No. 5, 1897); W. R. Holloway, *Indianapolis, a Historical and Statistical Sketch* (Indianapolis, 1879); the Indianapolis Board of Trade's *Report on the Industries of Indianapolis* (1889); *Civic Studies of Indianapolis* (Indianapolis, 1907 seq.), edited by Arthur W. Dunne; and P. S. Heath's sketch of Indianapolis in L. P. Powell's *Historic Towns of the Western States* (New York, 1901).

**INDIAN ARCHITECTURE.** The development of architectural art in India is of the highest interest for the history of the subject; and whatever may be our estimate of its aesthetic qualities, we can hardly fail to realize that Indian builders attained with marked success the aims they had before them, though they employed arrangements and adopted forms and details very different from those of western builders in ancient and medieval times. These forms and adaptations, of course, require study properly to understand them, and to recognize the adjustment of the designs to their purposes. But besides the scientific advantages of such a study, it has been well remarked by Fergusson, to whose genius the history of Indian architecture is so specially due as its creator, that "it will undoubtedly be conceded by those who are familiar with the subject that, for certain qualities, the Indian buildings are unrivalled. They display an exuberance of fancy, a lavishness of labour, and an elaboration of detail to be found nowhere else." Besides, if anywhere the history of a country is imprinted in its architecture, it is in India that it throws the most continuous, distinct and varied light on that history.

In the early architecture of India, as in that of Burma, China and Japan till the present day, wood was solely or almost solely employed; and it was only about the 3rd century B.C. that stone became largely used as the material for important structures; if brick or stone were in use previously, it was only for foundations and engineering purposes. Even at the end of the 4th century B.C. Megasthenes states that Pataliputra, the capital of Chandragupta—the Sandrokottos of Greek writers—was "surrounded by a wooden wall pierced with loop-holes for the discharge of arrows." And if the capital were defended by such palisading, we may fairly infer that the architecture of the time was wholly wooden. On the Sanchi gateways, brick walls are indeed represented, but apparently only as fences or limits with serrated copings, but not in architectural structures. And at whatever date stone came to be introduced, the Hindus continued and repeated the forms they had employed in the earlier material, and preserved their own style, so that it bore witness to the general antecedent use of wood. Hence we are

able to trace its conversion into lithic forms until finally its origin disappears in its absorption in later styles.

India possesses no historical work to afford us a landmark previous to the invasion of Alexander the Great in the 4th century B.C., nor do we know of an architectural monument of earlier date. For later periods there are fortunately a few examples dated by inscriptions, and for others by applying the scientific principles developed by Thomas Rickman for the discrimination of other styles and the relative ages of architectural works, we are enabled to arrange the monuments of India approximately in chronological sequence or order of succession.

The invasion of Alexander and the westward spread of Buddhism brought India into contact with Persia, where the Achaemenian kings had hewn out mausolea in the rocks, and built palaces with stone basements, doorways and pillars, filling in the walls with bricks. These works would attract the attention of Indian visitors—ambassadors, missionaries and merchants; and the report of such magnificent works would lead to their imitation.

About the middle of the 3rd century B.C. we find the great Asoka, the grandson of Chandragupta, in communication with the contemporary kings of Syria, Egypt, Macedonia, Epirus and Cyrene; and to his reign belong the great stone pillars, with capitals of Persian type, that are engraved with his religious edicts. A convert to Buddhism, Asoka is credited with the construction all over the country of vast numbers of stūpas—monumental structures enshrining relics of Sakyamuni Buddha or other Buddhist saints; and with them were erected monasteries and chapels for the monks.

On the monumental pillars, known as *lāts*, set up by this emperor, besides the Persepolitan form of capital, we find the honeysuckle with the bead and reel and the cable ornaments that were employed in earlier Persian carvings; and though not continued later in India proper, these prevailed in use in Afghanistan for some centuries after the Christian era. This seems to indicate that these forms first came from Persia along with the ideas that led to the change of wooden architecture for that of stone.

The stūpas were structures that may be regarded as conventional architectural substitutes for funeral tumuli, and were constructed to enshrine relics of Buddha or of his more notable disciples, or even to mark the scene of notable events in the tradition of his life. How relic-worship originated and came to hold so large a place in the Buddhist cult we can hardly conjecture: the sentiment could not have arisen for the first time on the death of Gotama Buddha, when, we are told, eight stūpas were built over his corporeal relics, a ninth over the vessel with which they were divided, and a tenth over the charcoal of the funeral pile.

These stūpas, known as *dāgabas* in Ceylon, and *chaitiys* in Nepal, are called *topes* in the ordinary patois of upper India. They consisted of a low circular drum supporting a hemispherical dome of less diameter and leaving a ramp or berm round it of a few feet in width. Round the drum was an open passage for circumambulation, and the whole was enclosed by a massive stone railing with lofty gates on four sides. These railings and gateways are their principal architectural features; the rails are constructed as closely as possible after wooden patterns, and examples are still found at Sanchi and Buddh-Gayā<sup>1</sup>; what remained of the Barahat stūpa was transferred to the Calcutta Museum, and portions of the Amravati rail are now in the British and Madras museums. The uprights and cross bars of the rails were in many cases covered with elaborate carvings of scenes of the most varied kinds, and are illustrative of manners and customs as well as of the art of sculpture.

The great stūpa at Sanchi in Bhopal is now the most entire of the class, as it still retains the gateways—styled *torans*—which must have been a feature of all stūpas, though perhaps mostly

<sup>1</sup> The restoration of the shrine at Buddh-Gaya was begun in 1908 under the auspices of the Buddhist Shrine Restoration Society, of which the Tashi Lama was first president and the eldest son of the maharaja of Sikkim vice-president.

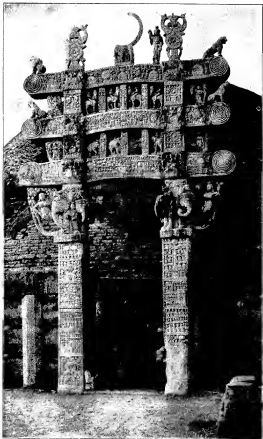
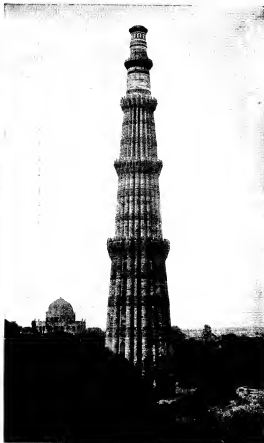
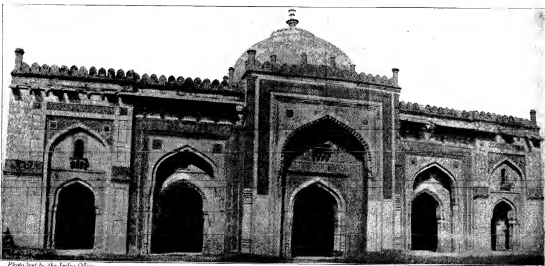

FIG. 8.—SANCHI NORTH GATEWAY.



*Photo, F. Frith & Co.*

FIG. 9.—THE KUTB MINAR NEAR DELHI.



*Photo lent by the India Office.*

FIG. 10.—SHER SHAH'S MOSQUE AT DELHI.



FIG. 11.—GREAT TEMPLE AT HALEBID.



FIG. 12.—ROOF OF DOME OF VIMALA'S TEMPLE ON MOUNT ABU.

*(From Photographs kindly lent by the India Office.)*

in wood (see Plate I. fig. 8). The whole of the superstructure of the Sanchi examples is essentially wooden in character, and we are astonished that it should have stood "for twenty centuries nearly uninjured." These torans reappear to this day in Japan as *tori-i* and in China as *p'ai-lus* or *p'ai-fangs*. The whole of the surfaces, inside and out, are carved with elaborate sculptures of much interest. A cast of the eastern toran from Sanchi is to be seen in the museums at S. Kensington, Edinburgh, Dublin, Paris and Berlin. On the southern one, an inscription appears to indicate that it was erected about 150 B.C.

The earlier cave temples are of about the same age as the stūpas; some of those in Behar bear inscriptions of Asoka and of his successor in the 2nd century B.C. And the earlier cave façades in western India indicate the identity of style and construction in the patterns from which both must have been copied. These Buddhist rock excavations are of two types: the chaitya or chapel caves, with vaulted roofs of considerable height, the earliest with wooden fronts and later with a screen wall left in the rock, but in both forms with a large horse-shoe shaped window over the entrance. The interior usually consisted

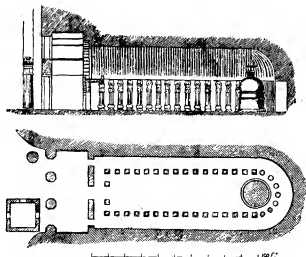

FIG. 1.—Cave at Karli near Bombay. Section and plan.

of a nave, separated from the side aisles by pillars, and containing a chaitya or small stūpa at the inner and circular end. The façades of these chaitya chapels were covered with sculpture—some of them very richly; and to protect them from the weather a screen was contrived and cut in the rock in front of the façade, with large windows in the upper half for the entrance of light. This mode of lighting by a great arch over the entrance has attracted considerable attention, as being admirably adapted for its purpose. As Fergusson remarked, "nothing invented before or since is lighted so perfectly, and the disposition of the parts or interior for an assembly of the faithful . . . is what the Christians nearly reached in after-times but never quite equalled."

The second type of rock excavations are known as viharas or monasteries devoted to the residence of monks and ascetics. They usually consisted of a hall surrounded by a number of cells—the earliest with stone beds in them. In the later viharas there was a shrine in the centre of the back wall containing a large image of the Buddha. In the Orissa caves, near Cuttack, we have a series of excavations that do not conform to these arrangements: they are early, dating as far back as the 2nd century B.C., but they belong to the Jain sect, which dates from the same age as the Buddhist.

On the north-west frontiers of India, about the Swāt and Yūsufzai districts, recently known as Gandhāra, are found a remarkable class of monuments, much ruined, but that must have abounded in sculptures belonging to the Buddhist cult. It is among these we find the first representations of Buddha and of the characters belonging to the Buddhist pantheon. The in-

fluence of classical art manifested in these images leaves no doubt that they were modelled after western patterns, carried thither by Greeks or brought from the Levant by Buddhist emissaries. The scenes depicted, however, have frequently an architectural setting in which we find represented façades with pillars fashioned with distinctly Corinthian capitals. These sculptures we can now assign with confidence, from dated epigraphs, to dates from the last years of the century B.C. till the 4th century A.D. One inscription of A.D. 47 is of a king Gondopherēs, who is mentioned in the legend of the apostle Thomas.

In the time of the great Gupta dynasty, from about A.D. 320 to 500, the architectural forms developed in variety and richness of decoration. To the columns were given higher square bases than before, and sometimes a sur-base; the capitals, which previously had a vase as the chief member, were developed by a foliated ornament, springing from the mouth of the vase and falling down upon it from the four corners, and so lending strength to the neck whilst converting the round capital into a square support for the abacus. Often, too, a similar arrangement of foliage was applied to the early bases; and this form quite superseded the Persepolitan pillar, with its bell-shaped capital, which now disappeared from Indian art. The shafts were round or of sixteen or more sides; pilasters were ornamented on the shafts; and the spires of the temple were simple in outline and rose almost vertically at first and curving inwards towards the summit, which was always capped by a large circular fluted disk supporting a vase, whilst the surface of the tower was covered with a peculiar sort of horse-shoe diaper. This style prevailed all over Hindustan, and was continued with modifications varying with age and locality down almost to the Mahomedan conquest.

In Kashmir from the 8th century, if not earlier, till the Mahomedan conquest we find a style of architecture possessing a certain quasi-classical element which has little if any connexion with the art of the rest of India. The best-known example of this Kashmir style is the temple of Mārtand, about 3 m. east

from Islāmābād or Anantnāg, the old capital. It stands in a court 220 ft. long by 142 ft. wide surrounded by the ruins of some eighty small cells, with a large entrance porch at the east end. The temple itself was 60 ft. long by 38 ft. wide, with two wings, and consisted of two apartments—a *naos* and *cella*. The trefoil or cusped arch on the doors of the temple and cells is a striking peculiarity of the style, and may have been derived from the section of the Buddhist chaitya. It is used decoratively, however, rather than constructively. The pillars and pilasters of the portico and temple bear a close resemblance to some of the later forms of the Roman Doric, and have usually sixteen shallow flutes on the shafts, with numerous members in the base and capital. A triangular pediment surmounts the doorways, and on gable-ends or projecting faces are representations of double sloping roofs, much in the style of modern Kashmir wooden roofs, of which also many of the temple-roofs in Nepal are exaggerated examples. The Mārtand temple was, in all probability, built in the 8th century, between A.D. 725 and 760, and was erected as a temple of the Sun, one of whose names is Mārtand. For, till the 12th century at least, Sun-worship was quite prevalent in the north and west of India. At a remote village called Buniār is a much better preserved

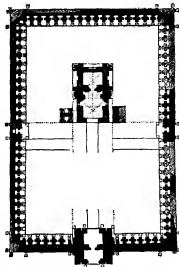

FIG. 2.—Plan of Temple of Mārtand.



specimen of the style: and at Avantipur, Vāngath, Payer and Pāndrethan are other interesting examples of the style. That at Pāndrethan about 3 m. from Srinagar is a well-preserved little temple, built between A.D. 906 and 921, and perhaps exhibits the most clearly the characteristics of the style.

In the Himalayas the architecture is still largely wooden, raised on stone basements and is often picturesque. In the Nepal valley we meet with hemispherical chaitiys or stupas

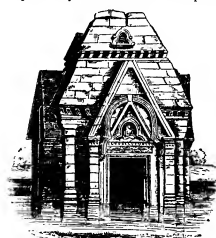

FIG. 3.—Temple of Pāndrethan.

on low bases with lofty brick spires, and some of them of great antiquity, along with temples having three or four storeys divided by sloping roofs, and others in the modern Hindu style of northern India.

In South Kanara, especially at Mūdbidare (Muddidri), there are also Jain temples and tombs with double and triple sloping roofs that resemble the native temples of Nepal, with which, however, they had no

connexion. The whole style is closely in imitation of wooden originals, the forms of which have been derived from the local thatched dwellings of the district. The interiors of the Kanara temples are often very rich in carving, the massive pillars being carved like ivory or the precious metals. Associated with these and other temples are elegant, monolithic pillars placed on square bases, the shafts richly carved and the capitals widespread, some of them supporting, on four very small colonnettes, a square roof elaborately modelled. These *stambhas* or pillars are the representatives of the early Buddhist *lāts* or columns raised at their temples, and bear emblems distinctive of the sects to which they respectively belong.

The southern portion of the peninsula is peopled by a race known as Dravidians, and to the style of architecture practised over most of this area we may conveniently apply the name of the race. This Dravidian architecture was essentially different from that of other regions of India and is of one type. One of the best-known groups of monuments in this style is that of the



FIG. 4.—Kailās at Ellora.

"Seven Pagodas" or the Māmāllapuram *rāths*, on the seashore, south from Madras. These *rāths* are each hewn out of a block of granite, and are rather models of temples than such. They are the earliest forms of Dravidian architecture and belong to the 7th century. To the same age belongs the temple of Kailāsānāth

at Conjeeveram, and to the following century some of the temples in the south of the Bombay Presidency, and the famous monolithic temple of the Kailās at Ellora near Aurangābād.

Buildings in the Dravidian style are very numerous in proportion to the extent of the area in which they are found. The temples generally consist of a square base, ornamented externally by thin tall pilasters, and containing the cell in which the image is kept. In front of this may be added a *mantapam* or hall, or even two such. Over the shrine rises the spire, of pyramidal form, but always divided into storeys and crowned by a small dome, either circular or polygonal in shape. The cornices are of double curvature, whilst in other Indian styles they are mostly straight with a downward slope. Another feature of these temples, especially those of later date, is the *gopurams* or great gateways, placed at the entrances to the surrounding courts, and often on all four sides. In general design they are like the spires over the shrines, but about twice as wide as deep, and very frequently far more imposing than the temples themselves.

The style is distinctly of wooden origin, and of this the very attenuated pilasters on the outer walls and the square pillars of small section are evidences. As the contemporary northern styles are characterized by the prevalence of vertical lines, the Dravidian is marked by horizontal mouldings and shadows, and the towers and *gopurams* are storeyed. The more important temples are also surrounded by courts enclosing great corridors and pillared halls.

One of the best examples of this style is the great temple at Tanjore. It would appear to have been begun on a definite plan, and not as a series of extensions of some small temple which, by accident, had grown famous and acquired wealth by which successively to enlarge its courts, as that at Tiruvallur seems to have grown by a series of accretions. The body of the Tanjore temple is of two storeys and fully 80 ft. high, whilst the sikhara or pyramidal tower rises in eleven storeys to a total height of 190 ft. This dominates the *gopurams* over the entrances to the court in which it stands, and to an outer court, added in front of the first, but which does not, as in other cases, surround it. The central shrine, so far as we know, was erected about A.D. 1025.

The Srirangam temple in Trichinopoly, the largest in India, is architecturally the converse of this: it is one of the latest in date, the fifth court having been left unfinished in the middle of the 18th century. The shrine is quite insignificant and distinguished only by a gilt dome, whilst proceeding outwards, the *gopurams* to each court are each larger and more decorative than the preceding. The successive independent additions, however, proved incompatible with any considered design or arrangement of parts.

Most of the Deccan was ruled by the Chalukya dynasty from early in the 6th century, and the style prevailing over this area,

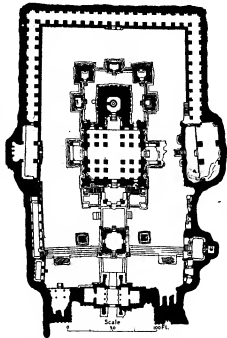

Reproduced, by permission of Mr John Murray, from Dr Burgess's *The Cave Temples of India*.

FIG. 5.—Plan of Kailās at Ellora.

from the Tungabhadra and Krishnā rivers to the Tapti and Mahānadi, may be styled, from them, as Chalukyan.

The earliest temples in this style, however, are not very clearly marked off from the Dravidian and the more northern styles. Some of them have distinctly northern spires, others are closely

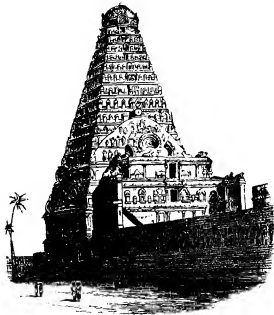

FIG. 6.—Temple at Tanjore.

allied to the southern style; and it was perhaps only gradually that the type acquired its distinctive characteristics. Till a late date we find temples with towers differing so little in form from Dravidian *vimānas* that, other details apart, they might readily be ascribed to that order.

Among Chalukyan temples a prevalent form is that of three shrines round one central hall. The support of the roofs of these halls is almost always after the Dravidian plan of four pillars,

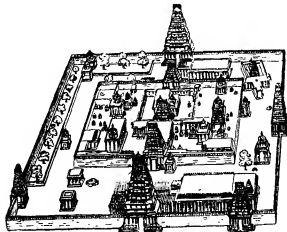

FIG. 7.—Temple at Tiruvallur, near Tanjore.

or multiples of four, in squares, so that larger domes were never attempted. Both in Dravidian and northern temples the projections on the walls are generally formed by increments of slight thickness added flatly to their faces, and, however thick, they are so placed as to leave the true corners of the shrines, &c., more or less recessed. In the Chalukyan temples the sides are often made prominent by increments placed over them, or the whole plan is star-shaped, the projecting angles having equal adjacent faces lying in a circle, as in the temple of Belūr in Mysore, built about A.D. 1120, and in others. The roofs are

stepped and more or less pyramidal in form, with breaks corresponding to the minor angles made on the walls.

Some of the details of this style are very elaborate; in fact, many of the finer temples were completely overlaid with sculptural ornament. The pillars are markedly different from the earlier Dravidian forms: they are massive, richly carved, often circular and highly polished. Their capitals are usually spread out, with a number of circular mouldings immediately below; and under these is a square block, while the middle section of the shaft is richly carved with mouldings in the round. In many cases the capitals and circular mouldings have been actually turned in a sort of lathe. They are almost always in pairs of the same design, the whole effect being singularly varied and elegant.

The great temple at Halebid (see Plate II. fig. 11), begun about A.D. 1250, was left unfinished at the Mahommedan conquest in 1310. It is a double temple, measuring 160 ft. by 122 ft., and is covered with an amazing amount of the richest sculpture. But the spires were never raised over the shrines. The Kedāresvara temple at Balagāmi is perhaps one of the oldest of the style in Mysore, and there are other good examples at Kubattūr, Harnhalli, Arsikere, Harihar, Koravangala and elsewhere; but their plans vary greatly.

Coming now to Northern India, we find the Hindu architectural style more widely spread and more varied than in the south, but wanting somewhat in individuality. Examples of the same order, however, are to be found also far to the south in the Chalukyan area. The characteristic that first appeals to our notice is the curvilinear spires of the temples, and the absence of that exuberance of sculpture seen in the great Chalukyan temples of the South; whilst in many cases, as in the Jain temples, a greater central area has been obtained in the halls by arranging twelve columns so as to support a dome on an octagonal disposition of lintels. The shrines are square in plan and only slightly modified by additions to the walls of parallel projections; the walls were raised on a moulded plinth of some height, over which was a deep base, the two together rising, roughly, to about half the height of the walls. Over this is the panelled face devoted to figure sculptures in compartments, but the tall, thin plasters of the southern style have disappeared. Above is the many-membered architrave and cornice supporting the roof and spire. The latter follow the vertical lines of the walls, presenting no trace of divisions into storeys or steps, but they vary in other details with the age.

In Rajputana and Western India a variety of this northern style has been known as the Jain order. Though used by the Hindus and Jains alike, it was employed in its most ornate form by the Jains in their famous temples on Mount Abū and elsewhere. A striking feature of this style is the elaborately carved roofs over their corridors and the domes of their porches and halls (see Plate II. fig. 12). Nothing can exceed the delicacy and elaboration of details in these sculptured roofs and vaults. Combined with the diversified arrangement of the variously spaced and highly sculptured pillars supporting them, these convey an impression of symmetry and beauty that is highly pleasing.

Gujarat must have been rich in splendid temples before the 12th century, but it was devastated so often by the Moslems that the more notable have all perished, though the once magnificent Sun Temple at Mudhera still witnesses, in its ruins, to the architectural style and grandeur of the period—the early part of the 11th century—when it was erected. A notable group of between thirty and forty temples in this style exists at Khajurāho in Bundelkhand. They belong to both the Hindu and the Jain cults, and mostly date from the 10th and 11th centuries. Many of them are covered, inside and out, with the richest sculpture, and may be regarded architecturally as “the most beautiful in form as well as the most elegant in detail” of the temples of Northern India. With these, the temples at Bhubaneswar in Orissa exhibit this style at its best. The latter have the earlier form of spire, nearly perpendicular below, but curving inwards near the summit.

The temple of Kanārak, known as the “Black Pagoda”

see Plate III. fig. 13), which for its size is, externally at least, the most richly ornamented building in the world. It has lately been filled up with stones and sand, as the only method the Archaeological Survey could devise to prevent its threatened collapse.

In the later examples of the style the spire is still a square curvilinear pyramid, to the faces of which are added smaller copies of the same form, carrying up the offsets of the walls; and in some examples these are multiplied to an extraordinary extent.

The Mahomedan architecture, also known as Indian Saracenic, begins in India with the 13th century and varied much at different periods and under the various dynasties, imperial and local. The imperial rulers at Delhi, for the first three centuries, were Pathāns, and were succeeded in 1526 by Baber, who founded the Mogul dynasty. Under the earlier Pathān emperors the style of building was massive but profusely ornamented and of extreme beauty in its details. Among the examples of this style may be instanced the Qutb Minār at Delhi (see Plate I. fig. 9), one of the finest pillars in the world, built in the first quarter of the 13th century. It is still 240 ft. high and ornamented by projecting balconies and richly carved belts between; the three lower storeys are cut up by projecting vertical ribs that add to its beauty. Beside it the tomb of Altamsh is also profusely sculptured and of extreme beauty of detail, and other examples are seen in the eastern portion of the adjoining mosque, the tomb of Ala-ud-din Khilji, and the Alai Darwāza. After about 1320 the Pathān architecture is marked by a stern simplicity of design and a solemn gloom and nakedness, in marked contrast to the elaborate richness of ornamentation of the preceding period. The tomb of Ghiyās-ud-din Tughlak at New Delhi, with its sloping walls and massive solidity, is a typical example of this period, as is also the Kalān mosque at Delhi completed in 1386.

Early in the 15th century, however, a reaction had set in, and the later style was hardly less rich and much more appropriate for its purposes than the earlier in the end of the 12th and early 13th century. The façades of the mosques became more ornamental, were often encrusted with marble, and usually adorned with rich and beautiful sculpture. This was clearly a return to the elaborateness of the past, but with every detail fitted to its place and purpose and presenting one of the completest architectural styles of the world.

About the beginning of the 15th century several local dynasties arose, each of which developed a style more or less their own. Of the Shārkī dynasty of Jaunpur only three great mosques in that city have come down to us, with several tombs. The cloisters surrounding the open courts of the mosques and the galleries within are closely allied to the Hindu style, being constructed with short square pillars having bracket capitals supporting lintels and roof of flat slabs. But the gateways and main features of the mosques are arched. The mosque itself consists of a central square hall covered by a lofty dome of the whole width of it, in front of which stands the great propylon or gate, of massive outline and rising to the full height of the central dome. This propylon had a large recessed arch between the two piers, in the lower portion of which was the entrance to the mosque, whilst the upper formed a pierced screen. On each side of the dome is a compartment divided into two storeys by a stone floor supported on pillars, and beyond this, on each side, is a larger apartment covered by a pointed ribbed vault. The ornamental work is bold and striking rather than delicate, and the *mīhrābs* or *qīblas* are marked by severe simplicity, and form a link in the evolution of the later form under Mogul rule. These buildings afford a marked expression of strength combined with a degree of refinement that is rare in other styles. Other examples of this style are met with at Benares, Kanauj and places within the Jaunpur kingdom.

In 1401 Dilawar Khān assumed independence in Malwa, of which Māndu became the capital, and his son Hoshang adorned it with important buildings. They are of a modified form of the Pathān style of the 14th century. Among them

the finest is the great Jama Masjid, which was finished by Mahmūd Shāh I. in 1454. It covers a nearly square area, 290 ft. from east to west by 275 ft. from north to south, exclusive of the porch on the east, which projects about 56 ft. Inside, the court is an almost exact square, surrounded by arches on each side, standing on plain square piers 10 ft. high, each of a single block of red sandstone; behind these are triple arcades on the north and south, a double one on the east, and on the west the mosque, having three great domes on its west side. This court, in its simple grandeur and expression of power, may be regarded as one of the very best specimens of this style to be found in India. The tombs and palaces of Māndu, mostly much ruined, it would occupy too much space to describe. But here, as elsewhere, the available materials have exercised a marked influence upon the architecture; the prevalence of a red sandstone is emphasized in the piers of the Jama Masjid, more than 300 of them being each of a single block of this material; and for more decorative purposes marble, both white and coloured, was freely used to revet the walls and piers. The style is strictly arcuate, without admixture of the general trabeate structural methods followed by the native Hindus; and while at Jaunpur and Ahmedābād, at the same period, we find the strong influence of native methods copied in the Mahomedan architecture, at Māndu the builders clung steadily to the pointed arch style, without any attempt, however, at groining.

The capital of the Bengal kingdom was at Gaur, which had been the metropolis of a native kingdom probably since the 9th century. As the country is practically without stone, the Hindu buildings would be chiefly of brick, but pillars, images and details were of hard potstone or hornblende; and these would afford materials for the Moslem conquerors. The construction of large buildings of brick required heavy piers for the arches and thicker walls than those constructed of stone. Then such piers and walls, when enriched by a facing of moulded or glazed tiles, would appear still heavier; and sometimes for tiles a casing of carved stone was substituted. Hence this style is a purely local one with short, heavy pillars faced with stone and supporting pointed brick arches and vaults. The use of brick further forced the builders to employ an arched style of their own and a mode of roofing in which a curvilinear form was given to the eaves descending at the corners of the structures. This form spread later up through Hindustan as far as the Punjab.

The capital at one time was moved to Pandua, north of Gaur, and there was built (1358-1368) the great Ādina mosque, 500 ft. in length by 285 in depth containing a large court surrounded by a thick wall of brick. The roof was supported by 266 stone pillars and covered by 378 domes, all of one form. Such a design has little architectural merit, but its size and the richness of its details make it an interesting study, and the same character belongs to most of the works of the Bengal Moslem rulers.

The Bahmanī dynasty, founded in 1347, had its capital at Gulbarga till 1428, when it was moved to Bidar. During this period the city was adorned with important buildings of which the most notable now remaining is the great mosque, one of the most striking in India. It measures over all 216 ft. from east to west by 176 from north to south. It differs from all the great mosques in India in having the whole central area covered over as in the great mosque at Cordova—what in others would be an open court being roofed by sixty-three small domes. The light is admitted through the side-walls, which are pierced by great arches on all sides except the west. The study is plain and substantial, with little ornament. The tombs of the kings are massive square-domed buildings, with handsome stone tracery on their outer walls, and are elaborately finished inside. At Bidar, mosques, palaces and tombs were also erected, but most of them have perished, the great mosque in the fort being the only one fairly entire. The ten tombs of the later Bahmanī kings, 5 m. from the city, are of like pattern with those of Gulbarga and of considerable



FIG. 13.—KALYĀNAK TEMPLE OF SŪRYA, OR BLACK PAGODA, FROM THE EAST.



FIG. 14.—TOMB OF MAHOMMED ADIL SHĀH, BIJAPUR.

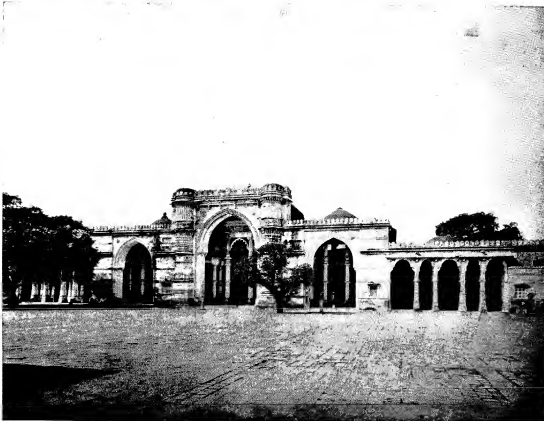

FIG. 15.—JAMA MAŠJID AT AHMEDĀBAD.  
*From Photographs kindly lent by the India Office.*

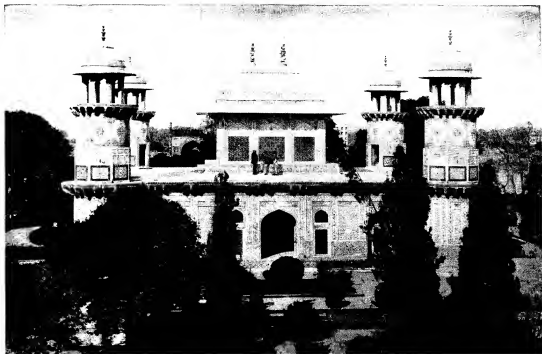

Photo. B. F. Peck & Co.

FIG. 16.—TOMB OF PRINCE ITIMAD-UD-DAULA, AGRA.

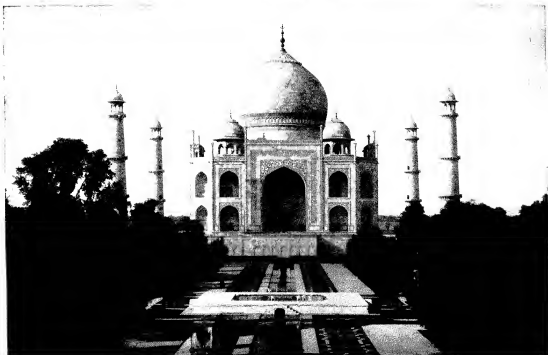

Photo. Johnston & Hofmann.

FIG. 17.—THE TAJ MAHAL, AGRA.

splendour. They are not much ornamented, but are structurally good and impressive by their massive proportions.

Of the various forms which the Moslem architecture assumed, "that of Ahmedabad," Fergusson has justly remarked, "may probably be considered as the most elegant, as it certainly is the most characteristic of all. No other form is so essentially Indian, and no one tells its tale with the same unmistakable distinctness." Under the Mahomedan rule the Hindu architects employed introduced forms and ornaments into the works they constructed for their rulers, superior in elegance to any the latter knew or could have invented. Hence there arose a style combining all the beauty and finish of the previous native art with a certain magnificence of conception which is deficient in their own works. The elevations of the mosques have usually been studiously arranged with a view to express at once the structural arrangements, and to avoid monotony of outline by the varied elevation of each division. The central portion of the façade was raised by a storey over the roof of the wings, and to the front of this was attached the minarets, in the earliest mosques forming only small towers over the façade, but soon after they became richly carved turrets of considerable height. The upper storey formed a gallery under the central dome which was supported on pillars connected by open stone trellis work, admitting a subdued light, and providing perfect ventilation (see Plate III. fig. 15). At first the façades were pierced by arched entrances, but at a later date a screen of columns formed an open front and the minarets were removed to the corners, no longer for the *mu'azzin*, but simply as architectural ornaments.

The tombs were pillared pavilions of varying dimensions, the central area over the grave covered by a dome standing on twelve pillars. These pillars connected by screens of stone trellis work carved in ever-varying patterns, and round this there might be a verandah with twenty pillars in the periphery, or a double aisle with thirty-two in the outer square. And as these were irregularly spaced in order to allow the inner twelve to support the lintels of a regular octagon for the dome, the monotony of equal spacing was avoided. For further details and examples of this style, however, we must refer the reader to the published volumes of the archaeological survey of Western India relating to Ahmedabad and Gujarat.

The Adil Shāhi dynasty of Bijapur (1492-1686) was of foreign extraction and held the Shiaah form of Islām, prevalent in Persia, whilst they largely employed Persian officers. This probably influenced their architecture and led to that largeness of scale and grandeur which characterized the style, differing markedly from that of the buildings of Agra and Delhi, but scarcely, if at all, inferior in originality of design and boldness of execution. There is no trace of Hindu forms or details; the style was their own, and was worked out with striking boldness and marked success. The mode in which the thrusts are provided for in the giant dome (see Plate III. fig. 14) of Mohammed Adil Shāh's tomb (A.D. 1650), by the use of massive pendentives, hanging the weight inside, has drawn the admiration of European architects. And this dome, rising to about 175 ft. from the floor, poofs over an area 130 ft. square, or 2500 sq. ft. larger than the Pantheon at Rome, where stability is secured only by throwing a great mass of masonry on the haunches. The Jami masjid, begun by Ali Adil Shāh, 1567, but never quite completed, is one of the finest mosques in India. The central area of the mosque proper is covered by a large dome, supported in the same way as that on Mahomed Shāh's tomb. This dome, like all the earlier ones in India, perhaps wants in outside elevation; but in the splendid Ibrahim Rauza and mosque we find the domes elevated above mere segments. In this latter group, erected about 1626, the domes are more elevated, and we have every detail of the structure covered with the most delicate and exquisitely elaborate carving, the windows filled with tracery, and the cornices supported by wonderfully rich brackets. In the tomb too—as in defiance of constructional demands—the room, 40 ft. sq., is covered by a perfectly level stone roof, supported only by a cove projecting on each side from the walls.

The Indian Saracenic style of the Mogul dynasty began under the emperor Bāber, 1526; but one of the first and most characteristic examples that remain is the mosque of Sher Shāh (1541) near Delhi (see Plate I. fig. 10), and others exist at Rohtās. These earlier structures are interesting as the initial forms of the style, but are little known to Europeans. The emperor Akbar (1556-1605) built largely, and the style developed so vigorously during his reign that it would be difficult to enumerate the peculiarities of his numerous buildings. As in the Gujārat and other styles, there is a combination of Hindu and Mahomedan features in his works which were never perfectly blended. Like their predecessors, the Pathāns, the Moguls were a tomb-building race, and those of the latter are even more splendid than those of the former, more artistic in design, and more elaborately decorated. The fine tomb of Akbar's father, Humāyūn, and the numerous structures at Fatehpur Sikri best illustrate the style of his works, and the great mosque there is scarcely matched in elegance and architectural effect; the south gateway is well known, and from its size and structure excels any similar entrance in India. And his tomb at Sikandra, near Agra, is a unique structure of the kind and of great merit.

Under Jahāngir the Hindu features vanished from the style; his great mosque at Lahore is in the Persian style, covered with enamelled tiles; his tomb near by (1630-1640) was made a quarry of by the Sikhs from which to build their temple at Amritsar. At Agra, the tomb of Itimād-ud-daula (see Plate IV. fig. 16), completed in 1628, built entirely of white marble and covered wholly by *pietra dura* mosaic, is one of the most splendid examples of that class of ornamentation anywhere to be found.

The force and originality of the style gave way under Shāh Jahān (1627-1658) to a delicate elegance and refinement of detail, illustrated in the magnificent palaces erected in his reign at Agra and Delhi, the latter once the most exquisitely beautiful in India. The most splendid of the Mogul tombs, and the most renowned building in India, is the far-famed mausoleum, the Taj Mahal at Agra (see Plate IV. fig. 17), the tomb of Mumtāz Mahal, the wife of Shāh Jahān. It is surrounded by a garden, as were almost all Moslem tombs. The extreme delicacy of the Taj Mahal, the richness of its material, and the complexity of its magnificent design have been dwelt on by writers of all countries. So also of the surpassingly pure and elegant Moti Masjid in the Agra fort, all of white marble: these are among the gems of the style. The Jama Masjid at Delhi is an imposing building, and its position and architecture have been carefully considered so as to produce a pleasing effect and feeling of spacious elegance and well-balanced proportion of parts. In his works Shāh Jahān presents himself as the most magnificent builder of Indian sovereigns.

In Aurangzeb's reign squared stone and marble gave way to brick or rubble with stucco ornament, and the decline of taste rapidly set in.

The buildings at Seringapatam and Lucknow are of still later date, and though in certain respects they are imposing, they are too often tawdry in detail.

**BIBLIOGRAPHY.**—J. Fergusson, *History of Indian and Eastern Architecture* (new ed., in press); Fergusson and Burgess, *Case Temples of India*, 8vo (London, 1880); J. Burgess, *Reports of the Archaeological Survey of Western India* (9 vols. 4to, London, 1874-1905); *Rock-cut Temples of Elephanta* (Bombay, 1871); *Buddhist Stūpas of Amaravati*, 4to, (1887); *Archæological Monuments, Temples, Sculptures, &c. in India*, 170 plates (fol. Griggs, London, 1897); *Gen. Sir A. Cunningham, Archaeological Survey of India Reports 1862-1885* (23 vols. 8vo, Calcutta, 1871-1886); H. Cole, *Preservation of Ancient Monuments in India*, 100 plates (fol. Griggs, London, 1866); G. le Bon, *Les Monuments de l'Inde* (6 vols. Paris, 1893); E. W. Smith, *Mughal Architecture of Fatehpur-Sikri* (4 vols. 4to, Allahabad, 1894-1898); Sir Lepell Griffin, *Famous Monuments of Central India* (10 vols. 8vo, Allahabad, 1891); *Archæological Architecture of Southern India* (4to, Madras, 1896); A. Führer, *Monumental Antiquities, &c. in the N.W. Provinces and Oudh* (4to, Allahabad, 1891); A. Foucher, *L'Art gréco-bouddhique du Gandhāra*, 2 tomes (8vo, Paris, 1905-1908); Grünwedel, *Buddhist Art in India* (Eng. trans., 8vo, 1901); R. Phéné Spiers, *Architecture East and West* (8vo, 1905); H. C. Fanshawe, *Delhi, Past and Present* (8vo, 1902); J. H. Ravenshaw, *Gaur: its Ruins and Inscriptions* (4to, 1878); Sayyid Muhammad Latif, *Lahore: its History, Architectural Remains, &c.* (8vo, Lahore, 1892);

H. Cousens, *Bijapur, the Old Capital of the Adil Shahi Kings* (8vo, Poona, 1908); G. W. Forrest, *Cities of India* (8vo, 1903); Dr W. H. and Mrs Workman, *Through Town and Jungle, among the Temples and People of the Indian Plains* (8vo, 1904). (J. Bs.)

**INDIAN LAW.**—The law in force in British India may be conveniently divided into five heads: (1) The law expressly made for India by the British parliament, or by the sovereign. (2) English law in force in India though not expressly made for India. (3) The law made by persons or bodies having legislative authority in India. (4) Hindu law. (5) Mohammedan law. The first three of these are frequently described as Anglo-Indian law. They are with rare exceptions territorial, i.e. they apply generally, either to the whole of India, or to a given area, and to all persons within those limits. The last two are personal, i.e. they apply only to persons who answer a given description.

1. *The Law expressly made for India by the British Parliament or the Sovereign.*—There are in existence about 120 acts of parliament containing provisions relating to India. The greater portion of these provisions relate to what may be called constitutional law, such as, the power of the East India company, the transfer of these powers to the crown, the powers of the secretary of state, of the Indian council, of the council of the governor-general, and of the other councils in India, and so forth. The law made by the sovereign consists mainly of charters granted to the four high courts of Bengal, Madras, Bombay and the North-West Provinces. A great many charters were granted to the East India Company, and some of the earlier ones contained very important provisions as to the legislative and judicial authority to be exercised in India, but these provisions are now obsolete.

2. *The English Law in force in India though not expressly for India.*—A considerable portion of the law of England, both statute law and common law, was introduced into India by the assumption that when courts of justice were established in India, to be presided over by English judges, it followed that they were to administer English law as it stood at the time of the granting of the charter so far as it was applicable. There has been considerable doubt as to when this assumption ceased, but the date generally assigned for this purpose is 1726. It only applied, however, to courts established before this date under the direct authority of the crown, that is to the charter courts of Calcutta, Madras and Bombay, and at a very early date (21 Geo. III. c. 70) the jurisdiction of these courts was limited, practically, to the inhabitants of the presidency towns and to suitors of European origin residing elsewhere. Moreover, even in the presidency towns, these courts were directed to apply to Hindus and Mohammedans their own laws in regard to all matters of inheritance and succession, family law and matters relating to religion or caste. In the territories outside the presidency towns where courts of justice were established by the East India company, acting under the authority of the emperor of Delhi, the only assumption that could be made as to the law to be administered was that it was the law already in existence. Acting on this assumption the company's courts administered the Mohammedan criminal law which was the general law of the subjects of the Mogul emperor: the revenue system remained, as did also the existing relations of zemindar and ryot, i.e. of the cultivator and of the persons intermediate between the state and the cultivator. In regard to matters of family law, inheritance and succession, religion and caste the company's courts were expressly enjoined to apply the Hindu law to the Hindus, and the Mohammedan law to the Mohammedans. Of course it was also the duty of these courts to recognize well-established local usages. Thus practically all the topics of litigation at that time likely to arise were provided for. It was as time went on, when by intercourse with Europeans new ideas, and with them new wants, sprang up in the native populations, that gaps came to be discovered in the law. To such cases the judges had been vaguely told that they were to apply "the rules of equity and good conscience," which they naturally sought in the English law. The matters in which the notions of English law have most affected India are the power of completely

separating the ownership of property from the enjoyment of it by means of trusts, the testamentary power, the creation of life estates, the substitution of one owner of property for another on the happening of some future event, the rules of evidence, criminal law, civil and criminal procedure and the subordination of the executive to the ordinary law. Upon all of these topics the law of India is mainly English. Not that the whole of it rests upon the slender authority above described. Much of it, as will appear presently, was introduced by the Indian legislatures; much of it also, although originally introduced by the courts, has since received legislative sanction.

3. *The Law made by Persons or Bodies in India having Legislative Authority.*—As a general proposition it would be true to say that wherever a British authority has legislated in India it has been largely influenced by the English law. The legislative authorities in India are very numerous. Those now existing are (1) the governor-general of India in council; (2) the governor of Madras in council; (3) the governor of Bombay in council; (4) the lieutenant-governor of Bengal in council; (5) the lieutenant-governor of the North-Western Provinces in council; (6) the lieutenant-governor of the Punjab in council; (7) the lieutenant-governor of Burma in council; (8) the lieutenant-governor of Eastern Bengal and Assam in council. No legislative enactments of any kind passed in India before 1793 are now in force. In Bengal in the year 1793 forty-eight regulations (as they were then called) were passed in a single day, and it was assumed that all previous legislation in Bengal was thereby superseded. Similar regulations were passed about the same time, and the same assumption was made, in Madras and Bombay. As new territories were acquired by the government of India, the existing regulations were in some cases extended to them, but in other cases this was thought not to be convenient, and for these territories the governor-general in council issued general orders, not in the regular way of legislation but in exercise of his executive power. Hence the distinction between "regulation" and "non-regulation" provinces. Any doubt as to the validity of the orders so made was removed by the Indian Councils Act 1861. The term "regulations" was dropped after the passing of the 3 & 4 Will. IV. c. 85 (1833), and since that time the word "Acts" has been in use. Acts are referred to by the year of their enactment.

Several attempts at extensive legislation in India, intended apparently as a step towards a general codification of the law, have been made. The act of 1833 above mentioned directed the issue of a commission in India which was intended to survey the whole field of law and to suggest such alterations as appeared desirable. Of this commission Lord Macaulay was a member. It never attempted to perform the large task indicated in its appointment, but it produced a draft of the Penal Code (Act XIV. of 1860). It was not, however, until 22 years after Lord Macaulay left India that the Penal Code became law, and in the meantime the draft had been a good deal altered. The Penal Code is, undoubtedly, the most important, as it is also the most successful, effort of Indian legislation. It is to a large extent a reproduction of the English law of crimes. But there are some important differences; for whereas there are in English law no authoritative definitions of such important crimes as murder, manslaughter, assault and theft, and many kindred offences, the Penal Code seeks to define every crime with precision. Moreover, the Penal Code imports into the definition of nearly every crime, and, therefore, into the charge on which the accused is tried, words the purport of which is to describe the state of mind of the accused at the time the alleged act was committed, thereby making it necessary to ascertain at the trial what that state of mind was. This in England is not necessary to anything like the same extent. For example in England, in order to charge a man with manslaughter all that is necessary to allege is that A killed B. But in order to charge a man with culpable homicide it is necessary to state with much particularity what the accused intended, or what he knew to be likely to happen when he did the act; and this condition of mind must be proved at the trial. It is true that this proof is facilitated by certain presumptions,

but nevertheless it sometimes presents considerable difficulty. On the other hand, in dealing with offences against property the authors of the Penal Code have cleared away entirely the difficulties which have long beset the English law as to how to deal with a man who, having become possessed of property, dishonestly misappropriates it. English lawyers have tried to squeeze as many of these cases as they can into the crime of larceny. The Penal Code simply makes dishonest misappropriation a crime in itself. (See further CRIMINAL LAW.)

In 1853 and again in 1861 commissions were appointed in England to draw up a body of laws for India "in preparing which the English law should be used as a basis," but the only direct result of these two commissions was the Indian Succession Act (Act X. of 1865). But as Hindus and Mahomedans are excluded from the operation of this act its application is limited. The wills of Hindus are provided for by Act XXI. of 1870. Two important acts, however, were passed in India shortly after the attempt to legislate for India through commissions sitting in England came to an end, namely the Evidence Act (Act I. of 1872) and the Contract Act (Act IX. of 1872). Both these acts have been a good deal criticized. Two other important acts passed somewhat later are the Transfer of Property Act (Act IV. of 1882) and the Trusts Act (Act IV. of 1882). These acts are all substantially reproductions of the English law.

The law relating to land revenue has been the subject of innumerable regulations and acts of the Indian legislature. A description of the revenue systems prevailing in India will be found in the article on India. The law which governs the relation of ryots (*i.e.* cultivators) to those who for want of a better term we must call landlords has grown to a considerable extent out of the revenue system. The view which was at first taken of this relation was unfortunately affected by English notions of the relation of landlord and tenant, but this view has been considerably modified in favour of the tenant by recent legislation.

BOOKS OF REFERENCE ON ANGLO-INDIAN LAW.—Morley, *Analytical Digest* (1849); Stokes, *Anglo-Indian Codes* (1887); Ilbert, *Government of India* (1906), which contains a very useful Table of Acts of Parliament and Digest of their contents; Strachey, *India, its Administration and Progress* (1903); Baden-Powell, *Land Systems of British India* (1892); Wigley, *Chronological Tables of Indian Statutes* (Calcutta, 1897).

4. *Hindu Law*.—The Hindu law is in theory of divine origin, and therefore unchangeable by human authority. Ask a Hindu where his law is to be found, and he will reply "In the Shasters." The Shasters are certain books supposed to be divinely inspired, and all of great antiquity.

They contemplate a state of society very unlike that of the present day, or that of many centuries back. It follows that these sacred writings, whilst they leave many of the legal requirements of the present day wholly unprovided for, contain many provisions which no Hindu even would now think of enforcing. Consequently, in spite of the theory, the law had to be changed. Legislation, which with us is the most potent as well as the most direct instrument of change, has had scarcely any effect on the Hindu law. Probably it never entered into the head of any Hindu before British rule was set up in India that any human agency could be entrusted with the power of making or changing the law; and although both the Indian legislatures and the British parliament have full power to legislate for Hindus upon all matters without any exception, they have, in fact, hardly ever exercised this power as regards the Hindu law. Custom is a less direct instrument of change than legislation, and operates more slowly and secretly, but its influence is very great. The custom which supplants the sacred law may indeed be as old or older than the sacred law, and its existence may be due to the divinely inspired law having failed to displace it; or the habits and necessities of the people may have engrained the custom upon the sacred law itself. In either view there has been no difficulty in accepting custom where it varied from the sacred law. Indeed, the sacred books themselves recognize to some extent the operation of custom. Thus we

find it said in the Laws of Manu (viii. 4, 1), "the king who knows the sacred law must inquire into the laws of castes, of districts, of gilds and of families, and thus settle the peculiar law of each." It is to the influence of custom that the divergence between the Hindu law of to-day and that of the Shasters is largely due. Another method by which law is developed, and one more subtle still, is interpretation; and it is one which in skillful hands may be used with considerable effect. Without any dishonesty, people very often find in the language of the law words sufficiently vague and comprehensive to cover the sense which they are looking for. The action of interpretation upon Hindu law differs accordingly as it took place before or after the British occupation. Formerly the only persons whose interpretation was accepted as authoritative were the writers of commentaries. But the Indian courts are very sparing in accepting modern commentaries as authoritative, though nevertheless they carefully record their own interpretations of the law, and these are always treated as authoritative. It follows, from the very nature of the influences thus brought to bear upon law, that not only have the sacred books been departed from, but that different results have been arrived at in different parts of India. The differences have led recent writers to speak of five schools of Hindu law, called respectively the Benares school, the Bengal or Gauriya school, the Bombay school or school of western India, the Dravida school or school of southern India and the Mithila school—the district last named being a very small one to the south of and adjoining Nepal. But it would be a great mistake to suppose that the differences between these so-called schools are comparable to each other in importance. As will appear presently, it would be much more correct to speak of two schools, that of Benares and that of Bengal—the other three being subdivisions of the first.

It will be convenient to give a short description of those of the sacred books which are actually in use in the Indian courts when they desire to ascertain the Hindu law. Of these **Sacred Books** by far the first in importance, as well as the first in date, is the one which we call the Laws of Manu.

It has been translated by Professor Bühler, and forms vol. xxv. of the "Sacred Books of the East," edited by Professor Max Müller. If we examine it, we find that only about one-fourth of the book deals with matters which we should call legal, the rest being concerned with topics either purely religious or ceremonial. And of these topics only one, that relating to partition of family property, belongs to that portion of the Hindu law which is administered in the courts, and, as one would expect, what is said on this topic has been largely departed from under the influences above described. Very little is known as to the date of the Laws of Manu. They are probably much older than their present form, which Bühler places somewhere between 200 B.C. and A.D. 200. Of more interest than the exact date is the state of society which they disclose. The tribal and nomadic stage had passed away. Society had so far settled down as to possess a regular form of government under a king. The people were divided into four great castes, representing religion, war, commerce and agriculture and servitude. Justice is spoken of as administered by the king. Provision is made for the recovery of debts and the punishment of offences. There are rules relating to the pasture of cattle, trespass by cattle and the enclosure of cultivated fields. There was evidently considerable wealth in the shape of horses, carriages, clothes, jewelry and money. There is no mention of land in general as the subject of permanent private property, though no doubt the homestead and the pasture land immediately adjoining were permanently owned.

The (so-called) Smṛiti of Yajñavalkya was, no doubt, a work of considerable importance in its day, and is still sometimes referred to. It shows a somewhat more advanced state of society than the Laws of Manu. The occupier of land has a firmer hold upon it, and there seems to be even a possibility of transferring land by sale. The date of it has not been fixed, but it is thought to be later than the Laws of Manu.

The Smṛiti of Narada belongs to a still later period, perhaps



to the 5th or 6th century of our era. It goes more into detail than the other two books just mentioned.

But far more important for practical purposes than these sacred books are the commentaries. These are not sacred. The most important of them all is that known as the *Mitacschara*. The author of it was named *Vijnaneswara*. His work is a commentary on the *Smriti* of *Yajñavalkya*, and it is supposed to have been written in the latter half of the 11th century. Only a portion of it is used by the law courts—that portion which relates to the partition of family property. The *Mitacschara* is an important authority for Hindus all over India, and in the greater part its authority is supreme. But there is one very important exception. In the district which is sometimes called *Bengal Proper* (from its correspondence with the ancient kingdom of Bengal, of which *Gaur* was the capital), and may be roughly described as the valley of the Ganges below *Bhagalpur*, the prevailing authority is a treatise called the *Dayabhaga*. It is, like the *Mitacschara*, as its name imports, a treatise on partition. The author of it was *Jimitavahana*. There does not appear to be any more distinct clue to its date than that this author wrote after the 12th century and before the 16th. The very important points of difference between the two commentaries will be stated hereafter. In western India there is a commentary of authority called the *Vyavahara Mayukha*. It belongs to the 16th century. Generally its authority is secondary to that of the *Mitacschara*, but in *Gujrat* its authority is to some extent preferred. In the south of India the *Smriti Chandrika* is a work of importance. It belongs to the 13th century. It generally follows the *Mitacschara*, but is fuller on some points. The *Vivada Chintamani* is used in the small district of *Mithila*. It is said to belong to the 15th century.

The joint family is by far the most important institution of Hindu society, and it is only through the joint family that we can form a proper conception of the Hindu law.

**The joint family.** It is the form in which the patriarchal system has survived in India. There is nowhere in Hindu literature, ancient or modern, a description of it as it has existed at any time. In its general features it has always been too universal and too well known to be described. In the *Laws of Manu* we find very little about it, but what we do find is of great interest. The subject is taken up with reference to a question which in every patriarchal system imperatively requires an answer. What is to be done when a break-up of the family is threatened by the death of the common ancestor? Upon this subject the author of the *Laws of Manu* says in chap. ix. v. 104: "After the death of the father and the mother, the brothers being assembled, may divide among themselves in equal shares the paternal estate, for they have no power over it while the parents live." Then in v. 105, "or the eldest son alone may take the whole paternal estate; the others shall live under him just as they lived under the father." And in v. 111, "Either let them thus live together, or apart if each desires to gain spiritual merit, for by their living separate merit increases, hence separation is meritorious."

We may put aside what is said about the mother which is probably a survival of polyandry, and is now obsolete, and fix our attention upon three important points: (1) Authority is attributed to the father during his life; (2) the same absolute authority is attributed to the eldest son upon the father's death, if the family remains undivided; (3) the sons are at liberty, are indeed recommended, to divide the property. Now, though there may be doubts as to how far this type of family was at any time the universal one, there cannot be any doubt that in those early times it largely prevailed, and that the modern Hindu joint family is directly derived from it. Moreover, it must be remembered that what is here discussed is not ownership, but *managership*. If the family remained undivided, the eldest son did not take the family property as owner; he only became the uncontrolled manager of it. So far as there was any notion of ownership of the family property, and it was in those early times quite rudimentary, it was in the nature of what we call corporate ownership. The property belonged

not to the individual members of the family collectively, but to the family as a whole; to use a modern illustration, not to the members of a family as partnership property belongs to partners, but as collegiate property belongs to fellows of a college. Probably, however, in early times it never occurred to any one to look very closely into the nature of ownership, for until the question of alienation arises the difference between *managership* and ownership is not of very great importance; and this question did not arise until much later. When and under what circumstances Hindus first began to consider more carefully the nature of ownership we have no means of ascertaining. But we have very clear evidence that there was at one time a very warm controversy on the subject. Each of the two leading commentaries on Hindu law, the *Mitacschara* and the *Dayabhaga*, opens with a very long discussion as to when and how a son becomes entitled to be called an owner of the family property. Two conflicting theories are propounded. One is that the sons are joined with the father in the ownership in his lifetime; the other is that they only become owners when he dies, or relinquishes worldly affairs, which, according to Hindu ideas, like taking monastic vows, produces civil death. The author of the *Mitacschara* adopts the first of these views; the author of the *Dayabhaga* adopts the second; and this radical difference led to the great schism in the Hindu law. It follows that, according to the *Dayabhaga* view, the sons not being owners, the father is sole owner. He is both sole owner and uncontrolled manager. According to the *Mitacschara* view the father and the sons together are the owners, not as individuals, but as a corporation. But even this is not inconsistent with the father retaining his absolute control as manager. How far he has done so will be considered presently.

Hitherto, for the sake of simplicity, the position of father and son has alone been considered; but now take the case of several brothers living together with sons and grandsons. What is the nature of the ownership in this case, and in whom is it vested? Neither in the *Dayabhaga* nor in the *Mitacschara* is this question discussed directly, but each of these commentaries discloses the answer which its author would give to this question. According to the *Mitacschara*, of however many different branches, and of however many different members, a family may consist, they all form a single unity or corporation to which the family property belongs. Not that this is asserted in so many words; there is probably no Sanskrit word corresponding at all nearly to our word corporation. But this is the only language in which a modern lawyer can describe the situation. The members of the family are not partners; no one can separately dispose of anything, not even an undivided share. It is quite otherwise under the *Dayabhaga*. The property belongs to the members of the family, not as a corporation, but as joint owners or partners. Each is the owner of his undivided share; but not all the members of the *Dayabhaga* family have a share in the ownership; the sons whose fathers are alive are entirely excluded; the owners are those members of the family of any age who have no direct living ancestor.

This was the nature of family ownership in its two principal forms, but the possibility that an individual member of the family could have something exclusively his own is clearly recognized in the *Laws of Manu*. Thus in chap. ix. v. 206, it is said, "Property acquired by learning belongs solely to him to whom it was given, likewise the gift of a friend, a present received in marriage, or with the honey mixture." And again in v. 208, "What the brother may acquire by his labour without using the patrimony, that acquisition made solely by his own effort he shall not share, unless by his own will, with his brothers"; and these texts, as we shall see presently, are still of practical application. Nowhere has a strict family system prevailed without some analogous measure of relief (see Sir H. Maine, *Early History of Institutions*, p. 110).

The modern Hindu joint family is a community the members of which are all descended from a common ancestor, and the wives and unmarried daughters of those who are married.

Perhaps the wives and daughters might more correctly be said to belong to the family than to be members of it. In its complete form the family is said to be joint in food, worship and estate; and notwithstanding the divergence between the Mitacschara and Dayabhaga systems, the main external features of such a family are the same all over India. Every Hindu family has a common home. This does not mean that there is a single house in which all the members of the family continuously reside, but there is one house where the family gods remain, where the wants of all the members of the family are provided for, where the family worship is conducted, and to which every member of the family is at any time at liberty to resort. This is the real home of a Hindu. Any other residence, however long it may last, is looked upon as temporary. Here also the wives and children remain whilst the men are employed at a distance. With regard to the enjoyment of the family property there is no distinction, except such as the members of the family themselves choose to make. Everything is enjoyable in common. This is the same all over India. It is very necessary to distinguish between ownership and enjoyment. Although the ownership of the family property under the Mitacschara differs very materially (as explained above) from that under the Dayabhaga, the enjoyment in both cases is the same. There is one common fund out of which the wants of the family are supplied. No one is dependent upon his own contribution to the family fund. No one member can say to another, "You have consumed more than your share, and you must make it good." On the other hand, whatever is earned goes into the common stock. Though separate acquisition is possible, it is exceptional, and there is always a presumption that the earnings of all the members belong to the common fund, so that if any member claims property as self-acquired he must establish his assertion by evidence as to how he acquired it, and that he did so "without using the patrimony." The accounts of the family are kept by the manager, who is usually the eldest male, and he also generally manages the property. But he is assisted and controlled by the other members of the family. No separate account is kept of what each member contributes or receives. The expenditure on behalf of the various members of the family is scarcely ever equal, but this inequality creates no debt between the members of the family. If any one is dissatisfied he can protest, and if his protest is not listened to, there is only one remedy—he can demand a partition. The powers of the manager are those of an agent: it is very rare to find them formally expressed, and they must be gathered from the usual course of dealing, either amongst Hindus generally, or in the particular family to which the manager belongs; and it is the custom for all the adult male members of the family to be consulted in matters of serious importance. The alienation of land is always looked upon as a matter of special importance, and, except in cases of urgent necessity, requires the express assent of all the members of the family.

If any member of a Hindu family who is one of the co-owners wishes for a partition, he can demand one, there never having

**Partition.** been any compulsion on the members of a Hindu family to live in common. Of course in a Dayabhaga family there can only be a partition as between brothers, or the descendants of brothers; between a father and his sons there can be no partition, the sons not being owners. The father may, if he chooses to do so, distribute the property amongst his sons, and he sometimes does so; but this is a distribution of his own property, and not a partition. The father can distribute the property as he pleases. But the absolute power of the father in this respect has only been recently established. It used to be thought that, if the father made a distribution, he must give to each of his sons an equal share. It is now settled that the father is absolute. Under the Mitacschara, the ownership being vested in the father and sons, there can be a partition between father and sons, and the sons can always insist that, if a partition is made, their rights shall be respected. Whether, under the Mitacschara law, the sons have the right to demand a partition in opposition to their

father has been much disputed. It is now generally considered that the sons have such a right.

In modern times if a partition takes place everything belonging to the family in common must be divided, even the idols. If there is only one idol, then each member of the family will be entitled to a "turn of worship," as it is called. It is, however, open to the members of the family to make any special arrangements either for retaining any portion of the property as joint, or as to the mode of carrying out of the partition, provided they can all agree to it. It is remarkable that in the Laws of Manu no such complete partition as can now be required is prescribed. A list of articles is given of considerable importance of which no partition could be aimed. In chap. ix. v. 210, it is said, "A dress, a vehicle, ornaments, cooked food, water and female slaves, property destined for pious uses and sacrifices, and a pasture ground" are all declared to be indivisible. Land and the right of way to the family house were also at one time indivisible. These things, therefore, must have been used in common after partition had taken place, which looks as if the family were not entirely broken up; and it is possible that they inhabited several houses within the same enclosure, as is sometimes seen at the present day. It is not always easy to subdivide property amongst the sharers, especially where they are numerous; and cases occur where a better division could be made by selling the whole or a portion of the property, and dividing the proceeds. This could always be done with the consent of all the sharers; and now by Act IV. of 1893 of the governor-general in council it can be done with the consent of a moiety in value of the sharers.

Rulers in India are apt to look upon their territories as private property, but there is no instance on record of the succession to the throne being considered as partible. On the contrary, in the families which now represent the small mediatised princes, the family property is frequently, by a special custom, considered to be impartible. The property descends to the eldest male, the younger members of the family getting allowances, generally in the form of temporary assignments of portions of the family property.

Of course only the family property can be divided, and if any of the members make a claim on the ground of self-acquisition to exclude anything from partition, this claim must be considered; and if it is upheld, that portion of the property must be excluded from partition. These claims sometimes give rise to a good deal of litigation, and are not always easy to determine. It must be borne in mind, however, that self-acquired property becomes family property as soon as it has once descended. Thus if a man by a separate trade earns Rs. 10,000, and dies leaving two sons and the son of a third son, these persons form a joint family, and the Rs. 10,000 is family property. So also family property which has been partitioned remains family property still. Thus if A, a bachelor, gets on partition a piece of land and afterwards marries and has sons, under the Mitacschara law the father and sons form a joint family as soon as the sons are born, and to this family the land belongs.

When we come to deal with the question of what shares are taken on partition, it is convenient to follow the example of the Hindu commentators, and to treat the subject of inheritance in conjunction with it. The relative importance of these two subjects has not always been perceived, particularly by the early English writers on Hindu law. H. T. Colebrooke, the learned and accomplished translator of the Mitacschara and the Dayabhaga, published the two treatises together in one volume which he called *The Law of Inheritance*. But these treatises, although they deal incidentally with inheritance, are both described by their authors as treatises on partition only; and this, no doubt, is because the subject of inheritance, apart from partition, is of comparatively small importance. Inheritance is the transfer of ownership which occurs at and in consequence of a death. It follows from this that in a Mitacschara joint family there is no inheritance. The death of a member of the family makes no change in the ownership; not any more than the death of a fellow in the ownership of a college, or of

**Inheritance.**

a shareholder in the ownership of a railway company. In a Dayabhaga family there is a case of inheritance whenever a member dies. The share of that member descends to his heir. But here, again, no perceptible change in the affairs of the family is occasioned thereby. The enjoyment of the family property is no more affected thereby than by a death in a Mitacschara family. It is only when a partition takes place that the devolution of the shares by inheritance has to be traced. Inheritance, therefore, apart from partition, has not to be considered when we are dealing with family property under either system.

Let us now consider partition in a Mitacschara family. Of course the only persons who can claim a share are the members of the family. These, as has been said, are the male descendants of a common ancestor through males, their wives and daughters. But the females are entirely excluded from any share on a partition, and we have to consider the males only. The rule for ascertaining the share to which each member of the family is entitled can be best explained by the following diagram, which represents the male members of a Mitacschara family of whom A is the common ancestor:—

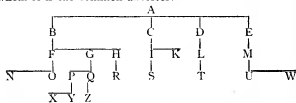

The whole family may be considered as forming one group, which may conveniently be called the group A; and it is evident on inspection that the family may be subdivided into a number of smaller groups each similarly organized, each group consisting of a man and his own male descendants. Thus besides the group A we have the group B, consisting of B and his descendants; the group C, consisting of C and his descendants; and so on. A group may die out altogether, as if U and W were to die childless, E and M being already dead. The rule of partition proceeds upon the supposition—not an unnatural one—that a family, when it breaks up, separates always into groups, and that the shares are moulded accordingly. For example, suppose that when the partition is made the surviving members of the family are N, O, S, T, X, Y, Z; then to find the shares we must go back to the common ancestor and reconstruct the pedigree. There were at first four groups, but at some time, it is immaterial when, by the death of E and all his descendants the groups have been reduced to three; hence the first step is to divide the property into three equal parts, assigning one to each group. The group B was originally represented by three smaller groups, but now by only two, the groups F and G, and to each of these we assign  $\frac{1}{3}$  of  $\frac{1}{3}$ , or  $\frac{1}{9}$ . And, of the  $\frac{1}{9}$  assigned to the group F, N will get  $\frac{1}{18}$  and O will get  $\frac{1}{18}$ . The other  $\frac{1}{9}$  is divided between the groups P and Q, each group getting  $\frac{1}{18}$ . Then in the group P, X and Y will each get  $\frac{1}{36}$ , while Z, as the sole representative of the group Q, will get  $\frac{1}{18}$ . It may be noted in passing that this principle of division survives in the succession *per stirpes*, of which we find so many examples in other systems of law which had their origin in the patriarchal system. By a similar process we should find that S and T each got  $\frac{1}{3}$  of the property, they being the sole representatives of the groups C and D respectively. For the sake of simplicity we have taken a case where no example occurs of a father and son being both alive at the time of partition. But suppose P to be alive in addition to the persons mentioned above; then the group P gets  $\frac{1}{9}$ , and that group consists of three persons, P, X and Y. There is no precise rule as to how the partition was to be made in such a case in the older Hindu law, and it is rarely that a partition takes place between father and sons, but if there should be one it is always assumed that the shares are equal, i.e. in the case under consideration each would take  $\frac{1}{27}$ .

Turning now to a Dayabhaga family, we find that the property is vested, not in the family as a whole, but in certain individual members of it—that is to say, in those male members of the

family who have no ancestor alive. And inasmuch as the undivided share of each member is his own, it follows that at his death inheritance will operate and it goes to his heirs. In order, therefore, to find what share each member takes on partition under the Dayabhaga, we must inquire into the history of the family and ascertain what share has become vested in each member of the family by the ordinary rules of inheritance. The rules of inheritance, as laid down in the Dayabhaga, are not very dissimilar to those which we find in other parts of the world. Everywhere we find that a man's property is taken by his nearest relatives, but there are differences in the way in which proximity is reckoned. Everywhere also there is a preference given to males and the relatives through males over females and the relatives through females, but there are differences in the extent to which this preference is carried. The relatives of a man through males are called his agnates; the relatives of a man through females are called his cognates. In the Hindu law as at present administered there is no primogeniture, and a decided preference of males over females and of agnates over cognates. With regard to the question of proximity, the Dayabhaga lawyers deal with the matter in a very curious way. All Hindus, as is well known, offer some sort of sacrifice to their deceased relatives, and the person by whom the sacrifice is to be offered as well as the nature of the offering are very carefully prescribed. These sacrifices are said to confer a "spiritual benefit" upon the deceased, and this spiritual benefit is greater or less according to the nature of the offering and the person who offers it. Now the Dayabhaga lawyers say that the person whose offering confers the greatest spiritual benefit is entitled to succeed as heir. This being the theory, we must see what rules govern in India the offering of sacrifices to the dead.

The most important offering is that of the pinda, or rice cake, and the persons who are entitled to make this offering to the deceased are called his sapindas. The offering next in importance is that of the lepa, or fragments of the cake, the crumbs as we might call them, and the persons who make this offering are called sakulyas. The offering of least importance is the simple libation of water, and persons connected by this offering are called samonadacas. But who are sapindas, sakulyas and samonadacas respectively, and of each class whose offering is most efficacious? Practically we shall find that this question is solved by rules of consanguinity not unlike those which we meet with elsewhere. First of all come the sons; their offering is most efficacious, so that they are the nearest heirs and all take equally. Then come the sons' sons; then the sons' sons' sons. Here we break off. The line of inheritance is not continued beyond the great-grandsons. There are other cases in which, as we shall see, there is a similar break when we get three degrees away from the propositus: nor is this peculiarity confined to the Hindu law. We find traces of a similar break in the Roman and in the Teutonic law. After the great-grandson comes the widow. It is difficult to establish her claim on the ground of spiritual benefit, and it rests upon authority rather than principle. The opinions of ancient writers on the subject are very conflicting. They are set forth at great length in the Dayabhaga, with a conclusion in favour of the widow. Probably the intrusion of the widow is connected with the fact that she could in early times by cohabitation with a brother, and in later times by adoption, procure an heir to her sonless husband. Next to the widow come the daughters and then the daughters' sons. Their position, again, may be referred to the notion which prevailed in early times, that a Hindu who had no son of his own might take one of his daughters' sons and make him his own. Then comes the father, then the mother, then the brothers, then the brothers' sons, and then the brothers' sons' sons. The sisters are excluded, but their sons succeed after the brothers' sons' sons; then come the brothers' daughters' sons. Then, leaving this generation, we go a step backward, and proceed to exhaust the previous generation in precisely the same way. It is only necessary to enumerate these in their order: father's father, father's mother, father's brothers, father's brothers' sons,

father's brothers' sons' sons, father's sisters' sons, father's brothers' daughters' sons. Then going another step backwards we get father's father's father, father's father's mother, father's father's brothers, father's father's brothers' sons, father's father's sisters' sons, father's father's brothers' daughters' sons.

So far the line of succession is confined either strictly to male agnates, or to persons who may restore the broken line of male agnate relationship. But at this point, under the Dayabhaga, instead of exhausting the male agnates still further, as we might expect, we turn now to the cognates, *i.e.* the relatives of the deceased through the mother. It is said that these are also in some way sapindas. They are generally called bandhus. There is some difficulty in finding out the order in which they succeed, and since it is rare that an heir has to be sought outside the father's family, the question has not been much discussed. The question would have to be decided by the religious doctrine of spiritual benefit, and it is not improbable that Hindus who are accustomed to keep up sacrifices which confer the benefit would be able to say whose sacrifice was most efficacious. When all the sapindas both on the father's and mother's side are exhausted, we then go to the sakulyas, and practically these are found by continuing the enumeration of agnates upon the same principle as that already indicated through three generations lower and three generations higher. On failure of the sakulyas we should have to fall back upon the samonadacas, but probably all that can be said with certainty is that the sakulyas and samonadacas between them exhaust entirely the male agnates of the deceased. Where there are several persons whose offerings are equally efficacious, *i.e.* who stand in the same relationship to the deceased, they all take: the male descendants *per stirpes*, and the other relatives of the deceased *per capita*.

These, then, are the rules which govern the ascertainment of the shares of the members of a family on a partition. Neither in a Mitachshara family nor in a Dayabhaga family have they any effect so long as the family remains joint: it is partition, and partition only, which brings them into play, and it is to this event rather than death that Hindu lawyers attach the greatest importance. Nevertheless all property in India is not joint property. Under the Mitachshara as well as under the Dayabhaga separate property may be acquired, and then, of course, we have true inheritance, for which the law must provide. So far as regards the Dayabhaga, the rules which govern the inheritance of separate property are (as we should expect) precisely the same as those which govern the inheritance of a share, and it is therefore unnecessary to restate them. But it remains to lay down the rules of inheritance for separate property under the Mitachshara law. They are not based by Mitachshara writers upon any religious principle, as under the Dayabhaga, yet the result is not widely different. First come the sons, then the sons' sons, and then the sons' sons' sons. Then the widow, whose right has been disputed, but was long ago established; then the daughters, and then the daughters' sons. After these come the parents, and it is peculiar that of these the mother comes before the father, then the father's sons and then the father's sons' sons. Then we go back to the preceding generation, and follow the same order—the father's mother, the father's father, the father's father's sons, the father's father's sons' sons. After this we go back another generation, and again follow the same order—father's father's mother, father's father's father, father's father's brother, father's father's brother's son. From this point the statements of Hindu lawyers as to the order of succession are very scanty and vague. One thing is certain, that under the Mitachshara law no cognates (relations through females) are admitted until all the agnates (relations through males) are exhausted.

So far we have considered intestate succession only, and the power of testamentary disposition is unknown to the true *widu*.

Hindu law. It was introduced by the decisions of the British courts of justice. By a will is meant a declaration by a man of his wishes as to the disposition of his property after his death, taking no effect during his life. A will is therefore by its very nature revocable. The general question whether a

Hindu could dispose of his property by will arose in Bengal when Hindus began to attempt to dispose of their property after their death according to the English method. At that time there was a doubt whether the father was so completely absolute that he could dispose of his property to the exclusion of his sons, even in his lifetime. As soon as it was settled that he could do so, it was assumed that he could also make a will. It seems never to have been asked why it was that up to this time no Hindu had ever made a will, or to question the radically false assumption that the power of alienation *inter vivos* and the power of testamentary alienation necessarily go together. A long series of decisions confirmed by the legislature has, however, established that a Hindu in modern times can dispose of any property of which he is the sole owner. In other words, a Hindu can dispose by will of his self-acquired property, and under the Dayabhaga a Hindu can dispose by will of his share in family property. But the courts which created the testamentary power have also limited it to disposition in favour of persons living at the time of the testator's decease, thus avoiding many of the fanciful dispositions of property to which testators in all countries are so prone. But, curiously enough, this restriction, salutary as it is, has also been based on the notion that a testamentary disposition is a gift from the testator to the object of his bounty.

In almost all countries at an early stage of civilization some legal provision exists by which debtors can be compelled by their creditors to pay their debts, and by which, **Debts.** if they fail to do so, their property can be seized and applied to this purpose. But the extent to which this can be done varies very considerably. So long as the family system exists in its primitive vigour it acts as a protection to the family property against the extravagance of a single member, and we often find that even when the family system has almost, or completely disappeared, there is an unwillingness to deprive the future representatives of the family of their land and houses. Doubts, too, have arisen as to whether the same right which a creditor has against his living debtor can be exercised after the debtor's death against those who have succeeded to his property. In India these two considerations have been deeply affected by a principle enunciated by Hindu lawyers (traces of which we find in many Eastern countries), that a man who dies in debt suffers cruel tortures in a future state, and that it is the imperative duty of his own immediate dependants to deliver him from these tortures by discharging his liabilities. Whether this should be looked upon as a legal, or only as a purely religious duty, might be questionable: the courts have seized upon it as a basis for laying down in the broadest manner the just rule that those who take the benefit of succession must take the burdens also. The subject is one which has caused a great deal of litigation in India, and whilst some points have been clearly settled, others are still being slowly worked out. As the matter stands at present, it may be safely said that all separate property is liable for the debts of the owner, both in his lifetime and after his death in the hands of his heirs. The same may be said of the share in the family property of the member of a Dayabhaga family, of which share he is the owner. So also the family property under both the Dayabhaga and Mitachshara is liable as a whole for the debts incurred on behalf of the family as a whole. As regards the question of the liability of the family property for the separate debts of the members of a Mitachshara family, the courts have held that the sons must pay their father's debts. Of course illegality would be an answer to the claims of the creditors against the heirs, just as it would be an answer to the claim against the original debtor; but there is some authority for saying that a debt contracted for an immoral though not an illegal purpose would not be enforced against the heir. According to modern decisions also, if judgment and execution on a separate debt are obtained against the member of a Mitachshara family, the share which would fall to him upon a partition may by process of law be set apart and sold for the benefit of the creditor.

The doctrine of what is called maintenance plays an important

part in the Hindu law, and, as we shall see, it modifies considerably the rigour of the Hindu law in excluding from the succession females or persons suffering from mental or bodily infirmity. The right of maintenance under the Hindu law is the right which certain persons have to be maintained out of property which is not their own. The persons who in certain circumstances have this right are sons, widows, parents and unmarried daughters and sisters. The claim of the widow arises at the death of her husband; of a child at the death of its parent, and so forth. The claim is not for a bare subsistence only, but to such a provision as is suitable to the claimant having regard to his or her position in life. Of course the sons are generally heirs, and an heir can have no claim to maintenance; but a son excluded by any mental or bodily defect would have a right to maintenance. The girls are generally married in infancy, and after marriage they have no claim to maintenance from their own family. The most frequent claim is by the widow; and it is a very important one, because she can sometimes, through the assertion of this claim, put herself almost in the position of an heir. If a Hindu under the Dayabhaga dies leaving sons and a widow, the widow is entitled to maintenance, and whilst the family remains joint she can claim to be suitably maintained, in the family if she remains in her husband's house, or out of it if she goes elsewhere. But if a partition takes place she is entitled to have a share equal to that of the sons set aside for her use. She can even, if she thinks that the sons do not treat her properly, apply to the court to compel the sons to give her a separate share. This, of course, gives her a very strong position. Whether in a Mitacsara joint family the widow enjoying maintenance can in any case claim a share on partition is doubtful.

In some respects, and as regards some kinds of property, the ownership of women under the Hindu law differs from that of men. These differences depend on the source from which the property is derived. If a woman has inherited property from a male, or as a gift by her husband, or has obtained it as a share on partition, she does not own it in the same way as a man would do; she obtains only a kind of restricted ownership. She has the full enjoyment and management of it, but she cannot sell it, or give it away, or dispose of it by will; and at her death it goes not to her heirs but to the heirs of the person from whom she obtained it; her ownership simply comes to an end. If she obtained it by inheritance from a male, it will go on her death to the heirs of that male; if as a share on partition it will be divided amongst the other sharers; if as a gift from her husband, to the heirs of the husband. As regards property otherwise obtained she is in the same position as any other owner, but the rules of inheritance applicable to it are somewhat peculiar. It would be a mistake to look upon the restricted ownership of a woman as what the English lawyers call a life estate. There is no such thing as a remainder or reversion. The whole estate is vested in her. If we endeavoured to describe the position of affairs at her death in the technical language of the English law of real property, it would be more correct to say that there was a shifting use. The restriction of alienation is sometimes removed where there is a danger that the property might otherwise be lost, as for example when the property is likely to be sold for non-payment of government revenue, in which case a portion may, if necessary, be sold by the woman so as to save the remainder. So also a woman who has no other means of maintaining herself, or of providing for the performance of religious duties which are incumbent upon her, may sell so much of the property as will produce the necessary funds. It would be difficult for a purchaser to know whether he would be safe in purchasing from a widow selling under necessity, and more difficult still to preserve evidence of the necessity in case the necessity were disputed. Of course the woman herself could not dispute the validity of the sales, but those who take after her might do so. Consequently it is not unusual to obtain the concurrence of the person who at the time of the purchase is entitled to succeed if the widow were dead, and

it has been held that if this person concurs in the sale, no one else can dispute it on the ground that it was unnecessary.

The subject of marriage is dealt with at considerable length in the Laws of Manu, and it is clear that, as originally conceived, marriage under the Hindu law consisted in nothing more than the mere possession of the woman, however obtained, by the man with the intention of making her his wife. Eight kinds of marriage are enumerated, and to each kind is assigned a separate name. The first four kinds are merely different forms of gift of the girl by her father to the husband. The other four kinds are—obtaining possession of a girl by purchase, fraud, ravishment or consent of the girl herself. But the simple gift of the girl by her father without any bargain or recompense was even then considered the most reputable form of marriage, and it is now the only one in common use amongst orthodox Hindus. The sale of the daughter was even in those early times stigmatized as disgraceful, but it was valid; and even now, if there were an actual transfer of the girl by the father, it is scarcely probable that the courts would inquire whether any inducement was given for the transfer. The transaction takes place entirely between the father of the girl and the future husband; the girl has nothing to do but to obey. If the girl has no father, then it will be the duty of her nearest male relatives to dispose of her in marriage. If, however, the girl is not married when she attains puberty (which is very rare), then she may choose a husband for herself. The father cannot dispose of his son in marriage as he can of his daughter, nor is anything said about his consent in the matter; though in the case of a very young boy there can be no doubt that the consent of one or both parents is obtained. The marriage of very young boys is very common, and is certainly valid.

The ceremonies which precede and accompany a marriage are very numerous. By far the most important is that which consists in the bridegroom taking the bride's hand and walking seven steps. Amongst Hindus generally the performance of this ceremony following upon a betrothal would be treated as conclusive evidence of a marriage, whilst the omission of it would, amongst orthodox Hindus, be almost conclusive that no marriage had yet taken place. But still any particular customs of the tribe or caste to which the parties belonged would always be considered, and it cannot be said that the completion or non-completion of this ceremony is universally conclusive as to the existence of a marriage. There may be communities of Hindus which require something more than this; there are certainly some which require something less, and others which require something altogether different. There are lower castes in some parts of India calling themselves Hindus in which the only ceremony accompanying a marriage is giving a feast to which the members of the two families are invited.

The marriage of Hindus is complete without consummation; and as girls are almost invariably married before the age of puberty, and sometimes long before, consummation is generally deferred, it may be, for several years. But all this time the parties are husband and wife, and if the husband dies the child becomes a widow. The condition of these child widows in India is certainly not an enviable one, for practically they can never hope to marry again. Whether the second marriage would be lawful was a disputed point in Hindu law until an act of the Indian Legislature (Act XV. of 1860) declared in favour of the opinion that the widow might remarry. But the social prejudice against remarriage is still very strong, and such a marriage rarely takes place. If the widow has inherited any property from her husband, she loses it by contracting a second marriage. There is no legal restraint upon the number of wives that a Hindu may marry, but polygamy is not practised so largely as is sometimes supposed.

Members of the three higher castes are forbidden to marry a woman of the same *gotra* as themselves. Literally a *gotra* means a cattle-yard, and the prohibition is considered to exclude marriage between all those who are descended from the same male ancestor through an uninterrupted line of males. This rule is said not to apply to Sudras. But there is another rule

**Maintenance.****Succession.****Widow's rights.****Property.****Marriage.****Child widows.****Consummation.****Remarriage.****Polygamy.****Gotra.****Female inheritance.****Partition.****Gift.****Intestacy.****Testamentary.****Will.****Executor.****Administrator.****Legatee.****Beneficiary.****Trust.****Agency.****Partnership.****Joint property.****Joint tenancy.****Co-ownership.****Joint debt.****Joint liability.****Joint action.****Joint defence.****Husband and wife.**

which applies to all Hindus, and prohibits the marriage of a man with a girl descended from his paternal or maternal ancestors within the sixth degree. The working out of the rule is a little peculiar, but the result is to give a rather wide rule of exclusion of both agnates and cognates. There is, however, this important exception to these rules of exclusion—that if a fit match cannot otherwise be procured, a man may marry a girl within the fifth degree on the father's side and the third on the mother's. Practically this reduces the limit of exclusion to that last stated, because no one but the parties themselves with whom the choice rested could say whether or no any other suitable wife was available to the husband.

A Hindu must also marry within his caste: a Brahmin must marry a Brahmin, a Rajput must marry a Rajput, and a Sudra must marry a Sudra. Whether there are any other representatives of the four original castes is very doubtful, and even the claim of the Rajputs to represent the military caste is disputed. Still the rule of prohibition is so far clear. But there are innumerable subdivisions of Hindus which are also called castes, and as a matter of fact these minor castes do not intermarry. How far such marriages would be lawful it is difficult to say. The matter is entirely one of custom. The ancient Hindu law furnishes no guide on the subject, because under the ancient law the intermarriages of persons of different castes, even the highest, though they were considered undesirable, were recognized as legal. Modern Hindus seem disposed to deny the validity of marriages between persons of different castes in either sense of the term.

Divorce, in the sense of a rupture of the marriage tie, is not known to the true Hindu law. But unchastity deprives a wife of all her rights except to a bare maintenance, and this without any legal proof. She cannot succeed her husband as his heir, and of course she cannot remarry. A little confusion has been caused by the fact that a Hindu husband sometimes goes through a private ceremony which is erroneously called a divorce. But this is only done in order more effectually to bar an unchaste wife from succeeding to his property. Some very low castes are, however, said to allow a husband to divorce his wife, and even to allow the divorced wife to marry again. The single case in which a Hindu marriage can be dissolved by a court of law is by a proceeding under Act XXI. of 1860, which was passed to meet the difficulties which arise when one of the parties to a Hindu marriage becomes a Christian. In this case, if the convert after deliberation during a prescribed time refuses to cohabit any longer with the other party, the court may declare the marriage tie to be dissolved, and a woman whose marriage has been thus dissolved is declared capable of marrying again.

An interesting chapter in the history of the modern development of Hindu law is that of the practice of what we call Suttee, though, properly speaking, the native term (*Sati*) denotes, not a practice, but a person, *i.e.* a faithful wife. The practice in question is that of the widow burning herself with her husband when his body is burned after his death. This, according to Hindu ideas, is a laudable act of devotion on the part of the widow, and when Great Britain first began to administer the law in India it was not uncommon. The newcomers had not as yet taken upon themselves the responsibility of altering the law, but of course British officers did what they could to discourage the practice, and especially to prevent any pressure being put upon the widow to perform the sacrifice. They could also take advantage of any circumstance which would render the case an improper one for the performance of the sacrifice, as, for example, that compulsion had been put upon the widow, or that the burning did not take place with the body of the husband. But if the proceedings were according to Hindu notions regular, it was contrary to the principles on which the governor-general then acted to interfere, and British officers had frequently to stand by, and, by not interfering, to give a sort of sanction to the sacrifice. When later the servants of the East India company began to assume a more direct responsibility for the government of the country, many suggestions were made for legislative interference. But, acting on the

salutary principle that it was unwise to interfere in any way with the religion of the people, the government abstained from doing so. In the meantime a considerable body of opinion against the practice had grown up amongst Hindus themselves, and at length the government thought it safe to interfere. By Regulation XVII. of 1829 widow-burning was declared to be a criminal offence. The measure produced no serious opposition. There was hardly a single prosecution under this Regulation; and from this time the practice of widow-burning has entirely disappeared from that part of India which is under British rule.

There are certain peculiarities in the relation of father and son in India which have given rise to the suggestion that there is no relationship between sonship and marriage, and that the notion of sonship in India is founded entirely on that of ownership—ownership of the mother and a consequent ownership of the child. But the arguments by which this view is supported do not appear to be sufficient. The rights of a father over his son, and of a husband over his wife are, it is true, so far like the rights of ownership that both are in the nature of rights *in rem*—that is, they are available against any person who infringes them; but it is contrary to established usage to speak of rights over a free person as rights of ownership, and no one is prepared to say that the wife or child are slaves of the father. There is no reason for abandoning in India the ordinary view, that sonship depends on marital cohabitation between the father and mother. There are undoubtedly in certain special and exceptional cases methods of acquiring sons otherwise than by marital cohabitation. But these contrivances can only be resorted to when there is no son by marriage, and the fiction which, as we shall see, is resorted to to conceal the true nature of these contrivances, would be entirely meaningless, as would most of the rules which regulate them, if sonship in general was based entirely on ownership. There were at one time more contrivances than there are now for supplying the want of male issue by marriage. At one time a son could be begotten for a man who was dead by cohabitation of his widow with a member of his family or perhaps even with a stranger. This is generally looked upon as a survival of polyandry. But this practice, though alluded to in the Laws of Manu as still subsisting, is now entirely obsolete. So there was a custom at one time by which a father could appoint a daughter to raise up male issue for him. The head of the family could also, if he had no son born in wedlock, accept as his own any child born in his house whose mother was not known or not married. So he could accept as his own the son of his wife born before marriage, or the son of his concubine. In the last three cases he may have been, and probably was, himself the father. But none of these contrivances for procuring a son is now in use. The only contrivance now employed for procuring a son, in the absence of one born in wedlock, is by taking into the family the son of another man who is willing to part with him. This is called adoption. There are two kinds of adopted sons: one called *dattaka* and the other *kritrima*. The former is in use all over India; the latter only in Mithila. The following rules apply to the *dattaka* born of adoption: A man can only adopt who is without issue capable of inheriting his property, of performing the funeral ceremonies for himself, and of making the necessary offerings to his ancestors. A woman cannot adopt. But by the authority of her husband, and acting on his behalf, she may select a son and receive him into the family. A man can adopt a son without his wife's assent; nevertheless, the son when adopted becomes the son of both parents.

Hindus consider it a grievous misfortune that the line of male descent should be broken. The due performance of the sacrificial offerings to the dead is thereby interrupted. Probably this explains the great latitude given in some parts of India to the widow to adopt a son on behalf of her husband in case he has died sonless. There is a text which says, "Nor let a woman give or accept a son unless with the assent of her lord." But the lawyers of western India do not consider that any express permission to adopt is necessary, and take it for granted that she

always has that permission. In Southern India, also, the widow may adopt without express permission, but the sapindas must give their sanction to make the adoption valid. Elsewhere the words have received their natural interpretation, namely, that the husband must in some way indicate his intention that his widow should have authority to adopt. The only person to whom an authority to adopt can be given is the wife or widow; and no widow can be compelled to exercise her power to adopt if she does not wish to do so. The father has absolute power to give away his son in adoption even without the consent of his wife. But her consent is generally asked and obtained before the son is given. After the father's death the widow may give a son in adoption. The rule which in former times rendered it necessary that the nearest male sapinda should be adopted is obsolete, and the adoption of a stranger is valid, although nearer relatives otherwise suitable are in existence. A man may adopt any child whose mother he could have married if she had been single; if he could not have done so, then he cannot adopt her child. The reason given in the text is that the adopted son must bear the resemblance of a son. This recalls the *dictum* of the Roman law—*adoptio naturam imitatur*. The adopted son and the adopting father must be of the same caste. The period fixed for adoption by the three higher castes is before the ceremony of upandayana, or investiture of the child with the thread which these castes always wear over the left shoulder. For Sudras, who have no thread, the period is prior to the marriage of the child. There has been much difference of opinion as to whether an only son can be given and received in adoption. It is now settled that the texts which discountenance this adoption do not constitute a prohibition which the law will enforce.

There is sometimes a difficulty in ascertaining whether or no an adoption has actually taken place. There must be a final giving and receiving of the child in adoption, and for Sudras nothing more is required. For the twice-born classes it is not finally settled whether any religious ceremony is actually necessary in order to render the adoption valid. But some religious ceremony in almost all cases accompanies the adoption, so that the absence of any such ceremony will always raise a suspicion that the adoption, though it may have been contemplated and some steps taken towards it, had not been finally completed. If an adoption were in itself invalid, no acquiescence and no lapse of time could make it valid—just as an invalid marriage could not be similarly validated. But acquiescence by the family would be strong evidence of the validity of an adoption, and the rules of limitation by barring any suit in which the question could be raised might render the adoption practically unassailable.

The *kritrima* adoption is altogether different; although the adopted son performs the ceremonies for his adopting father's family, and has a right to succeed, he is nevertheless not cut off from his own family. A person of any age may be adopted, and he must be old enough to be able to consent to the adoption, as without this consent it cannot take place. In this form a female can adopt, and no ceremonies are required.

**AUTHORITIES.**—HINDU LAW: J. D. Mayne, *Hindu Law* (London, 1892); Colebrooke's *Treatises on the Hindu Law of Inheritance* (Calcutta, 1810); Stokes's *Hindu Law Books* (Madras, 1865); West and Buhler, *A Digest of the Hindu Law of Inheritance* (Bombay, 1878); Jogendra Nath Bhattacharya, *A Commentary on Hindu Law* (Calcutta, 1894); Rajkumar Sarvadhikari, *Principles of the Hindu Law of Inheritance* (Calcutta, 1882); Gooroodass Banerjee, *The Hindu Law of Marriage and Stridhana* (Calcutta, 1896); Jogendra Chunder, *Principles of Hindu Law* (Calcutta, 1906).

5. *Mahomedan Law.*—The Mahomedan law is always spoken of by Mahomedans as a sacred law, and as contained in the Koran. But the Koran itself could not have supplied the wants even of the comparatively rude tribes to whom it was first addressed. Still less has it proved sufficient to satisfy the requirements of successive generations. No doubt the great veneration which Mahomedans have for the Koran has caused them to be less progressive than members of other religious creeds. But in human affairs some change is inevitable, and

the law of the Koran, like other sacred laws, has had to undergo the supplementary and transforming influence of custom and interpretation, though not of legislation. This direct method of changing the law by human agency, natural and simple as it appears to us, is scarcely acknowledged by Orientals even in the present day, except in the rare instances in which it has been forced upon them by Western authority. But besides custom and interpretation, another influence of a special kind has been brought to bear upon Mahomedan law. Besides those utterances which the Prophet himself announced as the inspired message of God, whatever he was supposed to have said and whatever he was supposed to have done have been relied upon as furnishing a rule for guidance. This tradition (*sunna*) is only to be accepted if it can be traced up to a narrator at first hand, though it would be rash to say that the chain of evidence is always very strong. Mahomedans also, in support of a legal rule for which there is no direct authority, resort to the argument from analogy (*kiyas*). The principle involved in a rule for which authority can be quoted is extended so as to cover other analogous cases. There have also been accepted amongst Mahomedans, as authoritative, certain opinions on points of law delivered by those who were actual companions of the Prophet; these opinions are spoken of collectively under the name of *ijma*. Some of these methods of extending and modifying the law have produced changes which it would be very difficult to reconcile with a strict adherence to the language of the Koran (see the Introduction to the *Corps de Droit Ottoman*, by George Young; Oxford, 1905). The Mahomedans of India generally are Sunnites of the Hanafite school. The two principal authorities on Mahomedan law to which recourse is had by the courts in India are the Hedaya and the Futwa Alumgiri. The Hedaya was translated into English by Mr Hamilton. The Futwa Alumgiri was compiled under the orders of the emperor Aurungzib Alumgiri. It is a collection of the opinions of learned Mahomedans on points of law. It has not been translated, but it forms the basis of the *Digest of Mahomedan Law* compiled by Neil Baillic. The Mahomedan law, like the Hindu law, is a personal law. It is essentially so in its nature. Persons of any other religion are to a large extent outside its pale. And in India, in civil matters, its application has been expressly limited to Mahomedans. At one time endeavour was made to administer the Mahomedan criminal law as the general territorial law of India, but it had constantly to be amended, and it was at length abolished and the penal code substituted. To be a Mahomedan, and so to claim to be governed by the Mahomedan law, it is necessary to profess the Mahomedan faith.

All that we find on the subject of intestate succession in the Koran are certain directions as to the shares which certain members of the family are to take in the estate of their deceased relative. So far as they go, these are <sup>intestate</sup> *succession* rules of distribution—that is to say, they depend, not on consanguinity only, but on certain equitable considerations, by which rules founded on consanguinity are modified. But these latter rules, though nowhere laid down in the Koran, still play a large part in Mahomedan law. There can be no doubt that they represent the pre-existing Arabian custom, which it was not the intention of the Prophet to displace, but only to modify. The claims under these rules take whatever is left after the specific shares assigned by the Koran to individual members of the family have been satisfied; if in any case there are no such shares, they take the whole. The Arabic term for this class of heirs is *asabah*, which literally means persons connected by a ligament. The term used by English writers is "residuary," but this description of them has the disadvantage that it entirely loses sight of the connexion on which the claim to succeed is based. They would be more correctly described as the "agnates" of the deceased, but the term "residuary" is too firmly established to be displaced. Those persons who take a share of the property, under the specific rules laid down in the Koran, we call "sharers," and this word has acquired a technical meaning; it is not used to describe those who can claim a portion of the

estate in any other way. It is hardly likely that females, or relatives through females, had any claim to the succession under any Arabian custom, nor, except so far as they are made sharers, are they recognized by the Koran as having a title to succeed. The proper description of this class of persons is *zawi-ul-arham*, i.e. "uterine kindred, and they have, in default of other heirs, established a claim to succeed. English writers have erroneously called them "distant kindred," but distance has nothing to do with the matter.

There is no right of primogeniture under Mahomedan law; there is a general preference of males over females, and if males and females take together as residuaries by an express provision of the Koran, each male takes as much as two females. Females are also expressly forbidden by the Koran to take more than two-thirds of the property; but in the application of these two rules the shares of the mother and the wife are not included. No person can claim to take any portion of the property who traces his relationship to the deceased through a living person, but this rule does not apply to brothers and sisters whose mother is alive. If several persons all stand in the same degree of relationship to the deceased, they take equally, *per caput* and not *per stirpem*.

It will now be convenient to state the rules for finding which of the agnates take as residuaries of the deceased. These are, in ordinary circumstances, the male agnates only, and the rule in question depends upon a classification of the male agnates which is common in other parts of the world. Every family consisting of several generations of male agnates may be broken up into groups, each of which has a separate common ancestor of its own. Thus, suppose A to be the person from whom the descent is to be traced. A belongs to a large group of persons, all of whom are males descended from a common ancestor D. But A and his or her own male descendants form a smaller group, which we may call the group A. This is the first class of male agnates of A. Then suppose A to be the son or daughter of B, excluding those who are descendants of A, and as such included in the first class, the remaining male descendants of B will form the second class of male agnates of A. In like manner we get a third class of male agnates of A who are descendants of C, excluding those who are descendants of A or B; and a fourth class of male agnates of A who are descendants of D, excluding those who are descendants of A, B, or C. This classification can obviously be carried through as many generations as we please. Mahomedan lawyers adopt this classification with only one difference. Between the first and second classes they interpose a class consisting entirely of the direct male ancestors, which they call the "root," so that the male descendants of A (the person whose heirs are in question) would be the first class of residuaries. B, C, D, &c., would be the second class of residuaries; the male descendants of B, other than the descendants of A, would be the third class of residuaries; the male descendants of C, other than the descendants of B and A, would be the fourth class of residuaries, and so on. In order to find the residuaries who are to succeed, we have only to take the classes in their order, and of the highest class which is represented to select the nearest to the deceased. If there are several who are equidistant, they will take equally *per caput*.

The sharers are, of course, those to whom a share is assigned by the Koran. They are (1) the father, (2) lineal male ancestors, whom Mahomedans call the "true grandfathers," (3) uterine half-brothers, i.e. the half-brothers by the mother, (4) daughters, (5) daughters of a son, or other direct male descendant, whom we call daughters of a son how low and soever, (6) the mother, (7) true grandmothers, i.e. female ancestors into whose line no male except a lineal male ancestor enters, (8) full sisters, (9) consanguine half-sisters, i.e. half-sisters by the father, (10) uterine half-sisters, (11) the husband, (12) the wives. The right to a share and the amount of it depends upon the state of the family. Under Mahomedan law not only, as elsewhere, the nearer relative excludes the more remote, but there are special rules of total or partial exclusion arising out of the equitable considerations upon which all rules of distribution are based.

These rules are best shown by taking the case of each member of the family in turn, and at the same time it will be useful to explain the general position of each member. First, the sons. They take no share, but they are first in the first class of residuaries, and their position is a very strong one; they exclude entirely sisters and daughters from a share, and they reduce considerably the shares of the husband, the widows, and the mother. The position of the other male descendants is very similar to that of the sons. They are not sharers; they are residuaries of the first class, and will take as such if the intermediate persons are dead. They reduce the shares of some of the sharers, but not to the same extent as the sons. The father is a residuary of the second class, and the first in that class. But he is also a sharer, and as such is entitled to a share of one-sixth. He can take in both capacities. The father's father is also a residuary of the second class, and he is a sharer, entitled to a share of one-sixth, but of course he cannot take either as sharer or residuary if the father is alive. The position of any true grandfather is analogous. An only daughter takes as sharer one-half of the property, two or more daughters take one-third between them. But sons exclude daughters from a share, and they would get nothing. Naturally this was considered unjust, and a remedy has been found by making the daughters what are called "residuaries in right of their brothers," each daughter taking half of what a son takes. The mother gets a share of one-sixth when there is a child of the deceased, or a child of any son how low and soever; also when there are two or more brothers or sisters. In any other case her share is one-third. If, however, the wife, or the husband (as the case may be), and the father are alive, the share of the mother is only one-third of what remains after deducting the share of the husband or the wife. The brother is never a sharer. He is a residuary of the third class, and he excludes some sharers. The daughters of a son how low and soever get a share of two-thirds between them if there are several; if there is only one she gets one-half. But the daughters of a son are excluded by any direct male descendant who is nearer to the deceased than themselves, or at the same distance from him. If, however, they are excluded by a person who is at the same distance from the deceased as themselves, Mahomedan lawyers again say that they come in as residuaries in right of that person, each female as usual taking half as much as each male. Of course the daughters of a son may also be excluded by the daughters having exhausted the two-thirds allotted to females. A single sister takes a share of one-half; several sisters take two-thirds between them. Sisters are excluded from a share by any residuary of the first class, and their own brothers also exclude them, but in the latter case they take as residuaries in right of their brothers, each sister taking half what a brother takes. So, again, the sisters may be excluded from a share by the daughters or daughters of sons having exhausted the two-thirds allotted to females, and the residue would go to the nearest male agnate—that is, the uncle or the nephew of the deceased, or some more distant relative. To prevent this Mahomedan lawyers say that in this case the sisters are residuaries, basing their assertion upon a somewhat vague tradition. The share of the husband in the property of the wife is one-fourth if there are surviving children, one-half if there are none. The share of the widow in the property of her deceased husband is one-eighth if there are surviving children, one-fourth if there are not. The nearest true grandmother takes a share of one-sixth. If there are several equidistant, they take one-sixth between them. The uterine half-brothers take a share of one-third when there is only one, but they are excluded by any direct descendant and by any direct male descendant. Uterine half-sisters are in the same position as uterine half-brothers. Consanguine half-brothers are residuaries of the same class as brothers, but only take in default of full brothers. Consanguine half-sisters take a share of two-thirds, or if there is only one she takes a share of one-half. But if there is a full sister also, the full sister takes one-half, and the consanguine sisters one-sixth between them. The consanguine half-sisters, like the full sisters, are excluded from a share by the children and the



father of the deceased, and also by full brothers and consanguine brothers; but in the last case they come in again as residuaries, taking half what a brother takes.

The sharers must of course, unless excluded, be all satisfied before anything is taken by the residuaries. But the sharers may not only exhaust the property; there may not be enough to satisfy all the claimants. Thus, if a man died leaving a wife, a mother and two daughters, the shares are one-fourth, one-sixth and two-thirds, and the sum of the shares being greater than unity, they cannot all be satisfied. The difficulty is met by decreasing the shares rateably, in other words, by increasing the common denominator of the fractions so as to produce unity; hence the process is called the "increase." The converse case arises when the shares of the sharers do not exhaust the property, but there are no residuaries to take what remains. It has been doubted whether the residue does not fall to the government as *bona vacantia*. But it is now settled that the surplus is to be divided rateably amongst the sharers in proportion to their shares. The process is called the "return." The husband and the wife are excluded from the benefit of the return. If there are no sharers, the whole estate will go to the residuaries. If there are neither sharers nor residuaries, it will go to the (so-called) distant kindred. Their claim is strong on equitable grounds, as some of them are very near relations; such, for example, as a daughter's children or a sister's children. Nevertheless their claim has been doubted, and it must be admitted that there is no very clear ground upon which it can be based. They are not mentioned as sharers in the Koran, and it is not very clear how, as cognates, they could have been recognized by any ancient Arabian custom. However, their claim is now well established, and, in default of both sharers and residuaries, they succeed on a plan somewhat resembling that on which male agnates are classified as residuaries. If all the claimants fall the property goes to the government, but there is one peculiar case. Supposing a man dies leaving a widow, or a woman dies leaving a husband, and no other relative. There is then a residue and no one whatever to take it, as the husband and wife are excluded from the return. Strictly speaking, it would fall to the government as *bona vacantia*, but the claim is never made, and would now be considered as obsolete, the husband or wife being allowed to take the property.

Under Mahomedan law there are certain grounds upon which a person who would otherwise succeed as heir to a deceased person would be disqualified. These grounds are—(1) that the claimant slew the deceased by an act which, under Mahomedan law, would entail expiation or retaliation, and this would include homicide by misadventure; (2) that the claimant is a slave; (3) that he is an infidel, i.e. not of the Mahomedan faith. The second impediment cannot now have any application in India; the third has been removed by Act 21 of 1850. There is a rule of Mahomedan law that if two persons die in circumstances which render it impossible to determine which died first, as, for example, if both went down in the same ship, for the purposes of succession it is to be assumed that both died simultaneously.

Mahomedan lawyers appear always to have recognized the validity of wills, and they are said to be recognized by the passage in the Koran. But the power of testamentary disposition is restricted within very narrow limits.

It only extends to one-third of the property after the payment of debts and funeral expenses. There is no hint of this restriction in the Koran, and it rests upon tradition. If the one-third has been exceeded the legacies must be reduced rateably. The heirs, however, by assenting to the legacies, may render them valid even though they exceed the prescribed amount. There is no restriction as to the form of making a will; it may be either oral or written. A legacy cannot be given to an heir. Mahomedan law contains some very simple and wise provisions for preventing the reckless and often unjust dispositions of property which persons are apt to make upon the approach of death. A man who is "sick," that is, who is suffering from illness which ends in death, can only give away

one-third of his property; and if he has also made a will containing legacies, the gifts and the legacies must be added together in the computation of the disposable one-third. So long as slaves had a money value, the value of the slaves liberated by a man on his deathbed was also included, which reminds us of the *Lex Furia Caninia* of the Roman law. Another transaction by which the restriction on the testamentary power might be eluded is that called *mohabat*. By this is meant a transaction in the form of a sale, but which, from the inadequacy of the price named, is obviously intended as a gift. If such a transaction is entered into during "sickness," the loss to the estate would have to be reckoned in computing the disposable one-third. But the *mohabat* transaction takes precedence of legacies. Another obvious mode of eluding the restriction on the testamentary power is the acknowledgment by a man on his deathbed of a fictitious debt; and it would seem that such acknowledgments ought to have been put under restriction. But Mahomedans, like other Orientals, have a useful, though possibly a superstitious, dread of leaving the debts of a deceased person unpaid, and it is this, no doubt, which has prevented their questioning the deathbed acknowledgment of a debt, even though there is every reason to believe it to be fictitious. All that has been done is to prescribe that debts of health should be paid before debts of sickness, and that debts cannot be acknowledged by a sick man in favour of an heir.

When a Mahomedan dies, the funeral expenses and the creditors must first be paid; then the legatees, then the claims of the sharers, and, lastly, those of the residuaries; or, if there are neither sharers nor residuaries, those of the (so-called) distant kindred. The administration of the estate need present no difficulties if there are no disputes, and if there is some one empowered to take possession of the property, to get in the debts, to satisfy the creditors, and distribute the assets amongst the various claimants; and such a person may be appointed by a Mahomedan in his will, who will perform these duties. He is called a *wasi*, and he is in a position very similar to an executor under English law. But if there is no *wasi*, even if there are no disputes, there may be a good deal of trouble. It would have been in accordance with the spirit of Mahomedan law, and with general principles of equity, if an officer of the courts established under British rule had been regularly empowered to take possession of the property, and to take such measures as were necessary to ensure all the claimants being satisfied in their proper order. But this view of their powers has not been taken by the courts in India; recently, however, they have been enabled by legislation to grant the power of administering the estate to a single person.

There is scarcely any part of Europe or Asia where the creation of fictitious relationships is altogether unknown. In many cases the object of the creation is simply to obtain an heir. This is the object of adoption amongst modern Hindus, and it is this, no doubt, which has led some persons to speak of Hindu adoption as a rudimentary will. But adoption, as such, has never obtained a footing in Mahomedan law. The fictitious relationships which that law recognizes are based upon a different idea. There was in early times a widespread notion that every man must belong to some family either as a freeman or a slave. The family to which a slave belongs is always that of his owner, and that of a freeman is generally indicated by his birth. But a liberated slave has no family, at least no recognized family; and as he cannot stand alone, it was necessary to attach him to some family. Now, just as in Roman law the freedman became a member of his master's family under the relationship of *patronus* and *cliens*, so in Mahomedan law a liberated slave becomes a member of the master's family under the relationship called *mawalat*. The object, of course, was to make the master's family liable for the consequences of the wrongful acts of the freed slave. As a compensation for the liability undertaken by the master's family, in default of residuaries of the slave's own blood (who can only be his own direct descendants), the master's family are entitled to succeed as what are called "residuaries for special

Admin-  
tration.

Fictitious  
relation-  
ships.

Testa-  
mentary  
suc-  
cess-  
sion.

cause." Of course the relationship of master and slave cannot now be created, and it is scarcely probable that any case of inheritance could arise in which it came into question. The relationship of *marwalat* may, under Mahomedan law, also be created in a case where a freeman is converted to Islam. From a Mahomedan point of view he then stands alone, and would be required to attach himself to some Mahomedan family. The form of the transaction exactly indicates the nature of it. The party wishing to attach himself says to the person ready to receive him, "Thou art my kinsman, and shalt be my successor after my death, paying for me any fine or ransom to which I may be liable." In this case also the family of the person who receives the convert is entitled, in default of other residuaries, to succeed to him as "residuaries for special cause." But this transaction can have no meaning under English law, which does not recognize the joint responsibility of the family, and it is therefore also obsolete. In the case of *marwalat* the rights of the persons concerned are not reciprocal. The person received gains no right of inheritance in the family into which he enters, and incurs no responsibility for their acts. An important part may still be played in Mahomedan law by the creation of relationships by acknowledgment. Any such relationship may be created, provided that the parentage of the person acknowledged is unknown; a person of known parentage cannot be acknowledged. The age, sex and condition of the person acknowledged must also be such that the relationship is not an impossible one; for, as was said in the Roman law, *factio naturam imitatur*. The relationship thus constituted is, in the case of a father, mother, child, or wife, complete, and must be treated for all purposes as having a real existence. But in any other case the acknowledgment, although good as between the parties thereto, has no effect upon the rights of other parties. The acknowledgment which we have just been considering contemplates the possibility at any rate, and in most cases the certainty, that the relationship is entirely fictitious, and has no connexion with any rule of evidence in whatever sense the term is understood. But there is a rule of Mahomedan law that, in cases where the paternity of a child is in dispute, the acknowledgment of the child by the father is conclusive. Whether this would now be maintained in face of the Evidence Act 1870, which deals with cases of conclusive evidence, and expressly repeals all previously existing rules of evidence, may be doubtful.

Marriage is a transaction based upon consent between a man and a woman, or between persons entitled to represent them. The result of the transaction is that certain family relationships involving legal rights and duties are created by the law, and these are not wholly under the control of the parties. But as to some of them, to some extent they may be regulated by agreement, and it is customary amongst Mahomedans at the time of a marriage to come to such an agreement. The only condition necessary to the constituting of a valid marriage between persons of full age is the consent of the parties. It is, however, the practice to conclude the transaction in the presence of two males, or one male and two female witnesses; and the omission of this formality would always throw a doubt upon the intention of the parties finally to conclude a marriage. It is even said that the absence of such witnesses would justify a judge in annulling the marriage. Minors of either sex may be given in marriage by their guardian, and the transaction will be irrevocable if the guardian be the father or any direct male ascendant. In any other case the marriage may be repudiated when the minor arrives at the age of puberty, but the repudiation is not effectual until confirmed by a judge of the civil court. A marriage may be conducted through agents. A woman can have only one husband; a man can have four wives; if he married a fifth the marriage would be annulled by a judge on the application of the woman. Mahomedans have a table of prohibited degrees within which parties cannot marry not very dissimilar to that in force in Great Britain. Nor can a man be married at the same time to two women nearly related to each other, as to two sisters. It is also considered that if a woman take a child to nurse she contracts

a sort of maternity towards it, and that if a boy and girl are nursed by the same woman they become brother and sister, and, in a general way, it is said "that whatever is prohibited in consanguinity is prohibited in fosterage"; but it is doubtful whether the law goes so far. The widow, or a divorced woman, is not allowed to marry again during her *iddat*. This is a period of chastity which a woman is bound to observe in order to avoid confusion of issue. If she is pregnant it lasts until the child is born; if not, then in case of divorce it lasts through three periods of menstruation; if she is a widow it lasts for four months and ten days. A Mahomedan man cannot marry an idolatress, but Jews and Christians are not thereby excluded, because, although infidels, they are not idolatresses. A woman is forbidden by Mahomedan law to marry any one who is not a Mahomedan; but if the marriage took place in conformity with the Act of 1872 it might be valid, if it amounted to a repudiation by the woman of her Mahomedanism. It is important to remember, when considering the validity of a Mahomedan marriage, that a distinction is drawn between marriages which are simply void (*batil*) and those which can only be annulled by judicial decision (*jarid*), for such a decision has no retrospective effect, so that the children already born are legitimate; and if no step is taken to obtain such a decision during the existence of the marriage, it cannot be questioned afterwards. What marriages are absolutely void, and what are only capable of being declared void, is not very clearly settled, but the evident leaning of Mahomedan law is against absolute invalidity, and there is strong authority for the opinion that no marriages are absolutely void except a marriage by a woman who has a husband living and such as are declared to be incestuous.

A Mahomedan has the absolute right to divorce his wife whenever he pleases without assigning any reason whatever for doing so. There are, however, very strong social reasons which have considerable influence in restraining the arbitrary exercise of the power. The power to divorce remains notwithstanding any formal promise by the husband not to exercise it, and it is even said that a divorce pronounced in a state of intoxication, or by a slip of the tongue, or under coercion, is valid. The divorce can, however, be revoked by the husband, but not after it has been three times pronounced, or after the *iddat* has been passed by the woman. Nor can the husband remarry his divorced wife unless she has been again married, and has been again divorced or become a widow, and the intermediate marriage must have been consummated. The power to divorce a wife may be entrusted by the husband to an agent acting on his behalf, and this contrivance is sometimes made use of to enable a woman's friends to rid her of her husband if he ill-treats her. The husband may even empower the wife to divorce herself. If the husband or the wife should happen to die whilst the divorce is still revocable, he or she will inherit; and even a triple repudiation pronounced during "sickness," that is death-sickness, will not deprive the woman of her inheritance if the *iddat* has not been passed. Of course there is nothing to prevent the husband and the wife from agreeing to a divorce, and to the terms on which it is to take place, and such an arrangement is very common. The treatment of the wife by the husband is not a ground upon which the marriage can be dissolved, but the impotence of the husband is a ground of dissolution. The courts in India consider that they have the power under Mahomedan law to grant a decree for the restitution of conjugal rights.

Dower in Mahomedan law is in the nature of a gift from the husband to the wife on the marriage, like the *donatio propter nuptias* of the Roman law, or the *morgengabe* of Teutonic nations. It may be either "prompt," that is, payable at once, or the payment of it may be deferred, or it may be partly the one and partly the other. The amount of the dower and the time of payment ought to be settled by agreement before the marriage takes place; if this is not done there is some trouble in ascertaining the rights of the parties. It seems clear that a woman is entitled as a matter of right to

what is called a "proper" dower. If the dower is payable at once the woman may, before consummation, refuse herself to her husband unless it is paid; whether she can do so after consummation is doubtful. If the husband capriciously repudiates the wife before consummation, or the wife before consummation repudiates the husband for his misconduct, then half the dower agreed on must be paid. If it is her misconduct which has caused the repudiation, she is not entitled to anything. Deferred dower becomes payable on the dissolution of the marriage either by death or by divorce. Probably a judge, when called upon to dissolve or annul a marriage, could make reasonable stipulations as to the dower. The dower is the wife's own property, and, as the wife is entirely independent of the husband in regard to her property, she can sue him or his representatives for the dower like any other creditor. Mahomedans generally before marriage enter into a formal contract which regulates not only the dower, but various other matters under the control of the parties, such as the visits the wife is to pay or receive, the amount of liberty which she is to have and so forth.

The right of pre-emption under Mahomedan law is the right of a third person, in certain circumstances, to step in and take the place of a buyer, at the same price and on the same conditions as the buyer has purchased.

**Pre-emption.** It applies only to the purchase of real property, and it can be exercised upon one of the three following grounds: (1) That the claimant is owner of property contiguous to that sold; (2) that he is a co-sharer in the property of which a share is being sold; (3) that he is a participator in some right over the property, such, for example, as a right of way over it. The claimant must announce his claim as soon as he hears of the sale, and he must follow up this announcement by a further claim in the presence of witnesses and of the seller, or, if possession has been transferred, of the buyer.

Mahomedan law, so far as it is administered by the courts of British India for Sunnites of the Hanafite school—that is, for the great bulk of Mahomedans—has attained a fair degree of precision, owing to the care bestowed on their decisions by the judges of those courts, and the assistance derived from Mahomedan lawyers. But much difficulty is experienced as soon as we come to deal with Mahomedans of any other description. No doubt in India any clearly-established custom prevalent amongst a well-defined body of persons would be recognized, or any rule of law founded upon texts which they accepted as authoritative. But it is not always easy to determine when these conditions have been satisfied. And to allow Mahomedans to set up a standard of rights and duties different from that of the bulk of their correligionists without this proof would lead not only to confusion but injustice. There is the further difficulty that Mahomedan law, as applied to any Mahomedans except those of the Hanafite school, has as yet been comparatively little studied by modern lawyers, so that

**Shiah System.** very little that is certain can be said about it. There is, however, a considerable body of Shiites in India whose legal system undoubtedly differs in some material particulars from that of the Sunnites. The Mahomedans of Oudh are generally Shiites, and Shiah families, mostly of Persian descent, are to be found in other parts of India. The following points seem clear. A marriage which the parties agree shall last for a fixed time, even for a few hours only, is a valid marriage, and at the expiration of the time agreed on the marriage ceases to exist. The relatives of the deceased, whether male or female, and whether tracing their connexion through males or females, may be sharers or residuaries. Both as sharers and residuaries the children can claim to take the place of their parents in the succession upon the principle of what we call representation. If there are parents or descendants of the deceased, and the sharers do not exhaust the property, the surplus is distributed amongst the sharers of that class in proportion to their shares. If the property is not sufficient to pay in full the shares of all the sharers, the shares do not abate rateably; e.g. as between daughters and the parents, or the

husband, or the wife of the deceased the whole deduction is made from the daughters' share.

**AUTHORITIES.**—(Mahomedan Law), Neil Baillie, *Digest of Mahomedan Law* (London, 1865); Sir R. K. Wilson, *Introduction to the Study of Mahomedan Law* (London, 1894); *Digest of Anglo-Mahomedan Law* (London, 1895); Charles Hamilton, *The Hedaya translated* (London, 1791); Syed Amer Ali, *Lectures on Mahomedan Law* (2 vols., Calcutta, 1891, 1894); Mahomed Yusuf, *Tagore Law Lectures* (Calcutta 1895); Alfred v. Kremer, *Culturgeschichte des Orients* (2 vols., Vienna, 1875). (W. M.A.)

**INDIAN MUTINY, THE.** the great revolt of the Bengal native army in 1857, which led to the transference of Indian government from the East India company to the crown in 1858. The mediate cause of the Mutiny was the great disproportion between the numbers of British and native troops in India, which gave the sepoys an exaggerated notion of their power; its immediate causes were a series of circumstances which promoted active discontent with British rule.

During the century which elapsed between the victory of Plassey and the outbreak at Meerut, the East India company relied mainly on native troops with a stiffening of British soldiers—especially artillery—for the successful conduct of its wars. The warlike Hindu and Mahomedan races supplied excellent fighting material, when led by British officers, and the sepoy army took a distinguished part in every Indian battle, from Assaye to Gujarat. At the close of Lord Dalhousie's administration (1856) British India was held by some 233,000 native and some 45,000 British troops—roughly a proportion of 5 to 1. It was already clear to some of the men who knew India best that this was a dangerous state of things, though when the Mutiny broke out the relative numbers were 257,000 native to 36,000 British soldiers. It had long been a fundamental principle of Indian government that the sepoy would always be true to his salt—knowing, as Macaulay wrote in 1840, that there was not another state in India which would not, in spite of the most solemn promises, leave him to die of hunger in a ditch as soon as he had ceased to be useful. But the history of the sepoy army might have shown that this was an over-estimate of its loyalty. As early as 1764 it was necessary to stamp out mutiny by blowing thirty sepoys away from guns. In 1806 the family of Tippee Sultan produced a dangerous mutiny at Vellore, which was nipped in the bud by the prompt action of Gillespie and his dragoons. In 1824 the 47th Bengal infantry refused to march when it was ordered for service in Burma, and after being decimated by British artillery was struck out of the army list. In 1844, after the disasters of the Afghan war had shaken the prestige of British arms in India, no less than seven native regiments broke into open mutiny over grievances both real and fancied; and this time the old stern measures were not adopted to stamp out military disobedience. Lord Ellenborough often said that a general mutiny of the native army was the only real danger with which the British empire in India was threatened, and his warning was solemnly repeated by Sir Charles Napier. A still more explicit warning was uttered by General Jacob, who declared in 1853 that the normal state of the Bengal army was a state of mutiny, and wrote to *The Times* as follows: "There is more danger to our Indian empire from the state of the Bengal army, from the feeling which there exists between the native and the European, and thence spreads throughout the length and breadth of the land, than from all other causes combined. Let government look to this; it is a serious and most important truth."

The causes which, in the middle of the 19th century, were thus tending to sap the long-tried fidelity of the sepoy army were partly military and partly racial. The professional conditions of the sepoy's career, especially in Bengal, were no longer so tempting as they had been in the first generations of the company's rule. The pay and privileges of the sepoy were steadily being diminished, and the increased demands made on the army by the great extension of the company's territory were by no means grateful to the average Bengal sepoy. Owing to the sildar system, under which the Indian sowlar provided his own horse and provender

**Disaffection in the Native Army.**

**Its causes in 1857.**

in return for a monthly wage, the Indian cavalry were almost to a man in debt, and therefore favoured any attempt to upset the existing régime, and with it to wipe out the moneylender and his books; and the general enlistment order passed in July 1856, for the purposes of the war in Persia, made the Hindu sepoy afraid of losing caste by crossing the sea.

The Indian government failed to take sufficient account of the social and religious feelings of their native soldiers, whilst a rigid insistence on the principle of seniority had greatly diminished the efficiency of the British regimental officers. Out of 73 mutinous regiments, only four colonels were found worthy of other commands. At the same time, there were deeper reasons for discontent with British rule, which specially affected the classes from which the Bengal sepoys were drawn. Chief among these was Dalhousie's policy of annexation, which brought under British dominion such small states as Satara, Nagpur and Jhansi, and finally the kingdom of Oudh. The insistence on the right of lapse, *i.e.* the refusal to allow an adopted son to inherit a native throne, and the threat of annexation on purely humanitarian grounds seriously alarmed the native princes of India, besides creating a class of malcontents, among whom the Nana Sahib, the adopted heir of the peshwa, made himself most infamous. The annexation of Oudh, which was the chief recruiting ground of the Bengal army, probably caused wider disaffection in the ranks of that army than any other act or omission of the government. There can also be little doubt that the social reforms of Lord Dalhousie and his predecessors had disturbed men's minds in Bengal. Thus the Brahmans were offended at the prohibition of suttee and female infanticide, the execution of Brahmans for capital offences, the re-marriage of widows, the spread of missionary effort and the extension of Western education. The Mahomedan zemindars were injured by the reassessment of the land revenue, which was carried through in the interests of the ryots, and the power of the zemindars was formidable, while that of the ryots was negligible; though it must be remembered that the peasantry as a whole gave no assistance to the mutineers. To all these causes must be added—not least important in dealing with orientals—the widespread feeling since the Afghan disaster that the star of the company was in the descendant, and that there was truth in the old prophecy that the British would rule in India for a bare century from Plassey (1757). Bazaar rumours of British reverses in the Crimea and in Persia increased the temptations for a general rising against the dominant race.

To this accumulation of inflammatory materials a spark was put in 1857 by an act of almost incredible folly on the part of the military authorities in India. The introduction of the Minié rifle, with its greased cartridges, was accompanied by no consideration of the religious prejudices of the Bengal sepoys, to whom, whether Hindus

or Mahomedans, the fat of cows and pigs was anathema. It was easy for agitators to persuade the sepoys that the new cartridges were greased with the fat of animals sacred to one creed or forbidden to another, and that the British government was thus engaged in a deep-laid plot for forcing them to become Christians by first making them outcasts from their own religions. The growth of missionary enterprise in India lent colour to this theory, which was supported by the fact that no precautions had been taken to grease the Indian cartridges with a neutral fat, such as that of sheep and goats. The researches of Mr G. W. Forrest in the Indian government records have shown that the sepoys' fears of defilement by biting the new cartridges had a considerable foundation in fact. At a court-martial in 1857 Colonel Abbott, inspector general of ordnance, gave evidence that "the tallow might or might not have contained the fat of cows." No attempt, in fact, had been made to exclude the fat of cows and pigs, and apparently no one had realized that a gross outrage was thus being perpetrated on the religious feelings of both Hindu and Mahomedan sepoys. The low-caste natives employed in the arsenals knew what grease was actually being employed, and taunted the Brahman sepoys

with the loss of caste that would follow their use of the new cartridges. Refusals to accept the suspected cartridges were soon heard in the Bengal army. The numerous agitators who had their own reasons for fomenting mutiny rose to the occasion, and in the first months of 1857 the greater part of the Bengal presidency was seething with sedition. At this time took place the mysterious distribution of chapatis, small cakes of unleavened bread, which had previously been known in connexion with the mutiny at Vellore (1806). "From village to village, from district to district, through hill-land and lowland, the signal—unexplained at the time, inexplicable still—sped; and in village after village, in district after district, the spreading of the signal was followed by the increased excitement of the people."

The first signs of the approaching trouble were displayed at the great military station of Barrackpur, 16 m. from Calcutta, in January 1857. The minds of the native regiments quartered there were maddened by rumours of the defilement which the new Minié cartridges would entail upon them, and incendiary fires broke out in the lines. The trouble was allayed by the tact of General Hearsey, who reported the incident to the Indian government on the 24th of January. A fortnight later he wrote, as the result of his inquiries, "We have at Barrackpur been dwelling upon a mine ready for explosion." At Berhampur, 100 m. to the north, on the 27th of February, the 19th Bengal infantry refused on parade to take their percussion caps, on the ground that to bite the new cartridges would defile them. The absence of any European troops made it impossible to deal with this act of mutiny on the spot. The defaulting regiment was marched down to Barrackpur for punishment. On the 20th of March, two days before its arrival, a sepoy named Manghal Pandi, from whom the mutineers afterwards came to be spoken of as "Pandies," drunk with bhang and enthusiasm, attempted to provoke a mutiny in the 34th Bengal infantry, and shot the adjutant, but Hearsey's personal courage suppressed the danger. Two days later the 19th were publicly disbanded, but no further punishment was attempted. This was partly due to Lord Canning's personal inclination to temper justice with mercy, but partly also to the fact that there was no adequate European force at hand to execute a severer sentence. Bengal had been recklessly depleted of white troops, and there was only one European regiment between Calcutta and Dinapur, a distance of 400 m. Canning sent at once for more British troops from Burma. Meantime new accounts of refusals to use even the old cartridges came from distant parts of Hindostan, from Umballa under the very eyes of Anson, the commander-in-chief, and from Lucknow, the capital of the newly annexed kingdom of Oudh. Lord Canning, the governor-general, who had at first hoped that he had only to deal with isolated cases of disaffection, at last recognized that the plague was epidemic, and that only stern measures could stay it. But before he could take the necessary steps, there reached Calcutta the news of the outbreak at Meerut and the capture of Delhi.

Meerut, 25 m. from Delhi, was an important military station, under the command of Colonel Archdale Wilson: the district was commanded by General Hewitt, one of the old and inefficient officers whom the rigid system of seniority had placed in so many high commands. At Meerut were quartered, besides one regiment of native cavalry and two of native infantry, a strong force of British troops, horse, foot and guns. Nevertheless, 85 men of the native cavalry regiment, driven to despair by the persistent rumours of the danger to their caste, refused on the 24th of April to accept their cartridges. For this offence they were condemned to ten years' imprisonment with hard labour on the roads, and on the 9th of May they were publicly stripped of their uniforms and marched off to gaol. The next day was a Sunday; and in the evening, whilst the British troops were parading for church, the native cavalry armed themselves, galloped to the gaol and released their comrades. Almost simultaneously the two infantry regiments shot down their officers and broke into open revolt. The badmashes, or criminal class, broke forth from their quarter and began to burn and

The greased cartridges.

The outbreak at Meerut.

plunder the dwellings of the British. A few of the mutineers took part in this work; but the great majority of them, fearing the vengeance of the British troops, hastened to move off, rather a mob than an army, upon the Delhi road. There is a general agreement that if a man like Gillespie or Nicholson had been in command of the station, the strong force at his disposal would have enabled him to strike such a deadly blow at the fleeing mutineers as might have stamped out the Mutiny. But Hewitt was too old and Wilson was lacking in initiative; the opportunity was lost, and no attempt was made to do more than clear the cantonments.

So many of the chief actors in the Mutiny on the native side carried their secrets into dishonoured graves that it is impossible to know exactly what schemes the household of the king of Delhi had concerted with the disaffected sepoy.

But when the mutineers reached Delhi they were at once joined by the city mob and the king's guards in proclaiming a revival of the Mogul empire. For a few hours the native troops of the British garrison awaited the turn of events; but when it became apparent that the British troops from Meerut were afraid to move, there was a general frame of revolt, and Delhi at once became the headquarters of the Mutiny. Most of the British officers and residents were massacred then or afterwards. The great magazine was gallantly defended for a time by nine Britons under Lieutenant Willoughby, and was blown up by them when all hope of relief had vanished. A young telegraph clerk sent the news to Umballa, continuing to signal until he was cut down at his post. Before the authorities in Calcutta and Lahore could take any steps to deal with the long-forecast danger, the whole of the North-West Provinces were in revolt. Fortunately the two men on whom the chief responsibility fell in this great crisis were equal to their task. Canning in Calcutta, John Lawrence in the Punjab, were men indeed equal to any burden; and the stress of the Mutiny, ending once and for ever the bad old system of seniority, brought to the front so many subordinates of dauntless gallantry and soldierly insight that a ring of steel was rapidly drawn round the vast territory affected. Lawrence saw that the surest way to prevent the Mutiny from spreading from the sepoy army of Bengal to the recently conquered fighting races of the Punjab was to hurl the Sikh at the Hindu; instead of taking measures for the defence of the Punjab, he acted on the old principle that the best defence is attack, and promptly organized a force for the reduction of Delhi, with the ardent co-operation of born leaders like John Nicholson, Neville Chamberlain and Herbert Edwardes. Anson, the commander-in-chief, died of cholera before he had had a chance to act on Lawrence's telegram, "Clubs, not spades, are trumps." He was succeeded by Sir Henry Barnard in command of the Delhi field force, then amounting to about 3000 British troops with 22 field guns, in addition to a few Gurkhas and Punjab native troops. The loyalty of the independent Sikh chiefs, headed by Patiala, and the stern measures which had been taken with the sepoy regiments enabled Lawrence to reinforce this little army with every available man and gun from the Punjab, in addition to Sikh and Pathan levies. It was to the insight of Lawrence and the splendid organization of the Punjab province—the spoilt child of the Indian government, as it had been called in allusion to the custom of sending thither the best of the Indian officials and soldiers—that the reduction of Delhi and the limitation of the outbreak were due. Meantime Canning was manfully playing his part at Calcutta. In the hour of danger he was undismayed, as in the hour of victory he was just and merciful. He telegraphed for reliefs from every available quarter, fortunately being able to divert the troops then on their way to China. The native armies of Bombay and Madras remained loyal, and the former in particular—thanks to Lord Elphinstone—furnished valuable reinforcements. Sir Colin Campbell, a veteran soldier whose laurels had been won in many battles from the Peninsula to the Crimea, was despatched from England to take command of the army in India. But even before he could arrive, the outspread of the Mutiny had already been checked by the gallantry

and skill of a mere handful of Britons and their faithful native allies.

Canning and Lawrence, at opposite ends of the disaffected districts, alike perceived that Delhi was the centre of peril, and that all other considerations must be subordinated to striking a decisive blow at that historic city. Both flung to the winds the European rules of warfare, which highly trained officers like Wilson had allowed to hamper their movements. "Make as short work as possible of the rebels," wrote Canning. "Where have we failed when we acted vigorously?" asked Lawrence. Though the nominal commanders of the army which captured Delhi were in turn Barnard, Reed and Wilson, the policy thus stated by Canning and Lawrence was really carried out by their subordinates—Baird Smith, Nicholson and Chamberlain. The Meerut troops, at last roused from their inaction, joined Barnard on the 7th of June, after a successful affair with the mutineers, and the next day the action of Badli-ki-Serai enabled the British force to occupy the famous Ridge, which they never abandoned till the final assault. At first the British troops, outnumbered by more than three to one by the mutinous regiments alone, were rather besieged than besiegers. Baird Smith indeed urged an immediate assault upon Delhi, on the ground that audacity is the best policy in Indian warfare; but it was not until the arrival of Nicholson on the 7th of August with the last Punjab reinforcements that the force was strong enough, in the opinion of its commander, to take offensive action. On the 14th of September, after three days of artillery preparation, the assault was delivered, under Nicholson's leadership. Two practicable breaches had been made by the siege guns, and a party of engineers under Home and Salkeld blew in the Kashmir gate. The assault was successful, in so far as a firm lodgment was made in the city, though the loss of Nicholson was a heavy price to pay for this success. Wilson actually thought of retreating; but Baird Smith and Chamberlain insisted on perseverance, and the city was captured after six days' hard fighting. The mutineers were completely cowed; the king of Delhi was taken and reserved for trial; and his sons were shot by Captain Hodson, after unconditional surrender, an act which has since been the theme of much reprobation, but which commended itself at the time to Hodson's comrades as wise and justifiable. The siege of Delhi, which was the turning-point of the Mutiny, had lasted for more than three months, during which thirty minor actions had been fought in the almost intolerable heat of the Indian midsummer.

The stern determination of the British troops, which alone made possible the reduction of Delhi with so inadequate a force, was intensified, if possible, by the ghastly story of Cawnpore. That important military station, lying on the Ganges on the confines of Oudh, was under the command of Sir Hugh Wheeler, an old but still efficient and experienced officer. It was garrisoned by about 3000 native troops, with a mere handful of white soldiers. When the news of the Meerut outbreak reached Wheeler, who had already noted many symptoms of disaffection in his own station, he was placed in a very difficult position. Under his care was a large body of non-combatants—women and children in great numbers among them. To occupy the one defensible position in the station, the magazine by the river with its vast military stores and its substantial masonry walls, would have involved steps which Wheeler regarded as certain to precipitate an outbreak. It was then thought that, if the sepoys mutinied, they would march off to Delhi, and Wheeler contented himself by throwing up a rude entrenchment round the hospital barracks, where he thought that the Europeans would be safe during the first tumult of a rising. All might have fallen out as he anticipated, had it not been that the Nana Sahib, the adopted heir of the late peshwa, was rajah of Bithur in the neighbourhood. This young Maharrata, since known to universal execration as the arch-villain of the Mutiny, was secretly burning with a sense of injury received from the Indian government. He was also ambitious; and when, on the 4th of June, the Cawnpore garrison

The Revolt of Delhi.

The Siege of Delhi.

The Massacre at Cawnpore.

broke into open mutiny, he prevailed on them to stay and help him to carve a new kingdom out of the company's territory, instead of throwing in their lot with the Delhi empire. From the 6th to the 27th of June the handful of British soldiers, who composed the garrison of a fortification that could not have resisted a serious assault for a single hour, held out with the greatest gallantry in hope of relief. When this hope had died away, they surrendered to the Nana on his solemn promise that all their lives should be spared and that they should have a safe conduct to Allahabad. The Nana, partly urged by his native cruelty, partly, no doubt, by the wish to commit his followers beyond all possibility of composition, massacred the entire garrison in the boats which should have taken it down the river, reserving only some two hundred women and children for a later death. These poor victims were confined in a house known as the Bibigarh. On the 15th of July, when Havelock's avenging army was within a march of Cawnpore, they were all hacked to death and their bodies—some still faintly breathing—were thrown down the adjacent well which is to-day one of the most famous monuments of British rule in India. No single act of the Mutiny elicited such a storm of fierce anger among the British, both those who were fighting in India and those who supported them at home; for none was a more terrible vengeance taken, though the Nana himself escaped from his pursuers.

Meanwhile Lucknow, the capital of Oudh, was the scene of a heroic defence. It was the headquarters of Sir Henry Lawrence, one of the most far-seeing of Indian statesmen, who was well aware of the mutinous state of the native army. On the 18th of April he warned

**The  
Defence of  
Lucknow.**

Lord Canning of some manifestations of discontent, and asked permission to transfer certain mutinous corps to another province. On the 1st of May the 7th Oudh infantry refused to bite the cartridge, but on the 3rd they were disbanded by other regiments. When the news of the outbreak at Meerut reached Lucknow, Sir Henry Lawrence recognized the gravity of the crisis and summoned from their homes two bodies of pensioners, one of sepoy and one of artillerymen, to whose loyalty, and to that of the Sikh sepoys, the successful defence of the residency was largely due. This position was immediately fortified. On the 30th of May the native troops broke into mutiny. On the 4th of June there was a mutiny at Sitapur, a large and important station 51 m. from Lucknow. This was followed by another at Fyzabad, one of the most important cities in the province, and outbreaks at Daryabad, Sultanpur and Salon. Thus in the course of ten days English authority in Oudh practically vanished. On the 30th of June Sir Henry Lawrence ordered a reconnaissance in force from Lucknow, which met the enemy at Chinhath; but the native sepoys and artillerymen turned traitors, and Sir Henry was forced to retreat to the residency, where the siege now began. The first attack was repulsed on the 1st of July, when the separate position of the Machchhi Bhawan was evacuated, and all the troops concentrated in the residency. The entrenchments surrounding this building covered some 60 acres of ground, and included a number of detached houses and buildings, knit together by ditches and stockades. In a military sense the position was indefensible. The garrison consisted of 1720 fighting men, of whom 712 were native troops, 153 civilian volunteers, and the remainder were British officers and men. This small force had to defend 1280 non-combatants. At the very beginning of the siege Sir Henry Lawrence was fatally wounded by a shell, and died on the 4th of July, thus depriving the defence of its guiding spirit. The command then developed upon General Inglis, who met the incessant attacks of the enemy with counter-services. On the 21st of July news was received that General Havelock was advancing, had defeated the Nana, and was master of Cawnpore; but it was still more than two months before even the first relief of Lucknow was achieved. During those two months every device was employed, by direct assault and by mining operations, to reduce the garrison, who held out nobly, meeting assault with sortie and mine with counter-mine. But the loyalty of the native troops began to waver

as the weeks dragged by and no sign of relief appeared. On the 23rd of September, however, the sound of distant guns in the direction of Cawnpore was heard, and on the 25th General Havelock's relieving force entered Lucknow. During the 87 days of the siege the strength of the garrison had diminished to 982, and many of these were sick and wounded. Against these were arrayed six thousand trained soldiers and a vast host of undisciplined rabble. For nearly three months their heavy guns and musketry had poured an unceasing fire into the residency entrenchment from a distance of only 50 yds. During the whole time the British flag flew defiantly on the roof of the residency. The history of the world's sieges contains no more brilliant episode.

On the 5th of June the troops at Benares mutinied, but were disbanded by Neill; and on the 6th of June the 6th native infantry at Allahabad mutinied and shot down their officers, but the fort was held until the arrival of Neill, who promptly restored order. On the 30th of June Sir Henry Havelock, who had been appointed to the command of the relieving column, arrived at Allahabad from Calcutta, and on the 7th of July he set out for the relief of Lucknow. His force consisted of some two thousand men all told, of whom three-quarters were British. On the 12th of July he fought the action of Fatehpur, and gained his first victory, though the irregular cavalry misbehaved and were subsequently disbanded. On the 15th the village of Aong was captured, and on the 16th the Nana's force was utterly shattered in the battle of Cawnpore. In nine days Havelock had marched 126 m. and fought three general actions under a broiling sun in the hottest season of the year; but the women and children whom it had been his object to save had already been massacred. Leaving Neill in command at Cawnpore, Havelock started out again on the 20th of July with ten light guns and 1500 men in the desperate attempt to relieve Lucknow, which was 53 m. away. On the 29th he gained two victories at Unao and Bushertunge, but considering himself too weak to advance, he fell back two marches upon Mangalwar. This decision was badly received by his troops, who were burning to avenge their countrywomen, and by General Neill, whom Havelock was obliged to reprimand for insubordination. Being slightly reinforced, he advanced on the 5th of August, and again turned the enemy out of Bushertunge, but was again obliged by cholera to retreat to Mangalwar; and on receipt of news from Neill that the enemy were assembling at Bithur, he returned to Cawnpore, and abandoned for the time the attempt to relieve Lucknow. On the 16th of August he defeated the mutineers at Bithur. At this point General Havelock was joined by Sir James Outram, who would have superseded him in the command had not Outram himself, with unequalled generosity, proposed to accompany Havelock only in his civil capacity as chief commissioner of Oudh and to serve under him as a volunteer. On the 21st of September Havelock started on his second attempt to relieve Lucknow, and won the victory of Mangalwar. On the 23rd another victory was gained at Alam Bagh, and news reached the force of the fall of Delhi. From Alam Bagh there were four possible routes of advance to the residency, and Outram considered that the route chosen by Havelock, lying through the streets of Lucknow, involved unnecessary losses to the troops. Neill was killed in the streets, and the little force lost in all 535 officers and men; but on the 26th of September it entered the residency, and the first relief of Lucknow was accomplished.

But the two thousand men who had thus entered the residency entrenchment under Havelock and Outram, though sufficient to reinforce the garrison and save it from destruction, were not strong enough to cut their way back to safety, hampered with the women and children and wounded, amounting to 1500 souls, and the siege now recommenced upon a larger scale. Havelock's task, however, was accomplished, and Outram now took command of the residency. A detachment had been left in the Alam Bagh, which was short of provisions; some attempts were made to open up communication with it, but without success. Subsequently it was

**First  
Relief of  
Lucknow.**

**Second  
Relief of  
Lucknow.**

reinforced from Cawnpore. Upon the fall of Delhi the troops before that city were freed for the operations in Oudh, and on the 24th of September a column of 2700 men under Colonel Greathed left Delhi. On the 29th a successful action was fought at Bulandshahr, and on the 10th of October the column reached Agra. Here they were surprised by the enemy, but drove them off with considerable loss. On the 14th of October the column left Agra under Colonel Hope Grant, and on the 26th reached Cawnpore, where news was received that the commander-in-chief was coming to take command of the operations. Sir Colin Campbell had been sent out from England to suppress the Mutiny, and had assumed command of the Indian army on the 17th of August, but could not immediately proceed to the front. It was his first task to reorganize the administrative and transport departments; only on the 27th of October did he leave Calcutta. On the 3rd of November he reached Cawnpore, and on the 12th marched upon Lucknow under the guidance of Thomas Henry Kavanagh, who had made his way from the residency disguised as a native for that purpose. Campbell had with him 4500 men with whom to raise a siege maintained by 60,000 trained soldiers occupying strong positions. On the 12th of November the force reached the Alam Bagh, and on the 14th advanced upon Lucknow, proceeding on this occasion across the open plain by the Dilkusha and Martinière instead of through the narrow and tortuous streets of Lucknow. On the 16th the Sikandra Bagh was stormed; on the following day Campbell joined hands with Outram and Havelock, and the relief of Lucknow was finally accomplished.

Sir Colin Campbell now decided to withdraw the garrison and women and children from the residency, and to hold Lucknow by a strong division operating outside the city. The residency was evacuated on the night of the 22nd of November; but the success of the operations was marred by the death of Havelock. On his return to Cawnpore Campbell found that General Windham was being attacked at that place by the Gwalior contingent. On the 6th of December he defeated the Gwalior contingent in the battle of Cawnpore, though he had only 5000 men against the enemy's 25,000. His next task was to clear his line of communications with Delhi and the Punjab, and this he accordingly undertook. Lord Canning now decided that the next step should be the reduction of Lucknow, on the ground that it, like Delhi, was a rallying point of the Mutiny, and that its continuance in the hands of the enemy would mean a loss of prestige. General Franks' column advanced to Lucknow from the eastern frontier of Oudh, defeating the enemy in four actions. Meanwhile Outram had held his own at the Alam Bagh for over three months with only 4000 men against 120,000 rebels. An offer of help from Nepal had been accepted in July, and now Jung Bahadur, the prime minister of Nepal, was advancing with 10,000 Gurkhas to aid in the operations against Lucknow; but the lateness of his arrival delayed the opening of the siege until the 2d of March 1858. The Martinière was captured on the 9th of March and the Begum Kothi on the 11th. On the 14th the Imambara was stormed, and the Kaisar Bagh, and on the 16th the residency was once more in British possession. The enemy were thoroughly routed, but Campbell lost the opportunity of pushing the victory home by forbidding Outram to cross the bridge in pursuit if he thought he would lose a "single man," and by sending the cavalry away from the environs of the city at the critical moment. Upon the fall of Lucknow Lord Canning's Oudh proclamation was issued, confiscating almost the entire lands of the province, and ensuring only their lives to those rebels who should submit at once. Outram considered the terms of this proclamation dangerously severe, and Lord Ellenborough, president of the board of control, thus criticized it in a hasty despatch, the publication of which necessitated his own resignation. It was afterwards acknowledged that the Oudh proclamation, interpreted as Canning meant it should be, was a wise piece of statesmanship. After the fall of Lucknow Canning insisted that Sir Colin Campbell should take immediate action against the rebels in Oudh and Rohilkhand, and a number of petty and harassing

operations were carried out by detached columns; but Campbell moved too slowly to bring his guerrilla opponents to book, and the rebellion was really brought to a conclusion by Sir Hugh Rose's brilliant campaign in Central India.

Though the two great princes of Central India, Sindhia and Holkar, wisely and fortunately remained true to the British, troops belonging to both of them joined the mutineers. **The Central India Campaign.** The Gwalior contingent of Sindhia's army mutinied in the middle of June, and on the 1st of July Holkar's troops revolted at Indore, and the resident, Henry Durand, was forced to leave the residency. The rani of Jhansi also rose in rebellion, to become known as "the best man upon the side of the enemy." The rising in this quarter received little attention until January 1858, when Sir Hugh Rose was given the command of two brigades, to act in concert with Sir Colin Campbell, and he immediately began a campaign which for celebrity and effectiveness has rarely been equalled in India. His principle was to go straight for the enemy wherever he found him, and pursue him until he had exterminated him. He was hampered by none of that exaggerated respect for the rebels which earned Sir Colin Campbell the nickname of Old Khabardhar (Old Take-Care); but carried to an extreme the policy of audacity. Advancing from Bombay Sir Hugh Rose relieved Saugor on the 3rd of February, after it had been invested by the rebels for upwards of seven months. On the 3rd of March he forced the pass of Madanpur, and took the whole of the enemy's defences in rear, throwing them into panic. On the 21st he began the siege of Jhansi, the stronghold of the mutineers in Central India, with a garrison of 17,000 men. During the course of the siege Tantia Topi, the most capable native leader of the Mutiny, arrived with a fresh force of 20,000 men, and threatened the British camp; but Sir Hugh Rose, with a boldness which only success could justify, divided his force, and while still maintaining the siege of the fort, attacked Tantia Topi with only 1500 men and completely routed him. This victory was won on the 1st of April, and two days later Sir Hugh carried Jhansi by assault. On the 1st of May the battle of Kunch was fought and won in a temperature of 110° in the shade, many of the combatants on both sides being struck down by heat apoplexy. On the 22nd of May the battle of Kalpi was won, though the European troops were hampered by defective ammunition and Sir Hugh himself here received his fifth sunstroke. In five months he had beaten the enemy in thirteen general actions and sieges, and had captured some of the strongest forts in India. News now arrived that the rebel army under Tantia Topi and the rani of Jhansi had attacked Sindhia, whose troops had gone over to the rebels and delivered Gwalior into their hands. Sir Hugh marched against Gwalior at once, captured the Morar cantonments on the 16th of June, and carried the whole of the Gwalior positions by assault on the 19th, thus restoring his state to Sindhia within ten days of taking the field. This was the crowning stroke of the Central India campaign, and practically put an end to the Mutiny, though the work of stamping out its embers went on for many months, and was only completed with the capture and execution of Tantia Topi in April 1859.

The Indian Mutiny was in no sense a national rising. The great mass of the people in the affected districts either stood neutral, waiting with the immemorial patience of the East to accept the yoke of the conqueror, or helped the British troops with food and service, in many cases also sheltering British fugitives to the best of their ability. The attempt to throw off the British yoke was confined to a few disaffected ex-rulers and their heirs, with their numerous clansmen and hangers-on, besides the badmashes and highway-men who saw their way to profit by the removal of the British administration under which their peculiar talents found no safe outlet. The Bengal native army was their tool, which circumstances put into their hands at the psychological moment when British power seemed to be at its lowest point. But the fighting races of the Punjab saw no reason for casting in their lot with the mutineers, and the great majority of the independent princes who had nothing of which to complain, like Patiala in the Punjab,

Capture  
of  
Lucknow.

Not a  
national  
rising.

Holkar and Sindhia in central India, preserved a loyal or at least an interested friendship. The Sikhs showed their appreciation of Lawrence's admirable administration by keeping faith with their recent conquerors, and the Gurkhas of Nepal did yeoman service for their fathers' enemies. The lack of any central principle or common interest was shown in the divided counsels and sporadic action of the mutineers and their allies, which made them an easy prey to the solid and audacious British forces.

The chief result of the Indian Mutiny was to end the government of India by the East India company. It was felt that a system of administration which could permit such a catastrophe was no longer desirable. On the 2nd of August 1858 the queen signed the act which transferred the government of India to the crown. On the 1st of November Lord Canning, now viceroy of India, published the noble proclamation in which the change was announced, and a full amnesty was offered to all the rebels who had not been leaders in the revolt or were not guilty of the murder of British subjects. Even before the fall of Delhi, Canning had been adversely criticized—"Clemency Canning" he was scornfully called—for announcing his intention to discriminate between the guilt of various classes of mutineers. But a wiser view soon prevailed, and the natives of India at large gratefully accepted the queen's proclamation as the charter of their lives and liberties.

See G. W. Forrest, *History of the Indian Mutiny* (1904), and *Selections from State Papers* (1897); T. R. E. Holmes, *History of the Indian Mutiny* (1898); Kaye and Mallison's *History of the Indian Mutiny* (1864-1888); R. S. Rait, *Life of Lord Gough* (1903); Sir W. Lee-Warner, *Life of Lord Dalhousie* (1904); Sir H. Cunningham, *Lord Canning* ("Kulers of India" series), (1890); Sir Owen Tudor Burne, *Clyde and Strathnairn* (1895); Lord Roberts, *Forty-one Years in India* (1898); and Sir Evelyn Wood's articles in *The Times* in the autumn of 1907.

**INDIAN OCEAN**, the ocean bounded N. by India and Persia; W. by Arabia and Africa, and the meridian passing southwards from Cape Agulhas; and E. by Farther India, the Sunda Islands, West and South Australia, and the meridian passing through South Cape in Tasmania. As in the case of the Atlantic and Pacific Oceans, the southern boundary is taken at either 40° S., the line of separation from the great Southern Ocean, or, if the belt of this ocean between the two meridians named be included, at the Antarctic Circle. It attains its greatest breadth, more than 6000 m. between the south points of Africa and Australia, and becomes steadily narrower towards the north, until it is divided by the Indian peninsula into two arms, the Arabian Sea on the west and the Bay of Bengal on the east. Both branches meet the coast of Asia almost exactly on the Tropic of Cancer, but the Arabian Sea communicates with the Red Sea and the Persian Gulf by the Straits of Bab-el-Mandeb and Ormuz respectively. Both of these, again, extend in a north-westerly direction to 30° N. Murray gives the total area, reckoning to 40° S. and including the Red Sea and Persian Gulf, as 17,320,550 English square miles, equivalent to 13,042,000 geographical square miles. Karstens gives the area as 48,182,413 square kilometres, or 14,001,000 geographical square miles; of these 10,842,000 square kilometres, or 3,150,000 geographical square miles, about 22% of the whole, lie north of the equator. For the area from 40° S. to the Antarctic Circle, Murray gives 9,372,600 English square miles, equivalent to 7,057,568 geographical square miles, and Karstens 24,718,000 square kilometres, equivalent to 7,182,474 geographical square miles. The Indian Ocean receives few large rivers, the chief being the Zambezi, the Sbat-el-Arab, the Indus, the Ganges, the Brahmaputra and the Irawadi. Murray estimates the total land area draining to the Indian Ocean at 5,050,000 geographical square miles, almost the same as that draining to the Pacific. The annual rainfall draining from this area is estimated at 4380 cubic miles.

**Relief.**—Large portions of the bed still remain unexplored, but a fair knowledge of its general form has been gained from the soundings of H.M.S. "Challenger," the German "Gazelle" Expedition, and various cable ships, and in 1898 information was greatly added to by the German "Valdivia" Expedition. A ridge, less than 2000 fathoms from the surface, extends south-eastwards from the Cape. This ridge, on which the Crozet Islands and Kerguelen are situated, is directly connected with the submarine plateau of the Antarctic.

From its depth increases north-eastwards, and the greatest depression is found in the angle between Australia and the Sunda Islands, where "Wharton deep," below the 3000-fathom line, covers an area of nearly 50,000 sq. m. Immediately to the north of Wharton deep is the smaller "Maclear deep," and the long narrow

Jeffreys deep off the south of Australia completes the list of depressions below 3000 fathoms in the Indian Ocean. The 2000-fathom line approaches close to the coast east of (1) in the Bay of Bengal, which it does not enter; (2) to the south-west of India along a ridge on which are the Laccadive and Maldivé Islands; and (3) in the Mozambique Channel, and on a bank north and east of Madagascar, on which are the Seychelles, Mascarene Islands and other groups.

**Islands.**—Like the Pacific, the Indian Ocean contains more islands in the western than in the eastern half. Towards the centre, the Maldivé, Chagos and Cocos groups are of characteristic coral formation, and coral reefs occur on most parts of the tropical coasts. There are many volcanic islands, as Mauritius, the Crozet Islands, and St. Paul's. The chief continental islands are Madagascar, Sokotra and Ceylon. Kerguelen, a desolate and uninhabited island near the centre of the Indian Ocean at its southern border, is noteworthy as providing a base station for Antarctic exploration.

**Deposits.**—The bottom of the Bay of Bengal, of the northern part of the Arabian Sea, of the Red Sea and the Persian Gulf, and of the narrow coastal strips on the east and west sides of the ocean, are chiefly covered by blue and green muds. Off the African coasts there are large deposits of Glauconitic sands and muds at depths down to 1000 fathoms, and on banks where coral formation occurs there are large deposits of coral muds and sands. In the deeper parts the bed of the ocean is covered on the west and south by Globigerina ooze except for an elongated patch of red clay extending most of the distance from Sokotra to the Maldivés. The red clay covers a nearly square area in the eastern part of the basin bounded on two sides by the Sunda Islands and the west coast of Australia, as well as two strips extending east and west from the southern margin of the square along the south of Australia and nearly to Madagascar. In the northern portion of the square, north and east of Wharton deep, the red clay is replaced over a large tract by Radiolarian ooze.

**Temperature.**—The mean temperature of the surface water is over 80° F. in all parts north of 13° S., except in the north-west of the Arabian Sea, where it is somewhat lower. South of 13° S. temperature falls uniformly and quickly to the Southern sea. Between the depths of 100 and 1000 fathoms temperature is high in the north-west, and in the south centre and south-west, and low in the north-east, the type of distribution remaining substantially the same. At 1500 fathoms temperature has become very uniform, ranging between 35° and 37° F., but still exhibiting the same type of distribution, though in a very degenerate form.

**Salinity.**—The saltiest surface water is found in (a) the Arabian Sea and (b) along a belt extending from West Australia to South Africa, the highest salinity in this belt occurring at the Australian end. South of the belt salinity falls quickly as latitude increases, while to the north of it, in the monsoon region, the surface water is very fresh off the African coast and to the north-east. Little is known with certainty about the distribution of salinity in the depth, the number of trustworthy observations available being still very small. Probably the northern and north-eastern region, within the monsoon area, contains relatively fresh water down to very considerable depths.

**Circulation.**—The north of the equator the surface circulation is under the control of the monsoons, and changes with them, the currents consisting chiefly of north-east and south-west drifts in the open sea, and induced streams following the coasts. During the northern summer the south-west monsoon, which is sufficiently strong to bring navigation practically to a standstill except for powerful steamers, sets up a strong north-easterly drift in the Arabian Sea, and the water removed from the east African coast is replaced by the upwelling of cold water from below; this is one of the best illustrations of this action extant. Along the line of the equator the Indian counter-current flows eastwards all the year round, acting as compensation to the great Equatorial current flowing westwards between the parallels of 7° and 20° S. The equatorial current, on meeting the northern extremity of Madagascar, sends a branch southwards along the east coast of that island, sometimes called the Mascarene current. When the main equatorial current reaches the African coast a minor stream is sent northwards to the source of the Indian counter-current, but the discharge is chiefly by the Mozambique current, which south of Cape Corrientes becomes the Agulhas current, one of the most powerful stream currents of the globe.

On the west coast of Madagascar and on the banks of the Arabian coast south of 30° S. return currents or "back-drifts" move in the opposite direction along the flanks of the Agulhas current; these back-drifts are of great importance to navigation. On clearing the land south of the Cape the waters of the Agulhas current meet those of the west wind drift of the Southern Ocean, and mingle with them in such a manner as to produce, by interdigitation, alternate strips of warm and cold water, which are met with at great distances south-west and south



of the Cape. Between South Africa and Australia the waters form a part of the great west wind drift. The waters of this drift are, in general, of very low temperature, but it is remarkable that the interdigitation just mentioned continues far to the eastward, at least as far as Kerguelen. This fact is probably due partly to the actual intrusion of warm water from the Mascarene current east of Madagascar, and partly to the circumstance that the different temperatures of the waters are so compensated by their differences of salinity that they have almost precisely the same specific gravity *in situ*. The west wind drift sends a stream northwards along the west coast of Australia, the *West Australia current*, the homologue of the Benguela current in the South Atlantic. The principal feature in the circulation in the depths of the Indian Ocean is a slow movement of Antarctic water northwards along the bottom to take the place of that removed from the surface by evaporation, and by currents in the lower latitudes. Little is known beyond the bare fact that such movement does take place. (H. N. D.)

**INDIANOLA**, a city and the county-seat of Warren county, Iowa, U.S.A., about 18 m. S. by E. of Des Moines. Pop. (1890) 2254; (1900) 3261; (1909) 3396; (1910) 3283. It is served by the Chicago, Burlington & Quincy and the Chicago, Rock Island & Pacific railways. Indianola is the seat of Simpson College (coeducational, Methodist Episcopal, 1867), with a college of liberal arts, an academy, a school of education, a school of business, a school of shorthand and typewriting, a conservatory of music, a school of oratory, a school of art and a military academy. In 1908 the college had 32 instructors and 905 students. The city lies in a rich farming region, and has a considerable trade in butter and eggs, vegetables and fruits, and in coal, lumber and live stock from the surrounding country. Indianola was laid out and was selected as the county-seat in 1849, and building began in the following year; it was incorporated as a town in 1864, and was chartered as a city of the second class in 1884.

**INDIANS, NORTH AMERICAN.** The name of "American Indians" for the aborigines of America had its origin in the use by Columbus, in a letter (February 1493) written soon after the discovery of the New World, of the term *Indios* (i.e. natives of India) for the hitherto unknown human beings, some of whom he brought back to Europe with him. He believed, as did the people of his age in general, that the islands which he had discovered by sailing westward across the Atlantic were actually a part of India, a mistaken idea which later served to suggest many absurd theories of the origin of the aborigines, their customs, languages, culture, &c. From Spanish the word, with its incorrect connotation, passed into French (*Indien*), Italian and Portuguese (*Indio*), German (*Indianer*), Dutch (*Indiane*), &c. When the New World came to be known as *America*, the natives received, in English especially, the name "American Indians," to distinguish them from the "Indians" of south-eastern Asia and the East Indies. The appellation "Americans" was for a long time used in English to designate, not the European colonists, but the aborigines, and when, in 1891, Dr D. G. Brinton published his notable monograph on the Indians he entitled it *The American Race*, recalling the early employment of the term. The awkwardness of such a term as "American Indian," both historically and linguistically, led Major J. W. Powell, the founder of the Bureau of American Ethnology, to put forward as a substitute "Amerind," an arbitrary curtailment which had the advantage of lending itself easily to form words necessary and useful in ethnological writings, e.g. pre-Amerind, post-Amerind, pseudo-Amerind, Amerindish, Amerindian, &c. Purists have objected strenuously to "Amerind," but the word already has a certain vogue in both English and French. Indeed, Professor A. H. Keane does not hesitate, in *The World's Peoples* (London, 1908), to use "Amerinds" in lieu of "American Indians." Other popular terms for the American Indians, which have more or less currency, are "Red race," "Red men," "Redskins," the last not in such good repute as the corresponding German *Rothhäute*, or French *Peaux-rouges*, which have scientific standing. The term "American Indians" covers all the aborigines of the New World past and present, so far as is known, although some European writers, especially in France, still seek to separate

from the "Redskins" the Aztecs, Mayas, Peruvians, &c., and some American authorities would (anatomically at least) rank the Eskimo as distinct from the Indian proper. When the name "Indian" came to be used by the European colonists and their descendants, they did not confine it to "wild men," but applied it to many things that were wild, strange, non-European in the new environment (see *Journ. Amer. Folk-Lore*, 1902, pp. 107-116; *Handbook of Amer. Inds.*, 1907, pt. i. pp. 605-607). Thus more than one hundred popular names of plants in use in American English (e.g. "Indian corn," "Indian pink," &c.) contain references to the Indian in this way; also many other things, such as "Indian file," "Indian ladder," "Indian gift," "Indian pudding," "Indian summer." The Canadian-French, who termed the Indian *savage* (i.e. "savage"), remembered him linguistically in *botte sauvage* (moccasin), *traîne sauvage* (toboggan). The term "Siwash," in use in the Chinook jargon of the North Pacific coast, and also in the English of that region, for "Indian" is merely a corruption of this Canadian-French appellation. In the literature relating to the Pacific coast there is mention even of "Siwash Indians." Throughout Canada and the United States the term "Indian" occurs in hundreds of place-names of all sorts ("Indian River," "Indian Head," "Indian Bay," "Indian Hill," and the like). There are besides these *Indiana* and its capital *Indianapolis*. In Newfoundland "Red Indian," as the special term for the Beothuks, forms part of a number of place-names. Pope's characterization of the American aborigine,

"Lo! the poor Indian, whose untutor'd mind  
Sees God in clouds, or hears Him in the wind,"

is responsible for the creation in the mind of the people of a "Mr Lo," who figures in newspaper lore, cartoons, &c. The reputations, deserved and undeserved, of certain Indian tribes north of Mexico have been such that their names have passed into English or into the languages of other civilized nations of Europe as synonyms for "ruffian," "thug," "rowdy," &c. Recently "les Apaches" have been the terror of certain districts of Paris, as were the "Mohocks" (Mohawks) for certain parts of London toward the close of the 18th century.

The North American Indians have been the subject of numerous popular fallacies, some of which have gained world-wide currency. Here belongs a mass of pseudo-scientific and thoroughly unscientific literature embodying absurd and extravagant theories and speculations as to the origin of the aborigines and their "civilizations" which derive them (in most extraordinary ways sometimes), in recent or in remote antiquity, from all regions of the Old World—Egypt and Carthage, Phoenicia and Canaan, Asia Minor and the Caucasus, Assyria and Babylonia, Persia and India, Central Asia and Siberia, China and Tibet, Korea, Japan, the East Indies, Polynesia, Greece, and at times even to Celtic Europe and even medieval Ireland and Wales. Favourite theories of this sort have made the North American aborigines the descendants of refugees from sunken Atlantis, Tatar warriors, Malayo-Polynesian sea-farers, Hittite immigrants from Syria, the "Lost Ten Tribes of Israel," &c., or attributed their social, religious and political ideas and institutions to the advent of stray junks from Japan, Buddhist votaries from south-eastern Asia, missionaries from early Christian Europe, Norse vikings, Basque fishermen and the like.

Particularly interesting are the theories of Welsh (or white) Indians and the "Lost Ten Tribes." The myth of the "Welsh Indians" is reputed to be the descendants of a colony founded about A.D. 1170 by Prince Madoc (well known from Southey's poem), has been studied by James Mooney (*Amer. Anthropol.* iv., 1891, 393-394), who traces its development from statements in an article in *The Turkish Spy*, published in London about 1730. At first these "Welsh Indians," who are subsequently described as speaking Welsh, possessing Welsh Bibles, beads, crucifixes, &c., are placed near the Atlantic coast and identified with the Tuscaroras, an Iroquoian tribe, but by 1776 they had retreated inland to the banks of the Missouri above St. Louis. A few years later they were far East in India, Polynesia, Greece, as time went on to recur farther and farther westward, being identified successively with the Mandans, in whose language Catlin thought he detected a Welsh element, the Moqui, a Pueblo tribe of north-eastern Arizona, and the Modocs (here the name was believed to re-echo Madoc) of south-western Oregon, until at last they vanished over the waters of the Pacific Ocean. The theory that the American Indians were the "Lost Ten Tribes of Israel" has not yet entirely disappeared from ethnological literature. Many of the identities and resemblances in ideas, customs and institutions between the American Indians and the ancient Hebrews, half-knowledge or distorted views of which

Popular fallacies.

formed the basis of the theory, are discussed, and their real significance pointed out by Colonel Garrick Mallory in his valuable address on "Israelite and Indian: A Parallel in Planes of Culture" (*Proc. Amer. Assoc. Adv. Sci.* vol. xxxviii., 1889, pp. 287-331). The whole subject has been discussed by Professor H. W. Henshaw in his "Popular Fallacies respecting the Indians" (*Amer. Anthropol.* vol. vii. n.s., 1905, pp. 104-113).

Of ways of classifying the races of mankind and their subdivisions the number is great, but that which measures them by their speech is both ancient and convenient. The multiplicity of languages among the American Indians

**Linguistic stocks.**

was one of the first things that struck the earliest investigators of a scientific turn of mind, no less than the missionaries who preceded them. The Abbé Hervas, the first serious student of the primitive tongues of the New World, from the classificatory point of view, noted this multiplicity of languages in his *Catálogo delle lingue conosciute e notizia della loro affinità e diversità* (Cesena, 1784); and after him Balbi, Adelung and others. About the same time in America Thomas Jefferson, who besides being a statesman was also a considerable naturalist (see *Amer. Anthropol.* ix. n.s., 1907, 499-509), was impressed by the same fact, and in his *Notes on the State of Virginia* observed that for one "radical language" in Asia there would be found probably twenty in America. Jefferson himself collected and arranged (the MSS. were afterwards lost) the vocabularies of about fifty Indian languages and dialects, and so deserves rank among the forerunners of the modern American school of comparative philologists. After Jefferson came Albert Gallatin, who had been his secretary of the treasury, as a student of American Indian languages in the larger sense. He had also himself collected a number of Indian vocabularies. Gallatin's work is embodied in the well-known "Synopsis of the Indian Tribes within the United States East of the Rocky Mountains, and in the British and Russian Possessions in North America," published in the *Transactions and Collections of the American Antiquarian Society* (ii. 1-422) for 1836. In this, really the first attempt in America to classify on a linguistic basis the chief Indian tribes of the better-known regions of North America, Gallatin enumerated the following twenty-nine separate divisions: Adaize, Algonkin-Lenape, Athapascas, Atnas, Attacapas, Blackfeet, Caddoes, Catawbas, Chahtas, Cherokeees, Chetimachas, Chinooks, Eskimaux, Fall Indians, Iroquois, Kinai, Koulischen, Muskhoegan, Natches, Pawnees, Queen Charlotte's Island, Salish, Salmon River (Friendly Village), Shoshonees, Sioux, Straits of Fuca, Utchees, Wakash, Woccons. These do not all represent distinct linguistic stocks, as may be seen by comparison with the list given below; such peoples as the Caddo and Pawnee are now known to belong together. The Blackfeet are Algonkian, the Catawba Siouan, the Adaize Caddoan, the Natchez Muskogian, &c. But the monograph is a very good first attempt at classifying North American Indian languages.

Gallatin's coloured map of the distribution of the Indian tribes in question is also a pioneer piece of work. In 1840 George Bancroft, in the third volume of his *History of the Colonization of the United States*, discussed the Indian tribes east of the Mississippi, listing the following eight families: Algonquin, Catawba, Cherokee, Huron-Iroquois, Mobilian (Choctaw and Muskhoegan), Natchez, Sioux or Dahcota, Uchee. He gives also a linguistic map, modified somewhat from that of Gallatin. The next work of great importance in American comparative philology is Horatio Hale's monograph forming the sixth volume (Phila., 1846), *Ethnography and Philology*, of the publications of the "United States Exploring Expedition, during the years 1838, 1839, 1840, 1842, under the Command of Charles Wilkes, U.S. Navy," which added much to our knowledge of the languages of the Indians of the Pacific coast regions. Two years later Gallatin published in the second volume of the *Transactions of the American Ethnological Society* (New York) a monograph entitled "Hale's Indians of North-west America, and Vocabularies of North America," in which he recognized the following additional groups: Arrapahoos, Jakon, Kalapuya, Kitunaha, Lutwami, Palainih, Sahaptin, Saste, Wailatpu. In 1853 he contributed a

brief paper to the third volume of Schoolcraft's *Information Respecting the History, Condition and Prospects of the Indian Tribes of the United States*, adding to the "families" already recognized by him the following: Cumanches, Gros Ventres, Kaskaias, Kiaways, Natchitoches, Towiaks, Ugaljachmutzi. Some modifications in the original list were also made. During the period 1853-1877 many contributions to the classification of the Indian languages of North America, those of the west and the north-west in particular, were made by Gibbs, Latham, Turner, Buschmann, Hayden, Dall, Powers, Powell and Gatschet. The next important step, and the most scientific, was taken by Major J. W. Powell, who contributed to the *Seventh Annual Report of the Bureau of Ethnology, 1885-1886* (Washington, 1891) his classic monograph (pp. 1-142) on "Indian Linguistic Families of America North of Mexico." In 1891 also appeared Dr D. G. Brinton's *The American Race: A Linguistic Classification and Ethnographic Description of the Native Tribes of North and South America* (New York, p. 392). With these two works the adoption of language as the means of distinction and classification of the American aborigines north of Mexico for scientific purposes became fixed. Powell, using the vocabulary as the test of relationship or difference, enumerated, in the area considered, 58 separate linguistic stocks, or families of speech, each "as distinct from one another in their vocabularies and apparently in their origin as from the Aryan or the Scythian families" (p. 26).

The 58 distinct linguistic stocks of American Indians north of Mexico, recognized by Powell, were as follows: (1) Adaizan; (2) Algonquin; (3) Athapascan; (4) Attacapan; (5) Beothukan; (6) Caddoan; (7) Chimakuan; (8) Chimirikan; (9) Chimesyan; (10) Chinookan; (11) Chitimachan; (12) Chumashan; (13) Coahuiltecan; (14) Copehan; (15) Costanoan; (16) Eskimauan; (17) Esselenian; (18) Iroquoian; (19) Kalapooian; (20) Karankawan; (21) Keresan; (22) Kiowan; (23) Kitunahan; (24) Kolushan; (25) Kulapanan; (26) Kusan; (27) Lutwami; (28) Mariposan; (29) Moquelumnan; (30) Muskhoegan; (31) Natchesan; (32) Palaihihihan; (33) Piman; (34) Pujunan; (35) Quoratan; (36) Salinan; (37) Salishan; (38) Sastean; (39) Shahaptian; (40) Shoshonean; (41) Siouan; (42) Skittagetan; (43) Takilian; (44) Tafoan; (45) Timuquanan; (46) Tonikan; (47) Tonkawan; (48) Uchean; (49) Wailatpuan; (50) Wakashan; (51) Washoan; (52) Weitspekan; (53) Wishoskan; (54) Yakonan; (55) Yanan; (56) Yukian; (57) Yuman; (58) Zuñian.

This has been the working-list of students of American Indian languages, but since its appearance the scientific investigations of Boas, Gatschet, Dorsey, Fletcher, Mooney, Hewitt, Hale, Morice, Henshaw, Hodge, Matthews, Kroeber, Dixon, Goddard, Swanton and others have added much to our knowledge, and not a few serious modifications of Powell's classification have resulted. With Powell's monograph was published a coloured map showing the distribution of all the linguistic stocks of Indians north of Mexico. Of this a revised edition accompanies the *Handbook of American Indians North of Mexico*, published by the Bureau of American Ethnology in 1907-1910, now the standard book of reference on the subject. The chief modifications made in Powell's list are as follows: The temporary presence in a portion of south-west Florida of a new stock, the Arawakan, is now proved. The Adaizan language has been shown to belong to the Caddoan family; the Natchez to the Muskogian; the Palaihihi to the Shastan; the Piman to the Shoshouan. The nomenclature of Powell's classification has never been completely satisfactory to American philologists, and a movement is now well under way (see *Amer. Anthropol.* vii. n.s., 1905, 579-593) to improve it. In the present article the writer has adopted some of the suggestions made by a committee of the American Anthropological Society in 1907, covering several of the points in question.

In the light of the most recent and authoritative researches and investigations the linguistic stocks of American aborigines north of Mexico, past and present, the areas occupied, earliest homes (or original habitats), number of tribes, subdivisions, &c., and population, may be given as follows:—

Stock.	Area.	Earliest Home.	Tribes, &c.	Population.	Stock.	Area.	Earliest Home.	Tribes, &c.	Population.
1. ALGONKIAN.	Most of N. and E. North America, between lat. 35° and 55°; centred in the region of the Great Lakes and Hudson's Bay.	N. of the St. Lawrence and E. of Lake Ontario (Brinton); N.W. of the Great Lakes (Thomas).	Some 50-60, with many minor groups.	About 90,000, of which some 50,000 in Canada.		and from the Pacific Ocean to the San Joaquin river.			
2. ARAWAKAN.	Within the territory of the Calusas in S.W. Florida.	Central South America.	Small colony from Cuba.	Extinct about end of 16th century.	14. ESKIMOAN.	Greenland and some of the Arctic islands, the whole northern coast N. of the Algonkian and Alaskan from the straits of Belle Isle to the end of the Aleutian Islands; also in extreme N.E. Asia W. to the Anadyr river; in E. North America in earlier times possibly considerably farther south.	Interior of Alaska (Rink); in the region W. of Hudson's Bay (Boas); preferably the latter.	9 well-marked groups, with 60-70 "settlements," &c.	About 28,000, of which there are in Greenland 11,000, in Alaska 13,000, in Canada 4,500, and in Asia 1,500.
3. ATAPAPAN.	In part of S.W. Louisiana and N.E. Texas.	Somewhere in E. or N.E. Texas.	2.	Practically extinct; in 1884 individuals living in Louisiana, and 5 in Texas.	15. ESSALENIAN.	On the coast of W. California, S. of Monterey, N. of the Salinan.	Somewhere in W. or central California.	Many small settlements.	Extinct; last speaker of language died about 1890.
4. ATHABASKAN.	Interior of Alaska and Canada; W. of Hudson's Bay and N. of the Algonkian; also represented in Oregon, California, New Mexico, Texas, and northern Mexico.	Interior of Alaska or N.W. Canada.	Some 50, with many minor groups.	About 54,000, of which some 20,000 in Canada.	16. HAIDAN (Skit-tagetan).	The Queen Charlotte Islands, off the N.W. coast of British Columbia, and part of the Prince of Wales Archipelago, Alaska.	Interior of Alaska or N.W. Canada.	2 dialects; about 25 chief "towns," and many minor settlements.	About 900, of which 300 are in Alaska.
5. BEOTHUKAN.	Newfoundland.	Some part of Newfoundland or Labrador.	Local settlements only.	Extinct; last representative died in 1850.	17. IROQUOIAN.	The region about Lakes Erie and Ontario (Ontario, New York, Pennsylvania, Ohio, &c.) and on both banks of the St. Lawrence, on the N. to beyond the Saguenay, on the S. to Gaspe; also represented in the S.E. United States by the Tuscarora, Cherokee, &c. (now chiefly in Oklahoma).	Somewhere between the lower St. Lawrence and Hudson's Bay (Brinton, Hale); in S. Ohio and Kentucky (Boyle, Thomas).	Some 15 chief tribes with many minor subdivisions.	About 40,000, of which 10,000 are in Canada; of those in the United States 28,000 are Cherokee.
6. CADDOAN.	Country between the Arkansas and Colorado rivers in Louisiana, Texas, &c., particularly on the Red River and its alluvies; later also in Kansas, Nebraska, Dakota, and Oklahoma.	On the lower Red River, or perhaps, somewhere to the S.W.	Some 12-15	About 2000.	18. KALAPUYAN.	In N.W. Oregon, in the valley of the Willamette, above the Falls.	Somewhere in N.W. Oregon.	With 15-18, but minor divisions.	Only some 140 individuals still living.
7. CHEMUKIAN.	On the N.W. shore of Puget Sound, Washington; also on Pacific coast, near Cape Flattery.	Some part of N.W. Washington.	2.	About 200.	19. KARANKAWAN.	On the Texas coast, from Galveston to Padre Island.	Somewhere in S. Texas.	5-6, with minor divisions.	Extinct probably in 1858; a few survived later, possibly, in Mexico.
8. CHIMARIKAN.	In N. California, on Trinity river, N.W. of the Copehan.	Somewhere in N. California.	1.	Practically extinct; in 1901 only 9 individuals reported living.	20. KERESAN.	In N. central New Mexico, on the Rio Grande and its tributaries the Jemez, San José, &c.	Somewhere in the New Mexico or Arizona region.	17 "villages" (pueblos); earlier more.	3900, in 6 pueblos (some 250 at Isleta).
9. CHINOOKAN.	On the lower Columbia river, from the Cascades to the Pacific Ocean; on the coast, N. to Shoalwater Bay and S. to Tillamook Head in Washington and Oregon.	N. of the Columbia, in W. Washington.	Some 10 or 12 with numerous villages.	About 300.	21. KIOWAN.	On the upper Arkansas and Canadian rivers, in Colorado, Kansas, Oklahoma, &c.; formerly on the head-waters of the Platte, and still earlier on the upper Yellowstone and Missouri, in S.W. Montana.	At the foot of the Rocky Mountains in S.W. Montana.	1.	1219 in Oklahoma.
10. CHITIMACHAN.	Part of S.E. Louisiana.	Region of Grand Lake and river, Louisiana.	2.	Nearly extinct; in 1891 only 100 individuals surviving.	22. KITUNABAN.	In S.E. British Columbia, N. Idaho, and part of N.W. Montana.	Somewhere E. of the Rocky Mountains in Montana or Alberta.	2 chief divisions and 3 others.	About 1700; half in Canada and half in the United States.
11. CHEMASHAN.	In S.W. California, S. of the Salinan and Mariposa; in the basins of the Sta. Maria, Sta. Inez, lower Sta. Clara, &c., on the coast, and the northern Sta. Barbara Islands.	Somewhere in S.W. California.	7 or more dialects, with many small settlements.	Nearly extinct; only 15-20 individuals still living.	23. KOLESHCHAN (Tlingit).	On the coast and adjacent islands of S. Alaska, from 55° to 60° N. lat.; also some in Canada.	Somewhere in the interior of Alaska or N.W. Canada.	About 30 local divisions, &c.; no true tribes.	About 2000.
12. COPEHAN (Wintun).	In central N. California, W. of the Pujanan; W. of the Coast range, from San Pablo and Suisun Bays N. to Mount Shasta.	Somewhere in N. California.	2 chief divisions, with many small settlements.	About 130 at various villages, and as many on Round Valley Reservation.	24. KULANAPAN (Pomo).	On the coast in N.W. California (Sonoma, Lake and Mendocino counties), W. of the Yastan.	Somewhere in N.W. California.	About 30 local divisions, &c.; no true tribes.	About 1000.
13. COSTANOAN.	In the coast region of central California, N. of the Salinan; from about San Francisco S. to Point Sur and Big Panocche Creek.	Somewhere in central California.	No true tribes, but 25 or 30 dialects.	Nearly extinct; only 25 or 30 individuals still living.	25. KUSAN.	On the coast of Oregon, on Coos Bay and	Somewhere inland from Coos Bay, Oregon.	4, earlier more.	About 50.

Stock.	Area.	Earliest Home.	Tribes, &c.	Population.	Stock.	Area.	Earliest Home.	Tribes, &c.	Population.
26. LUTIAMIAN (Klamath).	In the region of the Klamath and Tule lakes, Lost and Sprague rivers, &c., in Oregon (chiefly) and N.E. California; now on Klamath Reservation, Oregon, with a few also in Oklahoma.	In S. Oregon, N. of the Klamath lakes.	2, with local subdivisions.	1034; of these 755 Klamath, and 279 Modoc (50 in Oklahoma).	36. SHASTAN.	In N. California and S. Oregon, in the basins of the Pit and Klamath rivers, on Rogue river, and to beyond the Siskiyou Mountains; S. of the Lutiamian.	In N. California or Oregon.	6 or more linguistic divisions.	Less than 20 Shasta full-bloods; some 1,000 Achomawi.
27. MARIPOSAN (Yokuts).	In S. central California, in the valley of the San Joaquin, on the Tule, Kaweah, King's rivers, &c.; E. of the Salinas, S. of the Mokelumna.	Somewhere in central California.	30-40 groups with local dialects.	About 150, at Tule river reservation, &c.	37. SHOSHOONIAN.	In the W. part of the United States; most of the country between lat. 35° and 45° and long. 105° and 120°, with extensions N., S., and S.E. outside this area; represented also in California, and in Mexico by the Piman, Sonoran and Na-huastlan tribes.	Foot-hills and plains E. of the Rocky Mountains in N.W. United States or Canada, but residence in Plateau region long-continued.	Somer2-15 in the United States; many more in Mexico, ancient and modern.	In the United States, some 24,000.
28. MOQUELUMNAN (Miwok).	In central California, in three sections: the main area on the W. slope of the Sierras, from the Cosumnes river on the N. to the Fresno on the S.; a second on the N. shore of San Francisco Bay, and a third (small) S. of Clear Lake on the headwaters of Putah Creek.	Somewhere in central California.	7 dialects; no true tribes; about 20 local groups with numerous minor ones.	Several hundred; much scattered.	38. STUCAN.	In the basin of the Missouri and the upper Mississippi; from about N. lat. 35° 53' and at the broadest, from 95° to 110° W. long.; also represented in Wisconsin (Winnebago), Louisiana, the Carolinas, and Virginia (formerly).	In the Carolina-Virginia region.	Some 20 large and many minor ones.	About 38,000; of which some 1,400 in Canada.
29. MUSHKOGIAN (Muskogean).	In the Gulf States, E. of the Mississippi, most of Mississippi, Alabama and Georgia, part of Tennessee, S. Carolina, Florida, and Louisiana; now mostly in Oklahoma.	Somewhere W. of the Mississippi.	About 12, with many minor divisions.	About 40,000; of these 38,000 in Oklahoma, 100 in Mississippi, 500 in Louisiana.	39. TAKELMAN.	In S.W. Oregon, in the middle valley of Rogue river, on the upper Rogue, and to about the California line or beyond.	In some part of S. Oregon.	2.	Practically extinct; perhaps 6 speakers of the language alive.
30. PAKAWAN (Coahuiltecan).	On both banks of the Rio Grande in Texas and Mexico, from its mouth to beyond Laredo; at one time possibly E. to Antonio, and W. to the Sierra Madre.	Some part of N.E. Mexico.	20-25, some very small.	Practically extinct; in 1886 about 30 individuals still living, mostly on the Mexican side of the Rio Grande.	40. TANQAN.	In New Mexico, on the Rio Grande, &c., from lat. 33° to 36°; also a settlement with the Moqui in N.E. Arizona, and another on the Rio Grande at the boundary line, partly in Mexico.	Some part of New Mexico.	Some 12-15 pueblos.	About 2,500 in 12 pueblos.
31. PUYUNAN (Maidu).	In N.E. California, E. of the Sacramento river, between the Shastan and Moquelumnan.	N.E. California.	No true tribes; several larger and very many smaller local divisions, villages, &c.	About 250 full-bloods.	41. TIMUQIAN.	In Florida, from the N. border and the Ocala river to Lake Okechobee, perhaps farther N. and S.	Some part of Florida.	Some 60 settlements.	Extinct in 18th century.
32. QUORALEAN (Karok).	In extreme N.W. California, on the Klamath river, &c.; W. of the Shastan.	Somewhere in N. California.	Many "villages," &c.	In 1860 some 600; much reduced since; possibly 300.	42. TONKAN.	In part of E. Louisiana and part of Mississippi; in Avoyelles parish, La., &c.	Somewhere in Louisiana-Mississippi region.	3.	Practically extinct; in 1886 some 25 individuals living at Marksville, La.
33. SARAPTIAN.	In the region of the Columbia and its tributaries, in parts of Washington, Idaho and Oregon; between lat. 44° and 47°, and from the Cascades to the Bitter Root Mountains.	Somewhere in the region of the Columbia, or farther N.	5-7.	About 4200.	43. TONKAWAN.	In S. E. Texas, N.W. of the Karankawan; remnants now in Oklahoma.	Somewhere in W. Texas.	1.	Nearly extinct; in 1884 only 28 individuals living; in 1905 but 47, with Ponk as S. in Oklahoma.
34. SALINAN.	On the Pacific coast above S.W. California, from above S. Antonio, to below S. Louis Obispo; W. of the Mari- posan.	Somewhere in S. W. California.	2 or 3 larger divisions; no true tribes.	Practically extinct; in 1884 only 10-12 individuals living.	44. TSMESIAN (Chimmeyan).	In N.W. British Columbia, on the Nass and Skeena rivers, and the adjacent islands and coast S. to Millbank Sound; also (since 1885) on Annette Island, Alaska.	On the headwaters of the Skeena river.	3 main and several minor divisions.	About 1200 in Canada and 950 in Alaska.
35. SALESIAN.	A large part of S. British Columbia and Washington, with parts of Idaho and Montana; also part of Vancouver Island, and outliers in N. British Columbia (Bilqila), and S. W. Oregon.	Central or N. British Columbia.	Some 60-65, number are merely local divisions.	About 15,000 in Canada, and some 6,000 in the United States.	45. WALLATPIAN.	A western prairie (Molala) in the Cascade region between Mount Hood and Scott, in Washington and Oregon; and in eastern (Cayuse) on the headwaters of the Wallawalla, Umatilla and Grande Ronde rivers.	In Oregon, S. of the Columbia river.	2.	Language practically extinct; 405 Cayuse (in 1888 only 6 of which the mother tongue) are still living; in 1881 about 20 Molalas.

Stock.	Area.	Earliest Home.	Tribes, &c.	Population.
46. WAKASHAN (Kwakwaka'wakw).	Most of Vancouver Island (except south coast) and most of the coast of British Columbia from Gardner channel to Cape Mudge; also part of extreme N.W. Washington.	Somewhere in the interior of British Columbia.	3 main divisions, with more than 50 tribes.	4765, of which 455 are in the United States.
47. WASHOAN.	In E. central California and the adjoining part of Nevada, in the region of Lake Tahoe and the lower Carson valley.	In N.W. Nevada.	1.	About 200, in the region of Carson, Reno, &c.
48. WEITSPEKAN (Yurok).	In N.W. California, W. of the Quornatan.	In N. California or S. Oregon.	5 divisions; no true tribes.	A few hundreds; in 1870 estimated at 2000 or more.
49. WISHOSKAN (Wiyot).	In N.W. California, in the coast region, S. of the Weitspekan.	In N. California.	3-5 divisions; no true tribes.	Nearly extinct.
50. YAKONAN.	In W. Oregon, in the coast region and on the rivers from the Yaquina to the Umpqua.	W. central Oregon.	4 chief divisions, with numerous villages.	About 300, on the Siletz Reservation.
51. YANAN.	In central N. California in the region of Round Mountain, &c., S. of the Shastan.	Somewhere further E.	1.	Practically extinct; in 1884 but 15 individuals living.
52. YUCHIAN.	In F. Georgia, on the Savannah river from above Augusta down to the Ogeechee, and also on Chatahoochee river; remnants now in Oklahoma.	Somewhere E. of the Chatahoochee.	1.	About 500, with Creeks in Oklahoma.
53. YUCIAN.	In N.W. California, E. of the Copelan, with a N. and a S. section, in the Round Valley region.	N. or central California.	5 divisions; no true tribes.	About 250.
54. YUMAN.	In the extreme S.W. of the United States (lower Colorado and Gila valley), part of California, most of Lower California, and a small part of Mexico.	N. W. Arizona.	9-10.	In the United States about 4800.
55. ZUÑIAN.	In N.W. New Mexico, on the Zuñi river.	Some part of the New Mexico-Arizona region.	1.	1500.

Of these 55 different linguistic stocks 5 (Arawakan, Beothukan, Esselenian, Karankawan and Timuquan) are completely extinct, the Arawakan, of course, in North America only; 13 (Atakapan, Chimarikan, Chitimachan, Chumashan, Costanoan, Kusan, Pakawan, Salinan, Takelman, Tonikan, Tonkawan, Wishoskan, Yakanan) practically extinct; while the speakers of a few other languages or the survivors of the people once speaking them (e.g. Chemakuan, Chinookan, 2000 or 3000, in some cases fewer. Of the Waitaipuan, although some individuals belonging to the stock are still living, the language itself is practically extinct. The distribution of the various stocks reveals some interesting facts. Among these are the stretch of the Eskimoan along the whole Arctic coast and its extension into Asia; the immense areas occupied by the Athabaskan and the Algonkian, and (less notably) the Shoshonian and the Siouan; the existence of few stocks on the Atlantic slope (from Labrador to Florida, east of the Mississippi, but 8 are represented); the great multiplicity of stocks in the Pacific coast region, particularly in Oregon and California; the extension of the Shoshonian, Yuman and Athabaskan southward into Mexico, the Shoshonian in ancient, the Athabaskan in

modern times; the existence of an Arawakan colony in south-western Florida, a 16th-century representative in North America of a South American linguistic stock. Some stocks, e.g. Atakapan, Beothukan, Chemakuan, Chimarikan, Chitimachan, Kiowan, Kitunahan, Lutuamian, Takelman, Tonkawan, Waitaipuan, Yanan, Yuchian, Zuñi, &c., were not split up into innumerable dialects, possessing at most but two, three or four, usually fewer. Of the larger stocks, the Athabaskan, Algonkian, Shoshonian, Siouan, Iroquoian, Salishan, &c., possess many dialects often mutually unintelligible. In marked contrast with this is the case of the Eskimoan stock, where, in spite of the great distance over which it has extended, dialect variations are at a minimum, and the people "have retained their language in all its minor features for centuries" (Boas). As to the reason for the abundance of linguistic stocks in the region of the Pacific (from Alaska to Lower California, west of long. 115°), there are 37: Eskimoan, Kuluschan, Athabaskan, Haidan, Tsimshian, Wakashan, Salishan, Kitunahan, Chimakuan, Chinookan, Sahaptian, Waitaipuan, Shoshonian, Kalapuyan, Yakanan, Kusan, Takelman, Lutuamian, Quoratean, Weitspekan, Wishoskan, Shastan, Yanan, Chimarikan, Yukian, Copelan, Pujunan, Washoan, Kulnapapan, Moquelumnan, Mariposan, Costanoan, Esselenian, Salinan, Chumashan, Yuman) there has been much discussion. Of these no fewer than 18 are confined practically to the limits of the present state of California. Dialects of Athabaskan, Shoshonian and Yuman also occur within the Californian areas, thus making, in all, representatives of 21 linguistic stocks in a portion of the continent measuring less than 156,000 sq. m. In explanation of this great diversity of speech several theories have been put forward. One is to the effect that here, as in the region of the Caucasus in the Old World, the multiplicity of languages is due to the fact that tribe after tribe has been driven into the mountain valleys, &c., by the pressure of stronger and more aggressive peoples, who were setting forth on careers of migration and conquest. Another view, advocated by Horatio Hale in 1886 (*Proc. Amer. Assoc. Adv. Sci.*; also *Proc. Canad. Inst.*, Toronto, 1888), is that this great diversity of human speech is due to the language-making instinct of children, being the result of "its exercise by young children accidentally isolated from the teachings and influence of grown companions." A pair of young human beings, separating thus from the parent tribe and starting social life in a new environment by themselves, would, according to Mr Hale, soon produce a new dialect or a new language. This theory was looked upon with favour by Romanes, Brinton, and other psychologists and ethnologists. Dr R. B. Dixon (*Congr. intern. des. Amer.*, Quebec, 1906, pp. 255-263), discussing some aspects of this question, concludes "that the great linguistic and considerable cultural complexity of this whole California-Oregon region is due to progressive differentiation rather than to the crowding into this restricted area of remnants of originally discrete stocks." How far two dialects of one stock can go in the way of such differentiation without becoming absolutely distinct is illustrated by the Achomawi branches of the Shastan family of speech, which Dr Dixon has very carefully investigated.

The test of vocabulary is not the only means by which the languages of the North American aborigines might be classified. There are peculiarities of phonetics, morphology, grammar, sentence-structure, &c., which suggest groupings of the linguistic stocks consonant (e.g. the Kootenay local, as are certain of the tongues independent of their lexical content. Some languages are harsh and region), some melodious and vocalic, and others of the North Pacific of California and the south-eastern United States. Some employ reduplication with great frequency, like certain Shoshonian dialects; others, like Kootenay, but rarely. A few, like the Chinook, are exceedingly onomatopoeic. Some, like the northern languages of California, have no proper plural forms. Of the Californian languages the Pomo alone distinguishes gender in the pronoun, a feature common to other languages no farther off than Oregon. The high development and syntactical use of demonstratives which characterize the Kwakwaka'wakw are not found among the Californian tongues. A few languages, like the Chinook and the Tonika, possess real grammatical gender. Some languages are essentially suffix, others essentially suffix tongues; while yet others possess both prefixes and suffixes, or even infixes as well. In some languages vocalic changes, in others consonantal, have grammatical or semantic meaning. In certain languages tense, mood and voice are rather

weakly developed. In some languages syntactical cases occur (e.g. in certain Californian tongues), while in many others they are quite unknown. Altogether the most recent investigations have revealed a much greater variety in morphological and in grammatical processes than was commonly believed to exist, so that the general statement that the American Indian tongues are all clearly and distinctly of the "incorporating" and "synthetic" types needs considerable modification. Using criteria of phonetics, morphology, grammar, &c., some of the best authorities have been able to suggest certain groups of North American Indian languages exhibiting peculiarities justifying the assumption of relationship together. Thus Dr Franz Boas (*Mem. Intern. Congr. Anthropol.*, 1893, pp. 339-346, and *Ann. Archaeol. Rep. Ontario*, 1905, pp. 88-106) has grouped the linguistic stocks of the North Pacific coast region as follows: (1) Tlingit (Kolušchan) and Haida; (2) Tsimshian; (3) Wakashan (Kwakiwilt-Nootka), Salish, Chemakum; (4) Chinook. In the same region the present writer has suggested a possible relationship of the Kootenay with Shoshonian. In the Californian area Dr R. B. Dixon and Dr A. L. Kroeber have made out these probable groups among the numerous language stocks of that part of the United States: (1) Chumashan and Salinan; (2) Yurok (Weitspekan), Wishoskan, Athabaskan, Karok (Quora-tean), Chimariki; (3) Maidu (Pujunan), Lutuamian, Wintun (Weitspekan), Yukian, Pomo (Kulanagan), Costanoan, Esseenian, Yokut (Mariposan), Shoshonian, Shastan, Moquelumnan and possibly Washoan; (4) Yanan (8) Yuman. Suggestions of even larger groups than any of these have also been made. It may be that, judged by certain criteria, the Kootenay, Shoshonian, Iroquoian and Siouan may belong together, but this is merely tentative. It is also possible, from the consideration of morphological peculiarities, that some if not all of the languages of the so-called "Palaeo-Asiatic" peoples of Siberia, as Boas has suggested (*Science*, vol. xxiii, n.s., 1906, p. 644), may be included within the American group of linguistic stocks. Indeed Sternberg (*Intern. Amer.-Kongr.*, Leipzig, Stuttgart, 1904, pp. 137-140) has undertaken to show the relationship morphologically of one of these languages, the Giliak (of the island of Saghalin and the region about the mouth of the Amur), to the American tongues, and its divergence from the "Ural-Altai" family of speech. Here, however, more detailed investigations are needed to settle the question.

At one time the opinion was widely prevalent that primitive languages changed very rapidly, sometimes even within a generation, and the American Indian tongues were rather freely used as typical examples of such extreme variation. The error of this view is now admitted everywhere, and for the speech of the New World aborigines Dr Franz Boas states (*Hndb. Amer. Ind.*, pt. I, 1907, p. 759): "There is, however, no historical proof of the change of any Indian language since the time of the discovery comparable with that of the language of England between the roth and 13th centuries." Another statement that has obtained currency, appearing even in otherwise reputable quarters sometimes, is to the effect that some of the vocabularies of American Indian languages consist of but a few hundred words, one being indeed so scanty that its speakers could not converse by night, since darkness prevented resort to the use of gesture. This is absolutely contrary to fact, for the vocabularies of the languages of the American Indians are rich, and, according to the best authority on the subject, "it is certain that in every one there are a couple of thousand of stem words and many thousand words, as that term is defined in English dictionaries" (Boas). The number of words in the vocabulary of the individual Indian is also much greater than is generally thought to be the case. It was long customary, even in "scientific" circles, to deny to American Indian tongues the possession of abstract terms, but here again the authority of the best recent investigators is conclusive, for "the power to form abstract ideas is, nevertheless, not lacking, and the development of abstract thought would find in every one of the languages a ready means of expression" (Boas). In this connexion, however, it should be remembered that, in general, the languages of the American aborigines "are not so well adapted to generalized statements as to lively descriptions." The holophrastic terms characteristic of so many American Indian languages "are not due to a lack of power to classify, but are rather expressions of form of culture, single terms being intended for those ideas of prime importance to the people" (Boas). This consideration of American primitive tongues in their relation to culture-types opens up a comparatively new field of research, and one of much evolutionary significance.

As a result of the most recent and authoritative philological investigations, the following may be cited as some of the chief characteristics of many, and in some cases, of most of the languages of the aborigines north of Mexico.

1. Tendency to express ideas with great graphic detail as to place, form, &c.
2. "Polysynthesis," a device making possible, by the use of modifications of stems and radicals and the employment of prefixes, suffixes, and sometimes infixes, &c., the expression of a large number of special ideas. By such methods of composition (to be two examples from Boas) the Eskimo can say at one breath, so to speak, "He only orders him to go and see," and the Tsimshian, "He went with him upward in the dark and came against an obstacle." The Eskimo *Takusariatorumagaluarnerpa?* ("Do you think he really intends to go to look after it?") is made up from the following elements: *Takusar*(pá), "he looks after it"; *sarior* (pog), "he goes to"; *uma* (pog), "he intends to"; *Gre* *aluar* (pog), "he does so, but"; *nerpa* (pog), "do you think he." The Cree "word" "he was with you" (*was-wah-wah-wah-wah-wah-wah-wah-wah*) "i.e. the grace of Jesus Christ, 'remain with you'" is resolvable into: *Kélanow* (here split into *ke* at the beginning and *-owow* as terminal), "you" (pl.); *ko*=sign of futurity (first and second persons); *we*=an optative particle; *weche*= "with"; *tusheka*=verbal radical, "remain"; *mik*=pronominal particle showing that the subject of the verb is in the third person and the object in the second, "the-you"; *owaw*=verbal possessive particle, indicating that the subject of the verb is something inanimate belonging to the animate third person, "his-it." The Carrier (Athabaskan) *lehanawehshandashanaskrok*, "I usually commence to go to walk to and fro in the furs while singing," which Morice calls "a simple word" is built up from the following elements: *le*= "prefix expressing reciprocity, which, when in connexion with a verb of locomotion, indicates that the movement is executed between two certain points without giving prominence to either"; *ke*=particle denoting direction toward these points; *na*= "iterative particle, suggesting that the action is repeated"; *shak*= "particle referring to the action as being in its incipient stage"; *shak*= "singing" (when incorporated in a verb it "indicates that singing accompanies the action expressed by the verbal root"); *da*= "a particle called for by *shen*, said particle always entering into the composition of verbs denoting reference to vocal sounds"; *tho*= "the secondary radical of the uncomposited verb *thitkret* inflected from *thi* for the sake of euphony with *nas*; *nas*= "the pronominal element of the whole compound" (the *n* is demanded by the previous *hwe*, *a* marks the present tense, and *s* marks the first person singular of the third conjugation; *krak*= "the main radical referred here by the uisative from the normal form *kret*, and is expressive of locomotion habitually executed on four feet or on all fours").
3. Incorporation of noun and adjectives in verb, or of pronouns in verb. From the Kootenay language of south-eastern British Columbia the following examples may be given: *Natláamkine*="He carries (the) head in (his) hand"; *Howanokotáamkine*="I shake (the) head in (my) hand"; *Witáamkine*="His belly is large"; *Tlitáamkine*="He has no tail"; *Matnáakítáamkine*="He opens his eyes"; in these expressions are incorporated, with certain abbreviations of form, the words *aqhám*, "head"; *aqhám*, "belly"; *aqkat*, "tail"; *aqhákáakám*, "eye." In some languages the form for the noun incorporated in the verb is entirely different from that in independent use. Of pronominal incorporation these examples are from the Kootenay: *Nuppanáamkine*="He sees me"; *Honuppanáamkine*="I see you"; *Tshatápitáamkine*="He will kill you"; *Tshatápitáamkine*="He will bite us"; *Tshatsukwátáamkine*="He is going to seize you"; *Hintshatápitáamkine*="You will honour me." For incorporation of adjectives these examples will serve: *Honiterustik*="I paint (the) face black"; *Himáakítáamkine*="red" (*kanokos*, "red"; the radical is *nás* or *nás* for *nóhós*); *Howítáamkine*="I shout, literally, 'I talk big'; *Hoswítáamkine*="I am tall (*big*). In some languages the pronouns denoting subject, direct object and indirect object are all incorporated in the verb.
4. The formation of nouns of very composite character by the use of stems or radicals and prefixes, suffixes, &c., of various sorts, the intricacy of such formations exceeding often anything known in the Indo-European and Semitic languages. Often the component parts are clipped or changed by dissimilation, dissimilation, syncope, &c., before being used in the compound. The following examples from various Indian languages will illustrate the process:—Kootenay: *Aghínkanukúttáamkine*="crown of head," from *aq* (prefix of uncertain meaning), *kínkan*="top," *ttám*="head," *-nam* (suffix="somebody's"). Tlingit: *Kanyákwáale*="aurora," literally, "fire (kan)-like (yáq)-out-of-doors (ku)-colour (wáale)."
5. The development of a great variety of forms for personal and demonstrative pronouns. In the latter, sometimes, the language distinguishes visibility and invisibility, present and past location to the right, left, front and back of, and above and below the speaker" (Boas). According to Morice (*Trans. Canad. Inst.*, 1889-1890, p. 187), the Carrier language of the Athabaskan stock has no fewer than seventeen possessive pronouns of the third person.
6. Indistinctness of demarcation between noun and verb; in some languages the transitive and in others the intransitive only is really verbal in form.

7. The use of the intransitive verb as a means of expressing ideas which in European tongues, e.g., would be carried by adjectives. In the Carrier language almost all adjectives are "genuine verbs" (Morice).

8. The expression of abstract nouns in a verbalized form. Thus Cree (Algonkian) generally says, in preference to using the abstract noun *pimatisewin*, "life," the periphrastic verb *pimatisewinewuk*, literally "that they (indefinite as to person) live." So far is this carried sometimes that Horden (*Cree Grammar*, London, 1881, p. 5) says: "I have known an Indian speak a long sentence, on the duties of married persons to each other, without using a single noun."

As an interesting example of a long word in American-Indian languages may be mentioned the Iroquois *taontasakonatiawitserak-nomseronniotionhatieseke*. This "word," which, as Forbes (*Congr. intern. d. Amer.*, Quebec, 1906, p. 103) suggests, would serve well on the signboard of a dealer in novelties, is translated by him, "Que plusieurs personnes viennent acheter des habits pour d'autres personnes avec de quoi payer." Not so formidable is *deyeknonhse-dehkhihadasterastrahetokwa*, a term for "stove polish," in use on the Mohawk Reservation near Brantford, Ontario.

The literature in the native languages of North America due to missionary efforts has now reached large proportions. Naturally Bible translations have been most important. According to Wilberforce Eames (*Handbook of Amer. Inds.*, 1907, pt. i, pp. 143-145), "the Bible has been printed in part or in whole in 32 Indian languages north of Mexico. In 18 one or more portions have been printed; in 9 others the New Testament or more has appeared; and in 5 languages, namely, the Massachusset, Cree, Labrador Eskimo, Santee Dakota and Tukthukutchin, the whole Bible is in print." Of the 32 languages possessing Bible translations of some sort 3 are Eskimoan dialects, 4 Athabaskan, 13 Algonkian, 3 Iroquoian, 2 Muskogian, 2 Siouan, 1 Caddoan, 1 Sahaptian, 1 Wakashan, 1 Tsimshian, 1 Haidan. Translations of the Lord's Prayer, hymns, articles of faith and brief devotional compositions exist now in many more languages and dialects. A goodly number of other books have also been made accessible in Indian versions, e.g. Bunyan's *Pilgrim's Progress* (Dakota, 1857), Baxter's *Call to the Unconverted* (Massachusetts, 1655), Goodrich's *Child's Book of the Creation* (Choctaw, 1830), Thomas, A.'s *Kempis's Imitation of Christ* (Greenland Eskimo, 1787), Newton's *The King's Highway* (Dakota, 1879), &c. The "Five Civilized Tribes," who are now full-fledged citizens of the state of Oklahoma, possess a mass of literature (legal, religious, political, educational, &c.) published in the alphabet adapted from the "Cherokee Alphabet" invented by Sequoyah about 1821, "which at once raised them to the rank of a literary people."

Of periodicals in Indian languages there have been many published from time to time among the "Five Civilized Tribes." Of the *Cherokee Advocate*, Mooney said in 1807-1808, "It is still continued under the auspices of the Nation, printed in both languages (i.e. Cherokee and English), and distributed free at the expense of the Nation to those unable to read English—an example without parallel in any other government." More or less ephemeral periodicals (weekly, monthly, &c.) are on record in various Algonkian, Iroquoian, Siouan and other languages, and the Greenland Eskimo have one, published irregularly since 1861. Wilberforce Eames (*Handbook of Amer. Inds.*, 1907, pt. i, p. 389) chronicles 122 dictionaries (of which more than half are still in MSS.) of 63 North American-Indian languages, belonging to 19 different stocks.

The following linguistic stocks are represented by printed dictionaries (in one or more dialects): Algonkian, Athabaskan, Chinookan, Eskimoan, Iroquoian, Lutuamian, Muskogian, Salishan, Shoshonian, Siouan. There exists a considerable number of texts (myths, legends, historical data, songs, grammatical material, &c.) in quite a number of Indian languages that have been published by scientific investigators. The Algonkian (e.g. Jones's *Fox Texts*, 1908), Athabaskan (e.g. Goddard's *Hupa Texts*, 1904, Matthews's *Navaho Legends*, 1897, &c.), Caddoan (e.g. Miss A. C. Fletcher's *Hoopa Ceremony*, 1901), Chinookan (Boas's *Chinook Texts*, 1904, and *Kathlamet Texts*, 1901), Eskimoan (texts in Boas's *Eskimo of Baffin Land*, &c., 1901, 1908; and Thalbitzer's *Eskimo Language*, 1904, Barnum's *Inuit Grammar*, 1901), Haidan (Swanton's *Haida Texts*, 1905, &c.), Iroquoian (texts in Hale's *Iroquois Book of Rites*, 1883, and Hewitt's *Iroquoian Cosmology*, 1899), Lutuamian (texts in Gatschet's *Klamath Indians*, 1890), Muskogian (texts in Gatschet's *Migration Legend of the Creeks*, 1884-1888), Salishan (texts in various publications of Boas and Hill-Tout), Siouan (Riggs and Dorsey in various publica-

tions), Tsimshian (Boas's *Tsimshian Texts*, 1902), Wakashan (Boas's *Kwakwaka'waka Texts*, 1902-1905), &c.

The question of the direction of migration of the principal aboriginal stocks north of Mexico has been reopened of late years. Not long ago there seemed to be practical agreement as to the following views. The Eskimo stock had reached its present habitats from a primitive home somewhere in the interior of north-western Canada or Alaska; the general trend of the Athabaskan migrations, and those of the Shoshonian tribes had been south and south-east, the first from somewhere in the interior of north-western Canada, the second from about the latitude of southern British Columbia; the Algonkian tribes had moved south, east and west from a point somewhere between the Great Lakes and Hudson Bay; the Iroquoian stock had passed southward and westward from some spot to the north-east of the Great Lakes; the Siouan tribes, from their primitive home in the Carolinas, had migrated westward beyond the Mississippi; some stocks, like the Kitunahan, now found west of the Rocky Mountains, had dwelt formerly in the plains region to the east. Professor Cyrus Thomas, however, of the Bureau of American Ethnology, discussing primary Indian migrations in North America (*Congr. intern. d. Amer.*, Quebec, 1906, i. 189-204), rejects the theory that the Siouan stock originated in the Carolinas, and adopts for them an origin in the region north of Lake Superior, whence he also derives the Iroquoian stock, whose primitive home Dr David Boyle (*Ann. Archaeol. Rep. Ontario*, 1905, p. 154), the Canadian ethnologist, would place in Kentucky and southern Ohio. Another interesting contribution to this subject is made by Mr P. E. Goddard (*Congr. intern. des. Amer.*, Quebec, 1906, i. 337-358). Contemplating the distribution of the tribes belonging to the Athabaskan stock in three divisions, viz. a northern (continuous and very extensive), a Pacific coast division (scattered through Washington, Oregon, California), and a southern division which occupies a large area in Arizona, New Mexico, Colorado, Kansas, Texas and Mexico, Mr Goddard suggests that the intrusion of non-Athabaskan peoples into a region once completely in the possession of the Athabaskan stock is the best explanation for the facts as now existing not explicable from assimilation to environment, which has here played a great rôle. It is possible also that a like explanation may hold for the conditions apparent in some other linguistic stocks. Many Indian tribes have been forcibly removed from their own habitats to reservations, or induced to move by missionary efforts, &c. Thus, in the state of Oklahoma are to be found representatives of the following tribes: Apache, Arapaho, Caddo, Cherokee, Cheyenne, Chickasaw, Choctaw, Comanche, Creek, Iowa, Kansa, Kickapoo, Kiowa, Miami, Missouri, Modoc, Osage, Oto, Ottawa, Pawnee, Peoria, Ponca, Potawatomi, Quapaw, Sac and Fox, Seminole, Seneca, Shawnee, Tonkawa, Wichita, Wyandot, &c.; these belong to 10 different linguistic stocks, whose original habitats were widely distant from one another in many cases.

Some of the American-Indian linguistic stocks (those of California especially) hardly know real tribal divisions, but local groups or settlements only; others have many large and important tribes.

The tabular alphabetical list given in the following pages contains the names of the more important and more interesting tribes of American aborigines north of Mexico, and of the stocks to which they belong, their situation and population in 1900, the degree of intermixture with whites or negroes, their social, moral and religious condition, state of progress, &c., and also references to the best or the most recent literature concerning them.

Up to the date of their publication references to the literature concerning the tribes of the stocks treated will be found in Pilling's bibliographies: Algonkian (1891), Athabaskan (1892), Chinookan (1893), Eskimoan (1887), Iroquoian (1888), Muskogean (1889), Salishan (1893), Siouan (1887) and Wakashan (1894). See also the *Handbook of American Indians North of Mexico* (Washington, 1907-1910); and the sumptuous monograph of E. S. Curtis, *The North American Indian* (N. Y., vols. i-xx., 1908), with its remarkable reproduction of Indian types.

Tribe.	Stock.	Situation, Population, &c.	Degree of Interixture.	Condition, Progress, &c.	Authorities.
ABSAKI.	Algonkian.	At Beauport, Quebec, 27; at St François du Lac and Pierrefort, 330. Decreasing.	Probably no pure blood left.	As civilized as the neighbouring whites. All Catholics.	Maurault, <i>Hid. des Abénaquis</i> (Quebec, 1866); Jack, <i>Trans. Canad. Inst.</i> , 1892-1893.
ACHOMAWI (Piñon Indians).	Shastan.	N.E. California. About 1100 in the Piñon river region; also 50 or 60 on the Klamath Reservation, Oregon.	Little.	Progress very slow; influence of schools felt. Klamath Achomawi under Methodist influence.	Powers, <i>Contrib. N. Amer. Ethnol.</i> , vol. iii, 1877; various writings of Dr. R. B. Dixon, <i>American Anthropologist</i> , 1905-1908, &c.
ALEUTS.	Eskimoan.	Alutian Islands and part of Alaska. About 1000. Decreasing.	About 50 % are mixed bloods.	"Decaying." Once converted to Greek Orthodox church. Methodist mission at Unalakleet.	Works (in Russian) of Veniaminov, 1800-1842; <i>Collier, Juare Amer. Folk-Lore</i> , 1905-1907; Chamberlain, <i>Diet. Relig. and Ethic.</i> (Hastings, vol. 1, 1908).
AMALETITES (Malisets).	Algonkian.	100 at Viger (Cacouna, Quebec); 200 in various parts of W. New Brunswick. Apparently increasing.	Probably few pure bloods.	Fairly good. At Viger industrially unsettled. Catholics.	Writings of S. T. Rand; Chamberlain (M.), <i>Malisiet Vocabulary</i> (Cambridge, 1899).
APACHE.	Athabaskan.	In Arizona, 4879; New Mexico, 1244 (Oklahoma), 453. Not rapidly decreasing as formerly thought.	Considerable Spanish blood due to captives, &c.	Marked improvement here and there. Catholic and Lutheran missions.	Cremoney, <i>Life among the Apaches</i> (1868); Bourke, <i>6th Ann. Rep. Bur. Ethnol.</i> , 1887-1888, and <i>Journ. Amer. Folk-Lore</i> , 1890; Hrdlička, <i>American Anthropologist</i> , 1905.
ARAPAHO.	Algonkian.	358 at Ft. Belknap Reservation, Montana; 873 at Wind River Reservation, Wyoming; 885 in Oklahoma. Holding their own.	Some Spanish (Mexican) blood in places.	Oklahoma Arapaho American citizens; progress elsewhere. Men's motto missions chiefly; also Dutch Reformed.	Writings of Kroeber and Dorsey, <i>Bull. Bur. Ethnol.</i> , 1890-1907; and <i>Publ. Field Columb. Mus.</i> , 1903; Scott, <i>Amer. Anthropol.</i> , 1907.
ASSINIBOIN.	Siouan.	In Montana, 1248; Alberta, 974; Saskatchewan, 420.	Some little.	In Canada "steady advance," elsewhere good. Alberta Assiniboin are Methodists; in Montana Catholic and Presbyterian missions on reservations.	Maclean, <i>Canadian Savage Folk</i> (Toronto, 1890); McGe, <i>25th Ann. Rep. Bur. Ethnol.</i> , 1893-1894.
BABINES.	Athabaskan.	530 on Habine Lake, Bulkley river, &c., in central British Columbia.	Little, if any.	Conservative. Little progress reached by Catholic mission of Stuart Lake, B.C.	Morice, <i>Anthrop.</i> , 1906-1907, and <i>Ann. Arch. Rep. Ontario</i> , 1905, and other writings.
BANNOCK.	Shoshonian.	About 500 at Ft. Hall, and 78 at Lemhi Agency, Idaho.	Little.	Considerable improvement morally and civilly.	Hoffman, <i>Proc. Amer. Philos. Soc.</i> , 1886; Mooney, <i>16th Ann. Rep. Bur. Ethnol.</i> , 1892-1893; Lewis, <i>Anthrop. Pap. Amer. Mus. Nat. Hist.</i> , 1909.
BEAVER.	Athabaskan.	About 700 on Peace river, a western affluent of Lake Athabaska.	Very little.	Rather stationary.	See Babines.
BIDJULA (Bellacoola).	Salishan.	287 on Dean Inlet, Bentinck Arm, Bellaçoola river, &c., coast of central British Columbia. Decreasing.	Little.	Not very encouraging. Mission influence not yet strongly felt.	Boss, <i>Rep. Brit. Assoc. Adv. Sci.</i> , 1891, and <i>Mem. Amer. Mus. Nat. Hist.</i> , 1898.
BLACKFEET (Siksika).	Algonkian.	About 824 in Alberta, Canada. Decreasing.	Little.	Steadily improving morally and financially. Anglicans, 237; Catholics, 269; pagans, 327.	Maclean, <i>Canadian Savage Folk</i> (Toronto, 1890), and other writings; Grinnell, <i>Blackfoot Lodge-Poles</i> (N.Y., 1903), and other writings; Wisler, <i>Ann. Arch. Rep. Ontario</i> , 1905; Schultz, <i>My Life as an Indian</i> (N.Y., 1907); Wisler, <i>Anthrop. Pap. Amer. Mus. Nat. Hist.</i> , 1908.
BLOODS.	Algonkian.	1108 near Ft. Macleod, Alberta. Probably decreasing somewhat.	Little.	All able-bodied Indians will soon be self-supporting. Presbyterians, 150; Catholics, 150; the rest pagans.	See Blackfeet.
CADDO.	Caddoan.	350 in Oklahoma. Increasing slightly.	Considerable French blood.	Citizens of United States. Catholic, Methodist and Presbyterian missions.	Mooney, <i>14th Ann. Rep. Bur. Ethnol.</i> , 1891-1892; and other writings of Fletcher, Dorsey, &c.
CARBOND-EATERS.	Athabaskan.	1900 in the region E. of Lake Athabaska, N.W. Canada.	Little, if any.	Little progress.	See Babines.
CARRIERS.	Athabaskan.	970 between Tañla Lake and Ft. Alexandra, central British Columbia.	Little.	Semi-sedentary and naturally progressive as Indians, improvements beginning to be marked. Under influence of Catholic mission at Stuart Lake, B.C.	Morice, <i>Proc. Canad. Inst.</i> , 1889; <i>Trans. Canad. Inst.</i> , 1894, <i>Hist. of Northern Inter. of British Columbia</i> (Toronto, 1904), and other writings.
CATAWA.	Siouan.	About 100 on the Catawba river, York county, South Carolina. Decreasing.	Much mixed with white blood.	Slowly adopting white man's ways. Chastly farmers.	Mooney, <i>Siouan Tribes of the East</i> (Washington, 1894); <i>American Anthropologist</i> , 1900; Harrington, <i>ibid.</i> , 1908.
CAYUGA.	Iroquoian.	179 on the Iroquois Reservations in New York State; 1024 with the Six Nations in Ontario; also some with the Seneca in Oklahoma and with Oneida in Wisconsin.	Some English admixture.	Canadian Cayuga steadily improving; they are "pagan."	See Six Nations.
CAYUSE.	Waiilatpan.	405 on Umatilla Reservation, Oregon.	About 1/2 are of mixed blood, chiefly French.	Conditions improving. Good work of Catholic and Presbyterian missions.	Moorey, <i>Marcus Whitman</i> (1901); Lewis, <i>Mem. Amer. Anthrop. Assoc.</i> , 1900.
CHERALS.	Salishan.	182 on Puyallup Reservation, Washington. Perhaps increasing slightly.	No data.	Gradually improving and generally prosperous. Congregational mission.	Bills, <i>Contrib. N. Amer. Ethnol.</i> , vol. iii, 1877; Edlis, <i>Hist. of Ind. Missions on the Pacific Coast</i> (N.Y., 1882), and other writings.
CHEROKEE.	Shoshonian.	About 500 at the Colorado Reservation, a few elsewhere in Arizona and California.	No data.	Some improvement. Missions of the Presbyterians and of the Church of the Nazarene.	See Ute.
CHEROKEE.	Iroquoian.	About 28,000, of which 1489 are in North Carolina and the rest in Oklahoma.	Not more than 1/2 are of approximately pure blood.	Oklahoma Cherokee citizens of the United States, and making excellent progress. Various religious faiths.	Royce, <i>5th Ann. Rep. Bur. Ethnol.</i> , 1883-1884; Mooney, <i>7th Rep.</i> , 1885-1886, and especially <i>10th Rep.</i> , 1895-1896.



Tribe.	Stock.	Situation, Population, &c.	Degree of Intermixture.	Condition, Progress, &c.	Authorities.
CHEYENNE.	Algonkian.	1,440 northern Cheyenne in Montana, 1894 southern Cheyenne in Oklahoma. Former increasing, latter decreasing.	Some white blood, from captives, &c.	Southern Cheyenne citizens of United States; Menomonic mission doing good work. Northern Cheyenne making progress as labourers, &c.; Menomonic and Catholic missions.	Mooney, 14th Ann. Rep. Bur. Ethnol., 1892-1893; Dorsey, <i>Publ. Field Colum. Mus.</i> , 1905; Grinnell, <i>Intern. Congr. Americanists</i> , 1902-1903; <i>Journ. Amer. Folk-Lore</i> , 1907-1908; <i>Amer. Anthropol.</i> , 1902-1906; Mooney and Petter, <i>Mem. Amer. Anthropol.</i> , 1907.
CHICKAHOMINY.	Algonkian.	Some 230 on Chickahominy river, Virginia.	No pure bloods left. Considerable negro admixture.	Fishers and Farmers.	Tooker, <i>Algonquian Series</i> (N.Y., 1903); Mooney, <i>Amer. Anthropol.</i> , 1907.
CHICKSAW.	Muskogian.	558 in Oklahoma.	Large admixture of white blood.	American citizens and progressing well. Various religious faiths.	Speck, <i>Journ. Amer. Folk-Lore</i> , 1907, and <i>Amer. Anthropol.</i> , 1907.
CHILCOTIN.	Athabaskan.	About 450 on Chilcotin river, in S. central British Columbia.	Little.	Fairly laborious, but clinging to native customs, though making progress. Catholic mission influence.	Writings of Morice (see Carriers); Farrand, <i>Mem. Amer. Mus. Nat. Hist.</i> , 1900.
CHILKAT.	Kotuschan.	About 700 at head of Lynn Canal, Alaska. Decreasing.	No data.	Little progress.	Emmons and Boas, <i>Mem. Amer. Mus. Nat. Hist.</i> , 1908.
CHINOOK.	Chinookan.	About 300 in Oregon. Decreasing.	Some little.	Stationary or "worse."	Boas, <i>Chinook Texts</i> (Washington, 1894), and other writings; Sapir, <i>Amer. Anthropol.</i> , 1907.
CHIPWEYAN.	Athabaskan.	About 3000 in the region S. of Lake Athabaska, N.W. Canada.	Some Canadian-French admixture.	Coming to be more influenced by the whites. Reached by Catholic missions.	Writings of Patin, Legoff, Morice (see Balmine), &c.; Morice, <i>Anthropol.</i> , 1906-1907, and <i>Ann. Arch. Rep. Ontario</i> , 1905.
CHIPPEWA (Ojibwa).	Algonkian.	About 18,000 in Ontario, Manitoba, &c.; nearly the same number in the United States (Michigan, Wisconsin, Minnesota, N. Dakota).	Much French and English admixture in various regions.	Good progress. Many Indians quite equal to average whites of neighborhood. Among the Canadian Chippewa the Methodists, Catholics and Anglicans are well represented; among those in the United States the Catholics and Episcopalians chiefly, also Methodists, Lutherans, &c. A number of native ministers.	Warren, <i>Minn. Hist. Soc. Coll.</i> , 1885; Blackbird, <i>Ottawa and Chippewa Indians</i> (1887); W. Jones, <i>Ann. Arch. Rep. Ontario</i> , 1905; Huggin, <i>Congr. Int. d. Amer.</i> (Quebec, 1902); P. Jones, <i>Hist. Ojibway Inds.</i> (1862).
CHICTAW.	Muskogian.	17,329 in Oklahoma; 1356 in Mississippi and Louisiana.	Large element of white and some negro blood.	Citizens of United States, making good progress. Various religious faiths.	Gatschet, <i>Migration Legend of Creeks</i> (1884-1888); Speck, <i>Amer. Anthropol.</i> , 1907.
CLAYCOQUOT.	Wakashan.	223 in the region of Claycoquot Sound, Vancouver Island. Decreasing.	No data.	Rather stationary, but beginning to improve. Influence of Catholic mission and industrial school.	See Nootka.
CLALLAM.	Salishan.	354 on Puyallup Reservation, Washington.	Little.	Improving, but suffering from white contact. Congregationalist mission.	Eells in <i>Ann. Rep. Smiths. Inst.</i> , 1887, and other writings.
COLVILLE.	Salishan.	316 at Colville Agency, Washington. Decreasing slightly.	Some Canadian-French, &c.	Improving.	See Chelalis.
COMANCHE.	Shoshonian.	1,028 in Oklahoma. Now holding their own.	Some due to Spanish (Mexican) captives, &c.	Good progress, in spite of white impositions.	Mooney, 14th Ann. Rep. Bur. Ethnol., 1892-1893.
COWICHAN.	Salishan.	About 2000 on E. coast of Vancouver Island, and on islands in Gulf of Georgia.	Little.	Industrious; steady progress. Catholic and Methodist missions, chiefly former.	Hill-Tout, <i>Rep. Brit. Assoc. Adv. Sci.</i> , 1902, and <i>Trans. R. Anthropol. Inst.</i> , 1907; Boas, <i>Rep. Brit. Assoc. Adv. Sci.</i> , 1889.
CREE.	Algonkian.	About 12,000 in Manitoba, and some 500 in Saskatchewan, Alberta, Kewatin, &c.	Large element of French, Scottish and English blood.	Slow but steady progress (except with a few bands). Catholics, Methodists and Anglicans strongly represented by missions and church members; many Presbyterians also.	Writings of Peitout, Lacombe, Horden, Bell, Watkins, Evans, Young, &c.; Lacombe, <i>Dict. de la langue des Cris</i> (1876); Russell, <i>Explor. in the Fur North</i> (1869); Stewart, <i>Ann. Arch. Rep. Ontario</i> , 1905; Maclean, <i>Canad. Sav. Folk</i> (1890).
CREEK.	Muskogian.	11,000 in Oklahoma.	Large element of white blood; some negro.	American citizens, making good progress. Various religious faiths.	Gatschet, <i>Migration Legend of the Creeks</i> (1884-1888); Speck, <i>Mem. Amer. Anthropol. Assoc.</i> , 1907.
CROWS (Absaroka).	Siouan.	2804 at Crow Agency, Montana.	Little.	Improving industrially and financially. Morals still bad.	Simms, <i>Publ. Field Colum. Mus.</i> , 1903; Schultz, <i>My Life as an Indian</i> (N.Y., 1907).
DAKOTA (Santee, Yankton, Teton-Sioux).	Siouan.	About 18,000 in South and 4,000 in North Dakota; 3,000 in Montana; 500 in Minnesota. Seemingly decreasing.	Considerable white blood, varying with different sections.	Capable of and making good progress. Episcopal, Catholic, Congregational missions with good results.	Writings of Dorsey, Riggs, Eastman, &c.; Kapps, <i>Contrib. N. Amer. Ethnol.</i> , vol. vii, 1890, and vol. ix, 1893; Wadler, <i>Journ. Amer. Folk-Lore</i> , 1907; Eastman, <i>Indian Boyhood</i> (1902).
DELAWARE.	Algonkian.	In Oklahoma, 800 with Cherokee and 90 with Wichita; 164 with Six Nations in Ontario.	Considerable.	Oklahoma, Delaware, U.S. citizens, and progressing; Canadians making also good progress.	Brinton, <i>Lenape and their Legends</i> (Phila., 1885), and <i>Essays of an Americanist</i> (1890); Nelson, <i>Indians of New Jersey</i> (1894).
DOG-RIMS.	Athabaskan.	About 1000 in the region E. of the Hares, to Back river, N.W. Canada.	Little.	"Wild and indolent," not yet much under white influence.	See Chipewyans, Carriers.
EKIMO (Greenland).	Eskimoan.	West coast, 10,500; East coast, 500. Slowly increasing.	Large element of white blood, estimated already in 1855 at 30%.	More or less "civilized" and "Christian" as result of Moravian missions.	Writings of Rink, Holm, Nansen, Penny, Rink, <i>Tales and Trad. of the Eskimo</i> (Lond., 1873) and <i>Eskimo Eskimo</i> (1887); Nansen, <i>Eskimo Life</i> (1893); Thalbitzer, <i>Eskimo Language</i> (1904).
EKIMO (Labrador).	Eskimoan.	About 1300.	Considerable on S.E. coast.	Much improvement due to Moravian and (later) other Protestant missions.	Pockard, <i>Amer. Naturalist</i> , 1848; Turner, 12th Ann. Rep. Bur. Ethnol., 1889-1890.

Tribe.	Stock.	Situation, Population, &c.	Degree of Intermixture.	Condition, Progress, &c.	Authorities.
ESKIMO (Central regions).	Eskimoan.	About 2500.	Little.	Not much improvement except here and there—some reached by Episcopalian mission.	Bous, 6th Ann. Rep. Bur. Ethnol., 1884-1885, and Bull. Amer. Nat. Hist., 1901 and 1908.
ESKIMO (Mackenzie, &c.).	Eskimoan.	About 1500.	Little.	Not much improvement. Reached by Catholic missions.	Pottot, <i>Les Grands Esquimaux</i> (1887); <i>Monographie des Esquimaux Tchiglit</i> (Paris, 1876) and other writings; Stefansson, <i>Harper's Magazine</i> , 1908-1909.
ESKIMO (Alaska).	Eskimoan.	About 12,000, exclusive of Aleuts.	Considerable on certain parts of coast.	Much improvement in parts since introduction of reindeer in 1892. Presbyterian, Methodist, Catholic, Moravian, Baptist, Swedish Evangelical, Quaker, Congregational, Lutheran missions now at work.	Dall, <i>Contrib. N. Amer. Ethnol.</i> , vol. 1, 1887; Murdock, <i>6th Ann. Rep. Bur. Ethnol.</i> , 1887-1888; and Nelson, 18th Rep., 1896-1897; Barnum, <i>Innuits Gromm. and Dist.</i> (1907).
ESKIMO (N.E. Asia).	Eskimoan.	About 1900.	Little.	Little improvement.	Hooper, <i>Tents of the Tusk</i> (1853); Dall, <i>Amer. Naturalist</i> (1881). See Eskimo (Alaska).
FLATHEADS.	Salishan.	615 at Flathead Agency, Montana.	Considerable.	Continued improvement. Catholic missions.	McDermott, <i>Journ. Amer. Folk-Lore</i> , 1901; Ronan, <i>Flathead Indians</i> (1890).
GOSWUTE.	Shoshonian.	About 300 in Utah.	Little.	Some improvement in last few years.	Chamberlin, <i>Proc. Acad. Nat. Sci. Phila.</i> , 1908. See Paiute, Ute.
GROSVENTRES (ASIN).	Algonkian.	538 at Ft. Belknap Agency, Montana.	Little.	Low-abiding, industrious and fast becoming more mixed. Catholic, chief mission influence, also Presbyterian.	Kroeger, <i>Anthrop. Pap. Amer. Mus. Nat. Hist.</i> , 1907-1908.
HAIDA.	Haidan.	About 600 on Queen Charlotte Is. and 300 in Alaska. Decreasing.	Some little.	Now "gradually advancing along the lines of civilization." Mission influences Methodists and Anglicans, with much success, especially former.	Swanton, <i>Contrib. to Ethnol. of the Haida</i> (1905) and other writings; Bous, <i>Rep. Br. Assoc. Adv. Sci.</i> , 1881; Newcombe, <i>Congr. Intern. des Amer.</i> (Quebec, 1906).
HANUKT'QIN.	Athabaskan.	About 400 on the Yukon, above the Kotlo, in Alaska.	Little, if any.	Not yet much under white or missionary influence.	See Babine.
HARES.	Athabaskan.	About 600 W. of Gt. Bear Lake to Eskimo country, in N.W. Canada.	Little.	"Wild and indolent," with little improvement. Reached by Catholic missions.	See Babines, Carriers, Chipewyan.
HAVASUPAL.	Yuman.	166 N. of Prescott in N.W. Arizona. Decreasing.	Little.	"Good workers"; not yet distinctly under mission influence.	James, <i>Indians of the Painted Desert Region</i> (Boston, 1903); Dorsey, <i>Indians of the South-west</i> (1903).
HIDATSA.	Siouan.	467 near Ft. Berthold, N. Dakota.	Little.	Making good progress. Congregational and Catholic missions.	Matthews, <i>Ethnogr. and Philol. of the Hidatsa</i> (1877); McGee, 25th Ann. Rep. Bur. Ethnol., 1892-1894; Peppel and Wilson, <i>Mem. Amer. Anthrop. Assoc.</i> , 1908.
HUPA.	Athabaskan.	429 in Hoopa Valley, N.E. California.	Little.	Self-supporting by agriculture and stock-raising. Presbyterian and Episcopal missions with good results.	Goddard, <i>Life and Culture of the Hupa</i> (1903); Hupa Texts (1904), and other writings.
HURONS OF LOREITE.	Iroquoian.	466 at Lorette, near the city of Quebec. Increasing, but losing somewhat by emigration.	No pure-bloods left.	Practically civilized. All Catholics, except one Anglican and six Presbyterians.	Gérin, <i>Rep. Brit. Assoc. Adv. Sci.</i> , 1900.
IOWA.	Siouan.	246 in Kansas; 88 in Oklahoma. Holding their own.	Considerable.	In 1906 "accomplished more on their allotments than at any time heretofore." One regular missionary.	Dorsey, <i>Trans. Anthropol. Soc. Wash.</i> , 1883, and 15th Ann. Rep. Bur. Ethnol., 1893-1894; also 11th Rep.
IROQUOIS (of Caughnawaga).	Iroquoian.	2072 at Caughnawaga, in S.W. Quebec (largely Mohawk). Increasing.	Few, if any, pure-bloods left.	Practically civilized and making fair progress. Chiefly Catholics, but there is a Methodist school.	<i>Ann. Rep. Dept. Ind. Aff. Canada</i> , 1907.
IROQUOIS (of Lake of Two Mountains).	Iroquoian.	395 at Lake of Two Mountains, Quebec.	Few, if any, pure-bloods left.	Practically civilized and making fair progress. Catholics and Methodists represented.	Cuoq, <i>Lexique de la langue iroquoise</i> (1882), and other writings.
IROQUOIS (of St Régis).	Iroquoian.	1249 at St Régis, Quebec; 1208 at St Regs, New York.	Few pure-bloods left.	Practically all civilized and making fair progress.	<i>Ann. Rep. Dept. Ind. Aff. Canada</i> , 1907.
IROQUOIS (of Watha).	Iroquoian.	About 65 at Watha (formerly Githwan), near the southern end of Lake Muskoka, Ontario.	Considerable.	Industrious and progressive. Influence of Methodist mission.	<i>Ann. Rep. Dept. Ind. Aff. Canada</i> , 1907.
IROQUOIS (of St Albert).	Iroquoian.	94 near St Albert, Alberta ("Michel's band").	"Indians only in name," no pure-bloods left.	Practically civilized; outlook promising. Catholics.	Chamberlain, <i>Amer. Anthrop.</i> , 1904.
JICARELLA (Apache).	Athabaskan.	784 in New Mexico. Decreasing.	Little.	Improvement during past few years.	Mooney, <i>Amer. Anthrop.</i> , 1898. See Apache.
KAIABAB.	Shoshonian.	About 100 in S.W. Utah. Decreasing.	Little.	"Destitute," but gaining somewhat.	See Paiute, Ute.
KAGGANI.	Haidan.	About 300 in S. Alaska.	See Haida.	See Haida.	See Haida.
KAYUKIKROTENSE.	Athabaskan.	About 1500 on the Yukon (between the Avvik and Koyukuk) in W. Alaska.	Little.	Up to the present influenced more by the Eskimo than by the whites.	See Babine, Carriers. (Also Chapman, 1906).
KALAPOOIA.	Kalapuyan.	About 125 at Grande Ronde, Oregon, and a few also on the Siletz Reservation.	Not much.	Continued improvement.	Powell, 7th Ann. Rep. Bur. Ethnol., 1883-1886; Gatschet, <i>Journ. Amer. Folk-Lore</i> , 1899; Lewis, <i>Mem. Amer. Anthrop. Assoc.</i> , 1906.
KALISPEE (Paiute d'Oreille).	Salishan.	826 on the Flathead Reservation, Montana; 98 at Colville Agency, Washington.	Considerable.	Continued improvement. Catholic missions.	Giorda, <i>Kalispea Dictionary</i> (1877-1879). See Chehalis.

Tribes	Stock	Situation, Population, &c.	Degree of Intermixture.	Condition, Progress, &c.	Authorities.
KASSA (Kaw)	Siouan.	207 in Oklahoma.	About half are mixed blood.	American citizens, making fair progress.	Dorsey, 17th Ann. Rep. Bur. Ethnol., 1889-1890, and 15th Rep. Bur. Ethnol., 1893-1894; Hav, <i>Trans. Kans. State Hist. Soc.</i> , 1909.
KICKAPOO	Algonkian.	188 in Kansas; 204 in Oklahoma; about 400 in Mexico.	Considerable.	Progress hampered by liquor, &c.	Mooney, 14th Ann. Rep. Bur. Ethnol., 1892-1893; Lutz, <i>Trans. Kansas Hist. Soc.</i> , 1900.
KAWIA (Chibchian)	Shoshonian.	About 150 in southern California.	Little.	Progress good. Nominally Catholics, result of Californian missions.	Bartons, <i>Ethnobotany of the Coachella Indians</i> (1902); Kroeber, <i>Ethnography of the Chibchian</i> (1906).
KIOWA.	Kiowan.	1219 in Oklahoma.	Some white blood from captives, &c.	Citizens of the U.S., making fair progress. Catholic, Methodist, Presbyterian, &c., mission influences.	Mooney, 14th Ann. Rep. Bur. Ethnol., 1892-1893, and 17th Rep., 1895-1896.
KITKIAN.	Tsimshian.	About 1100 on upper Skeena river in central British Columbia.	Little.	Making good progress.	See Tsimshian.
KLAMATH.	Lutunian.	764 at Klamath Agency, Oregon.	Little.	Mostly self-supporting. Methodist mission, but poor work done.	Gatschet, <i>The Klamath Indians</i> (Washington, 1892); Dorsey, <i>Amer. Anthrop.</i> , 1901.
KUPENAT.	Shapitian.	About 300 merged with Yakima and other tribes on Yakima Reservation, Washington.	Considerable.	Late reports indicate much bad influence of whites.	Lyman, <i>Proc. Amer. Anth. Soc.</i> , 1904; Lewis, <i>Mem. Amer. Anthrop. Soc.</i> , 1909.
KONKAT (Concom)	Pujunan.	172 at Round Valley, California.	Little.	Gradually improving.	See Malda.
KOOTENAY.	Kitunshian.	In S. E. British Columbia; 220 at St. Mary's; 50 at Tobacco Plains; 82 at Columbia Lakes; 170, lower Kootenay - At Flathead Agency, Montana, etc. Holding their own, or increasing.	A little French and English.	Good, especially upper Kootenay; continued progress. Kootenay in U.S. not so progressive. Catholic missions with good results.	Boas, <i>Rep. Brit. Assoc. Adv. Sci.</i> , 1889; Chumbarlin, <i>ibid.</i> , 1892 (and other writings); <i>Ann. Ark. Rep. Ontario</i> , 1902; Schullis, <i>My Life as an Indian</i> (N.Y., 1907).
KOYUKT-KHO-TENNE.	Athabaskan.	About 300 on the Koyukuk and Yukon above the Katiyukho-tenne in Alaska.	Little, if any.	Little progress noted.	See Bahines, Carriers, Chipewyan.
KWAKWITL.	Wakashian.	About 2000 in Vancouver Island and British Columbia. Decreasing.	Considerable in places.	Improvement recently. Anglican and Methodist missions—former counting 400; latter, 19 members; rest, "10000."	Boas, <i>Rep. Brit. Assoc. Adv. Sci.</i> , 1889, 1890, 1896, <i>Rep. U.S. Nat. Hist.</i> , 1892; and other writings; Boas and Hunt, <i>Mem. Amer. Mus. Nat. Hist.</i> , 1902.
LILLOOET (Stallumh).	Salishan.	About 900 in S.W. British Columbia, on Fraser river, Douglas and Lillooet Lakes, &c.	Considerable in places.	Getting along well generally. Catholic and Anglican missions.	Boas, <i>Ethnogr. Album</i> (N.Y., 1890); Hill-Tout, <i>Journ. Anth. Inst.</i> , 1905; Teti, <i>Mem. Amer. Mus. Nat. Hist.</i> , 1909.
LAMME.	Salishan.	218 at Tulalip Agency, Washington.	Considerable.	Suffering from white contact.	See Chehalis.
MALDA.	Pujunan.	In N. E. California. About 210 full-blood.	Not much.	Few and scattered.	Dixon, <i>Bull. Amer. Mus. Nat. Hist.</i> , 1902-1905; <i>Journ. Amer. Folk-Lore</i> , 1900-1907.
MARAH.	Wakashian.	400 on Makah, 25 on Ozette Reservation, Washington.	Considerable.	Progress good.	Swan, <i>The Indians of Cape Flattery</i> (Washington, 1879); Dorsey, <i>Amer. Anthrop.</i> , 1901.
MANDAN.	Siouan.	202 at Ft. Berthold, N. Dakota. Beginning to increase again.	Considerable.	Making some progress. Catholic and Protestant mission influences.	Will and Spindler, <i>The Mandans</i> (1906); Dorsey in 17th and 15th Reps. Bur. Ethnol.
MARICOPA.	Yuman.	342 at Pima Agency Arizona. Decreasing slightly.	No data.	Progress in 1906 excellent. Catholic mission school.	See Yuma.
MANSAGON (Swamp Cree)	Algonkian.	About 2500 in Manitoba, Keewatin, Saskatchewan.	Considerable in certain regions.	Generally law-abiding, but impatient; some making good progress.	Summs in <i>Journ. Amer. Folk-Lore</i> , 1900; Stewart in <i>Ann. Arch. Rep. Ontario</i> , 1905.
MASSET.	Haidan.	460 at Masset, Q. Charlotte Is.	See Haida.	See Haida.	See Haida.
MESQUIMILE.	Algonkian.	About 1600, of which 1364 under superintendency of Green Bay, Wisconsin.	Considerable.	Making gradual progress, with noticeable improvement in many respects. Catholic church has many members.	Hoffman in 14th Ann. Rep. Bur. Ethnol., 1892-1893.
MILAMI.	Algonkian.	129 in Oklahoma; 220 in Indiana, a few elsewhere; total about 400.	Considerable French blood, about 50%.	American citizens; intelligent, thrifty and progressive.	Pilling, <i>Bibl. of Algon. Lang.</i> (1891).
MIMAC.	Algonkian.	2112 in Nova Scotia, 288 in Prince Edward Island, 1000 in New Brunswick, 793 in Quebec.	Large element of French; some Scottish and English blood.	Progress good; not degenerating nor decreasing. All Catholics.	Writings of Dr S. T. Rand, especially <i>Mimac Legends</i> (1894); Pacifico and Prince, <i> Congr. Intern. des Amer. Querc.</i> , 1905; Leland, <i>Algonquin Legends</i> (1885); Leland and Prince, <i>Kinoshka</i> (1902).
MISSION INDIANS.	Yuman; Shoshonian.	About 3000 in S. California.	Considerable in some sections.	Self-supporting; some individuals remarkably able and industrious. Catholics nominally.	Writings of Miss C. G. du Bois, <i>Journ. Amer. Folk-Lore and Amer. Anthrop.</i> , 1900-1908, &c. See Kawi.
MISISSAGUA.	Algonkian.	At Alnwick, 249; at the river Credit, 207; Rice Lake, 90; Mud Lake, 109; Senago, 45. Increasing slightly.	Considerable.	Fairly good generally; some at the Credit very successful farmers, competing with whites. Methodist chiefly.	Chamberlain, <i>Journ. Amer. Folk-Lore</i> , 1888, and <i>Language of the Mississauga of Senago</i> (Phila., 1892); Barnham, <i>Ont. Hist. Soc. Pap. and Rec.</i> , 1905.
MOHOC.	Lutunian.	52 in Oklahoma, 229 on Klamath Reservation, Oregon. Apparently decreasing slowly, or holding their own.	Little.	Generally industrious and moral. Methodist mission.	Miller, <i>My Life Among the Modocs</i> (1873); Gatschet, <i>Amer. Anthrop.</i> , 1894. See Klamath.
MOHAVE.	Yuman.	About 1600 in Arizona.	Little.	Good; industrious but restless. Presbyterian and Church of the Nazarene missions.	Booke, <i>Journ. Amer. Folk-Lore</i> , 1889; Kroeber, <i>Amer. Anthrop.</i> , 1902. See Yuman.

Tribe	Stock.	Situation, Population, &c.	Degree of Intermixture	Condition, Progress, &c.	Authorities.
MOHAWK.	Iroquoian.	1762 with Six Nations, Grand river, Ont.; 1,250, Bay of Quinte, Ont., slight increase. The "Iroquois" at Caughnawaga, &c., are largely Mohawks.	Considerable English and French.	See Six Nations.	Forbes, <i>Congr. intern. d. Amér.</i> , Quebec, 1904; Brant-Sears, <i>Man</i> (London, 1904). See Six Nations.
MONTAGNAB.	Algonkian.	About 2000 in N.E. Quebec, N. shore of St Lawrence and St John, &c.	Large element of French blood.	At St John, "energetic, hard working and provident"; others suffering from liquor, &c. Catholic missions.	Chambers, <i>The Owananakis</i> (1866); Chamberlain, <i>Ann. Arch. Rep. Ontario</i> , 1901; David, <i>Congr. int. d. Amér.</i> , Quebec, 1906.
MOQU (Hopi).	Shoshonian.	About 2000 in N.E. Arizona.	Little.	Still "yagan," but "dry-farming" experts. At Oraibi two factions, progressives and conservatives, Memmonite mission.	Bourke, <i>Snake Dance Among the Hopis</i> (1884); Haugh, <i>Amer. Anthropol.</i> , 1903; Dorcey and Yoh, <i>Field Columbian Mus. Publ.</i> , 1901-1902. Also the numerous monographs of Dr. J. W. Fewkes in <i>Rep. Bur. Ethnol. Amer. Anthropol. Journ. Amer. Folk-Lore</i> , 1894-1928.
"MORAVIANS."	Algonkian.	520 on river Thames, Ontario, Canada.	Considerable.	Generally industrious and very law-abiding. All Methodists.	<i>Ann. Rep. Dept. Ind. Aff. Canada</i> , 1907.
MUSKIEE.	Algonkian.	118 on river Thames, Ontario, Canada; also a few with the Stockbridges in Wisconsin and the Chippewa in Kansas.	Considerable.	Fairly industrious; progress slow.	<i>Ann. Rep. Dept. Ind. Aff. Canada</i> , 1907.
NAHANÉ.	Athabaskan.	About 1000 in N.W. British Columbia, N. and S. of Stikton river, and E. to beyond the Rockies.	Not much.	Have suffered much from white contact Reached by Catholic missions from Stuart Lake.	Writings of Peitout, Morice, &c., especially the latter in <i>Trans. Canad. Inst.</i> , 1894, <i>Proc. Canad. Inst.</i> , 1899. See Carriers.
NASCAPEE.	Algonkian.	Some 2500 in N.E. Quebec, Labrador, &c.	Not very much.	Improvement not marked. Catholic mission influence.	Turner, <i>11th Ann. Rep. Bur. Ethnol.</i> , 1889-1892; Chamberlain, <i>Ann. Arch. Rep. Ontario</i> , 1905.
NAVAGO.	Athabaskan.	About 20,000 in Arizona and New Mexico, about 8000 in the latter state. Increasing in number.	Much Spanish (Mexican) blood.	Mission made remarkable progress racially and individually. Catholic, Presbyterian, &c., missions.	Writings of Dr. W. Matthews, especially <i>Native Legends</i> (Boston, 1897); <i>The Night Chant</i> (N.Y., 1902).
NEPELIM.	Salishan.	191 at Colville Agency, Washington.	Considerable.	Suffering from liquor and white contact.	See Chehalis.
NEZ PERCÉS.	Sahaptian.	83 at Colville Agency, Washington, 1834 under Ft. Lapwai superintendency, Idaho. Decreasing.	Amount uncertain.	Of a high intellectual type (seen in children); suffering much from disease and white contact. About 60% Catholics and 15% Presbyterians.	Packard, <i>Journ. Amer. Folk-Lore</i> , 1894; McBeth, <i>The Nez Percés since Lewis and Clark</i> (New York, 1908); Spinden, <i>Mem. Amer. Anthropol. Assoc.</i> , 1908.
NIPISSING.	Algonkian.	230 on Lake Nipissing, Ontario. Increasing.	Little.	Improving.	<i>Ann. Rep. Dept. Ind. Aff. Canada</i> , 1907.
NIPISSING (Algonquins).	Algonkian.	About 60 at Lake of Two Mountains, Quebec.	Considerable.	Little marked progress; but fairly industrious. Catholics.	Writings of Rev. J. A. Cuog, especially <i>Lesque algonquins</i> (Montreal, 1886); Lemoine, <i>Congr. inter. d. Amér.</i> , Quebec, 1906.
NISKA (Nasqa).	Tsimshian.	About 800 in Nass river region in W. British Columbia. Decreasing.	Little.	Making good progress.	Boas, <i>Rep. Brit. Assoc. Adv. Sci.</i> , 1895, 1896, and <i>Indians of the Saguenay</i> (Berlin, 1895). See Tsimshian.
NISQUALLI.	Salishan.	146 in W. Washington.	Considerable.	Suffering from white contact, liquor, &c.	Gibbs, <i>Contrib. N. Amer. Ethnol.</i> , vol. 1, 1877, and <i>Nisqualli Dictionary</i> , <i>ibid.</i>
NOOTKA.	Wakashan.	2133 (including Chayoquot) on Vancouver Island, B.C. Decreasing slowly.	Considerable.	Industrious and law-abiding; evil from white contact increasing. Catholic and Presbyterian missions.	Sproot, <i>Scenes and Studies of Savage Life</i> (1868); Boas, <i>Rep. Brit. Assoc.</i> , 1890, and <i>Indians of the Saguenay</i> (1895).
OKANAGAN.	Salishan.	824 in the Kamloops-Okanagan Agency, British Columbia; 527 on Colville Reservation, Washington.	Considerable.	Industrious and law-abiding. Catholic, and in Canada Catholic and Anglican churches largely represented.	Boas, <i>Rep. Brit. Assoc.</i> , 1889; Teit, <i>Mem. Amer. Mus. Nat. Hist.</i> , 1900.
OMAHA.	Siouan.	11,88 in Nebraska.	Much white blood.	Good progress in many respects; improvidence, &c., still causing trouble. Presbyterian mission.	Dorsey, <i>3rd Ann. Rep. Bur. Ethnol.</i> , 1887-1882, and <i>12th Rep.</i> , 1891-1893, and other writings. Also writings of Miss A. C. Fletcher. See Ponca.
ONEIDA.	Iroquoian.	727 on river Thames, Ontario, and 850 with Six Nations in Ontario; 2181 in Wisconsin; 286 in New York. Increasing.	Large element of white blood.	Canadian Oneidas all Delaware full citizens. All progressing excellently and self-supporting. U.S. Oneidas citizens.	Bloomfield, <i>The Oneidas</i> (N.Y., 1907). See Six Nations.
ONONDAGA.	Iroquoian.	350 with the Six Nations, Ontario; 553 in New York.	Large element of white blood.	Not so advanced in U.S. as Tuscarora.	Clark, <i>Onondaga</i> (Syracuse, 1849); writings of Beuchamp, de Cost Smith, M. R. Harrington, &c. See Six Nations.
OSAGE.	Siouan.	1924 in Oklahoma.	Very much white blood; half are mixed-bloods.	U.S. citizens and making good progress. Baptists and Catholics represented.	Dorsey (J. O.), <i>6th Ann. Rep. Bur. Ethnol.</i> , 1884-1885; Brewster, <i>Trans. Kans. Nat. Hist. Soc.</i> , 1906; Dorsey (G. A.), <i>Publ. Field Columbian Mus.</i> , 1904; Speck, <i>Trans. Arch. Dept. Univ. of Penn.</i> (Phila.), 1907.
OTO.	Siouan.	About 590 with the Missouri in Oklahoma.	Considerable.	Making good progress.	See Osage.
OTTAWA.	Algonkian.	About 750 on Manitowlin and Coburn Islands, Ontario; 2750 in Michigan; 197 in Oklahoma.	Considerable French and English blood.	Canadian Ottawa industrious and law-abiding, and many in the U.S. civilized as average whites, about them. Catholic and Protestant missions.	Blackbird, <i>Ottawa and Chippewa Indians</i> (1887). See <i>Pilling's Bibliography of the Algonkian Languages</i> , 1891.
PAIUTE.	Shoshonian.	6500 to 7000 chiefly in Nevada (about 600 in Utah; 350 in Arizona).	No data.	Peaceable, moral and industrious; "have steadily resisted the vices of civilization." Catholic and Protestant missions.	Mooney in <i>12th Ann. Rep. Bur. Ethnol.</i> , 1892-1893. See Ute.

Tribes.	Stock.	Situation, Population, &c.	Degree of Intermixture.	Condition, Progress, &c.	Authorities.
PANUNKEY.	Algonkian.	About 140 in King William county, Virginia.	All mixed-bloods; some negro mixture.	Fishermen and small farmers.	Pollard, <i>The Pamankey Indians of Virginia</i> (Washington, 1894).
PANAMINT.	Shoshonian.	About 100 in the Panamint Valley, S.E. California.	No data.	Stationary.	Coville, <i>Amer. Anthropol.</i> , 1892.
PAPAGO.	Piman.	4995 in Arizona; about 1000 in Mexico.	Little.	Making very good progress recently. Catholic mission.	McGee in Coville and MacDougal, <i>Det. bot. lab.</i> , 1902; Bandler, <i>Arch. Inst. Papers</i> , 1890. See Pima.
PASSAMAQUODDY.	Algonkian.	About 350 in Maine.	Considerable French and English.	With Penobscots have representative in Maine legislature.	Leland, <i>Algon. Leg. of New England</i> (Boston, 1885); Brown, <i>Trans. R. Soc. Canada</i> , 1889; Prince, <i>Proc. Amer. Philos. Soc.</i> , 1897; Leland and Prince, <i>Kulstap</i> (Boston, 1902).
PAWNEE.	Caddoan.	649 in Oklahoma. Decreasing.	Considerable.	Citizens of U.S. Special progress recently in agriculture. Methodist mission.	Writings of Dunbar, Grinnell, Dorsey, Fletcher, &c.; Grinnell, <i>Pawnee Hero-Stories</i> (1885); Dorsey, <i>Traditions of the Santa Fe</i> (Boston, 1904), and <i>Pawnee Mythology</i> (1906); Fletcher, 22nd Ann. Rep. Bur. Ethnol., 1900-1901.
PENOBSCOT.	Algonkian.	About 410 in Maine.	Considerable.	See Passamaquoddy.	See Passamaquoddy.
PEORIA.	Algonkian.	192 with Kaskaskia, Wea and Piankaskaw in Oklahoma.	No pure-bloods left.	American citizens and progressing well.	See Pilling, <i>Bibliography of the Algonquian Languages</i> (1891).
PIEGAN.	Algonkian.	482 near Macleod, Alberta; 2072 at Blackfoot Agency, Montana.	Considerable.	Improvement slow in Montana; in Alberta, "noticeable advance along all lines." Methodist and Anglican missions in Alberta.	See Blackfeet.
PIMA.	Shoshonian.	3536 in Arizona; more in Mexico. Increasing slightly.	Considerable.	Making good progress recently. Catholic and Protestant missions.	Russel, <i>Amer. Anthropol.</i> , 1903, <i>Journ. Field-Lore</i> , 1901, and 20th Ann. Rep. Bur. Ethnol., 1904-1905; Dorsey, <i>Indians of the Southwest</i> (1903); <i>Field-Lore</i> , <i>Amer. Anthropol.</i> , 1904; Kroeber, <i>Univ. Calif. Publ.</i> , 1907.
POMO.	Kulanapan.	About 1000 in N.E. California.	Little.	Progress good.	Barrett, <i>Ethnography of the Pomo</i> (1908).
PONCA.	Siouan.	570 in Oklahoma.	Considerable.	U.S. citizens, making good progress.	Dorsey (J. O.), <i>Cegaha Language</i> (1890), <i>Omaha and Ponka Letters</i> (1891), &c.; Dorsey (G. A.), <i>Field Columbian Mus. Publ.</i> , 1905; Ross, <i>Congr. Int. d. Amer.</i> , Quebec, 1906.
POTAWATOMI.	Algonkian.	179 on Walpole Island, Ontario; 1760 in Oklahoma.	Considerable.	Canadian Potawatomi are law-abiding and industrious. American Potawatomi citizens making progress.	See Pilling, <i>Bibliography of the Algonquian Languages</i> (1891).
PUEBLOS.	Keresan.	3990 in 6 pueblos in N. central New Mexico.	Larger element of white blood than other Pueblos Indians, but not great.	Majority nominally Catholics.	Writings of Bandler, Hodge, Lumis, Stevenson, &c. Stevenson, 17th Ann. Rep. Bur. Ethnol., 1889-1890; Dorsey, <i>Indians of the Southwest</i> (1903); Bandler, <i>Archaeol. Inst. Papers</i> , 1881, 1883, 1892.
PUEBLOS.	Shoshonian.	See Moqui.	See Moqui.	See Moqui.	See Moqui.
PUEBLOS.	Tanoan.	About 4300 in 12 pueblos in New Mexico.	Have not favoured intermixture. Amount little.	Nominally Catholics for most part. At San Juan notable evidences of thrift, less elsewhere.	Writings of Bandler, Lumis, Fowkes, &c. See Pueblos (Keresan) and Moqui.
PUEBLOS.	Zuni.	1500 in Western New Mexico.	Have not favoured white intermixture.	Practically all are "pagans." Substantial progress lately in several ways.	Bandler, <i>Journ. Amer. Ethnol. and Archaeol.</i> , 1892; Fowkes, <i>ibid.</i> , 1891; Stevenson, 16th Ann. Rep. Bur. Ethnol., 1883-1884, and 23rd Rep., 1901-1902; Cushing, 2nd Rep., 1880-1881, 4th Rep., 1882-1883, 13th Rep., 1891-1892, and <i>Zuni Folk-Tales</i> (N.Y., 1901), and other writings.
PUYALLUP.	Salishan.	486 at the Puyallup Agency, Washington.	Considerable.	Suffering from white contact; future not bright.	See Chehalis.
QUAPAW.	Siouan.	292 in Oklahoma.	Considerable.	Majority are intelligent, thrifty and progressive. Catholic missions.	Dorsey (J. O.), 11th Ann. Rep. Bur. Ethnol., 1889-1890, 13th Rep. 1891-1892, and other writings.
QUILEUTE.	Chemakuan.	532 at Neah Bay Agency, N.W. Washington.	Considerable.	Progress good.	See Clallam.
QUINAIETI.	Salishan.	142 at Puyallup Agency in N.W. Washington.	Considerable.	See Nisqualli.	Farrand, <i>Mem. Amer. Mus. Nat. Hist.</i> , 1902; Conard, <i>Open Court</i> , 1905.
SACS AND FOXES (Saké, &c.).	Algonkian.	343 in Iowa; 630 in Oklahoma; 90 in Kansas.	Considerable.	Continued improvement; conservative opposition less. Catholic missions.	Lashley, <i>Journ. Amer. Folk-Lore</i> , 1902; Jotey, <i>ibid.</i> , 1902, 25th Feb. <i>Field-Lore</i> (1907); Owen, <i>Folk-Lore of the Musquaki</i> (1904).
SANSPOL.	Salishan.	126 at Colville Agency, Washington.	Considerable.	Improving.	See Chehalis.
SARCEE.	Athabaskan.	205 S.W. of Calgary, Alberta.	More than many other tribes of this stock.	Making good material progress lately. Anglican mission.	Maclean, <i>Canad. Savage Folk</i> (1890); Goddard, <i>Lang.</i> , 1902, 25th Feb. <i>Field-Lore</i> , 1907; and Ann. Arch. Rep. Ontario, 1905; Simms, <i>Journ. Amer. Folk-Lore</i> , 1904.
SEKANÉ (Sikani).	Athabaskan.	About 450 on Finlay and Parsnip rivers and W. to forks of Tatta Lake in N. central British Columbia.	Little.	Not so progressive as Carriers &c. Reached by Catholic mission from Stuart Lake.	Morice, <i>Anthropol.</i> , 1906, 1907, and Ann. Arch. Rep. Ontario, 1905, and other writings. See Babine.

Tribes	Stock.	Situation, Population, &c.	Degree of Intermixture.	Condition, Progress, &c.	Authorities.
SEMINOLE.	Muskogian.	2332 in Oklahoma; 350 in Florida.	Much white and some negro blood.	Oklahoma Seminoles American citizens.	MacCauley, <i>5th Ann. Rep. Bur. Ethnol.</i> , 1887; <i>Co. Red Patriots</i> (1898). See Creek.
SENECA.	Iroquoian.	384 in Oklahoma; 2742 in New York; 215 with Six Nations, on Grand river, Ontario.	Considerable.	See Six Nations.	Sarborn, <i>Seneca Indians</i> (1862); Hulbard, <i>An Account of Sa-poo-yo-ya-ha, or Red Jacket and his People</i> (Albany, 1886). See Six Nations.
SHAWNEE.	Algonkian.	574 in Oklahoma.	Considerable.	Progress good. Catholic and Protestant missions.	See Pilling, <i>Bibl. of Algon. Lang.</i> (1891). Also Harvey, <i>Shawnee Indians</i> (1855).
SHOSHONEE.	Shoshonian.	About 1000 in Idaho; 242 in Nevada; 793 in Wyoming.	Amount of admixture not large.	Progress good in the last few years. Catholic and Protestant Episcopal missions.	Culin, <i>Bull. Free Mus. Sci. and Art</i> (Phila., 1901); Dorney, <i>Indians of the South-west</i> (1903). See Ute.
SHUSWAP (Seqwapamug).	Salishan.	About 1000 in the S. interior of British Columbia; also 52 within the Kootenay area at the Columbia Lakes.	Considerable in places.	Industrious and law-abiding. Catholic and Protestant missions.	Boas, <i>Rep. Brit. Assoc. Adv. Sci.</i> , 1890, and <i>Ethnogr. Album</i> (N.Y., 1900); Dawson, <i>Trans. Roy. Soc. Canada</i> , 1891; Boas, <i>Indianische Sagen</i> (1895).
SILETZ.	Indians of several stocks.	483 on Siletz Reservation, Oregon.	Considerable.	Progress good.	Dorsey, <i>Journ. Amer. Folk-Lore</i> , 1890, and <i>Amer. Anthrop.</i> , 1889.
SIX NATIONS (Canada).	Iroquoian.	On Grand River Reservation, Ontario; Cayuga, 1044; Mohawk, 1767; Oneida, 350; Onondaga, 350; Seneca, 215; Tuscarora, 297. Total, 4118.	Large admixture of white blood.	Generally capable and industrious, and steadily improving; many, both in U.S. and Canada, equal to whites. The Canadian Cayuga and Onondaga are "pagans." Many Christian faiths represented.	Boyle, <i>Ann. Arch. Rep. Ontario</i> , 1898 and 1901; Hale, <i>Iroquois Book of Rites</i> (Phila., 1883); Wilson, <i>Trans. Roy. Soc. Can.</i> , 1885. See also under tribal names.
SIX NATIONS (New York).	Iroquoian.	In New York State: Cayuga, 179; Oneida, 280; Onondaga, 553; Seneca, 2742; Tuscarora, 350. Total, 4116.	Large admixture of white blood.	Improvement varying with tribes; Tuscarora said to be best. Various religious faiths.	Bouchamp, <i>Bull. N.Y. State Mus.</i> , 1897-1907; <i>The Iroquois Trail</i> (1892), and other writings; Smith, <i>2nd Ann. Rep. Bur. Ethnol.</i> , 1886-1887; Hewitt, <i>21st Ann. Rep. Bur. Ethnol.</i> , 1899-1900, and other writings. See also under tribal names.
SKOMOC.	Salishan.	About 150 in the Howe Sd. and Burrard Inlet region of British Columbia.	Some Canadian-French admixture.	"Probably the most industrious and orderly band of Indians in the province." Catholic mission.	Hill-Tout, <i>Rep. Brit. Assoc. Adv. Sci.</i> , 1900; Boas, <i>ibid.</i> , 1894.
SLAVÉ.	Athabaskan.	About 1200 in the region W. of Ot. Bear Lake, from Ft. Simpson to Ft. Norman in N.W. Canada.	No certain data; but some admixture now going on.	No marked progress, but white influence being felt. Catholics and Episcopal missions.	Various writings of Pettit and Morice; <i>Ann. Arch. Anthrop.</i> , 1900-1907; Bompis, <i>Mackenzie River</i> (London, 1888); Bell, <i>Journ. Amer. Folk-Lore</i> , 1901.
SNAMUQ (Nanaimo).	Salishan.	About 160 on reserve near Nanaimo Harbour, B.C.	No data.	Making good progress recently. Catholic mission.	Boas, <i>Rep. Brit. Assoc. Adv. Sci.</i> , 1889, and <i>Amer. Anthrop.</i> , 1889.
SONGISH (Lkungen).	Salishan.	About 200 in S.E. Vancouver Island, B.C.	No data.	Industrious and mostly well-off. Catholic mission.	Boas, <i>Rep. Brit. Assoc. Adv. Sci.</i> , 1900; Hill-Tout, <i>Journ. Roy. Anthrop. Inst.</i> , 1907.
SPOKAN.	Salishan.	91 in Idaho; 133 in Montana; 434 in Washington.	Considerable.	Improving.	Writings of Rev. M. Eells. See Chells.
TALITAN.	Athabaskan.	220 in the N. Interior of British Columbia, at mouth of Talitan river.	Little.	Making good progress.	Teit, <i>Boas Anniv. Vol.</i> (N.Y., 1906).
TEN'A.	Athabaskan.	About 2000 on the Yukon, between Tanana and Koneserky in Alaska.	Little.	Not yet much influenced by whites. Catholic mission.	Jetté, <i>Congr. int. des Amér.</i> , 1906; <i>Man</i> , 1907; <i>Journ. Amér. Ind.</i> , 1907.
THOMPSON INDIAN (Nlakapanuk).	Salishan.	About 1770 in the Thompson river region, S. central British Columbia.	Not very much.	Making good progress. Catholic and Protestant missions.	Teit and Boas, <i>Mem. Amer. Mus. Nat. Hist.</i> , 1900; Teit, <i>Trad. of Thompson Inds.</i> (Boston, 1898); Hill-Tout, <i>Saich and Inds</i> (London, 1907).
TLINGIT.	Kotuschan.	About 2000 in S. Alaska.	Considerable in places.	Not marked generally. Greek Orthodox and other missions.	Krause, <i>Die Tlingit Indianer</i> (Berlin, 1885); Boas, <i>Indianische Sagen</i> (Berlin, 1905); Dogoras, <i>Amer. Anthrop.</i> , 1902; Swanton, <i>26th Ann. Rep. Bur. Amer. Ethnol.</i> , 1900-1901; Emmots, <i>Mem. Amer. Mus. Nat. Hist.</i> , 1903.
TONKAWA.	Tonkawan.	47 in Oklahoma.	No data.	"Contented and enjoying life."	Mooney, <i>Globas</i> , 1902.
TSMESHIAN (Proper).	Tsimshian.	About 2000 in northern British Columbia.	Not large.	Making good progress. Anglican and other missions.	Boas, <i>Rep. Brit. Assoc. Adv. Sci.</i> , 1889, and <i>Indianische Sagen</i> (Berlin, 1905); von der Schellenburg, <i>Die Tsimshian-Indianer</i> (1894); Wellcome, <i>Melakula</i> (1887).
TUSCARORA.	Iroquoian.	397 on Six Nation Reservation, Ontario; 150 with Six Nations, New York.	Considerable.	Making good progress in both Canada and New York.	See Six Nations.
TUTCHONEK'T'QIN.	Athabaskan.	About 1000 on the Yukon from Deer river to Ft. Selkirk, in Alaska.	Little.	Little progress.	See Babines, Carriers, Chipewyan.
UINTA UTE.	Shoshonian.	435 in Utah.	Little.	See Ute.	See Ute.
UMATELLA.	Sahaptian.	207 in Oregon.	Some.	Making progress. Catholic and Presbyterian missions.	See Nez Percés.
UNCOMPAGHEE UTE.	Shoshonian.	493 in Utah.	Little.	See Ute.	See Ute.
UTE.	Shoshonian.	845 in Colorado; 1245 in Utah.	Not much.	Some progress recently. Catholic and Protestant missions.	Culin, <i>Bull. Free Mus. Sci. and Art</i> (Phila., 1901); Kroeber, <i>Journ. Amer. Folk-Lore</i> , 1901, and <i>Amer. Anthrop.</i> , 1906.

Tribe.	Stock.	Situation, Population, &c.	Degree of intermixture.	Condition, Progress, &c.	Authorities.
WALAPA.	Yuman.	513 in Arizona. Decreasing.	Little.	Self-supporting, but poor morally.	James, <i>Indians of the Painted Desert Region</i> (Boston, 1909).
WALLAWALLA.	Sahaptian.	579 in Oregon.	Some.	Not so satisfactory recently, but progressing.	See Nez Percés.
WICHITA.	Caddoan.	441 in Oklahoma.	Probably considerable.	Citizens of U.S., making good progress. Catholic and Protestant missions.	Dorsey, <i>Mythology of the Wichita</i> (Washington, 1904) and other writings.
WENNERAGO.	Siouan.	1070 in Nebraska; 1285 in Wisconsin.	Considerable.	Many good citizens of U.S. and progressing. Suffering from liquor and the moral ban to some extent.	Thwaites, <i>Coll. State Hist. Soc. Wisconsin</i> , 1892; Fletcher, <i>Journ. Amer. Folk-Lore</i> , 1890; McGee, <i>15th Ann. Rep. Bur. Ethnol.</i> , 1893-1894.
WYANDOT.	Iroquoian.	385 in Oklahoma; 1 at Anderson, Ontario, Canada.	No pure-bloods left, hardly a half-blood.	More white than Indian.	Powell, <i>1st Ann. Rep. Bur. Ethnol.</i> , 1879-1880; Connelley, <i>Amer. Arch. Rep. Ontario</i> , 1905, and <i>Wyandot Folk-Lore</i> (Topeka, 1890); Merwin, <i>Trans. Kansas State Hist. Soc.</i> , 1906.
YAKIMA.	Sahaptian.	About 1500 in Washington.	Considerable.	Late reports indicate had influence of whites.	Pandey, <i>Gramm. and Dict. of Yakima</i> (1862); Lewis, <i>Mem. Amer. Anthropol.</i> , 1906, 1906.
YELLOWKNIVES.	Athabaskan.	About 500 N.E. of Great Slave Lake in N.W. Canada.	Not much.	No practical advance as yet.	Writings of Petot, Morice, &c. <i>Petit. Annu. du Grand-Lac des Esclaves</i> (1891), and <i>Monographie des Dindjé-Dindjé</i> (1876) See Carriers, Clapewyan.
YUMA.	Yuman.	807 at Fort Yuma Agency, California, and a few at San Carlos, Arizona.	Some Spanish (Mexican) blood.	Progress good. Catholic and Protestant missions.	Gatschet, <i>Zwölft. J. Ethnol.</i> (1893); Trimpel, <i>Oregon Monthly</i> , 1889; Dorsey, <i>Indians of the Snake-valley</i> (1903). See Mission Indians.
ZUÑI.	Zuñian.	See Pueblos.	Zuñian.	See Pueblos.	See Pueblos. (See Mission Indians)

From the tables it will be seen that the American Indians in some parts of North America are not decreasing, but either holding their own or even increasing; also that thousands of them are now to all intents and purposes the equals in wealth, thrift, industry and intelligence of the average white man and citizens with him in the same society. In certain regions of the continent small tribes have been annihilated in the course of wars with other Indians or with the whites, and others have been decimated by disease, famine, &c.; and over large areas the aboriginal population, according to some authorities, has vastly diminished. Thus Morice estimates that the Athabaskan population at present in Canada (about 20,000) is less than one-seventh of what it was a century or more ago; Hill-Tout thinks the Salishan tribes (c. 15,000) number not one-fifth of their population a hundred years ago, and equally great reductions are claimed for some other peoples of the North Pacific region; Kroeber thinks probable an Indian population in California of 150,000 before the arrival of the whites, as compared with but 15,000 now; by some the arid regions of the south-west are supposed to have sustained a very large population in earlier times; certain of the Plains tribes are known to have lost much in population since contact with the whites. But under better care and more favourable conditions generally some tribes seem to be taking on a new lease of life and are apparently beginning to thrive again. A considerable portion of the "disappearance" of the Indian is through amalgamation with the whites. Undoubtedly, in some parts of the country, exaggerated ideas prevalent in the early colonial period as to the numbers of the native population have interfered with a correct estimate of the aborigines past and present. Mooney thinks that the Cherokee "are probably about as numerous now as at any period in their history" (*Humb. Amer. Inds.*, 1907, pt. i. p. 247), and this is perhaps true also of some other tribes east of the Mississippi. Major J. W. Powell was of opinion that the Indian population north of Mexico is as large to-day as it was at the time of the discovery. This, however, is not the view of the majority of authorities. The total number of Indians in Canada (*Ann. Rep. Dept. Ind. Aff.*, 1907) for 1907 is given as 110,345, as compared with 109,594 for the previous year, not including the Micmac in Newfoundland and the Indians and Eskimo in that part of Labrador belonging to Newfoundland. In 1903 the figures were 108,233. The gain may be largely due to more careful enumeration of Indians in the less well-known parts of the country, but there is evidently no marked decrease going on, but rather a slight increase in

Ontario, Quebec, New Brunswick, &c. In the United States (exclusive of Alaska, which counts about 30,000) the Indian population (*Ann. Rep. Ind. Aff.*, 1906) is estimated at 107,289, not including the "Five Civilized Tribes," of whose numbers (94,292) some 65,000 can be reckoned as Indians—a total of 382,000. The figures of 107,289, according to the report, show an increase in population "due mainly to increase in number of Indians reported from California."

The financial condition of the Indians of the Dominion of Canada for the year ending March 31, 1907, is indicated in the following table:

	Total Amount of Real and Personal Property.	Total Income for the Year.
Ontario . . .	\$7,566,125	\$1,426,690
Quebec . . .	1,781,330	915,783
N. Brunswick . . .	189,701	109,892
N. Scotia . . .	151,949	76,603
P. E. I. . . . .	6,370	15,374
Manitoba . . .	2,102,044	348,966
B. Columbia . . .	7,475,719	1,501,456
Sask . . . . .	7,721,532	548,533
Alberta . . . . .	5,154,789	211,839
Total . . . . .	\$30,129,659	\$5,155,052

The total amounts earned during the year were: from agriculture, \$1,337,948; wages and miscellaneous industries, \$714,125; fishing, \$544,487; hunting and trapping, \$630,633. Of these hunting and trapping show a decided decrease over 1906. The Indian Trust Fund amounts to \$5,157,566.59. The total appropriation in connexion with the Indians of the Dominion for all purposes for the year 1906-1907 was \$1,055,010 and the actual expenditure some \$1,040,000 less. The total amount of sales of lands for the benefit of Indian tribes was \$422,086.13. The balance to the credit of the Indian savings account for the funding of the annuities and earnings of pupils at industrial schools, together with collections from Indians for purchase of cattle and for ranching expenses, was \$51,708.92. According to the *Report of the Commissioner of Indian Affairs* the total amount of trust funds held by the United States government for the Indians, in lieu of investment, amounted to \$36,352,950.97, yielding for 1906 interest at 4 and 5% of \$1,788,237.23. The total incomes of the various tribes from all sources for the year ending June 30, 1906, was \$6,557,554.39, including interest on trust funds, treaty agreement and obligations, gratuities, Indian money, proceeds of labour, &c.

While the general constitution of the American aborigines north of Mexico is such as to justify their designation as one "American race," whose nearest congener is to be found in

the "Mongolian race" of eastern Asia, &c., there is a wide range in variation within the American tribes with respect to particular physical characteristics. Some authorities, like Dr Hrdlička (*Handb. Amer. Inds. N. of Mex.*, 1907, pt. i. p. 53), separate the Eskimo from the "Indians," regarding them as "a distinct sub-race of the Mongolo-Malay," but this is hardly necessary if, with Boas (*Ann. Archaeol. Rep. Ontario*, 1905, p. 85), we "consider the inhabitants of north-eastern Asia and of America as a unit divided into a great many distinct types but belonging to one and the same of the large divisions of mankind." Upon the basis of differences in stature and general bodily conformation, colour of skin, texture and form of hair, shape of nose, face and head, &c., some twenty-one different physical "types" north of Mexico have been recognized.

Although the variation in stature, from the short people of Harrison Lake (average 1611 mm.) to the tall Sioux (average 1726 mm.), Eastern Chippewa (average 1723 mm.), Iroquois (average 1727 mm.), Omaha and Winnebago (average 1733 mm.) and other tribes of the Plains and the regions farther east, is considerable, the North American Indian, on the whole, may be termed a tall race. The stature of women averages among the tall tribes about 92%, and among the short tribes about 94% of that of the men.

The proportion of statures (adult males) above 1730 mm. in certain Indian tribes (Boas) is as follows: Apache and Navaho, 25.3; Arapaho, 45.9; Arikara, 15.2; British Columbia (coast), 28.8; British Columbia (interior), 16.4; California (south), 32.7; Cherokee (eastern), 21.0; Cherokee (western), 40.7; Cheyenne, 72.2; Chickasaw, 23.8; Chinook, 36.2; Choctaw, 32.6; Coahuila, 14.2; Comanche, 27.1; Cree, 33.4; Creek, 52.6; Crow, 51.3; Delaware, 41.1; Eskimo (Alaska), 5.9; Eskimo (Labrador), 0.0; Flathead, 18.9; Harrison Lake, B.C., 1.0; Hupa, 18.7; Iroquois, 52.1; Kiowa, 4.3; Klamath, 20.0; Kootenay, 26.0; Micmac and Abnaki, 35.7; Ojibwa (eastern), 42.7; Ojibwa (western), 42.7; Omaha and Winnebago, 54.9; Oregon (south), 5.1; Ottawa and Menominee, 30.6; Pawnee, 22.1; Pawnee, 39.0; Puget Sound and Makah, 6.5; Round Valley, Cal., 3.3; Sahaptin, 28.2; Shuswap, 15.9; Sioux, 50.8; Taos, 18.5; Ute, 12.4; Zuni and Moqui, 1.9.

Very notable is the percentage of tall statures among the Cheyenne, Creek, Iroquois, &c., the form of the head (skull) varies considerably among the Indian tribes north of Mexico, running from the dolichocephalic eastern Eskimo with a cephalic index of 71.3 on the skull to the brachycephalic Aleuts with 84.8. Several tribes practising deformation of the skull (mound-builders, Klamath, &c.) show much higher brachycephaly.

The percentage of cephalic indices above 84 (on the heads of living individuals) among certain Indian tribes (Boas) is as follows: Apache, 87.6; Arapaho, 5.9; Arikara, 24.6; Blackfoot, 6.2; Caddo, 47.2; Cherokee, 20.0; Cheyenne, 10.4; Chickasaw, 14.4; Comanche, 65.3; Cree, 4.9; Creek, 25.0; Crow, 12.0; Delaware 15.0; Eskimo, (Alaska), 10.6; Harrison Lake, B.C., 88.8; Iroquois, 52.4; Kiowa, 25.0; Kootenay, 19.1; Mandan, 4.5; Micmac and Abnaki, 7.0; Mohave, 86.5; Montagnais, 21.7; Moqui, 54.3; Navaho, 49.4; Ojibwa (eastern), 26.6; Ojibwa (western), 10.2; Omaha, 23.0; Oregon (south), 50.9; Osage, 79.1; Ottawa and Menominee, 24.7; Pawnee, 4.8; Pima, 9.6; Round Valley, Cal., 4.8; Sahaptin, 57.4; Shuswap, 59.9; Sioux, 9.6; Taos, 6.0; Ute, 8.9; Wichita, 96.0; Winnebago, 66.8; Zuni, 41.4.

The Apache, Mohave, Navaho, Osage, Sahaptin, Wichita and Winnebago practised skull-deformation, which accounts in part for their high figures. The brachycephalic tendency of the Caddo, Moqui, Shuswap and Zuni is marked; the Comanche, with an average cephalic index of 84.6 and the Harrison Lake people with one of 88.8, are noteworthy in this respect. As in the case of stature, so in the case of head-form, there seems to have been much mingling of types, especially in the Huron-Algonkian region, the Great Plains and the North Pacific coast.

The North American Indian may be described in general as brown-skinned (of various shades, with reddish tinge, sometimes dark and chocolate or almost black in colour) with black hair and eyes varying from hazel brown to dark brown. Under good conditions of food, &c., the Indian tends to be tall and mesocephalic as to head-form, and well-proportioned and symmetrical in body. The ideal Indian type can be met with among the youth of several different tribes (Plains Indians, Algonkians, Iroquoians, Muskogians and some of the tribes of the south-western United States). Beauty among the aborigines of America north of Mexico has been the subject

of brief studies by Dr R. W. Shufeldt and Dr A. Hrdlička (*Boas Anniv. Vol.*, New York, 1906, pp. 38-42).

The extent to which the red and white races have mixed their blood in various parts of North America is greater than is generally thought. The Eskimo of Greenland have intermarried with the Danes, and their kinsmen of Labrador with the English settlers and "summerers."

Race mixture.

The eastern Algonkian Indians in New England and Acadia have now considerable French, English and Scottish blood. Many of the Canadian Iroquois are more than half French, many of the Iroquois of New York half English. The Cherokee, an Iroquoian people of the Carolinas, have some admixture of Scottish and German blood, to which Mooney would attribute some, at least, of their remarkable progress. In the state of Oklahoma, which has absorbed the old "Indian Territory," the results of race-amalgamation are apparent in the large number of mixed bloods of all shades. In spite of the romance of Pocahontas, the intermarriages of the two races in the Virginian region seem not to have been very common or very important. Nor does there appear to have been much intermarriage between Spaniards and Indians in the south Atlantic region, though in Texas, &c., there was a good deal. In New France, in spite of the efforts of some recent Canadian-French writers to minimize the fact, intermixture between whites and Indians began early and continued to be extensive. In parts of New Brunswick, Quebec, Ontario, some of the northern American states and regions of the Canadian north-west, there are Indian villages and white settlements where hardly a single individual of absolutely pure blood can now be found. In the veins of some of the "Iroquois" of Caughnawaga and New York state to-day flows blood of the best colonial stock (Kice, Hill, Williams, Stacey, &c., captives adopted and married within the tribe). In the great Canadian north-west, and to a large extent also in the tier of American states to the south, the blood of the Indian, through the mingling of French, Scottish and English traders, trappers, employees of the great fur companies, pioneer settlers, &c., has entered largely and significantly into the life of the nation, the half-breed element playing a most important rôle in social, commercial and industrial development.

In 1879, besides those whose mixed blood had not been remembered and those who wished to forget it, there were, according to Dr Havard (*Rep. Smiths. Inst.*, 1870), at least 22,000 *métis* in the United States and 18,000 in Canada (*i.e.* in the north-west in each case). When the province of Manitoba entered the Canadian Confederation it numbered within its borders some 10,000 mixed-bloods, one of whom, John Norquay, afterwards became its premier. In the Columbia river region and British Columbia some intermixture has taken place, originating in the conditions due to the establishment of trading-posts, the circumstances of the early settlement of the country, &c.—this has been both French and English and Scottish. Farther north in Alaska the Russian occupation led to not a little intermixture, both with the Aleuts, &c., and the coast Indians. In some parts of the far north intermixture of the whites with the Athabaskans is just beginning. In Canada no prohibition of marriage between whites and Indians exists, but such unions are forbidden by law in the states of Arizona, Oregon, North Carolina and South Carolina.

A considerable number of the chiefs and able men of the various Indian tribes of certain regions in recent times have had more or less white blood—Iroquois, Algonkian, Siouan, &c.—who have sometimes worked with and sometimes against the whites. In the case of some tribes there have been "pure blood" and "mixed blood" factions. Some tribes have frowned upon miscegenation; even the Pueblos (except Laguna, which is Keresan) have never intermarried with the whites. Both in Canada and the United States strains of Indian blood run in the veins of prominent families. Some of the "first families of Virginia" are proud to descend from Pocahontas, the Algonkian "Princess," who married the Englishman Rolfe. In Maine may still be discovered perhaps those whose line of life goes back to the Baron de St Castains and his Abnaki bride, while in Ontario and New York are to be met those who trace their ancestry back to the famous Iroquois Joseph Brant and his half-English wife. In the early history of Pennsylvania and Ohio were noted the Montours, descendants of a French nobleman who about



1665 had a son and two daughters by a Huron woman in Canada. In 1817 Captain John S. Pierce, U.S.A., brother of President Franklin Pierce, married the fair Josette la Framboise, who had at least a quarter Indian (Ottawa) blood. In the latter part of the 18th century a young Irish gentleman married Neengai, daughter of the Michigan Ojibwa chief Waubojoc, and of the daughters born to them one married a Canadian Frenchman of reputation in the early development of the province of Ontario; another the Rev. Mr. McHenry, afterwards Episcopal archdeacon of Niagara, and a third Henry R. Schoolcraft, the ethnologist.

Several Indians, some full-blood, others with more or less white blood in their veins, have rendered signal service to ethnological science. These deserve special mention: Francis la Flèche, an Omaha, a graduate of the National University Law School, D.C., holding a position in the Office of Indian Affairs; Dr. William Jones, a Sac and Fox, in the service of the Field Museum, Chicago, a graduate of Harvard and of Columbia (Ph.D.); and J. N. B. Hewitt, a Tuscarora, ethnologist in the Bureau of American Ethnology, Washington, D.C. In some regions considerable intermixture between negroes and Indians (*Science*, New York, vol. xvii, 1891, pp. 85-90) has occurred, e.g. among the Mashpee and Gay Head Indians of Massachusetts, the remnants of the Pequots in Connecticut, the Shinnecocks and the Montauks, &c., of Long Island; the Pamunkeys, Mattaponies and some other small Virginian and Carolinian tribes. In earlier times some admixture of negro blood took place among the Seminoles, although now the remnants of that people still in Florida are much averse to miscegenation. Of the tribes of the Muskogian stock who kept large numbers of negro slaves the Creeks are said to have about one-third of their number of mixed Indian-negro blood. Sporadic intermixture of this sort is reported from the Shawnee, the Minnesota Chippewa, the Canadian Tuscarora, the Caddo, &c., in the case of the last the admixture may be considerable. It is also thought probable that many of the negroes of the whole lower Atlantic coast and Gulf region may have strains of Indian blood. The mythology and folk-lore of the negroes of this region may have borrowed not a little from the Indian, or as Mooney notes (*19th Rep. Bur. Amer. Ethnol.*, 1900, pp. 232-234), "in all the southern colonies Indian slaves were bought and sold and kept in servitude and worked in the fields side by side with negroes up to the time of the Revolution." When Dr. John R. Swanton visited the Haida recently the richest man among the Skidegate tribe was a negro. Some of the Plains tribes and some Indians of the far west, however, have taken a dislike to the negro. The leader in the Seminole Massacre of March 5, 1779, was Crispus Attucks of Framingham, Mass., the son of a white father and a Natick Indian mother. The physical anthropology of the white-Indian half-blood has been studied by Dr. Franz Boas (*Pop. Sci. Monthly*, New York, 1894).

The culture, arts and industries of the American aborigines exhibit marked correspondence to and dependence upon environment, varying with the natural conditions of land and water, wealth or poverty of the soil, abundance or scarcity of plant and animal life subsidiary to human existence, &c. Professor O. T. Mason (*Handb. of Amer. Inds. N. of Mexico*, 1907, pt. i. pp. 427-430; also *Rep. Smiths. Inst.*, 1895, and *Pop. Sci. Monthly*, 1902) recognizes north of Mexico twelve "ethnic environments," in each of which there is "an ensemble of qualities that impressed themselves on their inhabitants and differentiated them."

These twelve "ethnic environments" are:—

- (1) Arctic (Eskimo); (2) Yukon-Mackenzie (practically Athabaskan); (3) Great Lakes and St Lawrence (Algonkian-Iroquoian); (4) Atlantic Slope (Algonkian, Iroquoian, Siouan, &c.); (5) Gulf Coast, embracing region from Georgia to Texas (Muskogian and a number of smaller stocks); (6) Mississippi Valley (largely Algonkian and "mound-builders"); (7) Plains, including the country from the neighbourhood of the Rio Grande to beyond the Saskatchewan on the north, and from the Rocky Mountains to the fertile lands west of the Mississippi (Algonkian, Siouan, Shoshonian, Kiowan, Caddoan); (8) North Pacific Coast, from Mount St Elias to the mouth of the Columbia river (Klouschan, Haidan, Tsimshian, Wakashan, Salishan); (9) Columbia-Fraser region (Salishan, Sahapian, Chinookan, &c.); (10) Interior Basin between Rocky Mountains and Sierras (Shoshonian); (11) California-Oregon ("the Caucasus of North America," occupied by more than twenty-five linguistic stocks); (12) Pueblos region, basin of Rio Grande, Pecos, San Juan and Colorado (Pueblos-Keresan, Tanoan, Zuñian, &c.); on the outskirts predatory Shoshonian, Athabaskan tribes; to the south-west, Yuman, &c.).

In the Arctic environment the Eskimo have conquered a severe

and thankless climate by the invention and perfection of the snow-house, the dog-sled, the oil-lamp (creating and sustaining social life and making extensive migrations possible), the harpoon and the kayak or skin-boat (the acme of adaptation of individual skill to environmental demands). In the region of the Mackenzie especially the older and simpler culture of the Athabaskan stock has been much modified by the European "civilization" of the Hudson's Bay Company, &c., and elsewhere also by contact with Indian tribes of other stocks, for the Athabaskans everywhere have shown themselves very receptive and ready to adopt foreign elements of culture. The culture-type of the North Pacific coast, besides being unique in some respects, stands in certain relations to the culture of the Palaeo-Asiatic tribes of north-eastern Asia who belong properly with the American race. The culture of the Great Plains, which has been studied by Drs Wissler (*Congr. Intern. d. Amer.*, Quebec, 1906, vol. ii. pp. 39-52) and Kroeber (*Ibid.*, pp. 53-63), is marked by the presence of a decided uniformity in part of the existence within this area of several physical types and a number of distinct linguistic stocks. Here the tipi and the camp-circle figure largely in material culture; innumerable ceremonies and religious practices (e.g. the "sun-dance") occur and many societies and ceremonial organizations exist. The buffalo and later the horse have profoundly influenced the culture of this area, in which Athabaskan (Sarcee), Kitunahan, Algonkian, Siouan, Shoshonian, Kiowan tribes have shared. In some respects the Plains culture is quite recent and is marked by "the presence of a culture common to the Pueblos tribes and perhaps also to the ancestors of the civilized peoples of ancient Mexico. In some other respects the culture of this area is noteworthy. In the east also there are evidences of the influence of Arawakan culture from the West Indies. The Pueblos region has been the scene of the development of sedentary "village" life on the largest scale known in North America north of Mexico, and of arts, industries and religious ideas (rain-cult especially) corresponding, as Professor J. W. Fewkes (*Rep. Smiths. Inst.*, 1895, pp. 683-700) has shown, most remarkable to their environment. The arid interior basin is the characteristic area of the great Shoshonian stock, here seen at its lowest level, but advancing with the Piman and other Sonoran and Nahuatl tribes till in ancient Mexico it attained the civilization of the Aztecs. The California-Oregon area is remarkable for the multiplicity of its linguistic stocks and also for the development of many local culture-types. Within the limits of California alone Dr. Kroeber (*Univ. of Calif. Publ. Amer. Arch. and Ethnol.*, vol. ii., 1904, pp. 81-103) distinguishes at least four types of native culture.

On account of climatic conditions, in part at least, the development of agriculture in North America has not reached with many Indian tribes a high state of development, although its diffusion is much greater than is generally believed. In the south-eastern part of the United States beans, squashes, pumpkins and some other gourds and melons, potatoes, Indian corn, tobacco, a variety of the sunflower, &c., were cultivated, the growing of beans, squashes and pumpkins extending as far north as Massachusetts and the Iroquois country, in which latter also tobacco was cultivated, as the tribal name "Tobacco Nation" of the Tionontati indicates. The cultivation of Indian corn extended from Florida to beyond 50° N. and from the Atlantic to far beyond the Mississippi, and to judge from the varieties found in existence, must have been known to the Indians for a very long period. In the arid region of Arizona and New Mexico a special development of agriculture occurred, made possible by the extensive use of irrigation in pre-Columbian and in more recent times. Here Indian corn, melons, beans, cotton, &c., were raised, in which latter also tobacco was cultivated. As the Iroquois purposes the Zuffi appear to have selectively produced a great variety of colours in the ears of corn. Where women had much to do with agricultural operations they greatly influenced society and religious and mythological ideas. Hunting and fishing, as might be expected in an extensive and varied environment like the North American continent, exhibit a great range from simple individual hand-capture to combined efforts with traps and nets, such as the communal nets of the Eskimo, the buffalo and deer "drives" of the Plains and other Indians, which were often associated

brush-fences, corrals, "pounds," pitfalls, &c., advantage taken of a natural *cal-de-sac*, &c. A great variety of traps, snares, &c., was used (see Mason in *Amer. Anthropol.*, 1899) and the dog was also of great service with certain tribes, although no special variety of hunting-dogs (except in a few cases) appears to have been developed. The necessary implements for the chase (spear, bow and arrow, harpoon, club, and sling) showed great variation and specialization. The throwing stick appears in the north among the Eskimo tribes in the south-west among the Pueblos. In the Muskogean area the blow-gun is found, and its use extended also to some of the Iroquoian tribes (Cherokee, &c.). In part of this area vegetable poisons were used to capture fish. In the New England region torch-fishing at night was in vogue. With the tribes of the Great Plains in particular the hunt developed into a great social event, and often into a more or less marked ceremonial or religious institution, with its own appropriate preliminary and subsequential rites, songs, formulae, allusions, and fetiches, &c., as seen, for example, among certain tribes of the Caddoan stock in very interesting fashion.

The art of transportation and navigation among the American aborigines north of Mexico has received special treatment from Mason (*Rep. U.S. Nat. Mus.*, 1894) and Friederici, in his recent monograph *Die Schiffahrt der Indianer* (Stuttgart, 1907). On land some of the Indian tribes made use of the dog-sled and the toboggan in winter, while the dog-trains were early met with in the region of the Great Plains. The Eskimo made special use of the dog-sled, but never developed the sledging apparatus of the Arctic and the Athabaskan and Algonkian tribes; with the last and with the Iroquoian tribes came the perfection of the skin-shoe or moccasin. In the south and south-west appear sandals. In North America the cradle, as pointed out by Professor Mason (*Rep. U.S. Nat. Mus.*, 1894), has undergone great variation in response to environmental suggestion. No wheeled vehicle and no use of an animal other than the dog for means of transportation is known among the aborigines north of Mexico, men, women and children, women especially, having been the chief burden-bearers. Among the types of boats in use are the seal-skin *kayak* and *umiak* (woman's boat) of the Eskimo; the bull-boat or coracle (raw-hide over willow frame) of the Missouri and the buffalo-region; the dug-out of various forms and degrees of ornamentation in divers regions from Florida to the North Pacific coast; bark-canoes (birch, elm, pine, &c.) in the Algonkian, Iroquoian and Athabaskan areas, reaching a high development in the region of the Great Lakes; the peculiar bark-canoe of the Bechuks in the form of two half ellipses; the bark-canoes of the Kutchin, sometimes with the *Amur* in the north (near eastern Asia), noteworthy as having both ends pointed under water; the plank-canoes of the Santa Barbara region; the basketry-boats (*coritas*) of the lower Colorado and in south central California; the balsas of tule rushes, &c., in use on the lakes and streams of California and Nevada. In various parts of the country log-rafts of a more or less crude sort were in use. No regular sail is reported from North America, although from time to time skins, blankets, &c., were used by several tribes for such purposes.

Since the appearance of Morgan's monograph on the *Houses and House-life of the American Aborigines* (Washington, 1881) our knowledge of the subject has been materially increased by the studies and researches of Boas, Fowkes, Mindell, Dorsey, Matthews, Murdoch, Willoughby and others. The dwellings in use among the aborigines north of Mexico varied from the rude brush huts of the primitive Shoshonian tribes, and the still earlier caves, to the communal dwellings of the Iroquois and the Pueblos stocks of New Mexico and Arizona. The principal types are as follows:

Crude brush shelters and huts of the lower Shoshonian tribes, the Apache (more elaborate), &c.; the *kagan* or earth-lodge of the Navaho, and the earth-lodges of certain Caddoan and Siouan tribes farther north, with similar structures even among the Aleuts of Alaska; the grass-lodge of the Caddoan tribes, still in use among the Wichita; the semi-subterranean earth-covered lodges of parts of California, &c.; the roofed pits of various styles in use in the colder north, &c.; the Eskimo snow-house and wooden *karmak*; the elaborately carved and painted wooden houses of Pacific coast recent Florida, Florida, Nootka, &c., some of which were originally built on platforms and entered by log-ladders; the simple wooden house of northern California; the dome-shaped bark wigwams of the Winnebago and the conical ones of many of the Algonkian tribes; the skin tents or tipis of many of the Plains peoples; the mat tents of the Nez Percé, Kootenay, &c., and the mat houses of the South Atlantic region; the circular wigwam of bark or mats banked up at the base, of the Ohio-Mississippi valley; the palmetto-house of certain Louisiana Indians; the pile-dwellings of the recent Florida Indians; the dome-shaped houses of divers types were found among the Mohegans, Iroquois, &c., but are especially illustrated by the so-called *peublos* of the south-western United States, out of which grew probably the elaborate structures of ancient Mexico. Some tribes appear to have had simple and ruder summer dwellings and more elaborate or better constructed winter houses. The Eskimo have sometimes temporary hunting-lodges; the Comanches brush-shelters for summer and lodges of buffalo-skin for winter; with some tribes temporary dwellings were erected for the use of winter cultivating the land. Many tribes had their "village-houses" for social purposes, like the *kashim* of the Eskimo. Special tipis or

houses for shamans, "medicine-men," &c., were common in many parts of North America. Secret societies had their own lodges and the so-called "men's-house." The houses of the North American Indians are the subject of a monograph by E. Sarfert (*Arch. f. Anthr.*, 1908, pp. 119-215).

The art of fire-making was known to all the aborigines north of Mexico, two methods of fire being widespread, that with flint and pyrites and that of the reciprocating motion of wood on wood. For the latter several varieties of apparatus were in use, the simple two-stick apparatus was very common; the Eskimo have a four-part fire-drill and the Iroquois a weighted drill with spindle whorl. The skill displayed in fire-making by some Indians is very great, and the individual parts of the apparatus have in certain regions been highly specialized. The subject of fire-making apparatus and the kindred topic of illumination have been specially treated by Dr. Walter Hough, 1907-1902. The camp-fire, the torch and the Eskimo lamp represent the employment of fire for artificial light among the aborigines. Fire and smoke were used for signalling by the Plains tribes, &c., and fire-ceremonies form an important part ("new-fire," "fire-dance") of the ritual observances of not a few peoples, especially in the region from Florida to the Rio Grande. In metal-working there is up to the present no convincing evidence of the use of fire (heat only being employed to facilitate the cold-hammering processes) by which the metals, copper, silver, gold and iron were manufactured and fashioned into weapons, ornaments, and articles of luxury north of Mexico. The tools used were few and the processes simple, as Cushing (*Amer. Anthropol.*, vol. vii, 1894) has proved by actual experiment. The only metal actually mined in large quantities was copper in the region of Lake Superior, whence came most of that employed in the east and south. In Alaska was a source of copper for the North Pacific coast. No special process of hardening copper other than by hammering was known to the Indians. The gold objects of most interest come from mounds in Florida and a few also from those in the Ohio valley. Galena was used to make simple ceremonial objects by the Indians of the Mississippi valley and the "mound-builders."

The art of sculpture in wood, stone, bone and ivory is best represented by the wooden masks, utensils, house-carvings and totem-poles of the Indians of the North Pacific coast, the stone pipes, ornaments and images of various sorts of the "mound-builders" and other Indians of the Mississippi valley, the carvings of the people of the Floridian pile-dwellings, and the remarkable work of the Eskimo, sometimes in ivory. Eskimo work in stone are the slate-sculpture of the Haida, and the work in bone, ivory and deer and mountain goat horn of the British Columbian Indians. The Indians of the region south of the Great Lakes were expert in the manufacture of tobacco-pipes of great variety, among the most interesting being the Catlinite pipes of the Sioux of Minnesota, &c. Soapstone served some of the Eskimo to make lamps and some Indian tribes for other purposes. Pottery appears to have been unknown in certain regions, but flourished remarkably in the Mississippi valley and the Pueblos region of the south-west, where specialization in form and decoration occurred, and ceramic objects of all sorts were manufactured in abundance. The pottery of the Iroquoian and Algonkian tribes of the north-east, was, as a rule, rather crude and undeveloped. In many places the relation of ceramic art to basketry is in evidence. Basketry, of which Professor O. T. Mason has recently made a detailed study in his *Aboriginal American Basketry* (Washington and New York, 1902, 1904), and related arts were carried on (especially by women) with great industry in form, decoration, material, &c., over a large portion of the continent. In North American basketry is "the primitive art," and here "the Indian women have left the best witness of what they could do in handiwork and expression." The most exquisite and artistic basketry in the world comes from an utterly uncivilized tribe in California. The relation of basketry to symbolism and religion is best observable among the Hopi or Moqui of Arizona. The appreciation of white men for the products of Indian skill and genius in basketry finds full expression in G. W. James's *Indian Basketry* (1906). Weaving is exemplified in the goat's hair by the Chilkat Indians (Kootenay) of Alaska, and similar products; also in the manufactures of buffalo-hair, &c., of the Indians of the Great Plains and Mississippi valley and the textile art of a higher type known to the Pueblos tribes and by some of them taught to the Navaho. Famous are the "Navaho blankets," less so the "Chilkat."

Feather-work and the utilization of bird-skins and feathers for dresses, hats, ornaments, &c., are known from many parts of the continent. In the Arctic regions bird-skins with the feathers on were used. So were dresses; the Algonkian tribes of Virginia, &c., had their bird-skin blankets and "turkey robes"; the tribes of the North Pacific coast used feathers for decorative purposes of many kinds, as did Indians in other regions also; feather head-dresses and ornaments were much in use among the Plains tribes, &c.; with the Pueblos Indians eagle and turkey feathers were important in ritual and ceremony; some of the tribes of the south-east made fans of turkey feathers. Beads made from various sorts of shell, rolled copper ("mound-builders," &c.), seeds, ivory (Eskimo) and the teeth of various animals are pre-Columbian, like the turquoise-beads of the Pueblos, and they were put to a great variety

of uses. Wampum was manufactured by many Algonkian and Iroquoian tribes, who also later produced fine specimens of work with the glass beads introduced by the whites. These glass beads made their way over most of the continent, soon driving out in many sections the older art in shell, &c. European-made wampum-beads affected native art in the 17th century. In the regions where the precious materials of the quills were used for purposes of ornamentation on articles of dress objects of barter, &c., some of the Algonkian and Iroquoian tribes producing beautiful work of this sort.

Besides face and body painting, employed for various purposes and widespread over the continent, particularly in ceremonial observances, during war-time, in courting, mourning, &c., painting found expression among the North American aborigines most fully in the products of the wood art of the Indians of the North Pacific coast (masks, utensils, houses, totem-poles, furniture, &c.), in the Pacific West, ceremonial and symbolic paintings on skins, (tip-covers and the like of some of the Plains tribes (e.g. Kiowa, Sioux) and in ceramic art, notably in the remarkable polychrome pottery of the Pueblos tribes. Among several Pueblos tribes of Arizona and New Mexico (also the Navaho and Apache and of a ruder sort among some of the Plains tribes, e.g. Cheyenne, Arapaho, Black-foot) "dry-painting," most highly developed in the sacred ceremonies of the Navaho, is practised and is evidently of great antiquity. The pictures of deities, natural phenomena, animals and plants are made of powdered sandstone of various colours.

Pictography among the aborigines north of Mexico varied from the rude petroglyphs of some of the Shoshonian tribes to the incised work on ivory, &c., of the Eskimo and the paintings on buffalo and other animal skins by some of the Plains tribes, the work of the Pueblos Indians, &c., the nearest approach to hieroglyphics in North America outside of Mexico. Some Indian tribes (e.g. the Kootenay) seem not at all given to pictography, while many others have practised it to an almost limitless extent. The pictography and picture-writing of the North American Indians have been the subject of two detailed monographs by Mallory (*4th Ann. Rep. Bur. Ethnol.*, 1882-1883, pp. 3-256; *10th Rep.*, 1888-1889, pp. 1-1290), and the graphic art of the Eskimo has received special treatment by Hoffman (*Rep. U.S. Nat. Mus.*, 1895). Some have argued that this ivory pictography of the Eskimo is of recent origin and due practically to the introduction of iron by the whites, but Boas thinks such a theory refuted by the resemblance of the Eskimo graphic art in question to the birch-bark art of the neighbouring Indian tribes. The real "hieroglyphic" system, which is of an alphabetic nature, have been discovered north of Mexico; the alleged specimens of such, turning up year to year, are frauds of one sort or another.

The music and song of the American Indians north of Mexico have been studied since the time of Baker (*Über die Musik der Nordamerikanischen Wilden*, Leipzig, 1882) by Boas, Fillmore, Curtis, Fletcher, Stumpf, Cringan (*Ann. Arch. Rep. Ont.*, 1902, 1905), &c. According to Miss Fletcher (*Indian Story and Song*, 1900; also *Pac. Mus.*, 1893), "among the Indians music envelops like an atmosphere every religious tribal and social ceremony as well as every personal experience, and "there is not a phase of life that does not find expression in song"; music, too, is "the medium through which man holds communion with his soul and with the unseen powers which control his destiny." Music, in fact, "is coextensive with tribal life," and "every public ceremony as well as each important act in the career of an individual has its accompaniment of music." Moreover, "The music of each ceremony has its peculiar character, so also have the classes of songs which exist in each act: fasting and prayer, sending of traps, hunting, courting, playing of games, facing and defying death." In structure the Indian song "follows the outline of the form which obtains in our own music," and "the compass of songs varies from 1 to 3 octaves." Among some of the tribes with highly developed ceremonial observances "men and women, having clear resonant voices and good musical intonation, compose the choirs which lead the singing in ceremonies and are paid for the services." A peculiar development of music among the Indians has been seen in the "birth-songs," by which controversies are settled, the parties to the dispute "singing at" each other till the public laughter, &c., proclaim one the victor. Among the American Indians songs belonging to individuals, societies, clans, &c., are met with, which have to be purchased by others from the owners, and even slight mistakes in the rendition of singing, dancing, &c., are heavily penalized. Musical contests were also known (e.g. among the Indians of the Pacific coast). The development of the "tribal song" among the Iroquoian peoples is seen in Hale's *Indes* (*Bureau Ethnol.* 1881) and songs having words, but merely "changeless" vocables are common. Dr. Boas has pointed out, the genius of the American Indians has been devoted more to the production of songs than to the invention of musical instruments. The musical instruments known to the aborigines north of Mexico, before contact with the whites, according to Miss Fletcher (*Handb. of Amer. Inds.*, 1907, pt. i. p. 960), were drums of great variety in size and form, from the plank or box of some of the tribes of the North Pacific coast to the shaman's drums of the Algonkian and Iroquoian peoples; whistles of bone, wood, pottery, &c. often employed in ceremonies to imitate the voices of birds,

animals and spirits); flageolet or flute (widely distributed and used by young men in courtship among the Siouan tribes); the musical bow (found among the Maidu of California and important in religion and sorcery). Rattles of gourd, skin, shell, wood, &c., are universal, and among some of the tribes of the south-west "notched sticks are rasped together or on gourds, bones or baskets to accentuate rhythm." From the rattle in the Pueblos region developed a sort of bow-play or that of the Eskimo.

So far as is known, the primitive culture of the aborigines of North America is fundamentally indigenous, being the reactions of the Indian to his environment, added to whatever rude equipment of body and of mind was possessed by the human beings who at some remote epoch reached the new world from the old, if, indeed, America was not, as Ameghino, on the basis of the discoveries of fossil anthropoids and fossil man in southern South America, maintains, the scene of origin of man himself.

Professor A. H. Keane (*Internat. Monthly*, vol. v., 1902, pp. 338-357), Stewart Culin (*Proc. Amer. Assoc. Adv. Sci.* vol. lii., 1903, pp. 495-506) and Dr Richard Andree (*Stagsb. d. anthrop. Ges. in Wien*, 1906, pp. 87-98) all agree as to the general autochthony of aboriginal American culture. The day of the argument for borrowing on the ground of mere resemblances in beliefs, institutions, implements, inventions, &c., is past. An admirable instance of the results of exact scientific research in this respect is to be found in Dr Franz Boas's discussion (*Proc. U.S. Nat. Mus.*, 1908, pp. 321-344) of the needle-cases of the Alaskan Eskimo, which were at first supposed to be of foreign (Polynesian) origin. Other examples occur in Mr Culin's study of American Indian games, where, for the first time, the relation of certain of them in their origin and development, and sometimes also in their degeneration and decay, is made clear. The independent origin in America of many things which other races have again and again invented and re-invented in other parts of the world must now be conceded.

The extreme north-western region of North America has recently been shown to be of great importance to the ethnologists. The investigations in this part of America and among the more or less primitive peoples of north-eastern Asia, carried on by the Jesup North Pacific expedition in 1897-1902, have resulted in showing that witiu what may be called the "Bering Sea culture-area" transmissions of culture have taken place from north-eastern Siberia to north-western America and vice versa. The only known example, however, of the migration of any people one way or the other is the case of the Asiatic Eskimo, who are undoubtedly of American origin, and it seems probable, in the language of Dr Boas, the organizer of the Jesup expedition and the editor of its publications, that "the Chukchee, Koryak, Kamchadal and Yukaghir must be classed with the American race rather than with the Asiatic race," and possibly also some of the other isolated Siberian tribes; also that, "in a broad classification of languages, the languages of north-eastern Siberia should be classed with the languages of America" (*Proc. Internat. Congr. Amer.*, New York, 1902, pp. 91-102). It appears, further, that the arrival of the Eskimo on the Pacific coast (this, although not recent, is comparatively late) from their home in the interior, near or east of the Mackenzie, "interrupted at an early period the communication between the Siberian and Indian tribes, which left its trace in many cultural traits common to the peoples on both sides of the Bering Sea."

This establishment of the essential unity of the culture-type (language, mythology, certain arts, customs, beliefs, &c.) of the Palaeo-Asiatic peoples of north-eastern Siberia and that of the American Indians of the North Pacific coast, as demonstrated especially by the investigations of Jochelson, Bogoraz, &c., is one of the most notable results of recent original ethnological research. No clear proof has been afforded of the theory of Polynesian influence farther south on the Pacific coast of America, believed in, more or less, by certain ethnologists (Ratzel, Mason, &c.). This theory rests largely upon resemblances in arts (clubs, masks and the like in particular), tattooing, mythic motifs, &c. But several things here involved, if not really American in origin, are so recent that they may perhaps be accounted for by such Hawaiian and other Polynesian contacts as resulted from the establishment of the whale and seal-fisheries in the 18th century.

Between the Indians of North America and those of South America few instances of contact and intercommunication, or even of transference of material products and ideas, have been substantiated. It is by way of the Antilles and the Bahamas that such contact as actually occurred took place. In 1894 (*Amer. Anthrop.* vol. vii. p. 71-99) Professor W. H. Holmes pointed out traces of Caribbean influences in the ceramic art of the Florida-Georgia region belonging to the period just before the Columbian discovery,

Culture of Indians essentially indigenous.

The decorative designs in question, paddle-stamp patterns, &c., akin to the motives on the wooden and stone stools from the Caribbean areas in the West Indies, have been found as far north as 36° in North Carolina and as far west as 84° in Tennessee and 89° in south-eastern Alabama. But the evidence does not prove the existence of Caribbean colonies at any time in the history of the region, but simply the migration from the West Indies to the North American coast of certain art features adopted by the Indians of the Timuquian and Muskogian Indians and (later) in part by the Cherokee. More recently (1907) Dr F. G. Speck, in a discussion of the aboriginal culture of the south-eastern states (*Amer. Anthropol. vol. ix, n.s., pp. 287-295*), cites as proof of Antillean or Caribbean influence in addition to that indicated by Holmes, the following: employment of the blow-gun for hunting, the hammock as baby-cradle, the regular storage-scaffold in one corner of house, plastering houses with clay, poisoning fish with vegetable juices. It is possible also that the North American coast may have been visited from time to time by small bodies of natives from the West Indies in search of the mythic fountain of youth (*Bimini*), the position of which had shifted from the Bahamas to Florida in its movement westward. Indeed, just about the time of the advent of the Europeans in this part of the world a number of Indians from Cuba, on such a quest, landed on the south-western shore of Florida, where they were captured by the Calusas, among whom they seem to have maintained a separate existence down to 1570 or later. This Arawakan colony, indicated on the map of linguistic stocks of American Indians north of Mexico, published by the Bureau of American Ethnology in 1907, is the only one demonstrated to have existed, but there may have been others of a more temporary character. In the languages of this region there are to be detected, perhaps as loan-words, from Arawakan or Cariban dialects. The exaggerated ideas entertained by some authorities concerning the "mound-builders" of the valley of the Ohio and Mississippi and their alleged "civilization" have led them to assume, without adequate proof, long-continued relations of the tribes inhabiting this part of the country in the past with the ancient peoples of Yucatan and Mexico, or even an origin of their culture from beyond the Gulf of Mexico. The facts were in all probability wholly the work of the modern Indians of this area or their immediate ancestors, and the greater part, if not all, of the art and industry represented therein lies easily within the capacity of the aborigines of North America, the "Mexican" theory in this form appears unnecessary to explain the facts. In its support stress has been laid upon the nature of some of the copper implements and ornaments, particularly the types of elaborate repoussé work in Etowah, Georgia, &c. It is true that the work does not beyond the skill of the Indian was shown by Cushing in his study of "Primitive Copper Working" (*Amer. Anthropol. vol. vii, pp. 93-117*), who did not consider the resemblance of these mound-specimens to the art of Mexico proof of extra-North American origin. Holmes (*Handb. of Inds. N. of Mex., 1907, pt. i, p. 343*) points out that the great mass of the copper of mounds came from the region of Lake Superior, and that had extensive intercourse between Mexico and Central America and the mound-country existed, or colonies from those southern parts been present in the area in question, artifacts of undoubtedly Mexican origin would have been found in the mounds in considerable abundance, and methods of manipulation peculiar to the south would have been much in evidence. The facts indicate at most some exotic influence from Mexico, &c., but nothing far-reaching in its effects.

In the lower Mississippi valley the culture of certain peoples has been thought to contain elements of the temples and other religious institutions of the Natchez suggestive of Mexican or Central American origin, either by inheritance from a common ancient source or by later borrowings. When one reaches the Pueblos region, with its present and its extinct "village culture," there is considerable evidence of contact and inter-influence, if not perhaps of common origin, of culture-factors. Dr J. Walter Fewkes, a chief authority on the ethnology of Arizona, Mexico, and the outlying areas of "Pueblos culture," especially in its former aspects, has expressed the opinion (*Amer. Anthropol. vol. vii, p. 51*) that "it is not improbable that both Mexican and Pueblo cultures originated in a region in northern Mexico, developing as environment permitted in its northern and southern homes." Unfavourable milieu in the north prevented the culture of the Pueblos Indians and the Cliff-dwellers, their ancestors, reaching the height attained in Mexico and Central America, represented by temple-architecture, ornamentation of buildings, hieroglyphs, &c. In the Mexican-Pueblo-Mexican relationship Dr Fewkes sees (*Proc. Wash. Acad. Sci., 1900*) in the great serpent cult of Tusayan, the "New Fire" and other Puebloan ceremonials of importance; also in the mosaic objects (gorgets, ear-pendants, breast-ornaments, &c.) from Pueblos ruins in Arizona, some of the workmanship of which equals that of similar character in old Mexico. The arid region of the south-western United States and northern Mexico may well have been a centre for the dispersion of such primitive institutions and ideas as reached their acme in the country of the Aztecs. But of the Pueblos languages, the Moqui or Hopi of north-eastern Arizona is the only one showing undoubtedly, though not intimate, relationship with the Nahuatl of ancient Mexico. The Shoshonian family, represented in the United States by the Shoshonees, Utes, Comanches

and other tribes, besides the Moqui, includes also the numerous Sonoran tribes of north-western Mexico, as well as the Nahuatl-speaking peoples farther south, some of the outliers having wandered even to Costa Rica (and perhaps to Panama). This linguistic unity of the civilized Aztecs with the rude Utes and Shoshonees of the north is one of the most interesting ethnological facts in primitive America. Change of environment may have had much to do with this higher development in the south. Besides the Shoshonian, the Coahuiltecan and the Athabaskan are or have been represented in northern Mexico, the last by the Apaches and Tobosos. From the period of the Spanish colonization of New Mexico down to about the last quarter of the 19th century (and sporadically later, e.g. the attack in 1900 on the Mormon settlement in Chihuahua), the Indians have hovered around the Mexican border, &c., their predatory expeditions extending at one time as far south as Jalisco. In the far west the Yuman family of languages belongs on both sides of the border.

In the popular mind the religion of the North American Indian consists practically of belief in the "Great Spirit" and the "Happy Hunting Grounds." But while some tribes, e.g. of the Iroquoian and Caddoan stocks, appear to have come reasonably near a pantheistic conception tending toward monism and monotheism, not a little of present Indian beliefs as to the "Great Spirit," "God" and "Devil," "Good Spirit" and "Evil Spirit," &c., as well as concerning moral distinctions in the hereafter, can reasonably be considered the result of missionary and other influences coming directly or indirectly from the whites. The central idea in the religion and mythology of the aborigines north of Mexico is what Hewitt (*Amer. Anthropol., 1902*) has proposed to term *orenda*, from the Iroquoian name of the fictive force, principle or magic power which was assumed by the inchoate reasoning of primitive man to be inherent in every body and being of nature and in every personified attribute, property or activity belonging to each of these and conceived to be the active cause or force or dynamic energy involved in every operation or phenomenon of nature, in any manner affecting or controlling the welfare of man." The *orendas* of the innumerable beings and objects, real and imagined, in the universe differed immensely in action, function, power, &c., and in like manner varied were the efforts of man by prayers, offerings and sacrifices, ceremonies and rites of a propitiatory or sympathetic nature to influence for his own welfare the possessor of this or that *orenda*, from the "high gods" to the least of all beings. Corresponding to the Iroquoian *orenda* is the *wakanda* of the Siouan tribes, some aspects of which have been admirably treated by Miss Fletcher in her "Notes on Certain Beliefs concerning Will Power among the Siouan Tribes" (*Science, vol. v., n.s., 1897*). Other parallels of *orenda* are Algonkian *manito*, Shoshonian *pokunt*, Athabaskan *cam*. As Hewitt points out, these Indian terms are not to be simply translated into English by such expressions as "mystery," "magic," "immortal," "sorcery," "wonderful" &c. Man, indeed, "may sometimes possess weapons whose *orenda* is superior to that possessed by some of the primal beings of his cosmology."

The main topics of the mythology of the American Indians north of Mexico have been treated by Powell in his "Sketch of the Mythology of the North American Indians" (*First Ann. Rep. Bur. Ethnol., 1870-1880*), and Brinton in his *American Hero Myths (1876), Myths of the New World (1866) and Religions of Primitive Peoples (1900)*. Widespread is the idea of a culture-hero or demi-god (sometimes one of twins or even quadruplets) who is born of a human virgin, often by divine secret fecundation, and, growing up, frees the earth from monsters and evil beings, or re-fashions it in various ways, improves the breed and perfects the institutions of mankind, then retires to watch over the world from some remote resting-place, or, angered at the wickedness of men and women, leaves them, promising to return at some future time. He often figures in the great deluge legend as the friend, helper and regenerator of the human race. A typical example of these culture-heroes is the Algonkian character who appears as Nanabozho among the Ojibwa, Wisaketchak among the Cree, Napiw among the Blackfeet, Wisaka among the Sacs and Foxes, Glosocap (Kuloskap) among the Micmac,

&c. (see *Journ. Amer. Folk-Lore*, 1891, and *Handbook of Amer. Inds.*, 1907), whose brother is sometimes represented as being after death the ruler of the spirit world. The Iroquoian correspondent of Nanabozho is Tehoronhiawakchon; the Siouan, in many respects, Ictinike. Among many tribes of the North Pacific coast region the culture-hero appears as the "transformer," demi-god, human or animal in form (coyote, blue-jay, raven, &c.), the last often being trickster and dupers of mankind and the rest of creation as well. This trickster and buffoon (also liar) element appears also in the Iroquoian and Algonkian culture-heroes and has received special treatment by Brinton (*Essays of an Americanist*, 1890). On the whole, the Algonkian and Iroquoian culture-hero is mainly actuated by altruistic motives, while the "transformer" of the Indians of the North Pacific coast region is often credited with producing or shaping the world, mankind and their activities as they now exist for purely egotistic purposes. Other noteworthy heroes, "reformers," &c., among the North American Indians are the subject of legends, like the Iroquoian "Good Mind and Bad Mind," the Algonkian (Musquaki) "Hot Hand and Cold Hand," the Zuni "Right Hand and Left Hand"; and numerous others, including such conceptions as the antagonism and opposition of land and water (dry and wet), summer and winter, day and night, food and famine, giants and pigmies, &c. In the matter of the personification of natural phenomena, &c., there is considerable variation, even among tribes of approximately the same state of culture. Thus, e.g. as Hewitt notes (*Handbook of Amer. Inds.*, 1907, pt. i, p. 970), while with the Iroquoian and eastern Algonkian tribes "the Thunder people, human in form and mind and usually four in number, are most important and staunch friends of man"; in the region of the Great Lakes and westward "this conception is replaced by that of the Thunder bird."

The Pawnee Indians of the Caddoan stock seem both individually and tribally to possess a deep religious sense expressing itself alike in moods of the person and in ceremonies of a general popular character. This is evident, alike from Miss Fletcher's description (*Amer. Anthropol.*, 1899, pp. 83-85) of a venerable priest of that tribe, Tahiroosawich, and from her detailed account of "The Snake Dance Ceremony" (*Twenty-second Ann. Rep. Bur. Ethnol.*, 1900-1901, pp. 5-372). This Snake ceremony, the original stimulus for which was probably desire for offspring, and then to ensure friendship and peace between groups of persons belonging to different clans, gentes or tribes, had no fixed or stated time and "was not connected with planting or harvesting, hunting or war or any tribal festival," although the Indians take up the Hako, with its long series of observances and its hundred songs, "in the spring when the birds are mating, or in the summer when the birds are nesting and caring for their young, or in the fall when the birds are flocking, but not in the winter when all things are asleep with the Hako we are praying for the gift of life, of strength, of plenty and of peace, so we must pray when life is stirring everywhere,"—these are the words of the Indian hierogogue.

In the arid region of the south-western United States there has grown up, especially among the Moqui, as may be read in the numerous monographs of Dr J. Walter Fewkes (and briefly in the *Report of the Smithsonian Institution for 1905*), a system of religious ceremonies and sympathetic magic, the object of which is to ensure the necessary rainfall and through this the continued life and prosperity of the people. Here everything is conceived as really or symbolically related to sun, water, rain. The Moqui are essentially a religious people, and their mythology, in which the central figures are the "earth mother" and the "sky father," has been described as "a polytheism largely tinged with ancestor-worship and permeated with fetishism." Part of their exceedingly intricate, complex and elaborate ritual is the so-called "snake dance," which has been written of by Bourke (*The Snake Dance of the Moquis*, 1884), Fewkes and others.

In the Gulf region east of the Mississippi, "sun worship," with primitive myths, appears among some of the tribes with certain curious myths, beliefs, ceremonies, &c. The Natchez, e.g. according to Dr Swanton (*Amer. Anthropol.*, 1907), were noteworthy on account of "their highly developed monarchical government and their possession of a national religion centring about a temple, which reminds one in many ways of the temples of Mexico and Central America." They seem to have had "an extreme form of sun-worship and a highly developed ritual." A simpler form of sun-worship is found among the Kootenay of British Columbia (*Rep. Brit. Assoc.*, 1889, 1892). With the Yuchi occur some Algonkian-like myths of the deluge, &c.

The best data as to the religion and mythology of the Iroquoian

tribes are to be found in the writings of Hewitt, especially in his monograph on "Iroquoian Cosmology" (*Twenty-first Ann. Rep. Bur. Ethnol.*, 1899-1900, pp. 127-339). In the creation-myths several instances of European influence are pointed out. Mother-earth and her life are the source, by transformation and evolution, of all things. The first beings of Iroquoian mythology (daylight, earthquake, winter, medicine, wind, life, flower, &c.) "were not beasts, but belonged to a rather vague class of which man was the characteristic type"—later come the "transformers" belonging to Hewitt the Iroquoian term rendered in English "god" signifies really "disposer, controller," for to these Indians "god" and "controller" are synonymous; and so "the reputed controller of the operations of nature received worship and prayers." Creation-legends in great variety exist among the North American aborigines, from simple *fiat* actions of single characters to complicated transformations accomplished with the aid of other beings. The specific creation legend often follows that of the deluge.

Perhaps the most remarkable of all North American creation stories is that of the Zuni as recorded by Cushing (*Thirtieth Ann. Rep. Bur. Ethnol.*, 1891-1892) in his "Outlines of Zuni Creation Myths." Here the principal figure is "Awonawilona, the maker and container of all," and the growth-substance the "fogs of increase," which he evolved by his thinking in the pristine night. The long tale of the origin of the sun, the earth and the sky, and the taking form of "the seed of men and all creatures" in the lowest of the four caves or wombs of the world and their long journey to light and real life on the present earth is a wonderful story of evolution as conceived by the primitive mind, an aboriginal epic, in fact.

In the mythology and religion of the Algonkian tribes (particularly the Chippewa, &c.) is expressed "a firm belief in a cosmic mystery present throughout all nature, called *manitou*." This *manitou* "was identified with both animate and inanimate objects, and the impulse was strong to enter into personal relation with the mystic power; it was easy for an Ojibwa to associate the *manitou* with all forms of transcendent agencies, some of which assumed definite characters and played the rôle of deities" (Jones). There were innumerable *manitous* of high or low degree. "The highest development of the shamanistic or spirit-lore was that of Manitow (Great Manitou), but whether this personification has not been considerably influenced by teachings of the whites is a question. The chief figure in the mythology of the Chippewa and related tribes is Nanabozho, who "while yet a youth became the creator of the world and everything it contained; the author of all the great institutions in Ojibwa society and the founder of the leading ceremonies" (Jones, *Ann. Arch. Rep. Ontario*, 1905; *Journ. Amer. Folk-Lore*, 1902, &c.). It is to this character that some of the most human of all Indian myths are attached, e.g. the Micmac legend of the origin of the canoe-lore, the hero-tales, treating of Nanabozho's attempt to sink his toe into his mouth after the manner of a little child. Nanabozho is also the central figure in the typical deluge legend of the Algonkian peoples of the Great Lakes (*Journ. of American Folk-Lore*, 1891), which, in some versions, is the most remarkable myth of its kind north of Mexico.

The best and most authoritative discussion of the religions and mythological ideas of the Eskimo is to be found in the article of Dr Franz Boas on "The Folk-Lore of the Eskimo" (*Journ. Amer. Folk-Lore*, 1904, pp. 1-13). The characteristic feature of Eskimo folk-lore is the hero-tales, treating of fabulous beings, encounters with monsters, quarrels and "wars," shamanistic witchcraft, &c., and generally of "the events occurring in human society as it exists now," the supernatural playing a more or less important rôle, but the mass of folk-lore being "thoroughly human in character." In Eskimo myths there appears to be "a complete absence of the idea that transformations or creations were made for the benefit of man during a mythological period, and that these events changed the general aspect of the world," quite in contrast with the conceptions of many Indian tribes, particularly in the region of the North Pacific, where the "transformer" (sometimes conceived also), demi-god, human or animal (coyote, raven, blue-jay, &c.), plays so important a part, as may be seen from the legends recorded in Dr Boas's *Indianische Sagen der nord-pazifischen Küste Amerikas* (Berlin, 1895) and other more recent monographs. In Eskimo folk-lore the field of animal tales is quite limited, and Dr Boas is of opinion that the genuine animal myth "was originally foreign to Eskimo folk-lore," and has been borrowed from the Indians. Perhaps the most prominent character in Eskimo mythology is Sedna, the old woman, who is mistress of the lower world beneath the ocean (*Amer. Anthropol.*, 1907). The highest belief concerned with the Athabaskans of Canada was, according to Morice (*Ann. Arch. Rep. Ontario*, 1905, p. 204), "a real entity, which they feared rather than loved or worshipped." The way of communicating with the unseen was through "personal totems," revealed usually in dreams. The Hupa, an Athabaskan people of California, are reported by Goddard as possessing a deep religious sense. But the most remarkable mythology of any Athabaskan tribe is that of the Navaho, which has been studied in detail under some of its chief aspects by Dr Washington Matthews in his valuable monographs, *Navaho Legends* (1897) and *The Right Hand* (1902). According to Dr Matthews, the Navaho "are a highly religious people having many

well-defined divinities (nature gods, animal gods and local gods), a vast mythic and legendary lore and thousands of significant formulated songs and prayers, which must be learned and repeated in the most exact manner; they have also hundreds of musical compositions; the so-called dances are ceremonies which last for nine nights and parts of ten days, and the medicine-men spend many years of study in learning to conduct a single one properly.

The most prominent and revered of the deities of the Navaho is *Etsanadeh*, the "woman who rejuvenates herself," of whom it is believed that she grows old, and then, at will, becomes young again.

The numerous Indian tribes subjected to the environment of the Great Plains have developed in great detail some special religious observances, ceremonial institutions, secret societies, ritual observances, &c. The mental life of these Indians was profoundly influenced by the buffalo and later not a little by the horse. Various aspects of Plains culture have recently been discussed by Goddard, Kroeber, Wissler, Dorsey, Fletcher, Boas, &c., from whose investigations it would appear that much intertribal borrowing has taken place. Among some of the Algonkian (Arapaho, Blackfeet, Cheyenne, &c.), Siouan (Ponka, e.g.) Caddoan, Shoshonian, Kiowan and perhaps Kitunahan stocks the "sun-dance" in some form or other prevailed at one time or another. According to Wissler (*Amer. Anthrop.*, 1908, p. 205), this ceremony, as now practised by many tribes, "is the result of a gradual accumulation both of ceremonies and ideas,"—the torture feature, e.g., "seems to have a separate institution among the Missouri river tribes, later incorporated in their sun-dance and eventually passed on to other tribes." Some other complicated ceremonials have apparently grown up in like manner. As ceremonies that are quite modern in origin have been introduced during the historical period, Dr. Wissler instances "the Ghost dance, Omaha dance, Woman's dance, Tea dance and Mescal eating," of which all, except the Ghost dance, "flourish in almost all parts of the area under various names, but with the same essential features and songs." Other interesting ceremonies of varying degrees of importance and extent of distribution are those of "the medicine-tips, buffalo-medicine, sweat-lodge, puberty-rites, medicine-tips, war-charms, &c." Interesting also are the "medicine bundles," or "araks" as they were once called, which were used by the Indians.

The "Ghost dance," the ceremonial religious dance of most notoriety to-day, "originated among the Paviotso (its prophet was a young Paiute medicine man, Wovoka or 'Jack Wilson') in Nevada about 1888, and spread rapidly among other tribes until it numbered among its adherents nearly all the Indians of the interior basin, from Missouri river to or beyond the Rockies" (Mooney). Wovoka's doctrine was that a new dispensation was at hand, and that "the Indians would be restored to their inheritance and united with their departed friends, and they must prepare for the event by praying and dancing a certain dance, to which the prophet gave them." East of the Rocky Mountains this dance soon came to be known as the "Ghost dance" and a common feature was hypnotic trances. The Sioux outbreak of 1890-1891 was in part due to the excitement of the "Ghost dance." According to Mooney, "in the Crow dance of the Cheyenne and Arapaho, a later development from the Ghost dance proper, the drum is used, and many of the ordinary tribal dances have incorporated Ghost dance features, including even the hypnotic trances." The doctrine generally "has now faded out and the dance exists only as a social function." As full accounts of this dance, its chief propagators, the *modi operandi* of its ceremonies and their transference, and the results of its prevalence among so many Indian tribes, is given in Mooney's detailed monograph on "The Ghost Dance Religion and the Sioux Outbreak of 1890" (*Fourteenth Ann. Rep. Bur. Ethnol.*, 1892-1893).

In reference to "Messiah doctrines" among the aborigines of North America, Mooney calls attention to the fact that "within the United States every great tribal movement (e.g. the conspiracy of Pontiac, the combination of Tecumseh and &c.) originated in the teaching of some messianic prophet." In primitive America the dance has figured largely in social, religious and artistic activities of all kinds, and one of its most interesting developments has occurred among the Plains Indians, where "the Mandan and other Siouan tribes dance in an elaborate ceremony, called the Buffalo dance, to bring game when food is scarce, in accordance with a well-defined ritual" (Hewitt). Among other noteworthy dances of the North American aborigines may be mentioned the calumet dance of several tribes, the scalp dance, the "Green-corn dance" of the Iroquois, the *bask* (or *pushkian*) of the Creeks (in connexion with "new fire" and regeneration of all things), the "fire dance" of the Mississaugas, &c.

The Californian area, remarkable in respect to language and culture in general presents also some curious religious and mythological phenomena. According to Kroeber, "the mythology of the Californians was characterized by unusually well-developed and consistent creation-myths, and by the complete lack not only of migration but of ancestor traditions." The ceremonies of the Californian Indians were numerous and elaborate as compared with the prevalent simplicity of life, but they lacked almost totally the rigid ritualism and extensive symbolism which characterize the ceremonies of most America." The most authoritative discussions of the religion and mythology of the Californian Indians are those

of Dr. Dixon and Dr. Kroeber, the latter especially in the *University of California Publications in American Archaeology and Ethnology* for 1904-1907.

The shamans, "medicine-men," &c., of the American Indians are of all degrees from the self-constituted *angekok* of the Eskimo to those among tribes of higher culture who are chosen from a special family or after undergoing elaborate preliminaries of selection and initiation. The "medicine-men" of several tribes have been described with considerable detail. This has been done for the "Midéwin, or Grand Medicine Society of the Ojibwa" by Hoffman (*Seventh Ann. Rep. Bur. Ethnol.* pp. 143-300); for the "Medicine-men of the Apache" by Bourke (*Ninth Ann. Rep.* pp. 443-603) and for those of the Cherokee by Mooney (*Seventh Ann. Rep.* pp. 301-397), while a number of the chief facts concerning American Indian shamans in general have been gathered in a recent article by Dr. R. B. Dixon (*Journ. Amer. Folk-Lore*, 1908, pp. 1-12). In various parts of the continent and among diverse tribes the shaman exercises functions as "a healer, sorcerer, seer, priest and educator." These functions among the tribes of lower culture are generally exercised by one and the same individual, but, with rise in civilization, the healer-sorcerer and shaman-sorcerer disappear or wane in power and influence as the true priest develops. The priestly character of the shaman appears among the Plains tribes in connexion with the custody of the "sacred bundles" and the keeping of the ceremonial myths, &c., but is more marked among the Pueblos, Navaho, &c., of the south-west, while "a considerable development of the priestly function may also be seen among the Muskogi, particularly in the case of the Natchez, with their remarkable cult and so-called temple." The reverent character of the belief in "priests" or shamans among the Pawnee and Omaha has been emphasized by Miss A. C. Fletcher and Francis la Flesche. The class-organization of the shamans reaches its acme in the *midé* societies of the Chippewa and the priest-societies of the Pueblos Indians (Moqui, Zuni, &c.).

The games of the American aborigines north of Mexico have been made the subject of a detailed monograph by Culin, "Games of the North American Indians" (*Twenty-fourth Ann. Rep. Bur. Ethnol.*, 1902-1903, pp. 1-846). Games.

In which are treated the games of chance, games of dexterity and minor amusements of more than 200 tribes belonging to 34 different linguistic stocks. According to Culin, "games of pure skill and calculation, such as chess, are entirely absent." There are more variations in the materials employed than in the object or methods of play and in general the variations do not follow differences in language. The type known as "dice game" is reported here from among 130 tribes belonging to 30 stocks; the "hand-game" from 81 tribes belonging to 28 stocks. The centre of distribution of North American Indian games, which, with the exception of a few post-Columbian additions, are all autochthonous, Culin finds in the south-west—"there appears to be a progressive change from what appears to be the oldest forms of existing games from a centre in the south-western United States, along lines north, north-east and east." Similar changes radiating southward from the same centre are likewise suggested. He is of opinion that, outside of children's games as such and the kinds of minor amusements common in all civilizations, the games of the North American Indians, as they now exist, "are either instruments of rites or have descended from ceremonial observances of a religious character," and that "while their common and secular object appears to be purely a manifestation of the desire for amusement or gain, they are performed also as religious ceremonies, as rites pleasing to the gods to secure their favour, or as processes of sympathetic magic, to drive away sickness, avert other evil, or produce rain and the fertilization and reproduction of plants and animals or other beneficial results." He also believes that these games, "in what appears to be their oldest and most primitive manifestations are almost exclusively divinatory." This theory of the origin of games in divination, which receives considerable support from certain facts in primitive America, needs, however, further proof. So, too, with Mr. Culin's further conclusion that "behind both ceremonies and games there existed some widespread myth from which both derived their impulse," that myth being the one which discloses the primal gamblers as those curious children, the divine Twins, the miraculous offspring of the sun, who are the principal personages in many Indian mythologies." These eternal contenders "are the original patrons of play, and their games are the games now played by men."

It was formerly thought that "totemism" and real "gentile organization" prevailed over all of North America. But it now appears that in several sections of the country such beliefs and institutions were unknown, and that even within the limits of one and the same stock one tribe did, while another did not, possess them. Matriarchal ideas and the corresponding tribal institutions were also once regarded as the primal social condition of all Indian tribes, having been afterwards in many cases replaced by patriarchal ideas and institutions. Since the appearance of Morgan's famous monograph on *Ancient Society* (New York, 1878) and his *Systems of Consanguinity and Affinity in the Human Family* (Washington, 1871), the labours of American ethnologists have added much to our knowledge of the sociology of the American Indians. Forms of society among these Indians vary from the absolute democracy of the Athabaskan Ten'a of Alaska, among whom, according to Jetté (*Congr. int. d. Amér.*, Quebec, 1886), there exist "no chiefs, guides or masters," and public opinion dominates ("every one commands and all obey, if they see fit"), to the complicated systems of some of the tribes of the North Pacific coast regions, with threefold divisions of chiefs, "nobles," and "common people" (sometimes also, in addition, slaves), secret and "totemic" organizations, religious societies, sexual institutions ("men's houses," &c.), and other like divisions; and beyond this to the development along political and larger social lines of alliances and confederations of tribes (often speaking entirely different languages) which have played an important rôle in the diffusion of primitive culture, such as the Powhatan confederacy of Virginia and the Abnaki confederacy of the North Atlantic region; the confederacy of the Chippewa, Ottawa and Potawatomi of the Great Lakes; the Huron confederacy of Ontario; the Dakota alliance of the north-west; the Blackfoot confederacy of the Canadian north-west; the Caddoan confederacy of the Arkansas region; the Creek confederacy of the South Atlantic country. The acme of federation was reached in the great "League of the Iroquois," whose further development and expansion were prevented by the coming of the Europeans and their conquest of primitive North America. According to Morgan (*League of the Iroquois*, New York, 1851) and Hale (*Iroquois Book of Rites*, 1881), who have written about this remarkable attempt, by federation of all tribes, to put an end to war and usher in the reign of universal peace, its formation under the inspiring genius of Hiawatha took place about 1450. But J. N. B. Hewitt, himself an Iroquois, offers reasons (*Amer. Anthropol.*, 1892) for believing that the correct date of its founding lies between 1350 and 1370.

Tribes like the Kootenay (*Rep. Brit. Assoc.*, 1892) have no totems and secret societies, nor do they seem to have ever possessed them. This may also be said of some of the Salishan tribes, though others of the same stock have complicated systems. The Klamath Indians (Lutuanian stock) "are absolutely ignorant of the gentile or clan system as prevalent among the Haida, Tlingit and Eastern Indians of North America; matriarchy is also unknown among them; every one is free to marry within or without the tribe, and the children inherit from the father" (Gatschet). In all parts of California indeed, according to Kroeber (*Handbook of Amer. Inds.*, 1907, pt. i, p. 191), "both totemism and a true gentile organization were totally lacking." Nor does it appear that either personal or communal totemism is a necessary attribute of clan and gentile organizations where such do exist. The Heiltsuk of British Columbia have animal totems, while the Kwakiut do not, although both these tribes belong to the same Wakashan stock. Among the Iroquoian tribes, according to Hewitt (*Handbook*, p. 203), "the primary unit of social and political organization, termed in Mohawk *okwachira*, is 'the family, comprising all the male and female progeny of a woman and of all her female descendants in the female line and of such other persons as may be adopted into the *okwachira*.' The head of the *okwachira* is 'usually the oldest woman in it,' and it 'never bears the name of a tutelary or other deity.' The clan was composed of one or more of such *okwachiras*, being 'developed apparently through the coalescence of two or more *okwachiras* having a common abode.' From the clan or gens developed the government of the tribe, and out of that the Iroquois confederation.

The power of the chief varied greatly among the North American aborigines, as well as the manner of his selection. Among the Eskimo, chiefs properly understood hardly have existed; nearly everywhere the power of all sorts of chiefs (both war and peace) was limited and modified by the restraints of councils and other advisers.

Age, wealth, ability, generosity, the favour of the shaman, &c., were qualifications for the chieftainship in various parts of the continent. Women generally seem to have had little or no direct voice in government, except that they could (even among some of the Athabaskan tribes) sometimes become chiefs, and, among the Iroquois, were represented in councils, had certain powers and prerogatives (including a sort of veto on war), &c. Many of the permanent peace-chiefs and temporary war-chiefs. According to Hewitt (*Handb. of Amer. Inds.*, 1907, pt. i, p. 264), "In the Creek confederation and that of the Iroquois, the most complex aboriginal government north of Mexico, there was, in fact, no head chief. The first chief of the Onondaga federal roll acted as the chairman of the federal council, and by virtue of his office he called the federal council together. With this all pre-eminence over the other chiefs ended, for the governing power of the confederation was lodged in the federal council. The federal council was composed of the federal chiefs of the several component tribes, the tribal council consisted of the federal chiefs and sub-chiefs of the tribe." The greatest development of the power of the chief and his tenure of office by heredity seems to have occurred among the Natchez and certain other tribes of the lower Mississippi and Gulf region. Among the Plains tribes, in general, non-inheritance prevailed, and "any ambitious and courageous warrior could apparently, in strict accordance with custom, make himself a chief by the acquisition of suitable property and through his own force of character" (Hewitt).

Among the North American aborigines the position of woman and her prerogatives among the various tribes, from the usually narrow limits prescribed by the Athabaskans, according to Morice (*Congr. int. d. Amér.*, Quebec, 1906), to the socially high status reached among some of the Iroquoian tribes in particular. In the North Pacific coast region the possession of slaves is said to have been a cause of a relatively higher position of woman there than obtained among neighbouring tribes. The custom of adoption both of children and captives also resulted advantageously to woman. The rôle and accomplishments of woman in primitive North America are treated with some detail in Mason's *Woman's Share in Primitive Culture* (1894). The form of the family and the nature of marriage varied considerably among the North American aborigines, as also did the ceremonies of courtship and the proceedings in divorce, &c. With some tribes apparently real purchase of brides occurred, but in many cases the seeming purchase turns out to be merely "a ratification of the marriage by means of gifts." Great differences in these matters are found within the limits of one and the same stock (e.g. Siouan). Female descent, e.g., prevailed among the Algonkian tribes of the south-east but not among those of the north and west, and the case of the latter (the Algonkian) is that of female descent is not necessarily the concomitant of a high social status of woman. Among the Zuli, where the man is adopted as a son by the father of his wife, "she is thus mistress of the situation; the children are hers, and she can order the husband from the house should occasion arise" (Lowie and Farrand). With many tribes, however, the husband could divorce his wife at will, but Farrand and Lowie in their discussion of Indian marriage (*Handb. of Amer. Inds.*, 1907, pt. i, p. 809) report on the other hand the curious fact that among the Winton of California "men seldom expel their wives, but sink away from home, leaving their families behind." In the case of divorce, the children generally go with the mother. From a survey of the available data Lowie and Farrand conclude that "monogamy is thus found to be the prevalent form of marriage throughout the continent," varied from to polygamy, where wealth and other circumstances dictated it. In California, e.g., polygamy is rare, while with some of the Plains tribes it was quite common. Here again differences of note occurred within the same stock, e.g. the Iroquois proper could not have more than one wife, but the Huron Indians, in the case of the family itself varied the number of parents and children to the larger ones dictated by social relations among the eastern tribes with clan organizations, and the large "families" found by Swanton (*Amer. Anthropol.*, 1905) among certain tribes of the North Pacific coast, where relations and "poor relations," servants and slaves entered to swell the aggregate. Exogamy was widely prevalent and incest rare. Cousin-marriages were frequently taboed.

With many of the North American aborigines the giving of the name, its transference from one individual to another, its change by the individual in recognition of great events, achievements, &c., and other aspects of nomenclature are of significance in connexion with social life and religious ceremonies, rites and superstitions. The high level attained by some tribes in these matters can be seen from Miss Fletcher's description of "A Pawnee Ritual used when changing a Man's Name" (*Amer. Anthropol.*, 1899). Names marked epochs in life and changed with new achievements, and they had often "so personal and sacred a meaning," that they were naturally enough rendered "unfit for the familiar purposes of ordinary address, to a people so reverently inclined as the Indians seem to have been." The ceremony of changing the name of boys often on the occasion of elaborate "initiation" ceremonies and rites of various kinds, some of which were of a very trying and even cruel character. Ceremonial or symbolic "killings," "new-births," &c., were also in vogue; likewise ordeals of whipping, isolation and solitary confinement, "medicine"-taking, physical torture, ritual batings,

painting of face or body, scarification and the like. The initiations, ordeals, &c., gone through by the youth as a prelude to manhood and womanhood resembled in many respects those imposed upon individuals aspiring to be chiefs, shamans and "medicine-men." Many facts concerning these rites and ceremonies will be found in G. Stanley Hall's *Adolescence* (1904) and in the articles on "Ordeals" and "Puberty Customs" in the *Handbook of American Indians North of Mexico* (1907-1910). In the method of approach to the supernatural and the superhuman among the North American aborigines there is great diversity, and the powers and capacities of the individual have often received greater recognition than is commonly believed. Thus, as Kroeber (*Amer. Anthropol.*, 1902, p. 285) has pointed out, the Mohave Indians of the Yuman stock have as a distinctive feature of their culture "the high degree to which they have developed their system of dreaming and of individual instead of traditional connexion with the supernatural." For the Omaha of the Siouan stock Miss A. C. Fletcher (*Proc. Amer. Assoc. Adv. Sci.*, 1895, 1896; *Journ. Anthropol. Inst.*, 1898) has shown the appreciation of the individual in the lonely "totem" vigil and the acquisition of the personal *genius*.

From the Indians of North America the white man has borrowed not only hosts of geographical names and many common terms of speech, but countless ideas and methods as to food, medicines, clothes and other items in the conduct of life. Even to-day, as G.W. James points out in his interesting little volume, *What the White Race may learn from the Indian* (Chicago, 1908), the end of the instruction of the "lower" race by the "higher" is not yet. The presence of the Indians and the existence of a "frontier" receding ever westward as the tide of immigration increased and the line of settlements advanced, have, as Prof. Turner has shown (*Ann. Rep. Amer. Hist. Assoc.*, 1893), conditioned to a certain extent the development of civilization in North America. Had there been no aborigines here, the white race might have swarmed quickly over the whole continent, and the "typical" American would now be much different from what he is. The fact that the Indians were here in sufficient numbers to resist a too rapid advance on the part of the European settlers made necessary the numerous frontiers (really "successive Americas"), which began with Quebec, Virginia and Massachusetts and ended with California, Oregon, British Columbia, Yukon and Alaska. The Indians again are no exception to the rule that one of the fundamentally important contributions of a primitive people to the culture-factors in the life of the race dispossessing them consists of the trails and camping-places, water-ways and trade-routes which they have known and used from time immemorial. The great importance of these trails and sites of Indian camps and villages for subsequent European development in North America has been emphasized by Prof. F. J. Turner (*Proc. Wisconsin State Histor. Soc.*, 1889 and 1894) and A. B. Hulbert (*Historic Highways of America*, New York, 1902-1905). It was over these old trails and through these water-ways that missionary, soldier, adventurer, trader, trapper, hunter, explorer and settler followed the Indian, with guides or without. The road followed the trail, and the railway the road.

The fur trade and traffic with the Indians in general were not without influence upon the social and political conditions of the European colonies. In the region beyond the Alleghenies the free hunter and the single trapper flourished; in the great north-west the fur companies. In the Mackenzie region and the Yukon country the "free hunter" is still to be met with, and he is, in some cases, practically the only representative of his race with whom some of the Indian tribes come into contact. J. M. Bell (*Journ. Amer. Folk-Lore*, xvi., 1903, 74), from personal observation, notes "the advance of the barbarous border civilization,—the civilization of the whaler on Hudson's Bay, of the free trader on the Athabasca Lake and river, of the ranchers and placer miners on the Peace and other mountain rivers," and observes further (p. 84) that "the influx of fur-traders into the Mackenzie River region, and even to Great Bear Lake within the last two years, since my return, has, I believe, very much altered the character of the Northern Indians." In many parts of North America the free trapper and solitary hunter were often factors in the extermination of the Indian, while the great fur companies were not infrequently powerful

agents in preserving him, since their aims of exploiting vast areas in a material way were best aided by alliance or even amalgamation. The early French fur companies, the Hudson's Bay Company, the North-West Company, the American Fur Company, the Missouri Fur Company, the Russian-American Company, the Alaska Commercial Company, &c., long stood with the Indians for the culture of the white man. For two centuries, indeed, the Hudson's Bay Company was ruler of a large portion of what is now the Dominion of Canada, and its trading-posts still dot the Indian country in the far north-west. The mingling of races in the region beyond the Great Lakes is largely due to the fact that the trading and fur companies brought thither employes and dependants, of French, Scottish and English stock, who intermarried more or less readily with the native population, thus producing the mixed-blood element which has played an important rôle in the development of the American north-west. The fur trade was a valuable source of revenue for the early colonists. During the colonial period furs were sometimes even legal tender, like the wampum or shell-money of the eastern Indians, which, according to Mr. Weeden (*Econ. Hist. of New England*), the necessities of commerce made the European colonists of the 17th century adopt as a substitute for currency of the Old World sort.

In their contact with the Indians the Europeans of the New World had many lessons in diplomacy and statecraft. Alliances entered upon chiefly for commercial reasons led sometimes to important national events. The adhesion of the Algonkian tribes so largely to the French, and of the Iroquoian peoples as extensively to the English, practically settled which was ultimately to win in the struggle for supremacy in North America. If we believe Lewis H. Morgan, "the Iroquois alliance with the English forms the chief fact in American history down to 1763."

The whites in their turn have influenced greatly the culture, institutions and ideas of the American aborigines. The early influence of the Scandinavians in Greenland has had its importance exaggerated by Dr. Tylor (*Journ. Anthropol. Inst.*, 1879). French influence in Canada and Acadia began early and was very marked, affecting the languages (several Algonkian dialects have numerous loan-words, as have the Iroquois tongues still spoken in Quebec) and the customs of the Indians. French authorities, missionaries and traders seemed to get into more sympathetic relations with the Indians, and the intermarriage of the races met with practically no opposition. Hence the French influence upon many tribes can be traced from the Atlantic past the Great Lakes and over the Plains to the Rocky Mountains and even beyond, where the trappers, *voyageurs*, *coureurs des bois* and missionaries of French extraction have made their contribution to the modern tales and legends of the Canadian north-west and British Columbia. In one of the tales of the North Pacific coast appears *Shishé Tlé* (i.e. Jesus Christ), and in another from the eastern slope of the Rockies *Mani* (i.e. Mary). Another area of French influence occurs in Louisiana, &c. The English, as a rule, paid much less attention than did the French to the languages, manners and customs and institutions of the aborigines and were in general less given to intermarriage with them (the classical example of Rolfe and Pocahontas notwithstanding), and less sympathetically minded towards them, although willing enough, as the numerous early educational foundations indicate, to improve them in both mind and body. The supremacy of the English-speaking people in North America made theirs the controlling influence upon the aborigines in all parts of the country, in the Pacific coast region to-day as formerly in the eastern United States, where house-building, clothing and ornament, furniture, weapons and implements have been modified or replaced. Beside the Atlantic, the Micmac of Nova Scotia now has its English loan-words, while among the Salishian tribes of British Columbia English is "very seriously affecting the purity of the native speech" (Hill-Tout), and even the Athabaskan Nahané are adding English words to their vocabulary (Morice).

The English influence on tribal government and land-tenure, culminating in the incorporation of so many of the aborigines



as citizens of Canada and the United States, began in 1641. The first royal grants both in New England and farther south made no mention of the native population of the country, and the early proprietors and settlers were largely left to their own devices in dealing with them, the policy of extinguishing their titles to land being adopted as needed. Later on, of course, due recognition was had of the fact that certain parts of America were inhabited by "heathen," "savages," &c., and the chiefs of many of the tribes were looked upon as rulers with prerogatives of princes and royal personages (e.g. the "Emperor" Powhatan and the "Princess" Pocahontas, "King" Philip, the "Emperor" of the Creeks, &c.). The method of dealing with the Indian "tribes" by the Federal government as autonomous groups through treaties, &c., lasted till 1871, when, by act of Congress, "simple agreements" were favoured in lieu of "solemn treaties."

Meanwhile no consistent purpose was shown in dealing with the Indian problem. At one time the American policy was to concentrate all the Indians on three great reservations, an expansion of the plan adopted early in the 19th century which set aside the former "Indian country" (afterwards restricted to the Indian Territory). The sentiment in regard to great reservations, however, gradually weakened, till in 1878 it was proposed to concentrate the Indians on smaller reservations; but the entire reservation system became increasingly unpopular, and finally in 1887 Congress enacted the Land Severalty Law, paving the way for abolition of the reservation and agency system; at the same time it emphasized the government policy of gradually (the reservation system was a preliminary step in the way of bringing the Indians more under government control) bringing about the cessation of all "tribes" as independent communities and securing their ultimate entrance upon citizenship with the white population. This certainly was far removed from the declaration of the Virginia Assembly in 1702 that "no Indian could hold office, be a capable witness, or hunt over patented land"; and at this time also, "an Indian child was classed as a mulatto, and Indians, like slaves, were liable to be taken on execution for the payment of debt." As Miss Fletcher (*Handb. of Amer. Inds.*, 1907, pt. i. p. 501) notes, the ordinance of Congress passed in 1787 respecting the duty of the United States to the Indian tribes, which was confirmed by the act of 1780, was reaffirmed in the organizing acts of Alabama, Colorado, Dakota, Idaho, Illinois, Iowa, Kansas, Michigan, Minnesota, Mississippi, Montana, Nebraska, Nevada, Oregon, Wisconsin and Wyoming.

The Land Severalty Law of 1887 (amended 1890) provided for the survey of reservations and the allotment to each person of a tract ranging from 40 to 160 acres, the remainder being sold to white settlers. The process of dividing the Indian lands into individual allotments and disposing of the remainder for the benefit of the tribe or the nation has been very successful in many cases. This policy has culminated in a recent decision of the United States Supreme Court, by virtue of which all Indians living upon their own allotments were declared to be citizens, on the same terms and subject to the same laws as the whites.

During the period 1609-1664, from the visit of Hudson to the surrender of New Amsterdam to the English, the Dutch exercised not a little influence upon the aborigines of the present state of New York and some of the regions adjoining. Hudson's harsh treatment of the natives caused the Dutch trouble later on. Through their trading-post of Fort Orange (now Albany) they came into contact with both Iroquoian and Algonkian tribes, carrying on an extensive trade in furs with some of them, including the New England Pequots. They sided with the Iroquois against the northern Algonkian tribes, but also aided the Mohegans against the Shawaks. Farther south they helped the Senecas against the Muncses. Their quarrels with the English involved many of the Indian tribes on one side or the other. They have been generally condemned for their readiness to furnish the Indians with firearms and intoxicating liquors, though some of these actions were doubtless performed by individual traders and settlers only and cannot be charged to a deliberate policy of the government. The modern title of *Kora*, given by the Canadian Iroquois to the governor-general (also to the king of England), is a corruption of *Corlaer*, the name of

a trusted Dutch manager of Rensselaerwyck (cf. the Iroquois name for the French governor, *Onontio* = Montmagny).

German influence among the American Indians north of Mexico has made itself felt among the Eskimo (particularly in Labrador), the Delawares and Mohegans, the Iroquois and the Cherokee, where the Moravian missionaries did much good work. They influenced the Indians for peace and good conduct during the great wars. In Labrador the dress, habitations and beliefs of the Eskimo have been considerably modified. It is said by some that Sequoyah, the inventor of the "Cherokee alphabet," had for father a German settler.

The great influence of the Spaniards upon the American Indians has been treated by Blackmar in his *Spanish Institutions in the South-west*, and by Lumis, Bourke, Hodge and other authorities. The results of Spanish contact and control are seen in the loan-words in the various languages of the region, the consequences of the introduction of domestic animals (horses, mule, sheep, goat, fowls), the perfection of the arts involved in the utilization of wool, the planting of wheat, the cultivation of peaches and other exotic fruits. The difference between the Navaho and their close kinsmen the Apache may be largely attributed to changes wrought by the coming of the Spaniards. The "Mission Indians" of California represent another great point of contact. In California thousands and thousands of Indians were converted and brought under the control of the able and devoted missionaries of the Catholic Church, only to become more or less utterly helpless when Spanish dominion ceased and the missions fell into decay. Traces of Spanish influence may be found as far north as the Saskatchewan, where personal names implying origin from a Mexican captive occur; and there is not a little Spanish blood in some of the tribes of the Great Plains, who often took with them from their border raids, or acquired from other tribes, many white prisoners from Mexico, &c.

In Alaska the influence of Russian sailors, traders and settlers during the period of occupancy was considerable, as was also that of the priests and missionaries of the Greek Church, but much of what was thus imposed upon the aborigines has now been modified or is being submerged by the more recent influences of the English-speaking settlers, miners, &c., and the efforts of the American government to educate and improve them. The influence of the Russians extended even to California, as the name "Russian River" would indicate, and Friederici (*Schiffahrt der Indianer*, 1907, p. 46) even thinks that to them is due the sporadic occurrence in that region of skin-boats. It was through the Russians that the Alaskan Eskimo received tobacco. Some Russian words have crept into certain of the Indian languages. It is seen that the Russian authorities from time to time transported a few Indians over-sea to Kamchatka, &c.

The general question of the relations of the Europeans in North America with the Indians has been treated by various authors, one of the most recent being Friederici, whose *Indianer und Amerikaner* (Brunswick, 1900) is perhaps a little too prejudiced.

The contact between the races in North America has had its darker side, seen in the numerous conflicts and "wars" that have marked the conquest of the continent by the whites and the resistance of the weaker people to the inevitable triumph of the stronger. The following sketch of the warlike relations of various Indian stocks with the European colonists and their descendants brings out the principal facts of historic interest.

*Eskimoan.*—The history of warfare between the European colonists (and their descendants) and the North American aborigines begins with the conflict of Eskimo and Northernmen in Greenland, the last phase of which, in the first half of the 15th century, ended in the destruction of the European settlements and the loss of knowledge of the Eskimo to the Old World till they were rediscovered by Frobisher in 1576 and Davis in 1585. Then came a new series of small conflicts in which the whites have been the chief aggressors—whalers, sealers and other adventurers. In the extreme north-west the Aloues were very harshly treated by the Russians, and one of the most recent deeds of brutality has been the reported extermination, by irresponsible whalers, of the Eskimo of Southampton Island in Hudson's Bay.

*Algonkian and Iroquoian.*—Southward, along the Atlantic coast, the period of actual settlement by the whites in large numbers was preceded by numerous conflicts with the Algonkian Indians in which all too often the whites (adventurers, fishermen, &c.) were principally at fault, the natives being some of the chief sufferers. In the extreme north-west the Aloues were very harshly treated by the Russians, and one of the most recent deeds of brutality has been the reported extermination, by irresponsible whalers, of the Eskimo of Southampton Island in Hudson's Bay.

*Algonkian and Iroquoian.*—Southward, along the Atlantic coast, the period of actual settlement by the whites in large numbers was preceded by numerous conflicts with the Algonkian Indians in which all too often the whites (adventurers, fishermen, &c.) were principally at fault, the natives being some of the chief sufferers. In the extreme north-west the Aloues were very harshly treated by the Russians, and one of the most recent deeds of brutality has been the reported extermination, by irresponsible whalers, of the Eskimo of Southampton Island in Hudson's Bay.

The battle fought and won by Champlain near Ticonderoga in 1609 made the Iroquois the lasting antagonists of the French, and, since the former held a large portion of what is now the state of New York, the latter were effectually prevented from annihilating or destroying the English colonies to the south. The Iroquois alliance with the English in New York was preceded by

Indian wars.

one with the Dutch. Another result of the feud between the Iroquois and the French was the destruction of the confederacy of the *Hurons*, themselves a people of Iroquoian stock, established in the region between Lakes Ontario, Erie and Huron, over a large portion of what is now the province of Ontario, although the antagonism between Hurons and Iroquois had existed even before the coming of Carrier and the inevitable conflict had already begun. As an outlet of Champlain's country, the Hurons were the first of the Jesuit missionaries had established themselves among these Indians and for thirty-five years laboured with a devotion and sacrifice almost unparalleled in the history of the continent. The struggle ended in the campaign of 1648-1649, in which the Iroquois destroyed the Huron settlements and practically exterminated the people, the French priests in many cases having suffered martyrdom in the most cruel fashion at the hands of the savage conquerors. Such of the Hurons as succeeded in escaping took refuge in some of the safer French settlements or found shelter among friendly Indian tribes farther west. Some of these refugees have their descendants among the Hurons of Lorette to-day and among the Wyandots of Oklahoma. The *Tionontati* (Tobacco Nation) Hurons continued the struggle for some time longer, a battle being fought in 1659 on the Ottawa above Montreal, in which the Iroquois were victorious and the Huron chief slain. As late as 1747-1748 some of the Hurons, who had taken refuge in the west, under Orontony, a wily and unscrupulous chief, who was offended at certain actions of the French, entered into a conspiracy with many Algonkian tribes of the region to destroy the French post at Detroit, &c., which, however, proved unsuccessful, the plot being revealed through the treachery of a Huron woman. A notable event in the French-Iroquois wars was the attack on Montreal in 1689. After the coming of Frontenac as governor of Canada the wars between the French and English involved some of the Indian tribes more and more, on one side or the other, the *Mohawks* especially, who took part against the French, being famous for their raids from the region of Ohio to far into New Brunswick. During the French war and the American War of Independence the Algonkian and Iroquoian Indians serving on both sides were in part or wholly responsible for numerous massacres and other acts of barbarity, though the whites sometimes showed themselves fully the equals of the savages they condemned.

In New England the most notable conflicts were "the *Pequot* war" of 1637-1638 and "King Philip's war" of 1675-1676, the latter resulting in the overthrow of a powerful confederacy, which at one time threatened the very existence of the colony, and the practical extermination of the Indians concerned, although great havoc had been wrought by them in the white settlements. New England also suffered much from Indian "wars" instigated by the French, and at Caughnawaga and other Iroquois settlements in French Canada there is much white blood resulting from the adoption of captives taken away (e.g. at Marlboro and Deerfield, Mass., in 1703-1704) in raids on New England villages. Celebrated in the annals of war are the Algonkian chiefs Tecumseh (Shawnee), who aided the British in the war of 1812, and Pontiac (Ottawa), whose remarkable captivity of 1763 has been studied by Farkman; of noted Iroquoian chiefs and warriors may be mentioned Joseph Brant, who fought for the British in the War of Independence, and Logan, ill-famed for his barbarities perpetrated against the border settlements on the Ohio, 1775-1780, &c.

In Virginia the future of the English colony was not absolutely assured much before 1620. From the founding of Jamestown in 1607 until about 1616 the colony was in more or less danger of extinction by starvation or destruction at the hands of the Indians. The most famous and romantic of the Indian wars of Virginia was that in which the tribe of Powhatan, under the leadership of Powhatan and Opechancanough, when his rescue by Pocahontas is said to have taken place. Under Opechancanough massacres of the English settlers took place in 1622 and 1644 in particular, while intermittent hostilities continued between these dates, many hundreds of whites being slain by the Powhatan Indians and their confederates of Algonkian stock. As a result of wars with the English and also with other Indian tribes, many of the Algonkian peoples of Virginia, like some of the Iroquoian peoples farther south, were by the end of the 17th century greatly reduced in number. In the Carolinas the first serious conflicts with the whites about 1840, made their first incursion into Mexico in 1853, and between 1860 and 1878-1879, according to Mooney, "they were prominent in border warfare. . . and have probably lost more in conflict with the whites than any other tribe of the plains in proportion to their number." They participated in the "Sitting Bull war" of 1876.

The *Chippewa* of the north-western United States in the latter

half of the 18th century and till the close of the war of 1812 kept up warfare with the border settlements, but have been generally peaceful since 1815, when a treaty was made. The only serious outbreak among the *Cree*, who have been generally friendly to the whites from the period of first contact, occurred during the Riel "rebellion" of 1885, but was soon settled. In the latter part of the 18th century (up to the treaty of Greenville, 1795) the *Delaware* took a prominent part in the wars of the Indians against the whites. The *Kickapoos* were concerned in the Indian plot to destroy the fort at Detroit in 1712, and a hundred years later they aided the English against the Americans; in 1832 numbers of them helped Black Hawk in his war against the whites. The *Miamac* were long hostile to the English, being prominent as aids to the French in the New England wars, and it was not until about 1779 or long after the French cessation that conflicts between these Indians and the whites came to an end. The *Mississaguas* fought with the Iroquois against the French about 1750, having become friendly with the English and remaining so. The *Ottawa* were prominent in the wars of the region about Detroit from 1750 till 1815. Pontiac, whose "conspiracy" of 1763 is noted in American history, was an Ottawa chief. The *Penobscot*, as friends of the French, continued their attacks on the English settlements till about 1750. The *Sacs* and *Foxes* appear early in the 18th century as antagonists of the French (a rare thing among Algonkian peoples) and they were the instigators of the nearly successful attack on Detroit in 1712. In the war of 1812 most of these Indians sided with the British. Black Hawk, the chief figure in the war of 1831-32, was a Sac and Fox chief, who endeavoured to engage all the Indian tribes of the region in a general alliance against the whites. The *Shawnees* were prominent in the border warfare of the Ohio region, and their famous chief Tecumseh fought for the British in the war of 1812.

*Athabaskan*.—The Athabaskan tribes of the far north, with the exception of occasional disputes with the traders and settlers, have generally been of a peaceful disposition, and "wars" with the whites have not been recorded to any extent. The warlike members of this stock have been the Apache and the Navaho. The *Apache* from the middle of the 16th century have given evidence of their instinct for raids and depredations on the frontiers of civilization. In recent times the most noteworthy outbreaks were those under Cochise, Victorio, Geronimo, Nana, Nakaidokini, &c., between 1870 and 1886, in which several hundred whites in Mexico and New Mexico were killed and much property destroyed. As late as 1906 some of the hostile Apaches, who had escaped to the mountains, made a raid on the Mormon settlers in Chihuahua, Mexico. The *Navaho*, when the Navaho invasion passed into the domain of the United States in 1849, had long lived in the habit of committing depredations upon the white settlements and the Pueblos. These wars "continued till 1863, when 'Kit' Carson completely defeated them and the greater part of the tribe were made prisoners. Since their release in 1867 they have thriven in peace, although occasionally serious trouble has threatened, as, e.g., in November 1905.

*Caddoan*.—The *Caddo* proper were friendly to the French and helped them against the Spaniards in the wars of the 18th century. After the annexation of Texas the Indians were badly treated and some of them made answer in kind; in 1855 a massacre of the Indians was proposed by the whites. Since their forced march to Oklahoma in 1859 they have been at peace. Their *Arikara* had a brief conflict with the United States authorities in 1823, as a result of the killing of some traders. In the wars of the 18th century the *Kickai* adhered to the cause of the French. The *Pawnee* seem never to have warred against the United States, in spite of much provocation at times.

*Californian Stocks*.—Such "wars" as are recorded, for the most part, by the miners and California states against the whites, have been largely direct or indirectly instigated by the latter for various purposes of gain. The *Lutatumian* stock is remarkable as (furnishing both the *Klamath*, who have always kept peace with the whites, and the *Modoc*, who are well known through the "Modoc war" of 1872-73 under the leadership of their chief, Kintpuash or "Captain Jack."

*Kiowan*.—The Indians of the Kiowan stock joined with the Comanche, Apache, &c., in the border wars in Texas and Mexico, and, according to Mooney, "among all the prairie tribes they were not so numerous as the white soldiers." The *Arikara* have probably killed more white men in proportion to their numbers than any other. They have been on their present reservation since 1868, and the only outbreak of importance latterly occurred in 1874-75, when they joined with the Comanche, Cheyenne, &c.

*Muskogean*.—This stock has furnished some of the most warlike Indians of the continent. The *Chickasaw* were friendly to the English, or rather hostile to the French, in the 18th century (war of 1736-40), and their action practically settled the question of the location of French power in the region. The *Woochee* aided the French in the war of the 18th century, and a few Indians of this tribe participated in the "Creek War" of 1813-14. The *Creeks* or *Muskogees* are famous on account of the terrible war of 1813-14 in which they sustained overwhelming defeat. Earlier they were hostile to the Spaniards in Florida, and during the 18th century were generally friendly to the English, particularly in the "Apalachee war" of 1703-08, when they served under Governor Moore of

Carolina. Another Muskogian people, the *Seminole*, are remembered for the long and bloody "Seminole War" in Florida, 1835-45, in which many atrocities were committed.

**Sahapian.**—The Indians of this stock have been generally very friendly to the whites, and the only notable "war" occurred in 1877, when the *Nez Percés*, under their famous chief, Joseph, resisted being confined to their reservation in Idaho. Joseph displayed wonderful generalship; he defeated the American troops several times, and finally executed a most remarkable retreat, over 1000 m., in an attempt to reach Canadian territory. This was foiled within a short distance of the boundary, and the entire force surrendered to General Miles on 18 July, 1877.

**Shoshonians.**—North of Mexico, this great stock has developed several warlike peoples. Trouble with the *Bannock* occurred in 1877-78, resulting from the encroachment of the whites at the time of the *Nez Percés* war, the killing of several settlers, scarcity of food, &c. The outbreak was ended by a campaign under General Howard in which many Indians, men, women and children, were killed and some one thousand taken prisoners. The *Comanche*, through a long period of more than 150 years after the Spanish occupation, kept up a continual series of raids and depredations upon the settlements of the whites in Mexico, &c., their general attitude towards Americans in the early years did not extend to the Texans, with whom for more than thirty years they indulged in savage warfare. They often entered into warlike alliance with the *Apache*, the *Kiowa*, &c. After the outbreak of 1874-75 they settled down for good. The leader in this "war" was Quana Parker, a half-blood Comanche, who, after the matter was settled, accepted broadly the new order of things and became "the most prominent and influential figure among the three confederated tribes" (Mooney). The *Paiute*, *Shoshonees* (*Snakes*) and *Utes* have figured in several more or less temporary outbreaks since 1865.

**Sioux.**—This great stock has had its celebrated antagonists of the whites as well as its famous combatants of other Indian tribes. The *Dakota* (or *Sious*) were unfriendly to the French for aiding their enemies, the Chippewa, and after the fall of French power in America in 1763, they allied themselves with the English and assisted them in the War of Independence and the war of 1812, with few exceptions. After the treaty of peace in 1815 various minor troubles occurred, but in 1862 the Indians in Minnesota rose under Chief Little Crow and committed terrible barbarities against the settlers, some 800 whites being killed before the revolt was put down. The gold-fever of the whites in Dakota, where the Indians had settled down, precipitated a formidable outbreak in 1876 under the leadership of Sitting Bull, Crazy Horse, Spotted Tail and other chiefs. The most notable event of this "war" was the so-called "massacre" (the early cutting-off) of General Custer and his cavalry at the battle of Little Bighorn on June 25, 1876. When the "Ghost Dance" was prevalent among so many Indian tribes of the Plains in 1890-1891 another serious rising of the Sioux took place, which was put down by General Miles. Sitting Bull was killed (December 15, 1890); and resistance to an attempt to disarm a large party of Indians at Wounded Knee Creek, near the Pine Ridge Agency, resulted (December 29) in a deplorable massacre, in which many women and children were killed. The story of these Sioux outbreaks and the guiltiness of the whites with respect to them has been told authoritatively by Mooney (*5th Ann. Rep. Bur. Ethnol.*, 1892-1893). At one time these troubles threatened to involve the Canadian Indians of the region adjacent. The *Catawba* of South Carolina, in the wars of the 18th century, aided the English against the French, the *Tuscaroras* (war of 1713-14) and the *Lake* tribes. They sided with the Americans during the War of Independence. The *Osage* were friendly with the French early in the 18th century and fought with them against the *Sacs* and *Foxes* at Detroit in 1714.

**Pueblos.**—After the Spanish conquest of the Pueblos Indians of Arizona and New Mexico the most remarkable effort of the natives to throw off the foreign yoke was in the general revolt of 1680 under the leadership of Popé of San Juan. At that time among the *Moqui* (*Shoshonians*) the missionaries were killed, the churches laid in ruins, &c., and similar events occurred elsewhere in the *Pueblos* region. For this the Spaniards subsequently took ample vengeance. The *Pueblos* Indians in general have never taken too kindly to the whites; and to-day at the *Moqui pueblo* of Oraibi there exist a "Hostile" and a "Friendly" faction, the first bitterly opposed to the Caucasian and all his ways, the latter more liberal-minded, but Indian none the less. An open rupture nearly took place in 1906.

In Canada, since the organization of the Dominion in 1867, Indian wars have been unknown, and Indian outbreaks of any sort rare. In 1890 an outbreak of the *Kootenays* was threatened, but it amounted to nothing—the present writer traversed all parts of the *Kootenay* country in 1891 in perfect safety. Occasional "risings" have been reported from the Canadian North-West and British Columbia, but have amounted to little or nothing. In the matter of war it should be noted that some Indian stocks have been essentially peaceful, and have resorted to force only when driven beyond endurance or treated with outrageous injustice. Again, within the same stock one tribe has shown itself peaceable, another quite warlike (e.g. *Klamath* and *Modoc*, both *Lutnami*; the *Hares* and the *Apache*, both *Athapascans*). Probably the amount and extent of wars existing north of Mexico in Pre-Columbian times were not as

large as is generally stated. The introduction of fire-arms, European-made weapons, the horse, &c., and the development of ideas of property made possible through these, doubtless stimulated intertribal disputes and increased the actual number of warlike enterprises. Over a large portion of the continent "wars" were nearly always initiated and carried out by a portion only of the tribe, which often had its permanent "peace party."

The missionary labours of the various Christian churches among the North American aborigines have been ably summarized by Mooney in the *Handbook of American Indians North of Mexico* (pt. i, 1907, pp. 874-900). Besides the famous *Relation des Jésuites* (ed. Thwaites, 1896-1901) there are now special mission histories for the Baptists, Congregationalists, Episcopalians, Lutherans, Methodists, Moravians, Mormons, Presbyterians, Quakers, Roman Catholics (also the various orders, &c.), who have all paid much attention to Christianizing and civilizing the Indians. To-day "practically every tribe officially recognized within the United States is under the missionary influence of some religious denomination, workers of several denominations frequently labouring in the same tribe." Something of the same sort might be said of the Indians of Canada, whose religion (that of 765,310 out of 110,345 altogether reported, is known) is given as follows in the *Report of the Department of Indian Affairs for 1907*: Roman Catholics 35,682; Anglicans 15,380; Methodists 11,620; Presbyterians 1527; Baptists 1103; Congregationalists 18; and other denominations 507; besides 10,347 pagans. All the Indians of Nova Scotia, New Brunswick, and Prince Edward Island, are Catholics; in Quebec there are but 678 Protestants (mostly Methodists); in Ontario there are 6173 Catholics to 1030 Baptists, 4626 Methodists, 5306 Anglicans, 18 Congregationalists and 34 Presbyterians. The Indians of British Columbia number 11,529 Catholics, 4304 Anglicans, 3277 Methodists and 431 Presbyterians; those of Manitoba, 1780 Catholics, 1683 Methodists, 381 Presbyterians and 3103 Anglicans; those of Saskatchewan and Alberta 4249 Catholics, 1527 Methodists, 719 Presbyterians, 2549 Anglicans. In some of the tribes and settlements both in Canada and in the United States missionary activities, the influence of individual white men, &c., have led to a great diversity of religious faith, sometimes within comparatively limited areas. Thus in the *Mistawasis* band of Cree, belonging to the *Carlton Agency*, province of Saskatchewan, numbering but 129, there are 6 Anglicans, 86 Presbyterians and 37 Catholics; in the *Oak River* band of *Sioux* in *Manitoba* there are 60 Anglicans, 1 Presbyterian, 13 Methodists, 4 Catholics and 195 pagans out of a total of 273. Among the "Six Nations" and the larger Indian peoples of Oklahoma all the leading Christian sects, besides the *Salvation Army*, the *Christian Scientists*, the *Mormons* and the "New Thought" movement are represented. There are also the "Navaho New Faith," the "Shaker Church" of Washington, &c. The history of missionary labours in North America among the aborigines contains stories of disappointment and disaster as well as chronicles of success. Some peoples, like the *Timuquans*, the *Apalachee*, the *Pakawan* tribes, &c., have been converted only to disappear altogether; other great attempts at civilization or "reduction," like the missions of *Huron* and *California*, succeeded for the time on a grand scale, but have fallen victims sooner or later to the fortunes of war, the changes of politics, or their own mechanism and its inherent weaknesses and defects. But the thousands of good church-members, including many ministers of the Gospel, in Canada and the United States, coming from scores of different tribes and many distinct stocks, no less than the general good conduct of so many Indian nations, are a remarkable tribute to the work done by Catholic and Protestant missionaries alike all over the broad continent from the Mexican border to the snows of Greenland and the islands of the Arctic. The martyrdom of the *Jesuits* among the fierce *Iroquois*, the zeal of *Duncan* at *Metlakatla*, the fate of the Spanish friars in the *Pueblos* rebellions of 1680 under *Popé*, the destruction of the *Huron* missions in 1641-1649 and of those of the *Apalachee* in 1703, the death of *Whitman* at the hands of the *Cayuse* in 1847, are but a few of the notable events of mission history. The following

Missions and Education.

brief accounts of missionary labours among one or two of the chief Indian stocks and in a few of the chief areas of the continent will serve to indicate their general character.

**Californian Indians.**—Beginning with the foundation by Father Junipero Serra in 1769 of San Diego de Alcalá, and ending with that of San Francisco Solano in 1823, there were established, from beyond San Francisco Bay to the River Colorado, twenty-three missions of the Catholic faith among the Indians of California, whose direct influence lasted until the "secularization" of the missions and the expulsion of the friars by the Mexican government in 1834. In that year the missions counted 30,650 Indians and produced 122,500 bushels of wheat and corn. They possessed also 424,000 cattle, 62,500 horses and mules, 321,900 sheep, and 1,000 swine. The principal buildings of brick and stone contained besides religious houses and chapels, schools-rooms and workshops for instruction in arts and industries, and were surrounded by orchards, vineyards and farms. Here Indians of diverse linguistic stocks were "reduced" and "civilized," and their labour fully utilized by the missionaries. But, in the words of Mooney (*Handb. of Amer. Inds.*, pt. i., 1907, p. 895), "Despite regular life, abundance of food and proper clothing according to the season, the Indian withered away under the restrictions of civilization supplemented by epidemic diseases introduced by the military garrisons or the seal-hunters along the coast. The death was so enormous, in spite of apparent material advancement, that it is probable that the former factor alone would have brought about the extinction of the missions within a few generations." Some of the missions had but a few hundred Indians, some, however, as high as three thousand. Kroeber thinks that their influence was "probably greater temporally than spiritually." After the "secularization" of the missions decay soon set in, which the American occupation of California later on did nothing to remedy, and the native population rapidly decreased. When the supervision of the missionaries no longer sustained them, the Indians fought pieces and the practical result of twenty years of labour and devotion were lost. In 1908 there remained of the "Mission Indians" less than 3000 individuals (belonging to the Shoshonian and Yuman stocks), whose condition was none too satisfactory, the only human relics of the huge attempt at the "reduction" of the Indian that was planned and carried out in California.

**Iroquoian.**—The French missions among the Hurons began in 1615-1616 with Father le Caron of the Recollet order; those of the Jesuits with Father Brebault in 1626. These missions flourished, in spite of wars and other adverse circumstances, till the invasion of a Huron country in Ontario by the Iroquois in 1641 and again in 1649 brought about their destruction and the dispersal of the Hurons who were not slain or carried off as prisoners by the victors. Some took refuge among neighbouring friendly tribes; others settled finally at Lorette near Quebec, &c. The Wyandots, now in Oklahoma, are another fragment of the scattered Hurons. The Hurons of Lorette numbered in 1908, 1 Anglican, 6 Presbyterians and 459 Catholics. The Wyandots of Oklahoma are largely Protestants. The mission among the Mohawks of New York was established in 1642 by Father Jogues (afterwards martyred by the Indians), and in 1653 the church at Onondaga was built, while during the next few years missions were organized among the Oneida, Cayuga and Seneca, to cease during the warlike times of 1658-66, after which they were again established among these tribes. The mission of St. Francois Xavier des Pré (La Prairie), out of which came the modern Caughnawaga, was founded in 1660, and here gathered many Christian Iroquois of various tribes—Mohawk especially. About this time the Iroquois settlement on the Bay of Quinté, Ontario, was formed by Christian Mohawks, Cayugas, &c. The Lake of the Two Mountains mission dates from 1720, that of St. Regis from 1759. Another mission at Oswegatchie, founded in 1748, was abandoned in 1807. The Episcopal missions among the Iroquois began early in the 18th century, the Mohawks being the first tribe influenced, about 1700. The extension of the work among the other Iroquoian tribes was aided by Sir William Johnson in the last half of the century and by Chief Joseph Brant, especially after the removal of those of the Iroquois who favoured the British to Canada at the close of the War of Independence. In 1776 the Congregationalists established a mission among the New York Oneida, and later continued their labours also among the Oneida of Wisconsin. The Congregational mission among the New York Seneca began in 1831. In 1791-1798, at the request of Chief Cornplanter, the Pennsylvania Quakers established missions among the Oneida, Tuscarora and Seneca. The Moravian missions among the New York Onondaga were established under the Rev. David Zeisberger about 1745. The Methodist missions among the Ontario Iroquois date from 1820. Of the "Six Nations" Indians of the Grand river, Ontario, the Cayuga and Onondaga are still "pagan," the others being Anglican, Methodist and other denominations, including Seventh Day Adventists, Salvation Army, &c. Among the New York Iroquois great variety of religious faith also exists, the Presbyterians being the largest, the Episcopalians and Baptists being all represented. The Iroquois of Caughnawaga and St. Regis are mainly Catholic; at Caughnawaga there is, however, a Methodist school.

**Muskogian.**—Several tribes of this stock came under the influence of the missions established by the Spanish friars along the Atlantic coast after the founding of St. Augustine in 1565. The missionaries in this region were chiefly Franciscans, who succeeded the Jesuits. They were very successful among the Apalachee, but these Indians were constantly subject to attack by the Yamasi, Creek, Catawba and other savage peoples, and in 1703-1704 they were destroyed or taken captive, and the missions came to an end. A few of the survivors were gathered later at Pensacola for a time. In the early part of the 18th century French missions were established among the Choctaw, Natchez, &c., and the Jesuits laboured among the Alibamu from 1725 till their expulsion in 1764. From 1735 to 1739 the Moravians (beginning under Spangenberg) had a mission school among the Yamacraw, a Creek tribe near Savannah. In 1831 a Presbyterian mission was established among the Choctaw on the Yalabusha river in northern Mississippi, to which went in 1834 the Rev. Cyrus Byington, the Eliot mission over which he presided there and in the Indian Territory till 1868 being one of great importance. After the removal of the Indians to the Indian Territory more missions were established among the Choctaw, the Creek and the Seminole, &c. The work was much interfered with by the Civil War of 1861-65, but the mission work was afterwards reorganized. The Baptist missions among the Choctaw began in 1832 and among the Creek in 1839. The "Choctaw Academy," a high school, at Great Crossings, Kentucky, chiefly for young men of the Choctaw and Creek nations, was founded in 1819 and continued for twenty-four years. In 1835 a Methodist mission was established among the Creek, but soon abandoned, to be reorganized later on. Among the Indians of Oklahoma, the Catholic and Mormon churches and practically all the Protestant denominations, including the Salvation Army and the Christian Scientists, are now represented by churches, schools, missions, &c. The missionaries among the Muskogian tribes during the last half of the 18th century, as may be seen from Pilling's *Bibliography of the Muskogean Languages* (1889), furnished many able students of Indian tongues, whose researches have been of great value in philology. This is true likewise of labourers in the mission-field among the Algonkian, Iroquoian, Athabaskan, Siouan and Salishan tribes and among the Eskimo. The celebrated "Eliot Bible" (the translation (1663) of the scriptures into the language of the Algonkian Indians of Massachusetts, made by the Rev. John Eliot (q.v.), is a monument of missionary endeavour and prescientific study of the aboriginal tongues. In his work Eliot, like many other missionaries, had the assistance of several Indians. The names of such mission-workers as Egede, Kleinschmidt, Fabricius, Erdmann, Kohlmeier, Bruyas, Zeisberger, Dencke, Rasles, Gravier, Mengarini, Giorda, Worcester, Byington, Wright, Riggs, Dorsey, Williamson, Voth, Ellis, Pandosy, Veniaminov, Barnum, Andree, Mathevet, Thavenet, Cuq, Sagar, O'Meara, Jones, Wilson, Rand, Lacombe, Pettit, Meade, Hunter, Horden, Kirby, Watkins, Tims, Evans, Morice, Hall, Harrison, Legoff, Bompas, Peck, &c., are familiar to students of the aboriginal tongues of America.

When in 1900 the withdrawal by the United States of government aid to denominational schools occurred, it compelled some of the weaker churches to give up such work altogether, and interfered much with the activities of some of the stronger ones. According to the statistics given by Mooney (*Handb. of Amer. Inds.*, 1907, pt. i. p. 897) the Catholic Church had in 1904 altogether, under the care of the Jesuits, Franciscans and Benedictines, &c., and the sisters of the orders of St. Francis, St. Anne, St. Benedict, St. Joseph, Mercy and Blessed Sacrament, "178 Indian churches and chapels served by 152 priests; 71 boarding and 26 day schools with 109 teaching priests, 384 sisters and 138 other religious or secular teachers and school assistants." The Catholic mission work is helped by "the Preservation Society, the Marquette League and by the liberality of Mother Katharine Drexel, founder of the order of the Blessed Sacrament for negro and Indian mission work." The corresponding statistics for the chief Protestant churches were as follows:—

Denomination.	Missions and Churches.	Missionaries.	Schools.
Baptist	14	15	4
Congregationalist	10	12	5
Episcopalian	14	28	17
Friends	10	15	1
Mennonite	5	6	0
Methodist	40	40	1
Moravian	3	3	0
Presbyterian	101	69	32
Total	157	188	60

This is exclusive of Alaska, where Greek Orthodox (18 ministers

1902). Roman Catholics (12 Jesuits and lay brothers and 11 sisters of St Anne in 1903), Moravians (5 mission stations with 13 workers and 21 native assistants among the Eskimo in 1903), Episcopalians (31 workers, white and native, 13 churches, 1 boarding and 7 day schools in 1903), Presbyterians (a dozen stations and several schools), Baptists, Methodists (several stations), Swedish Evangelical (several stations), Friends (several missions), Congregationalists (mission school) and Lutherans (orphangee), all are labouring.

Before the advent of the whites the children of the North American aborigines "had their own systems of education, through which the young were instructed in their coming labours and obligations, embracing not only the whole round of economic pursuits—hunting, fishing, handicraft, agriculture and household work—but speech, fine art, customs, etiquette, social obligations and tribal lore" (Mason). Parents, grandparents, the elders of the tribe, "priests," &c., were teachers, boys coming early under the instruction of their male relatives and girls under that of their female relatives. Among some tribes special "teachers" of some of the arts existed and with certain of the more developed peoples, such as some of the Iroquoian and Siouan tribes, both childhood and the period of puberty received special attention. Playthings, toys and children's games were widespread. Imitation of the arts and industries of their elders began early, and with not a few tribes there were "secret societies," &c., for children and fraternities of various sorts, which they were allowed to join, thus receiving early initiation into social and religious ideas and responsibility in the tribal unit. Corporal punishment was little in vogue, the Iroquois e.g. condemning it as bad for the soul as well as the body. Appeals to the feelings of pride, shame, self-esteem, &c., were commonly made. As the treatment of the youth at puberty by the Omaha e.g. indicates, there was among some tribes distinct recognition of individuality, and the young Indian acquired his so-called "totem" or "guardian spirit" individually and not tribally. In some tribes, however, the tribal consciousness overpowered altogether children and youth. With the Indian, as with all other young human beings, "unconscious absorption" played its important rôle. Parental affection among some of the peoples north of Mexico reached as high a degree as with the whites, and devices for aiding, improving and amusing infants and children were innumerable. Some of the "beauty makers," however, amounted to rather serious deformations, though often no worse than those due to the corset, the use of uncouth foot-wear, premature factory labour, &c., in civilized countries.

Interesting details of Indian child-life and education are to be found in books like Eastman's *Indian Boyhood* (1902), Jenks' *Childhood of Jiskib the Ojibwa* (1900), Spencer's *Education of the Pueblo Child* (1889), La Flesche's *The Middle Five* (1901), Stevenson's *Religious Education of the Zuni Child* (1887), and in the writings of Miss A. C. Fletcher, J. O. Dorsey, J. Mooney, W. M. Beauchamp, &c., besides the accounts of missionaries and travellers of the better sort.

Outside of missions proper there has been many efforts made by the colonists to educate the Indians. It is an interesting fact, emphasized by James in his *English Institutions and the American Indian* (1894), that several institutions still existing, and now of large influence in the educational world of the United States and Canada, had their origin in whole or in part in the desire to Christianize and to educate the aborigines, which object was mentioned in charters (e.g. Virginia in 1606 and again in 1621), &c. Sums of money were also left for the purposes of educating Indian children and youth, many of whom were sent over to England for that purpose, by colonists who adopted them (one such was Sampson Occum, minister and author of the hymn, "Awaked by Sinai's Awful Sound"). In 1618 Henrico College in Virginia was founded, where Indian youth were taught religion, "civility" and a trade. It was succeeded by the College of William and Mary (founded in 1691 with the aid of a benefaction of Robert Boyle), where Indian youth were boarded and received their education for many years. The great university of Harvard has long outgrown "the Indian college at Cambridge," whose single graduate Cheeshateamuck, took his degree in 1665, but died afterwards of consumption. But its original charter provided for all things "that may conduce to the education of the English and Indian youth of

this country in knowledge and godliness." Since Cheeshateamuck's time, doubtless, there have been graduates of Harvard who could boast of Indian blood in their veins (e.g. recently William Jones, the ethnologist), but they have been few and far between. Dartmouth College, at Hanover, New Hampshire, founded in 1754, really grew out of Wheelock's Indian school at Lebanon, Connecticut—at this period there were several such schools in New England, &c. In the royal charter, granted to Dartmouth in 1769, is the provision "that there be a College erected in our said Province of New Hampshire, by the name of Dartmouth College, for the education and instruction of Youth of the Indian Tribes in this Land, in reading, writing and all parts of Learning which shall appear necessary and expedient for civilizing and christianizing children of pagans, as well as in all liberal Arts and Sciences, and also of English Youth and any other." The college of New Jersey long served as one of the institutions for the education of Indian youth. A glimpse of Indians at Princeton is given by Collins (*Princeton Univ. Bull.*, 1902) in his account of the attempt to confer an academic education, at the end of the 18th century, upon Thomas Killbuck and his cousin, George Bright-eyes, son of a Delaware chief, and a descendant of Taimened, eponym of the political "Tammany." It would seem that at this period the states and Congress were in the habit of granting moneys for the education of individual Indians at various institutions.

At the present time the most noteworthy institutions for the education of the Indian in the United States are the Chillico Indian Industrial school, under government auspices, in Kay county, Oklahoma, near Arkansas city, Kansas; the Carlisle school (government) at Carlisle, Pa.; and the Hampton Normal and Agricultural Institute (private, but subsidized by the government), at Hampton, Va.

The Chillico school is, in many respects, a model institution for Indian youth of both sexes, devoted to "agriculture and attendant industries." It was opened in 1884 with 186 pupils, and in 1906 the attendance was 685 out of an enrolment of 700. There are 35 buildings, and the corps of instruction, &c., consists of "a superintendent, 51 principal employes and 20 minor Indian assistants." The Carlisle school, "the first non-reservation school established by the government," whose origin is due to "the efforts of General R. H. Pratt, when a lieutenant in charge of Indian prisoners of war at St Augustine, Florida, from May 11, 1875, to April 14, 1878," was opened in November 1879 with 147 Indians, including 11 Florida prisoners; it had in 1906 an enrolment of over 1000 pupils of both sexes, under both white and Indian teachers, and an average attendance of 981. In 1906 there were in attendance members of 67 tribes, representing at least 22 distinct linguistic stocks. According to J. H. Dorch (*Handb. of Amer. Inds.*, 1907, pt. i, p. 207), "since the foundation of the school nearly every tribe in the United States has had representatives on its rolls." The following statistics, cited by Mr Dorch, indicate both the success of the school in general and of the "outing system" (pupils are allowed to work in temporary homes, but keeping in close touch with the school), which "has come to be a distinctive feature not only of the Carlisle school but of the Indian school service generally":

Admitted during 25 years	5,170
Discharged during 25 years	4,210
On rolls during fiscal year 1904	1,087
Outings, fiscal year 1904 (girls 426, boys 498)	924
Outings during 21 years (girls 3214, boys 5118)	8,332
Students' earnings 1904	\$34,970
Students' earnings during 15 years	\$352,951

The staff of the school consists of a superintendent, 75 instructors, clerks, &c. It has graduated "a large number of pupils, many of whom are filling responsible positions in the business world, and especially in the Indian service, in which, during the fiscal year 1903, 101 were employed in various capacities from teachers to labourers, drawing a total of £46,300 in salaries." The Carlisle football team competes with the chief white colleges and universities.

The Hampton Institute was established in 1868 by General S. C. Armstrong and trains both Negroes and Indians, having admitted the latter since 1878. It is partly supported by the government of Virginia and by the United States government, the latter paying \$467 a year for 120 Indian pupils, boys and girls (in 1906 there were in attendance 112, of whom 57 were girls and 55 boys), belonging to 33 different tribes, representing 13 distinct linguistic stocks. The following extract from the report of the principal for 1905-1906 is of interest: "Fifteen catechists among the Sioux still hold their own. There are two field-matrons and seven camp-school teachers, all coming into close touch with the more ignorant of the people. Four are physicians getting their living from their white patients

and doing more or less missionary work among their own people. William Jones has his degrees of A.M. and Ph.D., and is doing valuable ethnological work for the Carnegie Institution, Columbia University and the American Museum of Natural History in New York. James Murie is assisting in similar work for the Field Museum in Chicago. Hampton has but one Indian lawyer. There are about 50 students holding positions pretty steadily in government schools. About 40 boys have employment at government agencies, 20 being employed as clerks and interpreters, either at the agencies or at the schools. Ten boys are working in machine shops at the north and three are in the navy. A fair proportion are working on their farms; some have accumulated quite a little stock, and five are prosperous cattlemen, seven boys have stores of their own and make a good living from them." The Indian Department has now adopted the policy of giving industrial training and household economy the chief place in education, varying the instruction to suit the environment in which the boy or girl is to grow up and live and not mixing the needs of Alaska with those of California, or those of Dakota with those of Florida.

In Canada the most notable institutions for the education of the Indians are the Mohawk Institute at Brantford, Ontario; the Mount Elgin Institute at Muncey, Ontario; the Brandon Industrial school at Brandon, Manitoba; the Qu'Appelle Industrial school at Lebreton, Saskatchewan.

The Mohawk Institute is the oldest, having been founded in 1831 by the "New England Company," which began its work among the Canadian Iroquois in 1822. It is un denominational, aided by a government grant, and had in 1907 an average attendance of 106 out of an enrolment of 111 of both sexes. The Mount Elgin Industrial Institute was founded by the Methodist Missionary Society in 1847, and had an attendance for 1907 of 104 of both sexes. The Brandon Industrial school, under Methodist auspices, had in 1907 an attendance of 104 of both sexes. The Qu'Appelle Industrial school, under Roman Catholic auspices, had an average attendance of 210 of both sexes. All these schools receive government aid. As in the United States, Indian teachers and assistants are often employed when fitted for such labours.

The first appropriation by the Congress of the United States for the general education of the Indians was made in 1819, when the sum of \$10,000 was assigned for that and closely allied purposes, and by 1825 there were 38 schools among the Indians receiving government aid, but government schools proper date from 1873 (contract schools are four years older), the order of their institution being day schools, reservation boarding schools, then non-reservation boarding schools. In 1900 the contract schools were practically abandoned and the Indian appropriation devoted to government schools altogether. Latterly some departure from this policy has occurred, following a decision of the Supreme Court. In less than a century the expenditure for Indian education increased from an annual outlay of \$10,000 to one of about \$5,000,000, to which must be added the expenditures from private sources, which are considerable.

Exclusive of Alaska, there were in the United States in 1906, according to the report of the Commissioner of Indian Affairs, 324 Indian schools (government 261, mission 48, contract 15), with an enrolment of 30,929 and an average attendance of 25,492 pupils, costing the government annually \$3,115,953. Of the government schools 25 were non-reservation and 90 reservation boarding schools, and 146 day schools; of the mission schools 45 boarding and 3 day; of the contract schools 8 boarding and 6 public. The schools of a denominational character belonged as follows: 29 to the Catholic Church, 5 to the Presbyterian, 4 to the Protestant Episcopal, 2 to the Congregational, 2 to the Lutheran, and 1 each to the Evangelical Lutheran, Reformed Presbyterian, Methodist, Christian Reformed and Baptist. Besides there were in all 446 public schools on or near reservations which Indians could attend.

In Canada, according to the report of the Department of Indian Affairs for 1907, there was a total of 303 Indian schools (day 226, boarding 55, industrial 22), of which 45 were un denominational, 91 Church of England, 106 Roman Catholic, 44 Methodist and 1 Salvation Army. The total enrolment of pupils was 9618, with an average attendance of 6138. In several cases Indians attend white schools, not being counted in these statistics. The total amount appropriated for Indian schools during the year 1906-1907 was \$356,277.

The intelligence of the American Indians north of Mexico ranges from a minimum with the lowest of the Athabaskan tribes of extreme north-western Canada and the lowest of the Shoshonian tribes of the south-western United States to a maximum with the highest developed members of the Muskogian and Iroquoian stocks (both the Cherokee branch and the Iroquois proper). It must be remembered, however, that the possibilities of improvement by change of environment are very great, as is shown by the fact that the Hupa of California and the Navaho of Arizona and New Mexico (also the cruel and cunning Apaches) belong to the Athabaskan family, while the Shoshonian includes many of the "civilized nations" of ancient Mexico and, in particular, the famous Aztecs. One way of judging of the intellectual character of the various stocks of North American aborigines is from the "great men" they have produced during the historical periods of contact with the whites. Many of these stocks have, of course, not had occasion for the development of great men, their small numbers, their isolation, their lack of historical experience, their long residence in an unfavourable environment, their perpetual and unrestricted democracy, &c., are some of the sufficient explanations for this state of affairs, as they would be in any other part of the world. The Eskimoan, Athabaskan, Kuluschan, Wakashan (and other tribes of the North Pacific coast), Salishan and Shoshonian (except in Mexico) stocks, together with the numerous small or unimportant stocks of the Oregon-California and Gulf-Atlantic regions, have not produced any great men, although members of many tribes have been individually of not a little service to the intruding race in pioneer times and since then, or have been highly esteemed by them on account of their abilities or character, &c. Here might be mentioned perhaps Sacajawea (see *Out West*, xxii, 223), the Indian woman who acted as guide and helper of the Lewis and Clark expedition and saved the journals at the risk of her life (she has now a statue erected to her memory in Seattle); Louise Sighouin, the Sahaptian convert of whom the missionary de Smet thought so much; Catherine Tekakwitha, the "Iroquois saint," &c.

The following list will serve to indicate some of the "great men" of the Indian race north of Mexico and the stocks to which they have belonged; in it are included also some products of the contact of the two cultures:—

1. *Algonkian*.—In politics and in oratory, as well as in combat, this stock has produced notable characters, the conflict with the whites and the Iroquois doubtless serving to stimulate native genius. Among Algonkian notables may be mentioned "King Philip" and Powhatan; Pontiac and Tecumseh; Black Hawk; Sampson Occum; George Copway; Francis Assinickinac, &c.
2. *Athabaskan*.—The possibilities of this stock have been recently illustrated by the Apaches, who, on the one hand, have produced Geronimo, the chief who from 1877 to 1886 gave the United States authorities such trouble, and, on the other, Dr Carlos Montezuma, a full-blood Indian, who, after receiving a good education, served the government as physician at several Indian agencies, and in 1908 was practising his profession in Chicago and teaching in the College of Physicians and Surgeons and the Post-Graduate Medical School. From these southern Athabaskans much is to be expected under favouring conditions.
3. *Iroquoian*.—Here, as among the Algonkian tribes, circumstances favoured the development of men of great ability. Of these may be mentioned: Hiawatha, statesman and reformer (fl. c. 1450), the chief mover in the formation of the great "League of the Iroquois"; Captain Joseph Brant; "Red Jacket"; Oronhyatekha (d. 1906), the head of the Independent Order of Foresters, an important secret charitable society, a physician, and a man of remarkable power as an organizer.
4. *Sahaptian*.—A remarkable Indian character was Nez Percé Joseph, the leader of his people in the troubles of 1877. In 1905, at the general assembly of the Presbyterian Church, a delegate representing both whites and Indians was Mark Arthur (d. 1873), a full-blood Nez Percé and since 1900 the successful pastor (fully ordained) of the church at Lapwai, Idaho, the oldest Presbyterian church west of the Rocky Mountains.
5. *Siouan*.—The most famous Indian of Siouan stock is "Sitting Bull" (d. 1890), medicine-man and chief. Miss Angel de Cora, a Winnebago, was in 1908 instructor in art at the Carlisle school.

Another, not always just or fair, method of gauging the intelligence of the North American Indians is by their ability to

assimilate the culture of the whites and to profit by the contact of the two races. Curiously enough, some of the tribes at one time considered lowest in point of general intellectual equipment have shown not a little of this ability, and there is a marked difference in this respect between tribes belonging to one and the same stock. The Athabaskan stock e.g. shows such variations, or rather perhaps this stock in general exhibits a tendency to adopt the culture of other peoples, thus some of the Athabaskan tribes in Alaska have acquired elements of culture from the Eskimo; the Takulli have been influenced by the Tsimshian, and Nahané by the Tlingit, the Chilcotin by the Salish, the Sarcee by the western Algonkian tribes, and in the extreme south the Navaho by the Pueblos Indians. The Salishan stock has largely this same characteristic. Of these two peoples Mr C. Hill-Tout (*The Salish and Déné*, London, 1907, p. 50) says: "It would be difficult indeed to find two peoples more susceptible to foreign influences, more receptive of new ideas and more ready and willing to adopt and carry them out." In the relations established between them and the whites not enough advantage in the proper way has been taken of this "philoneism," which ought to have been the basis of their acquisition of our culture, or such aspects of it as suited them best. And perhaps there are other stocks of which, if we knew them well, similar things might be said. Of the Indians of the Shoshonian stock the Paiutes of Nevada and Arizona have shown themselves capable of making themselves necessary to the whites (farmers, &c.) of that region, and not falling victims to the "vices of civilization." Although they still retain their primitive *wickiups* (or rush huts), they seem actually to have improved in health, wealth and character from association with the "superior" race, a rare thing in many respects among the lower Indian tribes of North America. This improvement of the Paiutes causes us not to be surprised when we find the more cultured Moquis and the "civilized" Aztecs of ancient Mexico to belong to the same Shoshonian stock. Acculturation by borrowing has played an important rôle in the development of North American Indian ideas and institutions. This is well illustrated by the history of the Plains Indians, with their numerous intertribal societies, their temporary and their permanent alliances, federations, &c. If ways and means for the transfer of elements of culture indicate intelligence, some of these tribes must rank rather high in the scale. The Algonkian, Iroquoian and Muskogian stocks, both in the case of individuals and in the case of whole tribes (or their remnants), have exhibited great ability in the directions indicated. Of the Caddoan stock the Pawnees seem gifted with considerable native ability expressing itself particularly in the matter of religion (the Hupas, of the Athabaskan stock, seem also to have "a religious sense"). Some tribes of the Siouan stock have, both in the case of individuals and as peoples, given evidence of marked intelligence, especially in relation to psychic phenomena and the treatment of adolescent youth. In their culture, their ceremonies and ritual proceedings, as well as in their material arts, the Pueblos Indians of the south-western United States show, in many ways, their mental kinship with the creators and sustainers of the civilization of ancient Mexico and Central America. From the table of Indian tribes it will be seen that aborigines of the most diverse stocks have shown themselves capable of assimilating white culture and of adapting themselves to the new set of circumstances. Progress and improvement are not at all confined to any one stock.

A very interesting fact in the history of the education of the aborigines north of Mexico is the success of the attempt to

enable them to read and write their own language by means of specially prepared syllabaries, "alphabets," &c. The first of these, the still existing "Micmac hieroglyphics," so-called, was the work of Father le Clercq in 1665, improved by Father Kauder in 1866; one of the most recent, the adaptation of the "Cree syllabary" of Evans by Peck to the language of the Eskimo of Cumberland Sound. The basis of many of the existing syllabaries is "the Cree syllabary," or "Evans Syllabary," invented about 1841 by the Rev. James Evans, a Methodist missionary in the Hudson's

Bay region from the study of the shorthand systems current at that time. This syllabary and modifications of it are now in use (with much printed literature) for both writing and printing among many tribes of the Algonkian, Athabaskan (modified by Morice for the Carriers, by Kirkby and others for Chipewyan, Slavé, &c.), Eskimo (modified by Peck), Siouan (Cree syllabary used by Canadian Stonies) stocks. Among the Salishan tribes of the Thompson river region, the Shuswap, Okanagan, &c., a stenographic modification (reproduced by mimeograph) by Father le Jeune of the Duployan system of shorthand has been used with great success. But the most remarkable of all these syllabaries is one more of Indian than missionary origin, in its application at least, the well-known "Cherokee alphabet" of Sequoyah, an uneducated Cherokee half-blood, who got part of his idea from an old spelling-book though his characters did not at all correspond to English sounds—at first 82, later 86 syllables were represented. Invented about 1821 the "Cherokee alphabet" was first used for printing in 1827, and has been in constant use since then for correspondence and for various literary purposes. The effect of this invention is thus described by Mooney (*Myths of the Cherokee*, 1902):—

"The invention of the alphabet had an immediate and wonderful effect on Cherokee development. An account of the remarkable adaptation of the syllabary to the language, it was only necessary to learn the characters to be able to read at once. No school-houses were built and no teachers hired, but the whole Nation became an academy for the study of the system, until, in the course of a few months, without school or expense of time or money, the Cherokee were able to read and write in their own language. An active correspondence began to be carried on between the Eastern and Western divisions, and plans were made for a national press, with a national library and museum to be established at the capital, New Echota. The missionaries, who had at first opposed the new alphabet on the ground of its Indian origin, now saw the advisability of using it to further their own work."

In spite of absurdities of form and position in the characters of this syllabary, it serves its purpose so well that, as Pilling informs us (*Amer. Anthropol.*, 1893), "a few hours of instruction are sufficient for a Cherokee to learn to read his own language intelligibly," and in two and a half months the Cherokee child "acquires the art of reading and writing fluently in these rude characters." The success of the "Cree syllabary" was also astonishing, and in 1890, according to Maclean (*Canad. Soc. Folk*, p. 283), "few Cree Indians can be found who are not able to read the literature printed in the syllabic characters." Here again, "an Indian with average intelligence can memorize the whole in a day, and in less than one week read fluently any book written upon this plan," and many Indians learn to read fluently "with no other teachers but the Indians around the camp-fires." Morice reports equal success with his syllabary: "Through it Indians of common intelligence have learnt to read in one week's leisurely study before they had any primer or printed matter of any kind to help them on. We even know of a young man who performed the feat in the space of two evenings." Le Jeune's experience with the Shuswap and Thompson Indians is the same. The creation of a "literary" class among so many Indian tribes within a comparatively brief period is certainly a very interesting result, and one which gives evidence of native intelligence among children and adults alike (*Amer. Journ. Psychol.*, 1905).

For a general list of authorities on the American aborigines, see bibliography under AMERICA, section 3, *Ethnology*. The literature on the subject, already vast, is continually increasing and it is impossible to enumerate every contribution made by the large number of expert anthropologists working in this field. The chief works of a special nature have already been cited in the text. (A. F. C.)

**INDICATOR** (from Lat. *indicare*, to point out), that which points out or records. In engineering, the word is specifically given to a mechanical device for registering the pressure of the working fluid in an engine cylinder during a stroke of the piston, the record so provided being termed the "indicator diagram" (see STEAM-ENGINE). In chemistry, the word is generically applied to re-agents or chemicals which detect usually small quantities or traces of other substances; it is, however, more customarily restricted to re-agents which show whether a

substance or solution is acid, alkaline or neutral, the character being revealed in a definite colour change.

Here we shall only deal with indicators in this last restricted sense. They were first systematically employed in analytical chemistry by Robert Boyle, who used the aqueous extracts of the coloured principles present in red-cabbage, violets and cornflowers. The indicator most in use to-day is litmus (*q.v.*), whose solution is turned red by an acid, and blue by an alkali. Several synthetic indicators are employed in acidimetry and alkalimetry. The choice is not altogether arbitrary, for experiments have shown that some are more suitable for acidimetry, while others are only applicable in alkalimetry; moreover, the strength of the acids and bases employed may exert a considerable influence on the behaviour of the indicator.

The following are well-known synthetic indicators: haemoid, obtained from resorcin and sodium nitrite, resembles litmus. Phenolphthalein, obtained by condensing phenol with phthalic anhydride, is colourless both in acid and in neutral solution, but intensely red in the presence of alkali; the colour change is very sharp with strong bases, but tardy with weak ones, and consequently its use should be restricted to acidimetry when a strong base can be chosen, or to alkalimetry when a strong base is present.  $\alpha$ -Naphtholphthalein has also been used (*Biochem. Zeit.*, 1910, p. 381). Methyl orange, which is the sodium salt of the acid helianthin, obtained by diazotizing sulphilic acid and coupling with dimethylaniline, is yellow in neutral and alkaline solutions, but red in acid; the change is only sharp with strong acids. Para-nitrophenol, obtained in the direct nitration of phenol, yields a colourless solution in the presence of acids, and an intense yellow with alkalis. Of more recent introduction are: alizarin red, L.W.S. (alizarin monosulphonic acid), claimed by G. E. Knowles (*Abst. J.C.S.*, 1907, ii. 380) to be better than methyl orange in alkalimetry; 3-amino-2-methylquinoline, used by O. Stark (*ibid.* 1907, i. 974) in ammonia estimations; para-nitrobenzenazo- $\alpha$ -naphthol, shown by J. T. Hewitt (*Analyst*, 1908, 33, p. 85) to change from purple to yellow when alkalis are titrated with weak acids; para-dimethylaminoazobenzene-ortho-carboxylic acid, proposed by E. Rupp and R. Loose (*Ber.*, 1908, 41, p. 3905) as very serviceable in the estimation of weak bases, such as the alkaloids or centinolina ammonia; the "resorubin" of M. Barberio (*Gazzetta*, 1907, ii. 577), obtained by acting with nitrous acid on resorcin, which forms a violet, blue or yellow coloration according as the solution is neutral, alkaline or acid. Mention may be made of E. Linder's (*J. Soc. Chem. Ind.*, 1908, 27, p. 485) suggestion to employ metanil yellow, obtained by coupling diazotized meta-aminobenzenesulphonic acid with diphenylamine for distinguishing mineral from organic acids, a violet coloration being produced in the presence of the former.

**Theory of Indicators.**—The ionic theory of solutions permitted the formulation of a logical conception of the action of indicators by W. Ostwald which for many years held its ground practically unchallenged; and even now the arguments originally advanced hold good, except for certain qualifications rendered necessary by more recent research. In the language of the ionic theory, an acid solution is one containing free hydriions, and an alkaline solution is one containing free hydroxidions. A neutral solution contains hydriions and hydroxidions in equal concentration; this is a consequence of the fact that pure water itself undergoes a certain dissociation, and several different methods show that in the purest water obtainable the concentration of the free hydriions and hydroxidions is  $10^{-7}$  at 24°. Moreover, the law of mass-action (see CHEMICAL ACTIONS) demands that the product of the concentrations of the hydriions and hydroxidions in any solution is constant at a given temperature, and we see from the above values that this constant is  $10^{-14}$ . It follows, therefore, that the acidity or alkalinity of any solution can be expressed both in terms of hydriion or hydroxidion concentration. Many researches have been directed to classify acid and alkaline solutions according to the concentration of the hydriion. Conductivity determinations show that the maximum concentration of hydriion occurs in 5.8-N nitric acid, where it has a value of about 2-N, and the minimum occurs in 0.7-N potassium hydroxide, where its value is  $5 \times 10^{-14}$ , that of the hydroxidion being about 2-N. These figures apply to a temperature of 24°. Bearing in mind the concentration of the ions in a neutral solution, it is seen that a scheme of seven grades of "neutrality," differing by successive powers of ten, may be formulated. The concentration of hydriion and hydrox-

idion in any solution may be determined by several independent methods, and it is therefore a simple matter to prepare solutions of definite ionic concentrations and to test these with the object of obtaining a list of indicators according to their sensitiveness. It is found that litmus responds to concentrations of  $10^{-6}$ H<sup>+</sup> and  $10^{-6}$ OH<sup>-</sup>, a result which shows this dye to be the best indicator of true neutrality. Methyl orange responds to between  $10^{-5}$ H<sup>+</sup> and  $10^{-5}$ OH<sup>-</sup>; para-nitrophenol to between  $10^{-4}$ H<sup>+</sup> and  $10^{-4}$ OH<sup>-</sup>; and phenolphthalein to between  $10^{-3}$ OH<sup>-</sup> and  $10^{-3}$ H<sup>+</sup> Sahn (*Zeit. Elektrochem.*, 1904, 10, p. 341) gives a list of twenty-seven indicators classified on this principle. Other papers bearing on this subject are Friedenthal, *ibid.*, p. 113; Salsky, *ibid.*, p. 204; Fels, *ibid.*, p. 208; Scholtz, *ibid.*, p. 549; M. Handa, *Ber.*, 1909, 42, p. 3179.

The actual mechanism by which the indicator changes colour with varying concentrations of hydriion or hydroxidion is now to be considered. Ostwald formulated his ionization theory which assumes the change to be due to the transition of the non-dissociated indicator to the ionized condition, which are necessarily of different colours. On this theory, an indicator must be weakly basic or acid, for if it were a strong acid or base high dissociation would occur when it was in the free state, and there would be no change of colour when the solution was neutralized. Take the case of a weakly acid indicator such as phenolphthalein. The presence of an acid depresses the very slight dissociation of the indicator, and the colour of the solution is that of the non-dissociated molecule. The addition of an alkali, if it is strong, brings about the formation of a salt of phenolphthalein, which is readily ionized, and so reveals the intense red coloration of the anion; a weak base, however, fails to give free ions. An acid indicator of medium strength is methyl orange. When a strong substance is ionized and the solution shows an orange colour, due to a mixing of the red of the non-dissociated molecule and the yellow of the ionized molecule. Addition of hydriions lessens the dissociation and the solution assumes the red colour, while a base increases the dissociation and so brings about the yellow colour. If the alkaline solution be titrated with a strong acid, the hydriions present in a very small amount of the acid suffices to reverse the colour; a weak acid, however, must be added in considerable excess of the quantity properly required to neutralize the solution, owing to its weak dissociation. This indicator is therefore only useful when strong acids are being dealt with, while its strongly acid nature renders it serviceable for both strong and weak bases.

It seems, however, that in addition to a change in the ionic condition of an indicator, there are cases where the coloration is associated with tautomeric change. For example, J. T. Hewitt (*Analyst*, 1908, 33, p. 85) regards phenolphthalein and similar indicators as obeying the following equilibrium in solution,

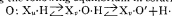

$X_n$  and  $X_n$  being isomeric. This indicates the presence of two tautomeric forms, one being of a quinonoid structure, and an ionized molecule. A similar view is advanced by A. Hantzsch and F. Hilscher (*Ber.*, 1908, 41, p. 1187) who find that helianthin is quinonoid when solid, whilst in solution there is an equilibrium between an aminazo- and sulphonic acid form; on the other hand, the sodium salt, methyl orange, is a sulphinate under both conditions.

**INDICTMENT** (from Anglo-Fr. *enditement*, *enditer*, to charge; Lat. *in*, against, *dictere*, declare), in English law, a formal accusation in writing laid before a grand jury and by them presented on oath to a court of competent jurisdiction. The accusation is drawn up in the form of a "bill" of indictment, prepared by the officer of the court or the legal adviser of the prosecution, engrossed on parchment, and sent before the grand jury. The grand jury hear in private the witnesses in support of the accusation (whose names are endorsed on the back of the bill), and, if satisfied that a prima facie case has been made out, find the bill to be a true bill and return it to the court as such. If otherwise, the jury ignore the bill and return to the court that they find "no true bill." Indictments differ from presents, which are made by the grand jury on their own motion and their own knowledge; and from informations, which are instituted on the suggestion of a public officer without the intervention of a grand jury.

An indictment lies for "all treasons and felonies, for misprison of treasons and felonies and for all misdemeanours of a public nature at common law." And if a statute prohibit a matter of public grievance or command a matter of public convenience all acts or omissions in disobedience to the command or prohibition of the statute are treated as misdemeanours at common law, and unless the statute otherwise provides are punishable on indictment. In other words, the ordinary common law remedy in respect of criminal offences is by indictment of the accused and trial before a petty jury; and except in the case of informations for misdemeanour and summary proceedings



by a court of record for "contempt of court" it is the only remedy, except where a statute creates another remedy, e.g. by trial before a court of summary jurisdiction.

The form of an indictment is still in the main regulated by the old common law rules of pleading, which as to civil pleadings were often amended during the 19th century, and finally abolished under the Judicature Acts.

An indictment may consist of one or more counts charging different offences. Each count consists of three parts: (1) the commencement, (2) the statement, (3) the conclusion. The formal commencement runs thus: "Surrey to wit." The first count begins "The jurors for our Lord the King (i.e. the grand jurors) upon their oath present that, &c.;" and the subsequent counts begin, the "jurors aforesaid on their oath aforesaid do further present." The first words, which are placed in the margin of the document, are the "venue," i.e. the county or district over which extends the jurisdiction of the court before which the indictment is found. Subject to certain statutory exceptions it is necessary to prove that the acts or omissions alleged to constitute the offence occurred within that area. The conclusion consists of the words following: "against the form of the statute (or statutes) in that case made and provided, and against the peace of our Lord the King, his crown and dignity." Where the offence is statutory the whole phrase is used; where it is at common law only the second part is used. A formal conclusion is not now essential to the validity of the indictment, but from inveterate habit is in continued use. The statement sets forth the circumstances alleged to constitute the offence, i.e. the accusation made. There are still in force a number of rules as to the proper elements in the statement; but in substance it is only necessary to set forth the facts alleged against the accused with accuracy and sufficient precision as to the time and place and circumstances of the alleged offence, and to indicate whether felony or misdemeanour are charged, and so to frame the statement as to indicate a definite offence for which a lawful sentence may be imposed.

The following example illustrates the form of the statement:—"That A. B. on the first day of June in the year of our Lord 1906 one oak tree of the value of five pounds the property of C. D. then growing in a certain park of the said C. D. situate in the parish of E. in the county of F. feloniously did steal take and carry away contrary to the statute, &c."

Only one offence should be stated in one count; and separate and distinct felonies should not be charged in the same indictment. If they are, the court makes the prosecution choose one upon which to proceed. This rule is altered by statute in certain cases: e.g. by allowing a limited number of separate thefts, or receivings of stolen property to be included in the same indictment. Misdemeanours and felonies may not be included in the same indictment because of the difference of procedure on the trial; but any number of misdemeanours may be included in different counts of the same indictment, subject to the right of the court to order separate trials or to quash the indictment if it is rendered vexatious by the agglomeration of charges.

There is no general limitation of the time within which indictments may lawfully be preferred; but various limitations have been fixed by statute for certain offences, e.g. in the case of certain forms of treason, of riot, of night poaching and of corrupt and illegal practices at elections. In this respect English law differs from European law, in which limitations of time for prosecution are the rule and not the exception.

Until the mitigation of the draconic severity of the English law in the early part of the 19th century, little or no power existed of amending defective statements or indictments, and the courts in *favorem vitæ* insisted strictly on accurate pleading and on proof of the offences exactly as charged. Since 1827 numerous enactments have been passed for getting rid of these technicalities, which led to undesired acquittals, and since 1851 the courts have had power to disregard technical objections to the form of indictment and to amend in matters not essential in case of variance between the indictment and the evidence. These changes apply to ordinary offences; but for the most part do not touch charges of treason, as to which the old law

in the main still applies. At the present time the looseness of pleading in criminal cases is carried almost too far; for while there is no danger in such looseness when times are quiet and when law is administered by the judges of the High Court in England, yet when crimes of a certain character are committed in times of great political excitement and the law is administered by an inferior judiciary, there may be some danger of injustice if the strictness of pleading and procedure is too much relaxed. In the Criminal Code drafted by Sir James Fitz James Stephen and revised by a judicial commission (Lord Blackburn and Lords Justices Lush and Barry), it was proposed to substitute for the old form of indictment a statement of the particulars of the offence with a reference to the section of the code defining the offence.

The law of Ireland as to indictments is in substance the same as that of England; but is to a certain extent expressed in different statutes.

In Scotland the terms indictment or criminal letters are used to express the *acte d'accusation*. But except in the case of high treason there is no grand jury, and the indictment is filed like an English criminal information by the lord advocate or one of his deputies: and it is only by order of the court of justiciary that a prosecution can be instituted without the general or particular assent of the lord advocate. By the Criminal Procedure Scotland Act 1887 the form of Scots indictments is much simplified. They are drawn in the second and not in the third person.

In those of the British colonies in which by settlement or statute the English criminal law runs, the form of indictment is substantially the same, and is found by a grand jury as in England. But in certain colonies, e.g. the Australian states, an indictment by a public officer without the intervention of a grand jury has been adopted. In India and British Asiatic possessions the procedure is regulated by the Indian Procedure Code or its adaptations. In South Africa indictments are framed under Roman Dutch law as modified by local legislation.

In the United States prosecution or indictment by a grand jury is the rule: the form of indictment is the same, substituting the state or commonwealth of the United States for references to the king, and the conclusions "against the form of the statute" and "against the peace" are still in use. (W. F. C.)

"INDIES, LAWS OF THE," in the colonial history of Spain, a general term designative either (1) of certain codifications of legislation for the colonies listed below, and especially the compilation of 1680; or (2) of the whole body of colonial law, of which those compilations were but a selection, and which was made up of a multitude of royal *cédulas*, orders, letters, ordinances, provisions, instructions, *autos*, dispatches, pragmatics and laws—all emanating from the crown (or crown and cortes) and all of equal force—that were passed through various departments of government to various officers and branches of the colonial administration, or between the different departments of government in Spain. The transfer of Spanish law to Ultramar began with the first days of the Conquest; and especially the civil law was translated with comparatively slight alteration. Many things, however, peculiar to colonial conditions—the special relations of the crown and the papacy in America, the *repartimientos* and *encomiendas* ("divisions of lands" and "commendations," a system of patronage, or modified slavery) of the Indians, the development of African slavery, questions of natural and international law, the spread of discovery and establishment of new settlements and administrative areas, the sales and grants of public lands, the working of the mines—necessitated the organization of a great mass of special law, made up of a body of general doctrine and a vast quantity of administrative applications, *la materia de Indias*—to which references are already found in the time of Ferdinand. The general doctrine was applicable everywhere in Ultramar, and the difficult and inconstant communication between the provinces, and other considerations, early counselled some work of codification. The first efforts to this end were begun in Mexico in 1525; a volume was published in 1563, and other

inadequate compilations in 1596 and 1628, and finally the great *Recopilación de Leyes de los Reinos de las Indias* of 1680. This code has enjoyed great fame, and in some ways even extravagant praise. The greatest praise that has been given it is that its dominant spirit through and through is not the mercantile aim but the political aim—the principle of civilization; and this praise it deserves. It had various defects, however, of an administrative nature; and as time passed its basic doctrines—especially its minute administrative strangulation of colonial political life, and its monopolistic economic principles—became fatally opposed to conditions and tendencies in the colonies. Two centuries in formation, the code of 1680—continually altered by supplementary interpretation and application—was only one century in effect; for in the seventeen-sixties Charles III. began, in a series of liberal decrees, to break down the monopolistic principles of colonial commerce. This change came too late to save the mainland colonies in America, but its remarkable effects were quickly seen in the agrandizement of Cuba. It is in the history of this colony (as also in Porto Rico and the Philippines) that one must follow the later history of the Laws of the Indies (see CUBA).

Of the *Recopilación* of 1680, five editions were issued by the government, the last in 1841 (Madrid, 4 vols.); and there are later, private editions approved by the government. See also J. M. Zamora y Coronado, *Biblioteca de legislación Ultramarina* (Madrid, 1844-1849, 6 vols., with appendices often bound as vol. 7); J. Rodríguez San Pedro, *Legislación Ultramarina concordada*, covering 1837-1868 (12 vols., Madrid, 1865-1868, vols. 10-12 being a supplement); the *Boletín oficial del Ministerio de Ultramar*, covering 1869-1879; and M. Fernández Martín, *Compilación legislativa del gobierno y administración civil de Ultramar* (Madrid, 1886-1894); the gap of 1879-1886 can be filled for Cuba by the series of *Reales Ordenes... publicadas en la Gaceta de la Habana* (annual, Havana, 1857-1898, covering 1854-1898).

**INDIGO** (earlier *indico*, from Lat. *indicum*, the Indian substance or dye; the Sans. name was *nili*, from *nīla*, dark blue, and this through Arab. *al-nīl*, *annīl*, gives "aniline") one of the most important and valuable of all dyestuffs. Until comparatively recently it was obtained exclusively from the aqueous extract of certain plants, principally of the genus *Indigofera* which belongs to the natural order Leguminosae. Small quantities are also obtained from *Lonchocarpus eyanescens* (west coast of Africa), *Polygonum tinctorium* (China) and the woad plant *Isatis tinctoria*. The latter is of historical interest, since up to the middle of the 17th century it was the only blue dyestuff used by dyers in England and on the adjoining continent; at the present time woad is still cultivated in Europe, but serves merely as a ferment in the setting of the fermentation indigo vat or so-called "woad vat" used in wool dyeing.

The bulk of the natural indigo which is brought into the market comes from India, while smaller quantities are imported from Java, Guatemala and other places. The plant from which indigo is made in Bengal is the *Indigofera sumatrana*, which is reared from seed sown about the end of April or the beginning of March. By the middle of June the plant has attained a height of from 3 to 5 ft., and it is at this period that the first manufacturing begins, a second crop being obtained in August. The indigo is contained in the leaf of the plant in the form of a colourless glucoside, known as indician,  $C_{14}H_{17}O_6N \cdot 3H_2O$ . This substance is soluble in water and by the joint action of an enzyme, contained in the leaf, and atmospheric oxygen it yields indigotine, the colouring matter of indigo. It is on these facts that the manufacturing of indigo from the plant is based.

The plant is cut early in the morning and transported to the factory in bullock carts. Here it is steeped in water in steeping vats having a capacity of about 1000 cub. ft. for periods varying, according to circumstances, from nine to fourteen hours, when the liquid—the colour of which varies from a bright orange to an olive green—is run into the beating vats which lie at a lower level. The beating, the object of which is to bring the liquor as freely as possible into contact with the air, was formerly done by striking the surface with bamboo sticks, but is now effected either by means of a paddle wheel or by forcing a current of air from a steam blower or a compressor through the liquid.

When the beating is finished, the precipitated indigo is allowed to settle, the supernatant liquid being drawn off and run to waste. The indigo mud thus obtained, which is known as *mal*, is strained, boiled for a short period for the purpose of sterilizing, formed into bars, cut into blocks of about 3 in. cube and dried.<sup>1</sup> The actual amount of colouring matter yielded by the leaf is but small, averaging, according to Ch. Rawson, 0.5%, but the yield from the whole plant is considerably less, since the stalks and twigs contain practically no colour.

Since the introduction on a large scale of synthetic indigo efforts have been made in India and in Java to place the cultivation of the plant and the manufacture of the natural product on a more scientific basis. But although many important improvements have been achieved from the agricultural as well as from the manufacturing point of view, resulting no doubt in the retention of a portion of the industry, the synthetic product has gained the upper hand and is likely to retain it.

Natural indigos vary considerably in composition, containing in some qualities as much as 90% and in others as little as 20% of colouring matter. The blue colouring matter which indigo contains is known as indigotine, but there are usually also present in small quantities other colouring matters such as indigo red or indirubrine, a yellow colour known as kaempferol, indigo green and indigo brown, as well as indigo gluten and more or less mineral matter.

The bulk of the indigo which now comes into the European market is prepared synthetically from coal tar. The following figures indicate the values of the imports into England of natural and synthetic indigo, and are taken from the official Board of Trade returns:—

	Natural Indigo.	Synthetic Indigo.
1899	£986,090	..
1900	542,089	..
1901	788,820	..
1902	498,043	£143,613
1903	262,775	110,970
1904	316,070	83,397
1905	116,902	121,269
1906	111,455	147,325
1907	151,297	158,481
1908	136,882	134,052

During the period 1899-1908, the average price of indigo had declined from a fraction under 3s. to about 2s. 2½d. per lb. At first sight it might appear that the use of indigo in England was rapidly declining, but this does not necessarily follow when it is borne in mind that London was formerly the distributing centre of natural indigo for the continent and America.

**Chemistry.**—Our knowledge of the chemistry of indigo is largely derived from the classic researches of A. von Baeyer and his collaborators. In 1841 Erdmann and Laurent observed that on oxidation indigo yielded isatin; and in 1848 Fritzsche obtained aniline by distilling the dyestuff with potash. In 1870 A. v. Baeyer and Knop succeeded in preparing indigotine by heating isatin with phosphorus trichloride, acetyl chloride and phosphorus. In the same year, C. Engler and A. Emmerling obtained small quantities of the dyestuff by heating nitroacetophenone with soda-lime and zinc dust, while in 1875 M. v. Nencki prepared it by the oxidation of indol by ozone. Indol had been previously obtained from albuminoids by means of the pancreas ferment. It was not, however, until 1880 that v. Baeyer, who had been at work on the subject since 1865, was able to obtain indigotine from more or less easily accessible coal tar derivatives of known constitution. The most important of these synthetic processes due to the researches of v. Baeyer was the production of the dyestuff from ortho-nitrophenylpropionic acid (see PROPIONIC ACID), which yields indigotine on being treated with caustic soda and a reducing agent such as grape sugar or xanthate of soda. Although used in small quantities in calico printing, it never attained any commercial importance as a means of producing indigo, the cost of production being far too high.

Many synthetic processes of preparing indigotine have since been devised, but the one which stands out pre-eminently from a technical point of view and the one which ultimately led to the commercial success of the synthetic product is that of Heumann who showed in 1890 that indigotine can be prepared by melting phenylglyccol

<sup>1</sup> For a full account of the manufacture of indigo in northern Bihar see Ch. Rawson, *Journ. Soc. Dyers and Colourists* (July 1899).

(phenylglycine),  $C_6H_5 \cdot NH \cdot CH_2 \cdot COOH$ , with caustic alkalis. The yield was at first very unsatisfactory. It was subsequently found, however, that by starting with phenylglycocol-ortho-carboxylic acid, the yield was sufficiently good to render the process a practical success. The starting-point for the manufacture of synthetic indigo is naphthalene,  $C_{10}H_8$ , which is oxidized, by heating with concentrated sulphuric acid in the presence of a little mercury, to phthalic anhydride,  $C_8H_4(O_2)_2$ , which is then converted into ortho-aminoazobenzene acid,  $C_8H_7(NH_2)(CO_2H)$ , by treatment with an alkaline hypochlorite. This acid is then condensed with monochloroacetic acid to form phenylglycocol-ortho-carboxylic acid,  $C_8H_7(NH \cdot CH_2 \cdot CO_2H)(CO_2H)$ , which on being melted with caustic alkali yields indoxylidic acid,  $C_8H_4 < \begin{smallmatrix} C(OH) \\ NH \end{smallmatrix} > C \cdot CO_2H$  and this readily loses carbonyl and passes over into indoxyl,  $C_8H_4 < \begin{smallmatrix} C(OH) \\ NH \end{smallmatrix} > CH$ .

By alkaline oxidation indoxyl is converted into indigotine. The patent literature of processes for bringing about the conversion of the phenylglycine or its carboxylic acid into indoxylidic acid, indoxyl and indigotine is enormous; a circumstance due to the fact that the efficiency of this operation controls the price of the synthetic dyestuff. Caustic soda has been practically given up, being replaced partly or wholly by caustic potash; in addition, alkaline earths, sodamide, nitrides, alkali carbides, &c., have been used. In 1906, Meister, Lucius and Brünning patented the addition of lead and sodium to a mixture of caustic potash and soda; the Basler Chemische Fabrik use a mixture of caustic potash and soda at  $210^\circ - 260^\circ$ ; Léon Lilienfeld added slaked lime or magnesia to the fused alkali, with a subsequent heating in a current of ammonia at  $150^\circ - 300^\circ$ , and in 1908 patented a process wherein the melt is heated under greatly reduced pressure; this gave a yield of 80-90%.

Synthetic indigo comes into the market chiefly in the form of a 20% paste but is also sold in the solid state in the form of a powder. Indigotine,  $C_{16}H_{10}N_2O_2$ , is a derivative of indol and its constitution

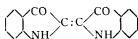

It can be prepared in an almost pure state by extracting good qualities of Bengal or Java indigo or synthetic indigo with boiling nitrobenzene, from which it crystallizes on cooling in dark blue crystals having a metallic sheen. When heated in an open vessel it readily volatilizes, yielding a violet vapour which condenses on cooling in the form of crystals. Indigotine is also soluble in boiling aniline oil, quinoline, glacial acetic acid and chloroform, but is insoluble in water, dilute acids and alkalis and ordinary solvents like alcohol, ether, &c. By nitric acid and many other oxidizing agents it is readily converted into isatin,  $C_{12}H_6N_2O_2$ . Heated with concentrated sulphuric acid it yields a di sulphonic acid,  $C_{16}H_8N_2O_2(SO_3H)_2$ , the sodium salt of which finds application as an acid colour in wood dyeing under the name of Indigo carmine.<sup>1</sup> By the action of reducing agents, indigotine is converted into *indigo white*,  $C_{16}H_{10}N_2O_2$ , which is readily soluble in alkalis or milk of lime with a yellow colour. On exposing the alkaline solution to the air the indigo white is rapidly oxidized back to indigotine, and on these two reactions the application of indigo in dyeing and printing is based. (See DYEING and TEXTILE PRINTING.)

Various halogen (chlorine and bromine) substitutive derivatives of indigotine have been introduced which, while not differing essentially from ordinary indigo in their properties, produce for the most part redder shades in dyeing. They are claimed to be faster and brighter colours. It has been shown by Friedländer (*Ber.*, 1909, 42, p. 765) that the reddish violet colouring matter obtained from the colouring glands of the mollusc *Murex brandaris*, by means of which the famous Tyrian purple of the ancients was dyed, is a dibromindigo,  $C_{16}H_8Br_2N_2O_2$ . A new departure in the synthetic dyestuffs belonging to the indigo group was inaugurated by the discovery in 1906 by P. Friedländer of thioindigo red, a derivative of thionaphthen, which is formed from phenylthioglycol-ortho-carboxylic acid,  $C_8H_4 < \begin{smallmatrix} CO_2H \\ S \cdot CH_2 \end{smallmatrix} > C \cdot CO_2H$ . This substance, on boiling with alkali and then with dilute acid yields thioindoxyl,  $C_8H_4 < \begin{smallmatrix} CO \\ S \end{smallmatrix} > CH_2$ , which is converted by alkaline oxidation into thioindogin, having the constitution  $C_8H_4 < \begin{smallmatrix} CO \\ S \end{smallmatrix} > C \cdot C < \begin{smallmatrix} CO \\ S \end{smallmatrix} > C_6H_4$ . The new dye-stuff is therefore analogous to indigotine, from which it differs by having the imino groups replaced by sulphur atoms. Thioindigo red can be readily crystallized from boiling benzene, and forms reddish brown crystals possessing a metallic reflex. Thioindigo scarlet,  $C_8H_4 < \begin{smallmatrix} CO \\ S \end{smallmatrix} > C = C < \begin{smallmatrix} CO \\ S \end{smallmatrix} > NH$ , is also obtained synthetically. Both products come into the market in the form of pastes and are used in dyeing like indigo (see DYEING). (E. K.)

**INDIUM** (symbol In, atomic weight 114.8), a metallic chemical element, included in the sub-group of the periodic classification of the elements containing aluminium, gallium and thallium. It was first discovered in 1863 by F. Reich and Th. Richter (*Journ. für prak. Chem.*, 1863, 89, p. 444) by means of its spectrum. It occurs naturally in very small quantities in zinc blende, and is best obtained from metallic zinc (which contains a small quantity of indium) by treating it with such an amount of hydrochloric acid that a little of the zinc remains undissolved; when on standing for some time the indium is precipitated on the undissolved zinc. The crude product is freed from basic zinc salts, dissolved in nitric acid and the nitric acid removed by evaporation with sulphuric acid, after which it is precipitated by addition of ammonia. The precipitated indium hydroxide is converted into a basic sulphite by boiling with excess of sodium bisulphite, and then into the normal sulphite by dissolving in hot sulphurous acid. This salt on strong ignition leaves a residue of the trioxide, which can be converted into the metal by heating in a current of hydrogen, or by fusion with sodium (C. Winkler, *Journ. für prak. Chem.*, 1867, 102, p. 273). Indium is a soft malleable metal, melting at  $155^\circ C$ . Its specific gravity is 7.421 and its specific heat 0.03695 (R. Bunsen).

*Indium oxide*,  $In_2O_3$ , is a yellow powder which is formed on ignition of the hydroxide. It is readily reduced on heating with carbon or hydrogen, and does not pass into an insoluble form when ignited. The *hydroxide*,  $In(OH)_3$ , is prepared, as a gelatinous precipitate, by adding ammonia to any soluble indium salt. It is readily soluble in caustic potash, but insoluble in ammonia.

Three chlorides of indium are known: the *trichloride*,  $InCl_3$ , a deliquescent salt, formed by heating a mixture of the oxide and carbon in a current of chlorine; the *dichloride*,  $InCl_2$ , obtained by heating the metal in hydrochloric acid gas; and the *monochloride*,  $InCl$ , which is prepared by distilling the vapour of the dichloride over metallic indium. The mono- and dichlorides are decomposed by water with the formation of the trichloride, and separation of metallic indium. *Indium Sulphate*,  $In_2(SO_4)_3$ , is obtained as a white powder very soluble in water by evaporating the trioxide with sulphuric acid. Concentration of the aqueous solution in a desiccator gives a deposit of crystals of a very deliquescent salt,  $H_2In_2(SO_4)_3 \cdot 8H_2O$ . An *indium ammonium alum*,  $In_2(SO_4)_3 \cdot (NH_4)_2SO_4 \cdot 24H_2O$  is known.

The atomic weight of indium has been determined by C. Winkler and by R. Bunsen by converting the metal into its oxide. Thiel (*Ber.*, 1904, 37, p. 1135) obtained the values 115.08 and 114.81 from analyses of the chloride and bromide, whilst F. C. Mathers (*Abst. J.C.S.*, 1907, ii, 352) obtained 114.88 and 114.86. Indium salts can be recognized by the dark blue colour they give in the flame of the Bunsen burner; and by the white beads of metal and the yellow incrustation formed when heated on charcoal with sodium carbonate.

**INDIVIDUALISM** (from Lat. *individualis*, that which is not divided, an individual), in political philosophy, the theory of government according to which the good of the state consists in the well-being and free initiative of the component members. From this standpoint, as contrasted with that of the various forms of socialism (*q.v.*) which subordinate the individual to the community, the community as such is an artificial unity. Individualism is, however, by no means identical with egoism, though egoism is always individualistic. An individualist may also be a conscientious altruist: he is by no means hostile to or aloof from society (any more than the socialist is necessarily hostile to the individual), but he is opposed to state interference with individual freedom wherever, in his opinion, it can be avoided. The practical distinction in modern society is necessarily one of degree, and both "individualism" and "socialism" are very vaguely used, and generally as terms of reproach by opponents. Every practical politician of whatever party must necessarily combine in his programme individualistic and socialist principles. Extreme individualism is pure anarchy: on the other hand Thomas Hobbes, a characteristic individualist, vigorously supported absolute government as necessary to the

<sup>1</sup> Although bright shades of blue are produced with this derivative, they are not fast.

well-being of individuals. Moreover it is conceivable under given circumstances that an individualist might logically advocate measures (e.g. compulsory military service) which conflict with individual freedom. In practice individualism is chiefly concerned to oppose the concentration of commercial and industrial enterprise in the hands of the state and the municipality. The principles on which this opposition is based are mainly two: that popularly elected representatives are not likely to have the qualifications or the sense of responsibility required for dealing with the multitudinous enterprises and the large sums of public money involved, and that the health of the state depends on the exertions of individuals for their personal benefit.

**INDO-ARYAN LANGUAGES.** "Indo-Aryan" is the name generally adopted for those Aryans who entered India and settled there in prehistoric times, and for their descendants. It distinguishes them from the other Aryans who settled in Persia and elsewhere, just as the name "Aryo-Indian" signifies those inhabitants of India who are Aryans, as distinguished from other Indian races, Dravidians, Mundas and so on. A synonym of "Aryo-Indian" is "Gaudian" or "Gaurian", based on a Sanskrit word for the non-Dravidian parts of India proper. These two words refer to the people from the point of view of India, while "Indo-Aryan" looks at them from the wider aspect of Indo-European ethnology and philology. The general history of the Aryan languages is treated in the articles INDO-EUROPEAN LANGUAGES and ARYAN. Here we propose to offer a brief review of the special course of their development in India.

Most of the Indo-Aryans branched off from the common Aryan stock in the highlands of Khokand and Badakshan, and marched south into what is now eastern Afghanistan. Here some of them settled, while others entered the Punjab by the valley of the river Kabul. This last migration was a gradual process extending over several centuries, and at different epochs different tribes came in, speaking different dialects of the common language. The literary records of the latest times of this invasion show us one Indo-Aryan tribe complaining of the unintelligible speech of another, and even denying to it the right of common Aryan-hood.

*The Piśāca Languages.*—Before proceeding farther, it is advisable to discuss the fate of another small group of languages spoken in the extreme north-west of India. After the great fission which separated the main body of the Indo-Aryans from the Iranians, but before all the special phonetic characteristics of Iranian speech had developed, another horde of invaders crossed the Hindū Kush from the Pāmirs, journeying directly south. They occupied the submontane tract, including the country round Chitral and Gilgit, Kashmir and Kafiristan. Some even followed the course of the Indus as far as Sind, and formed colonies there and in the western Punjab. Here they mingled with the Indo-Aryans who had come down the Kabul valley, and to a certain extent influenced the local dialect with their idioms. How far their influence extended over the rest of India is undecided, and will probably never be known, but traces of it have been detected by some inquirers even in the dialects of modern Marathi. Those who remained behind in the hill country, the whole of which is popularly known as Dardistan, were isolated by the inhospitable nature of their home and by their own savage character. They seem to have had customs allied to cannibalism, and in later Indian literature legends grew around them as a race of demons called *Piśācas*, *ῥωφάγοι*, who spoke a barbaric tongue called *Paśāci*. This language appears now and then in the Sanskrit drama, and Sanskrit philologists wrote still-extant grammatical notices of its peculiarities. These show that it possessed an extremely archaic character, and the same fact is prominent in the Piśāca languages of the present day. Some words which were spoken in the oldest time are preserved with hardly a change of letter, while in India proper the corresponding forms have either disappeared altogether or have been so changed as to be hardly recognizable at first sight. The principal modern Piśāca languages are three or four spoken in Kafiristan, Khōwar of

Chitral, Shinā of Gilgit, Kāshmirī, and Kōhistanī. The last two are border tongues, much mixed with the neighbouring languages of India proper. The only one which has any literature is Kashmirī (q.v.). The rest are entirely uncultivated. Their general character may be described as partly Indian and partly Iranian, although they have in their isolated position developed some phonetic laws of their own.

*Indo-Aryan Classification.*—The oldest specimens of Indo-Aryan speech which we possess very closely resemble the oldest Iranian (see PERSIA: Language). There are passages in the Iranian Avesta which can be turned into good Vedic Sanskrit by the application of a few simple phonetic laws. It is sufficient for our present purposes to note that after the separation the development of the two old forms of speech went on independently and followed somewhat different lines. This is most marked in the treatment of a nexus of two consonants. While modern Iranian often retains the nexus with little or no alteration, modern Indo-Aryan prefers to simplify it. For instance, while the old Aryan *sth* becomes *sʰt* or *ist* in modern Persian, it becomes *th* or *tʰ* in modern Indo-Aryan. Similarly *bhr* becomes *bʰr* in the former, but *bh* or *b* in the latter. Thus:—

Old Indo-Aryan.	Old Iranian.	Modern Persian.	Hindī.
<i>sthāna- bhrāt-</i>	<i>stāna- brāt-</i>	<i>s'tān or istān b'rādār</i>	<i>sthāna, a place. bhāi, a brother.</i>

The earliest extant literary record of Indo-Aryan language is the collection of hymns known as the Rig-Veda. As we have it now, we may take it as representing, on the whole, the particular vernacular dialect spoken in the east of the Punjab and in the upper portion of the Gangetic Doab where it was compiled. The tribe which spoke this dialect spread east and south, and their habitat, as so extended, between the Punjab and the modern Allahabad and reaching from the Himalaya to the Vindhya Hills in the south, became known to Sanskrit geographers as the *Madhyadēśa* or "Midland," also called *Āryāvarta*, or the "home of the Aryans." The language spoken here received constant literary culture, and a refined form of its archaic dialect became fixed by the labours of grammarians about the year 300 B.C., receiving the name of *Saṁskṛta* (Sanskrit) or "purified," in contradistinction to the folk-speech of the same tract and to the many Indo-Aryan dialects of other parts of India, all of which were grouped together under the title of *Prākṛta* (Prakrit) or "natural," "unpurified." Sanskrit (q.v.) became the language of religion and polite literature, and thus the Midland, the native land of its mother dialect, became accepted as the true pure home of the Indo-Aryan people, the rest being, from the point of view of educated India, more or less barbarous. In later times, the great *lingua franca* of India, Hindostani, also took its origin in this tract.

Round the Midland, on three sides—west, south and east—lay a country inhabited, even in Vedic times, by other Indo-Aryan tribes. This tract included the modern Punjab, Sind, Gujarat, Rajputana with the country to its east, Oudh and Behar. Rajputana belongs geographically to the Midland, but it was a late conquest, and for our present purposes may be considered as belonging to the Outer Band. The various Indo-Aryan dialects spoken over this band were all more closely related to each other than was any of them to the language of the Midland. In fact, at an early period of the linguistic history of India there must have been two sets of Indo-Aryan dialects,—one the language of the Midland and the other that of the Outer Band.<sup>1</sup> Hoernle was the first to suggest that the dialects of the Outer Band represent on the whole the language of the earlier Indo-Aryan immigrants, while the language of the Midland

<sup>1</sup> Attempts have been made to discover dialectic variations in the Veda itself, and, as originally composed in various parts of the Punjab widely distant from each other, the hymns probably did contain many such. But they have been edited by compilers whose home was in the Midland, and now their language is fairly uniform throughout. In the time of Aśoka (250 B.C.) there were at least two dialects, an eastern and a western, as well as another in the extreme north-west. The grammarian Patañjali (150 B.C.) mentions the existence of several dialects.

was that of the latest comers, who entered the Punjab like a wedge and thrust the others outwards in three directions.

As time went on, the population of the Midland expanded and forced the Outer Band into a still wider circuit. The Midland conquered the eastern Punjab, Rajputana with Gujarat (where it reached the sea) and Oudh. With its armies and its settlers it carried its language, and hence in all these territories we now find mixed forms of speech. The basis of each is that of the Outer Band, but the body is that of the Midland. Moreover, as we leave the Midland and approach the external borders of this tract, the influence of the Midland language grows weaker and weaker, and traces of the original Outer language become more and more prominent. In the same way the languages of the Outer Band were forced farther and farther afield. There was no room for expansion to the west, but to the south it flowed over the Maratha country, and to the east into Orissa, into Bengal and, last of all, into Assam.

The state of affairs at the present day is therefore as follows: There is a Midland Indo-Aryan language (Western Hindi) occupying the Gangetic Doab and the country immediately to its north and south. Round it, on three sides, is a band of mixed languages, Panjabi (of the central Punjab), Gujarati, Rajasthani (of Rajputana and its neighbourhood), and Eastern Hindi (of Oudh and the country to its south). Beyond these again, there is the band of Outer Languages (Kashmiri, with its Pisaca basis), Lahnda (of the western Punjab), Sindi (here the band is broken by Gujarati), Marathi, Oriya (of Orissa), Bihari, Bengali and Assamese. There are also, at the present day, Indo-Aryan languages in the Himalaya, north of the Midland. These belong to the Intermediate Band, being recent importations from Rajputana. The Midland language is therefore now enclosed within a ring fence of Intermediate forms of speech.

We have seen that the word "Prakrit" means "natural" or "vernacular," as opposed to the "purified" literary Sanskrit. From this point of view every vernacular of India, from the earliest times, is a Prakrit. The Rig-Veda itself, composed long before the birth of "purified" Sanskrit, can only be considered as written in an old vernacular, and its language, together with the other contemporary Indo-Aryan dialects which never attained to the honour of "purification," may be called the *Primary* Prakrits of India. If we compare literary Sanskrit with classical Latin (see Brandreth, "The Gaurian compared with the Romance Languages," *Journal of the Royal Asiatic Society* xi. (1879), 287; xii. (1880), 335), then these *Primary* Prakrits correspond to the old Italic dialects contemporary with and related to the literary language of Rome. They were synthetic languages with fairly complicated grammars, no objection to harsh combinations of consonants, and several grammatical forms strange to the classical speech. In the course of centuries (while literary Sanskrit remained stereotyped) they decayed into *Secondary* Prakrits. These still remained synthetic, and still retained the non-classical forms of grammar, but diphthongs and harsh combinations of consonants were eschewed. They now corresponded to the post-classical Italic dialects. Just as Sanskrit (and the *Primary* Prakrits) knew of a city called Kauśāmbī, which was known as Kōsambī to the *Secondary* Prakrits, so the real Umbrian name of the poet known to literature as Plautus was Plot(ū)s. Again, as the Latin *lactuca* became *lattuca*, so the *Primary* Prakrit *bhaktā* became the *Secondary bhatta*-. In India, the dislike to harsh consonantal sounds, a sort of glottic laziness, finally led to a condition of almost absolute fluidity, each word of the *Secondary* Prakrits ultimately becoming an emasculated collection of vowels hanging on to an occasional consonant. This weakness brought its own Nemesis and from, say, A.D. 1000 we find in existence the series of modern Indo-Aryan vernaculars, or, as they may be called, *Tertiary* Prakrits, closely corresponding to the modern Romance languages. Here we find the hiatus between contiguous vowels abolished by the creation of new diphthongs, declensional and conjugational terminations consisting merely of vowels becoming worn away, and new languages appearing, no longer synthetic,

but analytic, and again reverting to combinations of consonants under new forms, which had existed three thousand years ago, but which two thousand years of attrition had caused to vanish.

It is impossible to fix any approximate date for the change from the *Primary* to the *Secondary* Prakrits. We see sporadic traces of the secondary stage already occurring in the Rig-Veda itself, of which the canon was closed about 1000 B.C. At any rate *Secondary* Prakrits were the current vernacular at the time of the emperor Asoka (250 B.C.). Their earliest stage was that of what is now called *Pāli*, the sacred language of the Buddhists, which forms the subject of a separate article (see *PALI*). A still later and more abraded stage is also discussed under the head of *PRAKRIT*. This stage is known as that of the Prakrit *par excellence*. When we talk of Prakrit without any qualifying epithet, we usually mean this later stage of the *Secondary* Prakrits, when they had developed beyond the stage of *Pāli*, but before they had reached the analytic stage of the modern Indo-Aryan vernaculars. The next, and final, stage of the *Secondary* Prakrits was that of the *Apabhraṃśas*. The word *Apabhraṃśa* means "corrupt" or "decayed," and was applied to the vernaculars in contrast to the Prakrit *par excellence*, which had in its turn (like Sanskrit and *Pāli*) become stereotyped by being employed for literature. It is these *Apabhraṃśas* which are the direct parents of the modern vernacular. The following is a list of the Indo-Aryan vernaculars, showing, when known, the names of the *Apabhraṃśas* from which they are sprung, and the number of speakers of each in the year 1901:—

<i>Apabhraṃśa</i> .	Modern Language.	Number of Speakers.
Saurasēna . . .	<i>A. Language of the Midland.</i> Western Hindi	40,714,925
Āvanta . . .	<i>B. Intermediate Languages.</i> Rājasthāni	10,917,712
" . . .	Pahārī Languages	3,124,681
Gaurjara . . .	Gujarātī	9,439,925
Saurasēna . . .	Pañjābī	17,070,961
Ardhāmagadha . . .	Eastern Hindi	22,136,358
Unknown . . .	<i>C. Outer Languages.</i> (a) <i>North-Western Group.</i> Kāshmirī (with a Piśāca basis)	1,007,957
" . . .	Kōhīstānī (with a Piśāca basis)	(unknown)
Vrācaḍa . . .	Lahnda or Western Pañjābī	3,337,917
" . . .	Sindhī	3,494,971
Māhārāṣṭra . . .	(b) <i>Southern Language.</i> Marāṭhī	18,237,899
Māgadha . . .	(c) <i>Eastern Group.</i> Bihārī	34,579,844
" . . .	Oriyā	9,687,429
" . . .	Bengalī	44,624,048
" . . .	Assamese	1,350,846
Total . . .	More than	219,725,473

Of these, the Pahārī languages are offshoots of Rājasthāni imported into the Himalaya. Kōhīstānī includes the mixed dialects of the Swat and Indus Kōhīstans. The census of 1901 did not extend to these tracts. A full account of the *Apabhraṃśas* will be found in the article *PRAKRIT*.

Although the modern Indo-Aryan vernaculars are not derived from Sanskrit, and though all, or nearly all, are not derived from the language of the Rig-Veda, nevertheless, as these are almost the only sources of our information as to what the *Primary* Prakrits of India were, and as all *Primary* Prakrits were related to these two and were in approximately the same stage of phonetic development, they afford a convenient means for carrying out historical investigation into the origin of all the modern Indo-Aryan vernaculars to its legitimate conclusion. At the same time they are not always trustworthy guides, and sometimes fail to explain forms derived from other ancient contemporary dialects, the originals of which were unknown to the Vedic and classical literature. A striking example is the origin of the

very common locative suffix *-ē*. This can be traced through the *Apabhraṃśa-hi* to the Pali *-dhi*. There all Indian cluses cease, and it is not till we recognize its relationship to the Greek *-thi* that we understand that it is an ancient Indo-European termination kept alive in India by some of the Primary Prakrits, but ignored both by the dialect of the Rig-Veda and by literary Sanskrit. With this reservation, a short comparison of Sanskrit with the Secondary and Tertiary Prakrit developments will be of interest. As the Pali and Prakrit stages are fully treated under their proper heads, very brief references to them will be sufficient.

*A. Vocabulary.*—The ground of all the vocabularies of the modern Indo-Aryan vernaculars is, of course, the vocabulary of Aryan India in the Vedic period. Thousands of words have descended from the earliest times and are still in existence, after passing through certain changes subject to well-known phonetic laws. As many of these laws are the same for every language, it follows that a large stock of words, which principally differ in inflection, is common to all these modern forms of speech. These words, which natives believe to be derived from Sanskrit itself, are called by them *tadbhāva*, i.e. "having" that " (sc. Sanskrit, or, more correctly, the Primary Prakrit) for its origin." As the language of the Midland is derived from the old dialect of which Sanskrit is the "polished" form, it is approximately true to say that it is derived from that form of speech, and its *native* vocabulary (allowing for phonetic development) may be said to be the same as that of Sanskrit. But the farther we go from the Midland, the more examples we meet of a new class of words which natives of India call *dēśya* or "country-born." Most of these are really also *tadbhāvas*, descendants of the old Primary Prakrit dialects spoken outside the Midland, of whose existence native scholars took no account. Finally, owing to the ever-present influence of literary Sanskrit, words are, and have been for many generations, borrowed direct from that language. Some of these borrowed words are due to the existence of Sanskrit as the language of religion, and this is paralleled by the employment of Greek and Latin words for religious technical terms in all the languages of Europe. Others are technical terms of arts and sciences, but most of those which we meet are simply employed for the sake of fine language, much as if some purist were to insist on employing *hālorā* instead of "lord" in writing English. These Sanskrit words are known as *tatsama* or "the same as" that " (sc. Sanskrit)." The number of *tatsamas* employed varies much. In languages such as Panjabi which have little or no literature, and in the speech of the peasantry all over India, they are few in number. In the modern literary Bengali a false standard of literary taste has led to their employment in overwhelming numbers, and the homely vigorous home-speech, which is itself capable of expressing every idea that the mind of man can conceive, flounders about awkwardly enough under the weight of its borrowed plumes. The native vocabulary of the modern Indo-Aryan vernaculars is thus made up of *tadbhāvas*, *dēśyas* and *tatsamas*.

The Dravidian languages of southern India have also contributed a small quota to the Indo-Aryan vocabulary. Most of the words have been given a colour of contempt in the process of borrowing. Thus the word *pilla*, a cub, is really the Dravidian *pillā*, a son. But the most important accretion from outside comes from Persian, and (through Persian) from Arabic. This is due to Mahomedan influence. In the Mogul courts Persian was for long the language of politeness and literature, and words belonging to it filtered into all stages of society. The proportion of these Persian words varies greatly in the different languages. In some forms of Western Hindi they have almost monopolized the vocabulary, while in others, such as Bengali and Marathi, the number is very few. Instances of borrowing from other languages are of small importance.

*B. Phonetics.*—The alphabet of the Indo-Aryan languages is, on the whole, the same as that of Sanskrit (*q.v.*), and the system of transliteration adopted for that language is also followed for them. Some new sounds have, however, developed in the Secondary and Tertiary Prakrits. New signs will be used for them, and will be explained in the proper places. Sanskrit knew only long *ē* and *ō*, but already in the Secondary Prakrits we find a corresponding short pair, *e* and *o*, of which the use is considerably extended in the tertiary stage.

The Sanskrit diphthongs *āi* and *āu* disappeared in the secondary stage, *ē* and *ō* being substituted for them respectively. On the other hand, in the same stage, we frequently come across pairs of vowels, such as *ai*, *au*, with a hiatus between the two members. In the tertiary stage, these pairs have been combined into new diphthongs *ai* and *au*, shorter in pronunciation than *āi* and *āu*. The pronunciation of *āi* and *āu* may be compared with that of the English "eye" and "ow" respectively. In the languages of the Outer Band there is again a tendency to weaken this new *āi* to *ē*, and the new *āu* to *ō*. All the tertiary languages weaken a short final vowel. In most it is elided altogether in prose, but in some of those of the Outer Band (Kashmiri, Sindhi and Bihari) it is half pronounced. Some of the Outer languages have also developed a new *a*-sound, corresponding to that of *a* in the German *Mann*. The stress-accent of classical Sanskrit has as a rule been preserved throughout. In the tertiary stage it generally resolves itself into falling on the ante-penultimate, if the penultimate is short. If the latter is long it takes the accent. In the eastern languages there is a tendency to throw the accent even farther back. There is also everywhere a tendency to lighten the pronunciation of a short vowel after an accented syllable, so that it is barely audible. Thus, *calāu* for *cālatā*. In some dialects, e.g. the Urdu form of Western Hindi, this "imperfect" vowel has altogether disappeared, as in *calā*.

The tertiary languages have on the whole preserved the consonantal system of the secondary stage, preferring, however, as a rule, to simplify double consonants, with compensatory lengthening of the preceding vowel. Thus, for Sanskrit *hāsta*, a hand, we have Secondary Prakrit *hāstha*. Tertiary *hāth*. Some tertiary languages have both *hath* and *hāth*: others (like Gujarati) have only *hāth*: while others (like Panjabi) have only *hath*. In the extreme north-west, Sindhi and Lahnda, under the influence of the Pisaca languages, simplify the double consonant without compensatory lengthening, so that we have *hath*. Again, many languages of the Outer Band show a tendency to avoid aspiration, so that Kashmiri, Marathi, Bengali and others have *hāt*. It is well known that the Iranian languages change *s* to *h*. The Tertiary Prakrits of the Outer Band find an analogous difficulty in pronouncing a sibilant. The north-western languages change it to *h* in Persian. Marathi changes *ś* to *f* before palatal sounds, and the same change occurs in Bengali in the case of every uncompound sibilant. Eastern Bengali and Assamese go farther. Here *ś* is again sounded almost like *h*. On the other hand, in the Midland, *ś* rarely becomes *h* and then only when medial. In the Outer languages the palatal consonants are also liable to change; *j* and *ḥ* approach the sound of *z*, and *c* and *ch* often become *ts*, or, in the East, a simple *s*. Thus, the Midland *cākār* a servant, is pronounced *isākār* in Marathi, and the Midland *māch*, a fish, is sounded *mās* in Marathi, Bengali and Assamese.

*C. Declension.*—The latest stage of the Secondary Prakrits the neuter gender begins to disappear, and in the tertiary stage, except in Gujarati and Marathi, it is nearly altogether wanting. Elsewhere we only come across occasional relics of its employment. In some of the tertiary languages grammatical gender, as distinct from sexual gender, has disappeared as entirely as it has in English. The dual number had already fallen into disuse in the Secondary Prakrits. In the secondary stage we see a gradual simplification of grammatical form and a disappearance of case endings. The complicated Sanskrit system is more and more superseded by the simple uniformity of the declension of *n*-bases. One by one the case-endings were discarded, and cases were confounded with one another till at length in *Apabhraṃśa* only one or two forms remained for each number. In the tertiary stage there remain in most languages only two cases, which we may call the nominative and the oblique. The latter can be employed for any case except the nominative, but the sense is usually defined by the aid of help-words called postpositions.<sup>2</sup> It is a linguistic rule that languages in which the genitive precedes the governing noun prefer suffixes to prefixes and vice versa;<sup>3</sup> and, as we are prefixing the help-words to the form of suffixes. In the Midland they are still separate words, but in the Outer Band each has in general become incorporated with the main word to which it is attached. Thus, the Midland *ghōrā*, a horse, has its oblique form *ghōrē*, genitive *ghōrē kēr*, but Bengali has oblique form *ghōrē*, genitive *ghōrē* contracted from *ghōrē + (k)ār*. The ground principles of declension in all tertiary languages are the same, but as each employs different postpositions the systems of declension vary considerably. Marathi is the only true Indo-Aryan language which has preserved anything more than sporadic relics of the old system of case termination.

*D. Conjugation.*—Two tenses, the present and the imperative, of the old synthetic system of conjugation have survived in all the Tertiary Prakrits, and in some of them we also find the ancient future. All other tenses are now made periphrastically, mostly with the aid of participles to which auxiliary verbs may or may not be added. The participles employed are all survivals of the old participles of the present, of the past and (in some languages) of the

<sup>2</sup> The origin of the postpositions is discussed in the article HINDOSTANI.

<sup>3</sup> See P. W. Schmidt in *Mitteilungen der Wiener Anthropologischen Gesellschaft*, xxxiii, 381.

<sup>1</sup> The Nāgarī (see SANSKRIT) and allied alphabets, when employed for modern Indo-Aryan languages or for Prakrit, are transliterated in this work according to the following system:—

a ā i u ē ō aū ō aū ā (anusvāra) ∞ (anusvāhā) h (visarga).  
 k kh g gh ṛ  
 c (ts) ch (tsh) j (dz) jh (dzh) ñ  
 ṭ ṭh ḍ (ṛ) ḍh (ṛh) l lh ṡ  
 t th d dh n  
 p ph b bh m  
 y ṛ (w)  
 ṣ ṣ h

Special sounds employed by particular languages are described in the articles in which reference is made to them. Here we may mention *ā*, sounded like the *aw* in "law," and *ā*, *ō*, *ū*, pronounced as in German.

future. The past and future participles are passive in their origin, and hence tenses formed with these participles must be construed passively. Thus, instead of "I struck him" we must say, either "he was struck by me," or else (impersonally) "it was struck by me with reference to him." So, for an intransitive verb we have, either "I am gone," or "it is gone by me." In the language of the Midland this is quite simple and clear, but in those of the Outer Band the subject (in the instrumental, or as it is usually called, "agent" of case) is indicated by means of pronominal suffixes attached to the participle or auxiliary verb; thus (Bengali) *māria-tam*, struck-by-me, becomes *māriām*, I struck. In such cases all memory of the passive meaning of the participle is lost by the eastern languages, and it, together with the appropriate pronominal suffixes, becomes in appearance and in practical use an ordinary past tense conjugated as in Latin or in Sanskrit. It is an instance of reversion to the original type: first synthetic, then analytic, and then again a new synthetic conjugation. In the other languages of the Outer Band, the memory of the passive nature of the participle is retained, although the conjugation is as synthetic as in the East, and the subject has to be put into the "agent" case.

**AUTHORITIES.**—No work has yet been published dealing with Indo-Aryan subjects as a whole, although several have been written which treat of one or more stages of their development. For the general question of the Pisāca languages, the reader may consult G. A. Grierson's *The Pisāca Languages of North-Western India* (London, 1906). For the different languages of this group, see G. W. Leitner, *Pardīstān* (Lahore, 1877); J. Biddulph, *Tribes of the Hindoo Kooch*, (Calcutta, 1880); O'Brien, *Grammatical Vocabulary of the Khasi or Khasi Dialect* (Lahore, 1895); J. Davidson, *Notes on the Bakāli (Kāfir) Language* (Calcutta, 1901). For the linguistic conditions of Vedic times, the Introduction to J. Wackernagel's *Altindische Grammatik* (Göttingen, 1896) gives much useful information in a convenient form. For the literature concerning Pāli and Prakrit, see under those heads. The following are the principal works dealing with the general question of the Tertiary Prakrits: J. Beames, *Comparative Grammar of the Modern Aryan Languages of India (1872-1879)*; A. F. R. Hoernle, *A Grammar of the Eastern Hindī combined with the other Gaudīya Languages* (1880); R. G. Bhandarkar, *The Phonology of the Prakrits of Northern India* (i. in the *Journal of the Royal Asiatic Society* (Bombay Branch), vol. XVII, ii., 99-182 (see also the same author's series of papers on cognate subjects, in vol. XVI. of the same *Journal*); and G. A. Grierson's essays "On the Zenschrift der deutschen morgenländischen Gesellschaft, vols. xlix., i. (1895-1896), 393, 1: "On the Radical and Participial Tenses of the Modern Indo-Aryan Vernaculars" in the *Journal of the Asiatic Society of Bengal*, vol. lxiv. (1895), part I., 352; and "On certain Suffixes in the Modern Indo-Aryan Vernaculars" in the *Zeitschrift für vergleichende Sprachforschung* (1903), 99-173. The general subject of this article is discussed at greater length in chapter vii. of the *Report on the Census of India, 1901* (Calcutta, 1903). The volumes of the *Linguistic Survey of India* also contain much detailed information, summed up at length in the introductory volume. (G. A. GR.)

**INDO-CHINA, FRENCH.**<sup>1</sup> The geographical denomination of French Indo-China includes the protectorates of Annam, Tongking and Cambodia, the colony of Cochinchina and part of the Laos country. In 1900 the newly-acquired territory of Kwang-Chow Bay, on the coast of China, was placed under the authority of the governor-general of Indo-China. Cochinchina, a geographical definition which formerly included all the countries in the Annamese empire—Tongking, Annam and Cochinchina—now signifies only the French colony, consisting of the "southern provinces" originally conquered from Annam, having Saigon as its capital. In its entirety French Indo-China, the eastern portion of the Indo-Chinese peninsula, lies between 8° 30' and 23° 25' N. and 100° and 109° 20' E. It is bounded N. by China, on which side the frontiers have been delimited; E. and S.E. by the Gulf of Tongking and the China Sea; W. by the Gulf of Siam and Siam, and N.W. by Burma. The area is estimated at about 200,000 sq. m., with a population of 174 millions, of whom 75 or 80% are Annamese. The French inhabitants number about 13,000.

The configuration of the country is determined by two rivers of unequal importance—the Mekong and the Song-Koi—and a continuous chain of mountains, an offshoot of the great Chinese group of Yun-nan, which, making a double curve, forms an immense S. South and west of this mountain chain the country forms part of the Mekong basin. To the north and north-east of the chain the valley of the Song-Koi, or Red river,

constitutes almost the whole of Tongking, of which its delta represents the most fertile and populous if not the largest portion. The small mountainous provinces of Lang-Son, That-Ke and Kao-Bang, however, belong geographically to the Si-Kiang basin. On the east the small province of Mon-Kay, on the borders of Kwang-Tung, forms a little basin enclosed between the mountains and the sea; on the south the province of Thanh-Hoa, although crossed by the small river Song-Ma, forms the extremity of the Red river delta and belongs to it, the two rivers being united at some distance from the sea by a natural channel formed by the junction of a northern branch of the Song-Ma with a southern branch of the Song-Koi. The Red river descends from the mountains of Yun-nan, rising near Tali-fu between deep and inaccessible gorges, and becomes navigable only on its entry into Tongking. Means have been taken to render it available to steam launches, and in consequence of an agreement between the state and the Compagnie des Correspondances Fluviales a service of steamers is provided from its mouth to Lao-Kay. Near Hung-Hoa the Red river receives its two chief tributaries, the Black river from the plateaus of the west—the land of the Muongs—and the Clear river, one of the largest of whose tributaries issues from the Ba-Be lakes. The Black river is navigable for a considerable distance, the Clear river only from Tuyen-Kwang. Between the basins of the Song-Koi and the Mekong the chain of mountains, crowned by tolerably extensive plateaus, covers, with its ramifications and transverse spurs, a vast extent of country little known, although several trade-routes traverse it, thus placing the Laos country in communication with Tongking and Annam. In about 10° N. the mountain-ridge approaches the sea and runs parallel to the coast, presenting on its eastern side a steep declivity which encloses a narrow littoral, in places only a mile or two broad, between the base of its cliffs and the shore. This coast-belt constitutes the habitable and cultivable portion of Annam proper, and consists of alluvial matter accumulated at the mouths of mountain streams, and marshes and swamps enclosed between land and sea by sand ridges heaped up by wind and tide. The high valleys and plateaus originally belonged to the empire, the limits of which, although invaded and occupied by Siamese, formerly extended to the banks of the Mekong. The western slopes form part of the French Laos possessions. The Mekong valley includes Laos, Cambodia and the greater part of Cochinchina. The Mekong (*g.v.*) is one of the largest rivers of south-eastern Asia, having a course 1900 m. in length. Its mouths, six in number, communicate by means of a navigable canal with the Saigon river (fed by the Don-Nai and the two Vaico rivers), which is navigable by the largest warships, rendering Saigon the most important natural port of Indo-China.

**Geology.**—The deltaic tracts of the Mekong and Red river are composed of alluvium (generally silicious clay) deposited by the rivers. The mountains from which this soil is derived are granitic in formation, the framework being almost always schists of ancient date, dislocated, folded, and occasionally rounded into hills 1000 to 1500 ft. in height, belonging to the Devonian period. Above these schists lie—more especially in the north and south of Tongking—marbles and other highly crystalline limestones, upon which rest, unconformably in places (Nong-Son, Ke-Bao, Hon-Gây), Carboniferous formations. In the upper part of the Red river valley rich deposits of coal have been found between Yen-Bay and Hai-Duong, in a considerable tract of Tertiary rock. Limestone occurs also in the valley of the Mekong, forming an extensive *massif* in the district of Lakhon and in the basins of the Nam-Ka-Dinh and Nam-Hin-Bun. The limestones appear to be Carboniferous. In the region south of Lakhon the rock is Triassic, and gold has been found in several districts. The natives collect it in very small quantities by a washing process. In the lateral valleys of the Mekong copper and tin are found. On the course of the Nam-Paton, a tributary of the Nam-Hin-Bun, the natives work a moderately productive tin-mine. Layers of spiegelglanz, limonite and other iron ores are numerous in the Laos states, in which also antimony occurs.

**Climate.**—The climate of Indo-China is that of an inter-tropical country, damp and hot. But the difference between the southern and northern regions is marked, as regards both temperature and meteorology. Cochinchina and Cambodia have very regular seasons, corresponding with the monsoons. The north-easterly monsoon blows from about the 15th of October to the 15th of April, with a day or so. The temperature remains almost steady during this time, varying but slightly from 78-8° to 80-6° F. by day to 68°

<sup>1</sup> See also ANNAM, CAMBODIA, COCHIN-CHINA, KWANG-CHOW BAY, LAOS, TONGKING.

by night. This is the dry season. From the 15th of April to the 15th of October the monsoon reverses, and blows from the south-west. The season of daily rains and tornadoes commences. The temperature rises from 80°-6° to 84°-2°, at which it remains day and night. April and May are the hottest months (from 86° to 93°-2°). The damp unwholesome heat sometimes produces dysentery and cholera. The climate of Annam is less regular. The north-easterly monsoon, which is "the ocean-wind," brings the rains in September. The north-easterly gales lower the temperature below 59°. September is the month in which the typhoon blows. During the dry season—June, July and August—the thermometer oscillates between 86° and 95°. The nights, however, are comparatively cool. Tongking has a winter season—October to May. The temperature, lowered by fog and the rains, does not rise above 75°-2° and descends to 50° over the delta, and to 44°-6° and even 42°-8° in the highlands, where white frost is occasionally seen. The summer, on the other hand, is scorching. The wind veers to the south-east and remains there until October. The temperature rises to over 83°; often it reaches and continues for several days at 95° or even more. The nights are distressingly airless. The Laos country in the interior and lying at a high altitude is cooler and drier. Its deep valleys and high hills vary its climate.

**Fauna and Flora.**—From the populous cultivated districts wild animals, once plentiful, have retired towards the wooded and mountainous districts. The wild life of Laos includes fairly numerous herds of elephants, the rhinoceros (one- and two-horned); rhinoceros horn is employed as a "meat-eater" (tiger, panther, brown bear, tree bear, monkeys and rats, among which are the musk rat, the palm rat and the *nu-khi*, or rat found in the rice-fields of the highlands, in which its eggs are considerable. In mountain districts the leopard, wild boar and deer are found, and in the neighbourhood of habitations the tiger-cat and ichneumon. The buffalo is commonly found wild in Laos; as a domesticated animal it also holds a prominent place. The zebu bull is used for transport purposes. Attempts to acclimatize the Arab horse and to introduce sheep from Aden and China have failed. There is, however, an indigenous race of horses, excellent in spite of their small size—the horses of Phu-Yen. Among birds the woodcock, peacock and numerous species of duck inhabit the woods and marshes. The goose and guinea-fowl appear, as also the turkey, to have become easily acclimatized. Reptiles (apart from the caimans of the Mekong, which attain a length of over 30 ft., and are much appreciated by the Annamese as food) are extremely numerous and varied in species. The rivers are rich in fish. The sole is found in the rivers of Tongking. The Mekong is fished for two species peculiar to it—the *pa-benk* and the *pa-loun*, which attain a length of nearly 6 ft. All varieties of mosquitoes, ants and leeches combine to render the forests bordering the rivers almost uninhabitable. Peculiar species of grubs and caterpillars destroy the cotton and coffee plantations of Cochinchina. The silkworm may be said to be indigenous in Tongking, where there are several thousand acres of mulberry trees.

The flora is inter-tropical, and comprises nearly all the trees known in China and Japan. The bamboo is utilized in building and a variety of other ways. Formerly the teak was believed not to exist in the forests of Indo-China, but it was found some years ago in considerable abundance, and plantations of it have been made. Certain hard woods are used for marqueterie and other ornamental work. Rubber is also exploited. Cotton, previously cultivated in Cochinchina and Cambodia, gives excellent results in Laos. Tea, of which there are a certain number of plantations in the highlands of Tongking and Annam, grows wild in Upper Laos, and in quality closely resembles the Pou-eurl or Puel variety noted in Yun-nan. Cocoa, coffee and cotton are cultivated in Tongking and Cambodia. Cinnamon and cardamoms are gathered in Laos and Annam. Ground nuts, sesame, sugar canes, pepper, jute, tobacco and indigo are also grown. The area under rice, which is incomparably the most important crop, is approximately 50,000 acres. All European fruits and vegetables have been introduced into Tongking, and with certain exceptions—the grape, for example—succeed perfectly. Measures taken to secure the monopoly of opium have notably increased the cultivation of the poppy.

**People.**—The population of French Indo-China falls into five chief divisions—the Annamese, forming the bulk of the population in Annam, Tongking and Cochinchina and four-fifths of that of the whole country; the Khmers or Cambodians; the Chams of southern Annam; the Thais, including the Laotians; and the autochthonous tribes classed by the other inhabitants as Moïs or Khas ("savages"). Driven into the interior by the now dominant races, these older people have mixed and blended with the peoples whom they found there, and new tribes have arisen, intermingled with fugitives from China, Annam and even Siam. In the north of Tongking people of Laos origin occur—the Thôis round Kaobang, the Muongs in the mountains bordering the Red river. When mixed with Chinese the Muongs and the Thôis are known as

the Hung-dans, Mâns and Miens. The Muongs are bigger and stronger than the Annamese, their eyes often almost straight. They have square foreheads, large faces and prominent cheek-bones. In the centre and south of the Indo-Chinese mountain chain are found, under a multiplicity of names—Phon-tays, Souis, Bah-nan, Bolovens, Stiengs, Mors, Kongs, &c.—people of Malayan origin mixed with all the races of Indo-China. Laos is inhabited by an essentially miscellaneous population—falling into three main groups—the Thais; various aboriginal peoples classed as Khâs; and the Moos and Yaos, tribes of Chinese origin.

**Religions.**—The Annamese religion is a somewhat vague and very tolerant Buddhism, which in practice resolves itself chiefly into the worship of ancestors. Certain ceremonies performed in Cambodia resemble distantly the Brahminical cult. The Roman Catholic religion has been introduced by missionaries. The course of its history has not been free from catastrophes and accidents. There is an apostolical vicariate in Cochinchina, one in Cambodia and several mission stations in Tongking. Two of these missions are mainly conducted by Spanish priests.

**Administration.**—Before taking its present form the governmental organization of Indo-China underwent many changes. Originally Cochinchina, the only French possession in the peninsula, was a colony directly administered, like other colonies, by the ministry of marine, and its earliest governors were admirals. Later, as further conquests were effected, Tongking and Cambodia were subjected to the régime of a protectorate somewhat ill-defined, and placed under the authority of residents-general. The seat of the resident-general of Tongking was at Hanoi; of Cambodia, at Pnom-Penh. The government of the colonies having been transferred (1886) from the ministry of marine to the ministry of commerce, and in 1894 to the newly created ministry of the colonies, the control of the residencies passed gradually into the hands of civil agents. Cochinchina, which already by the decree of the 8th of February 1880 had been endowed with a colonial council, had a municipality, a chamber of commerce, and even a deputy in the French parliament. There had thus been three distinct states, each with its own ruler and government. But by the decrees of the 17th of October and the 3rd of November 1887 the unity of Indo-China was determined. By decree of October the post of director of the interior of Cochinchina was done away with and replaced by that of lieutenant-governor under the immediate authority of a governor-general. The functions and powers of the latter official were, however, but vaguely defined before the decree of the 21st of April 1891, which conferred on M. J. M. A. de Lanessan, appointed governor-general, the most extensive powers. The residents-general of Tongking, Annam and Cambodia, and the lieutenant-governor of Cochinchina, as well as the military authorities, were placed under him. But this change of policy, which put an end to the system of expeditions and minor military operations, and restricted the power of the residents whilst restoring to the mandarins a share of authority, was unwelcome to numerous interests, which, combining, secured the abrupt recall of M. de Lanessan on the 29th of December 1894. The decree of the 21st of April 1891 was not, however, revoked, but the powers it conferred were restricted. After the appointment of M. Doumer, successor to M. Rousseau, who died on the 10th of December 1896, this decree was again put in force on the former scale, and in 1898 it was supplemented by the decrees of the 3rd and 31st of July, which definitely established the political and financial unity of Indo-China. The governor-general is the sole intermediary between the Indo-Chinese Union and the home government, the powers of which, with few restrictions, are delegated to him. As supreme administrative and military authority, he directly controls the civil services, and, though prohibited from commanding in the field, disposes of the land and sea forces in the country. His diplomatic negotiations with foreign powers must be carried on under the authorization and surveillance of the home authorities. The governor-general is assisted by the Superior Council of Indo-China, which meets



monthly, and as reorganized by the decree of the 8th of August 1898 is composed as follows: the governor-general (president); the general commanding as head of the troops; the rear-admiral commanding the naval squadron of the Far East; the lieutenant-governor of Cochinchina; the residents superior of Tongking, Annam, Cambodia and Laos; the director-general of finances; the director of the *contrôle financier*; the head of the judicial service of Indo-China; the director-general of the customs and excise of Indo-China; the directors-general of agriculture, forests and commerce; of public works; of posts and telegraphs; of health; and of public instruction; the treasurer-general of Indo-China; the director of the school of medicine at Hanoi; the president of the colonial council of Cochinchina; the presidents of the chambers of commerce of Saigon, Hanoi and Hai-Phong; the presidents of the united chambers of commerce and agriculture of Annam and Cambodia; the presidents of the chambers of agriculture of Tongking and Cochinchina; four influential natives; the chief of the cabinet and the governor-general's secretary. This list sufficiently indicates the departmental services, by means of which the general government is carried on. The Superior Council meets not only at Hanoi, the seat of the government, but also at Saigon, Hué and Pnom-Penh. It delegates its powers to a "permanent commission" consisting of thirteen of its members, and dispensing with the attendance of the local authorities of regions other than those in which the place of meeting is situated. The Superior Council meets annually to receive the general budget and the local budgets which "must be accepted by the governor-general at a session of the Superior Council."<sup>1</sup> It must also be consulted on the distribution of military credits, and on the credits to be devoted to public works. The *contrôle financier*, which scrutinizes and sanctions all measures of the public services involving outlay of money, is dependent on the ministry of the colonies. Its returns have to be communicated to the governor-general.

The governor-general is also assisted by a "council of defence," comprising the chief military and naval authorities.

**Justice.**—The whole of Indo-China is, in principle, subject to French justice, represented by a court of appeal and a certain number of tribunals. Before 1898 the administration of justice was not centralized. There was a court of appeal at Hanoi, and another at Saigon. But the decree of the 8th of August 1898 established one court of appeal for French Indo-China: two chambers sitting at Saigon and the other two at Hanoi. Three tribunals of commerce are established at Saigon, Hanoi and Hai-Phong. There are courts of first instance at Saigon, My-Tho, Vinh-Luyen, Ben-Tre, Chau-Doc, Kantho, Soc-Trang, Tra-vinh, Long-Xuyen for Cochinchina, at Pnom-Penh for Cambodia, and at Hanoi and Hai-Phong for Tongking. These courts are supplemented by *juges de paix* in Cochinchina, and there are *juges de paix* at Nam-Dinh (Tongking) and Tourane; elsewhere in the protectorates the residents perform judicial functions. There are criminal courts at Saigon, My-Tho, Vinh-Luyen and Long-Xuyen in Cochinchina, at Hanoi in Tongking, and at Pnom-Penh in Cambodia. In Cochinchina Annamese law is administered in the French courts in suits between natives, but native tribunals have been superseded. In Annam-Tongking, outside the sphere of the French tribunals, the natives are subject to Annamese justice, represented in each province by a mandarin, called the *An Sat*, and in Cambodia the natives are subject to the native tribunals. At the same time, whenever a French subject or European or other foreigner is a party in an affair, French justice only is competent.

**Public Works.**—The order of the 9th of September 1898 placed the public works of Indo-China under the "direct authority of the governor-general as regards works entered to the general budget account."<sup>2</sup> There is a director of public works in Indo-China at Saigon, a director of engineering in the other countries. In 1895 a "special service" was created in Tongking to consider railway business.

**Posts and Telegraphs.**—The country is divided into two sections for the purposes of this service, the one comprising Annam, Tongking and Upper Laos, the other Cochinchina, Cambodia and Lower Laos. The post and telegraph offices in Indo-China number about three hundred. Tourane communicates by submarine cable with Amoy in China, thence with Vladivostok and Europe.

**The Army—Land Force.**—The military services are under the authority of a general of division commanding in chief. The European troops in 1907 comprised four regiments of colonial

infantry with 22 batteries of artillery (10 in Tongking and 12 in Cochinchina). The native troops, numbering over 18,000, comprised four regiments of Tongkingese *brûlailleurs* (sharpshooters), two of Annamese, a battalion of Cambodian and a battalion of Chinese *brûlailleurs*, a squadron of Annamese *chasseurs* or light horse and two companies of engineers.

**Sea Force.**—Indo-China is protected by the naval division of the Far East. In addition five gunboats are stationed at Saigon and a third-class cruiser and some minor vessels at Hai-Phong.

The *Policing* of the country is performed by natives (the *garde indigène*) under European officers and by the *gendarmes coloniales*, which is reinforced by native auxiliaries.

**Money, &c.**—The monetary unit is the *piastre*, which is of variable value, having fallen from 4.50 francs to 2.40 francs and fluctuating round that figure. The chief native coin is the *sapek* of zinc or tin, six hundred of which strung together form a *ligature*, a tenth of which is called a *ten*. The *piastre* is worth 2700 sapeks. The unit of weight, the *picul*, equals 60.4 kilos. (about 133 lb.); the *thuoc-moet* equals .425 metre (about 17 in.).

**Education.**—The Annamese are intelligent and have old intellectual and artistic traditions. In consequence the promotion of education has been assigned to a special council (*Conseil de perfectionnement de l'enseignement*) selected from Frenchmen and Asiatics particularly qualified for membership. Among its preoccupations are the reconstitution of the schools of Chinese characters in Cochinchina, the remodelling of the programmes of the triennial examinations in Annam and Tongking (see ANNAM) with a view to completing them with a summary knowledge of French and science, the improvement of the teaching given in the pagodas in Cambodia and Laos, and the foundation of a university comprising classes for natives. In 1906, in Cochinchina, where the largest sum (£45,000 in 1906) is devoted to instruction, 22,500 children received a French education.

**Finance.**—The unification of the budget brought about by M Doumer (decree of the 31st of July 1898) specially contributed to that of the government. The financial scheme is based on the political. Just as a single central government directs the various local governments, so in addition to the general budget, comprising the revenue and expenditure of the supreme government, there are several local budgets, including the revenue and expenditure incidental to the individual provinces.

The general budget in 1899 and 1904 is summarized below:—

	Receipts.	Expenditure.
1899 . . . . .	£1,968,770	£1,639,800
1904 . . . . .	2,809,851	2,797,031

While direct taxes, e.g. the poll-tax and land tax and (in Cambodia) the tax on products, are the main sources of revenue for the local budgets, those for the general budget are the indirect taxes: (1) customs (£619,616 in 1904); (2) "régies" and other indirect taxes (£1,733,836 in 1904), these including the excise on alcohol, the monopoly of the purchase and sale of salt, and the monopoly of the purchase, manufacture and sale of opium.

The chief items of expenditure in 1904 were the following:—

Public Works . . . . .	£385,680
Customs and "régies" . . . . .	618,654
Naval and Military Services . . . . .	527,663
Loans <sup>2</sup> . . . . .	417,421

**Shipping.**—The following table shows the total tonnage of shipping entered and cleared at the ports of French Indo-China in 1905 and its distribution over the countries of the Union:—

Country.	Tonnage.	
	Entered.	Cleared.
Cochin-China . . . . .	1,117,054	1,007,510
Tongking . . . . .	242,119	348,947
Annam . . . . .	28,065	26,406
Cambodia . . . . .	2,520	2,012
Total . . . . .	1,389,758	1,384,875

Over half the tonnage was French (698,178 tons entered); the

<sup>2</sup> This does not include the expenditure on account of the  $\frac{3}{4}$  loan of £8,000,000, which is inscribed in a special account. The debt of the government-general of Indo-China is composed as follows:—

	Nominal Capital.	Nominal Capital in circulation on Jan. 1, 1907.
2½% Loan of 1896 (Annam-Tongking) . . . . .	£3,678,000	£3,342,800
3½% Loan of £8,000,000 issued from 1899 to 1905 . . . . .	8,748,260	8,640,060
Total . . . . .	£12,426,260	£11,982,860

<sup>1</sup> This does not apply to the budget of Cochinchina, which is voted by the colonial council and approved by the governor-general alone.

United Kingdom came second (284,277 tons); Germany, third (205,615 tons).

Commerce.—The value of the trade of French Indo-China increased from 16,796,000 in 1896 to 116,933,000 in 1905, its average annual value for the years 1896-1905 being 112,213,000.

The following table shows the movement of commerce in 1905:

	Imports.	Exports.	Total.
France	£ 4,314,586	£ 1,233,295	£ 5,547,881
French colonies	163,568	76,855	240,423
Foreign countries	5,794,257	5,440,156	11,144,413
Total	10,182,411	6,750,306	16,932,717

In 1905 the principal foreign countries from which goods were imported were:

Hong Kong	for	£2,473,883
Singapore	"	598,449
China and Japan	"	1,473,794
Burma and Siam	"	280,542
The British Isles	"	141,381
The United States	"	126,425

The principal countries to which goods were exported were:

Hong Kong	for	£1,706,597
China and Japan	"	497,288
Singapore	"	360,510
Burma and Siam	"	80,071
The British Isles	"	55,539

The principal imports were:

Wheat	for	£214,156
Rice	"	226,755
Raw opium	"	271,582
Raw cotton	"	167,020
Wine	"	340,027
Pit coal	"	206,221
Petroleum	"	388,163
Gold	"	303,369
Iron and steel	"	253,214
Tin	"	526,428
Cotton thread	"	672,040
Jute tissues	"	254,255
Cotton tissues	"	932,250
Silk tissues	"	241,113
Paper	"	344,633
Metal-work	"	1,170,576
Arms, powder and ammunition	"	170,882

The principal exports were:

Dried fish, salt and smoked	for	£151,415
Rice	"	2,848,389
Pepper	"	214,297
Pit coal	"	182,077
Tin	"	553,914
Cotton thread	"	421,162

The customs tariff is substantially the same as that of France, severe import duties being levied on foreign goods. French goods pay no import duty and goods exported thither are exempt from export duty, with the exception of sugar, which is regulated by special legislation and of various other colonial products (e.g. coffee, cocoa, tea, vanilla, pepper) which pay half the duty applicable to similar foreign products according to the minimum tariff. Goods from French colonies pay no import duty. About 53% of the imports, comprising nearly all manufactured goods of European origin, come from France. China, Japan and Singapore are the other chief sources of imports. The Bank of Indo-China (capital 1,400,000) besides receiving deposits and discounting bills, issues bank-notes and has, till 1920, the privilege of lending money on security.

Communications.—The railway communications of French Indo-China comprise lines from Hai-Phong to Lao-Kay, continued thence via the Nam-Te valley to Yun-nan; from Hanoi northward to Lang-Son and south to Vinh; from Tourane to Kwang-Tri via Hué and from Kan-Tho (Cochin-China) to Khanh-Hoa (Annam) via My-Tho, Saigon, Bien-Hoa and Jiring with branches to Phan-Tiet and Phan-Rang. The three last are the completed sections of a line which will unite Tongking with Cochin-China. The towns in the deltas of the Mekong and Red river are united by a network of canals. The main road following the coast line of Annam connects Tongking with Cochin-China, but the easiest means of communication between these two territories is by sea, the voyage from Saigon to Tourane lasting three days, that from Tourane to Hai-Phong, thirty hours.

History.—The beginning of French influence in Indo China dates from 1787, when a treaty was concluded between Gia-

long, king of Annam (q.v.), and the king of France, whereby Tourane and the island of Pulo-Condore were ceded to the latter. The successors of Gia-long were averse from French influence and instituted persecutions of the Christian missionaries and natives, which led, in the reign of Tu-duc in 1858, to the arrival at Tourane of a French and Spanish fleet. The capture of that town was followed early in 1859 by the storming of Saigon, which Rigault de Genouilly, the French admiral, chose as his base of operations. The French and Spanish were, however, too few to take the offensive, and were forced to submit to a blockade, conducted by the Annamese general Nguyen Tri Phuong, at the head of 20,000 troops. It was not till February 1861 that reinforcements under Admiral Charner reached Saigon, and the Annamese were defeated and My-Tho taken. A revolt against Tu-duc in Tongking, and the stoppage of the rice supplies from Cochin-China, obliged the king to submit, in 1862, to a treaty by which three provinces of Cochin-China were ceded and other concessions accorded to France. However, it was only after further military operations that Tu-duc consented to the ratification of the treaty. In 1863 Admiral de la Grandière was appointed governor of Cochin-China and in the same year France established her protectorate over Cambodia. It was under La Grandière that the exploration of Mekong was undertaken (see GARNIER, M J. F.) and that in 1867 the three provinces of Cochin-China left to Annam were annexed. French intervention in Tongking, which began with the expedition of François Garnier to Hanoi in 1873, culminated after a costly and tedious war (see TONGKING) in the treaties of 1883 and 1884, whereby Annam and Tongking passed under the protectorate of France. The latter treaty, though its provisions were subsequently much modified, remains theoretically the basis of the present administration of Annam.

From 1884 onwards the history of Indo-China may be divided into two distinct periods, characteristic of the political conception and governmental system adopted by the French government. In the first period, 1884-1891, the French agents in Tongking and Indo-China generally proceeded under cover of the treaty of 1884 with the definite conquest and annexation of Tongking and also Annam. Cochin-China itself openly designed to seize the southern provinces of Annam, upon the borders of which it lay. This policy, momentarily checked by the war with China, was vigorously, even violently, resumed after the treaty of Tientsin (June 1885). The citadel of Hué was occupied in July 1885 by General de Courcy. The Annamese government forthwith decided upon rebellion. An improvised attack upon the French troops was led by the ministers Thu-yét and Thu-ong. The revolt was promptly suppressed. The regent Thu-yét and the king Ham-N'ghi (crowned in August 1884) fled. At this time the French government, following a very widespread error, regarded Tongking and Annam as two distinct countries, inhabited by populations hostile to each other, and considered the Tongkingese as the oppressed vassals of the Annamese conqueror. To conquer Annam, it was said, would liberate Tongking. This misconception produced the worst consequences. With the flight of the king civil war commenced in Annam. The people of Tongking, whose submission the court of Hué had not dared to demand, began to rise. Taking advantage of this state of anarchy, pirates of the Black Flag, Chinese deserters and Tongkingese rebels devastated the country. The occupation of Tongking became a prolonged warfare, in which 25,000 French, compelled to guard innumerable posts, had to oppose an intangible enemy, appearing by night, vanishing by day, and practising brigandage rather than war. The military expenditure, met neither by commerce, which had become impossible, nor taxation, which the Annamese could not pay nor the French receive, resulted in heavy deficits. The resident-general, Paul Bert, who hoped to gain the confidence of the mandarins by kindness and goodwill, did not succeed in preventing, or even moderating, the action of the military régime. Than-quan, Hon-Koi, Lao-Kay, Pak-Lun and Kao-Pang were occupied, but the troops were driven back to the delta and almost invested in the towns. Disappointed in his hopes and worn out

<sup>1</sup>The transit trade between Hong Kong and Yun-nan via Tongking is of considerable importance (see TONGKING).

rather by anxiety than work, Paul Bert succumbed to his troubles in November 1886, seven months after his arrival in the country. His successors possessed neither the strength nor the insight necessary to grapple with the situation. M. Constans, however, appointed "provisional" governor-general after the death of M. Filippini, succeeded to a certain extent in reviving commerce in the towns of the delta. MM. Richaud, Bihourd and Piquet, successors of M. Constans, were all powerless to deal with the uninterrupted "bush-fighting" and the augmentation of the deficit, for no sooner was the latter covered by grants from the mother country than it began to grow again. At the close of the financial year in 1890 France had paid 13,000,000 francs. In April 1891 the deficit again approached the sum of 12,000,000 francs. The rebels held almost all the delta provinces, their capitals excepted, and from Hanoi itself the governor-general could see the smoke of burning villages at the very gates of his capital.

At this point a complete change of policy took place. M. de Lanessan, a Paris deputy sent on a mission in the course of 1887, made himself acquainted with the government and the court of Hué. He recognized the absolute falsity of the story which represented the Tongkinese as the oppressed subjects of the Annamese. He demonstrated the consanguinity of the populations, and after intercourse with the regents, or ministers, of Hué he realized that the pacification of the country depended upon harmonious relations being established between the general government and the court. Appointed governor-general with the fullest powers on the 21st of April 1891, he presented himself at Hué, concluded with the *comat* an agreement based on the principle of a "loyal protectorate," and reassured the court, up to this point uneasy under menace of annexation. The *comat* shortly issued a proclamation under the great royal seal, never hitherto attached to any of the public acts imposed upon the king by the governors, who had been unaware of its existence. In this proclamation the king ordered all his subjects to obey the governor-general and to respect him, and commanded rebels to lay down arms. The effect was immediate—disorders in the delta ceased. The pirates alone, in revolt against the king of Annam and all authority, continued their brigandage. But the governor-general instituted four "military districts," the commanders of which were commissioned to destroy the pirates. At the same time he placed a force of native police, the *linh co*, at the disposal of the mandarins, hitherto regarded with suspicion and intentionally deprived of all means of action. Order was restored within the delta. In the mountainous districts infested by pirates roads were opened and posts established. The chief haunts of the pirates were demolished, and during 1893 the foremost pirate chiefs gave in their submission. The Indo-Chinese budget regained its balance. On the Chinese frontier agreements were concluded with Marshal Sou, in command of the Chinese forces, regarding the simultaneous repression of piracy in both countries. But on the Mekong difficulties arose with the Siamese. For centuries Siam had occupied the right bank of the Mekong, and her troops had crossed the river and occupied the left bank. Luang-Prabang was in the hands of the Siamese, who had also established posts at Stung-treng and elsewhere. Friction occurred between the French agents and Siamese soldiery. After the death of Inspector Croscurin on the 5th of June 1893 the French government occupied Stung-treng and Khong. France demanded explanations and redress at Bangkok, but the court refusing concessions, an ultimatum was presented to the king by M. Pavie, French minister to Siam. The terms of the ultimatum not having been complied with within the given time, the French flotilla, consisting of the gunboats "L'Inconstant" and "La Comète," crossed the bar of the Menam on 13th July 1893, forced the entrance of the channel, and anchored at Bangkok, before the French legation. A second ultimatum was then presented. It contained the following conditions:—First the occupation of Chantabun by the French until the Siamese should have entirely evacuated the left bank of the Mekong; secondly, the Siamese to be interdicted from maintaining military forces at Battambang,

Siem-Rep, and generally from establishing fortified positions within 15½ m. of the right bank of the Mekong; thirdly, Siam to be interdicted from having armed boats on the great lake Tonle-Sap. This agreement was executed immediately, the Laotians being eager parties to it. On the 20th of September 1893 the king of Luang-Prabang made his submission to the French government, and besought it to use its influence with the court of Siam for the return to their families of the sons of princes and mandarins then in schools at Bangkok. The Siamese evacuated the left bank of the Mekong, and France took possession of Laos, a treaty, on the basis of the ultimatum, being signed on the 1st of October 1893. The disputes to which this affair with Siam had given rise between France and Great Britain were amicably settled by an agreement concluded on the 15th of January 1896. This "declaration," virtually ratifying the treaty concluded in 1893 between France and Siam, settled the limits of the zones of influence of the two contracting powers in the north of the Mekong regions and on the frontiers of Siam and Burma. Great Britain resigned to France the regions of the Muong-Sing which she had previously occupied. The great part of Siam included in the Menam basin was declared neutral, so also the Me-ping basin in the north, Meklong Pechaburi and Bang Pa Kong rivers in the south. The neutral zone, 15½ m. wide on the right bank of the Mekong, was formally recognized.

In 1904, by a new Franco-Siamese treaty setting aside that of 1893, Chantabun was evacuated and the neutral zone renounced in return for the cession of the provinces of Bassac and Melupré and the district of Dansai (comprising the portion of Luang Prabang on the right bank of the Mekong) and the maritime district of Krat. By a further convention in 1907 Siam ceded the provinces of Battambang, Siem-Rep and Sisophon, and received in return the maritime province of Krat and the district of Dansai ceded in 1904. At the same time France abandoned all designs on territory of Siam by giving up certain areas obtained for the purposes of railway building on the right bank of the Mekong.

After the recall of M. de Lanessan in 1894 (see above), and before his successor, M. Rousseau, was able to acquaint himself fully with the condition of the country, military expeditions began again and the deficit soon reappeared. Tranquillity, however, being restored, attention was given to public works. On the 12th of October 1895 M. Rousseau left to ask parliament to vote a loan of 100,000,000 francs. On the 10th of February 1896 a law was passed authorizing a loan of 80,000,000 francs, and on the 14th of March 1896 an office for the financial control of the government-general of Indo-China was established. In the interval a French company had obtained from China a concession to prolong the railway from Langson to Lungchow on a tributary of the Canton river. M. Rousseau, who died on the 10th of December 1896, was replaced by M. Doumer, previously minister of finance, under whose government was realized, as has been before stated, the union of Indo-China. On the 20th of December 1898 M. Doumer obtained from parliament authorization to contract a loan of 200,000,000 francs, the proceeds of which were appropriated to the construction of railway lines.

AUTHORITIES.—M. J. F. Garnier, *Voyage d'exploration en Indo-Chine* (Paris, 1873); J. M. A. de Lanessan, *L'Indo-Chine française* (Paris, 1886); P. Doumer, *L'Indo-Chine française* (Souverains) (Paris, 1908); F. Bernard, *Indo-Chine* (Paris, 1901); L. Salau, *L'Indo-Chine* (Paris, 1903); A. Girault, *Principes de colonisation et de législation coloniale* (Paris, 1907); M. Petit, *Les Colonies françaises* (2 vols., Paris, 1902); J. C. Gervais Courtellemont, *L'Indo-Chine* (Paris, 1902); A. Neton, *L'Indo-Chine et son avenir économique* (Paris, 1904); A. Pavie, *Mission Pavie Indo-Chine (1879-1895): Géographie et voyages* (Paris, 1901-1906); H. Lorin, *La France: puissance coloniale* (Paris, 1906); M. Monnier, *La Tour d'Asie: Cochinchine, Annam, Tonkin* (Paris, 1899); E. Bonhoure, *L'Indo-Chine* (Paris, 1900); R. Castex, *Les Rivières indo-chinoises* (Paris, 1904); L. de Reinach, *Le Laos* (Paris, 1902) (this work gives a very complete bibliography); *Annuaire général administratif, commercial et industriel de l'Indo-Chine* (Hanoi); *Revue Indochinoise* (Hanoi); C. Madrolle, *Guide-Books* (Paris, 1904-1907); *Bulletin économique de l'Indo-Chine* (Saigon).

(J. M. A. DE L.; R. TR.)

**INDO-EUROPEAN LANGUAGES.** The Indo-European (I.E.) languages are a family of kindred dialects spread over a large part of Europe, and of Asia as far as India.

The main branches so far identified fall easily into two groups of four. These groups are distinguished from one another by the treatment of certain original guttural sounds, *k(c)*, *g*, *kh*, *gh*, which one group shows as consonants, while the other converts them into sibilants. The variation is well shown in the word for "hundred": Gr. *é-karvō*, Lat. *centum*, Old Irish *cēt*; Sanskrit *śatam*, Zend *satəm*, Lithuanian *šimtas*, Old Bulgarian (Old ecclesiastical Slavonic) *silo*. In the first three the consonant is a hard guttural (the Romans said *centum*, not *sentum*), in the others it is a sibilant (the Lithuanian *sz* is the English *sh*).

The first group (generally known as the *centum*-group) is the Western and entirely European group, the second (generally known as the *satem*-group) with one exception lies to the east of the *centum*-group and much its largest part is situated in Asia. To the *centum*-group belong (1) Greek; (2) the Italic languages, including Latin, Oscan, Umbrian and various minor dialects of ancient Italy; (3) Celtic, including (a) the Q-Celtic languages, Irish, Manx and Scotch Gaelic, (b) the P-Celtic, including the language of ancient Gaul, Welsh, Cornish and Breton: the differentiation, which exists also in the Italic languages, turning upon the treatment of original *kw* sounds, which all the Italic languages save Latin and the little-known Faliscan and the (b) group of the Celtic languages change to *p*. With these go (4) the Germanic or Teutonic languages, including (a) Gothic, (b) the Scandinavian languages, Swedish, Danish, Norwegian, Icelandic—differentiated in historical times out of a single language, Old Norse,—(c) West Germanic, including English and Frisian, Low Frankish (from which spring modern Dutch and Flemish), Low and High German.

To the *satem*-group belongs (1) Aryan or Indo-Iranian, including (a) Sanskrit, with its descendants, (b) Zend, and (c) Old Persian, from which is ultimately descended Modern Persian, largely modified, however, by Arabic words. This group is often divided into two sub-groups, *Indo-Aryan*, including the languages of India, and *Iranian*, used as a general title for Zend and Old Persian as the languages of ancient Iran. Although the sounds of Indo-Aryan and Iranian differ considerably, phrases of the earliest form of the one can be transliterated into the other without change in vocabulary or syntax. (2) To the west of these lies Armenian, which is so full of borrowed Iranian words that only in 1875 was it successfully differentiated by Hübschmann as an independent language. It is probably related to, or the descendant of, the ancient Phrygian, which spread into Asia from Thrace by the migration of tribes across the Hellespont. Of ancient Thracian unfortunately we know very little. (3) North of the Black Sea, and widening its borders in all directions, comes the great Balto-Slavonic group. In this there are two branches somewhat resembling the division between Indo-Aryan and Iranian. Here three small dialects on the south-east coast of the Baltic form the first group, Lithuanian, Lettish and Old Prussian, the last being extinct since the 17th century. The Slavonic languages proper themselves fall into two groups: (a) an Eastern and Southern group, including Old Bulgarian, the ecclesiastical language first known from the latter part of the 9th century A.D.; Russian in its varieties of Great Russian, White Russian and Little Russian or Ruthenian; and Servian and Slovene, which extend to the Adriatic. (b) The western group includes Polish with minor dialects, Czech or Bohemian, also with minor languages in the group, and Sorb. In the *satem* division is also included (4) Albanian, which like Armenian is much mixed with foreign elements—Latin, Greek, Turkish and Slavonic. The relation between it and the ancient Illyrian is not clear.

Besides the languages mentioned there are many others now extinct or of which little is known—*e.g.* Venetic, found in clearly written inscriptions with a distinctive alphabet in north-eastern Italy; Messapian, in the heel of Italy, which is supposed to have been connected with the ancient Illyrian; and possibly also the unknown tongue which has been found recently on several inscriptions in Crete and seems to have been the language of the

pre-Hellenic population, the finds apparently confirming the statement of Herodotus (vii. 170) that the earlier population survived in later times only at Praesos and Polichne. Names of deities worshipped by the Aryan branch are reported to have been discovered in the German excavations at Boghaz-Keui (anc. *Pteria*, *q.v.*) in Cappadocia; names of kings appear in widely separated areas elsewhere in Asia,<sup>1</sup> and a language not hitherto known has recently been found in excavations in Turkestan and christened by its first investigators Tocharish.<sup>2</sup> So far as yet ascertained, Tocharish seems to be a mongrel dialect produced by an intermixture of peoples speaking respectively an I.E. language and a language of an entirely different origin. The stems of the words are clearly in many cases I.E., but the terminations are no less clearly alien to this family of languages. It is remarkable that some of its words, like *ku*, "dog," have a hard *k*, while the other languages of this stock in Asia, so far as at present known, belong to the *satem*-group, and have in such words replaced the *k* by a sibilant.

Till the latter part of the 18th century it was the universal practice to refer all languages ultimately to a Hebrew origin, because Hebrew, being the language of the Bible, was assumed, with reference to the early chapters of Genesis, to be the original language. Even on these premises the argument was unsound, for the same authority also recorded a confusion of tongues at Babel, so that it was unreasonable to expect that languages thus violently metamorphosed could be referred so easily to a later period to the same original. The first person to indicate very briefly the existence of the Indo-European family, though he gave it no distinctive name, was Sir William Jones in his address to the Bengal Oriental Society in 1786. Being a skilled linguist, he recognized that Sanskrit must be of the same origin as Greek, Latin, Teutonic (Germanic) and possibly Celtic (*Asiatic Researches*, i. p. 422; *Works of Sir W. Jones*, i. p. 26, London, 1799). Unfortunately Sir William Jones's views as to the relationship of the languages were not adopted for many years by later investigators. He had said quite definitely, "No philologist could examine them all three (Sanskrit, Greek and Latin) without believing them to have sprung from some common source, which perhaps no longer exists." Friedrich Schlegel, who learnt Sanskrit from Alexander Hamilton in Paris nearly twenty years later, started the view that Sanskrit, instead of being the sister, was the mother of the other languages, a mistake which, though long since refuted in all philological works, has been most persistent.

Curiously enough the history of the names given to the family is obscure. The earliest known occurrence of the word "Indo-European" is in an article in the *Quarterly Review* for 1813<sup>3</sup> by Dr Thomas Young. The term has been in use in English and in French almost continuously since that date. But a glance at Dr Young's article will show that he included under Indo-European many languages like Basque, Etruscan and Arabian (his term for Semitic), which certainly do not belong to this family of languages at all; and if the term is taken to mean, as it would seem to imply, all the languages spoken in India and Europe, it is undoubtedly a misnomer. There are many languages in India, as those of the Dravidians in Southern India and those of Northern Assam, which do not belong to this family. On the other hand there are many languages belonging to the family which exist outside both India and Europe—Zend, Old Persian, Armenian, Phrygian, to say nothing of language recently discovered. The term most commonly used in Germany is "Indo-Germanic." This was employed by Klaproth as early as 1823. It is said not to have been invented by him, but by whom and

<sup>1</sup> E. Meyer, *Sitzungsberichte der Berliner Akademie* (1908, pp. 14 ff.), and more fully in *Kuhn's Zeitschrift* (xlii. pp. 17 ff.); also *Geschichte des Altertums* (i. 2, 2nd ed. pp. 807 ff.).

<sup>2</sup> Sieg and Sieglig, "Tocharisch, die Sprache der Indoskythen" (*Sitab. d. Berl. Ak.* 1908, pp. 915 ff.).

<sup>3</sup> No. ix. p. 255. "Another ancient and extensive class of languages, united by a greater number of resemblances than can well be altogether accidental, may be denominated the Indo-European, comprehending the Indian, the West Asiatic, and almost all the European languages."

when it was invented is not quite ascertained.<sup>1</sup> It is an attempt to name the family by its most easterly and most westerly links. At the time when it was invented it had not yet been settled whether Celtic was or was not a member of this family. But in any case the term would not have been wrong, for members of the Germanic stock have been settled for above a thousand years in Iceland, the most westerly land of Europe, and for the last four centuries have increasingly dominated the continent of America. As has been pointed out by Professor Buck of Chicago (*Classical Review*, xviii, p. 400), owing to the German method of pronouncing *eu* as *oi*, the word "Indo-Germanic" is easier for a German to pronounce than "Indo-European." Attempts to discover a more accurate and less ponderous term, such as "Indo-Celtic" or "Celtindic," have not met with popular favour. Aryan (*q.v.*) is conveniently brief, but is wanted as the proper term for the most easterly branch of the family. What is wanted is a term which does not confuse ethnological and linguistic ideas. Not all speakers of any given language are necessarily of the same stock. In ancient Rome Latin must have been spoken by many slaves or sons of slaves who had no Latin blood in their bodies, though a slave if manumitted by his master might be the father or grandfather of a Roman citizen with full rights. Plautus and Terence were both aliens, the one an Umbrian, the other an African. The speakers of modern English are even a more multifarious body. A possible name for the family, implying only the speaking of a language of the stock without any reference to racial or national characteristics, could be obtained from the name for man, so widely though perhaps not altogether universally diffused throughout the family—Sanskrit *vīras*, Lithuanian *vyras*, Lat. *vir*, Irish *fear*, Gothic *waitr*, &c. If the speakers of these languages were called collectively *Vīras*, no confusion with ethnological theories need arise.

It is customary to talk of the roots, stems and suffixes of words in the Indo-European languages. These languages are distinguished from other languages by the fact that in the great majority of words suffixes can be separated from roots. But the distinction between them and the so-called agglutinative languages is one of degree rather than of kind. In the agglutinative languages, or at any rate in some of them, some of the post-fixed elements may stand an independent value. In the Indo-Germanic languages no one can say what the meaning of the earliest suffixes was. Suffixes which have developed in individual languages or individual sections of this family of languages can often be traced, e.g. the often quoted *-hood* in English words like "manhood," or the English *-ly* in "manly," which has gradually extended till it is actually attached to its own parent *like* in "likely." But all recent investigation goes to show that before the Indo-European languages separated they possessed words with all the characteristics which we recognize in substantives like the Latin *dominus* or verbs like the Greek *διδάσκειν*. Or, to put the same fact in another way, by the comparative method it is impossible to reach a period when the speakers of Indo-European languages spoke in roots. A "root" is only a convenient philological abstraction; it is merely the remnant which is left when all the elements that can be analysed are taken away; it is therefore only a kind of greatest common measure for a greater or smaller body of words expressing modifications of the same idea. Thus, though by no means the earliest form of the word, the English *man* might be taken as the "root" from which are derived by various suffixes *manhood*, *manly*, *mannish*, *manful*, *manned* (past tense), *manned* (participle), *unman*, *mannikin*, &c. How far the suffixes which can be traced back to Indo-European times (*Lt.* to a time before the separation of the languages) had existence as separate entities it is impossible to say. From what we see of the later history of the languages it is much more probable that both forms and signification were very largely the result of analogy. For in the making of new words analogy plays a much larger part than any reference to general principles of formation or composition. New words are to a large extent, even in modern times, the invention of persons unskilled in the history of language.

The first to point out that the term Indo-European (or Indo-Germanic) was not used uniformly by one single writer, Professor Kretschmer in his *Einführung in die Geschichte der griechischen Sprache* (Göttingen, 1896), pp. 9 ff. It is in fact used in three senses. (1) Indo-European is treated as preceding and different from all its descendants, a single uniform speech without dialects. But, strictly, no such language can exist, for even individual members of the same family differ from one another in pronunciation, vocabulary,

sentence formation, etc. Thus it appears impossible to ascertain what the Indo-European term for the numeral 1 was, since different languages show at least four words for this, three of them presenting the same root with different suffixes: (a) Sanskrit *ekā* (= \**oek-qoo-*); (b) Zend *asō*, Old Persian *asō*; Greek *(-)* *ἓξ* (= \**oek-ju-*); (c) Greek *οἶς*, *ἄς*, Latin *unus* (older *unus*), Old Irish *oen*, Gothic *ain*, &c. (where the initial *s* has no real etymological significance though the *w* to which now begins the pronunciation of the English *one*), Old Bulgarian *inā*; (d) Greek *εἶς*, *ἓ* (= *sem-s*). But the Indo-European community must have had a word for the numeral since the various languages agree in forms for the numerals 2 to 10, and the original Indo-European people seem to have been able to count at least as far as 100. On the other hand, if the Indo-European language must have had dialects, the line of differentiation between it and its descendants becomes obliterated. (2) But even when we are found very widely diffused over the area of the Indo-European languages, it is not justifiable to conclude that therefore the word must have belonged to the original language. The dispersion of the Indo-European people over the areas they now inhabit, or inhabited in the earliest times known to history, must have been gradual, and commerce or communication between different branches must have always existed to some extent; the word might thus have been transmitted from one community to another. When a word is found in two branches which are geographically remote from one another and is not found in the intermediate area, the probability that it is original is often somewhat stronger. But even in this case the originality of the word is by no means certain, for (a) the intervening branch or branches which do not possess the word may merely have dropped it and replaced it by another; (b) the geographical position which the branches occupy in historical times may not be their original position; the branches which do not possess the word may have forced themselves into the area they now occupy after they had dropped the word; (c) if the linguistic communities which possess the word have a seaboard and the intervening communities have not, the possibility of its transmission in connexion with early sea-borne commerce must be considered. At the dawn of European history the Phoenicians and the Etruscans are great seafarers; at a later time the Varangians of the North penetrated to the Mediterranean and as far as Constantinople; in modern times sea-borne commerce brought to Europe words from the Caribbean Indians like *potato* and *tabacco*, and gave English a new word for man-eating savages—*cannibal*. Thus with Kretschmer we must distinguish between what is common to all the Indo-European languages and what is original in languages.

(3) A word may exist in several of the languages, and may have existed in them for a very long time, and yet not be Indo-European. Hehn (*Das Salz*, ed. 2, 1901) rejects *salt* as an Indo-European word because it is not found in the Aryan group, though in this case he is probably wrong, (a) because, as has been shown by Professor Johannes Schmidt, its irregular declension (*sāl-d*, genitive *sāl-nes*) possesses characteristics of the oldest Indo-European words; (b) because the great plains of Iran are characterized by their great saltiness, so that the Aryan branch did not pass through a country where salt was unknown, although, according to Herodotus (i. 133), the Persian did not use salt to season his food. Since Kretschmer wrote, this argument has been used very extensively by Professor A. Meillet of Paris in his *Dialectes indo-européens* (Paris, 1908). In this treatise he brings forward arguments from a great variety of facts to show that in the original Indo-European language there were dialects, the Aryan, Armenian, Balto-Slavonic and Albanian, as we have seen, forming an original group with novel characteristics developed in common, though in various other characteristics they do not agree. Similarly Italic, Celtic and Germanic form a Western group, while Greek agrees now with the one group now with the other, at some points being more intimately connected with Italic than with any other branch, at others inclining more towards the Aryan. This grouping, however, is by no means exclusive, members of either group having characteristics in common with individuals of the other group which they do not share with the other languages of their own group (Meillet, p. 134 ff.).

From all this it is clear that in many cases it must be extremely uncertain what is original Indo-European and what is not. Some general characteristics can, however, be predicated from what is handed down to us in the earliest forms of all or nearly all the existing languages. (1) The noun had certainly a large number of distinct cases in the singular: nominative, accusative, genitive, ablative, locative, instrumental, dative.<sup>1</sup> In the plural, however, there was less variety, the forms for dative and ablative being from the earliest times identical. In the dual, the oblique cases cannot be restored with certainty, so little agreement is there between the languages. In the locative-singular the ending *-i* seems to have been of the nature of a post-position, because in various languages (notably in Sanskrit) forms appear without any suffix. In the locative plural also the difference between the *-su* of Sanskrit and early Lithuanian (Slavonic *-chu*) on the one hand, and of *-ai* in Greek on the other,

<sup>1</sup> See Meyer, "Über den Ursprung der Namen Indogermanen, Semiten und Aryaner," in the *Göttinger gelehrte Nachrichten*, philologisch-historische Klasse, 1901, pp. 454 ff.

<sup>1</sup> The vocative is not strictly speaking a case at all, for it stands outside the syntax of the sentence. It was originally an exclamatory form consisting of the bare stem without case suffix. In the plural the nominative is used to supply the lacking vocative form.

seems to be best explained by supposing that the *-u* and *-i* are postpositions, a conclusion which is strengthened by the Greek rule that *-o-* between vowels disappears. In the instrumental singular and plural it is noticeable that there are two suffixes—*o-*, represented in Germanic and Balto-Slavonic only, beginning with the sound *-m*, the other, surviving in most of the other languages for the plural, going back to an Indo-European form beginning with *-bi-*. Professor Hirt's *Lehrbuch der vergleichenden Sprachlehre* (v. 7, pp. 251 ff.) that *-bi-* originally belonged to the instrumental plural (cf. the Lat. *fiatibus, omnibus*, &c.), and the forms with *-m* to the dative and ablative. But this is merely a conjecture, which has no linguistic facts in its favour, for the *-bi* of the Latin dative *tibi*, which has parallel forms in many other languages, belongs to the pronouns, which show in their declension many differences from the declension of the noun (cf. also Brugmann, *Grundriss* (ed. 2), ii. 2, p. 120).

(2) The adjective agrees with its noun in gender, number and case, thus introducing a superfluous element of agreement which is not found, e.g. in most of the agglutinative languages. Thus in phrases like the Greek  $\tau\acute{\eta}\ \kappa\alpha\lambda\acute{\eta}\ \psi\acute{\alpha}\nu\eta\varsigma$  or the Latin *illa pulchra puella* the feminine gender is expressed three times, with no advantage, so far as can be detected, over the modern English, that *fair maid*, where it is not obviously expressed at all. In this respect and also in the employment of the same case endings for the plural as well as the singular, in the plural after a syllable expressing plurality, the agglutinative languages have a distinct superiority over the Indo-European languages in their earliest forms. Some languages like English and Modern Persian, have practically got rid of inflexion altogether, and the distinctness of their adjectives, like modern German, as the result of phonetic and analogical changes have even intensified the difficulty.

(3) In the personal pronouns, especially those of the first and second persons, there is widely spread agreement, but more in the singular than in the plural. Forms corresponding to the English *I* and *thou*, the Latin *ego* and *tu*, are practically universal. On the other hand the demonstrative pronouns vary very considerably. (4) The system of numerals (subject to slight discrepancies, as that regarding 1 mentioned above) is the same, at least up to 100. (5) In the verb there were at first two voices, the active and the middle, and three moods, the indicative, the subjunctive and the optative. It has been suggested by Professor Oertel and Morris in *Harvard Studies*, xvi. (p. 101, n. 3) that the similarity which exists between the earliest Greek and the earliest Aryan in the moods is the result of a longer common life between those two branches. But of this there is no proof, and the great difference in the treatment of the sounds by these two branches (see below) militates very strongly against the supposition. The tense forms indicated originally not relations in time but different kinds of action.

The distinctive forms at the present, the perfect, and the aorist. The present is that in which the action is progressing or continuous, the aorist on the other hand regarded the action as a whole and, as it were, summed it up. The aorist has sometimes been said to express instantaneous action, and so it does. But this is not the essence of the aorist; the aorist may be used also of a long continued action when it is regarded as a whole. Greek shows this very clearly. In Athenian official inscriptions it was usual to fix the date of the record by stating at the commencement who was the chief magistrate (archon) of the year. This was expressed by the imperfect ( $\theta\acute{\alpha}\nu\epsilon\tau\epsilon$ ). But when reference was made to a past archonship, this was expressed by the aorist. A very characteristic is evident also in prohibitions; thus, in Plato's *Apology of Socrates*,  $\mu\eta\ \theta\acute{\alpha}\nu\eta\tau\epsilon$  is "Do not begin to make a disturbance,"  $\mu\eta\ \theta\alpha\upsilon\theta\eta\tau\epsilon$  is "Do not keep on making a disturbance." These points are most easily illustrated from Greek, because Greek, better than the other languages, has kept the distinctive usages of both moods and tenses. The perfect as distinguished from the other forms expresses either repetition of the action, emphasis, or the state which results from the action expressed by the verb. Different languages regard this last in different ways. Sometimes the state resulting from the action is so characteristic that the perfect is almost an independent verb. Thus in Greek  $\kappa\acute{\alpha}\tau\alpha\mu\alpha\iota$  is "I acquire," but  $\acute{\epsilon}\kappa\tau\alpha\mu\alpha\iota$  (the perfect) is "I possess," the result of the action of acquiring. On the other hand the perfect may mean that the action has come to an end. This is specially common in Latin, as in Cicero's famous announcement of the execution of the Catilinarian conspirators.—*Vixerunt* ("They have lived" = "They are no more"). But it is by no means confined to Latin. The pluperfect, the past of the perfect, is a late development and can hardly be reckoned Indo-European.

In Greek the forms clearly arise from adding aorist endings to a perfect stem. The forms of Latin are not yet completely explained—but it is certain that the specially Latin meaning expressing something that was past at a time already past (relative time) is a late growth. When Homeric Greek wishes to express this meaning it uses most frequently the aorist, but also the imperfect as well as the pluperfect, the notion of relative time being derived from the context. In the earliest Latin the pluperfect is not uncommonly used with the value of the aorist perfect. As regards the future it is difficult to say how far it was an original form. Some languages, like Germanic, preserve no original form for the future. When the future is not formed, the perfect is almost always periphrastic forms come in. In other languages, like Latin and Greek, there is constant confusion between subjunctive and future

forms. It is impossible to distinguish by their form between  $\delta\acute{\alpha}\lambda\omega$  (future) and  $\delta\acute{\alpha}\lambda\omega$  (subjunctive), between *regam* (future) and *regam* (subjunctive). A special future with a suffix  $-\sigma\acute{\alpha}\nu\omega$  (*yo-*) is found only with certainty in the Aryan group and the Baltic languages. The future perfect is, strictly speaking, only a future made from a perfect stem; in the Latin sense it is certainly a late development, and even in early Latin, *videro* has occasionally no different meaning from *videbo*. The imperative, which was originally an exclamatory form to the verb, of the same kind as the vocative was to the noun, and which consisted simply of the verb stem without further suffixes, developed, partly on the analogy of the present and partly with the help of adverbs, a complete paradigm. The infinitives of all the languages are noun cases, generally stereotyped in form and no longer in touch with a noun system, though this, e.g. in early Sanskrit, is not always true. The participles differ only from other adjectives in governing the same case as their verb; and this is not an early distinction, for in the earliest Sanskrit all verbal nouns may govern the same case as their verb.

The system here sketched in the barest outline tended steadily to fall into decay. The case system was not extensive enough to express even the commonest relations. Thus there was no means of distinguishing by the cases between starting from outside and starting from inside, ideas which, e.g. Finnish regards as requiring separate cases: without a preposition it was impossible to distinguish between *on* and *in*, though to the person concerned there is much difference, for example between being on a river and in a river. There are also in the same kind of the same line. These have been got over by the use of adverbs. But no sooner had the adverbs become well established for the purpose of defining these local relations than the meaning was felt to exist more in the adverb than in the case ending. For this syntactical reason, as well as for mechanical reasons arising from accent (*q.v.*), the case system in some languages fell more and more into desuetude. In Sanskrit it has been kept entire, in Balto-Slavonic the only loss has been the disappearance of the original genitive and its replacement by the ablative. In Latin the locative has been confused with the genitive and the ablative, according to the law of the same kind. The loss of the locative as an independent case had not long preceded historical times, because it survives in Oscan, the kindred dialect of the neighbouring Campania. Greek has confused ablative with genitive, except for one small relic recently discovered on an inscription at Delphi; in the consonant stems it has replaced the dative by the locative form and confused it in dative, locative and instrumental meanings. In some other members of the family, e.g. Germanic, the confusion has gone still farther.

The fate of the verb is similar, though the two paradigms do not necessarily decay at the same rate. Thus Latin has modified its verb system much more than has the noun system. In Greek, by reducing seriously its noun forms, shows a very elaborate verb system, which has no parallel except in the Aryan group. From the syntactical point of view, however, the Greek system is much superior to the Aryan, which has converted its perfect into a past tense in classical Sanskrit, and to a large extent lost grip of the moods. The decay in Aryan may be largely attributed to the power, which this group developed beyond any other, of making compounds which in practice took the place of subordinate sentences to a large extent. The causes for the modifications which the Latin verb system has undergone are more obscure, but they are shared not only by its immediate neighbours the other Italic dialects, but also to a great degree by the more remote Celtic dialects.

The origin and spread of the Indo-European languages has long been, and remains, a vexed question. No sooner had Bopp laid the foundation of Comparative Philology in his great work, the first edition of which appeared in 1833-1835, than this question began to be seriously considered. The earlier writers agreed in regarding Asia as the original home of the speakers of these languages. For this belief there were various grounds,—statements in the Biblical record, the greater originality (according to Schlegel) of Sanskrit, the absurd belief that the migrations of mankind always proceeded towards the west. The view propounded by an English philologist, Dr R. G. Latham, that the original home was in Europe, was scouted by one of the most eminent writers on the subject—Victor Hehn—as lunacy possible only to one who lived in a country of cranks. Latham's view was first put forward in 1851, and in half a century opinion had almost universally come over to his side. Max Müller indeed to the last held to the view that the home was "somewhere in Asia," and Professor Johannes Schmidt of Berlin, in a paper read before the Oriental Congress at Stockholm in 1880, argued for a close contact between early Indo-European and Assyrian civilization, from the borrowing of one or two words and the existence of duodecimal elements in the Indo-European numeral system side by side with the prevalent decimal system—the dozen, the gross, the long hundred (120), &c.

At 60 the systems crossed, and 60 was a very characteristic element in Assyrian numeration, whence come our minutes and seconds and many other units.<sup>1</sup>

Even before Latham a Belgian geologist, d'Omalius d'Halloy, in 1848 had raised objections to the theory of the Asiatic origin of the Indo-Europeans, but his views remained unheeded. In 1864 he brought three questions before the *Société d'anthropologie* of Paris: (1) What are the proofs of the Asiatic origin of Europeans? (2) Have not inflectional languages passed from Europe to Asia rather than from Asia to Europe? (3) Are not the speakers of Celtic languages and the descendants of the autochthonous peoples of Western Europe? (Reinach, *op. cit.* p. 38). Broca in replying to d'Omalius emphasized the fact which has been too often forgotten in this controversy, that race and language are not necessarily identical. In 1868 Professor Benfey of Göttingen argued for the south-east of Europe as the original home, while Ludwig Geiger in 1871 placed it in Germany, a view which in later times has had not a few supporters.

Truth to tell, however, we are not yet ready to fix the site of the original home. Before this can be done, many factors as yet imperfectly known must be more completely ascertained. The pre-historic conditions of Northern, Western, Central and South-eastern Europe have been carefully investigated, but important new discoveries are still continually being made. Investigation of other parts of Europe is less complete, and prehistoric conditions in Asia are at present very imperfectly known. In Western Europe two prehistoric races are known, the palaeolithic and the neolithic. The former, distinguished by their great skill in drawing figures of animals, especially the horse, the reindeer, and the mammoth, preceded the period of the Great Ice Age which rendered Northern Europe to the latitude of London and Berlin uninhabitable for a period the length of which, as of all geological ages, cannot definitely be ascertained. For the present purpose, however, this is of less importance, because it is not claimed that the Indo-European stock is of so great antiquity. But when the ice again retreated it must have been long before Northern Europe could have maintained a population of human beings. The disappearance of the surface ice must have been followed by a long period when ice still remained underground, and the surface was occupied by swamps and barren tundras, as Northern Siberia is now. Then a human population once more occupied Northern Europe, and it is impossible to say in years.

The problem may be attacked from the opposite direction. How long would it have taken for the Indo-European stock to spread from its original home to its modern areas of occupation? Some recent writers say that it is unnecessary to carry the stock back farther than 2500 B.C.—a period when the civilizations of Egypt and Mesopotamia were already ancient. Wherever the original home was situated, this date is probably fixed too low. The discussion, moreover, is in danger not only of moving in one vicious circle but in two. (a) The term "Indo-European stock" necessarily implies race, but we might not the language as being from the earliest times at which we can trace it the language of a mixed race? (b) It is usual to assume that the Indo-European stock was tall and blond, in fact much as the classical writers describe the early Germans. But the truth of this hypothesis is much more difficult to demonstrate. In most countries known to the ancients where blond hair prevailed, at the present day dark or brown hair is much more in evidence. Moreover the colour of fair hair often varies from childhood to middle life, and the flaxen hair of youth is very frequently replaced by a much darker shade in the adult. It has been often pointed out that many of Homer's heroes are *xanthoi*, and it is frequently argued that *xanthos* means blond. This, however, is anything but certain, even when Vacher de Lapouge has collected all the passages in ancient writers which bear upon the subject. When Diodorus (v. 32) wishes to describe the children of the Galatæ, by whom apparently he means the Germans, he says that their hair as children is generally white, but as they grow up it is assimilated to the colour of their fathers. The ethnological argument as to long-headed and short-headed races (dolichocephalic and brachycephalic) seems untrustworthy, because in countries described as dolichocephalic short skulls abound and vice versa. Moreover this classification, to which much more attention has been devoted than its inventor Retzius ever intended, is in itself unsatisfactory. The relation between the length and breadth of the head without consideration of the total size is clearly an unsatisfactory criterion. It is true that to the mathematician  $\frac{3}{4}$  or  $\frac{4}{5}$  or  $\frac{5}{6}$  are of identical value, but if it be also generally true that mental and physical energy are dependent on the size and weight of the brain, then the mere mathematical relation between length and breadth is of less importance than the size of the quantities. Anthropologists now appear now to recognize this themselves.

The argument from physical geography seems equally unimpaired. But here also no certain answer can be obtained till more is known of the conditions, in early times, of the eastern part of the area.

According to Ratzel<sup>2</sup> the Caspian was once very much larger than it is now, and to the north of it there extended a great area of swamp, which made it practically impossible for the Indo-European race to have crossed north of the Caspian from either continent to the other. At an early period the Caspian and Black Sea were connected, and the Sea of Marmora and the Dardanelles were represented by a river which entered the Aegean at a point near the island of Andros. At the present time the northern Aegean was still land divided only by a river, it is clear that migration from south-eastern Europe to Asia Minor, or reversely, might have taken place with ease. Even in much later times the Dardanelles have formed no serious barrier to migration in either direction. At the dawn of history, Thracian tribes crossed it and founded, it seems, the Phrygian and Armenian stock in Asia Minor; the Gauls at a later time followed the same road, as did Alexander the Great a generation earlier. At the end of the middle ages, Asia sent by way of the Dardanelles the invading Turks into Europe. The Greeks, a nation of seafarers on the other hand reached Asia directly across the Aegean, using the islands, as it were, as stepping-stones.

Though much more attention has been devoted to the subject by recent writers than was earlier the practice, it is doubtful whether migration by sea has even now been assigned its full importance. The most mysterious people of antiquity, the Pelagians, do not seem to be in all cases the same stock, as their name appears merely to mean "the people of the sea." *Πελαγοί* representing an earlier *πελαγος*, and where *πελαγος* is the weak form of the stem of *πέλαγος*, "sea," and *ωο* the ending so frequent in the names of peoples. A parallel to the sound changes may be seen in *μάγοι*, for *μάγωοι*, by the side of *μάγιστροι*. As titles of evidence we have more to tend to confirm the truth of the great migrations by sea, recorded by Herodotus, of Lydians to Etruria, of Eteoetrans both to east and west. An argument in favour of the original Indo-Europeans being seated in north-western Germany has been developed by G. Kossinna (*Zeitschrift für Ethnologie*, 1902, pp. 161-222) from the forms and ornamentation of ancient pottery. It has certainly not been generally received with favour, and as Kossinna himself affirms that the classification of prehistoric pottery is still an unexplored science, his conclusion, as it is presented, is unequal to the weight of such a superstructure as he would build upon it. As the allied sciences are not prepared with an answer, it is necessary to fall back upon the Indo-European languages themselves. The attempt has often been made to ascertain both the position of the original home and the stage of civilization which the original community had reached from a consideration of the vocabulary for plants and animals common to the various languages of the Indo-European family. But the experience of recent centuries warns us to be wary in the application of this argument. If we cut off all past history and regard the language of the present day as we have to perform to regard our earliest records, two of the words most widely disseminated amongst the Indo-European people of Europe are *tobacco* and *potato*. Without historical records it would be impossible for us to discover that these words in their earliest European form had been borrowed from the Caribbean Indians. Most languages tend to adopt with an imported product the name given to it by its producers, though frequently misunderstanding arises, as in the case of the two words mentioned, the *potato* being properly the yam, and *tobacco* being properly the pipe, while *petum* or *petan* (cp. *petunia*) was the plant.

The first treatise in which an attempt was made to work out the primitive Indo-European civilisation in detail was Adolphe Pictet's *Les Origines indo-européennes ou les Aryas primitifs* (1859-1863). The idyllic conditions in which, according to Pictet, early Indo-European man subsisted were accepted and extended by many enthusiastic successors. The father, the protector of the family (*pater* from *pā*, protect), and the mother (*mater* from *mā*, to produce) were surrounded by their children (Skt. *putra*), whose name implied that of the next generation clean and near. The daughter was the milkmaid (Skt. *dadhā* from *dah*, milk), while the brother (Skt. *bhrātrā*), derived from the root of *ferre*, "bear," was the natural protector of his sister, whose name, with some hesitation, is decided to mean "she who dwells with her brother," the notion of brother and sister marriage being, however, summarily rejected (ii. p. 365). The uncle and aunt are a second father and mother to the family, and for this reason *nepos*, Skt. *napāt*, is both nephew and grandson. The life of such families was pastoral but not nomad; there was a farmstead where the women were busied with housewifery and butter-making, while the men drove their flocks afield. The ox, the horse, the sheep, the goat and the pig were domesticated as well as the dog and the farmyard fowls, but it was in oxen that their chief wealth consisted. Hence a cow was offered to an honoured guest, cows were the object of armed raids upon their neighbours, and when a member of the family died, a cow was killed to accompany him in the next world. Even the phenomena of nature to their

<sup>1</sup> For the history of the controversy see the excellent summary in Salomon Reinach's *L'Origine des Aryens: Histoire d'une controverse* (1892). Max Müller's latest views are contained in his *Biographies of Words and the Home of the Aryas* (1888). See Schmidt's *Die Urheimat der Indogermanen und das europäische Zahlssystem* (1890).

<sup>2</sup> "Geographische Prüfung der Tatsachen über den Ursprung der Völker Europas" (*Berichte der k. sächsischen Ges. d. Wissenschaften*, 1900, pp. 34 ff.).

<sup>3</sup> See the essay on "Evolution and the Science of Language," in Darwin and Modern Science (1909), p. 524 f.

# FRENCH INDO-CHINA & SIAM

Scale: 1:18,000,000

0 50 100  
English Miles  
0 100 200  
Kilometers

State Capitals.....  
Provincial Capitals.....  
Railways.....





naive imaginations could be represented by cows: the clouds of heaven were cows whose milk nourished the earth, the stars were a herd with the sun as the bull amongst them, the earth was a cow yielding her increase. Before the original community, which extended over a wide area with Bactria for its centre, had broken up, agriculture had begun, and barley, if not other cereals, and various leguminous plants were cultivated. Oxen drew the plough and the wagon. Industry also had developed with the introduction of agriculture; the carpenter with a variety of tools appears to construct farm implements, buildings and furniture, and the smith is no less busy. Implements had begun with stone, but by this time were made of bronze if not of iron, for the metals gold, silver, copper, tin were certainly known. Spinning and weaving had also begun; pottery was well developed. The flocks and herds and agriculture supplied food with plenty of variety; fermented liquors, mead, probably wine and perhaps beer, were used, not always in moderation. A great variety of military weapons had been invented, but geographical reasons prevented navigation from developing in Bactria. Towns existed and fortified places. The people were organized in clans, the clans in tribes. At the head of all, though not in the most primitive epoch, was the king, who reigned not by hereditary right, but by election. Though money had not yet been invented, exchange and barter flourished; there were borrowers and lenders, and property passed from father to son. Though we have no definite information as to their laws, justice was administered; murder, theft and fraud were punished with death, imprisonment or fine (*Résumé général* at end of vol. ii.).

Further investigation, however, did not confirm this ideally happy form of primitive civilization. Many of Picet's etymologies were erroneous, many of his deductions based on very uncertain evidence. No recent writer adopts Picet's views of the Indo-European family. But his list of domesticated animals is approximately correct, if domestication is used loosely simply of animals that might be kept by the Indo-European man about his homestead. Even at the present day domestication means different things in the case of different animals. A pig is not domesticated as a dog is; in areas like the Hebrides or western Ireland, where cattle and human beings share the two ends of the same building, domestication means something very different from the treatment of large herds on a farm extending to many hundreds of acres. In other respects the height of the civilization was vastly exaggerated. That the Indo-European people were agricultural as well as pastoral seems highly probable. But as Heraclides says of the Athamæans (*Fragmenta hist. Græc.* ii. 219), the women were the agriculturists, while the men were shepherds. Agriculture begins on a very small scale with the dibbling by means of a pointed stick of a few seeds of some plant which the women recognize as useful either for food or medicine, and is possible only when the people have ceased to be absolutely nomad and have fixed settlements and a continuous period of growth. The pastoral habit is broken down in men only by starvation, if the pasture-lands become too cramped through an excessive increase of population or are seized by a conqueror. As has been well said, "of all the ordinary means of gaining a livelihood—with the exception perhaps of mining—agriculture is the most laborious, and is never voluntarily adopted by men who have not been accustomed to it from their childhood" (Mackenzie Wallace, *Russia*, new ed. i. p. 266, in relating the conversion of the Bashkir Tatars to agriculture). Even the plough, in the primitive form of a tree stump with two branches, one forming the handle, the other the pole, was developed, and in this period may belong the representations in rock carvings in Sweden and the Alps of a pair of oxen in the plough (S. Müller, *Nordische Altertumskunde*, i. 205; Dechelette, *Manuel d'archéologie*, ii. pp. 492 ff.). The Indo-European civilization in its beginnings apparently belongs to the chalcolithic period (sometimes described by the barbarous term of Italian origin *emolithic*) when copper, if not bronze had come in, but the use of stone for many purposes had not yet gone out. While primitive Indo-European man apparently knew, as has been said, the horse, ox, sheep, goat, pig and dog, it is to be observed that in their wild state at least these animals do not all affect the same kind of area. The horse is an animal of the open plain; the foal always accompanies the mother, for at first its neck is too short to allow it to graze, and the mare, unlike the cow, has no large udder in which to carry a great supply of milk. The cow, on the other hand, hides her calf in a brake when she goes to graze, and is more a woodland animal. The pig's natural habitat is the forest where beech mast, acorns, or chestnuts are plentiful. The goat is a climber and affects the heights, while the sheep also prefers short grass to the richer pastures suited to kine. To collect and tame all those animals implies control of an extensive and varied area.

What of the trees known to primitive Indo-European man? On this the greater part of the arguments regarding the original home have turned. The name for the beech extends through a considerable number of Indo-European languages, and it has generally been assumed that the beech must have been known to the first man; therefore must have been a tree which flourished in the original home. Now the habitat of the beech is to the west of a line drawn from Königsberg to the Crimea. The argument assumes that its distribution was always the same. But nothing is more certain than that in different ages different trees succeed one another on

the same soil. In the peat mosses of north-east Scotland are found the trunks of vast oaks which have no parallel among the trees which grow in the same district now, where the oak has a hard struggle to live at all, and where experience teaches the planter that coniferous trees will be more successful. On the coast of Denmark in the same way the conifer has replaced the beech since the days of the "kitchen middens," from which so much information as to the primitive inhabitants of that area has been obtained. But with regard to the names of trees there are two serious pitfalls which it is difficult to avoid. (a) It is common to give a tree the name of any herb which it habitually resembles. In England the original plane does not grow freely north of the Trent; accordingly, farther north the sycamore, which has a leaf that a casual observer might think similar, has usurped the name of the plane. (b) In the case of the beech (*Lat. Fagus*), the corresponding Greek word *φάγος* does not mean beech but oak, or possibly, if one may judge from the magnificent trees of north-west Greece, the chestnut. It has been suggested that the word is connected with the verb *φαίνω* to eat, so that it was originally the tree with edible fruit and could thus be specialized in different senses in different areas. If, however, Bartholomæ's connexion of the Kurd *bû*, "elm" (*Jdg. Forschungen*, ix. 271) be correct, there can be no relation between *φαίνω* and *φάγος*, but the latter comes from a root *g* which becomes *g* would become *g* among the *sater* languages. The birch is a more widely spread tree than the beech, growing as luxuriantly in the Himalayas as in western Europe, but notwithstanding, the Latin *fraxinus*, which is almost certainly of the same origin, means not birch but ash, while the oak akin to ash (*Gr. ἄσκη*) appears in Latin without the *k* suffix as *os* in Latin *ornus*, "mountain ash," for an earlier *\*osnus*, cp. Old Bulgarian *jasenŭ* (the *j* has no etymological value), Welsh and Cornish *onnen*, from the original *ek* *\*onna* from *\*os-na*. One of the most widely spread tree names is the word tree itself, which appears in a variety of forms, *Gr. ὄπις*, *Goth. triu*; *Skt. dāru*, *ḍāru*, *ḍāru*, &c., which is sometimes as in Greek specifically limited to the oak, while the Indo-European *(dewān)* conifer is *Schrader's* *beech* in his remarkable book, *Sprachvergleichung und Urschichte* (1883, 3rd ed., 1906-1907), locates the original home in southern Russia, would allow the original community (ii. p. 178) to be partly within, partly without the beech line. The only other tree the name of which is widely spread is the willow: the English *with*, *witly*, *Lat. vitex*, *Gr. ἴσρα* for *Frax*, Lithuanian *vitis*, *Zend vāiti*. Otherwise the words for trees are limited to a small number of languages, and the meaning in different languages is widely different, as *Gr. ἄλγυς*, "pine," Old High German *linta*, "linden," with which go the Latin *linter*, "boat," and Lithuanian *lentā*, "board." The lime tree and the birch do not exist in Greece, and the Latin *betula* is a borrowing from Gaulish (Irish *beith*), the native word *fraxinus*, as we have seen the *Skt. vīṣ*, meaning corn or barley, in *Zend* corn (*moṣu*), with *Gr. ῥίζω*, "bow," is no doubt correct; Schrader's equation of *Skt. dhawan*, "bow," with the German *tanne*, "fir," must, if correct, show at least a change of material, for no wood is less well adapted for a bow than fir. The only conclusion that can be drawn with apparent certainty from the names of trees is that the original settlements were not in the southern peninsula of Europe.

Some of the names for cultivated plants are widely spread, but like the names of trees do not always indicate the same thing. This is not surprising if we consider that the word *corn*, within the Teutonic languages alone, means wheat in England, oats in Scotland, rye in Germany, barley in Sweden, maize in the United States of America. Schrader's *Skt. vīṣ*, meaning corn or barley, in *Zend* corn (*moṣu*), Persian *jan*, barley, but in the language of the Ossetes *yeu*, *yau* is millet, the Gk. *ῥέ* is spelt, the Lithuanian *javai* corn, the Irish *corn* barley (Schrader, *Sprachvergleichung*, ii. p. 188). The word here or barley itself is widely spread in Europe—Latin *far*, spelt, *Goth. barzeins*, "of barley," Old Norse *barr*, Old Slav, *būra*, a kind of millet (*ibid.*). But the original habitat of the cultivated grain plants has not yet been clearly established, and circumstances of many kinds may occasion a change in the kind of grain cultivated, provided another can be found suitable to be barley. In early England it is clear that the prevalent crop was the *climber*, for *barn* is the *bere-ern* or barley-house.

The earliest tree-fruit found in Europe are apparently those discovered at Edouard Pictet as Mas d'Azil in a stratum which he places between palæolithic and neolithic. They included nuts, plums, birdcherry, sloe, &c., and along with them was a little heap of grains of wheat. If Pictet's observations are correct, this find must go back to a date long preceding the fruits found by Heer in the pile-dwellings of Switzerland. Here also cherry-stones were found, though the modern cherry is said to have been imported first by Lucullus in the first century B.C. from Cerasus in Pontus, whence its name. In the pile-dwellings a considerable number of apples were found. They were generally cut up into two or three pieces, apparently to be dried for winter use, and in all probability they were wild apples of the variety *Pirus silvatica* which is found even to the whole of Central Europe from north to south (Buschan, *Vergeschichtliche Botanik*, p. 165). The original habitat of the apple is uncertain, but it is supposed to be indigenous at any rate south of the Black Sea (Schrader, *Reallexikon*, s. v. *Apfelbaum*). The history of the name is obscure; it is often connected with the Campanian town Abella, which Virgil (*Aeneid*, vii. 740) calls *malifera*.

"apple-bearing." Here also the material for fixing the site of the original habitat is untrustworthy.

The attempt has been made to limit the possible area by a consideration of three animals which are said not to occur in certain parts of it—(a) the eel, which is said not to be found in the Black Sea; (b) the honey bee, which is not found in that part of Central Asia drained by the Oxus and Jaxartes; (c) the tortoise, which is not found in northern areas. From evidence collected by Schrader from a specialist at Bucharest (*Sprachevergleichung*,<sup>2</sup> ii. p. 147) *eels are found in the Black Sea*. The argument, therefore, for excluding the area which drains into the Black Sea from the possible habitat of the primitive Indo-European community falls to the ground. Honey was certainly familiar at an early age, as is shown by the occurrence of the word \*medhu, Skt. *mádhu*, Gr. *μέθυ* (here the meaning has shifted from mead to wine), Irish *míid*, English *mead*, Old Slav. *medú*, Lithuanian *medús* honey, *mádús* mead. Schrader, who is the first to utilize the name of the tortoise in this argument, points out (*op. cit.*, p. 148) that forms from the same root occur in both a *centum* and a *satem* language—Gr. *χελίς*, *χελών*, Old Slav. *čelý*, *čelávis*—but that while it reaches far north in eastern Europe, it does not pass the 46th parallel of latitude in western Europe. This argument would make not only the German site for the original home which is supported by Kossinna and Hirt impossible, but also that of Scandinavia contended for by Penka.

From the foregoing it will be seen that the arguments for any given area are not conclusive. In the great plain which extends across Europe north of the Alps and Carpathians and across Asia north of the Hindu Kush there are few geographical obstacles to prevent the rapid spread of peoples from any part of its area to any other, and, as we have seen, the Celts and the Hungarians, &c., have, in the historical period, demonstrated the rapidity with which such migrations could be made. Such migration may possibly account for the appearance of a people using a *centum* language so far east as Turkestan. But our information as to Tocharian is still too fragmentary to decide the question. It is impossible here to discuss at any length the relations between the separate Indo-European languages, a subject which has formed, from somewhat different points of view, the subject of Kretschmer's *Einführung in die Geschichte der griechischen Sprache* and Meillet's *Les Dialectes indo-européens*.

**BIBLIOGRAPHY.**—Besides the articles on the separate languages in this Encyclopaedia the following works are the most important for consultation: K. Brugmann (phonology and morphology) and B. Delbrück (syntax), *Grundriss der vergleichenden Grammatik der indogermanischen Sprachen* (1886-1900), 2d. ed., 2 vols. 1. (1897); of vol. 2 two large parts, including the stem formation and inflexion of the noun, the pronoun and the numerals, have been published in 1906 and 1909. A shorter work by Brugmann, *Kurse vergleichende Grammatik der indogermanischen Sprachen*, dealing mainly with Sanskrit, Greek, Latin, Germanic and Slavonic, appeared in three parts in 1902-1903. A good but less elaborate work is A. Meillet, *Introduction à l'étude comparative des langues indo-européennes* (1903, 2nd ed. 1908). For the ethnological argument: W. Z. Ripley, *The Races of Europe* (1900); G. Sergi, *The Mediterranean Race* (English edition, 1901). Other works, now largely superseded, which deal with this argument are K. Penka, *Origines Ariacae* (1883), and *Die Herkunft der Arier* (1886), and I. Taylor, *The Origin of the Aryans*, n.d. (1890). The ethnologists are no more in agreement than the philologists. For the arguments mainly from the linguistic side see especially O. Schrader, *Sprachevergleichung und Urgeschichte* (3rd ed., 2 vols., 1906-1907)—the second edition was translated into English by Dr F. B. Jevons under the title *Pre-historic Antiquities of the Aryan Peoples* (1890); *Reaktion der indogermanischen Altertumskunde* (1901); M. Much, *Die Heimat der Indogermanen* (1902); E. de Michel, *Les Origines des Indo-européens* (1903); H. Hirt, *Die Indogermanen* (2 vols., 1905-1907); S. Feist, *Europa im Lichte der Vorgeschichte und die Ergebnisse der vergleichenden indogermanischen Sprachwissenschaft*, 1910, in W. Siegl's *Quellen und Forschungen zur alten Geschichte und Geographie*. Important for special sections of this question are S. Müller, *Nordische Altertumskunde* (2 vols., 1897-1898), and *Urgeschichte Europas* (1905); V. Hehn, *Kulturpflanzen und Haustiere* (1870), 7th ed., edited by O. Schrader, with contributions on botany by H. Engler (1902); J. Hoops, *Wörterbuch und Kulturpflanzen in germanischen Altertum* (1905). Delbrück has devoted a special monograph to the I.-E. names of relationships, from which he shows that the I.-E. family was patriarchal, not matriarchal (*Die idg. Verwandtschaftsnamen*, 1889). E. Meyer, from Tocharian being a *centum* language, has revived with reserve the hypothesis of the Asiatic origin (*Geschichte des Altertums*,<sup>2</sup> 1. 2, p. 801) (P. Gi.)

**INDOLE**, or BENZOPYRROL,  $C_8H_7N$ , a substance first prepared by A. Baeyer in 1868. It may be synthetically obtained by distilling oxindole ( $C_8H_7NO$ ) with zinc dust; by heating ortho-nitrocinamic acid with potash and iron filings; by the reduction of indigo blue; by the action of sodium ethylate on ortho-aminochlorostyrene; by boiling aniline with dichloroacetaldehyde; by the dry distillation of ortho-toloxylic acid; by heating aniline with dichloroacetal; by distilling a mixture of calcium

formate and calcium antiodoacetate; and by heating pyruvic acid phenyl hydrazone with anhydrous zinc chloride. It is also formed in the pancreatic fermentation of albumen, and, in small quantities, by passing the vapours of mono- and dialkylanilines through a red-hot tube. It crystallizes in shining leaflets, which melt at 53° C. and boil at 245° C. (with decomposition), and is volatile in a current of steam. It is a feeble base, and gives a cherry-red coloration with a pine shaving. Many derivatives of indole are known. B-methylindol or skatole occurs in human faeces.

**INDONESIAN**, a term invented by James Richardson Logan to describe the light-coloured non-Malay inhabitants of the Eastern Archipelago. It now denotes all those peoples of Malaysia and Polynesia who are not to be classified as Malays or Papuans, but are of Caucasian type. Among these are the Battaks of north Sumatra; many of the Bornean Dyaks and Philippine Islanders, and the large brown race of east Polynesia which includes Samoans, Maoris, Tongans, Tahitians, Marquesas Islanders and the Hawaiians.

See J. Richardson Logan, *The Languages and Ethnology of the Indian Archipelago* (1877).

**INDORE**, a native state of India in the central India agency, comprising the dominions of the Maharaja Holkar. Its area, exclusive of guaranteed holdings on which it has claims, is 9,500 sq. m. and the population in 1901 was 850,690, showing a decrease of 23% in the decade, owing to the results of famine. As in the case of most states in central India the territory is not homogeneous, but distributed over several political charges. It has portions in four out of the seven charges of central India, and in one small portion in the Rajputana agency. The Vindhya range traverses the S. division of the state in a direction from east to west, a small part of the territory lying to the north of the mountains, but by much the larger part to the south. The latter is a portion of the valley of the Nerbudda, and is bounded on the south by the Satpura hills. Basalt and other volcanic formations predominate in both ranges, although there is also much sandstone. The Nerbudda flows through the state; and the valley at Mandlesar, in the central part, is between 600 and 700 ft. above the sea. The revenue is estimated at £350,000. The metre gauge railway from Khandwa to Mhow and Indore city, continued to Neemuch and Ajmere, was constructed in 1876.

The state had its origin in an assignment of lands made early in the 18th century to Malhar Rao Holkar, who held a command in the army of the Mahratta Peshwa. Of the Dhangar or shepherd caste, he was born in 1694 at the village of Hol near Poona, and from this circumstance the family derives its surname of Holkar. Before his death in 1766 Malhar Rao had added to his assignment large territorial possessions acquired by his armed power during the confusion of the period. By the end of that century the rulership had passed to another leader of the same clan, Tukoji Holkar, whose son, Jaswant Rao, took an important part in the contest for predominance in the Mahratta confederation. He did not, however, join the combined army of Sindha and the raja of Berar in their war against the British in 1803, though after its termination he provoked hostilities which led to his complete discomfiture. At first he defeated a British force that had marched against him under Colonel Monson; but when he made an inroad into British territory he was completely defeated by Lord Lake, and compelled to sign a treaty which deprived him of a large portion of his possessions. After his death his favourite mistress, Tulsi Bai, assumed the regency, until in 1817 she was murdered by the military commanders of the Indore troops, who declared for the Peshwa on his rupture with the British government. After their defeat at Mehidpur in 1818, the state submitted by treaty to the loss of more territory, transferred to the British government its suzerainty over a number of minor tributary states, and acknowledged the British protectorate. For many years afterwards the administration of the Holkar princes was troubled by intestine quarrels, misrule and dynastic contentions, necessitating the frequent interposition of British authority;

and in 1857 the army, breaking away from the chief's control, besieged the British residency, and took advantage of the mutiny of the Bengal sepoy to spread disorder over that part of central India. The country was pacified after some fighting. In 1809 a British resident was appointed to Indore, which had formerly been directly under the agent to the governor-general in central India. At the same time a change was made in the system of administration, which was from that date carried on by a council. In 1903 the Maharaja, Shivaji Rao Holkar, G.C.S.I., abdicated in favour of his son Tukoji Rao, a boy of twelve, and died in 1908.

THE CITY OF INDORE is situated 1738 ft. above the sea, on the river Saraswati, near its junction with the Khan. Pop. (1901) 86,686. These figures do not include the tract assigned to the resident, known as "the camp" (pop. 11,118), which is under British administration. The city is one of the most important trading centres in central India.

INDORE RESIDENCY, a political charge in central India, is not co-extensive with the state, though it includes all of it except some outlying tracts. Area, 8690 sq. m.; pop. (1901) 833,410. (J. S. Co.)

**INDORSEMENT**, or ENDORSEMENT (from Med. Lat. *indorsare*, to write upon the *dorsum*, or back), anything written or printed upon the back of a document. In its technical sense, it is the writing upon a bill of exchange, cheque or other negotiable instrument, by one who has a right to the instrument and who thereby transmits the right and incurs certain liabilities. See BILL OF EXCHANGE.

**INDO-SCYTHIANS**, a name commonly given to various tribes from central Asia, who invaded northern India and founded kingdoms there. They comprise the Sakas, the Yue-Chi or Kushans and the Ephthalites or Hünas.

**INDRA**, in early Hindu mythology, god of the clear sky and greatest of the Vedic deities. The origin of the name is doubtful, but is by some connected with *indu*, drop. His importance is shown by the fact that about 250 hymns celebrate his greatness, nearly one-fourth of the total number in the Rig Veda. He is represented as specially lord of the elements, the thunder-god. But Indra was more than a great god in the ancient Vedic pantheon. He is the patron-deity of the invading Aryan race in India, the god of battle to whose help they look in their struggles with the dark aborigines. Indra is the child of Dyaus, the Heaven. In Indian art he is represented as a man with four arms and hands; in two he holds a lance and in the third a thunderbolt. He is often painted with eyes all over his body and then he is called Sahasraksha, "the thousand eyed." He lost much of his supremacy when the triad Brahma, Siva and Vishnu became predominant. He gradually became identified merely with the headship of Swarga, a local vice-regent of the abode of the gods.

See A. A. Macdonell, *Vedic Mythology* (Strassburg, 1897).

**INDRE**, a department of central France, formed in 1790 from parts of the old provinces of Berry, Orléanais, Marche and Touraine. Pop. (1906) 290,216. Area 2666 sq. m. It is bounded N. by the department of Loir-et-Cher, E. by Cher, S. by Creuse and Haute-Vienne, S.W. by Vienne and N.W. by Indre-et-Loire. It takes its name from the river Indre, which flows through it. The surface forms a vast plateau divided into three districts, the Boischaux, Champagne and Brenne. The Boischaux is a large well-wooded plain comprising seven-tenths of the entire area and covering the south, east and centre of the department. The Champagne, a monotonous but fertile district in the north, produces abundant cereal crops, and affords excellent pasturage for large numbers of sheep, celebrated for the fineness of their wool. The Brenne, which occupies the west of the department, was formerly marshy and unhealthy, but draining and afforestation have brought about considerable improvement.

The department is divided into the arrondissements of Châteauroux, Le Blanc, La Châtre and Issoudun, with 23 cantons and 245 communes. At Neuvy-St-Sépulchre there is a circular church of the 11th century, to which a nave was added

in the 12th century, and at Mézières-en-Brenne there is an interesting church of the 14th century. At Levroux there is a fine church of the 13th century and the remains of a feudal fortress, and there is a magnificent château in the Renaissance style at Valençay.

**INDRE-ET-LOIRE**, a department of central France, consisting of nearly the whole of the old province of Touraine and of small portions of Orléanais, Anjou and Poitou. Pop. (1906) 337,916. Area 2377 sq. m. It is bounded N. by the departments of Sarthe and Loir-et-Cher, E. by Loir-et-Cher and Indre, S. and S.W. by Vienne and W. by Maine-et-Loire. It takes its name from the Loire and its tributary the Indre, which enter it on its eastern border and unite not far from its western border. The other chief affluents of the Loire in the department are the Cher, which joins it below Tours, and the Vienne, which waters the department's southern region. Indre-et-Loire is generally level and comprises the following districts: the Gâtine, a pebbly and sterile region to the north of the Loire, largely consisting of forests and heaths with numerous small lakes; the fertile Varenne or valley of the Loire; the Champagne, a chain of vine-clad slopes, separating the valleys of the Cher and Indre; the Véron, a region of vines and orchards, in the angle formed by the Loire and Vienne; the plateau of Sainte-Maure, a hilly and unproductive district in the centre of which are found extensive deposits of shell-marl; and in the south the Brenne, traversed by the Claise and the Creuse and forming part of the marshy territory which extends under the same name into Indre.

Indre-et-Loire is divided into the arrondissements of Tours, Loches and Chinon, with 24 cantons and 282 communes. The chief town is Tours, which is the seat of an archbishopric; and Chinon, Loches, Amboise, Chenonceau, Langeais and Azay-le-Rideau are also important places with châteaux. The Renaissance château of Ussé, and those of Luynes (15th and 16th centuries) and Pressigny-le-Grand (17th century) are also of note. Montbazou possesses the imposing ruins of a square donjon of the 11th and 12th centuries. Preully has the most beautiful Romanesque church in Touraine. The Sainte Chapelle (16th century) at Champigny is a survival of a château of the dukes of Bourbon-Montpensier. The church of Montrésor (1532) with its mausoleum of the family of Montrésor; that of St Denis-Hors (12th and 16th century) close to Amboise, with the curious mausoleum of Philibert Babou, minister of finance under Francis I. and Henry II.; and that of Ste Catherine de Fierbois, of the 13th century, are of architectural interest. The town of Richelieu, founded in 1631 by the famous minister of Louis XIII., preserves the enceinte and many of the buildings of the 17th century. Megalithic monuments are numerous in the department.

**INDRI**, a Malagasy word believed to mean "there it goes," but now accepted as the designation of the largest of the existing Malagasy (and indeed of all) lemurs. Belonging to the family *Lemuridae* (see *PRIMATES*) it typifies the subfamily *Indrisinae*, which includes the avahi and the sifakas (*q.v.*). From both the latter it is distinguished by its rudimentary tail, measuring only a couple of inches in length, whence its name of *Indris brevicaudatus*. Measuring about 24 in. in length, exclusive of the tail, the indri varies considerably in colour, but is usually black, with a variable number of whitish patches, chiefly about the loins and on the fore-limbs. The forests of a comparatively small tract on the east coast of Madagascar form its home. Shoots, flowers and berries form the food of the indri, which was first discovered by the French traveller and naturalist Pierre Sonnerat in 1780. (R. L. \*)

**INDUCTION** (from Lat. *inducere*, to lead into; cf. Gr. *εἰσαγωγή*), in logic, the term applied to the process of discovering principles by the observation and combination of particular instances. Aristotle, who did so much to establish the laws of deductive reasoning, neglected induction, which he identified with a complete enumeration of facts; and the schoolmen were wholly concerned with syllogistic logic. A new era opens with Bacon, whose writings all preach the principle of investigating the laws

of nature with the purpose of improving the conditions of human life. Unluckily his mind was still enslaved by the formulae of the quasi-mechanical scholastic logic. He supposed that natural laws would disclose themselves by the accumulation and due arrangement of instances without any need for original speculation on the part of the investigator. In his *Novum Organum* there are directions for drawing up the various kinds of lists of instances. For two hundred years after Bacon's death little was done towards the theory of induction; the reason being, probably, that the practical scientists knew no logic, while the university logicians, with their conservative devotion to the syllogism, knew no science. Whewell's *Philosophy of the Inductive Sciences* (1840), the work of a thoroughly equipped scientist, if not of a great philosopher, shows due appreciation of the cardinal point neglected by Bacon, the function of theorizing in inductive research. He saw that science advances only in so far as the mind of the inquirer is able to suggest organizing ideas whereby our observations and experiments are colligated into intelligible system. In this respect J. S. Mill is inferior to Whewell: throughout his *System of Logic* (1843) he ignores the constitutive work of the mind, and regards knowledge as the merely passive reception of sensuous impressions. His work was intended mainly to reduce the procedure of induction to a regular demonstrative system like that of the syllogism; and it was for this purpose that he formulated his famous Four Methods of Experimental Inquiry. His work has contributed greatly to the systematic treatment of induction. But it must be remarked that his Four Methods are not methods of formal proof, as their author supposed, but methods whereby hypotheses are suggested or tested. The actual proof of an hypothesis is never formal, but always lies in the tests of experiment or observation to which it is subjected.

The current theory of induction as set forth in the standard works is so far satisfactory that it combines the merit of Whewell's treatment with that of Mill's; and yet it is plain that there is much for the logician of the future to accomplish. The most important faculty in scientific inquiry is the faculty of suggesting new and valuable hypotheses. But no one has ever given any explanation how the hypotheses arise in the mind: we attribute it to "genius," which, of course, is no explanation at all. The logic of discovery, in the higher sense of the term, simply has no existence. Another important but neglected province of the subject is the relation of scientific induction to the inductions of everyday life. There are some who think that a study of this relation would quite transform the accepted view of induction. Consider such a piece of reasoning as may be heard any day in a court of justice, a detective who explains how in his opinion a certain burglary was effected. If all reasoning is either deductive or inductive, this must be induction. And yet it does not answer to the accepted definition of induction, "the process of discovering a general principle by observation of particular instances": what the detective does is to reconstruct a particular crime; he evolves no general principle. Such reasoning is used by every man in every hour of his life: by it we understand what people are doing around us, and what is the meaning of the sense-impressions which we receive. In the logic of the future it will probably be recognized that scientific induction is only one form of this universal constructive or reconstructive faculty. Another most important question closely akin to that just mentioned is the true relation between these reasoning processes and our general life as active intelligent beings. How is it that the detective is able to understand the burglar's plan of action?—the military commander to forecast the enemy's plan of campaign? Primarily, because he himself is capable of making such plans. Men as active creatures co-operating with their fellow-men are incessantly engaged in forming plans and in apprehending the plans of those around them. Every plan may be viewed as a form of induction; it is a scheme invented to meet a given situation, an hypothesis which is put to the test of events, and is verified or refuted by practical success or failure. Such considerations widen still farther our view of scientific induction and help us to understand

its relation to ordinary human thought and activity. The scientific investigator in his inductive stage is endeavouring to make out the plan on which his material is constructed. The phenomena serve as indications to help him in framing his hypothesis, generally a guess at first, which he proceeds to verify by experiment and the collection of additional facts. In the deductive stage he assumes that he has made out the plan and can apply it to the discovery of further detail. He has the capacity of detecting plans in nature because he is wont to form plans for practical purposes.

There are good recent accounts of induction in Welton's *Manual of Logic*, ii., in H. W. B. Joseph's *Introduction to Logic*, and in W. R. Keyce Gibson's *Problem of Logic*; see also Logic. (H. Str.)

**INDUCTION COIL**, an electrical instrument consisting of two coils of wire wound one over the other upon a core consisting of a bundle of iron wires. One of these circuits is called the primary circuit and the other the secondary circuit. If an alternating or intermittent continuous current is passed through the primary circuit, it creates an alternating or intermittent magnetization in the iron core, and this in turn creates in the secondary circuit a secondary current which is called the induced current. For most purposes an induction coil is required which is capable of giving in the secondary circuit intermittent currents of very high electromotive force, and to attain this result the secondary circuit must as a rule consist of a very large number of turns of wire. Induction coils are employed for physiological purposes and also in connexion with telephones, but their great use at the present time is in connexion with the production of high frequency electric currents, for Röntgen ray work and wireless telegraphy.

The instrument began to be developed soon after Faraday's discovery of induced currents in 1831, and the subsequent researches of Joseph Henry, C. G. Page and W. Sturgeon on the induction of a current. **Early history.** N. J. Callan described in 1836 the construction of an electromagnet with two separate insulated wires, one thick and the other thin, wound on an iron core together. He provided the primary circuit of this instrument with an interrupter, and found that when the primary current was rapidly intermitted, a series of secondary currents was induced in the fine wire, of high electromotive force and considerable strength. Sturgeon in 1837 constructed a similar coil, and provided the primary circuit with a mercury interrupter operated by hand. Various other experimentalists took up the construction of the induction coil, and to G. H. Bachhoffner is due the suggestion of employing an iron core made of a bundle of fine iron wires. At a somewhat later date Callan constructed a very large induction coil containing a secondary circuit of very great length of wire. C. G. Page and J. H. Abbot in the United States, between 1838 and 1840, also constructed some large induction coils.<sup>1</sup> In all these cases the primary circuit was interrupted by a mechanically worked interrupter. On the continent of Europe the invention of the automatic primary circuit interrupter is generally attributed to C. E. Neef and to J. P. Wagner, but it is probable that J. W. M'Gaulley, of Dublin, independently invented the form of hammer break now employed. In this break the magnetization of the iron core by the primary current is made to attract an iron block fixed to the end of a spring, in such a way that two platinum points are separated and the primary circuit thus interrupted. It was not until 1853 that H. L. Fizeau added to the break the condenser which greatly improved the operation of the coil. It 1851 H. D. Rühmkorff (1803-1877), an instrument-maker in Paris, profiting by all previous experience, addressed himself to the problem of increasing the electromotive force in the secondary circuit, and induction coils with a secondary circuit of long fine wire have generally, but unnecessarily, been called Rühmkorff coils. Rühmkorff, however, greatly lengthened the secondary circuit, employing in some coils 5 or 6 m. of wire. The secondary wire was insulated with silk and shellac varnish,

<sup>1</sup> For a full history of the early development of the induction coil see J. A. Fleming, *The Alternating Current Transformer*, vol. ii., chap. i.

and each layer of wire was separated from the next by means of varnished silk or shellac paper; the secondary circuit was also carefully insulated from the primary circuit by a glass tube. Rühmkorff, by providing with his coil an automatic break of the hammer type, and equipping it with a condenser as suggested by Fizeau, arrived at the modern form of induction coil. J. N. Hearder in England and E. S. Ritchie in the United States began the construction of large coils, the last named constructing a specially large one to the order of J. P. Gassiot in 1858. In the following decade A. Apps devoted great attention to the production of large induction coils, constructing some of the most powerful coils in existence, and introduced the important improvement of making the secondary circuit of numerous flat coils of wire insulated by varnished or paraffined paper. In 1869 he built for the old Polytechnic Institution in London a coil having a secondary circuit 150 m. in length. The diameter of the wire was 0.014 in., and the secondary bobbin when complete had an external diameter of 2 ft. and a length of 4 ft. 10 ins. The primary bobbin weighed 145 lb, and consisted of 6000 turns of copper wire 3770 yds. in length, the wire being .095 of an inch in diameter. Excited by the current from 40 large Bunsen cells, this coil could give secondary sparks 30 in. in length. Subsequently, in 1876, Apps constructed a still larger coil for William Spottiswoode, which is now in the possession of the Royal Institution. The secondary circuit consisted of 280 m. of copper wire about 0.01 of an inch in diameter, forming a cylinder 37 in. long and 20 in. in external diameter; it was wound in flat disks in a large number of separate sections, the total number of turns being 341,850. Various primary circuits were employed with this coil, which when at its best could give a spark of 42 in. in length.

A general description of the mode of constructing a modern induction coil, such as is used for wireless telegraphy or

Röntgen ray apparatus, is as follows: The iron core consists of a bundle of soft iron wires inserted in the interior of an ebonite tube. On the outside of this tube is wound the primary circuit, which generally consists of several distinct wires capable of being joined either in series or parallel as required. Over the primary circuit is placed another thick ebonite tube, the thickness of the walls of which is proportional to the spark-producing power of the secondary circuit. The primary coil must be wholly enclosed in ebonite, and the tube containing it is generally longer than the secondary bobbin. The second circuit consists of a number of flat coils wound up between paraffined or shellaced paper, much as a sailor coils a rope. It is essential that no joints in this wire shall occur in inaccessible places in the interior. A machine has been devised by Leslie Miller for winding secondary circuits in flat sections without any joints in the wire at all (British Patent, No. 5811, 1903). A coil intended to give a 10 or 12 in. spark is generally wound in this fashion in several hundred sections, the object of this mode of division being to prevent any two parts of the secondary circuit which are at great differences of potential from being near to one another, unless effectively insulated by a sufficient thickness of shellaced or paraffined paper. A 10-in. coil, a size very commonly used for Röntgen ray work or wireless telegraphy, has an iron core made of a bundle of soft iron wires No. 22 S.W.G., 2 in. in diameter and 18 in. in length. The primary coil wound over this core consists of No. 14 S.W.G. copper wire, insulated with white silk laid on in three layers and having a resistance of about half an ohm. The insulating ebonite tube for such a coil should not be less than  $\frac{1}{4}$  in. in thickness, and should have two ebonite checks on it placed 14 in. apart. This tube is supported on two hollow pedestals down which the ends of the primary wire are brought. The secondary coil consists of No. 36 or No. 32 silk-covered copper wire, and each of the sections is prepared by winding, in a suitable winding machine, a flat coiled wire in such a way that the two ends of the coil are on the outside. The coil should not be wound in less than a hundred sections, and a larger number would be still better. The adjacent ends of consecutive sections are soldered together and insulated,

and the whole secondary coil should be immersed in paraffin wax. The completed coil (fig. 1) is covered with a sheet of ebonite and mounted on a base board which, in some cases, contains the primary condenser within it and carries on its upper surface a hammer break. For many purposes, however, it is better to separate the condenser and the break from the coil. Assuming that a hammer break is employed, it is generally of the Apps form. The interruption of the primary circuit is made between two contact studs which ought to be of massive platinum, and across the break points is joined the primary condenser. This consists of a number of sheets of paraffined paper interposed between sheets of tin foil, alternate sheets of the tin foil being joined together (see LEYDEN JAR). This condenser serves to quench the break spark. If the primary

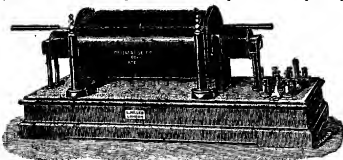

FIG. 1.

condenser is not inserted, the arc or spark which takes place at the contact points prolongs the fall of magnetism in the core, and since the secondary electromotive force is proportional to the rate at which this magnetism changes, the secondary electromotive force is greatly reduced by the presence of an arc-spark at the contact points. The primary condenser therefore serves to increase the suddenness with which the primary current is interrupted, and so greatly increases the electromotive force in the secondary circuit. Lord Rayleigh showed (*Phil. Mag.*, 1901, 581) that if the primary circuit is interrupted with sufficient suddenness, as for instance if it is severed by a bullet from a gun, then no condenser is needed. No current flows in the secondary circuit so long as a steady direct current is passing through the primary, but at the moments that the primary circuit is closed and opened two electromotive forces are set up in the secondary; these are opposite in direction, the one induced by the breaking of the primary circuit being by far the stronger. Hence the necessity for some form of circuit breaker, by the continuous action of which there results a series of discharges from one secondary terminal to the other in the form of sparks.

The hammer break is somewhat irregular in action and gives a good deal of trouble in prolonged use; hence many other forms of primary circuit interrupters have been devised.

These may be classified as (1) hand- or motor-worked interrupters; (2) employing mercury or platinum contacts; (3) turbine mercury interrupters; (4) electrolytic interrupters. In the first class a steel or platinum point, operated by hand or by a motor, is periodically immersed in mercury and so serves to close the primary circuit. To prevent oxidation of the mercury by the spark and break it must be covered with oil or alcohol. In some cases the interruption is caused by the continuous rotation of a motor either working an eccentric which operates the plunger, or, as in the Mackenzie-Davidson break, rotating a slate disk having a metal stud on its surface, which is thus periodically immersed in mercury in a vessel. A better class of interrupter is the mercury turbine interrupter. In this some form of rotating turbine pump pumps mercury from a vessel and squirts it in a jet against a copper plate. Either the copper plate or the jet is made to revolve rapidly by a motor, so that the jet by turns impinges against the plate and escapes it; the mercury and plate are both covered with a deep layer of alcohol or paraffin oil, so that

Inter-  
rupters or  
Breaks.

the jet is immersed in an insulating fluid. In a recent form the chamber in which the jet works is filled with coal gas. The current supplied to the primary circuit of the coil travels from the mercury in the vessel through the jet to the copper plate, and hence is periodically interrupted when the jet does not impinge against the plate. Mercury turbine breaks are much employed in connexion with large induction coils used for wireless telegraphy on account of their regular action and the fact that the number of interruptions per second can be controlled easily by regulating the speed of the motor which rotates the jet. But all mercury breaks employing paraffin or alcohol as an insulating medium are somewhat troublesome to use because of the necessity of periodically cleaning the mercury. Electrolytic interrupters were first brought to notice by Dr A. R. B. Wehnelt in 1898 (*Elektrotechnische Zeitschrift*, January 20th, 1899). He showed that if a large lead plate was placed in dilute sulphuric acid as a cathode, and a thick platinum wire protruding for a distance of about one millimetre beyond a glass or porcelain tube into which it tightly fitted was used as an anode, such an arrangement when inserted in the circuit of a primary coil gave rise to a rapid intermittency in the primary current. It is essential that the platinum wire should be the anode or positive pole. The frequency of the Wehnelt break can be adjusted by regulating the extent to which the platinum wire protrudes through the porcelain tube, and in modern electrolytic breaks several platinum anodes are employed. This break can be employed with any voltage between 30 and 250. The Caldwell interrupter, a modification of the Wehnelt break, consists of two electrodes immersed in dilute sulphuric acid, one of them being enclosed by a glass vessel which has a small hole in it capable of being more or less closed by a tapered glass plug. It differs from the Wehnelt break in that there is no platinum to wear away and it requires less current; hence finer regulation of the coil to the current can be obtained. It will also work with either direct or alternating currents. The hammer and mercury turbine breaks can be arranged to give interruptions from about 10 per second up to about 50 or 60. The electrolytic breaks are capable of working at a higher speed, and under some conditions will give interruptions up to a thousand per second. If the secondary terminals of the induction coils are connected to spark balls placed a short distance apart, then with an electrolytic break the discharge has a flame-like character resembling an alternating current arc. This type of break is therefore preferred for Röntgen ray work since it makes less flickering upon the screen, but its advantages in the case of wireless telegraphy are not so marked. In the Grisson interrupter the primary circuit of the induction coil is divided into two parts by a middle terminal, so that a current flowing in at this point and dividing equally between the two halves does not magnetize the iron. This terminal is connected to one pole of the battery, the other two terminals being connected alternately to the opposite pole by means of a revolving commutator which (1) passes a current through one half of the primary, thus magnetizing the core; (2) passes a current through both halves in opposite directions, thus annulling the magnetization; (3) passes a current through the second half of the primary, thus reversing the magnetization of the core; and (4) passes a current in both halves through opposite directions, thus again annulling the magnetization. As this series of operations can be performed without interrupting a large current through the inductive circuit there is not much spark at the commutator, and the speed of commutation can be regulated so as to obtain the best results due to a resonance between the primary and secondary circuits. Another device due to Grisson is the electrolytic condenser interrupter. If a plate of aluminium and one of carbon or iron is placed in an electrolyte yielding oxygen, this aluminium-carbon or aluminium-iron cell can pass current in one direction but not in the other. Much greater resistance is experienced by a current flowing from the aluminium to the iron than in the opposite direction, owing to the formation of a film of aluminic hydroxide on the aluminium. If then a cell consisting of a number of aluminium plates alternating with

iron plates or carbon in alkaline solution is inserted in the primary circuit of an induction coil, the application of an electromotive force in the right direction will cause a transitory current to flow through the coil until the electrolytic condenser is charged. By the use of a proper commutator the position of the electrolytic cell in the circuit can be reversed and another transitory primary current created. This interrupted flow of electricity through the primary circuit provides the intermittent magnetization of the core necessary to produce the secondary electromotive force. This operation of commutation can be conducted without much spark at the commutator because the circuit is interrupted at the time when there is no current in it. In the case of the electrolytic condenser no supplementary paraffined paper condenser is necessary as in the case of the hammer or mercury interrupters.

An induction coil for the transformation of alternating current is called a transformer (*q.v.*). One type of high frequency current transformer is called an *oscillation transformer* or sometimes a *Tesla coil*. The construction of such a coil is based on different principles from that of the coil just described. If the secondary terminals of an ordinary induction coil or transformer are connected to a pair of spark balls (fig. 2), and if these are also connected to

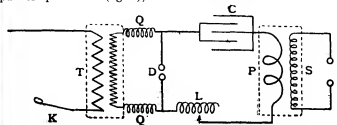

FIG. 2.—Arrangements for producing High Frequency Currents.

T, Transformer or induction coil. L, Inductance.  
Q, Q, Choking coils. P, Primary circuit of high frequency coil.  
C, Condenser. S, Secondary circuit.

a glass plate condenser or Leyden jar of ordinary type joined in series with a coil of wire of low resistance and few turns, then at each break of the primary circuit of the ordinary induction coil a secondary electromotive force is set up which charges the Leyden jar, and if the spark balls are set at the proper distance, this charge is succeeded by a discharge consisting of a movement of electricity backwards and forwards across the spark gap, constituting an oscillatory electric discharge (see ELECTROKINETICS). Each charge of the jar may produce from a dozen to a hundred electric oscillations which are in fact brief electric currents of gradually decreasing strength. If the circuit of few turns and low resistance through which this discharge takes place is overlaid with another circuit well insulated from it consisting of a large number of turns of finer wire, the inductive action between the two circuits creates in the secondary a smaller series of electric oscillations of higher potential. Between the terminals of this last-named coil we can then produce a series of discharges each of which consists in an extremely rapid motion of electricity to and fro, the groups of oscillations being separated by intervals of time corresponding to the frequency of the break in the primary circuit of the ordinary induction coil charging the Leyden jar or condenser. These high frequency discharges differ altogether in character from the secondary discharges of the ordinary induction coil. Theory shows that to produce the best results the primary circuit of the oscillation transformer should consist of only one thick turn of wire or, at most, but of a few turns. It is also necessary that the two circuits, primary and secondary, should be well insulated from one another, and for this purpose the oscillation transformer is immersed in a box or vessel full of highly insulating oil. For full details N. Tesla's original Papers must be consulted (see *Journ. Inst. Elect. Eng.* 21, 62).

In some cases the two circuits of the Tesla coil, the primary and secondary, are sections of one single coil. In this form the

arrangement is called a *resonator* or *auto transformer*, and is much used for producing high frequency discharges for medical purposes. The construction of a resonator is as follows: A bare copper wire is wound upon an ebonite or wooden cylinder or frame, and one end of it is connected to the outside of a Leyden jar or battery of Leyden jars, the inner coating of which is connected to one spark ball of the ordinary induction coil. The other spark ball is connected to a point on the above-named copper wire not very far from the lower end. By adjusting this contact, which is movable, the electric oscillations created in the short section of the resonator coil produce by resonance oscillations in the longer free section, and a powerful high frequency electric brush or discharge is produced at the free end of the resonator spiral. An electrode or wire connected with this free end therefore furnishes a high frequency glow discharge which has been found to have valuable therapeutic powers.

The general theory of an oscillation transformer containing capacity and inductance in each circuit has been given by Oberbeck, Bjerknes and Drude.<sup>1</sup> Suppose there are two circuits, each consisting of a coil of wire, the two being superimposed or adjacent, and let each circuit contain a condenser or Leyden jar in series with the circuit, and let one of these circuits contain a spark gap, the other being closed (fig. 3). If to the spark balls the secondary terminals of an ordinary induction coil are connected, and these spark balls are adjusted near one another, then when the ordinary coil is set in operation, sparks pass between the balls and oscillatory discharges take place in the circuit containing the spark gap. These oscillations induce other oscillations in the second circuit. The two circuits have a certain mutual inductance,  $M$ , and each circuit has self inductance  $L_1$  and  $L_2$ .

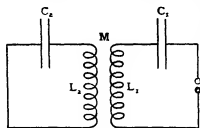

FIG. 3.

- $C_1$ , Condenser in primary circuit.  
 $C_2$ , Condenser in secondary circuit.  
 $L_1$ , Inductance in primary circuit.  
 $L_2$ , Inductance in secondary circuit.

currents,  $i_1$  and  $i_2$ , and potentials,  $v_1$ , and  $v_2$ , in the primary and secondary circuits respectively at any instant:—

$$L_1 \frac{di_1}{dt} + M \frac{di_2}{dt} + R_1 i_1 + v_1 = 0,$$

$$L_2 \frac{di_2}{dt} + M \frac{di_1}{dt} + R_2 i_2 + v_2 = 0,$$

$R_1$  and  $R_2$  being the resistances of the two circuits. If for the moment we neglect the resistances of the two circuits, and consider that the oscillations in each circuit follow a simple harmonic law  $i = \sin pt$  we can transform the above equations into a biquadratic

$$p^4 + \frac{p^2}{C_1 C_2} \frac{L_1 C_1 + L_2 C_2}{L_1 L_2 - M^2} + \frac{1}{C_1 C_2 (L_1 L_2 - M^2)} = 0.$$

The capacity and inductance in each circuit can be so adjusted that their products are the same number, that is,  $C_1 L_1 = C_2 L_2 = CL$ . The two circuits are then said to be in resonance or to be tuned together. In this particular and unique case the above biquadratic reduces to

$$p^2 = \frac{1}{CL} \frac{1+k}{1-k^2},$$

where  $k$  is written for  $M \sqrt{L_1 L_2}$  and is called the *coefficient of coupling*. In this case of resonant circuits it can also be shown that the maximum potential differences at the primary and secondary condenser terminals are determined by the rule  $V_1/V_2 = 2\sqrt{C_2/L_1 C_1}$ . Hence the transformation ratio is not determined by the relative number of turns on the primary and secondary circuits, as in the case of an ordinary alternating current transformer (see TRANSFORMERS), but by the ratio of the capacity in the two oscillation circuits. For full proofs of the above the reader is referred to the original papers.

Each of the two circuits constituting the oscillation transformer taken separately has a natural time period of oscillation; that is to say, if the electric charge in it is disturbed, it oscillates to and fro in a certain constant period like a pendulum and therefore with a certain frequency. If the circuits have the same frequency when

separated they are said to be isochronous. If  $n$  stands for the natural frequency of each circuit, where  $n = p/2\pi$  the above equations show that when the two circuits are coupled together, oscillations set up in one circuit create oscillations of two frequencies in the secondary circuit. A mechanical analogue to the above electrical effect can be obtained as follows: Let a string be strung loosely between two fixed points, and from it let two other strings of equal length hang down at a certain distance apart, each of them having a weight at the bottom and forming a simple pendulum. If one pendulum is set in oscillation it will gradually impart this motion to the second, but in so doing it will bring itself to rest; in like manner the second pendulum being set in oscillation gives back its motion to the first. The graphic representation, therefore, of the motion of each pendulum would be a line as in fig. 4. Such a curve



FIG. 4.

represents the effect in music known as beats, and can easily be shown to be due to the combined effect of two simple harmonic motions or simple periodic curves of different frequency superimposed. Accordingly, the effect of inductively coupling together two electrical circuits, each having capacity and inductance, is that if oscillations are started in one circuit, oscillations of two frequencies are found in the secondary circuit, the frequencies differing from one another and differing from the natural frequency of each circuit taken alone. This matter is of importance in connexion with wireless telegraphy (see TELEGRAPHY), as in apparatus for conducting it, oscillation transformers as above described, having two circuits in resonance with one another, are employed.

REFERENCES.—J. A. Fleming, *The Alternating Current Transformer* (2 vols., London 1900), containing a full history of the induction coil; id., *Electric Wave Telegraphy* (London, 1906), dealing in chap. 1, with the construction of the induction coil and various forms of interrupter as well as with the theory of oscillation transformers; A. T. Hare, *The Construction of Large Induction Coils* (London, 1900); J. Trowbridge, "On the Induction Coil," *Phil. Mag.* (1902), 3, p. 393; Lord Rayleigh, "On the Induction Coil," *Phil. Mag.* (1901), 2, p. 581; J. E. Ives, "Contributions to the Study of the Induction Coil," *Physical Review* (1902), vols. 14 and 15. (J. A. F.)

**INDULGENCE** (Lat. *indulgentia*, *indulgere*, to grant, concede), in theology, a term defined by the official catechism of the Roman Catholic Church in England as "the remission of the temporal punishment which often remains due to sin after its guilt has been forgiven." This remission may be either total (*plenary*) or partial, according to the terms of the Indulgence. Such remission was popularly called a *pardon* in the middle ages—a term which still survives, e.g. in Brittany.

The theory of Indulgences is based by theologians on the following texts: 2 Samuel (Vulgate, 2 Kings) xii. 14; Matt. xvi. 19 and xviii. 17, 18; 1 Cor. v. 4, 5; 2 Cor. ii. 6-11; but the practice itself is confessedly of later growth. As Bishop Fisher says in his Confutation of Luther, "in the early church, faith in Purgatory and in Indulgences was less necessary than now. . . . But in our days a great part of the people would rather cast off Christianity than submit to the rigour of the [ancient] canons: therefore it is a most wholesome dispensation of the Holy Ghost that, after so great a lapse of time, the belief in purgatory and the practice of Indulgences have become generally received among the orthodox" (*Confutatio*, cap. xviii.; cf. Cardinal Caietan, *Tract. XV. de Indulg.*, cap. 1.). The nearest equivalent in the ancient Church was the local and temporary African practice of restoring lapsed Christians to communion at the intercession of confessors and prospective martyrs in prison. But such reconciliations differed from later Indulgences in at least one essential particular, since they brought no remission of ecclesiastical penance save in very exceptional cases. However, as the primitive practice of public penance for sins died out in the Church, there grew up a system of equivalent, or nominally equivalent, private penances. Just as many of the punishments enjoined by the Roman criminal code were gradually commuted by medieval legislators for pecuniary fines, so the years or months of fasting enjoined by the earlier ecclesiastical codes were commuted for proportionate fines, the recitation of a certain number of psalms, and the like. "Historically speaking, it is indisputable that the practice of Indulgences in the medieval

<sup>1</sup> See A. Oberbeck, *Wied. Ann.* (1895), 55, p. 623; V. F. R. Bjerknes, *d.* (1895), 55, p. 121, and (1891), 44, p. 74; and P. K. L. Drude, *Ann. Phys.* (1904), 13, p. 512.

church arose out of the authoritative remission, in exceptional cases, of a certain proportion of this canonical penalty. At the same time, according to Catholic teaching, such Indulgence was not a mere permission to omit or postpone payment, but was in fact a discharge from the debt of temporal punishment which the sinner owed. The authority to grant such discharge was conceived to be included in the power of binding and loosing committed by Christ to His Church; and when in the course of time the vaguer theological conceptions of the first ages of Christianity assumed scientific form and shape at the hands of the Schoolmen, the doctrine came to prevail that this discharge of the sinner's debt was made through an application to the offender of what was called the "Treasure of the Church" (Thurston, p. 315). "What, then, is meant by the 'Treasure of the Church'? . . . It consists primarily and completely of the merit and satisfaction of Christ our Saviour. It includes also the superfluous merit and satisfaction of the Blessed Virgin and the Saints. What do we mean by the word 'superfluous'? In one way, as I need not say, a saint has no superfluous merit. Whatever he has, he wants it all for himself, because, the more he merits on earth (by Christ's grace) the greater is his glory in heaven. But, speaking of mere satisfaction for punishment due, there cannot be a doubt that some of the Saints have done more than was needed in justice to expiate the punishment due to their own sins . . . It is this 'superfluous' expiation that accumulates in the 'Treasure of the Church' (Bp. of Newport, p. 166). It must be noted that this theory of the 'Treasure' was not formulated until some time after Indulgences in the modern sense had become established in practice. The doctrine first appeared with Alexander of Hales (c. 1230) and was at once adopted by the leading schoolmen. Clement VI. formally confirmed it in 1350, and Pius VI. still more definitely in 1794.

The first definite instance of a plenary Indulgence is that of Urban II. for the First Crusade (1095). A little earlier had begun the practice of partial Indulgences, which are always expressed in terms of days or years. However definite may have been the ideas originally conveyed by these notes of time, their first meaning has long since been lost. Eusebius Amort, in 1735, admits the gravest differences of opinion; and the Bishop of Newport writes (p. 163) "to receive an Indulgence of a year, for example, is to have remitted to one so much temporal punishment as was represented by a year's canonical penance. If you ask me to define the amount more accurately, I say that it cannot be done. No one knows how severe or how long a Purgatory was, or is, implied in a hundred days of canonical penance." The rapid extension of these time-Indulgences is one of the most remarkable facts in the history of the subject. Innocent II., dedicating the great church of Cluny in 1132, granted as a great favour a forty days' Indulgence for the anniversary. A hundred years later, all churches of any importance had similar indulgences; yet Englishmen were glad even then to earn a pardon of forty days by the laborious journey to the nearest cathedral, and by making an offering there on one of a few privileged feast-days. A century later again, Wycliffe complains of Indulgences of two thousand years for a single prayer (ed. Arnold, i. 137). In 1456, the recitation of a few prayers before a church crucifix earned a Pardon of 20,000 years for every such repetition (Glassberger in *Analecta Franciscana*, ii. 368): "and at last Indulgences were so freely given that there is now scarcely a devotion or good work of any kind for which they cannot be obtained" (Arnold & Addis, *Catholic Dictionary*, s.v.). To quote again from Father Thurston (p. 318): "In imitation of the prodigality of her Divine Master, the Church has deliberately faced the risk of depreciation to which her treasure was exposed. . . . The growing effeminacy and corruption of mankind has found her censures unendurable. . . and the Church, going out into the highways and the hedges, has tried to entice men with the offer of generous Indulgence." But it must be noted that, according to the orthodox doctrine, not only can an Indulgence not remit future sins, but even for the past it cannot take full effect unless the

subject be truly contrite and have confessed (or intend shortly to confess) his sins.

This salutary doctrine, however, has undoubtedly been obscured to some extent by the phrase *a poena et a culpa*, which, from the 13th century to the Reformation, was applied to Plenary Indulgences. The prima-facie meaning of the phrase is that the Indulgence itself frees the sinner not only from the temporal penalty (*poena*) but also from the guilt (*culpa*) of all his sins: and the fact that a phrase so misleading remained so long current shows the truth of Father Thurston's remark: "The laity cared little about the analysis of it, but they knew that the *a culpa et poena* was the name for the biggest thing in the nature of an Indulgence which it was possible to get" (*Dublin Review*, Jan. 1900). The phrase, however, was far from being confined to the unlearned. Abbot Gilles li Muisis, for instance, records how, at the Jubilee of 1300, all the Papal Penitentiaries were in doubt about it, and appealed to the Pope. Boniface VIII. did indeed take the occasion of repeating (in the words of his Bull) that confession and contrition were necessary preliminaries; but he neither repudiated the misleading words nor vouchsafed any clear explanation of them. (*Chron. Aegidii li Muisis* ed. de Smet, p. 186.) His predecessor, Celestine V., had actually used them in a Bull.

The phrase exercised the minds of learned canonists all through the middle ages, but still held its ground. The most accepted modern theory is that it is merely a catchword surviving from a longer phrase which proclaimed how, during such Indulgences, ordinary confessors might absolve from sins usually "reserved" to the Bishop or the Pope. Nobody, however, has ventured exactly to reconstitute this hypothetical phrase; nor is the theory easy to reconcile with (i.) the uncertainty of canonists at the time when the locution was quite recent, (ii.) the fact that Clement V. and Cardinal Cusanus speak of absolution *a poena et a culpa* as a separate thing from (a) plenary absolution and (b) absolution from "reserved" sins (Clem. lib. v. tit. ix. c. 2, and Johann Busch (d. c. 1480) *Chron. Windeshemense*, cap. XXXV.). But, however it originated, the phrase undoubtedly contributed to foster popular misconceptions as to the intrinsic value of Indulgences, apart from repentance and confession; though Dr Lea seems to press this point unduly (p. 54 ff.), and should be read in conjunction with Thurston (p. 324 ff.).

These misconceptions were certainly widespread from the 13th to the 16th century, and were often fostered by the "pardoners," or professional collectors of contributions for Indulgences. This can best be shown by a few quotations from eminent and orthodox churchmen during those centuries. Berthold of Regensburg (c. 1270) says, "Fie, penny-preacher! . . . thou dost promise so much remission of sins for a mere halfpenny or penny, that thousands now trust thereto, and fondly dream to have atoned for all their sins with the halfpenny or penny, and thus go to hell" (ed. Pfeiffer, i. 393).<sup>1</sup> A century later, the author of *Piers Plowman* speaks of pardoners who "give pardon for pence poundable about" (i.e. wholesale; B. ii. 222); and his contemporary, Pope Boniface IX., complained of their absolving even impenitent sinners for ridiculously small sums (*pro quilibet parva pecuniarum summula*, Raynaldus, *Ann. Ecc.* 1390). In 1450 Thomas Gascoigne, the great Oxford Chancellor, wrote: "Sinners say nowadays 'I care not how many or how great sins I commit before God, for I shall easily and quickly get plenary remission of any guilt and penalty whatsoever (*cujusdam culpae et poenae*) by absolution and indulgence granted to me from the Pope, whose writing and grant I have bought for 4d. or 6d. or for a game of tennis'" — or sometimes, he adds, by a still more disgraceful bargain (*pro actu meretricio*, Lib. Ver. p. 123, cf. 126). In 1523 the princes of Germany protested to the Pope in language almost equally strong (Browne, *Fasciculus*, i. 354). In 1562 the Council of Trent abolished the office of "pardoner."

The greatest of all Plenary Indulgences is of course the Roman

<sup>1</sup>Equally strong assertions were made by the provincial council of Mainz in 1261; and Lea (p. 287) quotes the complaints of 36 similar church councils before 1538.



Jubilee. This was instituted in 1300 by Boniface VIII., who pleaded a popular tradition for its celebration every hundredth year, though no written evidence could be found. Clement VI. shortened the period to 50 years (1350): it was then further reduced to 33, and again in 1475 to 25 years.

See also the article on LUTHER. The latest and fullest authority on this subject is Dr H. C. Lea, *Hist. of Arctularia Confession and Indulgences in the Latin Church* (Philadelphia, 1896); his standpoint is frankly non-Catholic, but he gives ample materials for judgment. The greatest orthodox authority is Eusebius Amort, *De Origine, &c., indulgentiarum* (1735). More popular and more easily accessible are Father Thurston's *The Holy Year of Jubilee* (1900), and an article by the Bishop of Newport in the *Nineteenth Century* for January 1901, with a reply by Mr Herbert Paul in the next number. (G. G. Co.)

**INDULINES**, a series of dyestuffs of blue, bluish-red or black shades, formed by the interaction of para-amino azo compounds with primary monamines in the presence of a small quantity of a mineral acid. They were first discovered in 1863 (English patent 3307) by J. Dale and H. Caro, and since then have been examined by many chemists (see O. N. Witt, *Ber.*, 1884, 17, p. 74; O. Fischer and E. Hepp, *Aun.*, 1890, 256, pp. 233 et seq.; J. Kehrman, *Ber.*, 1891, 24, pp. 584, 2167 et seq.). They are derivatives of the eorbidines (aminophenazines, aminonaphthophenazines), and by means of their diazo derivatives can be de-amidated, yielding in this way azonium salts; consequently they may be considered as amidated azonium salts. The first reaction giving a clue to their constitution was the isolation of the intermediate *azophenin* by O. Witt (*Jour. Chem. Soc.*, 1883, 43, p. 115), which was proved by Fischer and Hepp to be dianilidoquinone dianil, a similar intermediate compound being found shortly afterwards in the naphthalene series. *Azophenin*,  $C_{16}H_{12}N_4$ , is prepared by warming quinone dianil with aniline; by melting together quinone, aniline and aniline hydrochloride; or by the action of aniline on para-nitrosophenol or para-nitrosodiphenylamine. The indulines are prepared as mentioned above from aminoazo compounds:

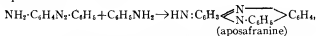

or by condensing oxy- and amido-quinones with phenylated ortho-diamines (J. Kehrman, *Ber.*, 1895, 28, p. 1714):

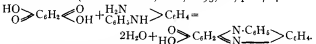

The indulines may be subdivided into the following groups:—  
(1) benzindulines, derivatives of phenazine; (2) isorosindulines; and (3) rosindulines, both derived from naphthophenazine; and (4) naphthindulines, derived from naphthazine.

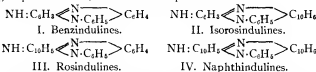

The rosindulines and naphthindulines have a strongly basic character, and their salts possess a marked red colour and fluorescence. *Benzinduline* (aposafranin),  $C_{16}H_{12}N_4$ , is a strong base, but cannot be diazotized, unless it be dissolved in concentrated mineral acids. When warmed with aniline it yields anilido-aposafranin, which may also be obtained by the direct oxidation of ortho-aminodiphenylamine. *Isorosinduline* is obtained from quinone dichloride and phenyl-β-naphthylamine; *rosinduline* from benzene-α-naphthylamine and aniline and *naphthinduline* from benzene-α-naphthylamine and naphthylamine.

**INDULT** (Lat. *indultum*, from *indulgere*, grant, concede, allow), a papal licence which authorizes the doing of something not sanctioned by the common law of the church; thus by an indult the pope authorizes a bishop to grant certain relaxations during the Lenten fast according to the necessities of the situation, climate, &c., of his diocese.

**INDUNA**, a Zulu-Bantu word for an officer or head of a regiment among the Kafir (Zulu-Xosa) tribes of South Africa. It is formed from the inflexional prefix *in* and *duna*, a lord or master. Indunas originally obtained and retained their rank

and authority by personal bravery and skill in war, and often proved a menace to their nominal lord. Where, under British influence, the purely military system of government among the Kafir tribes has broken down or been modified, indunas are now administrators rather than warriors. They sit in a consultative gathering known as an indaba, and discuss the civil and military affairs of their tribe.

**INDUS**, one of the three greatest rivers of northern India.

A considerable accession of exact geographical knowledge has been gained of the upper reaches of the river Indus and its tributaries during those military and political movements which have been so constant on the northern frontiers of India of recent years. The sources of the Indus are to be traced to the glaciers of the great Kailas group of peaks in 32° 20' N. and 81° E., which overlook the Mansarowar lake and the sources of the Brahmaputra, the Sutlej and the Gogra to the south-east. Three great affluents, flowing north-west, unite in about 80° E. to form the main stream, all of them, so far as we know at present, derived from the Kailas glaciers. Of these the northern tributary points the road from Ladakh to the Jhalung goldfields, and the southern, or Gar, forms a link in the great Janglam—the Tibetan trade route—which connects Ladakh with Lhasa and Lhasa with China. Gartok (about 50 m. from the source of this southern head of the Indus) is an important point on this trade route, and is now made accessible to Indian traders by treaty with Tibet and China. At Leh, the Ladakh capital, the river has already pursued an almost even north-westerly course for 300 m., except for a remarkable divergence to the south-west which carries it across, or through, the Ladakh range to follow the same course on the southern side that had been maintained on the north. This very remarkable instance of transverse drainage across a main mountain axis occurs in 79° E., about 100 m. above Leh. For another 230 m., in a north-westerly direction, the Indus pursues a comparatively gentle and placid course over its sandy bed between the giant chains of Ladakh to the north and Zaskar (the main "snowy range" of the Himalaya) to the south, amidst an array of mountain scenery which, for the majesty of sheer altitude, is unmatched by any in the world. Then the river takes up the waters of the Shyok from the north (a tributary nearly as great as itself), having already captured the Zaskar from the south, together with innumerable minor glacier-fed streams. The Shyok is an important feature in Trans-Himalayan hydrography. Rising near the southern foot of the well-known Karakoram pass on the high road between Ladakh and Kashgar, it first drains the southern slopes of the Karakoram range, and then breaks across the axis of the Muztagh chain (of which the Karakoram is now recognized as a subsidiary extension northwards) ere bending north-westwards to run a parallel course to the Indus for 150 m. before its junction with that river. The combined streams still hold on their north-westerly trend for another 100 m., deep hidden under the shadow of a vast array of snow-crowned summits, until they arrive within sight of the Rakapushi peak which pierces the north-western sky midway between Gilgit and Hunza. Here the great change of direction to the south-west occurs, which is thereafter maintained till the Indus reaches the ocean. At this point it receives the Gilgit river from the north-west, having dropped from 15,000 to 4000 ft. (at the junction of the rivers)

after about 500 m. of mountain descent through the independent provinces of northern Kashmir. (See *The Shyok affluent.*) A few miles below the junction it passes Bunji, and from that point to a point beyond Chilas (50 m. below Bunji) it runs within the sphere of British interests. Then once again it resumes its "independent" course through the wild mountains of Kohistan and Hazara, receiving tribute from both sides (the Buner contribution being the most noteworthy) till it emerges into the plains of the Punjab below Darband, in 34° 10' N. All this part of the river has been mapped in more or less detail of late years. The hidden strongholds of those Hindostani fanatics who had found a refuge on its banks since

In the Himalaya.

The Shyok affluent.

The Gilgit affluent.

Mutiny days have been swept clean, and many ancient mysteries have been solved in the course of its surveying.

From its entrance into the plains of India to its disappearance in the Indian Ocean, the Indus of to-day is the Indus of the 'fifties

—modified only in some interesting particulars. It has been bridged at several important points. There are bridges even in its upper mountain courses. This is a wooden pier bridge at Leh of two spans, and there are native suspension bridges of cane or twig-made rope swaying uneasily across the stream at many points intervening between Leh and Bunji; but the first English-made iron suspension bridge is a little above Bunji, linking up the highroad between Kashmir and Gilgit. Next occurs the iron girder railway bridge at Attock, connecting Rawalpindi with Peshawar, at which point the river narrows almost to a gorge, only 900 ft. above sea-level. Twenty miles below Attock the river has carved out a central trough which is believed to be 180 ft. deep. Forty miles below Attock another great bridge has been constructed at Kushalgarh, which carries the railway to Kohat and the Kurram valley. At Mari, beyond the series of gorges which continue from Kushalgarh to the borders of the Kohat district, on the Sind-Sagar line, a boat-bridge leads to Kalabagh (the Salt city) and northwards to Kohat. Another boat-bridge opposite Dera Ismail Khan connects that place with the railway; but there is nothing new in these southern sections of the Indus valley railway system except the extraordinary development of cultivation in their immediate neighbourhood. The Lansdowne bridge at Sukkur, whose huge cantilevers stand up as a monument of British enterprise visible over the flat plains for many miles around, is one of the greatest triumphs of Indian bridge-making. Kotri has recently been connected with Hyderabad in Sind, and the Indus is now one of the best-bridged rivers in India. The intermittent navigation which was maintained by the survivals of the Indus flotilla as far north as Dera Ismail Khan long after the establishment of the railway system has ceased to exist with the dissolution of the fleet, and the high-sterned flat Indus boats once again have the channels and sandbanks of the river all to themselves.

Within the limits of Sind the vagaries of the Indus channels have necessitated a fresh survey of the entire riverain.

The results, however, indicate not so much a marked departure in the general course of the river as a great variation in the channel beds within what may be termed its outside banks. Collaterally much new information has been obtained about the ancient beds of the river, the sites of ancient cities and the extraordinary developments of the Indus delta. The changing channels of the main stream since those prehistoric days when a branch of it found its way to the Rann of Cutch, through successive stages of its gradual shift westwards—a process of displacement which marked the disappearance of many populous places which were more or less dependent on the river for their water supply—to the last and greatest change of all, when the stream burst its way through the limestone ridges of Sukkur and assumed a course which has been fairly constant for 150 years, have all been traced out with systematic care by modern surveyors till the medieval history of the great river has been fully gathered from the characters written on the delta surface. That such changes of river bed and channel should have occurred within a comparatively limited period of time is the less astonishing if we remember that the Indus, like many of the greatest rivers of the world, carries down sufficient detritus to raise its own bed above the general level of the surrounding plains in an appreciable and measurable degree. At the present time the bed of the Indus is stated to be 70 ft. above the plains of the Sind frontier, some 50 m. to the west of it.

The total length of the Indus, measured directly, is about 1500 m. With its many curves and windings it stretches to about 2000 m., the **Statistics**. area of its basin being computed at 372,000 sq. m. Even at its lowest in winter it is 500 ft. wide at Iskardo (near the Gilgit junction) and 9 or 10 ft. deep. The temperature of the surface water during the cold season in the plains is found to be 5° below that of the air (64° and 69° F.). At the beginning of the hot

season, when the river is bringing down snow water, the difference is 14° (87° and 101° June). At greater depths the difference is still greater. At Attock, where the river narrows between rocky banks, a height of 50 ft. in the flood season above lowest level is common with a velocity of 13 m. per hour. The record rise (since British occupation of the Punjab) is 80 ft. At its junction with the Panjnad (the combined rivers of the Punjab east of the Indus) the Panjnad is twice the width of the Indus, but its mean depth is less, and its velocity little more than one-third. This discharge of the Panjnad at low season is 69,000 cubic ft. per second, that of the Indus 92,000. Below the junction the united discharge in flood season is 380,000 cubic ft., rising to 460,000 (the record in August). The Indus after receiving the other rivers carries down into Sind, in the high flood season, turbid water containing silt to the amount of  $\frac{1}{10}$  part by weight, or  $\frac{1}{14}$  by volume—equal to 6480 millions of cubic ft. in the three months of flood. This is rather less than the Ganges carries. The silt is very fine sand and clay. Unusual floods, owing to landslips or other exceptional causes, are not infrequent. The most disastrous flood of this nature occurred in 1858. It was then that the river rose 80 ft. at Attock. The most striking result of the rise was the reversal of the current of the Kabul river, which flowed backwards at the rate of 10 m. per hour, flooding Nowshera and causing immense damage to property. The prosperity of the province of Sind depends almost entirely on the waters of the Indus, as its various systems of canals command over nine million acres out of a cultivable area of twelve and a half million acres.

See MacLagan, *Proceedings R.G.S.*, vol. iii.; Haig, *The Indus Delta Country* (London, 1894); Godwin-Austen, *Proceedings R.G.S.*, vol. vi. (T. H. H.)

**INDUSTRIA** (mod. Monte da Po), an ancient town of Liguria, 20 m. N.E. of Augusta Taurinorum. Its original name was Bodincomagus, from the Ligurian name of the Padus (mod. Po), Bodincus, i.e. bottomless (Plin. *Hist. Nat.* iii. 122), and this still appears on inscriptions of the early imperial period. It stood on the right bank of the river, which has now changed its course over 1 m. to the north. It was a flourishing town, with municipal rights, as excavations (which have brought to light the forum, theatre, baths, &c.) have shown, but appears to have been deserted in the 4th century A.D.

See A. Fabietti in *Atti della Società di Archeologia di Torino*, iii. 17 seq.; Th. Mommsen in *Corp. Inscr.* Lat. v. (Berlin, 1877), p. 845; E. Ferrero in *Notizie degli Scavi* (1903), p. 43.

**INDUSTRIAL SCHOOLS**, in England a school, generally established by voluntary contributions, for the industrial training of children, in which children are lodged, clothed and fed, as well as taught. Industrial schools are chiefly for vagrant and neglected children and children not convicted of theft. Such schools are for children up to the age of fourteen, and the limit of detention is sixteen. They are regulated by the Children Act 1908, which repealed the Industrial Schools Act 1866, as amended by Acts of 1872, 1891 and 1901, and parallel legislation in the various Elementary Education Acts, besides some few local acts. The home secretary exercises powers of supervision, &c. See **JUVENILE OFFENDERS**.

**INDUSTRY** (Lat. *industria*, from *indus-*, a form of the preposition *in*, and either *stare*, to stand, or *struere*, to pile up), the quality of steady application to work, diligence; hence employment in some particular form of productive work, especially of manufacture; or a particular class of productive work itself, a trade or manufacture. See **LABOUR LEGISLATION**, &c.

**INE**, king of the West Saxons, succeeded Ceadwalla in 688, his title to the crown being derived from Ceawin. In the earlier part of his reign he was at war with Kent, but peace was made in 694, when the men of Kent gave compensation for the death of Mul, brother of Ceadwalla, whom they had burned in 687. In 710 Ine was fighting in alliance with his kinsman Nun, probably king of Sussex, against Gerent of West Wales and, according to Florence of Worcester, he was victorious. In 715 he fought a battle with Ceolred, king of Mercia, at Woodborough in Wiltshire, but the result is not recorded. Shortly after this time a quarrel seems to have arisen in the royal family. In 721 Ine slew Cynewulf, and in 722 his queen Athelburg destroyed Taunton, which her husband had built earlier in his reign. In 722 the South Saxons, previously subject to Ine, rose against him under the exile Aldbryht, who may have been a member of the West Saxon royal house. In 725 Ine fought with the South Saxons and slew Aldbryht. In 726 he resigned

the crown and went to Rome, being succeeded by Aethelhard in Wessex. Ine is said to have built the minster at Glastonbury. The date of his death is not recorded. He issued a written code of laws for Wessex, which is still preserved.

See Bede, *Hist. Eccl.* (Plummer), iv. 15, v. 7; *Saxon Chronicle* (Earle and Plummer), s. a. 686, 694, 710, 715, 721, 722, 725, 728; Thorpe, *Ancient Laws*, i. 2-25; Schmid, *Gesetze der Angelsachsen* (Leipzig, 1858); Liebermann, *Gesetze der Angelsachsen* (Halle, 1898-99).

**INEBOLI**, a town on the north coast of Asia Minor, 70 m. W. of Sinth (Sinope). It is the first place of importance touched at by mercantile vessels plying eastwards from Constantinople, being the port for the districts of Changra and Kastamuni, and connected with the latter town by a carriage road (see KASTAMUNI). The roadstead is exposed, having no protection for shipping except a jetty 300 ft. long, so that in rough weather landing is impracticable. The exports (chiefly wool and mohair) are about £248,000 annually and the imports £200,000. The population is about 9000 (Moslems 7000, Christians 2000). Ineboli represents the ancient *Abonou-teichos*, famous as the birthplace of the false prophet Alexander, who established there (2nd century A.D.) an oracle of the snake-God Glycon-Asclepius. This impostor, immortalized by Lucian, obtained leave from the emperor Marcus Aurelius to change the name of the town to *Ionopolis*, whence the modern name is derived (see ALEXANDER THE PAPHLAGONIAN).

**INEBRIETY, LAW OF.** The legal relations to which inebriety (Lat. *in*, intensive, and *ebrietas*, drunkenness) gives rise are partly civil and partly criminal.

I. *Civil Capacity.*—The law of England as to the civil capacity of the drunkard is practically identified with, and has passed through substantially the same stages of development as the law in regard to the civil capacity of a person suffering from mental disease (see INSANITY). Unless (see III. *inf.*) a modification is effected in his condition by the fact that he has been brought under some form of legal control, a man may, in spite of intoxication, enter into a valid marriage or make a valid will, or bind himself by a contract, if he is sober enough to know what he is doing, and no improper advantage of his condition is taken (cf. *Matthew v. Baxter*, 1873, L.R. 8 Ex. 132; *Imperial Loan Co. v. Stone*, 1892, 1 Q.B. 599). The law is the same in Scotland and in Ireland; and the Sale of Goods Act 1893 (which applies to the whole United Kingdom) provides that where necessaries are sold and delivered to a person who by reason of drunkenness is incompetent to contract, he must pay a reasonable price for them; "necessaries" for the purposes of this provision mean goods suitable to the condition in life of such person and to his actual requirements at the time of the sale and delivery.

Under the Roman law, and under the Roman Dutch law as applied in South Africa, drunkenness, like insanity, appears to vitiate absolutely a contract made by a person under its influence (*Molyneux v. Natal Land and Colonization Co.*, 1905, A.C. 555).

In the United States, as in England, intoxication does not vitiate contractual capacity unless it is of such a degree as to prevent the person labouring under it from understanding the nature of the transaction into which he is entering (*Bouvier, Law Dict.*, s.v. "Drunkenness"; and cf. *Waldron v. Anglemann*, 1004, 58 Atl. 568; *Fowler v. Meadow Brook Water Co.*, 1904, 57 Atl. 950; 208 Penn., 473). The same rule is by implication adopted in the Indian Contract Act (Act ix. of 1872), which provides (s. 12) that "a person is . . . of sound mind for the purpose of making a contract if, at the time when he makes it, he is capable of understanding it and of forming a rational judgment as to its effect upon his interests." In some legal systems, however, habitual drunkenness is a ground for divorce or judicial separation (Sweden, Law of the 27th of April 1810; France, Code Civil, Art. 231, *Hirt v. Hirt*, Dalloz, 1898, pt. ii., p. 4, and n. 4).

II. *Criminal Responsibility.*—In English law, drunkenness, unlike insanity, was at one time regarded as in no way an excuse for crime. According to Coke (*Co. Litt.*, 247) a drunkard, although he suffers from acquired insanity, *dementia affectata*,

is *voluntarius daemon*, and therefore has no privilege in consequence of his state; "but what hurt or ill soever he doth, his drunkenness doth aggravate it." Sir Matthew Hale (P.C. 32) took a more moderate view, viz. that a person under the influence of this voluntarily contracted madness "shall have the same judgment as if he were in his right senses"; and admitted the existence of two "alloys" or qualifying circumstances: (1) *temporary frenzy* induced by the unskillfulness of physicians or by drugging; and (2) *habitual* or fixed frenzy. Those early authorities have, however, undergone considerable development and modification.

Although the general principle that drunkenness is not an excuse for crime is still steadily maintained (see Russell, *Crim. Law*, 6th ed., i. 144; Archbold, *Cr. Pl.*, 23rd ed., p. 29), it is settled law that where a particular intent is one of the constituent elements of an offence, the fact that a prisoner was intoxicated at the time of its commission is relevant evidence to show that he had not the capacity to form that intent. Drunkenness is also a circumstance of which a jury may take account in considering whether an act was premeditated, or whether a prisoner acted in self-defence or under provocation, when the question is whether the danger apprehended or the provocation was sufficient to justify his conduct or to alter its legal character. Moreover, *delirium tremens*, if it produce such a degree of madness as to render a person incapable of distinguishing right from wrong, relieves him from criminal responsibility for any act committed by him while under its influence; and in one case at *nisi prius* (*R. v. Baines*, *The Times*, 25th Jan. 1886) this doctrine was extended by Mr Justice Day to temporary derangement occasioned by drink. The law of Scotland accepts, if it does not go somewhat beyond, the later developments of that of England in regard to criminal responsibility in drunkenness. Indian law on the point is similar to the English (Indian Penal Code, Act. xiv. of 1860, ss. 85, 86; Mayne, *Crim. Law of India*, ed. 1896, p. 391). In the United States the same view is the prevalent legal doctrine (see Bishop, *Crim. Law*, 8th ed., i. ss. 307-416). The Criminal Code of Queensland (No. 9 of 1899, Art. 28) provides that a person who becomes intoxicated intentionally is responsible for any crime that he commits while so intoxicated, whether his voluntary intoxication was induced so as to afford an excuse for the commission of an offence or not. As in England, however, when an intention to cause a specific result is an element of an offence, intoxication, whether complete or partial, and whether intentional or unintentional, may be regarded for the purpose of ascertaining whether such intention existed or not. There is a similar provision in the Penal Code of Ceylon (No. 2 of 1883, Art. 79). The Criminal Codes of Canada (1892, c. 29, ss. 7 et seq.) and New Zealand (No. 56 of 1893, ss. 21 et seq.) are silent on the subject of intoxication as an excuse for crime. The Criminal Code of Grenada (No. 2 of 1897, Art. 51) provides that "a person shall not, on the ground of intoxication, be deemed to have done any act involuntarily, or be exempt from any liability to punishment for any act; and a person who does an act while in a state of intoxication shall be deemed to have intended the natural and probable consequences of his act." There is a similar provision in the Criminal Code of the Gold Coast Colony (No. 12 of 1892, s. 54). Under the French Penal Code (Art. 64), *il n'y a ni crime, ni délit, lorsque le prévenu était en état de démence au temps de l'action ou lorsqu'il aura été contraint par une force à laquelle il n'a pu résister.*" According to the balance of authority (Dalloz, *Rép. tit.*, Peine, ss. 402 et seq.) intoxication is not assimilated to insanity, within the meaning of this article, but it may be and is taken account of by juries as an extenuating circumstance (Ortolan, *Droit Pénal* i. s. 323; Chauveau et Hélie i. s. 366). A provision in the German Penal Code (Art. 51) that an act is not punishable if its author, at the time of committing it, was in a condition of unconsciousness, or morbid disturbance of the activity of his mind which prevented the free exercise of his will, has been held not to extend to intoxication (Clunet, 1883, p. 311). But in Germany as in France, intoxication may apparently be an extenuating circumstance.

Under the Italian Penal Code (Arts. 46-49) intoxication—unless voluntarily induced so as to afford an excuse for crime—may exclude or modify responsibility.

So far only the question whether drunkenness is an excuse for offences committed under its influence has been dealt with. There remains the question how far drunkenness itself is a crime. Mere private intoxication is not, either in England or in the United States (Bishop, *Crim. Law*, 8th ed., i. s. 399) indictable as an offence at common law; but in all civilized countries public drunkenness is punishable when it amounts to a breach of the peace (see LIQUOR LAWS) or contravention of public order; and modern legislation in many countries provides for deprivation of personal liberty for long periods in case of a frequent repetition of the offence. Reference may be made in this connexion to the Inebriates Acts 1898, 1899 and 1900 (see iii. *inf.*), and also to similar legislation in the British colonies and in foreign legal systems (e.g. Cape of Good Hope, No. 32 of 1896; Ceylon, Licensing Ordinance 1891, ss. 23, 24, 29; New South Wales, Vagrants Punishment Act 1866; Massachusetts, Acts of 1891, c. 427, 1893, cc. 414, 44; France, Law of 23rd of Jan. 1873, Art. 6).

III. *State Action in Regard to Inebriety.*—This assumes a variety of forms. (a) Measures regulating the punishment of occasional or habitual drunkenness by fines or short terms of imprisonment. (b) Control in *penal* establishments for lengthened periods. (c) Laws prohibiting the sale of liquor to persons who are known inebriates: e.g. in England (Licensing Act 1902); Ontario (Rev. Stats. 1897, c. 245, ss. 124, 125); New South Wales (Liquor Act 1898, ss. 52, 53); Cape of Good Hope (No. 28 of 1883, s. 89); New York (Rev. Stats. 1880-1892, c. 20, Title iv.); California (Act to prevent sale of liquor to drunkards, 1889); Massachusetts (Pub. Stats., ed. 1902, c. 100, s. 9). (d) Laws regulating the appointment of some person or persons to act as guardian or guardians, or who may be endowed with legal powers over the person and estate of an inebriate. Thus in France (Code Civil, Arts. 489 et seq.), Germany (Civil Code, Art. 6 (30)) and Austria-Hungary (*Bürgerliches Gesetzbuch*, ss. 21, 269, 270, 273), an inebriate may be judicially interdicted if he is squandering his property and thereby exposing his family to future destitution. Provision is also made for the interdiction of inebriates by the laws of Nova Scotia (Rev. Stats. 1900, c. 126, s. 2), Manitoba (Rev. Stat. 1902, c. 103, ss. 30 et seq.), British Columbia (Rev. Stat. 1897, c. 66), New South Wales (Inebriates Act 1900, s. 5), Tasmania (Inebriates Act 1885, No. 17, s. 23); Canton of Bâle (Trustee Law of the 23rd of Feb. 1880, s. 11), Orange River Colony (Code Laws, c. 108, s. 30), Maryland (Code General Laws, c. 474, s. 47). (e) Control for the purpose of reformation. Legislation of this character provides reformatory treatment: (1) for the inebriate who makes a voluntary application for admission; (2) by compulsory seclusion for the inebriate who refuses consent to treatment and yet manages to keep out of the reach of the law; (3) for the inebriate who is a police-court recidivist, or who has committed crime, caused or contributed to by drink. The legislation of the Cape of Good Hope (Inebriates Act 1896) and of North Dakota (Habitual Drunkards Act 1895) provides for the first of these methods of treatment alone. Compulsory detention for ordinary inebriates only is provided for by the laws of Delaware (Act of 1898), Massachusetts (Rev. Laws, c. 87), and of the Cantons of Berne (Law of the 24th of Nov. 1883) and Bâle (Law of the 21st of Feb. 1901). All three methods of treatment are in force in New South Wales (Inebriates Act 1900), Queensland (Inebriates Institutions Act 1896) and South Australia (Inebriates Act 1881). Provision is made only for voluntary application and compulsory detention of ordinary inebriates in Victoria (Inebriates Act 1890), Tasmania (Inebriates Act 1885; Inebriates Hospitals Act 1892) and New Zealand (Inebriates Institutions Act 1898). The legislation of the United Kingdom (Inebriates Acts 1870-1900) deals both with voluntary application and with the committal of criminal inebriates or of police-court recidivists. A brief sketch of the English system must suffice.

The Inebriates Acts of 1870-1900 deal in the first place with non-criminal, and in the second place with criminal, habitual drunkards.

For the purposes of the acts the term "habitual drunkard" means "a person who, not being amenable to any jurisdiction in lunacy, is notwithstanding, by reason of habitual intemperate drinking of intoxicating liquor, at times dangerous to himself or herself, or incapable of managing himself or herself and his or her affairs." A person would become amenable to the lunacy jurisdiction not only where habitual drunkenness made him a "lunatic" in the legal sense of the term, but where it created such a state of disease and consequential "mental infirmity" as to bring his case within section 116 of the Lunacy Act 1890, the effect of which is explained in the article INSANITY. Any "habitual drunkard" within the above definition may obtain admission to a "licensed retreat" on a written application to the licensee, stating the time (the maximum period is two years) that he undertakes to remain in the retreat. The application must be accompanied by the statutory declaration of two persons that the applicant is an habitual drunkard, and its signature must be attested by a justice of the peace who has satisfied himself as to the fact, and who is required to state that the applicant understood the nature and effect of his application. Licences (each of which is subject to a duty and is impressed with a stamp of £5, and 10s. for every patient above ten in number) are granted for retreats by the borough council and the town clerk in boroughs, and elsewhere by the county council and the clerk of the county council. The maximum period for which a licence may be granted is two years, but licences may be renewed by the licensing authority on payment of a stamp duty of the same amount as on the original grant. When an habitual drunkard has once been committed to a retreat, he must remain in the retreat for the time that he has fixed in his application, subject to certain statutory provisions similar to those prescribed by the Lunacy Acts for asylums as to leave of absence and discharge; and he may be retaken and brought back to the retreat under a justice's warrant. The term of detention may be extended on its expiry, or an inebriate may be readmitted, on a fresh application, without any statutory declaration, and without the attesting justice being required to satisfy himself that the applicant is an habitual drunkard. Licensed retreats are subject to inspection by an Inspector of Retreats appointed by the Home Secretary, to whom he makes an annual report. The Home Secretary is empowered to make rules and regulations for the management of retreats, and "regulations and orders," not inconsistent with such rules, are to be prepared by the licensee within a month after the granting of his licence, and submitted to the inspector for approval. The rules now in force are dated as regards (a) England, 28th Feb. 1902; (b) Scotland, 14th April 1902; (c) Ireland, 3rd Feb. 1903. There are also statutory provisions, similar to those of the Lunacy Acts, as to offences—(i.) by licensees failing to comply with the requirements of the acts; (ii.) by persons ill-treating patients, or helping them to escape, or unlawfully supplying them with intoxicating liquor; (iii.) by patients refusing to comply with the rules. The Home Secretary may (i.) authorize the establishment of "State Inebriate Reformatories," to be paid for out of moneys provided by parliament; and (ii.) sanction "Certified Inebriates' Reformatories" on the application of any borough or county council, or any person whatever, if satisfied concerning the reformatory and the persons proposing to maintain it. An Inspector of Certified Inebriate Reformatories has been appointed. Regulations for State Inebriate Reformatories and for Certified Inebriate Reformatories have been made, dated as follows: *State Inebriate Reformatories*—England, 21st of June 1901, 20th of Dec. 1903, 20th of April 1904; Scotland, 9th of March 1900; Ireland, 16th of March 1899, 16th of April 1901, 10th of Feb. 1904. *Certified Inebriate Reformatories*—England, Model Regulations, 17th of Dec. 1898; Scotland, Regulations, 14th of Feb. 1899; Ireland, Model Regulations, 29th of April 1899.

Any person convicted on indictment of an offence punishable with imprisonment or penal servitude (*i.e.* of any non-capital

felony and of most misdemeanours), if the court is satisfied from the evidence that the offence was committed under the influence of drink, or that drink was a contributing cause of the offence, may, if he admits that he is, or is found by the jury to be, an habitual drunkard, in addition to or in substitution for any other sentence, be ordered to be detained in a state or certified inebriate reformatory, the managers of which are willing to receive him. Again, any habitual drunkard who is found drunk in any public place, or who commits any other of a series of similar offences under various statutes, after having within twelve months been convicted at least three times of a similar offence, may, on conviction on indictment, or, if he consent, on summary conviction, be sent for detention in any certified inebriate reformatory. The expenses of prosecuting habitual drunkards under the above provisions are payable out of the local rates upon an order to that effect by the judge of assize or chairman of quarter-sessions if the prosecution be on indictment, or by a court of summary jurisdiction if the offence is dealt with summarily.

**AUTHORITIES.**—As to the history of legislation on the subject see Parl. Paper No. 242 of 1872; 1893 C. 7008. See also Wyatt Paine, *Inebriate Reformatories and Retreats* (London, 1899); Blackwell, *Inebriates Acts, 1879-1898* (London, 1899); Wood Renton, *Lunacy* (London and Edinburgh, 1896); Kerr, *Inebriety* (3rd ed., London, 1894). An excellent account of the systems in force in other countries for the treatment of inebriates will be found in Parl. Pap. (1902), cd. 1474.

**INFALLIBILITY** (Fr. *infaillibilité* and *infallibilità*, the latter now obsolete, Med. Lat. *infallibilitas*, *infallibilis*, formed from *faktor*, to make a mistake), the fact or quality of not being liable to err or fail. The word has thus the general sense of "certainty"; we may, e.g., speak of a drug as an infallible specific, or of a man's judgment as infallible. In these cases, however, the "infallibility" connotes certainty only in so far as anything human can be certain. In the language of the Christian Church the word "infallibility" is used in a more absolute sense, as the freedom from all possibility of error guaranteed by the direct action of the Spirit of God. This belief in the infallibility of revelation is involved in the very belief in revelation itself, and is common to all sections of Christians, who differ mainly as to the kind and measure of infallibility residing in the human instruments by which this revelation is interpreted to the world. Some see the guarantee, or at least the indication, of infallibility in the consensus of the Church (*quod semper, ubique, et ab omnibus*) expressed from time to time in general councils; others see it in the special grace conferred upon St Peter and his successors, the bishops of Rome, as heads of the Church; others again see it in the inspired Scriptures, God's Word. This last was the belief of the Protestant Reformers, for whom the Bible was in matters of doctrine the ultimate court of appeal. To the translation and interpretation of the Scriptures men might bring a fallible judgment, but this would be assisted by the direct action of the Spirit of God in proportion to their faith. As for infallibility, this was a direct grace of God, given only to the few. "What ever was perfect under the sun," ask the translators of the Authorized Version (1611) in their preface, "where apostles and apostolical men, that is, men endued with an extraordinary measure of God's Spirit, and privileged with the privilege of infallibility, had not their hand?" In modern Protestantism, on the other hand, the idea of an infallible authority whether in the Church or the Bible has tended to disappear, religious truths being conceived as valuable only as they are apprehended and made real to the individual mind and soul by the grace of God, not by reason of any submission to an external authority. (See also **INSPIRATION**.)

At the present time, then, the idea of infallibility in religious matters is most commonly associated with the claim of the Roman Catholic Church, and more especially of the pope personally as head of that Church, to possess the privilege of infallibility, and it is with the meaning and limits of this claim that the present article deals.

The substance of the claim to infallibility made by the Roman Catholic Church is that the Church and the pope cannot err

when solemnly enunciating, as binding on all the faithful, a decision on a question of faith or morals. The infallibility of the Church, thus limited, is a necessary outcome of the fundamental conception of the Catholic Church and its mission. Every society of men must have a supreme authority, whether individual or collective, empowered to give a final decision in the controversies which concern it. A community whose mission it is to teach religious truth, which involves on the part of its members the obligation of belief in this truth, must, if it is not to fail of its object, possess an authority capable of maintaining the faith in its purity, and consequently capable of keeping it free from and condemning errors. To perform this function without fear of error, this authority must be infallible in its own sphere. The Christian Church has expressly claimed this infallibility for its formal dogmatic teaching. In the very earliest centuries we find the episcopate, united in council, drawing up symbols of faith, which every believer was bound to accept under pain of exclusion, condemning heresies, and casting out heretics. From Nicaea and Chalcedon to Florence and Trent, and to the present day, the Church has excluded from her communion all those who do not profess her own faith, i.e. all the religious truths which she represents and imposes as obligatory. This is infallibility put into practice by definite acts.

The infallibility of the pope was not defined until 1870 at the Vatican Council; this definition does not constitute, strictly speaking, a dogmatic innovation, as if the pope had not hitherto enjoyed this privilege, or as if the Church, as a whole, had admitted the contrary; it is the newly formulated definition of a dogma which, like all those defined by the Councils, continued to grow into an ever more definite form, ripening, as it were, in the always living community of the Church. The exact formula for the papal infallibility is given by the Vatican Council in the following terms (Constit. *Pastor aeternus*, cap. iv.): "we teach and define as a divinely revealed dogma, that the Roman Pontiff, when he speaks *ex cathedra*—i.e. when, in his character as Pastor and Doctor of all Christians, and in virtue of his supreme apostolic authority, he lays down that a certain doctrine concerning faith or morals is binding upon the universal Church,—possesses, by the Divine assistance which was promised to him in the person of the blessed Saint Peter, that same infallibility with which the Divine Redeemer thought fit to endow His Church, to define its doctrine with regard to faith and morals; and, consequently, that these definitions of the Roman Pontiff are irrevocable in themselves, and not in consequence of the consent of the Church." A few notes will suffice to elucidate this pronouncement.

(a) As the Council expressly says, the infallibility of the pope is not other than that of the Church; this is a point which is too often forgotten or misunderstood. The pope enjoys it in person, but solely *qua* head of the Church, and as the authorized organ of the ecclesiastical body. For this exercise of the primacy as for the others, we must conceive of the pope and the episcopate united to him as a continuation of the Apostolic College and its head Peter. The head of the College possesses and exercises by himself alone the same powers as the College which is united with him; not by delegation from his colleagues, but because he is their established chief. The pope when teaching *ex cathedra* acts as head of the whole episcopal body and of the whole Church.

(b) If the Divine constitution of the Church has not changed in its essential points since our Lord, the mode of exercise of the various powers of its head has varied; and that of the supreme teaching power as of the others. This explains the late date at which the dogma was defined, and the assertion that the dogma was already contained in that of the papal primacy established by our Lord himself in the person of St Peter. A certain dogmatic development is not denied, nor an evolution in the direction of a centralization in the hands of the pope of the exercise of his powers as primate; it is merely required that this evolution should be well understood and considered as legitimate.

(c) As a matter of fact the infallibility of the pope, when giving decisions in his character as head of the Church, was generally admitted before the Vatican Council. The only reservation which the most advanced Gallicans dared to formulate, in the terms of the celebrated declaration of the clergy of France (1682), had as its object the irrefragable character of the pontifical definitions, which, it was claimed, could only have been acquired by them through the assent of the Church. This doctrine, rather political than theological, was a survival of the errors which had come into being after the Great Schism, and especially at the council of Constance; its object was to put the Church above its head, as the council of Constance had put the ecumenical council above the pope, as though the council could be ecumenical without its head. In reality it was Gallicanism alone which was condemned at the Vatican Council, and it is Gallicanism which is aimed at in the last phrase of the definition we have quoted.

(d) Infallibility is the guarantee against error, not in all matters, but only in the matter of dogma and morality; everything else is beyond its power, not only truths of another order, but even discipline and the ecclesiastical laws, government and administration, &c.

(e) Again, not all dogmatic teachings of the pope are under the guarantee of infallibility; neither his opinions as private instructor, nor his official allocutions, however authoritative they may be, are infallible; it is only his *ex cathedra* instruction which is guaranteed; this is admitted by everybody.

But when does the pope speak *ex cathedra*, and how is it to be distinguished when he is exercising his infallibility? As to this point there are two schools, or rather two tendencies, among Catholics: some extend the privilege of infallibility to all official exercise of the supreme *magisterium*, and declare infallible, e.g. the papal encyclicals.<sup>1</sup> Others, while recognizing the supreme authority of the papal *magisterium* in matters of doctrine, confine the infallibility to those cases alone in which the pope chooses to make use of it, and declares positively that he is imposing on all the faithful the obligation of belief in a certain definite proposition, under pain of heresy and exclusion from the Church; they do not insist on any special form, but only require that the pope should clearly manifest his will to the Church. This second point of view, as clearly expounded by Mgr Joseph Fessler (1813-1872), bishop of St Pölten, who was secretary to the Vatican Council, in his work *Die wahre und die falsche Unfehlbarkeit der Päpste* (French trans. *La vraie et la fausse infallibilité*, Paris, 1873), and by Cardinal Newman in his "Letter to the Duke of Norfolk," is the correct one, and this is clear from the fact that it has never been blamed by the ecclesiastical authority. Those who hold the latter opinion have been able to assert that since the Vatican Council no infallible definition had yet been formulated by the popes, while recognizing the supreme authority of the encyclicals of Leo XIII.

It is remarkable that the definition of the infallibility of the pope did not appear among the projects (*schemata*) prepared for the deliberations of the Vatican Council (1869). It doubtless arose from the proposed forms for the definitions of the primacy and the pontifical *magisterium*. The chapter on the infallibility was only added at the request of the bishops and after long hesitation on the part of the cardinal presidents. The proposed form, first elaborated in the conciliary commission *de fide*, was the object of long public discussions from the 50th general congregation (May 13th, 1870) to the 85th (July 13th); the constitution as a whole was adopted at a public session, on the 18th, of the 535 bishops present, two only replied "*Non placet*"; but about 50 had preferred not to be present. The controversies

occasioned by this question had started from the very beginning of the Council, and were carried on with great bitterness on both sides. The minority, among whom were prominent Cardinals Rauscher and Schwarzenberg, Hefele, bishop of Rotterdam (the historian of the councils) Cardinal Mathieu, Mgr Dupanloup, Mgr Maret, &c., &c., did not pretend to deny the papal infallibility; they pleaded the inopportunities of the definition and brought forward difficulties mainly of an historical order, in particular the famous condemnation of Pope Honorius by the 6th ecumenical council of Constantinople in 680. The majority, in which Cardinal Manning played a very active part, took their stand on theological reasons of the strongest kind; they invoked the promises of Our Lord to St Peter: "Thou art Peter, and upon this rock will I build my Church, and the gates of hell shall not prevail against her"; and again, "I have prayed for thee, Peter, that thy faith fail not; and do thou in thy turn confirm thy brethren"; they showed the popes, in the course of the ages, acting as the guardians and judges of the faith, arousing or welcoming dogmatic controversies and authoritatively settling them, exercising the supreme direction in the councils and sanctioning their decisions; they explained that the few historical difficulties did not involve any dogmatic defect in the teaching of the popes; they insisted upon the necessity of a supreme tribunal giving judgment in the name of the whole of the scattered Church; and finally, they considered that the definition had become opportune for the very reason that under the pretext of its inopportunities the doctrine itself was being attacked.

The definition once proclaimed, controversies rapidly ceased; the bishops who were among the minority one after the other formulated their loyal adhesion to the Catholic dogma. The last to do so in Germany was Hefele, who published the decrees of the 10th of April 1871, thus breaking a long friendship with Döllinger; in Austria, where the government had thought good to revive for the occasion the royal *placet*, Mgr Haynald and Mgr Strossmayer delayed the publication, the former till the 15th of September 1871, the latter till the 26th of December 1872. In France the adhesion was rapid, and the publication was only delayed by some bishops in consequence of the disastrous war with Prussia. Though no bishops abandoned it, a few priests, such as Father Hyacinthe Loyson, and a few scholars at the German universities refused their adhesion. The most distinguished among the latter was Döllinger, who resisted all the advances of Mgr Scherr, archbishop of Munich, who was excommunicated on the 17th of April 1871, and died un-reconciled, though without joining any separate group. After him must be mentioned Friedrich of Munich, several professors of Bonn, and Reinkens of Breslau, who was the first bishop of the "Old Catholics." These professors formed the "Committee of Bonn," which organized the new Church. It was recognized and protected first in Bavaria, thanks to the minister Freiherr Johann von Lutz, then in Saxony, Baden, Württemberg, Prussia, where it was the pretext for, if not the cause of, the Kulturkampf, and finally in Switzerland, especially at Geneva.

For the theological aspects of the dogma of infallibility, see, among many others, L. Billot, S.J., *De Ecclesia Christi* (3 vols., Rome, 1898-1900); or G. Wilmers, S.J., *De Christi Ecclesia* (Regensburg, 1897). The most accessible popular work is that of Mgr Fessler already mentioned. For the history of the definition see VATICAN COUNCIL; also PAPACY, GALLICANISM, FEBRONIANISM, OLD CATHOLICS, &c.

(A. Bo.)\*

**INFAMY** (Lat. *infamia*), public disgrace or loss of character. Infamy (*infamia*) occupied a prominent place in Roman law, and took the form of a censure on individuals pronounced by a competent authority in the state, which censure was the result either of certain actions which they had committed or of certain modes of life which they had pursued. Such a censure involved disqualification for certain rights both in public and in private law (see A. H. J. Greenidge, *Infamia, its Place in Roman Public and Private Law*, 1894). In English law infamy attached to a person in consequence of conviction of some crime. The effect of infamy was to render a person incompetent to give evidence

<sup>1</sup> It was in this sense that it was understood by Döllinger, who pointed out that the definition of the dogma would commit the Church to all past official utterances of the popes, e.g. the Syllabus of 1864, and therefore to a war *à outrance* against modern civilization. This view was embodied in the circular note to the Powers, drawn up by Döllinger and issued by the Bavarian prime minister Prince Hohenzollern-Schillingfürst on April 9, 1869. It was also the view universally taken by the German governments which supported the *Kulturkampf* in a greater or less degree.—E.D.

in any legal proceeding. Infamy as a cause of incompetency was abolished by an act of 1843 (6 & 7 Vict. c. 85).

The word "infamous" is used in a particular sense in the English Medical Act of 1858, which provides that if any registered medical practitioner is judged by the General Medical Council, after due inquiry, to have been guilty of infamous conduct in any professional respect, his name may be erased from the Medical Register. The General Medical Council are the sole judges of whether a practitioner has been guilty of conduct infamous in a professional respect, and they act in a judicial capacity, but an accused person is generally allowed to appear by counsel. Any action which is regarded as disgraceful or dishonourable by a man's professional brethren—such, for example, as issuing advertisements in order to induce people to consult him in preference to other practitioners—may be found infamous.

**INFANCY**, in medical practice, the nursing age, or the period during which the child is at the breast. As a matter of convenience it is usual to include in it children up to the age of one year. The care of an infant begins with the preparations necessary for its birth and the endeavour to ensure that taking place under the best possible sanitary conditions. On being born the normal infant cries lustily, drawing air into its lungs. As soon as the umbilical cord which unites the child to the mother has ceased to pulsate, it is tied about 2 in. from the child's navel and is divided above the ligature. The cord is wrapped in a sterilized gauze pad and the dressing is not removed until the seventh to the tenth day, when the umbilicus is healed.

The baby is now a separate entity, and the first event in its life is the first bath. The room ready to receive a new-born infant should be kept at a temperature of 70° F. The temperature of the first bath should be 100° F. The child should be well supported in the bath by the left hand of the nurse, and care should be taken to avoid wetting the gauze pad covering the cord. In some cases infants are covered with a white substance termed "vernix caseosa," which may be carefully removed by a little olive oil. Sponges should never be used, as they tend to harbour bacteria. A soft pad of muslin or gauze which can be boiled should take its place. After the first ten days 94° F. is the most suitable temperature for a bath. When the baby has been well dried the skin may be dusted with pure starch powder to which a small quantity of boric acid has been added. The most important part of the toilet of a new-born infant is the care of the eyes, which should be carefully cleansed with gauze dipped in warm water and one drop of a 2% solution of nitrate of silver dropped into each eye. The clothes of a newly born child should consist exclusively of woollen undergarments, a soft flannel binder, which should be tied on, being placed next the skin, with a long-sleeved woven wool vest and over this a loose garment of flannel coming below the feet and long enough to tuck up. Diapers should be made of soft absorbent material such as well-washed linen and should be about two yards square and folded in a three-cornered shape. An infant should always sleep in a bed or cot by itself. In 1907, of 749 deaths from violence in England and Wales of children under one month, 445 were due to suffocation in bed with adults. A healthy infant should spend most of its time asleep and should be laid into its cot immediately after feeding.

The normal infant at birth weighs about 7 lb. During the two or three days following birth a slight decrease in weight occurs, usually 5 to 6 oz. When nursing begins the child increases in weight up to the seventh day, when the infant will have regained its weight at birth. From the second to the fourth week after birth (according to Camerer) an infant should gain 1 oz. daily or  $\frac{1}{2}$  to 2 lb monthly, from the fourth to the sixth month  $\frac{1}{2}$  to  $\frac{3}{4}$  of an oz. daily or 1 lb monthly, from the sixth to the twelfth month  $\frac{1}{2}$  oz. daily or less than 1 lb monthly. At the sixth month it should be twice the weight at birth. The average weight at the twelfth month is 20 to 21 lb. The increase of weight in artificially fed is less regular than in breast-fed babies.

**Food**—There is but one proper food for an infant, and that is its mother's milk, unless when in exceptional circumstances

the mother is not allowed to nurse her child. Artificially fed children are much more liable to epidemic diseases. The child should be applied to the breast the first day to induce the flow of milk. The first week the child should be fed at intervals of two hours, the second week eight to nine times, and the fourth week eight times at intervals of two and a half hours. At two months the child is being suckled six times daily at intervals of three hours, the last feed being at 11 P.M. Where a mother cannot nurse a child the child must be artificially fed. Cow's milk must be largely diluted to suit the new-born infant. Armstrong gives the following table of dilution:—

1st week,	milk 1 tablespoonful,	water 2 tablespoonfuls	
at 3 months,	" 3 $\frac{1}{2}$ tablespoonfuls,	" 3 "	added
at 6 months,	" 9 "	" 3 "	with
at 9 months,	" 12 "	" 3 "	sugar.

Koplik has drawn out a table of the amounts to be given as follows:—

1st day	3 feeds of 10 cc	total 1 oz. in 24 hours
2nd day	8 " 20 cc	" 5 $\frac{1}{2}$ "
3rd day	8 " 30 cc (1 oz.)	" 8 "
7th day	9 " 50 cc	" 13 $\frac{1}{2}$ "
4th week	8 " 60 cc (2 oz.)	" 16 "
3 months	7 " 4 oz.	" 28 "
6 months	6 " 7 oz.	" 42 "
9 months	6 " 8 $\frac{1}{2}$ oz.	" 50 "

In cities it is advisable that milk should be either sterilized by boiling or pasteurized, i.e. subjected to a form of heating which, while destroying pathogenic bacteria, does not alter the taste. The milk in a suitable apparatus is subjected to a temperature of 65° C. (149° F.) for half an hour and is then rapidly cooled to 20° C. (68° F.). Children fed on pasteurized milk should be given a teaspoonful of fresh orange juice daily to supply the missing acid and salts.

Artificial feeding is given by means of a bottle. In France all bottles with rubber tubes have been made illegal. They are a fruitful source of infection, as it is impossible to keep them clean. The best bottle is the boat-shaped one, with a wide mouth at one end, to which is attached a rubber teat, while the other end has a screw stopper. This is readily cleaned and a stream of water can be made to flow through it. All bottle teats should be boiled at least once a day for ten minutes with soda and kept in a glass-covered jar until required. A feed should be given at the temperature of 100° F.

At the ninth month a cereal may be added to the food. Before that the infant is unable to digest starchy foods. Much starch tends to constipation, and it is rarely wise to give starchy preparations in a proportion of more than 5% to children under a year old. A child who is carefully fed in a cleanly manner should not have diarrhoea, and its appearance indicates carelessness somewhere. The English registrar-general's returns for 1906 show that in the seventy-six largest towns in England and Wales 14,306 deaths of infants under one year from diarrhoea took place in July, August and September alone. These deaths are largely preventable; when Dr Budin of Paris established his "Consultations de Nourissons" the infant mortality of Paris amounted to 178 per 1000, but at the consultation the rate was 46 per 1000. At Varenneville-sur-mer a consultation for nurslings was instituted under Dr Poupalt of Dieppe in 1904. During the seven previous years the infant mortality had averaged 145 per 1000. In 1904-1905 not one infant at the consultation died, though it was a summer of extreme heat, and in 1898 when similar heat had prevailed the infant mortality was 285 per 1000. The deaths of infants under one year in England and Wales, taken from the registrar-general's returns for 1907, amounted to 117.62 per 1000 births, an alarming sacrifice of life. France has been turning her attention to the establishment of infant consultations on the lines of Dr Budin's, and similar dispensaries under the designation "Gouttes de lait" have been widely established in that country; gratifying results in the fall in infant mortality have followed. At the Fécamp dispensary the mortality from diarrhoea has fallen to 2.8, while that in neighbouring towns is from 50 to 76 per 1000 (Sir A. Simpson). It has been left to private enterprise in England to deal with this problem. The St Pancras "School for Mothers" was

established in 1907 in north-west London. Though started by private persons it was in 1909 worked in connexion with the Health Department of the Borough Council, but was supported by charitable subscriptions and by a small contribution from the student mothers. There are classes for mothers on the care of their health during pregnancy, infant feeding, home nursing, cooking and needlework. Poor mothers unable to contribute get free dinners for three months previous to the birth of their child and for nine months after if the child is breast-fed. Two doctors are in attendance, and mothers are encouraged to bring their children fortnightly to be weighed, and receive advice. The average attendance is ninety. A baby is said to have "graduated" when it is a year old. An interesting development in connexion with the scheme is a class for fathers at which the medical officer of health for the district lectures on the duties of fatherhood. Similar schools for mothers are now established in Fulham and Stepney. Weighing centres have been established at Dundee, Sheffield, Nottingham, Birmingham, Aberdeen, Bolton, Belfast, and Newcastle-on-Tyne. An infants' milk depot has been established at Finsbury, and effort is being made to establish milk laboratories where separate nursing portions of sterile milk could be supplied to poor mothers. The Walker-Gordon milk laboratories in the United States are a step in this direction.

The average length of a child at birth is 19½ in. and during the first year the average increase is 7½ in. A new-born infant is deaf (Koplik). This is supposed to be due to the blocking of the eustachian tubes with mucus. On the fourth day there is some evidence of hearing, and at the fifth week noises in the room disturb it. A healthy infant may be taken out of doors when a fortnight old in summer, after which it should have a daily outing, the eyes being protected from the direct rays of the sun. On the second day the eyes are sensitive to light, in the second month the infant notices colours, at the sixth month it knows its parents, and should be able to hold its head up. At the sixth month the baby begins to cut its temporary teeth. After their appearance they should be cleaned once a day by a piece of gauze moistened in boric acid solution. Attempts to stand are made about the tenth month, and walking begins about the fourteenth month. By this time the intelligence should be developed and memory is observed. A child a year old should be able to articulate a few small words. With the advent of walking and speech the period of infancy may be said to end.

See Pierre Budin, *The Nursing* (1907); Henry Koplik, *Disease of Infancy and Childhood* (1906); Eric Pritchard, *The Physiological Feeding of Infants* (1904); Eric Pritchard, *Infant Education* (1907); John Grimshaw, *Your Child's Health* (1908). (H. L. H.)

**INFANT** (in early forms *enfant*, *enfant*, through the Fr. *enfant*, from Lat. *infans*, in, not, and *fans*, the present participle of *fari*, to speak), a child; in non-legal use, a very young child, a baby, or one of an age suitable to be taught in an "infant school"; in law, a person under full age, and therefore subject to disabilities not affecting persons who have attained full age.

This article deals with "infants" in the last sense; for the more general sense see **INFANCY** and **CHILD**. The period of full age varies widely in different systems, as do also the disabilities attaching to nonage (non-age). In Roman law, the age of puberty, fixed at fourteen for males and twelve for females, was recognized as a dividing line. Under that age a child was under the guardianship of a tutor, but several degrees of infancy were recognized. The first was absolute infancy; after that, until the age of seven, a child was *infantia proximus*; and from the eighth year to puberty he was *pubertati proximus*. An infant in the last stage could, with the assent of his tutor, act so as to bind himself by stipulations; in the earlier stages he could not, although binding stipulations could be made to him in the second stage. After puberty, until the age of twenty-five years, a modified infancy was recognized, during which the minor's acts were not void altogether, but voidable, and a curator was appointed to manage his affairs. The difference between the tutor and the

curator in Roman law was marked by the saying that the former was appointed for the care of the person, the latter for the estate of the pupil. These principles apply only to children who are *sui juris*. The *patria potestas*, so long as it lasts, gives to the father the complete control of the son's actions. The right of the father to appoint tutors to his children by will (*testamentarii*) was recognized by the Twelve Tables, as was also the tutorship of the *agnati* (or legal as distinct from natural relations) in default of such an appointment. Tutors who held office in virtue of a general law were called *legitimi*. Besides and in default of these, tutors *dati* were appointed by the magistrates. These terms are still used in much the same sense in modern systems founded on the Roman law, as may be seen in the case of Scotland, noticed below.

By the law of England full age is twenty-one, and all minors alike are subject to incapacities. The period of twenty-one years is regarded as complete at the beginning of the day before the birthday; for example, an infant born on the first day of January attains his majority at the first moment of the 31st of December. The incapacity of an infant is designed for his own protection, and its general effect is to prevent him from binding himself absolutely by obligations. Of the contracts of an infant which are binding *ab initio*, the most important are those relating to "necessaries." By the Sale of Goods Act 1893, an infant liable on a contract for necessaries can be sued only for a reasonable price, not necessarily the price he agreed to pay. The same statute declares "necessaries" to mean "goods suitable to the condition in life of the infant, and to his actual requirements at the time of the sale and delivery." In the case of goods having a market price, the market price is reasonable. In all other cases the question is one of fact for the jury. The protection of infants extends sometimes to transactions completed after full age; the relief of heirs who have been induced to barter away their expectations is an example. "Catching bargains," as they are called, throw on the persons claiming the benefit of them the burden of proving their substantial righteousness.

At common law a bargain made by an infant might be ratified by him after full age, and would then become binding. Lord Tenderden's act required the ratification to be in writing. But now, by the Infants' Relief Act 1874, "all contracts entered into by infants for the repayment of money lent or to be lent, or for goods supplied or to be supplied (other than contracts for necessities), and all accounts stated, shall be absolutely void," and "no action shall be brought whereby to charge any person upon any promise made after full age to pay any debt contracted during infancy, or upon any ratification made after full age of any promise or contract made during infancy, whether there shall or shall not be any new consideration for such promise or ratification after full age." For some years after the passage of this statute highly conflicting views were held as to the meaning of the part of section 2 whereby it was enacted that "no action shall be brought whereby to charge any person . . . upon any ratification made after full age of any promise or contract made during infancy." Some authorities were of opinion that the section only applied to the three classes of contract made void by the previous section, viz. for goods supplied, money lent and on account stated. Others thought the effect to be that no contract, except for necessities, made during infancy could be enforced after the infant came to full age. After several conflicting decisions it has been settled that both these views were wrong. Of the infant's contracts voidable at common law there were two kinds. The first kind became void at full age, unless expressly ratified. The second kind were valid, unless repudiated within a reasonable time after full age was attained by the infant. The Infants' Relief Act (section 2) strikes only at the first class and leaves the second untouched. Thus a promise of marriage made during infancy cannot be ratified so as to become actionable; but an infant's marriage settlement, being of the second class, is valid, unless it is repudiated within a reasonable time after the infant attains full age. What is a reasonable time depends on all the circumstances of the case. In a case decided in 1893 a



settlement made by a female infant was allowed to be repudiated thirty years after she attained full age, but the circumstances were exceptional. A contract of marriage may be lawfully made by persons under age. Marriageable age is fourteen in males and twelve in females. So, generally, an infant may bind himself by contract of apprenticeship or service. Since the passing of the Wills Act, an infant, except he be a soldier in actual military service or a seaman at sea, is unable to make a will. Infancy is in general a disqualification for public offices and professions, e.g. to be a member of parliament or an elector, a mayor or Burgess, a priest or deacon, a barrister or solicitor, &c.

Before 1886 the custody of an infant belonged in the first place, and against all other persons, to the father, who was said to be "the guardian of his children by nature and nurture"; and the father might by deed or will dispose of the custody or tuition of his children until the age of twenty-one.

The Guardianship of Infants Act 1886 placed the mother almost on the same footing as the father as to guardianship of infants. On the death of the father the mother becomes guardian under the statute, either alone when no guardian has been appointed by the father, or jointly with any guardian appointed by him under 12 Chas. II. c. 24. A change of the law even more important is that whereby the mother may by deed or will appoint a guardian or guardians of her infant children to act after her death. If the father survives the mother, the mother's guardian can only act if he be shown to the satisfaction of the court that the father is unfit to be the sole guardian. On the death of the father, the guardian so appointed by the mother acts jointly with any guardian appointed by the father. The Guardianship of Infants Act 1886 also gives power to the high court and to county courts to make orders, upon the application of the mother, regarding the custody of an infant, and the right of access thereto of either parent. The court must take into consideration "the welfare of the infant, and . . . the conduct of the parents, and . . . the wishes as well of the mother as of the father." The same statute also empowers the high court of justice, "on being satisfied that it is for the welfare of the infant," to "remove from his office any testamentary guardian or any guardian appointed or acting by virtue of this act," and also to appoint another in place of the guardian so removed.

The same statute gives power to a court sitting in divorce practically to take away from a parent guilty of a matrimonial offence all rights of guardianship. When a decree for judicial separation or divorce is pronounced, the court pronouncing it may at the same time declare the parent found guilty of misconduct to be unfit to have the custody of the children of the marriage. "In such case the parent so declared to be unfit shall not, upon the death of the other parent, be entitled as of right to the custody or guardianship of such children." The court exercises this power very sparingly. When the declaration of unfitness is made, the practical effect is to give to the innocent parent the sole guardianship, as well as power to appoint a testamentary guardian to the exclusion of the guilty parent.

Another radical change has been made in the rights of parents as to guardianship of their children. In consequence of several cases where, after children had been rescued by philanthropic persons from squalid homes and improper surroundings, the courts had felt bound by law to redeliver them to their parents, the Custody of Children Act 1891 was passed. It provides that when the parent of a child applies to the court for a writ or order for the production of the child, and the court is of opinion that the parent has abandoned or deserted the child, or that he has otherwise so conducted himself that the court should refuse to enforce his right to the custody of the child, the court may, in its discretion, decline to issue the writ or make the order. If the child, in respect of whom the application is made, is being brought up by another person ("person" includes "school or institution"), or is being boarded out by poor-law guardians, the court may, if it orders the child to be given up to the parent, further order the parent to pay all or part of the cost incurred by such person or guardians in bringing up the child.

A parent who has abandoned or deserted his child is, *prima facie*, unfit to have the custody of the child. And before the court can make an order giving him the custody, the onus lies on him to prove that he is fit. The same rule applies where the child has been allowed by the parent "to be brought up by another person at that person's expense, or by the guardians of a poor-law union, for such a length of time and under such circumstances as to satisfy the court that the parent was unmindful of his parental duties."

The 4th section of the Custody of Children Act 1891 preserves the right of the parent to control the religious training of the infant. The father, however unfit he may be to have the custody of his child, has the legal right to require the child to be brought up in his own religion. If the father is dead, and has left no directions on the point, the mother may assert a similar right. But the court may consult the wishes of the child; and when an infant has been allowed by the father to grow up in a faith different from his own, the court will not, as a rule, order any change in the character of religious instruction. This is especially the case where the infant appears to be settled in his convictions.

In the same direction as the Custody of Children Act 1891 is the Children Act 1908, whereby considerable powers have been conferred on courts of summary jurisdiction (see CHILDREN, LAW RELATING TO).

There is not at common law any corresponding obligation on the part of either parent to maintain or educate the children. The legal duties of parents in this respect are only those created by the poor laws, the Education Acts and the Children Act 1908.

An infant is liable to a civil action for torts and wrongful acts committed by him. But, as it is possible so to shape the pleadings as to make what is in substance a right arising out of contract take the form of a right arising from civil injury, care is taken that an infant in such a case shall not be held liable. With respect to crime, mere infancy is not a defence, but a child under seven years of age is presumed to be incapable of committing a crime, and between seven and fourteen his capacity requires to be affirmatively proved. After fourteen an infant is *doli capax*.

The law of Scotland follows the leading principles of the Roman law. The period of minority (which ends at twenty-one) is divided into two stages, that of absolute incapacity (until the age of fourteen in males, and twelve in females), during which the minor is in pupilarity, and that of partial incapacity (between fourteen and twenty-one), during which he is under curators. The guardians (or tutors) of the pupil are either tutors-nominate (appointed by the father in his will); tutors-at-law (being the next male agnate of twenty-five years of age, in default of tutors-nominate; or tutors-datave, appointed by royal warrant in default of the other two. No act done by the pupil, or action raised in his name, has any effect without the interposition of a guardian. After fourteen, all acts done by a minor having curators are void without their concurrence. Every deed in nonage, whether during pupilarity or minority, and whether authorized or not by tutors or curators, is liable to annulment on proof of "lesion," i.e. of material injury, due to the fact of nonage, either through the weakness of the minor himself or the imprudence or negligence of his curators. Damage in fact arising on a contract in itself just and reasonable would not be lesion entitling to restitution. Deeds in nonage, other than those which are absolutely null *ab initio*, must be challenged within the *quadriennium utile*, or four years after majority.

The Guardianship of Infants Act 1886, the Custody of Children Act 1891 and the Children Act 1908, mentioned above, all apply to Scotland.

In the United States, the principles of the English common law as to infancy prevail, generally the most conspicuous variations being those affecting the age at which women attain majority. In many states this is fixed at eighteen. There is some diversity of practice as to the age at which a person can make a will of real or personal estate.

**INFANTE** (Spanish and Portuguese form of Lat. *infans*, young child), a title of the sons of the sovereign of Spain and Portugal, the corresponding *infanta* being given to the daughters. The title is not borne by the eldest son of the king of Spain, who is prince of Asturias, *El príncipe de Asturias*. Until the severance of Brazil from the Portuguese monarchy, the eldest son was prince of Brazil. While a son or daughter of the sovereign of Spain is by right infante or infanta of Spain, the title, alone, is granted to other members of the blood royal by the sovereign.

**INFANTICIDE**, the killing of a newly-born child or of the matured foetus. When practised by civilized peoples the subject of infanticide concerns the criminologist and the jurist; but its importance in anthropology, as it involves a widespread practice among primitive or savage nations, requires more detailed attention. J. F. McLennan (*Studies in Ancient History*, pp. 75 et seq.) suggests that the practice of female infanticide was once universal, and that in it is to be found the origin of exogamy. Much evidence, however, has been adduced against this hypothesis by Herbert Spencer and Edward Westermarck. Infanticide, both of males and females, is far less widespread among savage races than McLennan supposed. It certainly is common in many lands, and more females are killed than males; but among many fierce and savage peoples it is almost unknown. Thus among the Tuski, Ahts, Western Eskimo and the Botocudos new-born children are killed now and then, if they are weak and deformed, or for some other reason (such as the superstition attaching to birth of twins) but without distinction of sex. Among the Dakota Indians and Crees female infanticide is rare. The Blackfoot Indians believe that a woman guilty of such an act will never reach "the Happy Mountain" after death, but will hover round the scene of her misdeed with branches of trees tied to her legs. The Aleutians hold that child-murder brings misfortune on the whole village. Among the Abipones it is common, but the boys are usually the victims, because it is customary to buy a wife for a son, whereas a grown daughter will always command a price. In Africa, where a warm climate and abundance of food simplify the problem of existence, the crime is not common. Herr Valdau relates that a Bakundu woman, accused of it, was condemned to death. In Samoa, in the Mitchell and Hervey Islands, and in parts of New Guinea, it was unheard of; while among the cannibals, the Solomon Islanders, it occurred rarely. A theory has been advanced by L. Fison (*Komiaroi and Kurnai*, 1880) that female infanticide is far less common among the lower savages than among the more advanced tribes. Among some of the most degraded of human beings, such as the Yahgans of Tierra del Fuego, the crime was unknown, except when committed by the mother "from jealousy or hatred of her husband or because of desertion and wretchedness." It is said that certain Californian Indians were never guilty of child-murder before the arrival of the whites; while Wm. Ellis (*Polynesian Researches*, i. 249) thinks it most probable that the custom was less prevalent in earlier than later Polynesian history. The weight of evidence tends to support Darwin's theory that during the earliest period of human development man did not lose that strong instinct, the love of his young, and consequently did not practice infanticide; that, in short, the crime is not characteristic of primitive races.

Infanticide may be said to arise from four reasons. It may be (1) an act of callous brutality or to satisfy cannibalistic cravings. A Fuegian, Darwin relates, dashed his child's brains out for upsetting a basket of fish. An Australian, seeing his infant son ill, killed, roasted and ate him. In some parts of Africa the negroes bait lion-traps with their own children. Some South American Indians, such as the Moxos, abandon or kill them without reason; while African and Polynesian cannibals eat them without the excuse of the periodic famines which made the Tasmanians regard the birth of a child as a piece of good fortune.

2. Or infanticide may be the result of the struggle for existence. Thus in Polynesia, while the climate ensures food in plenty, the relative smallness of the islands imposed the custom on all families without distinction. In the Hawaiian Islands all children, after the third or fourth, were strangled or buried alive. At Tahiti fathers had the right (and used it) of killing their newly-born children by suffocation. The chiefs were obliged by custom to kill all their daughters. The society of the Areois, famous in the Society Islands, imposed infanticide upon the women members by oath. In other islands all girl-children were spared, but only two boys in each family were reared. The difficulties of suckling partly explain the custom of killing twins. For the same reason the Eskimo and Red Indians used to bury the

infant with the mother who died in child-birth. Among warrior and hunter tribes, where women could not act as beasts of burden as in agricultural communities, and where a large number of girls were likely to attract the hostile attentions of neighbouring tribesmen, girl-babies were murdered. Arabs, in ancient times, buried alive the majority of female children. In many lands infanticide was regarded as a meritorious act on the part of a parent, done, as a precaution against famine, in the interests of the tribe. In other parts of the world, infanticide results from customs which impose heavy burdens on child-rearing. Of these artificial hardships the best example is afforded by India. There the practice, though forbidden by both the Vedas and the Koran, prevailed among the Rajputs and certain aboriginal tribes. Among the aristocratic Rajputs, it was thought dishonourable that a girl should remain unmarried. Moreover, a girl may not marry below her caste; she ought to marry her superior, or at least her equal. This reasoning was most powerful with the highest castes, in which the disproportion of the sexes was painfully apparent. But, assuming marriage to be possible, it was ruinously expensive to the bride's father, the cost in the case of some rajahs having been known to exceed £100,000. To avoid all this, the Rajput killed a proportion of his daughters—sometimes in a very singular way. A pill of tobacco and bhargh may be given to the new-born child; or it was drowned in milk; or the mother's breast was smeared with opium or the juice of the poisonous *datura*. A common method was to cover the child's mouth with a plaster of cow-dung, before it drew breath. Infanticide was also practised to a small extent by some sects of the aboriginal Khonds and by the poorer hill-tribes of the Himalayas. Where infanticide occurs in India, though it really rests on the economic facts stated, there is usually some poetical tradition of its origin. Infanticide from motives of prudence was common among some American Indian tribes of the northwest, with whom the "potlatch" was an essential part of their daughter's marriage ceremonies.

3. Or infanticide may be in the nature of a religious observance. The gods must be appeased with blood, and it is believed that no sacrifice can be so pleasing to them as the child of the worshipper. Such were the motives impelling parents to the burning of children in the worship of Moloch. In India children were thrown into the sacred river Ganges, and adoration paid to the alligators who fed on them. Where the custom prevails as a sacrifice the male child is usually the victim.

4. Or, finally, infanticide may have a social or political reason. Thus at Sparta (and in other places in early Greek and Roman history) weakly or deformed children were killed by order of the state, a custom approved in the ideal systems of Aristotle and Plato, and still observed among the Eskimo and the Kamchadales.

**AUTHORITIES**.—Herbert Spencer, *Principles of Sociology*, i. 614-619; McLennan, *Studies in Ancient History*, pp. 75 et seq.; McLennan, "Exogamy and Endogamy" in the *Fortnightly Review*, xxi. 884 et seq.; Darwin, *Descent of Man*, ii. 400 et seq.; L. Fison, and A. W. Howitt, *Komiaroi and Kurnai* (1880); Westermarck, *History of Human Marriage* (1894); Browne, *Infanticide: Its Origin, Progress and Suppression* (London, 1857); Lord Avebury, *Prehistoric Times* (1900), and *Origin of Civilization* (1902).

**Law**.—The crime of infanticide among civilized nations is still frequent. It is however due in most cases to abnormal causes, such as a sudden access of insanity, privation, unreasoning dislike to the child, &c. It is most closely connected with illegitimacy in the class of farm and domestic servants, the more common motive being the terror of the mother of incurring the disgrace with which society visits the more venial offence. Often, however, it is inspired by no better motive than the wish to escape the burden of the child's support. The granting of affiliation orders thus tends to save the lives of many children, though it provides a motive for the paramour sometimes to share in the crime. The laws of the European states differ widely on this subject—some of them treating infanticide as a special crime, others regarding it merely as a case of murder

<sup>1</sup> In Baluchistan, where children are often drowned in milk, there is a euphemistic proverb: "The lady's daughter died drinking milk."

of unusually difficult proof. In the law of England infanticide is murder or manslaughter according to the presence or absence of deliberation. The infant must be a human being in the legal sense; and "a child becomes a human being when it has completely proceeded in a living state from the body of its mother, whether it has breathed or not, and whether it has an independent circulation or not, and whether the navel-string is severed or not; and the killing of such a child is homicide when it dies after birth in consequence of injuries received before, during or after birth." A child in the womb or in the act of birth, though it may have breathed, is therefore not a human being, the killing of which amounts to homicide. The older law of child murder under a statute of James I. consisted of cruel presumptions against the mother, and it was not till 1803 that trials for that offence were placed under the ordinary rules of evidence. The crown now takes upon itself the onus of proving in every case that the child has been alive. This is often a matter of difficulty, and hence a frequent alternative charge is that of concealment of birth (see BIRTH), or concealment of pregnancy in Scotland. It is the opinion of the most eminent of British medical jurists that this presumption has tended to increase infanticide. Apart from this, the technical definition of human life has excited a good deal of comment and some indignation. The definition allows many wicked acts to go unpunished. The experience of assizes in England shows that many children are killed when it is impossible to prove that they were wholly born. The distinction taken by the law was probably comprehended by the minds of the class to which most of the unhappy mothers belong. Partly to meet this complaint it was suggested to the Royal Commission of 1866 that killing during birth, or within seven days thereafter, should be an offence punishable with penal servitude. The second complaint is of an opposite character—partly that infanticide by mothers is not a fit subject for capital punishment, and partly that, whatever be the intrinsic character of the act, juries will not convict or the executive will not carry out the sentence. Earl Russell gave expression to this feeling when he proposed that no capital sentence should be pronounced upon mothers for the killing of children within six months after birth. When there has been a verdict of murder, sentence of death must be passed, but the practice of the Home Office, as laid down in 1908, is invariably to commute the death sentence to penal servitude for life. The circumstances of the case and the disposition and general progress of the prisoners under discipline in a convict prison are then determining factors in the length of subsequent detention, which rarely exceeds three years. After release, the prisoner's further progress is carefully watched, and if it is seen to be to her advantage the conditions of her release are cancelled and she is restored to complete freedom.

In India measures against the practice were begun towards the end of the 18th century by Jonathan Duncan and Major Walker. They were continued by a series of able and earnest officers during the 19th century. One of its chief exponents, representing many minor occurrences, was the Amritsar durbar of 1853, which was arranged by Lord Lawrence. At that meeting the chiefs residing in the Punjab and the trans-Sutlej states signed an agreement engaging to expel from caste every one who committed infanticide, to exclude fixed and moderate rates of marriage expenses, and to abstain from these ceremonies the minstrels and beggars who had so greatly swollen the expensc. According to the present law, if the female children fall below a certain percentage in any tract or among any tribe in northern India where infanticide formerly prevailed, the suspected village is placed under police supervision, the cost being charged to the locality. By these measures, together with a strictly enforced system of reporting births and deaths, infanticide has been almost trampled out; although some of the Rājput clans keep their female offspring suspiciously close to the lowest average which secures them from surveillance.

It is difficult to say to what extent infanticide prevails in the United Kingdom. At one time a large number of children were murdered in England for the purpose of obtaining the

burial money from a benefit club,<sup>1</sup> but protection against this risk has been provided for by the Friendly Societies Act 1896, and the Collecting Societies Act 1896. The neglect or killing of nurse-children is treated under BABY-FARMING, and CHILDREN, LAW RELATING TO.

In the United States, the elements of this offence are practically the same as in England. The wilful killing of an unborn child is not manslaughter unless made so by statute. To constitute manslaughter under Laws N.Y. 1869, ch. 631, by attempts to produce miscarriage, the "quickenig" of the child must be averred and proved (*Evans v. People*, 49 New York Rep. 86; see also *Wallace v. State*, 7 Texas app. 570).

**INFANTRY**, the collective name of soldiers who march and fight on foot and are armed with hand-weapons. The word is derived ultimately from Lat. *infans*, infant, but it is not clear how the word came to be used to mean soldiers. The suggestion that it comes from a guard or regiment of a Spanish *infanta* about the end of the 15th century cannot be maintained in view of the fact that Spanish foot-soldiers of the time were called *soldados* and contrasted with French *fantassins* and Italian *fanteria*. The *New English Dictionary* suggests that a foot-soldier, being in feudal and early modern times the varet or follower of a mounted noble, was called a boy (cf. *Knabe*, *garçon*, footman, &c., and see VALET).

#### HISTORICAL SKETCH

The importance of the infantry arm, both in history and at the present time, cannot be summed up better and more concisely than in the phrase used by a brilliant general of the Napoleonic era, General Morand—"L'infanterie, c'est l'armée."

It may be confidently asserted that the original fighting man was a foot-soldier. But infantry was differentiated as an "arm" considerably later than cavalry; for when a new means of fighting (a chariot or a horse) presented itself, it was assimilated by relatively picked men, chiefs and noted warriors, who *ipso facto* separated themselves from the mass or reservoir of men. How this mass itself ceased to be a mere residue and developed special characteristics; how, instead of the cavalry being recruited from the best infantry, cavalry and infantry came to form two distinct services; and how the arm thus constituted organized itself, technically and tactically, for its own work—these are the main questions that constitute the historical side of the subject. It is obvious that as the "residue" was far the greatest part of the army, the history of the foot-soldier is practically identical with the history of soldiering.

It was only when a group of human beings became too large to be surprised and assassinated by a few lurking enemies, that proper fighting became the normal method of settling a quarrel or a rivalry. Two groups, neither of which had been able to surprise the other, had to meet face to face, and the instinct of self-preservation had to be reconciled with the necessity of victory. From this it was an easy step to the differentiation of the champion, the proved excellent fighting man, and to providing this man, on whom everything depended, with all assistance that better arms, armour, horse or chariot could give him. But suppose our champion slain, how are we to make head against the opposing champion? For long ages, we may suppose, the latter, as in the *Iliad*, slaughtered the sheep who had lost their shepherd, but in the end the "residue" began to organize itself, and to oppose a united front to the enemy's champions—in which term we include all selected men, whether horsemen, charioteers or merely specially powerful axemen and swordsmen. But once the individual had lost his commanding position, the problem presented itself in a new form—how to ensure that every member of the group did his duty by the others—and the solution of this problem for the conditions of the ancient hand-to-hand struggle marks the historical beginning of infantry tactics.

Galloic warriors bound themselves together with chains. The Greeks organized the city state, which gave each small army

<sup>1</sup> See *Report on the Sanitary Condition of the Labouring Classes*, "Supplementary Report on Intercement in Towns," by Edwin Chadwick (*Park Papers*, 1843, xii, 395); and *The Social Condition and Education of the People*, by Joseph Kay (1850).

solidarity and the sense of duty to an ideal, and the phalanx, in which the file-leaders were in a sense champions yet were made so chiefly by the unity of the mass. But the Romans went farther. Besides developing solidarity and a sense of duty, they improved on this conception of the battle to such a degree that as a nation they may be called the best tacticians who ever existed. Giving up the attempt to make all men fight equally well, they dislocated the mass of combatants into three bodies, of which the first, formed of the youngest and most impressionable men, was engaged at the outset, the rest, more experienced men, being kept out of the turmoil. This is the very opposite of the "champion" system. Those who would have fled after the fall of the champions are engaged and "fought out" before the champions enter the area of the contest, while the champions, who possess in themselves the greatest power of resisting and mastering the instinct of self-preservation, are kept back for the moment when ordinary men would lose heart.

It might be said with perfect justice that without infantry there would never have been discipline, for cavalry began and continued as a crowd of champions. Discipline, which created and maintained the intrinsic superiority of the Roman legion, depended first on the ideal of patriotism. This was ingrained into every man from his earliest years and expressed in a system of rewards and punishments which took effect from the same ideal, in that rewards were in the main honorary in character (mural crowns, &c.), while no physical punishment was too severe for the man who betrayed, by default or selfishness, the cause of Rome. Secondly, though every man knew his duty, not every man was equal to doing it, and in recognition of this fact the Romans evolved the system of three-line tactics in which the strong parts of the machine neutralized the weak. The first of these principles, being psychological in character, rose, flourished and decayed with the *moral* of the nation. The second, deduced from the first, varied with it, but as it was objectively expressed in a system of tactics, which had to be modified to suit each case, it varied also in proportion as the combat took more or less abnormal forms. So closely knit were the parts of the system that not only did the decadence of patriotism sap the legionary organization, but also the unsuitability of that organization to new conditions of warfare reacted unfavourably, even disastrously, on the *moral* of the nation. Between them, the Roman infantry fell from its proud place, and whereas in the Republic it was familiarly called the "strength" (*robur*), by the 4th century A.D. it had become merely the background for a variety of other arms and corps. Luxury produced "egoists," to whom the rewards meant nothing and the punishments were torture for the sake of torture. When therefore the Roman *imperium* extended far enough to bring in silks from China and ivory from the forests of central Africa, the citizen-army ceased to exist, and the mere necessity for garrisoning distant savage lands threw the burden of service upon the professional soldier.

The natural consequence of this last was the uniform training of every man. There were no longer any primary differences between one cohort and another, and though the value of the three-line system in itself ensured its continuance, any cohort, however constituted, might find itself serving in any one of the three lines, i.e. the *moral* of the last line was no better than that of the first. The best guarantee of success became *uniform* regimental excellence, and whereas Camillus or Scipio found useful employment in battle for every citizen, Caesar complained that a legion which had been sent him was too raw, though it had been embodied for nine years. The conditions which were so admirably met by the old system never reappeared; for before armies resumed a "citizen" character the invention of firearms had subjected all ranks and lines alike to the same ordeal of facing unseen death, and the old soldiers were better employed in standing shoulder to shoulder with the young. In brief, the old Roman organization was based on patriotism and experience, and when patriotism gave place to "egoism," and the experience of the citizen who spent every other summer in the field of war gave

place to the formal training of the paid recruit, it died, unregretted either by the citizen or by the military chieftain. The latter knew how to make the army his devoted servant, while the former disliked military service and failed to prepare himself for the day when the military chief and the mercenary overrode his rights and set up a tyranny, and ultimately the inner provinces of the empire came to be called *inermes*—unarmed, defenceless—in contrast to the borderland where the all-powerful professional legions lay in garrison.

In these same frontier provinces the tactical disintegration of the legion slowly accomplished itself. Originally designed for the exigencies of the normal pitched battle on firm open fields, and even after its professionalization retaining its character as a large battle unit, it was soon fragmented through the exigencies of border warfare into numerous detachments of greater or less size, and when the military frontier of the empire was established, the legion became an almost sedentary corps, finding the garrisons for the blockhouses on its own section of the line of defence. Further, the old heavy arms and armour which had given it the advantage in wars of conquest—in which the barbarians, gathering to defend their homes, offered a target for the blow of an army—were a great disadvantage when it became necessary to police the conquered territory, to pounce upon swiftly moving bodies of raiders before they could do any great harm. Thus gradually cavalry became more numerous, and light infantry of all sorts more useful, than the old-fashioned linesman. To these corps went the best recruits and the smartest officers, the opportunities for good service and the rewards for it. The legion became once more the "residue." Thus when the "champion" reappeared on the battlefield the solidarity that neutralized his power had ceased to exist.

The battle of Adrianople, the "last fight of the legion," illustrates this. The frontal battle was engaged in the ordinary way, and the cohorts of the first line of the imperial army were fighting man to man with the front ranks of the Gothic infantry (which had indeed a solidarity of its own, unlike the barbarians of the early empire, and was further guaranteed against moral over-pressure by a wagon laager), when suddenly the armoured heavy cavalry of the Goths burst upon their flank and rear. There were no longer *Principes* and *Triarii* of the old Republican calibre, but only average troops, in the second and third lines, and they were broken at once. The first line felt the battle in rear as well as in front and gave way. Thereafter the victors, horse and foot, slaughtered unresisting herds of men, not desperate soldiers, and on this day the infantry arm, as an arm, ceased to exist.

Of course, not every soldier became a horseman, and still fewer could provide themselves with armour. Regular infantry, too, was still maintained for siege, mountain and forest warfare. But the *robur*, the kernel of the line of battle, was gone, and though a few of the peoples that fought their way into the area of civilization in the dark ages brought with them the natural and primitive method of fighting on foot, it was practically always a combination of mighty champions and "residue," even though the latter bound themselves together by locked shields, as the Gauls had found themselves long before with chains, to prevent "skulking." These infantry nations, without any infantry system comparable to that of the Greeks and Romans, succumbed in turn to the crowd of mounted warriors—not like the Greeks and Romans for want of good military qualities, but for want of an organization which would have distributed their fighting powers to the best advantage. One has only to study the battle of Hastings to realize how completely the infantry masses of the English slipped from the control of their leaders directly the front ranks became seriously engaged. For many generations after Hastings there was no attempt to use infantry as the kernel of armies, still less to organize it as such beforehand. Indeed, except in the Crusades, where men of high and of low degree alike fought for their common faith, and in sieges, where cavalry was powerless and the services of archers and labourers were at a premium, it became quite unusual for infantry to appear on the field at all.

**The phalanx and the legion.**

**The Dark Ages.**

**The Roman Imperial Army.**

The tactics of feudal infantry at its best were conspicuously illustrated in the battle of Bouvines, where besides the barons, knights *Bouvines*, and sergeants, the Brabançon mercenaries (heavy foot) and the French communal militia opposed one another. On the French right wing, the opportune arrival of a well-ordered mass of cavalry and infantry in the flank of a loose crowd of men-at-arms which had already been thoroughly engaged, decided the fight. In the centre, the respective infantry were in first line, the nobles and knights, with their sovereigns, in second, yet it was a mixed mass of both that, after a period of confused fighting, focussed the battle in the persons of the emperor and the king of France, and if the personal encounters of the two bodies of knights gave the crowded German infantry a momentary chance to strike down the king, the latter was soon rescued by a half-dozen of heavy cavalrmen. On the left wing, the count of Boulogne made a living castle of his Brabançon pikes, whence with his men-at-arms he sallied forth from time to time and played the champion. Lastly, the Constable Montmorency brought over what was still manageable of the corps that had defeated the cavalry on the right (nearly all mounted men), and gave the final push to the allied centre and right in succession. Then the imperial army fled and was slaughtered without offering much resistance. Of infantry in this battle there was enough and to spare, but its only opportunities for decisive action were those afforded by the exhaustion of the armoured men or by the latter becoming absorbed in their own single combats to the exclusion of their proper work in the line of battle. As usual the infantry suffered nine-tenths of the casualties. For all the numbers and apparent tactical distribution on this field, they were "residue," destitute of special organization, training or utility; and the only suggestion of "combined tactics" is the expedient adopted by the count of Boulogne, rings of spearmen to serve as pavilions served in the tournament—to secure a decorous setting for a display of knightly prowess.

In those days in truth the infantry was no more the army than to-day the shareholders of a limited company are the board of directors. They were deeply, sometimes vitally, interested in the result, but they contributed little or nothing to bringing it about, except when the opposing cavalries were in a state of moral equilibrium, and in these cases anything suffices—the appearance of camp followers on a "Gillies Hill," as at Bannockburn or the sound of half-a-dozen trumpets—to turn the scale. Once it turned, the infantry of the beaten side was cut down unresistingly, while the more valuable prisoners were admitted to ransom. Thereafter, feudal tactics were based principally on the ideas of personal glory—won in single combat, champion against champion, and of personal profit—won by the knight in holding a wealthy and well-armed baron to ransom and by the foot-soldier in plundering while his masters were fighting. In the French army, the term *bidoux*, applied in the days of Bouvines to all the infantry other than archers and arblasters, came by a quite natural process to mean the laggards, malingerers and skulkers of the army.

But even this infantry contained within itself two half-smothered sparks of regeneration, the idea of *archery* and the idea of *communal militia*. Archery, in whatever form practised, was the one special form of military activity with which the heavy *gendarme* (whether he fought on horseback or dismounted) had no concern. Here therefore infantry had a special function, and in so far ceased to be "residue." The communal militia was an early and inadequate expression of the town-spirit that was soon to produce the solid burgher-militia of Flanders and Germany and after that the trained bands of the English cities and towns. It therefore represented the principles of solidarity, of combination, of duty to one's comrade and to the common cause—principles which had disappeared from feudal warfare.<sup>1</sup> It was under the influence of these two ideas or forces that infantry as an arm began once again, though slowly and painfully, to differentiate itself from the mass of *bidoux* until in the end the latter practically contained only the worthless elements.

The first truth of infantry battle of the Hastings was fought at Courtrai in 1302, between the burghers of Bruges and a feudal army under Count Robert of Artois. The citizens, arrayed in heavy masses, and still armed with miscellaneous weapons, were careful to place themselves on ground difficult of access—dikes, pools

and marshes—and to fasten themselves together, like the Gauls of old. Their van was driven back by the French communal infantry and professional crossbowmen, whereupon Robert of Artois, true feudal leader as he was, ordered his infantry to clear the way for the cavalry and without even giving them time to do so pushed through their ranks with a formless mass of gendarmic. This, in attempting to close with the enemy, plunged into the canals and swamped lands, and was soon immovably fastened in the mud. The citizens swarmed all round it and with spear, cleaver and flail destroyed it. Robert himself with a party of his gendarmic strove to break through the solid wall of spears, but in vain. He was killed and his army perished with him, for the citizens did not regard war as a game and ransom as the loser's forfeit. As for the communal infantry which had won the first success, it had long since disappeared from the field, for when count Robert ordered his heavy cavalry forward, they had thought themselves attacked in rear by a rush of hostile cavalry—as indeed they were, for the gendarmic rode them down—and melted away.

Crécy (*q.v.*) was fought forty-four years after Courtrai. Here the knights had open ground to fight on, and many boasted that they would revenge themselves. But they encountered not merely infantry, but infantry tactics, and were for the second, and not the last, time destroyed. The English army included a large feudal element, but the spirit of discipline had been crushed by a series of iron-handed kings, and for more than a century the nobles, in so far as they had been bad subjects, had been good Englishmen. The English yeoman had reached a level of self-discipline and self-respect which few even of the great continental cities had attained. They had, lastly, made the powerful long-bow (see ARCHERY) their own, and Edward I. had combined the shock of the heavy cavalry with the slow searching preparatory rain of arrows (see FALKIRK). That is, infantry tactics and cavalry tactics were co-ordinated by a *general*, and the special point of this for the present purpose is that instead of being, as in France, the unstable base of the so-called "feudal pyramid," infantry has become an *arm*, capable of offence and defence and having its own special organization, function in the line of battle and tactical method. This last, indeed, like every other tactical method, rested ultimately on the *moral* of the men who had to put it into execution. Archer tactics did not serve against the disciplined rush of Joan of Arc's gendarmic, for the solidarity of the archer companies that tried to stop it had long been undermined.

Yet we cannot overrate the importance of the archer in this period of military history. In the city militias solidarity had been obtained through the close personal relationship of the trade guilds and by the elimination of the champion. Therefore, as every offensive in war rests upon boldness, these militias were essentially defensive, for they could only hope to ward off the feudal champion, not to outfight him (Battle of Legnano, 1176. See Oman, p. 442). England, however, had evolved a weapon which no armour could resist, and a race of men as fully trained to use it as the gendarme was to use the lance.<sup>2</sup> This weapon gave them the power of killing without being killed, which the citizens' spears and maces and voluges did not. But like all missiles, arrows were a poor stand-by in the last resort if determined cavalry crossed the "beaten zone" and closed in, and besides paves and pointed stakes the English archers were given the support of the knights, nobles and sergeants—the armoured champions—whose steady lances guaranteed their safety. Here was the real forward stride in infantry tactics. Archery had existed from time immemorial, and a mere technical improvement in its weapon could hardly account for its suddenly becoming the queen of the battlefield. The defensive power of the "dark impenetrable wood" of spears had been demonstrated again and again, but when the cavalry had few or no preliminary difficulties to face, the chances of the infantry mass resisting long-continued pressure was small. It was the combination of the two elements that made possible a Crécy and a Poitiers, and this combination was the result of the English social system which produced the

The  
English  
archer.

<sup>1</sup> At Bouvines, it is recorded with special emphasis that Guillaume des Barres, when in the act of felling the emperor, heard the call to rescue King Philip Augustus and, forfeiting his rich prize, made his way back to help his own sovereign.

<sup>2</sup> Crossbows indeed were powerful, and also handled by professional soldiers (e.g. the Genoese at Crécy), but they were slow in action, six times as slow as the long bow, and the impatient gendarmic generally became tired of the delay and crowded out or rode over the crossbowmen.

*camaraderie* of knight and yeoman, champion and plain soldier. Fortified by the knight's unshakable steadiness, the yeoman hardened his bow and arrows with cool certainty and rapidity, and shot down every rush of the opposing champions. This was *camaraderie de combat* indeed, and in such conditions the offensive was possible and even easy. The English conquered whole countries while the Flemish and German spearmen and vougiers merely held their own. For them, decisive victories were only possible when the enemy played into their hands, but for the English the guarantee of such victories was the specific character of their army itself and the tactical methods resulting from and expressing that character.

But the war of conquest embodied in these decisive victories dwindled in its later stages to a war of raids. The feudal lord, like the feudal vassal, returned home and gave place to the professional man-at-arms and the professional captain. Ransom became again the chief object, and except where a great leader, such as Bertrand Du Guesclin, compelled the mercenaries to follow him to death or victory, a battle usually became a *mêlée* of irregular duels between men-at-arms, with all the selfishness and little of the chivalry of the purely feudal encounter. The war went on and on, the gendarmes thickened their armour, and the archers found more difficulty in penetrating it. Moreover, in raids for devastation and booty, the slow-moving infantryman was often a source of danger to his comrades. In this *guerrilla* the archer, though he kept his place, soon ceased to be the mainstay of battle. It had become customary since Crécy (where the English knights and sergeants were dismounted to protect the archers) for all mounted men to send away their horses before engaging. Here and there cavalry masses were used by such energetic leaders as the Black Prince and Du Guesclin, and more often a few men remained mounted for work requiring exceptional speed and courage,<sup>1</sup> but as a general rule the man-at-arms was practically a mounted infantryman, and when he dismounted he stood still. Thus two masses of dismounted lances, mixed with archers, would meet and engage, but the archers, the offensive element, were now far too few in proportion to the lances, the purely defensive element, and battles became indecisive skirmishes instead of overwhelming victories.

Cavalry therefore became, in a very loose sense of the word, infantry. But we are tracing the history not of all troops that stood on their feet to fight, but of infantry and the special tactics of infantry, and the period before and after 1370, when the moral foundations of the new English tactics had disappeared, and the personality of Du Guesclin gave even the bandits of the "free companies" an intrinsic, if slight, superiority over the invaders, is a period of deadlock. Solidarity, such as it was, had gone over to the side of the heavy cavalry. But the latter had deliberately forfeited their power of forcing the decision by fighting on foot, and the English archer, the cadre of the English tactical system, though diminished in numbers, prestige and importance, held to existence and survived the deadlock. Infantry of that type indeed could never return to the "residue" state, and it only needed a fresh moral impetus, a Henry V., to set the old machinery to work again for a third great triumph. But again, after Agincourt, the long war lapsed into the hands of the soldiers of fortune, the basis of Edward's and Henry's tactics crumbled, and, led by a greater than Du Guesclin, the knights and the nobles of France, and the mercenary captains and men-at-arms as well, rode down the stationary masses of the English, lances and bowmen alike.

The net result of the Hundred Years' War therefore was to re-establish the two arms, cavalry and infantry, side by side, the one acting by shock, and the other by fire. The lesson of Crécy was "prepare your charge before delivering it," and for that purpose great bodies of infantry armed with bows, arblasters and handguns were brought into existence in France. When the French king in 1448 put into force the "lessons of the war" and organized a permanent army, it consisted in the main of heavy

cavalry (knights and squires in the "ordonnance" companies, soldiers of fortune in the paid companies) and archers and arblasters (*francs-archers* recruited nationally, arblasters as a rule mercenaries, though largely recruited in Gascony). To these *armes de jet* were added, in ever-increasing numbers, hand firearms. Thus the "fire" principle of attack was established, and the defensive principle of "mass" relegated to the background. In such circumstances cavalry was of course the decisive arm, and the reputation of the French gendarmerie was such as to justify this bold elimination of the means of passive defence.<sup>2</sup>

The foot-soldier of Germany and the Low Countries had followed a very different line of development. Here the rich commercial cities scarcely concerned themselves with the quarrels or revolts of neighbouring nobles, but they resolutely defended their own rights against feudal interference, and enforced them by an organized militia, opposing the strict solidarity of their own institutions to the prowess of the champion who threatened them. The struggle was between "you shall" on the part of the baron and "we will not" on the part of the citizens, the offensive *versus* the defensive in the simplest and plainest form. The latter was a policy of unbreakable squares, and wherever possible, strong positions as well. Sometimes the citizens, sometimes the nobles gained the day, but the general result was that steady infantry in proper formation could not be ridden down, and as yeomen-archers of the English type to "prepare" the charge were not obtainable from amongst the serf populations of the countryside, the problem of the attack was, for Central Europe, insoluble.

The unbreakable square took two forms, the *wagenburg* with artillery, and the infantry mass with pikes. The first was no more, in the beginning, than an expedient for the safe and rapid crossing of wider stretches of open country than would have been possible for dismounted men, whom the cavalry headed off as soon as they ventured far enough from the shelter of walls. The men rode not on horses but on carriages, and the carriages moved over the plains in laager formation, the infantrymen standing ready with halberd and vouge or short stabbing spear, and the gunners crouching around the long barbed two-pounders and the "ribaudequins"—the early machine guns—which were mounted on the wagons. These *wagenburgs* combined in themselves the due proportions of mobility and passive defence, and in the skilled hands of Ziska they were capable of the boldest offensive. But such a tactical system depended first of all on drill, for the armoured cavalry would have crowded through the least gap in the wagon line, and the necessary degree of drill in those days could only be attained by an army which had both a permanent existence and some bond of solidarity more powerful than the incentive to plunder—that is, in practice, it was only attained in full by the Hussite insurgents. The cavalry, too, learned its lesson, and pitted mobile three-pounders against the foot-soldiers' one- and two-pounders, and the *wagenburg* became no more than a helpless target. Thus when, not many years after the end of the Hussite wars, the Wars of the Roses eliminated the English model and the English tactics from the military world of Europe, the French system of fire tactics—masses of archers, arblasters and handgun-men, with some spearmen and halberdiers to stiffen them—was left face to face with that of the Swiss and Landsknechts, the system of the "long pike."

A series of victories ranging from Morgarten (1315) to Nancy (1477) had made the Swiss the most renowned infantry in Europe. Originally their struggles with would-be oppressors had taken the form, often seen elsewhere, of arraying solid masses of men, united in purpose and fidelity to one another rather than by any material or tactical cohesion. Like the men of Bruges at Courtrai, the Swiss had the advantage of broken ground, and the still greater advantage of being opposed by reckless feudal cavalry. Their armament at this stage was not peculiar—vouges, pikas, halberds and spears—though they were specially adept in the use of the two-handed sword. But as time went on the long pike (said to have originated in Savoy or the Milanese about 1330)

<sup>1</sup> As for instance when thirty men-at-arms "cut out" the Capital de Buch from the midst of his army at Cocherel.

<sup>2</sup> This tendency of the French military temperament reappears at almost every stage in the history of armies.

*Burgher  
militias.*

*The  
Wagen-  
burg.*

*The Swiss.*

became more and more popular until at last on the verge of their brief ascendancy (about 1475-1515) the Swiss armed as much as one quarter of their troops with it. The use of firearms made little or no progress amongst them, and the Swiss mercenaries of 1480, like their forerunners of Morgarten and Sempach, fought with the *arme blanche* alone. But in a very few years after the Swiss nation had become soldiers of fortune *en masse*, the more open lands of Swabia entered into serious and bitter competition with them. From these lands came the Landsknechts, whose order was as strong as, and far less unwieldy than, that of the Swiss, whose armament included a far greater proportion of firearms, and who established a regimental system that left a permanent mark on army organization. The Landsknecht was the prototype of the infantryman of the 16th and 17th centuries, but his right to indicate the line of evolution had to be wrung from many rivals.

The year 1480 indeed was a turning-point in military history. Within the three years preceding it the battles of Nancy and Guinegate had destroyed both the old feudalism of Charles the Bold and the new cavalry tactics of the French gendarmierie. The former was an anachronism, while the latter, when the great war came to an end and there was no longer either a national impulse or a national leader, had lapsed into the old vices of ransom and plunder. With these, on the same fields, the *franc-archer* system of infantry tactics perished ignominiously. It rested, as we know, on the principle that the fire of the infantry was to be combined with and completed by the shock of the gendarmierie, and when the latter were found wanting as at Guinegate, the masses of archers and arblasters, which were only feebly supported by a few handfuls of pikemen and halberdiers, were swept away by the charge of some heavy batallions of Swabian and Flemish pikemen.

Guinegate had destroyed both the old feudalism of Charles the Bold and the new cavalry tactics of the French gendarmierie. The former was an anachronism, while the latter, when the great war came to an end and there was no longer either a national impulse or a national leader, had lapsed into the old vices of ransom and plunder. With these, on the same fields, the *franc-archer* system of infantry tactics perished ignominiously. It rested, as we know, on the principle that the fire of the infantry was to be combined with and completed by the shock of the gendarmierie, and when the latter were found wanting as at Guinegate, the masses of archers and arblasters, which were only feebly supported by a few handfuls of pikemen and halberdiers, were swept away by the charge of some heavy batallions of Swabian and Flemish pikemen. Guinegate was the *début* of the Landsknecht infantry as Nancy was that of the Swiss, and the lesson could not be misread. Louis XI. indeed hanged some of his *franc-archers* and dismissed the rest, and in their place raised "bands" of regular infantry, one of which bore for the first time the historic name of *Picardie*. But these "bands" were not self-contained. Armed for the most part with *armes de jet* they centred on the 6000 Swiss pikemen whom Louis XI., in 1480, took into his service, and for nearly fifty years thereafter the French foot armies are always composed of two elements, the huge batallions of Swiss or Landsknechts,<sup>1</sup> armed exclusively with the long pike (except for an ever-decreasing proportion of halberts, and a few arquebuses), and for their support and assistance, French and mercenary "bands."

The Italian wars of 1494-1544, in which the principles of fire and shock were readjusted to meet the conditions created by firearms, were the nursery of modern infantry. The combinations of Swiss, Landsknechts, Spanish "tercios" and French "bands" that figured on the battlefields of the early 16th century were infinitely various. But it is not difficult to find a thread that runs through the whole.

The essence of the Swiss system was solidity. They arrayed themselves in huge oblongs of 5000 men and more, at the corners of which, like the tower bastions of a 16th-century fortress, stood small groups of arquebusiers.

The Landsknechts and the Romagnols of Italy, imitated and rivalled them, though as a rule developing more fire and less depth. At this stage solidity was every-thing and fire-power nothing. At Fornuovo (1495) the mass of arquebusiers and arblasters in the French army did little or nothing; it was the Swiss who were the *l'espérance de l'ost*. At Agnadello or Vaillà in 1509 the ground and the "encounter-battle" character of the engagement gave special chances of effective employment to the arquebusiers on either side. Along the front the Venetian marksmen, secure behind a bank, picked off the leaders of the enemy as they came near. On the outer flank of the battle the bands of Gascon arquebusiers, which would otherwise have been relegated to an unimportant place in the general line of battle, lapped round the enemy's flank

<sup>1</sup> The term *landsknecht*, it appears, was not confined to the right bank of the Rhine. The French "lansquenets" came largely from Alsace, according to General Hardy de Perini. In the Italian wars Francis I. had in his service a famous corps called the "black bands" which was recruited in the lower Rhine countries.

in broken ground and produced great and almost decisive effect. But this was only an afterthought of the king of France and Bayard. In the rest of the battle the huge masses of Swiss pikemen were thrown upon the enemy much as the old feudal cavalry had been, regardless of ditches, orchards and vineyards.

Then for a moment the problem was solved, or partially solved, by the artillery. From Germany the material, though not—at least to the same extent—the principle, of the *wagenburg* penetrated, in the first years of the 16th century, to Italy and thence to France. Thus by degrees a very numerous and exceedingly handy light artillery—"carts with gones," as they were called in England—came into play on the Italian battlefields, and took over from the dying *franc-archer* system the work of preparing the assault by fire. For mere skirmishing the Swiss and Landsknechts had arquebusiers enough, without needing to call on the masses of Gascons, &c., and *pari passu* with the development of this artillery, the "bands," other than Swiss and Landsknechts, began to improve themselves into pikemen and halberdiers. At Ravenna (1512) the bands of Gascony and Picardy, as well as the French *aventuriers* (the "bands of Piedmont," afterwards the second senior regiment of the French line) fought in the line of battle shoulder to shoulder with the Landsknechts. On this day the fire action of the new artillery was extraordinarily murderous, ploughing lanes in the immobile masses of infantry. At Marignan the French gendarmierie and artillery, closely and skilfully combined, practically destroyed the huge masses of the Swiss, and so completely had "infantry" and "fire" become separate ideas that on the third day of this tremendous battle we find even the "bands of Piedmont" cutting their way into the Swiss masses.

But from this point the lead fell into the hands of the Spaniards. These were originally swift and handy light infantry, capable—like the Scottish Highlanders at Prestonpans and Falkirk long afterwards—of sliding under the forest of pikes and breaking into the close-locked ranks with buckler and stabbing sword. For troops of this sort the arquebus was an ideal weapon, and the problem of self-contained infantry was solved by Gonsalvo de Cordoba, Pescara and the great Spanish captains of the day by intercalating small closed bodies of arquebusiers with rather larger, but not inordinately large, bodies of pikes. These arquebusiers formed separate, fully organized sections of the infantry regiment. In close defence they fought on the front and flanks of the pikes, but more usually they were pushed well to the front independently, their speed and excellent fire discipline enabling them to do what was wholly beyond the power of the older type of firing infantry—to take advantage of ground, to run out and reopen fire during a momentary pause in the battle of lance and pike, and to run back to the shelter of their own closed masses when threatened by an oncoming charge. When this system of tactics was consecrated by the glorious success of Pavia (1525), the "cart with gones" vanished and the system of fighting everywhere and always "at push of pike" fell into the background.

The lessons of Pavia can be read in Francis I.'s instructions to his newly formed Provincial (militia) Legions in 1534 and in the battle of Cerisolas ten years later. The "legion" was ordered to be composed of six "bands"—batallions we should call them now, but in those days the term "batallion" was consecrated to a gigantic square of the Swiss type—each of 800 pikes (including a few halberts) and 200 arquebusiers. The pikes, 4800 strong, of each legion were grouped in one large batallion, and covered on the front and flanks by the 1200 arquebusiers, the latter working in small and handy squads. These "legions" did not of course count as good troops, but their organization and equipment, designed deliberately in peace time, and not affected by the coming and going of soldiers of fortune, represent therefore the theoretically perfect type for the 16th century. Cerisolas represents the system in practice, with veteran regular troops. On the side of the French most of the arquebusiers were grouped on the right wing, in a long irregular line of companies or strong squads, supported at a moderate distance by companies or small batallions of "corselets" (pikes of the French bands of Picardy and Piedmont); the rest of the line of battle was composed of Landsknechts, &c., similarly arrayed, except that the arquebusiers were on the flanks and immediate front of the "corselets" and behind

The long pike.

The Spanish infantry and the arquebus.

the arquebuses and corselets of the right wing came a Swiss monster of the old type. On the imperial side of the Landsknechts, Spanish with its due proportion of pikes and "shot." The course of the battle demonstrated both the active tactical power of the new form of fire-action and the solidity of the pike nucleus, the former in the attack and defence of hills, woods and localities, the latter in an episode in which a Spanish battalion, after being ridden through from corner to corner by the French gendarmes, continued on its way almost unchecked and quite unbroken. This combination of arquebuses supported by corselets in first line and corselets with a few arquebusers in second, reappeared at Renty (1554), and St Quentin (1557), and was in fact the typical disposition of infantry from about 1530 to 1600.

By 1550, then, infantry had entirely ceased to be an auxiliary arm. It contained within itself, and (what is more important) within its regimental units, the power of fighting effectively and decisively both at close quarters and at a distance—the principal characteristic of the arm to-day. It had, further, developed a permanent regimental existence, both in Spain and in France, and in the former country it had progressed so far from the "residue" state that young nobles preferred to trail a pike in the ranks of the foot to service in the gendarmerie or light horse. The service battalions were kept up to war strength by the establishment of depots and the preliminary training there of recruits. In France, apart from Picardie and the other old regiments, every temporary regiment, on disbandment, threw off a depot company of the best soldiers, on which nucleus the regiment was reconstituted for the next campaign. Moreover, the permanent establishment was augmented from time to time by the colonel-general of the foot "giving his white flag" to temporary regiments.

The organization of the French infantry in 1570 presents some points of interest. The former broad classification of *au delà* and *en deça des monts* or "Picardie" and "Piedmont," representing the home and Italian armies, had disappeared, and instead the whole of the infantry, under one colonel-general, and France, under the regiments of Picardie, Piedmont and France, was divided into each of which had its own colour and its own colours. Besides these, three newer corps were *créés*, *mis en la Roy*—"Champagne," practically belonging to the Guescliers, and two others formed out of the once enormous regiment of Marshal de Cosse-Briassac. At the end of a campaign all temporary regiments were disbanded, but in imitation of the Spanish depot system, each, on disbandment, threw off a depot company of picked men who formed the nucleus for the next year's augmentation. The regiment consisted of 10-16 "ensigns" or companies, each of about 150 pikemen and 50 arquebusers. Each company had a proprietary captain, the owners of the first two companies being the colonel-general and the colonel (*mestre de camp*). The senior captain was called the sergeant-major, and performed the duties of a second in command and an adjutant or brigade-major. Unlike the regimental commander, the sergeant-major was always mounted, and it is recorded that one officer newly appointed to the post incurred the ridicule of the army by dismounting to speak to the king! "Some veteran officers," wrote a contemporary, "are inclined to think that the regimental commander should be mounted as well as the sergeant-major." The regiment was as a rule formed for parade and battle either in line to deep or in "battalion" (*i.e.*, mass), Swiss fashion. The captain occupied the front, the ensigns with the company colours the centre, and the lieutenants the rear place in the file. The sergeants, armed with the halbert, marched on each side of the battalion or company. Though the musket was gradually being introduced, and had powerful advocates in Marshal Strozzi and the duke of Guise, the bulk of the "shot" still carried the arquebus, the calibre of which had been, thanks to Strozzi's efforts, standardized (see CALIVER) so that all the arms took the same sizes of ball. The pikeman had half-armor and a 14-ft. pike, the arquebuser bore the fire-arm a sword which he was trained to use in the manner of the former Spanish light infantry. The arquebusers were arrayed in 3 ranks in front of the pikes or in 2 deep files on either flank.

The wars in which this system was evolved were wars for prestige and aggrandizement. They were waged, therefore, by mercenary soldiers, whose main object was to live, and who were officered either by men of their own stamp, or by nobles eager to win military glory. But the Wars of Religion raised

<sup>1</sup> This practice of "maintenance" on a large scale continued to exist in France long afterwards. As late as the battle of Lens (1648) we find figuring in the king of France's army three "regiments of the House of Condé."

questions of life and death for the Frenchmen of either faith, and such public opinion as there was influenced the method of operations so far that a decision and not a prolongation of the struggle began to be the desired end of operations. Hence in those wars the relatively immobile "battalion" of pikes diminishes in importance and the arquebusers and musketeers grow more and more efficient. Armies, too, became smaller, and marched more rapidly. Encounter-battles became more frequent than "pitched" battles, and in these the musketeer was at a great advantage. Thus by 1600 the proportions between pikes and musketeers in the French army had come to be 6 pikes to 4 muskets or arquebuses, and the *bataillon de combat* or brigade was normally no more than 1200 strong. In the Netherlands, however, the war of consciences was fought out between the best regular army in the world and burgher militias. Even the French *fantassins* were second in importance to the Spanish *soldados*. The latter continued to hold the pre-eminent position they had gained at Pavia.<sup>2</sup> They improved the arquebus into the musket, a heavier and much more powerful weapon (fired from a rest) which could disable a horse at 500 paces.

At this moment the professional soldier was at the high-water mark of his supremacy. The musket was too complicated to be rapidly and efficiently used by any but a highly trained man; the pike, probably because it had now to protect two or three ranks of "shot" in front of the leading rank of pikemen, as well as the pikemen themselves, had grown longer (up to 18 ft.); and drill and manoeuvre had become more important than ever, for in the meantime cavalry had mostly abandoned the massive armour and the long lance in favour of half-armor and the pistol, and their new tactics made them both swifter to charge groups of musketeers and more deadly to the solid masses of pikemen. This superiority of the regular over the irregular was most conspicuously shown in Alva's war against the Netherlands patriots. Desperately as the latter fought, Spanish captains did not hesitate to attack patriot armies ten times their own strength. If once or twice this contempt led them to disaster, as at Helligerlee in 1568 (though here, after all, Louis of Nassau's army was chiefly composed of trained mercenaries), the normal battle was of the Jemingen type—seven *soldados* dead and seven thousand rebels.

As regards battles in the open field, such results as these naturally confirmed the "Spanish system" of tactics. The Dutch themselves, when they evolved reliable field armies, copied it with few modifications, and by degrees it was spread over Europe by the professional soldiers on both sides. There was plenty of discussion and readjustment of details. For example, the French, with their smaller battalions and more rapid movements, were inclined to disparage both the cuirass and the pike, and only unwillingly hampered themselves with the long heavy Spanish musket, which had to be fired from a rest. In 1600, nearly fifty years after the introduction of the musket, this most progressive army still deliberately preferred the old light arquebus, and only armed a few selected men with the larger weapons. On the other hand, the Spaniards, though supreme in the open, had for the most part to deal with desperate men behind fortifications. Fighting, therefore, chiefly at close quarters with a fierce enemy, and not disposing either of the space or of the opportunity for "manoeuvre-battles," they sacrificed all their former lightness and speed, and clung to armour, the long pike and the heavy 2½ oz. bullet. But the principles first put into practice by Gonsalvo de Cordoba, the combination, in the proportions required in each case, of fire and shock elements in every body of organized infantry however small, were maintained in full vigour, and by now the superiority of the infantry arm in method, discipline and technique, which had long before made the Spanish nobles proud to trail a pike in the ranks, began to impress itself on other nations. The relative value of horse and foot became a subject for expert

<sup>2</sup> Even as late as 1645 a battalion of infantry in England was called a "tercio" or "tertia" (see ARMY; Spanish army).



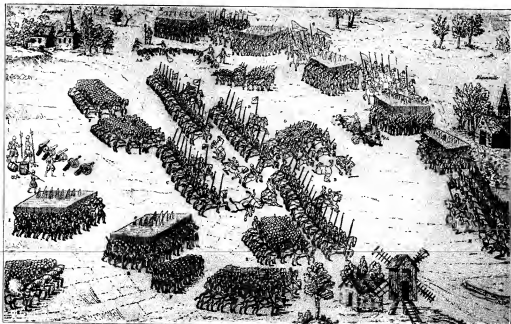

DREUX—1562.

(From Hardy de Poyssi's *Batailles Françaises*, by permission.)

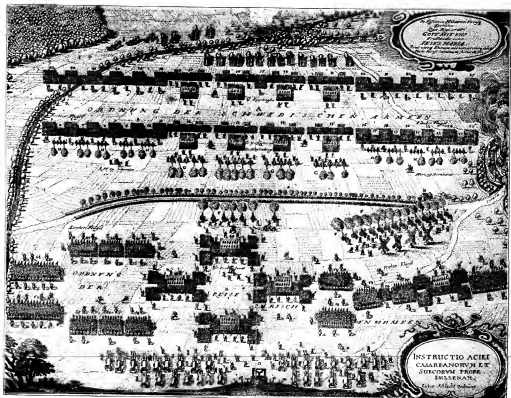

LÜTZEN—1632.

INSTRUCIO ACIEI  
CASABANORVM ET  
SVCORVM FRIS.  
EMMAN.

WELLINGTON.

EVOLUTIONS OF THE COLUMN AND SKIRMISHERS.

PRUSSIAN COLLENS, 1740.

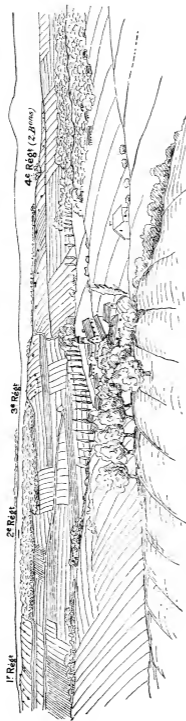

VIONVILLE DE CISSEY'S COUNTER-ATTACK (SEEN FROM REAR OF PRUSSIAN 38TH BRIGADE).

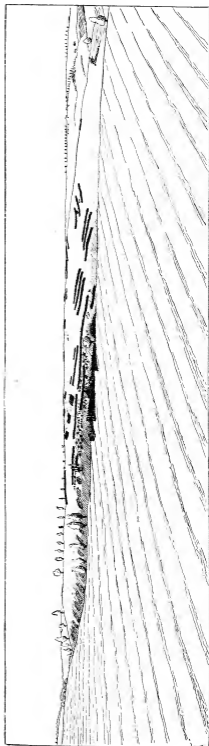

APPROACH-MARCH UNDER ARTILLERY FIRE, FRENCH PRINCIPLES (FROM ENEMY'S ARTILLERY POSITION).

(From *Revue d'Ingenieur*, 1899.)

discussion instead of an axiom of class pride. The question of cavalry *versus* infantry, hotly disputed in all ages, is a matter affecting general tactics, and does not come within the scope of the present article (see further CAVALRY). Expert opinion indeed was still on the side of the horsemen. It was on their cavalry, with its speed, its swords and its pistols that the armies of the 16th century relied in the main to produce the decision in battle. Sir Francis Vane, speaking of the battle of Nieupoort in 1600, says, "Whereas most commonly in battles the success of the foot dependeth on that of the horse, here it was clean contrary, for so long as the foot held good the horse could not be beaten out of the field." The "success" of the foot in Vane's eyes is clearly resistance to disintegration rather than ability to strike a decisive blow.

It must be remembered, however, that Vane is speaking of the Low Countries, and that in France at any rate the solidity which saved the day at Nieupoort was less appreciated than the *elan* which had won so many smart engagements in the Wars of Religion. Moreover, it was the *offensive*, the decision-compelling faculty of the foot that steadily developed during the 17th century. To this, little by little, the powers of passive resistance to which Vane did homage, valuable as they were, were sacrificed, until at last the long pike disappeared altogether and the firearm, provided with a bayonet, was the uniform weapon of the foot-soldier. This stage of infantry history covers almost exactly a century. As far as France was concerned, it was a natural evolution. But the acceptance of the principle by the rest of the military world, imposed by the genius of Gustavus Adolphus, was rather revolution than evolution.

In the army which Louis XIII. led against his revolted barons of Anjou in 1620, the old regiments (*les vieux*—Picardie, Piedmont, &c.) seem to have marched in an open chequer-wise formation of companies which is interesting not only as a deliberate imitation of the Roman legion (all soldiers of that time, in the prevailing confusion of tactical ideas, sought guidance in the works of Xenophon, Aelian and Vegetius), but as showing that flexibility and handiness was not the monopoly of the Swedish system that was soon to captivate military Europe. The formations themselves are indeed found in the Spanish and Dutch armies, but the equipment of the men, and the general character of the operations in which they were engaged, probably failed to show off the advantages of this articulation, for the generals of the Thirty Years' War, trained in this school, formed their infantry into large battalions (generally a single line of masses). Experience certainly gave the troops that used these unwieldy formations a relatively high manœuvring capacity, for Tilly's army at Breitenfeld (1631) "changed front half-left" in the course of the battle itself. But the manœuvring power of the Swedes was higher still. Each party represented one side of the classical revival, the Swedes the Roman three-line manipular tactics, the Imperialists and Leaguers those of the Greek line of phalanxes. The former, depending as it did on high *moral* in the individual foot-soldier, was hardly suitable to such a congeries of mercenaries as those that Wallenstein commanded, and later in the Thirty Years' War, when the old native Swedish and Scottish brigades had been annihilated, the Swedish infantry was little if at all better than the rest.

But its tactical system, sanctified by victory, was eagerly caught up by military Europe. The musket, though it had finally driven out the arquebus, had been lightened by Gustavus Adolphus so far that it could be fired without a rest. Rapidity in loading had so far improved that a company could safely be formed six deep instead of ten, as in the Spanish and Dutch systems. Its fire power was further augmented by the addition of two very light field-guns to each battalion; these could inflict loss at twice the effective range of the shortened musket. Above all, Gustavus introduced into the military systems of Europe a new discipline based on the idea of exact performance of duty, which made itself felt in every part of the service, and was a welcome substitute for the former easy-going methods

of regimental existence.<sup>1</sup> The adoption of Swedish methods indeed was facilitated by the disrepute into which the older systems had fallen. Men were beginning to see that armies raised by contract for a few months' work possessed inherent vices that made it impossible to rely upon them in small things. Courage the mercenary certainly possessed, but his individual sense of honour, code of soldierly morals, and sometimes devotion to a particular leader did not compensate for the absence of a strong motive for victory and for his general refractoriness in matters of detail, such as march-discipline and punctuality, which had become essential since the great Swedish king had reintroduced order, method and definiteness of purpose into the conduct of military operations. In the old-fashioned masses, moreover, individual weaknesses, both moral and physical, counted for little or were suppressed in the general soldierly feeling of the whole body. But the six-deep line used by Gustavus demanded more devotion and exact obedience in the individual and a more uniform method of drill and handling arms. So shallow an order was not strong enough, under any other conditions, to resist the shock of cavalry or even of pikemen. Indeed, had not the cavalry (who, after Gustavus's death, were uninspired mercenaries like the rest) ceased to charge home in the fashion that Gustavus exacted of them, it is possible that the new-fashioned line would not have stood the test, and that infantry would have reverted to the early 16th-century type.

The problem of combining the maximum of fire power with the maximum of control over the individual firer was not fully solved until 1740, but the necessity of attempting the problem was realised from the first. In the Swedish **The Great** army, before it was corrupted by the atmosphere **Rebellion** of the Thirty Years' War, duty to God and to country were the springs of the punctual discipline, in small things and in great, which made it the most formidable army, unit for unit, in the world. In the English Civil War (in which the adherents of the "Swedish system" from the first ousted those of the "Dutch") the difficulty was more acute, for although the mainsprings of action were similar, the technical side of the soldier's business—the regimental organization, drill and handling of arms—had all to be improvised. Now in the beginning the Royalist cavalry was recruited from "gentlemen that have honour and courage and resolution"; later, Cromwell raised a cavalry force that was even more thoroughly imbued with the spirit of duty, "men who made some conscience of what they did," and throughout the Civil War, consequently, the mounted arm was the queen of the battlefield.

The Parliamentary foot too "made some conscience of what it did," more especially in the first years of the war. But its best elements—the drilled townsmen—were rather of a defensive than of an offensive character, and towards the close of the struggle, when the foot on both sides came to be formed of professional soldiers, the defensive element decreased, as it had decreased in France and elsewhere. The war was like Gustavus's German campaign, one of rapid and far-ranging marches, and the armoured pikeman had either to shorten his pike and to cast off his armour or to be left at home with the heavy artillery (see Firth's *Cromwell's Army*, ch. iv.). Fights "at push of pike" were rare enough to be specially mentioned in reports of battles. Sir James Turner says that in 1657, when he was commissioned with others to raise regiments for the king of Denmark, "those of the Privy Council would not suffer one word to be mentioned of a pike in our Commissions." It was the same with armour. In 1658 Lockhart, the commander of the English contingent in France, specially asked for a supply of cuirasses and headpieces for his pikemen in order to impress his allies. In 1671 Sir James Turner says, "When we see battalions of pikes, we see them everywhere naked unless it be in the Netherlands." But a small proportion of pikes was still held to be necessary by experienced soldiers, for as yet the socket bayonet had not been invented, and there was still cavalry in Europe that could be trusted to ride home.

<sup>1</sup> In France it is recorded that the *Gardes françaises*, when warned for duty at the Louvre, used to stroll thither in twos and threes.

While such cavalry existed, the development of fire power was everywhere hindered by the necessity of self-defence. On the other hand the hitherto accepted defensive means militated against efficiency in many ways, and about 1670, when Louis XIV. and Louvois were fashioning the new standing army that was for fifty years the model for Europe, the problem was how to improve the drill and efficiency of the musketeers so far that the pikes could be reduced to a minimum. In 1680 the firelock was issued instead of the matchlock to all grenadiers and to the four best shots in each French Company. The bayonet—in its primitive form merely a dagger that was fixed into the muzzle of the musket—was also introduced, and the pike was shortened. The proportion of pikes to muskets in Henry IV.'s day, 2 to 1 or 3 to 2, and in Gustavus's 2 to 3, had now fallen to 1 to 3.

The day of great causes that could inspire the average man with the resolution to conquer or die was, however, past, and the "shallow order" (*l'ordre mince*), with all its demands on the individual's sense of duty, had become an integral part of the military system. How then was the sense of duty to be created? Louis and Louvois and their contemporaries sought to create it by taking raw recruits in batches, giving them a consistent training, quartering them in barracks and uniforming them. Henceforward the soldier was not a unit, self-taught and free to enter the service of any master. He had no existence as a soldier apart from his regiment, and within it he was taught that the regiment was everything and the individual nothing. Thus by degrees the idea of implicit obedience to orders and of *esprit de corps* was absorbed. But the self-respecting Englishman or the quick-ardent Frenchman was not the best raw material for quasi-automatic regiments, and it was not until an infinitely more rigorous system of discipline was applied to an unimaginative army that the full possibilities of this enforced sense of duty were realized.

The method of delivering fire originally used by the Spaniards, in which each man in succession fired and fell back to the rear of the file to reload, required for its continued and exact performance a degree of coolness and individual smartness which was probably rarely attained in practice. This was not of serious moment when the "shot" were simple auxiliaries, but when under Gustavus the offensive idea came to the front, and the bullets of the infantry were expected to do something more than merely annoy the hostile pikemen, a more effective method had to be devised. First, the handiness of the musket was so far improved that one man could reload while five, instead of as formerly ten, fired. Then, as the enhanced rate of fire made the file-firing still more disorderly than before, two ranks and three were set to fire "volves" or "salvees" together, and before 1640 it had become the general custom for the musketeers to fire one or two volleys and then, along with the pikemen, to "fall on." It was of course no mean task to charge even a disordered mass of pikes with a short sword or a clubbed musket, and usually after a few minutes the combatants would drift apart and the musketeers on either side would keep up an irregular fire until the officers urged the whole forward for a second attempt.

With the general disuse of the lance, the disappearance of the personal motives that formerly made the cavalryman charge home, the adoption of the flintlock musket and the invention of the fixed bayonet (the fixing of which did not prevent fire being delivered, all respect for retreating the pike vanished, and from about 1700 to the present day, therefore, the invariable armament of infantry has been the musket (or rifle) and bayonet. The manner of employing the weapons, however, changed but slowly. In the French army in 1688, for instance (15 years before the abolition of the pike), the old file-fire was still officially recognized, though rarely employed, the more usual method being for the musketeers in groups of 12 to 30 men to advance to the front and deliver their volleys in turn, these groups corresponding in size to one of the musketeer wings (*manches*) of a company or double company. But the fire and shock action of infantry were still distinct, the idea of "push of pike" remained, the bayonet (as at Marsaglia) taking the place of the pike, and musketry methods were still throughout the War of the Spanish Succession somewhat half-hearted and tentative. Two generals so entirely different in genius and temperament as Saxe and Catinat could agree on this point, that attacking infantry ought to close with the enemy, bayonets fixed, without firing a shot. Catinat's orders to his army in 1690, indeed, seem rather to indicate that he expected his troops to endure the enemy's first fire without replying in order that their own volley, when it was at last delivered at a few paces distance, should be as murderous as possible, while Saxe, who was a dreamer as well as a

practical commander of troops, advocated the pure bayonet charge. But the fact that is common to both is the relative ineffectiveness of musketry before the Prussian era, whether this musketry was delivered by groups of men running forward and returning in line or even by companies in a long line of battle.

This ineffectiveness was due chiefly to the fact that fire and movement were separate matters. The enemy's volley, that Catinat and others ordered their troops to endure without flinching, was sometimes (as at Fontenoy) absolutely crushing. But as a rule it inflicted an amount of loss that was not sufficient to put the advancing troops out of action, and experienced officers were aware that to halt to reply gave the enemy time to reload, and that once the fight became an interchange of partial and occasional volleys or a general *trahierie*, there was an end to the attack.

Meanwhile, the tactics of armies had been steadily crystallizing into the so-called "linear" form, which, as far as concerns the infantry, is simply two long lines of battalions (three, four or five deep) and gave the utmost possible development of fire-power. The object of the "line" was to break or beat down the opposing line in the shortest possible time, whether by fire action or shock action, but fire action was only decisive at so short a range that the principal volley could be followed immediately by a charge over a few score paces at most and the crossing of bayonets. Fire was, however, effective at ranges outside charging distance, especially from the battalion guns, and however the decision was achieved in the end, it was necessary to cross the zone between about 300 yds. and 50 yds. range as quickly as possible. It was therefore the business of the regimental officer to force his men across this zone before fire was opened. If, as Catinat recommended, decisive range was reached with every musket loaded and the troops well in hand, their fire when finally it was delivered might well be decisive. But in practice this rarely happened, and though here and there such expedients as a skirmishing line were employed to assist the advance by disturbing the enemy's fire the most that was hoped by the average colonel or captain was that in the advance fire should be opened as late as possible and that the officers should strive to keep in their hands the power of breaking off the fire-fight and pushing the troops forward again. Theorists were already proposing column formations for shock action, and initiating the long controversy between *l'ordre mince* and *l'ordre profonde*, but this was for the time being pure speculation. The linear system rested on the principle that the maximum weight of controlled fire at short range was decisive, and the practical problem of infantry tactics was how to obtain this. The question of *fire versus shock* had been answered in favour of the former, and henceforward for many years the question of *fire versus movement* held the first place. The purpose was settled, and it remained to discover the means.

This means was Prussian fire-discipline, which was elaborated by Leopold of Dessau and Frederick William I. and practically applied by Frederick the Great. It consisted first in the combination, instead of the alternation, of fire and movement, and secondly in the thorough efficiency of the fire in itself. But both these demanded a more stringent and technically more perfect drill than had ever before been imagined, or, for that matter, has ever since been attained. A hundred years before the steady drill of the Spanish veterans at Rocroi, who at the word of command opened their ranks to let the cannon fire from the rear and again closed them, impressed every soldier in Europe. But such drill as this was child's play compared with the Old Dessauer's.

On approaching the enemy the marching columns of the Prussians, which were generally open columns of companies 4 deep, wheeled in succession to the right or left (almost always to the right) and thus passed along the front of the enemy at a distance of 800-1200 yds. until the rear company had wheeled. Then the whole together (or in the case of a deployment to the left, in succession) wheeled into line facing the enemy. These movements, intervals and distances were preserved with proper precision, brought the infantry into two long well-ordered lines, and parade-ground precision was actually attained, thanks to remorseless drilling and to the reintroduction of the march in step to music. Of course such movements were best executed on a firm plain, and as far as possible the attack and defence of woods and villages was left to light infantry and grenadiers. But even in marshes and scrub, the line managed to manoeuvre with some

**Disuse of the pike.**

**Methods of fire before 1740.**

**Linear tactics.**

**Prussian fire discipline, 1740.**

approach to the precision of the barrack square.<sup>1</sup> Now, this precision allowed Frederick to take risks that no former commander would have dared to take. At Hohenfriedberg the infantry columns crossed a marshy stream almost within cannon shot of the enemy; at Kolin (though there this insolence was punished) the army filed past the Imperialist skirmishers within less than musket shot, and the climax of this daring was the "oblique order" attack of Leuthen. With this was bound up a fire discipline that was more extraordinary than any previous of manoeuvre. Before Hohenfriedberg the king gave orders that "pelotonfeuer" was to be opened at 200 paces from the enemy and continued up to 50 paces, when the line was to fall on with the bayonet. The possibility of this combination of fire and movement was the work of Leopold, who gave the Prussian infantry iron ramrods, and by sheer drill made the soldier a machine capable of delivering (with the flintlock muzzle-loading muskets, he observed) five volleys a minute. This *pelotonfeuer* or company volleys replaced the old fire by ranks practised in other armies. Fire began from the flanks of the battalion, which consisted of eight companies (for firing, 3 deep). When the right company commander gave "fire," the commander of No. 2 gave "ready," followed in turn by other companies up to the centre. The same process having been gone through on the left flank, by the time the two centre companies had fired the two flank companies were ready to recommence, and thus a continuous series of rolling volleys was delivered, at one or two seconds' interval only between companies. In attack this fire was combined with movement, each company in turn advancing a few paces after "making ready." In square, old-fashioned methods of fire were employed. Square was an indecisive and defensive formation, rarely used, and in the advance of the deployed line, the offensive and decision-seeking formation *par excellence*, the special Prussian fire-discipline gave Frederick an advantage of five shots to two against all opponents. The bayonet-attack, if the rolling volleys had done their work, was merely "presenting the cheque for payment" as a modern German writer puts it. The cheque had been drawn, the decision given, in the fire-fight.

For some years this method of infantry training gave the Prussians a decisive superiority in whatever order they fought.

**Leuthen.** But their enemies improved and also grew in numbers, while the Prussian army's resources were strictly limited. Thus in the Seven Years' War, after the two costly battles of Prague and Kolin (1757) especially, it became necessary to manoeuvre with the object of bringing the Prussian infantry into contact with an equal or if possible smaller portion of the enemy's line. If this could be achieved, victory was as certain as ever, but the difficulties of bringing about a successful manoeuvre were such that the classical "oblique order" attack was only once completely executed. This was at Leuthen, December 5th, 1757, perhaps the greatest day in the history of the Prussian army. Here, in a rolling plain country occasionally broken by marshes and villages, the "oblique order" was executed at high speed and with clockwork precision. Frederick's object was to destroy the left of the Austrian army (which far outnumbered his own) before the rest of their deployed line of battle could change front to intervene. His method was to place his own line, by a concealed flank march, opposite the point where he desired to strike, and then to advance, not in two long lines but in echelon of battalions from the right (see LEUTHEN). The echelon was not so deep but that each battalion was properly supported by the following one on its left (100 paces distance), and each, as it came within 200 yds. of the Austrian battalion facing it, opened its "rolling volleys" while continuing to advance; thus long before the left and most backward battalions were committed to the fight, the right battalions were crumbling the Austrian infantry units one by one from left to right. It was the same, without parade manoeuvres, when at last the Austrians managed to organize a line of defence about Leuthen village. Unable to make an elaborate change of front with the whole centre and right wing for want of time, they could do no more than crowd troops about Leuthen, on a short fighting front, and this crumbled in turn before the Prussian volleys.

One lesson of Leuthen that contemporary soldiers took to heart was that even a two-to-one superiority in numbers could not remedy want of manoeuvring capacity. It might be hoped

<sup>1</sup> About this time there was introduced, for resisting cavalry, the well-known hollow battalion square, which, replacing the former masses of pikes, represented up to the most modern times the defensive, as the line or column represented the offensive formation of infantry.

that with training and drill an Austrian battalion could be made equal to a Prussian one in the front-to-front fight, and in fact, as losses told more and more heavily on Frederick's army as years went on, the specific superiority of his infantry disappeared. From 1758 therefore, to the end of the war, there were no more Rossbachs and Leuthens. Superiority in efficiency through previous training having exhausted its influence, superiority in force through manoeuvre began to be the general's ideal, and as it was a more familiar notion to the average Prussian general, trained to manoeuvre, than to his opponent, whose idea of "manoeuvre" was to sidle carefully from one position to another, Prussian generalship maintained its superiority, in spite of many reverses, to the end. The last campaigns were indeed a war of positions, because Frederick had no longer the men available for forcing the Austrians out of them, and on many occasions he was so weak that the most passive defensive and the most elaborate entrenchments barely sufficed to save him. But whenever opportunity offered itself, the king sought a decisive success by bringing the whole of his infantry against part of the enemy's—the principle of Leuthen put in practice over a wider area and with more elastic manoeuvre methods. The long echelon of battalions directed against a part of the hostile line developed quite naturally into an irregular echelon of brigade columns directed against a part of the enemy's position. But the history of the "cordon system" which followed this development belongs rather to the subject of tactics in general than to that of infantry fighting methods. Within the unit the tactical method scarcely varied. In a battle each battalion or brigade fought as a unit in line, using company volleys and seeking the decision by fire.

In this, and in even the most minute details of drill and uniform, military Europe slavishly copied Prussia for twenty years after the Seven Years' War. The services of ex-Prussian officers were at a premium just as those of Gustavus's officers had been 150 years before. Military developments from all countries went to Potsdam or to the "Reviews" to study Prussian methods, with as simple a faith in their adequacy as that shown to-day by small states and half-civilized kingdoms who send military representatives to serve in the great European armies. And withal, the period 1763-1792 is full of tactical and strategical controversies. The principal of these, as regards infantry, was that between "fire" and "shock" revived about 1710 by Folard, and about 1780 the American War of Independence complicated it by introducing a fresh controversy between *skirmishing* and *close order*. As to the first, in Folard's day as in Frederick's, fire action at close range was the deciding factor in battle, but in Frederick's later campaigns, wherein he no longer disposed of the old Prussian infantry and its swift mechanical fire-discipline, there sprang up a tendency to trust to the bayonet for the decision. If the (so-called) Prussian infantry of 1762 could be in any way brought to close with the enemy, it had a fair chance of victory owing to its leaders' previous dispositions, and then the advocates of "shock," who had temporarily been silenced by Mollwitz and Hohenfriedberg, again took courage. The ordinary line was primarily a formation for fire, and only secondarily or by the accident of circumstances for shock, and, chiefly perhaps under Saxe's influence, the French army had for many years been accustomed to differentiate between "linear" formations for fire and "columnar" for attack—thus reverting to 16th-century practice. While, therefore, the theoreticians pleaded for battalion columns and the bayonet or for line and the bullet, the practical soldier used both. Many forms of combined line and column were tried, but in France, where the question was most assiduously studied, no agreement had been arrived at when the advent of the skirmisher further complicated the issues.

In the early Silesian wars, when armies fought in open country in line order, the outpost service scarcely concerned the line troops sufficiently to cause them to get under arms at the sound of firing on the sentry line. It was performed by irregular light troops, recruited from wild characters of all nations, who were also charged with the preliminary skirmishing necessary to clear up the situation before

the deployment of the battle-army, but once the line opened fire their work was done and they cleared away to the flanks (generally in search of plunder). Later, however, as the preliminary manoeuvring before the battle grew in importance and the ground taken into the manoeuvring zone was more varied and extended than formerly, light infantry was more and more in demand—in a "cordon" defensive for patrolling the intervals between the various detachments of line troops, in an attack for clearing the way for the deployment of each column. Yet in all this there was no suggestion that light troops or skirmishers were capable of bringing about the decision in an armed conflict. When Frederick gained a durable peace in 1763 he dismissed his "free battalions" without mercy, and by 1764 not more than one Prussian soldier in eleven was an "irregular," either of horse or foot.<sup>1</sup>

But in the American War of Independence the line was pitted against light infantry in difficult country, and the British and French officers who served in it returned to Europe full of enthusiasm for the latter. Nevertheless, their light infantry was, unlike Frederick's, *selected line infantry*. The light infantry duties—skirmishing, reconnaissance, outposts—were grafted on to a thorough close-order training. At first these duties fell to the grenadiers and light companies of each battalion, but during the struggle in the colonies, the light companies of a brigade were so frequently massed in one battalion that in the end whole regiments were converted into light infantry. This combination of "line" steadiness and "skirmisher" freedom was the keynote of Sir John Moore's training system fifteen years later, and Moore's regiments, above all the 52nd, 43rd (now combined as the Oxfordshire Light Infantry) and 95th Rifles (Rifle Brigade), were the backbone of the British Army throughout the Peninsular War. At Waterloo the 52nd, changing front in line at the double, flung itself on the head and flank of the Old Guard infantry, and with the "rolling volleys" inherited from the Seven Years' War, shattered it in a few minutes. Such an exploit would have been absolutely inconceivable in the case of one of the old "free battalions." But the light infantry had not merely been levelled up to the line, it had surpassed it, and in 1815 there were no troops in Europe, whether trained to fight in line or column or skirmishers, who could rival the three regiments named, the "Light Division of Peninsular annals. For meantime the infantry organization and tactics of the old régime, elsewhere than in England, had been disintegrated by the flames of the French Revolution, and from their ashes a new system had arisen, which forms the real starting-point of the infantry tactics of to-day.

The controversialists of Louis XVI.'s time, foremost of whom were Guibert, Joly de Maizeroy and Menil Durand (see Max Jähns, *Gesch. d. Kriegswissenschaften*, vol. iii.) were agreed that shock action should be the work of troops formed in column, but as to the results to be expected from shock action, the extent to which it should be facilitated by a previous fire preparation, and the formations in which fire should be delivered (line, line with skirmishers or "swarms") discussion was so warm that it sometimes led to wranglings in ladies' drawing-rooms and meetings in the duelling field. The drill-book for the French infantry issued shortly before the Revolution was a common-sense compromise, which in the main adhered to the Frederician system as modified by Guibert, but gave an important place in infantry tactics to the battalion "columns of attack," that had hitherto appeared only spasmodically on the battlefields of the French army and never elsewhere. This, however, and the quick march (100 paces to the minute instead of the Frederician 75) were the only prescriptions in the drill-book that survived the test of a "national" war, to which within a few years it was subjected (see FRENCH REVOLUTIONARY WARS). The rest, like the "linear system" of organization and manoeuvre to which it belonged (see ARMY, §§ 30-33; CONSCRIPTION, &c.) was ignored, and circumstances and the practical troop-leaders evolved by circumstances fashioned the combination of *close-order columns* and *loose-order skirmishers* which constituted essentially the new tactics of the Revolutionary and Napoleonic infantry.

The process of evolution cannot be stated in exact terms, more especially as the officers, as they grew in wisdom through experience, learned to apply each form in accordance with ground and circumstances, and to reject, when unsuitable, not only the forms of the drill-book, but the forms proposed by themselves to replace those of the drill-book. But certain tendencies are easily discernible. The first tendency was towards the dissolu-

tion of all tactical links. The earlier battles were fought partly in line for fire action, partly in columns for the bayonet attack. Now the linear tactics depended on exact preservation of dressing, intervals and distances, and what required in the case of the Prussians years of steady drill at 76 paces to the minute was hardly attainable with the newly levied ardent Frenchmen marching at 100 to 120. Once, therefore, the line moved, it broke up into an irregular swarm of excited firers, and experience soon proved that only the troops kept out of the turmoil, whether in line or in column, were susceptible of manoeuvre and united action. Thus from about 1795 onwards the forms of the old régime, with half the troops in front in line of battle (practically in dense hordes of firers) and the other half in rear in line or line of columns, give way to new ones in which the skirmishers are fewer and the closed troops more numerous, and the decision rests no longer with the fire of the leading units (which of course could not compare in effectiveness with the rolling volleys of the drilled line) but with the bayonets of the second and third lines—the latter being sometimes in line but more often, owing to the want of preliminary drill, in columns. The skirmishers tended again to become pure light infantry, whose rôle was to prepare, not to give, the decision, and who fought in a thin line, taking every advantage of cover and marksmanship. In the Consulate and early Empire, indeed, we commonly find, in the closed troops destined for the attack, mixed line and column formations combining in themselves shock and controlled close-order fire—absolutely regardless of the skirmishers in front.

In sum, then, from 1792 to 1795 the fighting methods of the French infantry, of which so much has been written and said, are, as they have aptly been called, "horde-tactics." From 1796 onwards to the first campaigns of the Empire, on the other hand, there is an ever-growing tendency to combine skirmishers, properly so called, with controlled and well-closed bodies in rear, the first to prepare the attack to the best of their ability by individual courage and skill at arms, the second to deliver it at the right moment (thanks to their retention of manoeuvre formations), and with all possible energy (thanks to the cohesion, moral and material, which carried forward even the laggards). Even when in the long wars of the Empire the quality of the troops progressively deteriorated, infantry tactics within the regiment or brigade underwent no radical alteration. The actual formations were most varied, but they always contained two of the three elements, column, line and skirmishers. Column (generally two lines of battalions in columns of double-companies) was for shock or attack, line for fire-effect, and skirmishers to screen the advance, to scout the ground and to disturb the enemy's aim. Of these, except on the defensive (which was rare in a Napoleonic battle), the "column" of attack was by far the most important. The line formations for fire, with which it was often combined, rarely accounted for more than one-quarter of the brigade or division, while the skirmishers were still less numerous. Withal, these formations in themselves were merely fresh shapes for old ideas. The armament of Napoleon's troops was almost identical with that of Frederick's or Saxe's. Line, column and combinations of the two were as old as Fontenoy and were, moreover, destined to live for many years after Napoleon had fallen. "Horde-tactics" would not survive the earlier Revolutionary campaigns. Wherein then lies the change which makes 1792 rather than 1740 the starting-point of modern tactics?

The answer, in so far as so comprehensive a question can be answered from a purely infantry standpoint, is that whereas Frederick, disposing of a small and highly finished instrument, used its manoeuvre power and regimental efficiency to destroy one part of his enemy so swiftly that the other had no time to intervene, Napoleon, *Napoleon's infantry artillery tactics, 1807-1815.* who had numbers rather than training on his side, only delivered his decisive blow after he had "fixed" all bodies of the enemy which would interfere with his preparations—i.e. had set up a physical barrier against the threatened intervention. This new idea manifested itself in various forms.

*Tactical evolution in France 1792-1807.*

In strategy (*q.v.*) and combined tactics it is generally for convenience called "economy of force." In the domain of artillery (see ARTILLERY) it marked a distinction, that has revived in the last twenty years, between slow disintegrating fire and sudden and overpowering "fire-preparation." As regards infantry the effect of it was revolutionary. Regiments and brigades were launched to the attack to compel the enemy to defend himself, and fought until completely dissolved to force him to use up his reserves. "On s'engage partout et puis l'on voit" is Napoleon's own description of his *holding attack*, which in no way resembled the "feints" of previous generations. The self-sacrifice of the men thus engaged enabled their commander to "see," and to mass his reserves opposite a selected point, while little by little the enemy was hypnotized by the fighting. Lastly, when "the battle was ripe" a hundred and more guns galloped into close range and practically annihilated a part of the defender's line. They were followed up by masses of reserve infantry, often more solidly formed at the outset than the old Swiss masses of the 16th century.<sup>1</sup> If the moment was rightly chosen these masses, dissolved though they soon were into dense formless crowds, penetrated the gap made by the guns (with their arms at the slope) and were quickly followed by cavalry divisions to complete the enemy's defeat. Here, too, it is to be observed there is no true shock. The infantry masses merely "present the cheque for payment," and apart from surprises, ambushes and fights in woods and villages there are few recorded cases of bayonets being crossed in these wars. Napoleon himself said "Le feu est tout, le reste peu de chose," and though a mere plan of his dispositions suggests that he was the disciple of Folard and Menil Durand, in reality he simply applied "fire-power" in the new and grander form which his own genius imagined.

The problem, then, was not what it had been one hundred and fifty years before. The business of the attack was not to break down the passive resistance of the defence, but to destroy or evade its fire-power. No attack with the bayonet could succeed if this remained effective and unbroken, and no resistance (in the open field at least) availed when it had been mastered or evaded. In Napoleon's army, the circumstance that the infantry was (after 1807) incapable of carrying out its own fire-preparation forced the task into the hands of the field artillery. In other armies the 18th-century system had been discredited by repeated disasters, and the infantry, as it became "nationalized," was passing slowly through the successive phases of irregular lines, "swarms," skirmishers and line-and-column formations that the French Revolutionary armies had traversed before them—none of them methods that in themselves had given decisive results.

In all Europe the only infantry that represented the Frederician tradition and prepared its own charge by its own fire was the British. Eye-witnesses who served in the ranks of the French have described the sensation of powerlessness that they felt as their attacking column approached the line and watched it load and come to the present. The column stopped short, a few men cheered, others opened a ragged individual fire, and then came the volleys and the counter-attack that swept away the column. Sometimes this counter-stroke was made, as in the famous case of Busaco, from an apparently unoccupied ridge, for the British line, under Moore's guidance, had shaken off the Prussian stiffness, fought a deep instead of 3 and was able to take advantage of cover. The "blankness of the battlefield" noted by so many observers to-day in the South African and Manchurian Wars was fully as characteristic of Wellington's battles from Vimeiro to Waterloo, in spite of close order and red uniforms. But these battles were of the offensive-defensive type in the main, and for various reasons this type could not be accepted as normal by the rest of Europe. Nonchalance was not characteristic of the eager national levies of 1813 and 1814, and the Wellington method of

infantry tactics, though it had brought about the failure of Napoleon's last effort, was still generally regarded as an illustration of the already recognized fact that on the defensive the fire-power of the line, unless partly or wholly evaded by rapidity in the advance and manoeuvring power or mastered and extinguished by the fire-power of the attack, made the front of the defence impregnable. There was indeed nothing in the English tactics at Waterloo that, standing out from the incidents of the battle, offered a new principle of winning battles.

Nor indeed did Europe at large desire a fresh era of warfare. Only the French, and a few unofficial students of war elsewhere, realized the significance of the rejuvenated "line." For every one else, the later Napoleonic battle was the model, and as the great wars had ended before the "national" spirit had been exhausted or misused in wars of aggrandizement, infantry tactics retained, in Germany, Austria and Russia, the characteristic Napoleonic formations, lines of battalion or regimental columns, sometimes combined with linear formations for fire, and always covered by skirmishers. That these columns must in action dissolve sooner or later into dense irregular swarms was of course foreseen, but Napoleon had accustomed the world to long and costly fire-fighting as the preliminary to the attack of the massed reserves, and for the short remainder of the period of smooth-bore muskets, troops were always launched to the attack in columns covered by a thin line of picked shots as skirmishers. The moral power of the offensive "will to conquer" and the rapidity of the attack itself were relied upon to evade and disconcert the fire-power of the defence. If the attack failed to do so, the ranges at which infantry fire was really destructive were so small that it was easy for the columns to deploy or disperse and open a fire-fight to prepare the way for the next line of columns. And after a careful study of the battle of the Alma, in which the British line won its last great victory in the open field, Moltke himself only proposed such modifications in the accepted tactical system as would admit of the troops being deployed for defence instead of meeting attack, as the Russians met it, in solid and almost stationary columns. Fire in the attack, in fact, had come to be considered as chiefly the work of artillery, and as artillery, being an expensive arm, had been reduced during the period of military stagnation following Waterloo, and was no longer capable of Napoleonic feats, the attack was generally a bayonet attack pure and simple. Waterloo and the Alma were credited, not to fire-power, but to English solidity, and as Ardent du Picq observes, "All the peoples of Europe say 'no one can resist our bayonet attack if it is made resolutely'—and all are right. . . . Bayonet fixed or in the scabbard, it is all the same." Since the disappearance of the "dark impenetrable wood" of spears, the question has always turned on the word "resolute." If the defence cannot by any means succeed in mastering the resolution of the assailant, it is doomed. But the means (moral and material) at the disposal of the defence for the purpose of mastering this resolution were, within a few years of the Crimean War, revolutionized by the general adoption of the rifle, the introduction of the breech-loader and the revival of the "nation in arms."

Thirty years before the Crimea the flint-lock had given way to the percussion lock (see GUN), which was more certain in its action and could be used in all weathers. But fitting a copper cap on the nipple was not so simple a matter for nervous fingers as priming with a pinch of powder, and the usual rate of fire had fallen from the five rounds a minute of Frederick's day to two or three at the most. "Fire-power" therefore was at a low level until the general introduction<sup>2</sup> of the rifled barrel, which while further diminishing the rate of fire, at any rate greatly increased the range at which volleys were thoroughly effective. Artillery (see ARTILLERY, § 13), the fire-weapon of the

<sup>2</sup> Rifles had, of course, been used by corps of light troops (both infantry and mounted) for many years. The British Rifle Brigade was formed in 1800, but even in the Seven Years' War there were rifle-corps or companies in the armies of Prussia and Austria. These older rifles could not compare in rapidity or volume of fire with the ordinary firelock.

<sup>1</sup> Even when the hostile artillery was still capable of fire these masses were used, for in no other formation could the heterogeneous and ill-trained infantry of Napoleon's vassal states (which constituted half of his army) be brought up at all.

attack, made no corresponding progress, and even as early as the Alma and Inkerman (where the British troops used the Minie rifle) the dense columns had suffered heavily without being able to retaliate by "crossing bayonets." Fire power, therefore, though still the special prerogative of the defence, began to reassert its influence, and for a brief period the defensive was regarded as the best form of tactics. But the low rate of fire was still a serious objection. Many incidents in the American Civil War showed this, notably Fredericksburg, where the key of the Confederate position was held—against a simple frontal attack unsupported by effective artillery fire—by three brigades in line one behind the other, *i.e.* by a *six-deep* firing line. No less force could guarantee the "inviolability of the front," and even when, in this unnatural and uneconomical fashion, the rate of fire was augmented as well as the effective range, a properly massed and well-led attack in column (or in a rapid succession of deployed lines) generally reached the defender's position, though often in such disorder that a resolute counterstroke drove it back again. The American fought over more difficult country and with less previous drill-training than the armies of the Old World. The fire-power of the defence, therefore, that even in America did not always prevail over the resolution of the attack, entirely failed in the Italian war of 1859 to stop the swiftly moving, well-drilled columns of the French professional army, in which the national *elan* had not as yet been suppressed, as it was a few years later, by the doctrine that "the new arms found their greatest scope in the defence." The Austrians, who had pinned their faith to this doctrine, deserted their false gods, forbade any mention of the defensive in their drill-books, and brought back into honour the bayonet tactics of the old wars.

The need of artillery support for the attack was indeed felt (though the gunners had not as yet evolved any substitute for the case-shot preparation of Napoleon's time), but men remembered that artillery was used by the great captain, not so much to enable good troops to close with the enemy, as to win battles with masses of troops of an inferior stamp, and contemporary experience seemed to show that (if losses were accepted as inevitable) good and resolute troops could overpower the defence, even in face of the rifle and without the aid of case shot. But a revolution was at hand.

In 1861 Moltke, discussing the war in Italy, wrote, "General Niel attributes his victory (at Solferino) to the bayonet. But that does not imply that the attack was often followed by a hand-to-hand fight. In principle, when one makes a bayonet charge, it is because one supposes that the enemy will not await it. . . . To approach the enemy closely, pouring an efficacious fire into him—as Frederick the Great's infantry did—is also a method of the offensive." This method was applicable at that time for the Prussians alone, for they alone possessed a breech-loading firearm. The needle-gun was a rudimentary weapon in many respects, but it allowed of maintaining more than twice the rate of fire that the muzzle-loader could give, and, moreover, it permitted the full use of cover, because the firer could lie down to fire without having to rise between every round to load. Further, he could load while actually running forward, whereas with the old arms loading not only required complete exposure but also checked movement. The advantages of the Prussian weapon were further enhanced, in the war against Austria, by the revulsion of feeling in the Imperial army in favour of the pure bayonet charge in masses that had followed upon Magenta and Solferino.

With the stiffly drilled professional soldier of England, Austria and Russia the handiness of the new weapon could hardly have been exploited, for (in Russia at any rate) even skirmishers had to march in step. The Prussians were drilled nominally in accordance with regulations dating from 1812, and therefore suitable, if not to the new weapon, at least to the "swarm" fighting of an enthusiastic national army, but upon these regulations a mass of peace-time amendments had been superposed, and in theory their drill was as stiff as that of the Russians. But, as in France in 1793-1796, the composition of their army—a true "nation in arms"—and the character of the officers

evolved by the universal service system saved them from their regulations. The offensive spirit was inculcated as thoroughly as elsewhere, and in a much more practical form. Dietrich von Bülow's predictions of the future battle of "skirmishers" (meaning thereby a dense but irregular firing line) had captivated the younger school of officers, while King William and the veterans of Napoleon's wars were careful to maintain small columns (sometimes company's 1 columns of 240 rifles, but quite as often half-battalion and battalion columns) as a solid background to the firing line. Thus in 1866 (see SEVEN WEEKS' WAR), as Moltke had foreseen, the attacking infantry fought its way to close quarters by means of its own fire, and the bayonet charge again became, in his own words, "not the first, but the last, phase of the combat," immediately succeeding a last burst of rapid fire at short range and carried out by the company and battalion reserves in close order. Against the Austrians, whose tactics alternated between unprepared bayonet rushes by whole brigades and a passive slow-firing defensive, victory was easily achieved.

But immediately after Königgrätz the French army was served out with a breech-loading rifle greatly superior in every respect to the needle-gun, and after four years' tension France pitted breech-loader against breech-loader. Infantry in the war of 1870. In the first battles (see WÜRTH, and METZ; Battles) the decision-seeking spirit of the "armed nation," the inferior range of the needle-gun as compared with that of the chassepot, and the recollections of easy triumphs in 1864 and 1866, all combined to drive the German infantry forward to win every range before they began to make use of their weapons. Their powerful artillery would have sufficed of itself to enable them to do this (see SEDAN), had they but waited for its fire to take effect. But they did not, and they suffered accordingly, for, owing to the ineffectiveness of their rifle between 1000 and 400 yds. range, they had to advance, as the Austrians and Russians had done in previous wars, without firing a shot. In these circumstances their formations, whether line or column, broke up, and the whole attacking force dissolved into long irregular swarms. These swarms were practically composed only of the brave men, while the rest huddled together in woods and valleys. When, therefore, at last the firing line came within 400 or 500 yds. of the French, it was both severely tried and numerically weak, but the fact that it was composed of the best men only enabled it to open and to maintain an effective fire. Even then the French, highly disciplined professional soldiers that they were, repeatedly swept them back by counter-strokes, but these counter-strokes were subjected to the fire of the German guns and were never more than locally and momentarily effective. More and more German infantry was pushed forward to support the firing line, and, like its predecessors; each reinforcement, losing most of its unwilling men as it advanced over the shot-swept ground, consisted on arrival of really determined men, and closing on the firing line pushed it forward, sometimes 20 yds., sometimes 100, until at last rapid fire at the closest ranges dislodged the stubborn defenders. Bayonets (as usual) were never actually used, save in sudden encounters in woods and villages. The decisive factors were, first the superiority of the Prussian guns, secondly, heavy and effective fire delivered at short range, and above all the high moral of a proportion of resolute soldiers who, after being subjected for hours to the most demoralizing influences, had still courage left for the final dash. These three factors, in spite of changes in armament, rule the infantry attack of to-day.

#### INFANTRY TACTICS SINCE 1870

The net result of the Franco-German War on infantry tactics, as far as it can be summed up in a single phrase, was to transfer the fire-fight to the line of skirmishers. Henceforward the old and correct sense of the word "skirmishers" is lost. They have

<sup>1</sup> The Prussian company was about 250 strong (see below under "Organization"). This strength was adopted after 1870 by practically all nations which adopted universal service. The battalion had 4 companies.



nothing to do with a "skirmish," but are the actual organ of battle, and their old duties of feeling the way for the battle-formations have been taken over by "scouts." The last-named were not, however, fully recognized in Great Britain<sup>1</sup> till long after the war—not in fact until the war in South Africa had shown that the "skirmisher" or firing line was too powerful an engine to be employed in mere "feeling." In most European armies "combat patrols," which work more freely, are preferred to scouts, but the idea is the same.

The fire-fight on the line of skirmishers, now styled the *firing line*, is the centre of gravity of the modern battle. In 1870, owing to the peculiar circumstances of unequal armament, the "fire-fight" was insufficiently developed and uneconomically used, and after the war tacticians turned their attention to the evolution of better methods than those of Wörth and Gravelotte, Europe in general following the lead of Prussia. Controversy, in the early stages, took the form of a contest between "drill" and "individualism," irrespective of formations and technical details, for until about 1890 the material efficiency of the gun and the rifle remained very much what it had been in 1870, and the only new factor bearing on infantry tactics was the general adoption of a "national army" system similar to Prussia's and of rifles equal, and in some ways superior, to the chassepot. All European armies, therefore, had to consider equality in artillery power, equality in the ballistics of rifles, and equal intensity of fighting spirit as the normal conditions of the next battle of nations. Here, in fact, was an equilibrium, and in such conditions how was the attacking infantry to force its way forward, whether by fire or movement or by both? France sought the answer in the domain of artillery. Under the guidance of General Langlois, she re-created the Napoleonic hurricane of case-shot (represented in modern conditions by time shrapnel), while from the doctrine formed by Generals Maillard and Bonnal there came a system of infantry tactics derived fundamentally from the tactics of the Napoleonic era. This, however, came later; for the moment (viz. from 1871 to about 1890) the lead in infantry training was admittedly in the hands of the Prussians.

German officers who had fought through the war had seen the operations, generally speaking, either from the staff officer's or from the regimental officer's point of view. To the former and to many of the latter the most indelible impression of the battlefield was what they called *Massen-Drückebertum* or "wholesale skulking." The rest, who had perhaps in most cases led the brave remnant of their companies in the final assaults, believed that battles were won by the individual soldier and his rifle. The difference between the two may be said to lie in this, that the first sought a remedy, the second a method. The remedy was *drill*, the method *extended order*.

The extreme statement of the case in favour of drill pure and simple is to be found in the famous anonymous pamphlet *A Summer Night's Dream*, in which a return to the "old Prussian fire-discipline" of Frederick's day was offered as the solution of the problem, how to give "fire" its maximum efficacy. Volleys and absolutely mechanical obedience to word of command represent, of course, the most complete application of fire-power that can be conceived. But the proposals of the extreme close-order school were nevertheless merely pious aspirations, not so much because of the introduction of the breechloader as because the short-service "national" army can never be "drilled" in the Frederician sense. The proposals of the other school were, however, even more impracticable, in that they rested on the hypothesis that all men were brave, and that, consequently, all that was necessary was to teach the recruit how to shoot and to work with other individuals in the squad or company. Disorder of the firing line was accepted, not as an unavoidable evil, but as a condition in which individuality had full play, and

as dense swarm formations were quite as vulnerable as an ordinary line, it was an easy step from a thick line of "individuals" to a thin one. The step was, in fact, made in the middle of the war of 1870, though it was hardly noticed that extension only became practicable in proportion as the quality of the enemy decreased and the Germans became acclimatized to fire.

Between these extremes, a moderate school, with the emperor William (who had more experience of the human being in battle than any of his officers) at its head, spent a few years in groping for close-order formations which admitted of control without vulnerability, then laid down the principle and studied the method of developing the greatest fire-power of which short-service infantry was supposed capable, ultimately combined the "drill" and teaching ideas in the German infantry regulations of 1888, which at last abolished those of 1812 with their multitudinous amendments.

The necessity for "teaching" arose partly out of the new conditions of service and the relative rarity of wars. The soldier could no longer learn the ordinary rules of safety in action and comfort in bivouac by experience, and had to be taught. But it was still more the new conditions of fighting that demanded careful individual training. Of old, the professional soldier (other than the man belonging to light troops or the ground scout) was, roughly speaking, either so far out of immediate danger as to preserve his reasoning faculties, or so deep in battle that he became the unconscious agent of his inborn or acquired instincts. But the increased range of modern arms prolonged the time of danger, and although (judged by casualty returns) the losses to-day are far less than those which any regiment of Frederick's day was expected to face without flinching, and actual fighting is apparently spasmodic, the period in which the individual soldier is subjected to the fear of bullets is greatly increased. Zorndorf, the most severe of Frederick's battles, lasted seven hours, Vionville twelve and Wörth eleven. The battle of the future in Europe, without being as prolonged as Liao-Yang, Shaho and Mukden, will still be undecided twenty-four hours after the advanced guards have taken contact. Now, for a great part of this time, the "old Prussian fire-discipline," which above all aims at a rapid decision, will be not only unnecessary, but actually hurtful to the progress of the battle as a whole. As in Napoleon's day (for reasons presently to be mentioned) the battle must resolve itself into a preparative and a decisive phase.<sup>2</sup> In the last no commander could desire a better instrument (if such were attainable with the armies of to-day) than Frederick's forged steel machine, in which every company was a human mitrailleuse. But the preparatory combat not only will be long, but also must be graduated in intensity at different times and places in accordance with the commander's will, and the Frederician battalion only attained its mechanical perfection by the absolute and permanent submergence of the individual qualities of each soldier, with the result that, although it furnished the maximum effort in the minimum time, it was useless once it fell apart into ragged groups. The individual spirit of earnestness and intelligence in the use of ground by small fractions, which in Napoleon's day made the *combat d'usurc* possible, was necessarily unknown in Frederick's. On the other hand, graduation implies control on the part of the leaders, and this the method of irregular swarms of individual fighters imagined by the German progressives merely abdicates. At most such swarms—however close or extended—can only be tolerated as an evil that no human power can avert when the battle has reached a certain stage of intensity. Even the latest German *Infantry Training* (1906) is explicit on this point. "It must never be forgotten that the obligation of abandoning close order is an evil which can often be avoided when" &c. &c. (par. 342). The consequences of this evil, further, are actually less serious in proportion as the troops are well drilled—not to

<sup>1</sup> The 1902 edition of *Infantry Training* indeed treated the new scouts as a thin advanced firing line, but in 1907, at which date important modifications began to be made in the "doctrine" of the British Army, the scouts were expressly restricted to the old-fashioned "skirmishing" duties.

<sup>2</sup> This is no new thing, but belongs, irrespective of armament, to the "War of masses." The king of Prussia's fighting instructions of the 10th of August 1813 lay down the principle as clearly as any modern work.

an unnecessary and unattainable ideal of mechanical perfection, but to a state of instinctive self-control in danger. Drill, therefore, carried to such a point that it has eliminated the bad habits of the recruit without detriment to his good habits, is still the true basis of all military training, whether training be required for the swift controlled movements of bodies of infantry in close order, for the cool and steady fire of scattered groups of skirmishers, or for the final act of the resolute will embodied in the "decisive attack." Unfortunately for the solution of infantry problems "drill" and "close order" are often confused, owing chiefly to the fact that in the 1870 battles the dissolution of close order formations practically meant the end of control as control was then understood. Both the material and objective, and the inward and spiritual significances of "drill" are, however, independent of "close order." In fact, in modern history, when a resolute general has made a true decisive attack with half-drilled troops, he has generally arrayed them in the closest possible formations.

Drill is the military form of education by repetition and association (see G. le Bon, *Psychologie de l'éducation*). Materially it consists in exercises frequently repeated by bodies of soldiers with a view to ensuring the harmonious action of each individual in the work to be performed by the mass—in a word, rehearsals. Physical "drill" is based on physiology and gymnastics, and aims at the development of the physique and the individual will power.<sup>1</sup> But the psychological or moral is incomparably the most important side of drill. It is the method or art of discipline. Neither self-control nor devotion in the face of imminent danger can as a rule come from individual reasoning. A commander-in-chief keeps himself free from the contact with the turmoil of battle so long as he has to calculate, to study reports or to manoeuvre, and commanders of lower grades, in proportion as their duty brings them into the midst of danger, are subjected to greater or less disturbing influences. The man in the fighting line where the danger is greatest is altogether the slave of the unconscious. Overtaxed infantry, whether defeated or successful, have been observed to present an appearance of absolute insanity. It is true that in the special case of great war experience reason resumes part of its dominion in proportion as the fight becomes the soldier's habitual *milieu*. Thus towards the end of a long war men become skilful and cunning individual fighters; sometimes, too, feelings of respect for the enemy arise and lead to interchange of courtesies at the outposts, and it has also been noticed that in the last stage of a long war men are less inclined to sacrifice themselves. All this is "reason" as against inborn or inbred "instinct." But in the modern world, which is normally at peace, some method must be found of ensuring that the peace-trained soldier will carry out his duties when his reason is submerged. Now we know that the constant repetition of a certain act, whether on a given impulse or of the individual's own volition, will eventually make the performance of that act a reflex action. For this reason peace-drilled troops have often defeated a war-trained enemy, even when the motives for fighting were equally powerful on each side. The mechanical performance of movements, and loading and firing at the enemy, under the most disturbing conditions can be ensured by bringing the required self-control from the domain of reason into that of instinct. "L'éducation," says le Bon, "est l'art de faire passer le conscient dans l'inconscient." Lastly, the instincts of the recruit being those special to his race or nation, which are the more powerful because they are operative through many generations, it is the drill sergeant's business to bring about, by disuse, atrophy of the instincts which militate against soldierly efficiency, and to develop, by constant repetition and special preparation, other useful instincts which the Englishman or Frenchman or German does not as such possess. In short, as regards infantry training, there is no real distinction between drill and education, save in so far as the latter term covers instruction in small details of field service which demand alertness, shrewdness and technical knowledge (as distinct from technical training). As understood by the controversialists of the last generation, drill was the antithesis of education. To-day, however, the principle of education having prevailed against the old-fashioned notion of drill, it has been discovered that after all drill is merely an intensive form of education. This discovery (or rather definition and justification of an existing empirical rule) is attributable chiefly to a certain school of French officers, who seized more rapidly than civilians the significance of modern psycho-physiology. In their eyes, a military body possesses in a more marked degree than another, the primary requisite of the "psychological crowd" studied by Gustave le Bon, "the concentration of the wills of each and all members of the crowd in a determined direction. Such a crowd generates a collective will that dominates the wills of the individuals composing it. It coheres and acts on the

common property of all the instincts and habits in which each shares. Further it tends to extremes of baseness and heroism—this being particularly marked in the military crowd—and lastly it reacts to a stimulus. The last is the keynote of the whole subject of infantry training as also, to a lesser degree, of that of the other arms. The officer can be regarded practically as a hypnotist playing upon the unconscious activities of his subject. In the lower grades, it is immaterial whether reason, caprice or a fresh set of instincts stimulated by an outside authority, set in motion the "suggestion." The true leader, whatever the provenance of his "suggestion," makes it effective by dominating the "psychological crowd" that he leads. On the other hand, if he fails to do so, he is himself dominated by the uncontrolled will of the crowd, and although leaderless mobs have at times shown extreme heroism, it is far more usual to find them reverting to the primitive instinct of brutality or panic fear. A mob, therefore, or a raw regiment, requires greater powers of suggestion in its leader, whereas a thorough course of drill tunes the "crowd" to respond to the stimulus that average officers can apply.

So far from diminishing, drill has increased in importance under modern conditions of recruiting. It has merely changed in form, and instead of being repressive it has become educative. The force of modern short-service troops, as *troops*, is far sooner spent than that of the old-fashioned automatic regiments, while the reserve force of its component parts, remaining after the dissolution, is far higher than of old. But this uncontrolled force is liable to panic as well as amenable to an impulse of self-sacrifice. In so far, then, it is necessary to adopt the catchword of the Btlow school and to "organize disorder," and the only known method of doing so is drill. "Individualism" pure and simple had certainly a brief reign during and after the South African War, especially in Great Britain, and both France and Germany coquetted with "Boer tactics," until the Russo-Japanese war brought military Europe back to the old principles.

But the South African War came precisely at the point of time when the controversies of 1870 had crystallized into a form of tactics that was not suitable to the conditions of that war, while after the same time the relations of infantry and artillery underwent a profound change. As regards the South African War, the clear atmosphere, the trained sight of the Boers, and the alternation of level plain and high concave kopjes which constituted the usual battlefield, made the front to front infantry attacks not merely difficult but almost impossible. For years, indeed ever since the Peninsular War, the tendency of the British army to deploy early had afforded a handle to European critics of its tactical methods. It was a tendency that survived with the rest of the "linear" tradition. But in South Africa, owing to the special advantages of the defenders, which denied to the assailant all reliable indications of the enemy's strength and positions, this early deployment had to take a non-committal form—viz. many successive lines of skirmishers. The application of this form was, indeed, made easy by the openness of the ground, but like all "schematic" formations, open or close, it could not be maintained under fire, with the special disadvantage that the extensions were so wide as to make any manoeuvring after the fight had cleared up a situation a practical impossibility. Hence some preconceived idea of an objective was an essential preliminary, and as the Boer mounted infantry hardly ever stood to defend any particular position to the last (as they could always renew the fight at some other point in their vast territory), the preconceived idea was always, after the early battles, an envelopment in which the troops told off to the frontal holding attack were required, not to force their advance to its logical conclusion, but to keep the fight alive until the flank attack made itself felt. The principal tendency of British infantry tactics after the Boer War was therefore quite naturally, under European as well as colonial conditions, to deploy at the outset in great depth, i.e. in many lines of skirmishers, each line, when within about 1400 yds of the enemy's position, extending to intervals of 10 to 20 paces between individuals. The reserves were strong and their importance was well marked in the 1902 training manual, but their functions were rather to extend or feed the firing line, to serve as a rallying point in case of defeat and to take up the pursuit (par. 220, *Infantry Training*, 1902), than to form the engine of

The South African War.

<sup>1</sup> In the British Service, men whose nerves betray them on the shooting range are ordered more gymnastics (*Musketry Regulations*, 1910).

a decisive attack framed by the commander-in-chief after "engaging everywhere and then seeing" as Napoleon did. The 1905 regulations adhered to this theory of the attack in the main, only modifying a number of tactical prescriptions which

had not proved satisfactory after their transplantation from South Africa to Europe, but after the Russo-Japanese War a series of important amendments was issued which gave greater force and still greater elasticity to the attack procedure, and in 1909 the tactical

"doctrine" of the British army was definitively formulated in *Field Service Regulations*, paragraph 102, of which after enumerating the advantages and disadvantages of the "preconceived idea" system, laid it down, as the normal procedure of the British Army, that the general should "obtain the decision by manoeuvre on the battlefield with a large general reserve maintained in his own hand" and "strike with his reserve at the right place and time."

The rehabilitation of the Napoleonic attack idea thus frankly accepted in Great Britain had taken place in France several years before the South African War, and neither this war nor that in Manchuria effectively shook the faith of the French army in the principle, while on the other hand Germany remains faithful to the "preconceived idea," both in strategy and tactics.<sup>1</sup> This essential difference in the two rival "doctrines" is intimately connected with the revival of the Napoleonic artillery attack, in the form of concentrated time shrapnel.

The Napoleonic artillery preparation, it will be remembered, was a fire of overwhelming intensity delivered against the selected point of the enemy's position, at the moment of the massed and decisive assault of the reserves. In Napoleon's time the artillery went in to within 300 or 400 yds. range for this act, i.e. in front of the infantry, whereas now the guns fire over the heads of the infantry and concentrate shells instead of guns on the vital point. The principle is, however, the same. A model infantry attack in the Napoleonic manner was that of Okasaki's brigade on the Terayama hill at the battle of Shaho, described by Sir Ian Hamilton in his *Staff Officer's Scrap-Book*. The Japanese, methodical and cautious as they were, only sanctioned a pure open force assault as a last resort. Then the brigadier Okasaki, a peculiarly resolute leader, arrayed his brigade in a "schematic" attack formation of four lines, the first two in single rank, the third in line and the fourth in company columns. Covered by a powerful converging shrapnel fire, the brigade covered the first 900 yds. of open plain without firing a shot. Then, however, it disappeared from sight amongst the houses of a village, and the spectators watched the thousands of flashes fringing the further edge that indicated a fire-fight at decisive range (the Terayama was about 600 yds. beyond the houses). Forty minutes passed, and the army commander Kuroki said, "He cannot go forward. We are in check to-day all along the line." But at that moment Okasaki's men, no longer in a "schematic" formation but in many irregularly disposed groups—some of a dozen men and some of seventy, some widely extended and some practically in close order—rushed forward at full speed over 600 yds. of open ground, and stormed the Terayama with the bayonet.

Such an attack as that at the battle of Shaho is rare, but so it has always been with masterpieces of the art of war. We have only to multiply the front of attack by two and the forces engaged by five—and to find the resolute general to lead them—to obtain the ideal decisive attack of a future European war. Instead of the bare open plain over which the advance to decisive range was made, a European general would in most cases dispose of an area of spinnets, farm-houses and undulating fields. The schematic approach-march would be replaced in France and England by a forward movement of bodies in close order, handy enough to utilize the smallest covered ways. Then the fire of both infantry and artillery would be augmented to its maximum intensity, overpowering that of the defence, and the whole of the troops opposite the point to be stormed would be thrown forward for the bayonet charge. The formation for

<sup>1</sup> In 1870 the "preconceived idea" was practically confined to strategy, and the tactical improvisations of the Germans themselves deranged the execution of the plan quite as often as the act of the enemy. Of late years, therefore, the "preconceived idea" has been imposed on tactics also in that country. Special care and study is given to the once despised "early deployments" in cases where a fight is part of the "idea," and to the difficult problem of breaking off the action, when it takes a form that is incompatible with the development of the main scheme.

this scarcely matters. What is important is speed and the will to conquer, and for this purpose small bodies (sections, half-companies or companies), not in the close order of the drill book but grouped closely about the leader who inspires and controls them, are as potent an instrument as a Frederician line or a Napoleonic column.

Controversy, in fact, does not turn altogether on the method of the assault, or even on the method of obtaining the fire-superiority of guns and rifles that justifies it. Although one nation may rely on its guns more than on the rifles, or vice versa, all are agreed that at decisive range the firing line should contain as many men as can use their rifles effectually. Perhaps the most disputed point is the form of the "approach-march," viz. the dispositions and movements of the attacking infantry between about 1400 and about 600 yds. from the position of the enemy.

The condition of the assailant's infantry when it reaches decisive ranges is largely governed by the efforts it has expended and the losses it has suffered in its progress. Sometimes even after a firing line of some strength has been established at decisive range, it may prove too difficult or too costly for the supports (sent up from the rear to replace casualties and to augment fire-power) to make their way to the front. Often, again, it may be within the commander's intentions that his troops at some particular point in the line should not be committed to decisive action before a given time—perhaps not at all. It is obvious then that no "normal" attack procedure which can be laid down in a drill book (though from time to time the attempt has been made, as in the French regulations of 1875) can meet all cases. But here again, though all armies formally and explicitly condemn the normal attack, each has its own well-marked tendencies.

The German regulations of 1906 define the offensive as "transporting fire towards the enemy, if necessary to his immediate proximity"; the bayonet attack "confirms" the victory. Every attack begins with deployment into extended order, and the leading line advances as close to the enemy as possible before opening fire. In ground offering cover, the firing line has practically its maximum density at the outset. In open ground, however, half-sections, groups and individuals, widely spaced out, advance stealthily one after the other till all are in position. It is on this position, called the "first fire position" and usually about 1000 yds. from the enemy, that the full force of the attack is deployed, and from this position, as simultaneously as possible, it opens the fight for fire-superiority. Then, each unit covering the advance of its neighbours, the whole line fights its way by open force to within charging distance. If at any point a decision is not desired, it is deliberately made impossible by employing there such small forces as possess no offensive power. Where the attack is intended to be pushed home, the infantry units employed act as far as possible simultaneously, resolutely and in great force (see the German *Infantry Regulations*, 1906, §§ 324 et seq.).

While in German movement "transports the fire," in France fire is regarded as the way to make movement possible. It is considered (see Grandmaison, *Dressage de l'infanterie*) that a premature and excessive deployment enervates the attack, that the ground (i.e. covered ways of approach for small columns, not for troops showing a fire front) should be used as long as possible to march "en troupe" and that a firing line should only be formed when it is impossible to progress without acting upon the enemy's means of resistance. Thereafter each unit, in such order as its chief can keep, should fight its way forward, and help others to do so—like Okasaki's brigade in the last stage of its attack—utilizing bursts of fire or patches of wood or depressions in the ground, as each is profitable or available to assist the advance. "From the moment when a fighting unit is 'uncoupled,' its action must be ruled by two conditions, and by those only: the one material, an object to be reached; the other moral, the will to reach the object."

The approach-march.

Current views on the infantry attack.

The British *Field Service Regulations* of 1909 are in spirit more closely allied to the French than to the German. "The climax of the infantry attack is the assault, which is made possible by superiority of fire" is the principle (emphasized in the book itself by the use of conspicuous type), and a "gradual building up of the firing line within close range of the position," coupled with the closest artillery support, and the final blow of the reserves delivered "unexpectedly and in the greatest possible strength" are indicated as the means.<sup>1</sup>

The defence, as it used to be understood, needs no description. To-day in all armies the defence is looked upon not as a means of winning a battle, but as a means of temporizing and avoiding the decision until the commander of the defending party is enabled, by the general military situation or by the course and results of the defensive battle itself, to take the offensive. In the British *Field Service Regulations* it is laid down that when an army acts on the defensive no less than half of it should if possible be earmarked, suitably posted and placed under a single commander, for the purpose of delivering a decisive counter-attack. The object of the purely defensive portion, too, is not merely to hold the enemy's firing line in check, but to drive it back so that the enemy may be forced to use up his local reserve resources to keep the fight alive. A firing line covered and steadied by entrenchments, and restless local reserves ever on the look-out for opportunities of partial counter-strokes, are the instruments of this policy.

A word must be added on the use of entrenchments by infantry, a subject the technical aspect of which is fully dealt with and illustrated in *FORTIFICATION AND SIEGE-CRAFT: Field Defences*. Entrenchments of greater or less strength by themselves have always been used by infantry on the defensive, especially in the wars of position of the 17th and 18th centuries. In the Napoleonic and modern "wars of movement," they are regarded, not as a passive defence—they have long ceased to present a physical barrier to assault—but as fire positions so prepared as to be defensible by relatively few men. Their purpose is, by concentrating force elsewhere, to give the maximum strength to the troops told off for the counter-offensive. In the later stages of the American Civil War, and also in the Russo-Japanese War of 1904-1905—each in its way an example of a "war of positions"—the assault has also made use of the methods of fortification to secure every successive step of progress in the attack. The usefulness and limitations of this procedure are defined in generally similar terms in the most recent training manuals of nearly every European army. Section 136, § 7 of the British *Infantry Training* (1905, amended 1907) says: "During the process of establishing a superiority of fire, successive fire positions will be occupied by the firing line. As a rule the most affording natural cover will be chosen, but if none exist and the intensity of the hostile fire preclude any immediate further advance, it may be expedient for the firing line to create some. This hastily constructed protection will enable the attack to cope with the defender's fire and thus prepare the way for a further advance. The construction of cover during an attack, however, will entail delay and a temporary loss of fire effect and should therefore be resorted to only when absolutely necessary. . . . As soon as possible the advance should be resumed, &c." The German regulations are as follows (*Infantry Training*, 1906, § 313): "In the offensive the entrenching tool may be used where it is desired, for the moment, to content one's self with maintaining the ground gained. . . . The entrenching tool is only to be used with the greatest circumspection, because of the great difficulty of getting an extended line to go forward under fire when it has expended much effort in digging cover for itself. The construction of trenches must never paralyze the desire for the irresistible advance, and above all must not kill the spirit of the offensive."

#### ORGANIZATION AND EQUIPMENT

The organization of infantry varies rather more than that of other arms in different countries. Taking the British system first, the battalion (and not as elsewhere the regiment of two, three or more battalions) is the administrative and manoeuvre unit. It is about 1000 strong, and is commanded by a lieutenant-colonel, who has a major and an adjutant (captain or lieutenant) to assist him, and an officer of lieutenant's or captain's rank (almost invariably promoted from the ranks), styled the quartermaster, to deal with supplies, clothing, &c. There are eight companies of a nominal strength of about 120 each. These are commanded by captains (or

by junior majors), and each captain has or should have two lieutenants or second lieutenants to assist him. Machine guns are in Great Britain distributed to the battalions and not massed in permanent batteries. In addition there are various regimental details, such as orderly-room staff, cooks, cyclists, signallers, band and ambulance men. The company is divided into four sections of thirty men each and commanded by sergeants. A half-company of two sections is under the control of a subaltern officer. A minor subdivision of the section into two "squads" is made unless the numbers are insufficient to warrant it. In administrative duties the captain's principal assistant is the quartermaster or pay-sergeant, who is not assigned to a section command. The lieutenant-colonel, the senior major and the adjutant are mounted. The commanding officer is assisted by a battalion staff, at the head of which is the adjutant. The sergeant-major holds a "warrant" from the secretary of state for war, as does the bandmaster. Other members of the battalion staff are non-commissioned officers, appointed by the commanding officer. The most important of these is the quartermaster-sergeant, who is the assistant of the quartermaster. The two colours ("king's" and "regimental") are in Great Britain carried by subalterns and escorted by colour-sergeants (see *Colours*).

The tactical unit of infantry is now the company, which varies very greatly in strength in the different armies. Elsewhere the company of 250 rifles is almost universal, but in Great Britain the company has about 110 men in the ranks, forming four sections. These sections, each of about 28 rifles, are the normal "fire-units," that is to say, the unit which delivers its fire at the orders of and with the elevation and direction given by its commander. This, it will be observed, gives little actual executive work for the junior officers. But a more serious objection than this (which is modified in practice by arrangement and circumstances) is the fact that a small unit is more affected by detachments than a large one. In the home battalions of the Regular Army such detachments are very large, what the finding drafts for foreign service are, and there are instructional courses, while in the Territorial Force, where it is so rarely possible to assemble all the men at once, the company as organized is often too small to drill as such. On the other hand, the full war-strength company is an admirable unit for control and manoeuvre in the field, owing to its rapidity of movement, handiness in using accidents of ground and cover, and susceptibility to the word of command of one man. But as soon as its strength falls below about 80 the advantages cease to counterbalance the defects. The sections become too small as fire-units to effect really useful results, and the battalion commander has to co-ordinate and to direct 8 comparatively inefficient units instead of 4 powerful ones. The British regular army therefore has since the First African War adopted the double company as the unit of training. This gives at all times a substantial unit for fire and manoeuvre training, but the disadvantage of having a good many officers only half employed is accentuated. As to the tactical value of the large or double company, opinions differ. Some hold that as the small company is a survival from the days when the battalion was the tactical unit and the company was the unit of volley-fire, it is unsuited to the modern exigencies that have broken up the old rigid line into several independent and co-operating fractions. Others reply that the strong continental company of 250 rifles came into existence in Prussia in the years after Waterloo, not from tactical reasons, but because the state was too poor to maintain a large establishment of officers, and that in 1870, at any rate, there were many instances of its tactical unwieldiness. The point that is common to both organizations is the fact that there is theoretically one subaltern to every 50 or 60 rifles, and this reveals an essential difference between the British and the Continental systems, irrespective of the sizes or groupings of companies. The French or German subaltern effectively commands his 50 men as a unit, whereas the British subaltern supervises two groups of 25 to 30 men under responsible non-commissioned officers. That is to say, a British sergeant may find himself in such a position that he has to be as expert in controlling and obtaining good results from collective fire as a German lieutenant. For reasons mentioned in *ARMY*, § 40, non-commissioned officers, of the type called by Kipling the "backbone of the army," are almost unobtainable with the universal service system, and the lowest unit that possesses any independence is the lowest unit commanded by an officer. But apart from the rank of the fire-unit commander, it is questionable whether the section, as understood in England, is not too small a fire-unit, for European warfare at any rate. The regulations of the various European armies, framed for these conditions, practically agree that the fire-unit should be commanded by an officer and should be large enough to ensure good results from collective fire. The number of rifles meeting this second condition is 50 to 80 and their organization a section (corresponding to the British half-company) under a subaltern officer. The British army has, of course, to be organized and trained for an infinitely wider range of activity, and no one would suggest the abolition of the small section as a fire-unit. But in a great European battle it would be almost certainly better to group the two sections into a real unit for fire effect. (For questions of infantry fire tactics see *RIFLE: § Musketry*.)

On the continent of Europe the "regiment," which is a unit, acting in peace and war as such, consists normally of three battalions, and

<sup>1</sup> In February 1910 a new *Infantry Training* was said to be in preparation. The I.T. of 1905 is in some degree incompatible with the later and ruling doctrine of the *F.S. Regulations*, and in the winter of 1909 the Army Council issued a memorandum drawing attention to the different conceptions of the decisive attack as embodied in the latter and as revealed in manoeuvre procedure.

each battalion of four companies or 1000 rifles. The company of 250 rifles is commanded by a captain, who is mounted. In France the company has four sections, commanded in war by the three subalterns and the "adjutant" (company sergeant-major); the sections are further grouped in pairs to constitute *pelotons* (platoons) or half-companies under the senior of the two section leaders. In peace there are two subalterns only, and the *peloton* is the normal junior officer's command. The battalion is commanded by a major (commandant) or strictly *chef de bataillon*, the regiment (three or four battalions) by a colonel with a lieutenant-colonel as second. An organization of 3-battalion regiments and 3-company battalions was proposed in 1910.

In Germany, where what we have called the continental company originated, the regiment is of three battalions under majors, and the battalion of four companies commanded by captains. The company is divided into three *Züge* (sections), each under a subaltern, who has as his second a sergeant-major, a "vice-sergeant-major" or a "sword-knot ensign" (aspirant officer). In war there is one additional officer for company. The *Zug* at war-strength has therefore about 80 rifles in the ranks, as compared with the French "section" of 50, and the British section of 30.

The system prevailing in the United States since the reorganization of 1901 is somewhat remarkable. The regiment, which is a tactical as well as an administrative unit, consists of three battalions. Each battalion has four companies of (at war-strength) 3 officers and 150 rifles each. The regiment in war therefore consists of about 1800 rifles in three small and handy battalions of 600 each. The circumstances in which this army serves, and in particular the maintenance of small frontiers, has always imposed on our subalterns the responsibilities of small independent commands, and it is fair to assume that the 75 rifles at a subaltern's disposal are regarded as a tactical unit.

In sum, then, the infantry battalion is in almost every country about 1000 rifles strong in four companies. In the United States it is 600 strong in four companies, and in Great Britain it is 1000 strong in eight. The captain's command is usually 200 to 250 men, in the United States 150, and in Great Britain 120. The lieutenant or second lieutenant commands in Germany 80 rifles, in France 50, and in the United States 75, as a unit of fire and manoeuvre. In Great Britain he commands, with relatively restricted powers, 60.

A short account of the infantry equipments—knapsack or valise, belt, haversack, &c.—in use in various countries will be found in *UNIFORMS, NAVAL AND MILITARY*. The armament of infantry is, in all countries, the magazine rifle (see *RIFLE*) and bayonet (*q.v.*), for officers and for certain under-officers sword (*q.v.*) and pistol (*q.v.*). Ammunition (*q.v.*) in the British service is carried (*a*) by the individual soldier, (*b*) by the reserves (mules and carts) in regimental charge, some of which in turn are supplied from the battalion of a brigade to form a brigade reserve, and (*c*) by the ammunition columns.

**BIBLIOGRAPHY.**—The following works are selected to show (1) the historical development of the arm, and (2) the different "doctrines" of to-day as to its training and functions:—Arduant du Picq, *Études sur le combat*; C. W. C. Oman, *The Art of War: Middle Ages*; Biotot, *Les Grands Inspirés—Jeanne d'Arc*; Hardy de Péron, *Batailles françaises*; C. H. Firth, *Cromwell's Army*; German official history of Frederick the Great's wars, especially *Erster Schlessische Krieg*, vol. I; Sussane, *Histoire de l'infanterie française*; French General Staff, *La Tactique au XVIII<sup>e</sup>—l'infanterie et La Tactique et la discipline dans les armées de la Révolution—Général Schauenbourg*; J. W. Fortescue, *History of the British Army*; Moorson, *History of the 52nd Regiment*; de Grandmaison, *Dressage de l'infanterie* (Paris, 1908); works of W. v. Scherff; F. N. Maude, *Evolution of Infantry Tactics and Attack and Defence*; [Meckel] *Ein Sommernachstrahl* (Eng. trans. in *United Service Magazine*, 1890); J. Meckel, *Taktik*; Malachowski, *Scharfe und Revolutaktik*; H. Langlois, *Enseignements de deux guerres*; F. Leisenig, *Tactics of the Future and Twenty-four Hours of Moltke's Strategy* (Eng. trans.); works of A. von Boguslawski; *British Officers' Reports on the Russo-Japanese War*; H. W. L. Hime, *Stray Military Papers*; Grange, "Les Réalités du champ de bataille—Woerth" (*Rev. d'infanterie*, 1908-1909); V. Lindenau, "The Boer War and Infantry Attack" (*Journal R. United Service Institution*, 1902-1903); Janin, "Aperçus sur la tactique—Mandchourie" (*Rev. d'infanterie*, 1909); Soloviev, "Infantry Combat in the Russo-Jap. War" (Eng. trans. *Journal U.S.I.*, 1908); *British Official Field Service Regulations*, part I. (1909), and *Infantry Training* (1908); German drill regulations of 1904 (Fr. trans.); French drill regulations of 1904; Japanese regulations 1907 (Eng. trans.). The most important journals devoted to the infantry arm are the French official *Revue d'infanterie* (Paris and Limoges), and the *Journal of the United States Infantry Association* (Washington, D. C.). (C. F. A.)

**INFANT SCHOOLS.** The provision in modern times of systematized training for children below the age when elementary education normally begins may be dated from the village school at Waldbach founded by Jean Frédéric Oberlin in 1774. Robert Owen started an infant school at New Lanark in 1800, and great interest in the question was taken in Great Britain during the early years of the 19th century, leading to the foundation in

1836 of the Home and Colonial School Society for the training of teachers in infant schools; this in turn reacted upon other countries, especially Germany. Further impetus and a new direction were given to the movement by Friedrich W. A. Froebel, and the methods of training adopted for children between the ages of three and six have in most countries been influenced by, if not based on, that system of directed activities which was the foundation of the type of "play-school" called by him the *Kinder Garten*, or "children's garden." The growing tendency in England to lay stress on the mental training of very young children, and to use the "infant school" as preparatory to the elementary school, has led to a considerable reaction; medical officers of health have pointed out the dangers of infection to which children up to the age of five are especially liable when congregated together—also the physical effects of badly ventilated class-rooms, and there is a consensus of opinion that formal mental teaching is directly injurious before the age of six or even seven years. At the same time the increase in the industrial employment of married women, with the consequent difficulty of proper care of young children by the mother in the home, has somewhat shifted the ground from a purely educational to a social and physical aspect. While it is agreed that the ideal place for a young child is the home under the supervision of its mother, the present industrial conditions often compel a mother to go out to work, and leave her children either shut up alone, or free to play about the streets, or in the care of a neighbour or professional "minder." In each case the children must suffer. The provision by a public authority of opportunities for suitable training for such children seems therefore a necessity. The moral advantages gained by freeing the child from the streets, by the superintendence of a trained teacher over the games, by the early inculcation of habits of discipline and obedience; the physical advantages of cleanliness and tidiness, and the opportunity of disclosing incipient diseases and weaknesses, outweigh the disadvantages which the opponents of infant training adduce. It remains to give a brief account of what is done in Great Britain, the United States of America, and certain other countries. A valuable report was issued for the English Board of Education by a Consultative Committee upon the school attendance of children below the age of five (vol. 22 of the *Special Reports*, 1909), which also gives some account of the provision of day nurseries or *crèches* for babies.

*United Kingdom.*—Up to 1905 it was the general English practice since the Education Act of 1870 for educational authorities to provide facilities for the teaching of children between three and five years old whose parents desired it. In 1905, of an estimated 1,467,700 children between those ages, 583,268 were thus provided for in England and Wales. In 1905 the objections, medical and educational, already stated, coupled with the increasing financial strain on the local educational authorities, led to the insertion in the code of that year of Article 53, as follows: "Where the local education authority have so determined in the case of any school maintained by them, children who are under five years may be refused admission to that school." In consequence in 1907 the numbers were found to have fallen to 459,034 out of an estimated 1,480,550 children, from 39.74% in 1905 to 31%. In the older type of infant school stress was laid on the mental preparation of children for the elementary teaching which was to come later. This forcing on of young children was encouraged by the system under which the government grant was allotted; children in the infant division earned an annual grant of 17s. per head, on promotion to the upper school this would be increased to 22s. In 1909 the system was altered; a rate of 21s. 4d. was fixed as the grant for all children above five, and the grant for those below the age was reduced to 13s. 4d. Different methods of training the teachers in these schools as well as the children themselves have been now generally adopted. These methods are largely based on the Froebelian plan, and greater attention is being paid to physical development. In one respect England is perhaps behind the more progressive of other European

countries, viz. in providing facilities for washing and attending to the personal needs of the younger children. There is no *femme de service* as in Belgium on the staff of English schools. While in Ireland the children below the age of five attend the elementary schools in much the same proportion as in England and Wales, in Scotland it has never been the general custom for such children to attend school.

**United States of America.**—In no country has the kindergarten system taken such firm root, and the provision made for children below the compulsory age is based upon it. In 1873 there were 42 kindergartens with 1252 pupils; in 1898 the numbers had risen to 2884 with 143,720 pupils; more than half these were private schools, managed by charitable institutions or by individuals for profit. In 1904-1905 there were 3176 public kindergartens with 205,118 pupils.

**Austria Hungary.**—Provision in Austria is made for children under six by two types of institution, the Day Nursery (*Kinderbewahranstalten*) and the Kindergartens. In 1872 as the result of a State Commission the Kindergartens was established in the state system of education. Its aim is to "confirm and complete the home education of children under school age, so that through regulated exercise of body and mind they may be prepared for institution in the primary school." No regular teaching in ordinary school subjects is allowed; games, singing and handicrafts, and training of speech and observation by objects, tales and gardening are the means adopted. The training for teachers in these schools is regulated by law. No children are to be received in a kindergarten till the beginning of the fourth and must leave at the end of the sixth year. In 1902-1903 there were 77,002 children in kindergartens and 74,110 in the day nurseries. In Hungary a law was passed in 1891 providing for the education and care of children between three and six, either by *asyle* or nurseries open all the year round in communes which contribute from £30 to £1250 in state taxation, or during the summer in those whose contribution is less. Communes above the higher sum must provide kindergartens. In 1904 there were over 233,000 children in such institutions.

**Belgium.**—For children between three and six education and training are provided by *Ecoles gardiennes* or *Jardins d'enfants*. They are free but not compulsory, are provided and managed by the communes, receive a state grant, and are under government inspection. Schools provided by private individuals or institutions must conform to the conditions of the communal schools. There is a large amount of voluntary assistance especially in the provision of clothes and food for the poorer children. The state first recognized these schools in 1833. In 1881 there were 708 schools with accommodation for over 56,000 children; in 1907 there were 2837 and 261,845 children, approximately one-half of the total number of children in the country between the ages of three and six. In 1890 the minister of Public Instruction issued a code of rules on which is based the organization of the *Ecoles gardiennes* throughout Belgium, but some of the communes have regulations of their own. A special examination for teachers in the *Ecoles gardiennes* was started in 1898. All candidates must pass this examination before a *certificat de capacité* is granted. The training includes a course in Froebelian methods. While Froebel's system underlies the training in these schools, the teaching is directed very much towards the practical education of the child, special stress being laid on manual dexterity. Reading, writing and arithmetic are also allowed in the classes for the older children. A marked feature of the Belgian schools is the close attention paid to health and personal cleanliness. In all schools there is a *femme de service*, not a teacher, but an attendant, whose duty is to see to the tidiness and cleanliness of the children, and to their physical requirements.

**France.**—The first regular day school was established in Paris at the beginning of the 19th century and was called a *Salle d'essai*. In 1828 a model school, called a *Salle d'asile*, was started, followed shortly by similar institutions all over France. State recognition and inspection were granted, and by 1836 there were over 400 in Paris and the provinces. In 1848 they became establishments of public instruction, and the name *École maternelle* which they have since borne was given them. Every commune with 2000 inhabitants must have one of these schools or a *Classe enfantine*. Admission is free, but not compulsory, for children between two and six. Food and clothes are provided in exceptional cases. Formal mental instruction is still given to a large extent, and the older children are taught reading, writing and arithmetic. Though the staffs of the school include *femmes de service*, not so much attention is paid to cleanliness as in Belgium, nor is so much stress laid on hygiene. In 1906-1907 there were 4111 public and private *Ecoles maternelles* in France, with over 650,000 pupils. The closing of the clerical schools has led to some diminution in the numbers.

**Germany.**—There are two classes of institution in Germany for children between the ages of 2½ or 3 and 6. These are the *Klein-kinderbewahranstalten* and *Kindergartens*. The first are primarily social in purpose, and afford a place for the children of mothers who

have to leave their homes for work. These institutions, principally conducted by religious or charitable societies, remain open all day and meals are provided. Many of them have a kindergarten attached, and others provide some training on Froebelian principles. The kindergartens proper are also principally in private hands, though most municipalities grant financial assistance. They are conducted on advanced Froebelian methods, and formal teaching in reading, writing and arithmetic is excluded. In Cologne, Düsseldorf, Frankfurt and Munich there are municipal schools. The state gives no recognition to these institutions and they form no part of the public system of education.

**Switzerland.**—In the German speaking cantons the smaller towns and villages provide for the younger children by *Bewahranstalten*, generally under private management with public financial help. The larger towns provide kindergartens where the training is free but not compulsory for children from four to six. These are generally conducted on Froebel's system and there is no formal instruction. In the French speaking cantons the *Ecoles enfantines* are recognized as the first stage of elementary education. They are free and not compulsory for children from three to six years of age. (C. WE.)

**INFINITE** (from Lat. *in*, not, *finis*, end or limit; cf. *findere*, to cleave), a term applied in common usage to anything of vast size. Strictly, however, the epithet implies the absence of all limitation. As such it is used specially in (1) theology and metaphysics, (2) mathematics.

1. Tracing the history of the word to the earliest date for which there is any kind of evidence, we are faced with the problem that for everything there is a prior something; the mind is unable to conceive an absolute beginning ("ex nihilo nihil"). Mundane distances become trivial when compared with the distance from the earth of the sun and still more of other heavenly bodies; hence we infer infinite space. Similarly by continual subdivision we reach the idea of the infinitely small. For these inferences there is indeed no actual physical evidence: infinity is a mental concept. As such the term has played an important part in the philosophical and theological speculation. In early Greek philosophy the attempt to arrive at a physical explanation of existence led the Ionian thinkers to postulate various primal elements (*e.g.* water, fire, air) or simply the infinite *τὸ ἀπειρον* (see IONIAN SCHOOL). Both Plato and Aristotle devoted much thought to the discussion as to which is most truly real, the finite objects of sense, or the universal idea of each thing laid up in the mind of God; what is the nature of that unity which lies behind the multiplicity and difference of perceived objects? The same problem, variously expressed, has engaged the attention of philosophers throughout the ages. In Christian theology God is conceived as infinite in power, knowledge and goodness, uncreated and immortal: in some Oriental systems the end of man is absorption into the infinite, his perfection the breaking down of his human limitations. The metaphysical and theological conception is open to the agnostic objection that the finite mind of man is by hypothesis unable to cognize or apprehend not only an infinite object, but even the very conception of infinity itself; from this standpoint the infinite is regarded as merely a postulate, as it were an unknown quantity (cf.  $\sqrt{-1}$  in mathematics). The same difficulty may be expressed in another way if we regard the infinite as unconditioned (cf. Sir William Hamilton's "philosophy of the unconditioned," and Herbert Spencer's doctrine of the infinite "unknowable"); if it is argued that knowledge of a thing arises only from the recognition of its differences from other things (*i.e.* from its limitations), it follows that knowledge of the infinite is impossible, for the infinite is by hypothesis unrelated.

With this conception of the infinite as absolutely unconditioned should be compared what may be described roughly as lesser infinities which can be philosophically conceived and mathematically demonstrated. Thus a point, which is by definition infinitely small, is as compared with a line a unit: the line is infinite, made up of an infinite number of points, any pair of which have an infinite number of points between them. The line itself, *i.e.* in relation to the plane is a unit, while the plane is infinite, *i.e.* made up of an infinite number of lines; hence the plane is described as doubly infinite in relation to the point, and a solid as trebly infinite. This is Spinoza's theory of the

"infinitely infinite," the limiting notion of infinity being of a numerical, quantitative series, each term of which is a qualitative determination itself quantitatively little, e.g. a line which is quantitatively unlimited (i.e. in length) is qualitatively limited when regarded as an infinitely small unit of a plane. A similar relation exists in thought between the various grades of species and genera; the highest genus is the "infinitely infinite," each subordinated genus being infinite in relation to the particulars which it denotes, and finite when regarded as a unit in a higher genus.

2. In mathematics, the term "infinite" denotes the result of increasing a variable without limit; similarly, the term "infinitesimal," meaning indefinitely small, denotes the result of diminishing the value of a variable without limit, with the reservation that it never becomes actually zero. The application of these conceptions distinguishes ancient from modern mathematics. Analytical investigations revealed the existence of series or sequences which had no limit to the number of terms, as for example the fraction  $1/(1-x)$  which on division gives the series  $1+x+x^2+\dots$ ; the discussion of these so-called infinite sequences is given in the articles **SERIES** and **FUNCTION**. The doctrine of geometrical continuity (*q.v.*) and the application of algebra to geometry, developed in the 16th and 17th centuries mainly by Kepler and Descartes, led to the discovery of many properties which gave to the notion of infinity, as a localized space conception, a predominant importance. A line became continuous, returning into itself by way of infinity; two parallel lines intersect in a point at infinity; all circles pass through two fixed points at infinity (the circular points); two spheres intersect in a fixed circle at infinity; an asymptote became a tangent at infinity; the foci of a conic became the intersections of the tangents from the circular points at infinity; the centre of a conic the pole of the line at infinity, &c. In analytical geometry the line at infinity plays an important part in trilinear co-ordinates. These subjects are treated in **GEOMETRY**. A notion related to that of infinitesimals is presented in the Greek "method of exhaustion"; the more perfect conception, however, only dates from the 17th century, when it led to the infinitesimal calculus. A curve came to be treated as a sequence of infinitesimal straight lines; a tangent as the extension of an infinitesimal chord; a surface or area as a sequence of infinitesimally narrow strips, and a solid as a collection of infinitesimally small cubes (see **INFINITESIMAL CALCULUS**).

**INFINITESIMAL CALCULUS.** 1. The infinitesimal calculus is the body of rules and processes by means of which continuously varying magnitudes are dealt with in mathematical analysis. The name "infinitesimal" has been applied to the calculus because most of the leading results were first obtained by means of arguments about "infinitely small" quantities; the "infinitely small" or "infinitesimal" quantities were vaguely conceived as being neither zero nor finite but in some intermediate, nascent or evanescent, state. There was no necessity for this confused conception, and it came to be understood that it can be dispensed with; but the calculus was not developed by its first founders in accordance with logical principles from precisely defined notions, and it gained adherents rather through the impressiveness and variety of the results that could be obtained by using it than through the cogency of the arguments by which it was established. A similar statement might be made in regard to other theories included in mathematical analysis, such, for instance, as the theory of infinite series. Many, perhaps all, of the mathematical and physical theories which have survived have had a similar history—a history which may be divided roughly into two periods: a period of construction, in which results are obtained from partially formed notions, and a period of criticism, in which the fundamental notions become progressively more and more precise, and are shown to be adequate bases for the constructions previously built upon them. These periods usually overlap. Critics of new theories are never lacking. On the other hand, as E. W. Hobson has well said, "pertinent criticism of fundamentals almost invariably gives rise to new construction." In the history of the infinitesimal calculus the

17th and 18th centuries were mainly a period of construction, the 19th century mainly a period of criticism.

### I. Nature of the Calculus.

2. The guise in which variable quantities presented themselves to the mathematicians of the 17th century was that of the lengths of variable lines. This method of representing variable quantities dates from the 14th century, when it was employed by Nicole Oresme, who studied and afterwards taught at the Collège de Navarre in Paris from 1348 to 1361. He represented one of two variable quantities, e.g. the time that has elapsed since some epoch, by a length, called the "longitude," measured along a particular line; and he represented the other of the two quantities, e.g. the temperature at the instant, by a length, called the "latitude," measured at right angles to this line. He recognized that the variation of the temperature with the time was represented by the line, straight or curved, which joined the ends of all the lines of "latitude." Oresme's longitude and latitude were what we should now call the abscissa and ordinate. The same method was used later by many writers, among whom Johannes Kepler and Galileo Galilei may be mentioned. In Galileo's investigation of the motion of falling bodies (1638) the abscissa OA represents the time during which a body has been falling, and the ordinate AB represents the velocity acquired during that time (see fig. 1). The velocity being proportional to the time, the "curve" obtained is a straight line OB, and Galileo showed that the distance through which the body has fallen is represented by the area of the triangle OAB.

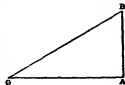

FIG. 1.

The most prominent problems in regard to a curve were the problem of finding the points at which the ordinate is a maximum or a minimum, the problem of drawing a tangent to the curve at an assigned point, and the problem of determining the area of the curve. The relation of the problem of maxima and minima to the problem of tangents was understood in the sense that maxima or minima arise when a certain equation has equal roots, and, when this is the case, the curves by which the problem is to be solved touch each other. The reduction of problems of maxima and minima to problems of contact was known to Pappus. The problem of finding the area of a curve was usually presented in a particular form in which it is called the "problem of quadratures." It was sought to determine the area contained between the curve, the axis of abscissae and two ordinates, of which one was regarded as fixed and the other as variable. Galileo's investigation may serve as an example. In that example the fixed ordinate vanishes. From this investigation it may be seen that before the invention of the infinitesimal calculus the introduction of a curve into discussions of the course of any phenomenon, and the problem of quadratures for that curve, were not exclusively of geometrical import; the purpose for which the area of a curve was sought was often to find something which is not an area—for instance, a length, or a volume or a centre of gravity.

3. The Greek geometers made little progress with the problem of tangents, but they devised methods for investigating the problem of quadratures. One of these methods was afterwards called the "method of exhaustions," and the principle on which it is based was laid down in the lemma prefixed to the 12th book of Euclid's *Elements* as follows: "If from the greater of two magnitudes there be taken more than its half, and from the remainder more than its half, and so on, there will at length remain a magnitude less than the smaller of the proposed magnitudes." The method adopted by Archimedes was more general. It may be described as the enclosure of the magnitude to be evaluated between two others which can be brought by a definite process to differ from each other by less than any assigned magnitude. A simple example of its

Geo-  
metrical  
represent-  
ation of  
Variable  
Quantities.

The problems  
of Maxima  
and Minima,  
Tangents,  
and Quadratures.

application is the 6th proposition of Archimedes' treatise *On the Sphere and Cylinder*, in which it is proved that the area contained between a regular polygon inscribed in a circle and a similar polygon circumscribed to the same circle can be made less than any assigned area by increasing the number of sides of the polygon. The methods of Euclid and Archimedes were specimens of rigorous limiting processes (see FUNCTION). The new problems presented by the analytical geometry and natural philosophy of the 17th century led to new limiting processes.

4. In the *problem of tangents* the new process may be described as follows. Let  $P, P'$  be two points of a curve (see fig. 2). Let  $x, y$  be the coordinates of  $P$ , and  $x+\Delta x, y+\Delta y$  those of  $P'$ . The symbol  $\Delta x$  means "the difference of two  $x$ 's" and there is a like meaning for the symbol  $\Delta y$ . The fraction  $\Delta y/\Delta x$  is the trigonometrical tangent of the angle which the secant  $PP'$  makes with the axis of  $x$ . Now let  $\Delta x$  be continually diminished towards zero, so that  $P'$  continually approaches  $P$ . If the curve has a tangent at  $P$  the secant  $PP'$  approaches a limiting position (see § 33 below). When this is the case the fraction  $\Delta y/\Delta x$  tends to a limit, and this limit is the trigonometrical tangent of the angle which the tangent at  $P$  to the curve makes with the axis of  $x$ . The limit is denoted by

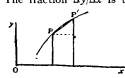

FIG. 2.

If the equation of the curve is of the form  $y=f(x)$  where  $f$  is a functional symbol (see FUNCTION), then

$$\frac{\Delta y}{\Delta x} = \frac{f(x+\Delta x) - f(x)}{\Delta x}$$

and

$$\frac{dy}{dx} = \lim_{\Delta x \rightarrow 0} \frac{f(x+\Delta x) - f(x)}{\Delta x}$$

The limit expressed by the right-hand member of this defining equation is often written

$$f'(x),$$

and is called the "derived function" of  $f(x)$ , sometimes the "derivative" or "derivate" of  $f(x)$ . When the function  $f(x)$  is a rational integral function, the division by  $\Delta x$  can be performed, and the limit is found by substituting zero for  $\Delta x$  in the quotient. For example, if  $f(x) = x^2$ , we have

$$\frac{f(x+\Delta x) - f(x)}{\Delta x} = \frac{(x+\Delta x)^2 - x^2}{\Delta x} = \frac{2x\Delta x + (\Delta x)^2}{\Delta x} = 2x + \Delta x,$$

and

$$f'(x) = 2x.$$

The process of forming the derived function of a given function is called *differentiation*. The fraction  $\Delta y/\Delta x$  is called the "quotient of differences," and its limit  $dy/dx$  is called the "differential coefficient of  $y$  with respect to  $x$ ." The rules for forming differential coefficients constitute the *differential calculus*.

The problem of tangents is solved at one stroke by the formation of the differential coefficient; and the problem of maxima and minima is solved, apart from the discrimination of maxima from minima and some further refinements, by equating the differential coefficient to zero (see MAXIMA AND MINIMA).

5. The *problem of quadratures* leads to a type of limiting process which may be described as follows: Let  $y=f(x)$  be the equation of a curve, and let AC and BD be the ordinates of the points C and D (see fig. 3). Let  $a, b$  be the abscissae of these points. Let the segment AB be divided into a number of segments by means of intermediate points such as M, and let MN be one such segment. Let PM and QN be those ordinates of the curve which have M and N as their feet. On MN as base describe two rectangles, of which the heights are the greatest and least values of  $y$  which correspond to points on the arc PQ of the curve. In fig. 3 these are the rectangles RM, SN. Let the sum of the areas of such rectangles as RM be formed, and likewise the sum of the areas of such rectangles as SN. When the number of the points such as M is increased without limit, and the lengths of all the segments as MN are diminished without limit, these two sums of areas tend to limits. When they tend to the same limit the curvilinear figure ACDB has an area, and the limit is the measure of this area (see § 33 below). The limit in question is the same whatever law may be adopted for inserting the points such as M between A and B, and for diminishing the lengths of the segments such as MN. Further, if  $P'$  is any point on the arc PQ, and  $PP'M$  is the ordinate of  $P'$ , we may construct a rectangle of which the height is  $PP'M$  and the base is MN, and the limit of the sum of the areas of all such rectangles is the area of the figure as before. If  $x$  is the

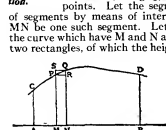

FIG. 3.

abscissa of  $P, x+\Delta x$  that of  $Q, x'$  that of  $P'$ , the limit in question might be written

$$\lim_{\Delta x \rightarrow 0} \sum_a^b f(x')\Delta x,$$

where the letters  $a, b$  written below and above the sign of summation  $\Sigma$  indicate the extreme values of  $x$ . This limit is called "the definite integral of  $f(x)$  between the limits  $a$  and  $b$ ," and the notation for it is

$$\int_a^b f(x)dx.$$

The germs of this method of formulating the problem of quadratures are found in the writings of Archimedes. The method leads to a definition of a definite integral, but the direct application of it to the evaluation of integrals is in general difficult. Any process for evaluating a definite integral is a process of integration, and the rules for evaluating integrals constitute the *integral calculus*.

6. The chief of these rules is obtained by regarding the extreme ordinate BD as variable. Let  $\xi$  now denote the abscissa of B. The area  $A$  of the figure ACDB is represented by the integral  $\int_a^{\xi} f(x)dx$ , and it is a function of  $\xi$ . Let BD be displaced to  $B'D'$  so that  $\xi$  becomes  $\xi+\Delta\xi$  (see fig. 4). The area of the figure  $ACD'B'$  is represented by the integral  $\int_a^{\xi+\Delta\xi} f(x)dx$ , and the increment  $\Delta A$  of the area is given by the formula

$$\Delta A = \int_{\xi}^{\xi+\Delta\xi} f(x)dx,$$

which represents the area  $BDD'B'$ . This area is intermediate

between those of two rectangles, having as a common base the segment  $BB'$ , and as heights the greatest and least ordinates of points on the arc  $DD'$  of the curve. Let these heights be  $H$  and  $h$ . Then  $\Delta A$  is intermediate between  $H\Delta\xi$  and  $h\Delta\xi$ , and the quotient of differences  $\Delta A/\Delta\xi$  is intermediate between  $H$  and  $h$ . If the function  $f(x)$  is continuous at B (see FUNCTION), then, as  $\Delta\xi$  is diminished without limit,  $H$  and  $h$  tend to  $BD$ , or  $f(\xi)$ , as a limit, and we have

$$\frac{dA}{d\xi} = f(\xi).$$

The introduction of the process of differentiation, together with the theorem here proved, placed the solution of the problem of quadratures on a new basis. It appears that we can always find the area  $A$  if we know a function  $F(x)$  which has  $f(x)$  as its differential coefficient. If  $f(x)$  is continuous between  $a$  and  $b$ , we can prove that

$$A = \int_a^b f(x)dx = F(b) - F(a).$$

When we recognize a function  $F(x)$  which has the property expressed by the equation

$$\frac{dF(x)}{dx} = f(x),$$

we are said to *integrate* the function  $f(x)$ , and  $F(x)$  is called the *indefinite integral of  $f(x)$  with respect to  $x$* , and is written  $\int f(x)dx$ .

7. In the process of § 4 the increment  $\Delta y$  is not in general equal to the product of the increment  $\Delta x$  and the derived function  $f'(x)$ . In general we can write down an equation of the form

$$\Delta y = f'(x)\Delta x + R,$$

in which  $R$  is different from zero when  $\Delta x$  is different from zero; and then we have not only

$$\lim_{\Delta x \rightarrow 0} R = 0,$$

but also

$$\lim_{\Delta x \rightarrow 0} \frac{R}{\Delta x} = 0.$$

We may separate  $\Delta y$  into two parts: the part  $f'(x)\Delta x$  and the part  $R$ . The part  $f'(x)\Delta x$  alone is useful for forming the differential coefficient, and it is convenient to give it a name. It is called the *differential of  $f(x)$* , and is written  $d(f(x))$ , or  $dy$  when  $y$  is written for  $f(x)$ . When this notation is adopted  $dx$  is written instead of  $\Delta x$ , and is called the "differential of  $x$ ," so that we have

$$d(f(x)) = f'(x)dx.$$

Thus the differential of an independent variable such as  $x$  is a finite difference; in other words it is any number we please. The differential of a dependent variable such as  $y$ , or of a function of the independent variable  $x$ , is the product of the differential of  $x$  and the differential coefficient or derived function. It is important to observe that the differential coefficient is not to be defined as the ratio of differentials, but the ratio of differentials is to be defined as the previously introduced differential coefficient. The differentials

FIG. 4.



are either finite differences, or are so much of certain finite differences as are useful for forming differential coefficients.

Again let  $F(x)$  be the indefinite integral of a continuous function  $f(x)$ , so that we have

$$\frac{dF(x)}{dx} = f(x), \int f(x)dx = F(b) - F(a).$$

When the points  $M$  of the process explained in § 5 are inserted between the points whose abscissae are  $a$  and  $b$ , we may take them to be  $n-1$  in number, so that the segment  $AB$  is divided into  $n$  segments. Let  $x_1, x_2, \dots, x_{n-1}$  be the abscissae of the points in order. The integral is the limit of the sum

$$f(a)(x_1-a) + f(x_1)(x_2-x_1) + \dots + f(x_{n-1})(x_n-x_{n-1})$$

every term of which is a differential of the form  $f(x)dx$ . Further the integral is equal to the sum of differences

$$[F(x_1) - F(a)] + [F(x_2) - F(x_1)] + \dots + [F(x_n) - F(x_{n-1})],$$

for this sum is  $F(b) - F(a)$ . Now the difference  $F(x_{r+1}) - F(x_r)$  is not equal to the differential  $(f(x_r)(x_{r+1} - x_r))$ , but the sum of the differences is equal to the limit of the sum of these differentials. The differential may be regarded as so much of the difference as is required to form the integral. From this point of view a differential is called a *differential element of an integral*, and the integral is the limit of the sum of differential elements. In like manner the differential element  $ydx$  of the area of a curve (§ 5) is not the area of the portion contained between two ordinates, however near together, but is so much of this area as need be retained for the purpose of finding the area of the curve by the limiting process described.

8. The notation of the infinitesimal calculus is intimately bound up with the notions of differentials and sums of elements. The letter *Notation*. "d" is the initial letter of the word *differencia* (difference) and the symbol "f" is a conventionally written "S," the initial letter of the word *summa* (sum or whole). The notation was introduced by Leibnitz (see §§ 25-27, below).

9. The fundamental artifice of the calculus is the artifice of forming differentials without first forming differential coefficients. From an equation containing  $x$  and  $y$  we can deduce a new equation,

containing also  $\Delta x$  and  $\Delta y$ , by substituting  $x + \Delta x$  for  $x$  and  $y + \Delta y$  for  $y$ . If there is a differential coefficient for  $y$  with respect to  $x$ , then  $\Delta y$  can be expressed in the form  $\phi \Delta x + R$ , where  $\lim_{\Delta x \rightarrow 0} (R/\Delta x) = 0$ , as in § 7 above. The artifice

consists in rejecting *ab initio* all terms of the equation which belong to  $R$ . We do not form  $R$  at all, but only  $\phi \Delta x$ , or  $\phi dx$ , which is the differential  $dy$ . In the same way, in all applications of the integral calculus to geometry or mechanics we form the *element* of an integral in the same way as the element of area  $y dx$  is formed. In fig. 5 of § 5 the element of area  $y dx$  is the area of the rectangle  $RM$ . The actual area of the curvilinear figure  $PQNM$  is greater than the area of this rectangle by the area of the curvilinear figure  $PQR$ ; but the excess is less than the area of the rectangle  $PROQ$ , which is measured by the product of the numerical measures of  $MN$  and  $QR$ , and we have

$$\lim_{MN \rightarrow 0} \frac{MN \cdot QR}{MN} = 0.$$

Thus the artifice by which differential elements of integrals are formed is in principle the same as that by which differentials are formed without first forming differential coefficients.

10. This principle is usually expressed by introducing the notion of *Orders of small quantities*. If  $x, y$  are two variable numbers which are connected together by any relation, and if when  $x$  tends to zero  $y$  also tends to zero, the fraction  $y/x$  may tend to a finite limit. In this case  $x$  and  $y$  are said to be "of the same order." When this is not the case we may have

$$\lim_{x \rightarrow 0} \frac{y}{x} = 0,$$

or

$$\lim_{x \rightarrow 0} \frac{y}{x^2} = 0.$$

In the former case  $y$  is said to be "of a lower order" than  $x$ ; in the latter case  $y$  is said to be "of a higher order" than  $x$ . In accordance with this notion we may say that the fundamental artifice of the infinitesimal calculus consists in the rejection of small quantities of an unnecessarily high order. This artifice is now merely an incident in the conduct of a limiting process, but in the 17th century, when limiting processes other than the Greek methods for quadratures were new, the introduction of the artifice was a great advance.

11. By the aid of this artifice, or directly by carrying out the appropriate limiting processes, we may obtain the rules by which differential coefficients are formed. These rules may be classified as "formal rules" and "particular results." The formal rules may be stated as follows:—

(i.) The differential coefficient of a constant is zero.

(ii.) For a sum  $u+v+\dots+z$ , where  $u, v, \dots, z$  are functions of  $x$ ,

$$\frac{d(u+v+\dots+z)}{dx} = \frac{du}{dx} + \frac{dv}{dx} + \dots + \frac{dz}{dx}.$$

(iii.) For a product  $w$

$$\frac{d(uv)}{dx} = u \frac{dv}{dx} + \frac{du}{dx} v.$$

(iv.) For a quotient  $u/v$

$$\frac{d(u/v)}{dx} = \left( \frac{du}{dx} \frac{v}{u} - \frac{dv}{dx} \right) / v^2.$$

(v.) For a function of a function, that is to say, for a function  $y$  expressed in terms of a variable  $x$ , which is itself expressed as a function of  $x$ ,

$$\frac{dy}{dx} = \frac{dy}{dz} \frac{dz}{dx}.$$

In addition to these formal rules we have particular results as to the differentiation of simple functions. The most important results are written down in the following table:—

$y$	$\frac{dy}{dx}$
$x^n$	$n x^{n-1}$ for all values of $n$
$\log_a x$	$x^{-1} \log_e a$
$a^x$	$a^x \log_e a$
$\sin x$	$\cos x$
$\cos x$	$-\sin x$
$\sin^{-1} x$	$(1-x^2)^{-1/2}$
$\tan^{-1} x$	$(1+x^2)^{-1}$

Each of the formal rules, and each of the particular results in the table, is a theorem of the differential calculus. All functions (or rather expressions) which can be made up from those in the table by a finite number of operations of addition, subtraction, multiplication or division can be differentiated by the formal rules. All such functions are called *explicit functions*. In addition to these we have *implicit functions*, or such as are determined by an equation containing two variables when the equation cannot be solved so as to exhibit the one variable expressed in terms of the other. We have also functions of several variables. Further, since the derived function of a given function is itself a function, we may seek to differentiate it, and thus there arise the second and higher differential coefficients. We postpone for the present the problems of differential calculus which arise from these considerations. Again, we may have explicit functions which are expressed as the results of limiting operations, or by the limits of the results obtained by performing an infinite number of algebraic operations upon the simple functions. For the problem of differentiating such functions reference may be made to FUNCTION.

12. The processes of the integral calculus consist largely in transformations of the functions to be integrated into such *Indefinite Integrals*. forms that they can be recognized as differential coefficients of functions which have previously been differentiated. Corresponding to the results in the table of § 11 we have those in the following table:—

$f(x)$	$\int f(x)dx$
$x^n$	$\frac{x^{n+1}}{n+1}$ for all values of $n$ except $-1$
$\frac{1}{x}$	$\log_e x$
$e^{ax}$	$a^{-1} e^{ax}$
$\cos x$	$\sin x$
$\sin x$	$-\cos x$
$(a^2 - x^2)^{-1/2}$	$\sin^{-1} \frac{x}{a}$
$\frac{1}{a^2 + x^2}$	$\frac{1}{a} \tan^{-1} \frac{x}{a}$

The formal rules of § 11 give us means for the transformation of integrals into recognizable forms. For example, the rule (ii.) for a sum leads to the result that the integral of a sum of a finite number of terms is the sum of the integrals of the several terms. The rule (iii.) for a product leads to the method of integration by parts. The rule (v.) for a function of a function leads to the method of substitution (see § 18 below).

## II. History.

13. The new limiting processes which were introduced in the development of the higher analysis were in the first instance related to problems of the integral calculus. Johannes Kepler in his *Astronomia nova . . . de motibus stellae Martis* (1609) stated his laws of planetary motion, to the effect that the orbits of the planets are ellipses with the sun at a focus, and that the radii vectors drawn from the sun to the planets describe equal areas in equal times. From these statements it is to be concluded that Kepler could measure the areas of focal sectors of an ellipse. When he made out these laws there was no method of evaluating areas except the Greek methods. These methods would have sufficed for the purpose, but Kepler invented his own method. He regarded the area as measured by the "sum of the radii" drawn from the focus, and he verified his laws of planetary motion by actually measuring a large number of radii of the orbit, spaced according to a rule, and adding their lengths.

He had observed that the focal radius vector  $SP$  (fig. 5) is equal to the perpendicular  $SZ$  drawn from  $S$  to the tangent at  $P$  to the auxiliary circle, and he had further established the theorem which we should now express in the form—the differential element of the area  $ASP$  as  $Sp$  turns about  $S$ , is equal to the product of  $SZ$  and the differential  $ad\phi$ , where  $a$  is the radius of the auxiliary circle, and  $\phi$  is the angle  $ACP$ , that is the eccentric angle of  $P$  on the ellipse. The area  $ASP$  bears to the area  $ASp$  the ratio of the minor to the major axis, a result known to Archimedes. Thus Kepler's radii are spaced according to the rule that the eccentric angles of their ends are equidifferent, and his "sum of radii" is proportional to the expression which we should now write

$$\int \phi (a + ae \cos \phi) d\phi,$$

where  $e$  is the eccentricity. Kepler evaluated the sum as proportional to  $\phi + e \sin \phi$ .

Kepler soon afterwards occupied himself with the volumes of solids. The vintage of the year 1612 was extraordinarily abundant, and the question of the cubic content of wine casks was brought under his notice. This fact accounts for the title of his work, *Nova stereometria doliorum; accessit stereometriae Archimedaeae supplementum* (1615). In this treatise he regarded solid bodies as being made up, as it were (*veluti*), of "infinitely" many "infinitely" small cones or "infinitely" thin disks, and he used the notion of summing the areas of the disks in the way he had previously used the notion of summing the focal radii of an ellipse.

14. In connexion with the early history of the calculus it must not be forgotten that the method by which logarithms were invented (1614) was effectively a method of infinitesimals. Natural logarithms were not invented as the indices of a certain base, and the notation  $e$  for the base was first introduced by Euler more than a century after the invention. Logarithms were introduced as numbers which increase in arithmetic progression when other related numbers increase in geometric progression. The two sets of numbers were supposed to increase together, one at a uniform rate, the other at a variable rate, and the increments were regarded for purposes of calculation as very small and as accruing discontinuously.

15. Kepler's methods of integration, for such they must be called, were the origin of Bonaventura Cavalieri's theory of the summation of indivisibles. The notion of a continuum, such as the area within a closed curve, as being made up of indivisible parts, "atoms" of area, if the expression may be allowed, is traceable to the speculations of early Greek philosophers; and although the nature of continuity was better understood by Aristotle and many other ancient writers yet the unsound atomic conception was revived in the 13th century and has not yet been finally uprooted. It is possible to contend that Cavalieri did not himself hold the unsound doctrine, but his writing on this point is rather obscure. In his treatise *Geometria indivisibilibus continuorum nova quadam ratione promota* (1635) he regarded

a plane figure as generated by a line moving so as to be always parallel to a fixed line, and a solid figure as generated by a plane moving so as to be always parallel to a fixed plane; and he compared the areas of two plane figures, or the volumes of two solids, by determining the ratios of the sums of all the indivisibles of which they are supposed to be made up, these indivisibles being segments of parallel lines equally spaced in the case of plane figures, and areas marked out upon parallel planes equally spaced in the case of solids. By this method Cavalieri was able to effect numerous integrations relating to the areas of portions of conic sections and the volumes generated by the revolution of these portions about various axes. At a later date, and partly in answer to an attack made upon him by Paul Guldin, Cavalieri published a treatise entitled *Exercitationes geometricae sex* (1647), in which he adapted his method to the determination of centres of gravity, in particular for solids of variable density.

Among the results which he obtained is that which we should now write

$$\int x^m dx = \frac{x^{m+1}}{m+1}, (m \text{ integral}).$$

He regarded the problem thus solved as that of determining the sum of the  $m$ th powers of all the lines drawn across a parallelogram parallel to one of its sides.

At this period scientific investigators communicated their results to one another through one or more intermediate persons. Such intermediaries were Pierre de Carcavy and Pater Marin Mersenne; and among the writers thus in communication were Bonaventura Cavalieri, Christian Huygens, Galileo Galilei, Giles Personnier de Roberval, Pierre de Fermat, Evangelista Torricelli, and a little later Blaise Pascal; but the letters of Carcavy or Mersenne would probably come into the hands of any man who was likely to be interested in the matters discussed. It often happened, that, when some new method was invented, or some new result obtained, the method or result was quickly known to a wide circle, although it might not be printed until after the lapse of a long time. When Cavalieri was printing his two treatises there was much discussion of the problem of quadratures. Roberval (1634) regarded an area as made up of "infinitely" many "infinitely" narrow strips, each of which may be considered to be a rectangle, and he had similar ideas in regard to lengths and volumes. He knew how to approximate to the quantity which we express by  $\int x^m dx$  by the process of forming the sum

$$\frac{0^m + 1^m + 2^m + \dots + (n-1)^m}{n^{m+1}},$$

and he claimed to be able to prove that this sum tends to  $1/(m+1)$ , as  $n$  increases for all positive integral values of  $m$ . The method of integrating  $x^m$  by forming this sum was found also by Fermat (1636), who stated expressly that he arrived at it by generalizing a method employed by Archimedes (for the cases  $m=1$  and  $m=2$ ) in his books on *Conoids and Spheroids* and on *Spirals* (see T. L. Heath, *The Works of Archimedes*, Cambridge, 1897). Fermat extended the result to the case where  $m$  is fractional (1644), and to the case where  $m$  is negative. This latter extension and the proofs were given in his memoir, *Proportionis geometricae in quadrandis parabolis et hyperbolis usus*, which appears to have received a final form before 1650, although not published until 1679. Fermat did not use fractional or negative indices, but he regarded his problems as the quadratures of parabolas and hyperbolas of various orders. His method was to divide the interval of integration into parts by means of intermediate points the  $\delta$ -series of which are in geometric progression. In the process of § 5 above, the points  $M$  must be chosen according to this rule. This restrictive condition being understood, we may say that Fermat's formulation of the problem of quadratures is the same as our definition of a definite integral.

The result that the problem of quadratures could be solved for any curve whose equation could be expressed in the form

$$y = x^m (m \neq -1),$$

or in the form

$$y = a_1 x^{m_1} + a_2 x^{m_2} + \dots + a_n x^{m_n},$$

Kepler's  
methods  
of integrat-  
tion.



FIG. 5.

Successors  
of Cavalieri.

Logarithms.

Cavalieri's  
indivisibles.

Fermat's  
method of  
integration.

where none of the indices is equal to  $-1$ , was used by John Wallis in his *Arithmetica infinitorum* (1655) as well as by Fermat (1659). The case in which  $m = -1$  was that of the ordinary rectangular hyperbola; and Gregory of St Vincent in his *Opus geometricum quadraturae circuli et sectionum conici* (1647) had proved by the method of exhaustions that the area contained between the curve, one asymptote, and two ordinates parallel to the other asymptote, increases in arithmetic progression as the distance between the ordinates (the one nearer to the centre being kept fixed) increases in geometric progression. Fermat described his method of integration as a logarithmic method, and thus it is clear that the relation between the quadrature of the hyperbola and logarithms was understood although it was not expressed analytically. It was not very long before the relation was used for the calculation of logarithms by Nicolaus Mercator in his *Logarithmotechnia* (1668). He began by writing the equation of the curve in the form  $y = 1/(1+x)$ , expanded this expression in powers of  $x$  by the method of division, and integrated it term by term in accordance with the well-understood rule for finding the quadrature of a curve given by such an equation as that written at the foot of p. 325.

By the middle of the 17th century many mathematicians could perform integrations. Very many particular results had been obtained, and applications of them had been made to the quadrature of the circle and other conic sections, and to various problems concerning the lengths of curves, the areas they enclose, the volumes and superficial areas of solids, and centres of gravity. A systematic account of the methods then in use was given, along with much that was original on his part, by Blaise Pascal in his *Lettres de Amos Deltonville sur quelques-unes de ses inventions en géométrie* (1659).

16. The problem of maxima and minima and the problem of tangents had also by the same time been effectively solved.

Oresme in the 14th century knew that at a point where the ordinate of a curve is a maximum or a minimum its variation from point to point of the curve is slowest; and Kepler in the *Stereometria doliorum* remarked that at the places where the ordinate passes from a smaller value to the greatest value and then again to a smaller value, its variation becomes insensible. Fermat in 1629 was in possession of a method which he then communicated to one Despagne of Bordeaux, and which he referred to in a letter to Roberval of 1636. He communicated it to René Descartes early in 1638 on receiving a copy of Descartes's *Géométrie* (1637), and with it he sent to Descartes an account of his methods for solving the problem of tangents and for determining centres of gravity.

Fermat's method for maxima and minima is essentially our method. Expressed in a more modern notation, what he did was to begin by connecting the ordinate  $y$  and the abscissa  $x$  of a point of a curve by an equation which holds at all points of the curve, then to subtract the value of  $y$  in terms of  $x$  from the value obtained by substituting  $x+E$  for  $x$ , then to divide the difference by  $E$ , to put  $E=0$  in the quotient, and to equate the quotient to zero. Thus he differentiated with respect to  $x$  and equated the differential coefficient to zero.

Fermat's method for solving the problem of tangents may be explained as follows:— Let  $(x, y)$  be the coordinates of a point  $P$  of a curve,  $(x', y')$  those of a neighbouring point  $P'$  on the tangent at  $P$ , and let  $MM' = E$  (fig. 6).

From the similarity of the triangles  $P'TM'$ ,  $PTM$  we have  $y':A - E = y:A$ , where  $A$  denotes the subtangent  $TM$ . The point  $P'$  being near the curve, we may substitute in the equation of the curve  $x-E$  for  $x$  and  $(y-A-E)/A$  for  $y$ . The equation of the curve is approximately satisfied. If it is taken to be satisfied exactly, the result is an equation of the form  $\phi(x, y, A, E) = 0$ , the left-hand member of which is divisible by  $E$ . Omitting the factor  $E$ , and putting  $E=0$  in the remaining factor, we have an equation which gives  $A$ . In this problem of tangents also Fermat found the required result by a process equivalent to differentiation.

Fermat gave several examples of the application of his method;

among them was one in which he showed that he could differentiate very complicated irrational functions. For such functions his method was to begin by obtaining a rational equation. In rationalizing equations Fermat, in other writings, used the device of introducing new variables, but he did not use this device to simplify the process of differentiation. Some of his results were published by Pierre Héron in his *Supplementum cursus mathematici* (1642). His communication to Descartes was not published in full until after his death (Fermat, *Opera varia*, 1679). Methods similar to Fermat's were devised by René de Sluse (1652) for tangents, and by Johannes Hudde (1658) for maxima and minima. Other methods for the solution of the problem of tangents were devised by Roberval and Torricelli, and published almost simultaneously in 1644. These methods were founded upon the composition of motions, the theory of which had been taught by Galileo (1638), and, less completely, by Roberval (1636). Roberval and Torricelli could construct the tangents of many curves, but they did not arrive at Fermat's artifice. This artifice is that which we have noted in §10 as the fundamental artifice of the infinitesimal calculus.

17. Among the comparatively few mathematicians who before 1665 could perform differentiations was Isaac Barrow. In his book entitled *Lectiones opticae et geometricae*, written apparently in 1663, 1664, and published in 1669, 1670, he gave a method of tangents like that of Roberval and Torricelli, compounding two velocities in the directions of the axes of  $x$  and  $y$  to obtain a resultant along the tangent to a curve. In an appendix to this book he gave another method which differs from Fermat's in the introduction of a differential equivalent to our  $dy$  as well as  $dx$ . Two neighbouring ordinates  $PM$  and  $QN$  of a curve (fig. 7) are regarded as containing an indefinitely small (*indefinite parvum*) arc, and  $PR$  is drawn parallel to the axis of  $x$ . The tangent  $PT$  at  $P$  is regarded as identical with the secant  $PQ$ , and the position of the tangent is determined by the similarity of the triangles  $PTM$ ,  $PQR$ . The increments  $QR$ ,  $PR$  of the ordinate and abscissa are denoted by  $a$  and  $e$ ; and the ratio of  $a$  to  $e$  is determined by substituting  $x+e$  for  $x$  and  $y+a$  for  $y$  in the equation of the curve, rejecting all terms which are of order higher than the first in  $a$  and  $e$ , and omitting the terms which do not contain  $a$  or  $e$ . This process is equivalent to differentiation. Barrow appears to have invented it himself, but to have put it into his book at Newton's request. The triangle  $PQR$  is sometimes called "Barrow's differential triangle."

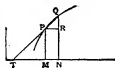

FIG. 7.

The reciprocal relation between differentiation and integration (§ 6) was first observed explicitly by Barrow in the book cited above. If the quadrature of a curve  $y=f(x)$  is known, so that the area up to the ordinate  $x$  is given by  $F(x)$ , the curve  $y=f(x)$  can be drawn, and Barrow showed that the subtangent of this curve is measured by the ratio of its ordinate to the ordinate of the original curve. The curve  $y=F(x)$  is often called the "quadratrix" of the original curve; and the result has been called "Barrow's inversion-theorem." He did not use it as we do for the determination of quadratures, or indefinite integrals, but for the solution of problems of the kind which were then called "inverse problems of tangents." In these problems it was sought to determine a curve from some property of its tangent, e.g. the property that the subtangent is proportional to the square of the abscissa. Such problems are now classed under "differential equations." When Barrow wrote, quadratures were familiar and differentiation unfamiliar, just as hyperbolas were trusted while logarithms were strange. The functional notation was not invented till long afterwards (see FUSCATION), and the want of it is felt in reading all the mathematics of the 17th century.

18. The great secret which afterwards came to be called the "infinitesimal calculus" was almost discovered by Fermat, and still more nearly by Barrow. Barrow went farther than Fermat in the theory of differentiation, though not in the practice, for he compared two increments; he went farther in the theory of integration, for he obtained the inversion-theorem. The great discovery seems to consist partly in the

recognition of the fact that differentiation, known to be a useful process, could always be performed, at least for the functions then known, and partly in the recognition of the fact that the inversion-theorem could be applied to problems of quadrature. By these steps the problem of tangents could be solved once for all, and the operation of integration, as we call it, could be rendered systematic. A further step was necessary in order that the discovery, once made, should become accessible to mathematicians in general; and this step was the introduction of a suitable notation. The definite abandonment of the old tentative methods of integration in favour of the method in which this operation is regarded as the inverse of differentiation was especially the work of Isaac Newton; the precise formulation of simple rules for the process of differentiation in each special case, and the introduction of the notation which has proved to be the best, were especially the work of Gottfried Wilhelm Leibnitz. This statement remains true although Newton invented a systematic notation, and practised differentiation by rules equivalent to those of Leibnitz, before Leibnitz had begun to work upon the subject, and Leibnitz effected integrations by the method of recognizing differential coefficients before he had had any opportunity of becoming acquainted with Newton's methods.

10. Newton was Barrow's pupil, and he knew to start with in 1664 all that Barrow knew, and that was practically all that was known about the subject at that time. His original thinking on the subject dates from the year of the great plague (1665-1666), and it issued in the invention of the "Calculus of Fluxions," the principles and methods of which were developed by him in three tracts entitled *De analysi per aequationes numero terminorum infinitas*, *Methodus fluxionum et serierum infinitarum*, and *De quadratura curvarum*. None of these was published until long after they were written. The *Analysis per aequationes* was composed in 1666, but not printed until 1711, when it was published by William Jones. The *Methodus fluxionum* was composed in 1671 but not printed till 1736, nine years after Newton's death, when an English translation was published by John Colson. In Horsley's edition of Newton's works it bears the title *Geometria analytica*. The *Quadratura* appears to have been composed in 1676, but was first printed in 1704 as an appendix to Newton's *Opticks*.

20. The tract *De Analysi per aequationes* . . . was sent by Newton to Barrow, who sent it to John Collins with a request that it might be made known. One way of making it known would have been to print it in the *Philosophical Transactions* of the Royal Society, but this course was not adopted. Collins made a copy of the tract and sent it to Lord Brouncker, but neither of them brought it before the Royal Society. The tract contains a general proof of Barrow's inversion-theorem which is the same in principle as that in § 6 above. In this proof and elsewhere in the tract a notation is introduced for the momentary increment (*momentum*) of the abscissa or area of a curve; this "moment" is evidently meant to represent a moment of time, the abscissa representing time, and it is effectively the same as our differential element—the thing that Fermat had denoted by  $E$ , and Barrow by  $e$ , in the case of the abscissa. Newton denoted the moment of the abscissa by  $o$ , that of the area  $z$  by  $oz$ . He used the letter  $v$  for the ordinate  $y$ , thus suggesting that his curve is a velocity-time graph such as Galileo had used. Newton gave the formula for the area of a curve  $v = x^m$  ( $m \neq -1$ ) in the form  $z = x^{m+1}/(m+1)$ . In the proof he transformed this formula to the form  $oz = c^p x^p$ , where  $\pi$  and  $p$  are positive integers, substituted  $x+\theta$  for  $x$  and  $z+\theta z$  for  $z$ , and expanded by the binomial theorem for a positive integral exponent, thus obtaining the relation

$$oz + m\pi z^{\pi-1}\theta + \dots = c^p(x^p + px^{p-1}\theta + \dots),$$

from which he deduced the relation

$$m\pi z^{\pi-1}\theta = c^p px^{p-1}\theta$$

by omitting the equal terms  $oz$  and  $c^p x^p$  and dividing the remaining terms by  $\theta$ , tacitly putting  $\theta = 0$  after division. This relation is the same as  $v = x^m$ . Newton pointed out that, conversely, from the relation  $v = x^m$  the relation  $z = x^{m+1}/(m+1)$  follows. He applied his formula to the quadrature of curves whose ordinates can be expressed as the sum of a finite number of terms of the form  $ax^m$ ; and gave examples of its application to curves in which the ordinate is expressed

by an infinite series, using for this purpose the binomial theorem for negative and fractional exponents, that is to say, the expansion of  $(1+x)^n$  in an infinite series of powers of  $x$ . This theorem he had discovered; but he did not in this tract state it in a general form or give any proof of it. He pointed out, however, how it may be used for the solution of equations by means of infinite series. He observed also that all questions concerning lengths of curves, volumes enclosed by surfaces, and centres of gravity, can be formulated as problems of quadratures, and can thus be solved either in finite terms or by means of infinite series. In the *Quadratura* (1676) the method of integration which is founded upon the inversion-theorem was carried out systematically. Among other results there given is the quadrature of curves expressed by equations of the form  $y = x^m(a+bx^n)^p$ ; this has passed into text-books under the title "integration of binomial differentials" (see § 49). Newton announced the result in letters to Collins and Oldenburg of 1676.

21. In the *Methodus fluxionum* (1671) Newton introduced his characteristic notation. He regarded variable quantities as generated by the motion of a point, or line, or plane, and called the generated quantity a "fluent" and its rate of generation a "fluxion." The fluxion of a fluent  $x$  is represented by  $\dot{x}$ , and its moment, or "infinitely" small increment accruing in an "infinitely" short time, is represented by  $\delta x$ . The problems of the calculus are stated to be (i), to find the velocity at any time when the distance traversed is given; (ii), to find the distance traversed when the velocity is given. The first of these leads to differentiation. In any rational equation containing  $x$  and  $y$  the expressions  $x+\delta x$  and  $y+\delta y$  are to be substituted for  $x$  and  $y$ , the resulting equation is to be divided by  $\delta$ , and afterwards  $\delta$  is to be omitted. In the case of irrational functions, or rational functions which are not integral, new variables are introduced in such a way as to make the equations contain rational integral terms only. Thus Newton's rules of differentiation would be in our notation the rules (i.), (ii.), (v.) of § 11, together with the particular rule which we write

$$\frac{d}{dx} x^m = mx^{m-1}, \quad (m \text{ integral}).$$

a result which Newton obtained by expanding  $(x+\delta x)^m$  by the binomial theorem. The second problem is the problem of integration, and Newton's method for solving it was the method of series founded upon the particular result which we write

$$\int x^m dx = \frac{x^{m+1}}{m+1}$$

Newton added applications of his methods to maxima and minima, tangents and curvature. In a letter to Collins of late 1672 Newton stated that he had certain methods, and he described certain results which he had found by using them. These methods and results are those which are to be found in the *Methodus fluxionum*; but the letter makes no mention of fluxions and fluents or of the characteristic notation. The rule for tangents is said in the letter to be analogous to de Sluse's, but to be applicable to equations that contain irrational terms.

22. Newton gave the fluxional notation also in the tract *De Quadratura curvarum* (1676), and he there added to it notation for the higher differential coefficients and for indefinite integrals, as we call them. Just as  $x, y, z, \dots$  are fluents of which  $\dot{x}, \dot{y}, \dot{z}, \dots$  are the fluxions, so  $\dot{x}, \dot{y}, \dot{z}, \dots$  can be treated as fluents of which the fluxions may be denoted by  $\ddot{x}, \ddot{y}, \ddot{z}, \dots$ . In like manner the fluxions of these may be denoted by  $\ddot{\dot{x}}, \ddot{\dot{y}}, \ddot{\dot{z}}, \dots$  and so on. Again  $x, y, z, \dots$  may be regarded as fluxions of which the fluents may be denoted by  $\int x, \int y, \int z, \dots$  and these again as fluxions of other quantities denoted by  $\int \int x, \int \int y, \int \int z, \dots$  and so on. No use was made of the notation  $\int \dot{x}, \int \dot{y}, \int \dot{z}, \dots$  in the course of the tract. The first publication of the fluxional notation was made by Wallis in the second edition of his *Algebra* (1663) in the form of extracts from communications made to him by Newton in 1692. In this account of the method the symbols  $o, \dot{x}, \dot{z}, \dots$  occur, but not the symbols  $\dot{x}, \dot{z}, \dots$ . Wallis's treatise also contains Newton's formulation of the problems of the calculus in the words *Dava aequatione fluente quocumque quantitates involvunt fluxiones invenit et vice versa* ("an equation containing any number of fluent quantities being given, to find their fluxions and vice versa"). In the *Philosophiae naturalis principia mathematica* (1687), commonly called the "Principia," the words "fluxion" and "moment" occur in a lemma in the second book; but the notation which is characteristic of the calculus of fluxions is nowhere used.

23. It is difficult to account for the fragmentary manner of publication of the Fluxional Calculus and for the long delays which took place. At the time (1671) when Newton composed the *Methodus fluxionum* he contemplated bringing out an edition of Gerhard Kinckhuysen's treatise on algebra and prefixing his tract to this treatise. In the same year his "Theory of Light and Colours" was published in the *Philosophical Transactions*, and the opposition which it excited led to the abandonment of

the project with regard to fluxions. In 1680 Collins sought the assistance of the Royal Society for the publication of the tract, and this was granted in 1682. Yet it remained unpublished. The reason is unknown; but it is known that about 1679, 1680, Newton took up again the studies in natural philosophy which he had intermitted for several years, and that in 1684 he wrote the tract *De motu* which was in some sense a first draft of the *Principia*, and it may be conjectured that the fluxions were held over until the *Principia* should be finished. There is also reason to think that Newton had become dissatisfied with the arguments about infinitesimals on which his calculus was based. In the preface to the *De quadratura curvarum* (1704), in which he describes this tract as something which he once wrote ("olim scripsi") he says that there is no necessity to introduce into the method of fluxions any argument about infinitely small quantities; and in the *Principia* (1687) he adopted instead of the method of fluxions a new method, that of "Prime and Ultimate Ratios." By the aid of this method it is possible, as Newton knew, and as was afterwards seen by others, to found the calculus of fluxions on an irreproachable method of limits. For the purpose of explaining his discoveries in dynamics and astronomy Newton used the method of limits only, without the notation of fluxions, and he presented all his results and demonstrations in a geometrical form. There is no doubt that he arrived at most of his theorems in the first instance by using the method of fluxions. Further evidence of Newton's dissatisfaction with arguments about infinitely small quantities is furnished by his tract *Methodus differentialis*, published in 1711 by William Jones, in which he laid the foundations of the "Calculus of Finite Differences."

24. Leibnitz, unlike Newton, was practically a self-taught mathematician. He seems to have been first attracted to mathematics as a means of symbolical expression, and on the occasion of his first visit to London, early in 1673, he learnt about the doctrine of infinite series which James Gregory, Nicolaus Mercator, Lord Brouncker and others, besides Newton, had used in their investigations. It appears that he did not on this occasion become acquainted with Collins, or see Newton's *Analysis per aequationes*, but he purchased Barrow's *Lectiones*. On returning to Paris he made the acquaintance of Huygens, who recommended him to read Descartes' *Géométrie*. He also read Pascal's *Lettres de Deatonville*, Gregory of St Vincent's *Opus geometricum*, Cavalieri's *Indivisibles* and the *Synopsis geometrica* of Honoré Fabri, a book which is practically a commentary on Cavalieri; it would never have had any importance but for the influence which it had on Leibnitz's thinking at this critical period. In August of this year (1673) he was at work upon the problem of tangents, and he appears to have made out the nature of the solution—the method involved in Barrow's differential triangle—for himself by the aid of a diagram drawn by Pascal in a demonstration of the formula for the area of a spherical surface. He saw that the problem of the relation between the differences of neighbouring ordinates and the ordinates themselves was the important problem, and then that the solution of this problem was to be effected by quadratures. Unlike Newton, who arrived at differentiation and tangents through integration and areas, Leibnitz proceeded from tangents to quadratures. When he turned his attention to quadratures and indivisibles, and realized the nature of the process of finding areas by summing "infinitesimal" rectangles, he proposed to replace the rectangles by triangles having a common vertex, and obtained by this method the result which we write

$$\frac{1}{2}x = 1 - \frac{1}{2} + \frac{1}{2} - \frac{1}{4} + \dots$$

In 1674 he sent an account of his method, called "transmutation," along with this result to Huygens, and early in 1675 he sent it to Henry Oldenburg, secretary of the Royal Society, with inquiries as to Newton's discoveries in regard to quadratures. In October of 1675 he had begun to devise a symbolical notation for quadratures, starting from Cavalieri's indivisibles. At first he proposed to use the word *omnia* as an abbreviation for Cavalieri's "sum of all the lines," thus writing *omnia y* for that

which we write " $\int y dx$ ," but within a day or two he wrote "fy." He regarded the symbol "f" as representing an operation which raises the dimensions of the subject of operation—a line becoming an area by the operation—and he devised his symbol "d" to represent the inverse operation, by which the dimensions are diminished. He observed that, whereas "f" represents "sum," "d" represents "difference." His notation appears to have been practically settled before the end of 1675, for in November he wrote  $f y dy = \frac{1}{2} y^2$ , just as we do now.

25. In July of 1676 Leibnitz received an answer to his inquiry in regard to Newton's methods in a letter written by Newton to Oldenburg. In this letter Newton gave a general statement of the binomial theorem and many results relating to series. He stated that by means of such series he could find areas and lengths of curves, centres of gravity and volumes and surfaces of solids, but, as this would take too long to describe, he would illustrate it by examples. He gave no proofs. Leibnitz replied in August, stating some results which he had obtained, and which, as it seemed, could not be obtained easily by the method of series, and he asked for further information. Newton replied in a long letter to Oldenburg of the 24th of October 1676. In this letter he gave a much fuller account of his binomial theorem and indicated a method of proof. Further he gave a number of results relating to quadratures; they were afterwards printed in the tract *De quadratura curvarum*. He gave many other results relating to the computation of natural logarithms and other calculations in which series could be used. He gave a general statement, similar to that in the letter to Collins, as to the kind of problems relating to tangents, maxima and minima, &c., which he could solve by his method, but he concealed his formulation of the calculus in an anagram of transposed letters. The solution of the anagram was given eleven years later in the *Principia* in the words we have quoted from Wallis's *Algebra*. In neither of the letters to Oldenburg does the characteristic notation of the fluxional calculus occur, and the words "fluxion" and "fluent" occur only in anagrams of transposed letters. The letter of October 1676 was not despatched until May 1677, and Leibnitz answered it in June of that year. In October 1676 Leibnitz was in London, where he made the acquaintance of Collins and read the *Analysis per aequationes*, and it seems to have been supposed afterwards that he then read Newton's letter of October 1676, but he left London before Oldenburg received this letter. In his answer of June 1677 Leibnitz gave Newton a candid account of his differential calculus, nearly in the form in which he afterwards published it, and explained how he used it for quadratures and inverse problems of tangents. Newton never replied.

26. In the *Acta eruditorum* of 1684 Leibnitz published a short memoir entitled *Nova methodus pro maximis et minimis, itemque tangentibus, quae nec fractas nec irracionales quantitates moratur, et singulare pro illis calculi genus*. In this memoir the differential  $dx$  of a variable  $x$ , considered as the abscissa of a point of a curve, is said to be an arbitrary quantity, and the differential  $dy$  of a related variable  $y$ , considered as the ordinate of the point, is defined as a quantity which has to  $dx$  the ratio of the ordinate to the subtangent, and rules are given for operating with differentials. These are the rules for forming the differential of a constant, a sum (or difference), a product (a quotient), a power (or root). They are equivalent to our rules (i.)–(iv.) of § 11 and the particular result

$$d(x^m) = mx^{m-1} dx.$$

The rule for a function of a function is not stated explicitly but is illustrated by examples in which new variables are introduced, in much the same way as in Newton's *Methodus fluxionum*. In connexion with the problem of maxima and minima, it is noted that the differential of  $y$  is positive or negative according as  $y$  increases or decreases when  $x$  increases, and the discrimination of maxima from minima depends upon the sign of  $ddy$ , the differential of  $dy$ . In connexion with the problem of tangents the differentials are said to be proportional to the momentary

increments of the abscissa and ordinate. A tangent is defined as a line joining two "infinitely" near points of a curve, and the "infinitely" small distances (e.g., the distance between the feet of the ordinates of such points) are said to be expressible by means of the differentials (e.g.,  $dx$ ). The method is illustrated by a few examples, and one example is given of its application to "inverse problems of tangents." Barrow's inversion-theorem and its application to quadratures are not mentioned. No proofs are given, but it is stated that they can be obtained easily by any one versed in such matters. The new methods in regard to differentiation which were contained in this memoir were the use of the second differential for the discrimination of maxima and minima, and the introduction of new variables for the purpose of differentiating complicated expressions. A greater novelty was the use of a letter ( $d$ ), not as a symbol for a number or magnitude, but as a symbol of operation. None of these novelties account for the far-reaching effect which this memoir has had upon the development of mathematical analysis. This effect was a consequence of the simplicity and directness with which the rules of differentiation were stated. Whatever indistinctness might be felt to attach to the symbols, the processes for solving problems of tangents and of maxima and minima were reduced once for all to a definite routine.

27. This memoir was followed in 1686 by a second, entitled *De Geometria recondita et analysi indivisibilium atque infinitorum*, in which Leibnitz described the method of using his new differential calculus for the problem of quadratures. This was the first publication of the notation  $\int y dx$ . The new method was called *calculus summatorius*. The brothers Jacob (James) and Johann (John) Bernoulli were able by 1690 to begin to make substantial contributions to the development of the new calculus, and Leibnitz adopted their word "integral" in 1695, yet at the same time adopting his symbol " $\int$ ." In 1696 the marquis de l'Hospital published the first treatise on the differential calculus with the title *Analyse des infiniment petits pour l'intelligence des lignes courbes*. The few references to fluxions in Newton's *Principia* (1687) must have been quite unintelligible to the mathematicians of the time, and the publication of the fluxional notation and calculus by Wallis in 1693 was too late to be effective. Fluxions had been supplanted before they were introduced.

The differential calculus and the integral calculus were rapidly developed in the writings of Leibnitz and the Bernoullis. Leibnitz (1695) was the first to differentiate a logarithm and an exponential, and John Bernoulli was the first to recognize the property possessed by an exponential ( $a^x$ ) of becoming infinitely great in comparison with any power ( $x^n$ ) when  $x$  is increased indefinitely. Roger Cotes (1722) was the first to differentiate a trigonometrical function. A great development of infinitesimal methods took place through the founding in 1696-1697 of the "Calculus of Variations" by the brothers Bernoulli.

28. The famous dispute as to the priority of Newton and Leibnitz in the invention of the calculus began in 1699 through the publication by Nicolas Fatio de Duillier of a tract in which he stated that Newton was not only the first, but by many years the first inventor, and insinuated that Leibnitz had stolen it. Leibnitz in his reply (*Acta Eruditiorum*, 1700) cited Newton's letters and the testimony which Newton had rendered to him in the *Principia* as proofs of his independent authorship of the method. Leibnitz was especially hurt at what he understood to be an endorsement of Duillier's attack by the Royal Society, but it was explained to him that the apparent approval was an accident. The dispute was ended for a time. On the publication of Newton's tract *De quadratura curvarum*, an anonymous review of it, written, as has since been proved, by Leibnitz, appeared in the *Acta Eruditiorum*, 1705. The anonymous reviewer said: "Instead of the Leibnizian differences Newton uses and always has used fluxions. . . just as Honoré Fabri in his *Synopsis Geometrica* substituted steps of movements for the method of Cavalieri." This passage, when it became known in England, was understood not merely as belittling Newton by comparing him with the

obscure Fabri, but also as implying that he had stolen his calculus of fluxions from Leibnitz. Great indignation was aroused; and John Keill took occasion, in a memoir on central forces which was printed in the *Philosophical Transactions* for 1708, to affirm that Newton was without doubt the first inventor of the calculus, and that Leibnitz had merely changed the name and mode of notation. The memoir was published in 1710. Leibnitz wrote in 1711 to the secretary of the Royal Society (Hans Sloane) requiring Keill to retract his accusation. Leibnitz's letter was read at a meeting of the Royal Society, of which Newton was then president, and Newton made to the society a statement of the course of his invention of the fluxional calculus with the dates of particular discoveries. Keill was requested by the society "to draw up an account of the matter under dispute and set it in a just light." In his report Keill referred to Newton's letters of 1676, and said that Newton had there given so many indications of his method that it could have been undoubtedly by a person of ordinary intelligence. Leibnitz wrote to Sloane asking the society to stop these unjust attacks of Keill, asserting that in the review in the *Acta Eruditiorum* no one had been injured but each had received his due, submitting the matter to the equity of the Royal Society, and stating that he was persuaded that Newton himself would do him justice. A committee was appointed by the society to examine the documents and furnish a report. Their report, presented in April 1712, concluded as follows:

"The differential method is one and the same with the method of fluxions, excepting the name and mode of notation; Mr Leibnitz calling those quantities differences which Mr Newton calls moments or fluxions, and marking them with the letter  $d$ , a mark not used by Mr Newton. And therefore we take the proper question to be, not who invented this or that method, but who was the first inventor of the method; and we believe that those who have reputed Mr Leibnitz the first inventor, knew little or nothing of his correspondence with Mr Collins and Mr Oldenburg long before; nor of Mr Newton's having that method above fifteen years before Mr Leibnitz began to publish it in the *Acta Eruditiorum* of Leipzig. For which reasons we reckon Mr Newton the first inventor, and are of opinion that Mr Keill, in asserting the same, has been no ways injurious to Mr Leibnitz."

The report with the letters and other documents was printed (1712) under the title *Commercium Epistolicum D. Johannis Collins et aliorum de analysi promotâ, jussu Societatis Regiæ in lucem editum*, not at first for publication. An account of the contents of the *Commercium Epistolicum* was printed in the *Philosophical Transactions* for 1715. A second edition of the *Commercium Epistolicum* was published in 1722. The dispute was continued for many years after the death of Leibnitz in 1716. To translate the words of Moritz Cantor, it "redounded to the discredit of all concerned."

29. One lamentable consequence of the dispute was a severance of British methods from continental ones. In Great Britain it became a point of honour to use fluxions and other Newtonian methods, while on the continent the notation of Leibnitz was universally adopted. This severance did not at first prevent a great advance in mathematics in Great Britain. So long as attention was directed to problems in which there is but one independent variable (the time, or the abscissa of a point of a curve), and all the other variables depend upon this one, the fluxional notation could be used as well as the differential and integral notation, though perhaps not quite so easily. Up to about the middle of the 18th century important discoveries continued to be made by the use of the method of fluxions. It was the introduction of partial differentiation by Leonhard Euler (1734) and Alexis Claude Clairaut (1739), and the developments which followed upon the systematic use of partial differential coefficients, which led to Great Britain being left behind; and it was not until after the reintroduction of continental methods into England by Sir John Herschel, George Peacock and Charles Babbage in 1815 that British mathematics began to flourish again. The exclusion of continental mathematics from Great Britain was not accompanied by any exclusion of British mathematics from the continent. The discoveries

of Brook Taylor and Colin Maclaurin were absorbed into the rapidly growing continental analysis, and the more precise conceptions reached through a critical scrutiny of the true nature of Newton's fluxions and moments stimulated a like scrutiny of the basis of the method of differentials.

30. This method had met with opposition from the first. Christiaan Huygens, whose opinion carried more weight than that of any other scientific man of the day, declared that the employment of differentials was unnecessary, and that Leibnitz's second differential was meaningless (1697). A Dutch physician named Bernhard Nieuwentijt attacked the method on account of the use of quantities which are at one stage of the process treated as somethings and at a later stage as nothings, and he was especially severe in commenting upon the second and higher differentials (1694, 1695). Other attacks were made by Michel Rolle (1701), but they were directed rather against matters of detail than against the general principles. The fact is that, although Leibnitz in his answers to Nieuwentijt (1695), and to Rolle (1702), indicated that the processes of the calculus could be justified by the methods of the ancient geometry, he never expressed himself very clearly on the subject of differentials, and he conveyed, probably without intending it, the impression that the calculus leads to correct results by compensation of errors. In England the method of fluxions had to face similar attacks. George Berkeley, bishop and philosopher, wrote in 1734 a tract entitled *The Analyst; or a Discourse addressed to an Injidel Mathematician*, in which he proposed to destroy the presumption that the opinions of mathematicians in matters of faith are likely to be more trustworthy than those of divines,

The "Analyst" controversy.

by contending that in the much vaunted fluxional calculus there are mysteries which are accepted unquestioningly by the mathematicians, but are incapable of logical demonstration. Berkeley's criticism was levelled against all infinitesimals, that is to say, all quantities vaguely conceived as in some intermediate state between nullity and finiteness, as he took Newton's moments to be conceived. The tract occasioned a controversy which had the important consequence of making it plain that all arguments about infinitesimals must be given up, and the calculus must be founded on the method of limits. During the controversy Benjamin Robins gave an exceedingly clear explanation of Newton's theories of fluxions and of prime and ultimate ratios regarded as theories of limits. In this explanation he pointed out that Newton's *moment* (Leibnitz's "differential") is to be regarded as so much of the actual difference between two neighbouring values of a variable as is needful for the formation of the fluxion (or differential coefficient) (see G. A. Gibson, "The Analyst Controversy," *Proc. Math. Soc.*, Edinburgh, xvii., 1899). Colin Maclaurin published in 1742 a *Treatise of Fluxions*, in which he reduced the whole theory to a theory of limits, and demonstrated it by the method of Archimedes. This notion was gradually transferred to the continental mathematicians. Leonhard Euler in his *Institutiones Calculi Differentialis* (1755) was reduced to the position of one who asserts that all differentials are zero, but, as the product of zero and any finite quantity is zero, the ratio of two zeros can be a finite quantity which it is the business of the calculus to determine. Jean le Rond d'Alembert in the *Encyclopédie méthodique* (1755, 2nd ed. 1784) declared that differentials were unnecessary, and that Leibnitz's calculus was a calculus of mutually compensating errors, while Newton's method was entirely rigorous. D'Alembert's opinion of Leibnitz's calculus was expressed also by Lazare N. M. Carnot in his *Réflexions sur la métaphysique du calcul infinitésimal* (1799) and by Joseph Louis de la Grange (generally called Lagrange) in writings from 1760 onwards. Lagrange proposed in his *Théorie des fonctions analytiques* (1797) to found the whole of the calculus on the theory of series. It was not until 1823 that a treatise on the differential calculus founded upon the method of limits was published. The treatise was the *Résumé des leçons sur le calcul infinitésimal* of Augustin Louis Cauchy. Since that time it has been understood that the use of the

phrase "infinitely small" in any mathematical argument is a figurative mode of expression pointing to a limiting process. In the opinion of many eminent mathematicians such modes of expression are confusing to students, but in treatises on the calculus the traditional modes of expression are still largely adopted.

Cauchy's method of limits.

31. Defective modes of expression did not hinder constructive work. It was the great merit of Leibnitz's symbolism that a mathematician who used it knew what was to be done in order to formulate any problem analytically, even though he might not be absolutely clear as to the proper interpretation of the symbols, or able to render a satisfactory account of them. While new and varied results were promptly obtained by using them, a long time elapsed before the theory of them was placed on a sound basis. Even after Cauchy had formulated his theory much remained to be done, both in the rapidly growing department of complex variables, and in the regions opened up by the theory of expansions in trigonometric series. In both directions it was seen that rigorous demonstration demanded greater precision in regard to fundamental notions, and the requirement of precision led to a gradual shifting of the basis of analysis from geometrical intuition to arithmetical law. A sketch of the outcome of this movement—the "arithmetization of analysis," as it has been called—will be found in *FUNCTION*. Its general tendency has been to show that many theories and processes, at first accepted as of general validity, are liable to exceptions, and much of the work of the analysts of the latter half of the 19th century was directed to discovering the most general conditions in which particular processes, frequently but not universally applicable, can be used without scruple.

Arithmetical basis of modern analysis.

### III. Outlines of the Infinitesimal Calculus.

32. The general notions of functionality, limits and continuity are explained in the article *FUNCTION*. Illustrations of the more immediate ways in which these notions present themselves in the development of the differential and integral calculus will be useful in what follows.

33. Let  $y$  be given as a function of  $x$ , or, more generally, let  $x$  and  $y$  be given as functions of a variable  $t$ . The first of these cases is included in the second by putting  $x=t$ . If certain conditions are satisfied the aggregate of the points determined by the functional relations form a curve. The first condition is that the aggregate of the values of  $t$  to which values of  $x$  and  $y$  correspond must be continuous, or, in other words, that these values must consist of all real numbers, or of all those real numbers which lie between assigned extreme numbers. When this condition is satisfied the points are "ordered," and their order is determined by the order of the numbers  $t$ , supposed to be arranged in order of increasing or decreasing magnitude; also there are two senses of description of the curve, according as  $t$  is taken to increase or to diminish. The second condition is that the aggregate of the points which are determined by the functional relations must be "continuous." This condition means that, if any point  $P$  determined by a value of  $t$  is taken, and any distance  $\delta$ , however small, is chosen, it is possible to find two points  $Q$ ,  $Q'$  of the aggregate which are such that (i.)  $P$  is between  $Q$  and  $Q'$ , (ii.) if  $R$ ,  $R'$  are any points between  $Q$  and  $Q'$  the distance  $RR'$  is less than  $\delta$ . The meaning of the word "between" in this statement is fixed by the ordering of the points. Sometimes additional conditions are imposed upon the functional relations before they are regarded as defining a curve. An aggregate of points which satisfies the two conditions stated above is sometimes called a "Jordan curve." It by no means follows that every curve of this kind has a tangent. In order that the curve may have a tangent at  $P$  it is necessary that, if any angle  $\alpha$ , however small, is specified, a distance  $\delta$  can be found such that when  $P$  is between  $Q$  and  $Q'$ , and  $PQ$  and  $PQ'$  are less than  $\delta$ , the angle  $RPQ'$  is less than  $\alpha$  for all pairs of points  $R$ ,  $R'$  which are between  $P$  and  $Q$ , or between  $P$  and  $Q'$  (fig. 8). When this condition is satisfied  $y$  is a function of  $x$  which has a differential coefficient. The only way of

Geometrical limits.

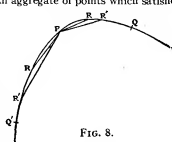

FIG. 8.

finding out whether this condition is satisfied or not is to attempt to form the differential coefficient. If the quotient of differences  $\Delta y/\Delta x$  has a limit when  $\Delta x$  tends to zero,  $y$  is a differentiable function of  $x$ , and the limit in question is the differential coefficient. The derived function, or differential coefficient, of a function  $f(x)$  is always defined by the formula

$$f'(x) = \frac{df(x)}{dx} = \lim_{h \rightarrow 0} \frac{f(x+h) - f(x)}{h}$$

Rules for the formation of differential coefficients in particular cases have been given in §11 above. The definition of a differential coefficient, and the rules of differentiation, are quite independent of any geometrical interpretation, such as that concerning tangents to a curve, and the tangent to a curve is properly defined by means of the differential coefficient of a function, not the differential coefficient by means of the tangent.

It may happen that the limit employed in defining the differential coefficient has one value when  $h$  approaches zero through positive values, and a different value when  $h$  approaches zero through negative values. The two limits are then called the "progressive" and "regressive" differential coefficients. In applications to dynamics, when  $x$  denotes a coordinate and  $t$  the time,  $dx/dt$  denotes a velocity. If the velocity is changed suddenly the progressive differential coefficient measures the velocity just after the change, and the regressive differential coefficient measures the velocity just before the change. Variable velocities are properly defined by means of differential coefficients.

All geometrical limits may be specified in terms similar to those employed in specifying the tangent to a curve; in difficult cases they must be so specified. Geometrical intuition may fail to answer the question of the existence or non-existence of the appropriate limits. In the last resort the definitions of many quantities of geometrical import must be analytical, not geometrical. As illustrations of this statement we may take the definitions of the areas and lengths of curves. We may not assume that every curve has an area or a length. To find out whether a curve has an area or not, we must ascertain whether the limit expressed by  $\int y dx$  exists. When the limit exists the curve has an area. The definition of the integral is quite independent of any geometrical interpretation. The length of a curve again is defined by means of a limiting process. Let  $P, Q$  be two points on a curve, and  $R_1, R_2, \dots, R_{n-1}$  a set of intermediate points of the curve, supposed to be described in the sense in which  $Q$  comes after  $P$ . The points  $R$  are supposed to be reached successively in the order of the suffixes when the curve is described in this sense. We form a sum of lengths of chords

$$PR_1 + R_1R_2 + \dots + R_{n-1}Q.$$

If this sum has a limit when the number of the points  $R$  is increased indefinitely and the lengths of all the chords are diminished indefinitely, this limit is the length of the arc  $PQ$ . The limit is the same whatever law may be adopted for inserting the intermediate points  $R$  and diminishing the lengths of the chords. It appears from this statement that the differential element of the arc of a curve is the length of the chord joining two neighbouring points (§§ 9, 10), the differential element of arc  $ds$  may be expressed by the formula

$$ds = \sqrt{(dx)^2 + (dy)^2},$$

of which the right-hand member is really the measure of the distance between two neighbouring points on the tangent. The square root must be taken to be positive. We may describe this differential element as being so much of the actual arc between two neighbouring points as need be retained for the purpose of forming the integral expression for an arc. This is a description, not a definition, because the length of the short arc itself is only definable by means of the integral expression. Similar considerations to those used in defining the areas of plane figures and the lengths of plane curves are applicable to the formation of expressions for differential elements of volume or of the areas of curved surfaces.

34. In regard to the differential coefficients it is an important theorem that, if the derived function  $f'(x)$  vanishes at all points of an interval, the function  $f(x)$  is constant in the interval. It follows that, if two functions have the same derived function they can only differ by a constant. Conversely, indefinite integrals are indeterminate to the extent of an additive constant.

35. The differential coefficient  $dy/dx$ , or the derived function  $f'(x)$ , is itself a function of  $x$ , and its differential coefficient is denoted by  $f''(x)$  or  $d^2y/dx^2$ . In the second of these notations  $d^2/dx^2$  is regarded as the symbol of an operation, that of differentiation with respect to  $x$ , and the index 2 means that the operation is repeated. In like manner we may express the results of  $n$  successive differentiations by  $f^{(n)}(x)$  or by  $d^n y/dx^n$ . When the second differential coefficient exists, or the first is differentiable, we have the relation

$$f''(x) = \lim_{h \rightarrow 0} \frac{f(x+h) - 2f(x) + f(x-h)}{h^2} \quad (i.)$$

The limit expressed by the right-hand member of this equation may

exist in cases in which  $f'(x)$  does not exist or is not differentiable. The result that, when the limit here expressed can be shown to vanish at all points of an interval, then  $f(x)$  must be a linear function of  $x$  in the interval, is important.

The relation (i.) is a particular case of the more general relation

$$f^{(n)}(x) = \lim_{h \rightarrow 0} h^{-n} \{ f(x+nh) - n f(x+(n-1)h) + \frac{n(n-1)}{2!} f(x+(n-2)h) - \dots + (-1)^n f(x) \} \quad (ii.)$$

As in the case of relation (i.) the limit expressed by the right-hand member may exist although some or all of the derived function  $f'(x), f''(x), \dots, f^{(n-1)}(x)$  do not exist.

Corresponding to the rule iii. of § 11 we have the rule for forming the  $n$ th differential coefficient of a product in the form

$$\frac{d^n(uv)}{dx^n} = \frac{d^n u}{dx^n} v + \frac{d^n v}{dx^n} u + \frac{n(n-1)}{2!} \frac{d^2 u}{dx^2} \frac{d^{n-2} v}{dx^{n-2}} + \dots + \frac{d^n u}{dx^n} v,$$

where the coefficients are those of the expansion of  $(1+x)^n$  in powers of  $x$  ( $n$  being a positive integer). The rule is due to Leibnitz, (1695).

Differential of higher orders may be introduced in the same way as the differential of the first order. In general when  $y=f(x)$ , the  $n$ th differential  $d^n y$  is defined by the equation

$$d^n y = f^{(n)}(x)(dx)^n,$$

in which  $dx$  is the (arbitrary) differential of  $x$ .

When  $d^2 x$  is regarded as a single symbol of operation the symbol  $f \dots dx^n$  represents the inverse operation. If the former is denoted by  $D$ , the latter may be denoted by  $D^{-1}$ .  $D^n$  means that the operation  $D$  is to be performed  $n$  times in succession;  $D^{-n}$  is to be performed  $n$  times in succession. Leibnitz's course of thought (§ 24) naturally led him to inquire after an interpretation of  $D^n$ , where  $n$  is not an integer. For an account of the researches to which this inquiry gave rise, reference may be made to the article by A. Voss in *Encyc. d. math. Wiss.* Bd. ii. A. 2 (Leipzig, 1889). The matter is referred to as "fractional" or "generalized" differentiation.

36. After the formation of differential coefficients the most important theorem of the differential calculus is the theorem of intermediate value ("theorem of mean value," "theorem of finite increments," " Rolle's theorem," are other names for it). This theorem may be explained as follows:

Let  $A, B$  be two points of a curve  $y=f(x)$  (fig. A, B). Then there is a point  $P$  between  $A$  and  $B$  at which the tangent is parallel to the secant  $AB$ . This theorem is expressed analytically in the statement that if  $f'(x)$  is continuous between  $a$  and  $b$ , there is a value  $x_1$  of  $x$  between  $a$  and  $b$  which has the property expressed by the equation

$$\frac{f(b) - f(a)}{b - a} = f'(x_1). \quad (i.)$$

The value  $x_1$  can be expressed in the form  $a + \theta(b-a)$  where  $\theta$  is a number between 0 and 1.

A slightly more general theorem was given by Cauchy (1823) to the effect that, if  $f(x)$  and  $F'(x)$  are continuous between  $x=a$  and  $x=b$ , then there is a number  $\theta$  between 0 and 1 which has the property expressed by the equation

$$\frac{F(b) - F(a)}{f(b) - f(a)} = F' [a + \theta(b-a)].$$

The theorem expressed by the relation (i.) was first noted by Rolle (1690) for the case where  $f(x)$  is a rational integral function which vanishes when  $x=a$  and also when  $x=b$ . The general theorem was given by Lagrange (1797). Its fundamental importance was first recognized by Cauchy (1823). It may be observed here that the theorem of integral calculus expressed by the equation

$$F(b) - F(a) = \int_a^b f(x) dx$$

follows at once from the definition of an integral and the theorem of intermediate value.

The theorem of intermediate value may be generalized in the statement that, if  $f(x)$  and all its differential coefficients up to the  $n$ th inclusive are continuous in the interval between  $x=a$  and  $x=b$ , then there is a number  $\theta$  between 0 and 1 which has the property expressed by the equation

$$f(b) - f(a) + (b-a)f'(a) + \frac{(b-a)^2}{2!} f''(a) + \dots + \frac{(b-a)^{n-1}}{(n-1)!} f^{(n-1)}(a) + \frac{(b-a)^n}{n!} f^{(n)} [a + \theta(b-a)]. \quad (i.)$$

37. This theorem provides a means for computing the values of a function at points near to an assigned point when the value of the function and its differential coefficients at the assigned point are known. The function is expressed by a terminated series, and, when the remainder tends to zero as  $n$  increases, it may be transformed into an infinite series. The theorem

Taylor's Theorem.

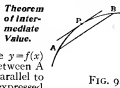

FIG. 9.



was first given by Brook Taylor in his *Methodus Incrementorum* (1717) as a corollary to a theorem concerning finite differences. Taylor gave the expression for  $f(x+z)$  in terms of  $f(x)$ ,  $f'(x)$ , ... as an infinite series proceeding by powers of  $z$ . His notation was that appropriate to the method of fluxions which he used. This rule for expressing a function as an infinite series is known as Taylor's theorem. The relation (1), in which the remainder after  $n$  terms is put in evidence, was first obtained by Lagrange (1797). Another form of the remainder was given by Cauchy (1823) viz.,

$$\frac{(b-a)^n}{(n-1)!} (1-\theta)^{n-1} \theta^n [a+\theta(b-a)].$$

The conditions of validity of Taylor's expansion in an infinite series have been investigated very completely by A. Pringsheim (*Math. Ann.* Bd. xliv., 1894). It is not sufficient that the function and all its differential coefficients should be finite at  $x=a$ ; there must be a neighbourhood of it which Cauchy's form of the remainder tends to zero as  $n$  increases (cf. FUNCTION).

An example of the necessity of this condition is afforded by the function  $f(x)$  which is given by the equation

$$f(x) = \frac{1}{1+x^2} + \sum_{n=1}^{n=\infty} \frac{(-1)^n}{n!} \frac{1}{1+3^{2n}x^2}. \quad (i.)$$

The sum of the series

$$f(a) + xf'(a) + \frac{x^2}{2!} f''(a) + \dots \quad (ii.)$$

is the same as that of the series

$$e^{-1} - x^2 e^{-2} + x^4 e^{-4} - \dots$$

It is easy to prove that this is less than  $e^{-1}$  when  $x$  lies between 0 and 1, and also that  $f(x)$  is greater than  $e^{-1}$  when  $x=1/\sqrt{3}$ . Hence the sum of the series (i.) is not equal to the sum of the series (ii.).

The particular case of Taylor's theorem in which  $a=0$  is often called Maclaurin's theorem, because it was first explicitly stated by Colin Maclaurin in his *Treatise of Fluxions* (1742). Maclaurin like Taylor worked exclusively with the fluxional calculus.

Examples of expansions in series had been known for some time. The series for  $\log(1+x)$  was obtained by Nicolaus Mercator (1668) by expanding  $(1+x)^{-1}$  by the method of algebraic division, and integrating the series term by term. He regarded his result as a "quadrature of the hyperbola."

Newton (1666) obtained the expansion of  $\sin^{-1} x$  by expanding  $(1-x^2)^{-\frac{1}{2}}$  by the binomial theorem and integrating the series term by term. James Gregory (1671) gave the series for  $\tan^{-1} x$ . Newton also obtained the series for  $\sin x$ ,  $\cos x$ , and  $e^x$  by reversion of series (1669). The symbol  $\epsilon$  for the base of the Napierian logarithms was introduced by Euler (1759). All these series can be obtained at once by Taylor's theorem. James Gregory found also the first few terms of the series for  $\tan x$  and  $\sec x$ ; the terms of these series may be found successively by Taylor's theorem, but the numerical coefficient of the general term cannot be obtained in this way.

Taylor's theorem for the expansion of a function in a power series was the basis of Lagrange's theory of functions, and it is fundamental also in the theory of analytic functions of a complex variable as developed later by Karl Weierstrass. It has also numerous applications to problems of maxima and minima and to analytical geometry. These matters are treated in the appropriate articles.

The forms of the coefficients in the series for  $\tan x$  and  $\sec x$  can be expressed most simply in terms of a set of numbers introduced by James Bernoulli in his treatise on probability entitled *Ars Conjectandi* (1713). These numbers  $B_1, B_2, \dots$  called Bernoulli's numbers, are the coefficients so denoted in the formula

$$\frac{x}{e^x - 1} = 1 - \frac{x}{2} + \frac{B_1}{2!} x^2 - \frac{B_2}{4!} x^4 + \frac{B_3}{6!} x^6 - \dots$$

and they are connected with the sums of powers of the reciprocals of the natural numbers by equations of the type

$$B_n = \frac{(2n)!}{2^{2n} - 1} \left( \frac{1}{1^{2n}} + \frac{1}{2^{2n}} + \frac{1}{3^{2n}} + \dots \right).$$

The function

$$x^n - \frac{m}{2} x^{n-1} + \frac{m(m-1)}{2!} B_1 x^{n-2} - \dots$$

has been called Bernoulli's function of the  $m$ th order by J. L. Raabe (*Crell's J. f. Math.* Bd. xlii., 1851). Bernoulli's numbers and functions are of special importance in the calculus of finite differences (see the article by D. Seltmann in *Ency. d. math. Wiss.* Bd. i., E., 1901).

When  $x$  is given in terms of  $y$  by means of a power series of the form  $x = y(C_0 + C_1 y + C_2 y^2 + \dots)$  ( $C_0 \neq 0$ ) =  $yf_0(y)$ , say,

there arises the problem of expressing  $y$  as a power series in  $x$ . This problem is that of reversion of series. It can be shown that provided the absolute value of  $x$  is not too great,

$$y = \frac{x}{f_0'(0)} + \sum_{n=2}^{n=\infty} \frac{x^n}{n!} \frac{d^{n-1}}{dy^{n-1}} \left[ \frac{1}{f_0'(y)} \right]_{y=0}$$

To this problem is reducible that of expanding  $y$  in powers of  $x$  when  $x$  and  $y$  are connected by an equation of the form

$$y = a + xf(y),$$

for which problem Lagrange (1770) obtained the formula

$$y = a + xf(a) + \sum_{n=2}^{n=\infty} \frac{x^n}{n-2} \left[ \frac{x^n}{da^{n-2}} \{f(a)\}^n \right].$$

For the history of the problem and the generalizations of Lagrange's result reference may be made to O. Stolz, *Gründzüge d. Diff. u. Int. Rechn.* Nr. 2 (Leipzig, 1896).

38. An important application of the theorem of intermediate value and its generalization can be made to the problem of evaluating certain limits. If two functions  $\phi(x)$  and  $\psi(x)$  both vanish at  $x=a$ , the fraction  $\phi(x)/\psi(x)$  may have a finite limit at  $a$ . This limit is described as the limit of an "indeterminate form." Such indeterminate forms were considered first by de l'Hospital (1666) to whom the problem of evaluating the limit presented itself in the form of tracing the curve

Indeterminate forms.

$y = \phi(x)/\psi(x)$  near the ordinate  $x=a$ , when the curves  $y = \phi(x)$  and  $y = \psi(x)$  both cross the axis of  $x$  at the same point as this ordinate. In fig. 1 to PA and QA represent short arcs of the curves  $\phi, \psi$ , chosen so that P and Q have the same abscissa. The value of the ordinate of the corresponding point R of the compound curve is given by the ratio of the ordinates PM, QM. De l'Hospital treated PM and QM as "infinitesimal," so that the equations PM:AM =  $\phi'(a)$  and QM:AM =  $\psi'(a)$  could be assumed to hold, and he arrived at the result that "the true value" of  $\phi(a)/\psi(a)$  is  $\phi'(a)/\psi'(a)$ . It can be proved rigorously that, if  $\phi'(x)$  does not vanish at  $x=a$ , while  $\phi(a) = 0$  and  $\psi(a) = 0$ , then

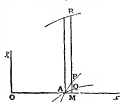

FIG. 10.

$$\lim_{x \rightarrow a} \frac{\phi(x)}{\psi(x)} = \frac{\phi'(a)}{\psi'(a)}.$$

It can be proved further if that  $\phi^{(m)}(x)$  and  $\psi^{(n)}(x)$  are the differential coefficients of lowest order of  $\phi(x)$  and  $\psi(x)$  which do not vanish at  $x=a$ , and if  $m=n$ , then

$$\lim_{x \rightarrow a} \frac{\phi(x)}{\psi(x)} = \frac{\phi^{(m)}(a)}{\psi^{(m)}(a)}.$$

If  $m > n$  the limit is zero; if  $m < n$  the function represented by the quotient  $\phi(x)/\psi(x)$  "becomes infinite" at  $x=a$ . If the value of the function at  $x/a$  is not assigned by the definition of the function, the function does not exist at  $x=a$ , and the meaning of the statement that it "becomes infinite" is that it has no finite limit. The statement does not mean that the function has a value which we call infinity. There is no such value (see FUNCTION).

Such indeterminate forms as that described above are said to be of the form  $0/0$ . Other indeterminate forms are presented in the form  $0 \times \infty$ , or  $1^\infty$ , or  $\infty/\infty$ , or  $\infty - \infty$ . The most notable of the forms  $1^\infty$  is  $\lim_{x \rightarrow 0} (1+x)^{1/x}$ , which is  $e$ . The case in which  $\phi(x)$  and  $\psi(x)$  both tend to become infinite at  $x=a$  is reducible to the case in which both the functions tend to become infinite when  $x$  is increased indefinitely. If  $\phi'(x)$  and  $\psi'(x)$  have determinate finite limits when  $x$  is increased indefinitely, while  $\phi(x)$  and  $\psi(x)$  are determinately (positively or negatively) infinite, we have the result expressed by the equation

$$\lim_{x \rightarrow \infty} \frac{\phi(x)}{\psi(x)} = \frac{\lim_{x \rightarrow \infty} \phi'(x)}{\lim_{x \rightarrow \infty} \psi'(x)}.$$

For the meaning of the statement that  $\phi(x)$  and  $\psi(x)$  are determinately infinite reference may be made to the article FUNCTION. The evaluation of forms of the type  $\infty/\infty$  leads to a scale of increasing "infinities," each being infinite in comparison with the preceding. Such a scale is

$$\log x, \dots, x, x^2, \dots, x^n, \dots, e^x, \dots, x^x;$$

each of the limits expressed by such forms as  $\lim_{x \rightarrow \infty} \phi(x)/\psi(x)$ , where  $\phi(x)$  precedes  $\psi(x)$  in the scale, is the same. The completion of such scales, along with the problem of constructing a complete scale, was discussed in numerous writings by Paul du Bois-Reymond (see in particular, *Math. Ann.* Bd. xi., 1877). For the general problem of indeterminate forms reference may be made to the article by A. Pringsheim in *Ency. d. math. Wiss.* Bd. ii., A. 1 (1899). Forms of the type  $0/0$  presented themselves to early writers on analytical geometry in connexion with the determination of the tangents at a double point of a curve; forms of the type  $\infty/\infty$  presented themselves in like manner in connexion with the determination of asymptotes of curves. The evaluation of limits has innumerable applications in all parts of analysis. Cauchy's *Analyse algèbre* (1821) was an epoch-making treatise on limits.

If a function  $\phi(x)$  becomes infinite at  $x=a$ , and another function  $\psi(x)$  also becomes infinite at  $x=a$  in such a way that  $\phi(x)/\psi(x)$  has a finite limit  $C$ , we say that  $\phi(x)$  and  $\psi(x)$  become "infinite of the same order." We may write  $\phi(x) = C\psi(x) + o(\psi(x))$ , where  $\lim_{x \rightarrow a} o(\psi(x))/\psi(x) = 0$ , and thus  $\phi(x)$  is of a lower order than  $\psi(x)$ ; it may be finite or infinite at  $x=a$ . If it is finite, we describe  $C\psi(x)$

as the "infinite part" of  $\phi(x)$ . The resolution of a function which becomes infinite into an infinite part and a finite part can often be effected by taking the infinite part to be infinite of the same order as one of the functions in the scale written above, or in some more comprehensive scale. This resolution is the inverse of the process of evaluating an indeterminate form of the type  $\infty \cdot \infty$ .

For example  $\lim_{x \rightarrow 0} x^n(e^x - 1)^{-1} - x^n$  is finite and equal to  $\frac{1}{2}$ , and the function  $(e^x - 1)^{-1} - x^n$  can be expanded in a power series in  $x$ .

39. The nature of a function of two or more variables, and the meaning to be attached to continuity and limits in respect of such functions, have been explained under **FUNCTIONS**. The theorems of differential calculus which relate to such functions are in general the same whether the number of variables is two or any greater number, and it will generally be convenient to state the theorems for two variables.

40. Let  $u$  or  $f(x, y)$  denote a function of two variables  $x$  and  $y$ . If we regard  $y$  as constant,  $u$  or  $f$  becomes a function of one variable  $x$ , and we may seek to differentiate it with respect to  $x$ .

**Partial differentiation.** If the function of  $x$  is differentiable, the differential coefficient which is formed in this way is called the "partial differential coefficient" of  $u$  or  $f$  with respect to  $x$ , and is denoted by  $\frac{\partial u}{\partial x}$  or  $\frac{\partial f}{\partial x}$ . The symbol " $\partial$ " was appropriated for partial differentiation by C. G. J. Jacobi (1841). It had before been written indifferently with " $d$ " as a symbol of differentiation.

Euler had written " $\left(\frac{df}{dx}\right)_y$ " for the partial differential coefficient of  $f$  with respect to  $x$ . Sometimes it is desirable to put in evidence the variable which is treated as constant, and then the partial differential coefficient is written " $\left(\frac{df}{dx}\right)_y$ " or " $\left(\frac{\partial f}{\partial x}\right)_y$ ". This course is often adopted by writers on Thermodynamics. Sometimes the symbols  $\partial$  or  $\partial$  are dropped, and the partial differential coefficient is denoted by  $u_x$  or  $f_x$ . As a definition of the partial differential coefficient we have the formula

$$\frac{\partial f}{\partial x} = \lim_{h \rightarrow 0} \frac{f(x+h, y) - f(x, y)}{h}$$

In the same way we may form the partial differential coefficient with respect to  $y$  by treating  $x$  as a constant.

The introduction of partial differential coefficients enables us to solve at once for a surface a problem analogous to the problem of tangents for a curve; and it also enables us to take the first step in the solution of the problem of maxima and minima for a function of several variables. If the equation of a surface is expressed in the form  $z = f(x, y)$ , the direction cosines of the normal to the surface at any point are in the ratios  $\frac{\partial f}{\partial x} : \frac{\partial f}{\partial y} : 1$ . If  $f$  is a maximum or a minimum at  $(x, y)$ , then  $\partial f/\partial x$  and  $\partial f/\partial y$  vanish at that point.

In applications of the differential calculus to mathematical physics we are in general concerned with functions of three variables  $x, y, z$ , which represent the coordinates of a point; and then considerable importance attaches to partial differential coefficients which are formed by a particular rule. Let  $F(x, y, z)$  be the function,  $P$  a point  $(x, y, z)$ ,  $P'$  a neighbouring point  $(x + \Delta x, y + \Delta y, z + \Delta z)$ , and let  $\Delta s$  be the length of  $PP'$ . The value of  $F(x, y, z)$  at  $P$  may be denoted shortly by  $F(P)$ . A limit of the same nature as a partial differential coefficient is expressed by the formula

$$\lim_{\Delta s \rightarrow 0} \frac{F(P') - F(P)}{\Delta s}$$

in which  $\Delta s$  is diminished indefinitely by bringing  $P'$  up to  $P$ , and  $P'$  is supposed to approach  $P$  along a straight line, for example, the tangent to a curve or the normal to a surface. The limit in question is denoted by  $\partial F/\partial s$ , in which it is understood that  $h$  indicates a direction, that of  $PP'$ . If  $l, m, n$  are the direction cosines of the limiting direction of the line  $PP'$ , supposed drawn from  $P$  to  $P'$ , then

$$\frac{\partial F}{\partial s} = \frac{\partial F}{\partial x} l + \frac{\partial F}{\partial y} m + n \frac{\partial F}{\partial z}$$

The operation of forming  $\partial F/\partial s$  is called "differentiation with respect to an axis" or "vector differentiation."

41. The most important theorem in regard to partial differential coefficients is the *theorem of the total differential*. We may write down the equation

$$f(a+h, b+k) - f(a, b) = f_x(a+h, b+k)h + f_y(a, b+k)k - f(a, b)$$

**Theorem of the Total Differential.** If  $f_x$  is a continuous function of  $x$  when  $x$  lies between  $a$  and  $a+h$  and  $y = b+k$ , and if further  $f_y$  is a continuous function of  $y$  when  $y$  lies between  $b$  and  $b+k$ , there exist values of  $\theta$  and  $\eta$  which lie between 0 and 1 and have the properties expressed by the equations

$$f(a+h, b+k) - f(a, b+k) = hf_x(a+\theta h, b+k), \\ f(a, b+k) - f(a, b) = kf_y(a, b+\eta k).$$

Further,  $f_x(a+\theta h, b+k)$  and  $f_y(a, b+\eta k)$  tend to the limits  $f_x(a, b)$  and  $f_y(a, b)$  when  $h$  and  $k$  tend to zero, provided the differential

coefficients  $f_x, f_y$  are continuous at the point  $(a, b)$ . Hence in this case the above equation can be written

$$f(a+h, b+k) - f(a, b) = hf_x(a, b) + kf_y(a, b) + R,$$

where

$$\lim_{h \rightarrow 0, k \rightarrow 0} \frac{R}{h} = 0 \text{ and } \lim_{h \rightarrow 0, k \rightarrow 0} \frac{R}{k} = 0.$$

In accordance with the notation of differentials this equation gives

$$df = \frac{\partial f}{\partial x} dx + \frac{\partial f}{\partial y} dy.$$

Just as in the case of functions of one variable,  $dx$  and  $dy$  are arbitrary finite differences, and  $df$  is not the difference of two values of  $f$ , but is so much of this difference as need be retained for the purpose of forming differential coefficients.

The theorem of the total differential is immediately applicable to the differentiation of *implicit functions*. When  $y$  is a function of  $x$  which is given by an equation of the form  $f(x, y) = 0$ , and it is either impossible or inconvenient to solve this equation so as to express  $y$  as an explicit function of  $x$ , the differential coefficient  $dy/dx$  can be formed without solving the equation. We have at once

$$\frac{dy}{dx} = -\frac{\partial f / \partial x}{\partial f / \partial y}$$

This rule was known, in all essentials, to Fermat and de Sluse before the invention of the algorithm, of the differential calculus.

An important theorem, first proved by Euler, is immediately deducible from the theorem of the total differential. If  $f(x, y)$  is a homogeneous function of degree  $n$  then

$$\frac{\partial f}{\partial x} x + \frac{\partial f}{\partial y} y = nf(x, y).$$

The theorem is applicable to functions of any number of variables and is generally known as *Euler's theorem of homogeneous functions*.

42. Many problems in which partial differential coefficients occur are simplified by the introduction of certain determinants called "Jacobians" or "functional determinants." **Jacobians.** They were introduced into Analysis by C. G. J. Jacobi (*J. f. Math.*, Crelle, Bd. 22, 1841, p. 319). The Jacobian of  $u_1, u_2, \dots, u_n$  with respect to  $x_1, x_2, \dots, x_n$  is the determinant

$$\begin{vmatrix} \frac{\partial u_1}{\partial x_1} & \frac{\partial u_1}{\partial x_2} & \dots & \frac{\partial u_1}{\partial x_n} \\ \frac{\partial u_2}{\partial x_1} & \frac{\partial u_2}{\partial x_2} & \dots & \frac{\partial u_2}{\partial x_n} \\ \vdots & \vdots & \ddots & \vdots \\ \frac{\partial u_n}{\partial x_1} & \frac{\partial u_n}{\partial x_2} & \dots & \frac{\partial u_n}{\partial x_n} \end{vmatrix}$$

in which the constituents of the  $r$ th row are the  $n$  partial differential coefficients of  $u_r$  with respect to the  $n$  variables  $x$ . This determinant is expressed shortly by

$$\frac{\partial(u_1, u_2, \dots, u_n)}{\partial(x_1, x_2, \dots, x_n)}$$

Jacobians possess many properties analogous to those of ordinary differential coefficients, for example, the following:—

$$\frac{\partial(u_1, u_2, \dots, u_n)}{\partial(x_1, x_2, \dots, x_n)} \times \frac{\partial(x_1, x_2, \dots, x_n)}{\partial(u_1, u_2, \dots, u_n)} = 1, \\ \frac{\partial(u_1, u_2, \dots, u_n)}{\partial(y_1, y_2, \dots, y_n)} \times \frac{\partial(y_1, y_2, \dots, y_n)}{\partial(x_1, x_2, \dots, x_n)} = \frac{\partial(u_1, u_2, \dots, u_n)}{\partial(x_1, x_2, \dots, x_n)}.$$

If  $n$  functions  $(u_1, u_2, \dots, u_n)$  of  $n$  variables  $(x_1, x_2, \dots, x_n)$  are not independent, but are connected by a relation  $f(u_1, u_2, \dots, u_n) = 0$ , then

$$\frac{\partial(u_1, u_2, \dots, u_n)}{\partial(x_1, x_2, \dots, x_n)} = 0;$$

and, conversely, when this condition is satisfied identically the functions  $u_1, u_2, \dots, u_n$  are not independent.

43. Partial differential coefficients of the second and higher orders can be formed in the same way as those of the first order. For example, when there are two variables  $x, y$ , the first partial derivatives  $\partial f/\partial x$  and  $\partial f/\partial y$  are functions of  $x$  and  $y$ , which we may seek to differentiate partially with respect to  $x$  or  $y$ . The most important theorem in relation to partial differential coefficients of orders higher than the first is the theorem that the values of such coefficients do not depend upon the order in which the differentiations are performed. For example, we have the equation

$$\frac{\partial}{\partial x} \left( \frac{\partial f}{\partial y} \right) = \frac{\partial}{\partial y} \left( \frac{\partial f}{\partial x} \right) \quad (i)$$

This theorem is not true without limitation. The conditions for its validity have been investigated very completely by H. A. Schwarz (see his *Ges. math. Abhandlungen*, Bd. 2, Berlin, 1890, p. 275). It is a sufficient, though not a necessary, condition that all the differential coefficients concerned should be continuous functions of  $x, y$ . In consequence of the relation (i) the differential coefficients expressed in the two members of this relation are written

$$\frac{\partial^2 f}{\partial x \partial y} \text{ or } \frac{\partial^2 f}{\partial y \partial x}$$

**Interchange of order of differentiations.**

The differential coefficient:

$$\frac{\partial^2 f}{\partial x^2 \partial y \partial z^2}$$

in which  $p+q+r=n$ , is formed by differentiating  $p$  times with respect to  $x$ ,  $q$  times with respect to  $y$ ,  $r$  times with respect to  $z$ , the differentiations being performed in any order. Abbreviated notations are sometimes used in such forms as

$$f_{pqr} \text{ or } f_{x,y,z}^{p,q,r}$$

Differentials of higher orders are introduced by the defining equation

$$\begin{aligned} d^2f &= \left( dx \frac{\partial}{\partial x} + dy \frac{\partial}{\partial y} \right)^2 f \\ &= (dx)^2 \frac{\partial^2 f}{\partial x^2} + n(dx)^{n-1} dy \frac{\partial^2 f}{\partial x^{n-1} \partial y} + \dots \end{aligned}$$

in which the expression  $\left( dx \frac{\partial}{\partial x} + dy \frac{\partial}{\partial y} \right)^n$  is developed by the binomial theorem in the same way as if  $dx \frac{\partial}{\partial x}$  and  $dy \frac{\partial}{\partial y}$  were numbers, and

$\left( \frac{\partial}{\partial x} \right)^r \left( \frac{\partial}{\partial y} \right)^q$  is replaced by  $\frac{\partial^r \partial^q f}{\partial x^r \partial y^q}$ . When there are more than two variables the multinomial theorem must be used instead of the binomial theorem.

The problem of forming the second and higher differential coefficients of *implicit functions* can be solved at once by means of partial differential coefficients. For example, if  $f(x, y) = 0$  is the equation defining  $y$  as a function of  $x$ , we have

$$\frac{\partial^2 y}{\partial x^2} \left( \frac{\partial f}{\partial y} \right)^{-1} + \left( \frac{\partial f}{\partial y} \right)^{-2} \frac{\partial^2 f}{\partial x^2} - 2 \frac{\partial f}{\partial x} \frac{\partial^2 f}{\partial x \partial y} + \left( \frac{\partial f}{\partial x} \right)^2 \frac{\partial^2 f}{\partial y^2} = 0$$

The differential expression  $Xdx + Ydy$ , in which both  $X$  and  $Y$  are functions of the two variables  $x$  and  $y$ , is a *total differential* if there exists a function  $f$  of  $x$  and  $y$  which is such that

$$\partial f / \partial x = X, \quad \partial f / \partial y = Y.$$

When this is the case we have the relation

$$\partial^2 V / \partial x = \partial X / \partial y. \quad (ii.)$$

Conversely, when this equation is satisfied there exists a function  $f$  which is such that

$$df = Xdx + Ydy.$$

The expression  $Xdx + Ydy$  in which  $X$  and  $Y$  are connected by the relation (ii.) is often described as a "perfect differential." The theory of the perfect differential can be extended to functions of  $n$  variables, and in this case there are  $\frac{1}{2}n(n-1)$  such relations as (ii.).

In the case of a function of two variables  $x, y$  an abbreviated notation is often adopted for differential coefficients. The function being denoted by  $z$ , we write

$$p, q, r, s, t, \text{ for } \frac{\partial z}{\partial x}, \frac{\partial z}{\partial y}, \frac{\partial^2 z}{\partial x^2}, \frac{\partial^2 z}{\partial x \partial y}, \frac{\partial^2 z}{\partial y^2}$$

Partial differential coefficients of the second order are important in geometry as expressing the curvature of surfaces. When a surface is given by an equation of the form  $z = f(x, y)$ , the lines of curvature are determined by the equation

$$\begin{aligned} &[(1+q^2)s - pqr] (dy)^2 + [(1+q^2)r - (1+p^2)t] dx dy \\ &\quad - (1+p^2)s - pqr (dx)^2 = 0, \end{aligned}$$

and the principal radii of curvature are the values of  $R$  which satisfy the equation

$$R^2(r^2 - s^2) - R[(1+q^2)r - 2pq s + (1+p^2)t] \sqrt{(1+p^2 + q^2)} = 0.$$

44. The problem of change of variables is first considered by Brook Taylor in his *Methodus incrementorum*. In the case considered by Taylor  $y$  is expressed as a function of  $x$ , and  $z$  as a function of  $x$ , and it is desired to express the differential coefficients of  $y$  with respect to  $x$  without eliminating  $z$ . The result can be obtained at once by the rules for differentiating a product and a function of a function. We have

$$\begin{aligned} \frac{dy}{dx} &= \frac{dy}{dz} \frac{dz}{dx} \\ \frac{d^2y}{dx^2} &= \frac{dy}{dz} \frac{d^2z}{dx^2} + \frac{d^2y}{dz^2} \left( \frac{dz}{dx} \right)^2 \\ \frac{d^3y}{dx^3} &= \frac{dy}{dz} \frac{d^3z}{dx^3} + 3 \frac{d^2y}{dz^2} \frac{dz}{dx} \frac{d^2z}{dx^2} + \frac{d^3y}{dz^3} \left( \frac{dz}{dx} \right)^3, \end{aligned}$$

The introduction of partial differential coefficients enables us to deal with more general cases of change of variables than that considered above. If  $u, v$  are new variables, and  $x, y$  are connected with them by equations of the type

$$x = f_1(u, v), \quad y = f_2(u, v), \quad (i.)$$

while  $y$  is either an explicit or an implicit function of  $x$ , we have the problem of expressing the differential coefficients of various orders of  $y$  with respect to  $x$  in terms of the differential coefficients of  $v$  with respect to  $u$ . We have

$$\frac{dy}{dx} = \left( \frac{\partial f_2}{\partial u} + \frac{\partial f_2}{\partial v} \frac{\partial v}{\partial u} \right) / \left( \frac{\partial f_1}{\partial u} + \frac{\partial f_1}{\partial v} \frac{\partial v}{\partial u} \right)$$

by the rule of the total differential. In the same way, by means of differentials of higher orders, we may express  $d^2y/dx^2$ , and so on.

Equations such as (i.) may be interpreted as effecting a *transformation* by which a point  $(u, v)$  is made to correspond to a point  $(x, y)$ . The whole theory of transformations, and of functions, or differential expressions, which remain invariant under groups of transformations, has been studied exhaustively by Sophus Lie (see, in particular, his *Theorie der Transformationsgruppen*, Leipzig, 1888-1893). (See also DIFFERENTIAL EQUATIONS and GROUPS.)

A more general problem of change of variables is presented when it is desired to express the partial differential coefficients of a function  $V$  with respect to  $x, y, \dots$  in terms of those with respect to  $u, v, \dots$  where  $u, v, \dots$  are connected with  $x, y, \dots$  by any functional relations. When there are two variables  $x, y$ , and  $u, v$  are given functions of  $x, y$ , we have

$$\begin{aligned} \frac{\partial V}{\partial x} &= \frac{\partial V}{\partial u} \frac{\partial u}{\partial x} + \frac{\partial V}{\partial v} \frac{\partial v}{\partial x}, \\ \frac{\partial V}{\partial y} &= \frac{\partial V}{\partial u} \frac{\partial u}{\partial y} + \frac{\partial V}{\partial v} \frac{\partial v}{\partial y} \end{aligned}$$

and the differential coefficients of higher orders are to be formed by repeated applications of the rule for differentiating a product and the rules of the type

$$\frac{\partial}{\partial x} = \frac{\partial u}{\partial x} \frac{\partial}{\partial u} + \frac{\partial v}{\partial x} \frac{\partial}{\partial v}.$$

When  $x, y$  are given functions of  $u, v, \dots$  we have, instead of the above, such equations as

$$\frac{\partial V}{\partial u} = \frac{\partial V}{\partial x} \frac{\partial x}{\partial u} + \frac{\partial V}{\partial y} \frac{\partial y}{\partial u};$$

and  $\partial V / \partial x, \partial V / \partial y$  can be found by solving these equations, provided the Jacobian  $\partial(x, y) / \partial(u, v)$  is not zero. The generalization of this method for the case of more than two variables need not detain us.

In cases like that here considered it is sometimes more convenient not to regard the equations connecting  $x, y$  with  $u, v$  as effecting a point transformation, but to consider the loci  $u = \text{const.}, v = \text{const.}$ , as two "families" of curves. In any region of the plane of  $(x, y)$  in which the Jacobian  $\partial(x, y) / \partial(u, v)$  does not vanish or become infinite, any point  $(x, y)$  is uniquely determined by the values of  $u$  and  $v$  which belong to the curves of the two families that pass through the point. Such variables as  $u, v$  are then described as "curvilinear coordinates" of the point. This method is applicable to any number of variables. When the loci  $u = \text{const.}, v = \text{const.}$  intersect each other at right angles, the variables are "orthogonal" curvilinear coordinates. Three-dimensional systems of such coordinates have important applications in mathematical physics. Reference may be made to G. Lamé, *Leçons sur les coordonnées curvilignes* (Paris, 1859), and to G. Darboux, *Leçons sur les coordonnées curvilignes et systèmes orthogonaux* (Paris, 1898).

When such a coordinate as  $u$  is connected with  $x$  and  $y$  by a functional relation of the form  $f(x, y, u) = 0$  the curves  $u = \text{const.}$  are a family of curves, and this family may be such that no two curves of the family have a common point. When this is not the case the points in which a curve  $f(x, y, u) = 0$  is intersected by a curve  $f(x, y, u + \Delta u) = 0$  tend to limiting positions as  $\Delta u$  is diminished indefinitely. The locus of these limiting positions is the "envelope" of the family, and in general it touches all the curves of the family. It is easy to see that, if  $u, v$  are the parameters of two families of curves which have envelopes, the Jacobian  $\partial(x, y) / \partial(u, v)$  vanishes at all points on these envelopes. It is easy to see also that at any point where the reciprocal Jacobian  $\partial(u, v) / \partial(x, y)$  vanishes, a curve of the family  $u$  touches a curve of the family  $v$ .

If three variables  $x, y, z$  are connected by a functional relation  $f(x, y, z) = 0$ , one of them,  $z$ , may be regarded as an *implicit function* of the other two, and the partial differential coefficients of  $z$  with respect to  $x$  and  $y$  can be formed by the rule of the total differential. We have

$$\frac{\partial z}{\partial x} = - \frac{\partial f / \partial z}{\partial f / \partial x} = - \frac{\partial f}{\partial x} / \frac{\partial f}{\partial z},$$

and there is no difficulty in proceeding to express the higher differential coefficients. There arises the problem of expressing the partial differential coefficients of  $z$  with respect to  $x$  and  $y$  and  $z$  in terms of those of  $z$  with respect to  $x$  and  $y$ . The problem is known as that of "changing the dependent variable." It is solved by applying the rule of the total differential. Similar considerations are applicable to all cases in which  $n$  variables are connected by fewer than  $n$  equations.

45. Taylor's theorem can be extended to functions of several variables. In the case of two variables the general form - *Extension of Taylor's theorem* - can be written as follows

$$f(a+h, b+k) = f(a, b) + df(a, b) + \frac{1}{2!} d^2f(a, b) + \dots$$

$$+ \frac{1}{(n-1)!} d^{n-1}f(a, b) + \frac{1}{n!} d^n f(a+h, b+k),$$

in which

$$df(a, b) = \left[ \left( h \frac{\partial}{\partial x} + k \frac{\partial}{\partial y} \right)^n f(x, y) \right]_{x=a, y=b}$$

and  $d^2f(a+\theta h, b+\theta k) = \left[ \left( h \frac{\partial^2}{\partial x^2} + k \frac{\partial^2}{\partial y^2} \right)^n f(x, y) \right]_{x=a+\theta h, y=b+\theta k}$ .

The last expression is the remainder after  $n$  terms, and in it  $\theta$  denotes some particular number between 0 and 1. The results for three or more variables can be written in the same form. The extension of Taylor's theorem was given by Lagrange (1797); the form written above is due to Cauchy (1823). For the validity of the theorem in this form it is necessary that all the differential coefficients up to the  $n$ th should be continuous in a region bounded by  $x=a+h, y=b+k$ . When all the differential coefficients, no matter how high the order, are continuous in such a region, the theorem leads to an expansion of the function in a multiple power series. Such expansions are just as important in analysis, geometry, and mechanics as expansions of functions of one variable. Among the problems which are solved by means of such expansions are the problem of maxima and minima for functions of more than one variable (see MAXIMA and MINIMA).

46. In treatises on the differential calculus much space is usually devoted to the differential geometry of curves and **Plane surfaces**. A few remarks and results relating to the differential geometry of plane curves are set down here.

(i.) If  $\psi$  denotes the angle which the radius vector drawn from the origin makes with the tangent to a curve at a point whose polar coordinates are  $r, \theta$  and if  $\rho$  denotes the perpendicular from the origin to the tangent, then

$$\cos \psi = r \, ds / dr, \quad \sin \psi = r \, d\theta / ds = \rho / r,$$

where  $ds$  denotes the element of arc. The curve may be determined by an equation connecting  $\rho$  with  $\psi$ .

(ii.) The locus of the foot of the perpendicular let fall from the origin upon the tangent to a curve at a point is called the *pedal* of the curve with respect to the origin. The angle  $\psi$  for the pedal is the same as the angle  $\psi$  for the curve. Hence the  $(\rho, \psi)$  equation of the pedal can be deduced. If the pedal is regarded as the primary curve, the curve of which it is the pedal is the "negative pedal" of the primary. We may have pedals of pedals and so on, also negative pedals of negative pedals and so on. Negative pedals are usually determined as envelopes.

(iii.) If  $\phi$  denotes the angle which the tangent at any point makes with a fixed line, we have

$$r^2 = \rho^2 + (d\rho/d\phi)^2.$$

(iv.) The "average curvature" of the arc  $\Delta s$  of a curve between two points is measured by the quotient

$$\frac{\Delta\phi}{\Delta s}$$

where the upright lines denote, as usual, that the absolute value of the included expression is to be taken, and  $\phi$  is the angle which the tangent makes with a fixed line, so that  $\Delta\phi$  is the angle between the tangents (or normals) at the points. As one of the points moves up to coincide with the other this average curvature tends to a limit which is the "curvature" of the curve at the point. It is denoted by

$$\frac{d\phi}{ds}$$

Sometimes the upright lines are omitted and a rule of signs is given:—Let the arc  $s$  of the curve be measured from some point along the curve in a chosen sense, and let the normal be drawn towards that side to which the curve is concave; if the normal is directed towards the left of an observer looking along the tangent in the chosen sense of description the curvature is reckoned positive, in the contrary case negative. The differential  $d\phi$  is often called the "angle of contingence." In the 14th century the size of the angle between a curve and its tangent seems to have been seriously debated, and the name "angle of contingence" was then given to the supposed angle.

(v.) The curvature of a curve at a point is the same as that of a certain circle which touches the curve at the point, and the "radius of curvature"  $\rho$  is the radius of this circle. We have  $\frac{1}{\rho} = \left| \frac{d\phi}{ds} \right|$ .

The centre of the circle is called the "centre of curvature"; it is the limiting position of the point of intersection of the normal at the point and the normal at a neighbouring point, when the second point moves up to coincide with the first. If a circle is described to intersect the curve at the point P and at two other points, and one of these two points is moved up to coincide with P, the circle touches the curve at the point P and meets it in another point; the centre of the circle is then on the normal. As the third point now moves up to coincide with P, the centre of the circle moves to the centre of curvature. The circle is then said to "osculate" the curve, or to have "contact of the second order" with it at P.

(vi.) The following arc formulae for the radius of curvature:—

$$\frac{1}{\rho} = \left\{ 1 + \left( \frac{dy}{dx} \right)^2 \right\}^{-\frac{3}{2}} \frac{d^2y}{dx^2}$$

$$\rho = \left| \frac{dr}{d\psi} \right| = \left| \rho + \frac{d^2\rho}{d\psi^2} \right|$$

(vii.) The points at which the curvature vanishes are "points of inflection." If P is a point of inflection and Q a neighbouring point,

then, as Q moves up to coincidence with P, the distance from P to the point of intersection of the normals at P and Q becomes greater than any distance that can be assigned. The equation which gives the abscissae of the points in which a straight line meets the curve being expressed in the form  $f(x) = 0$ , the function  $f(x)$  has a factor  $(x-x_0)^n$ , where  $x_0$  is the abscissa of the point of inflection P, and the line is the tangent at P. When the factor  $(x-x_0)$  occurs  $(n+1)$  times in  $f(x)$ , the curve is said to have "contact of the  $n$ th order" with the line. There is an obvious modification when the line is parallel to the axis of  $y$ .

(viii.) The locus of the centres of curvature, or envelope of the normals, of a curve is called the "evolute." A curve which has a given curve as evolute is called an "involute" of the given curve. All the involutes are "parallel" curves, that is to say, they are such that one is derived from another by marking off a constant distance along the normal. The involutes are "orthogonal trajectories" of the tangents to the common evolute.

(ix.) The equation of an algebraic curve of the  $n$ th degree can be expressed in the form  $u_0 + u_1 + u_2 + \dots + u_n = 0$ , where  $u_0$  is a constant, and  $u_n$  is a homogeneous rational integral function of  $x, y$  of the  $n$ th degree. When the origin is on the curve,  $u_0$  vanishes, and  $u_1 = 0$  represents the tangent at the origin. If  $u_1$  also vanishes, the origin is a double point and  $u_2 = 0$  represents the tangent at the origin. If  $u_2$  has distinct factors, or is of the form  $a(y-p_1x)(y-p_2x)$ , the vertex of  $y$  on either branch of the curve can be expressed (for points sufficiently near the origin) in a power series, which is either

$$\rho_1 x + \frac{1}{2} q_1 x^2 + \dots, \text{ or } \rho_2 x + \frac{1}{2} q_2 x^2 + \dots$$

where  $q_1, \dots, q_n$  are determined without ambiguity. If  $\rho_1$  and  $\rho_2$  are real the two branches have radii of curvature  $\rho_1, \rho_2$  determined by the formulæ

$$\frac{1}{\rho_1} = \left[ (1+p_1^2)^{-\frac{3}{2}} q_1 \right], \quad \frac{1}{\rho_2} = \left[ (1+p_2^2)^{-\frac{3}{2}} q_2 \right].$$

When  $\rho_1$  and  $\rho_2$  are imaginary the origin is the real point of intersection of two imaginary branches. In the real figure of the curve it is an *isolated point*. If  $u_2$  is a square,  $a(y-px)^2$ , the origin is a *cusp*, and in general there is not a series for  $y$  in integral powers of  $x$ , which is valid in the neighbourhood of the origin. The further investigation of cusps and multiple points belongs rather to analytical geometry and the theory of algebraic functions than to differential calculus.

(x.) When the equation of a curve is given in the form  $u_0 + u_1 + \dots + u_n = 0$  where the notation is the same as that in (ix.), the factors of  $u_n$  determine the directions of the *asymptotes*. If these factors are all real and distinct, there is an asymptote corresponding to each factor. If  $u_n = L_1 L_2 \dots L_m$ , where  $L_1, \dots$  are linear in  $x, y$ , we may resolve  $u_n / u_0$  into partial fractions according to the formula

$$\frac{u_n - 1}{u_0} = \frac{A_1}{L_1} + \frac{A_2}{L_2} + \dots + \frac{A_m}{L_m}$$

and then  $L_1 + A_1 = 0, L_2 + A_2 = 0, \dots$  are the equations of the asymptotes. When a real factor of  $u_n$  is repeated we may have two parallel asymptotes or we may have a "parabolic asymptote." Sometimes the parallel asymptotes coincide, as in the curve  $x^2(x^2+y^2-a^2) = a^4$ , where  $x = 0$  is the only real asymptote. The whole theory of asymptotes belongs properly to analytical geometry and the theory of algebraic functions.

47. The formal definition of an integral, the theorem of the existence of the integral for certain classes of functions, a list of classes of "integrable" functions, extensions of the notion **Integral calculus** of integration to functions which become infinite or indeterminate, and to cases in which the limits of integration become infinite, the definitions of multiple integrals, and the possibility of defining functions by means of definite integrals—all these matters have been considered in FUNCTION. The definition of integration has been explained in § 5 above, and the results of some of the simplest integrations have been given in § 12. A few theorems relating to integrations have been noted in §§ 34, 35, 36 above.

48. The chief methods for the evaluation of indefinite integrals are the method of integration by parts, and the **Methods of Integration** introduction of new variables.

From the equation  $d(w) = u \, dv + v \, du$  we deduce the equation

$$\int u \, dv = uv - \int v \, du,$$

or, as it may be written

$$\int u \, v \, dx = u \int v \, dx - \int \frac{du}{dx} \left\{ \int v \, dx \right\} dx.$$

This is the rule of "integration by parts."

As an example we have

$$\int x e^{ax} dx = x \frac{e^{ax}}{a} - \int \frac{e^{ax}}{a} dx = \left( \frac{x}{a} - \frac{1}{a^2} \right) e^{ax}.$$

When we introduce a new variable  $z$  in place of  $x$ , by means of an equation giving  $x$  in terms of  $z$ , we express  $f(x)$  in terms of  $z$ . Let  $\phi(z)$  denote the function of  $z$  into which  $f(x)$  is transformed. Then from the equation

$$dx = \frac{dx}{dz} dz$$

we deduce the equation

$$\int f(x)dx = \int \phi(z) \frac{dz}{z^2} dx.$$

As an example, in the integral

$$\int \sqrt{1 - (x-2)^2} dx$$

put  $x = \sin z$ ; the integral becomes

$$\int \cos z \cdot \cos z dz = \int \frac{1}{2}(1 + \cos 2z) dz = \frac{1}{2}(z + \frac{1}{2} \sin 2z) = \frac{1}{2}(z + \sin z \cos z).$$

49. The indefinite integrals of certain classes of functions can be expressed by means of a finite number of operations of addition or multiplication in terms of the so-called "elementary" functions.

**Integration in terms of elementary functions.** The elementary functions are rational algebraic functions, implicit algebraic functions, exponentials and logarithms, trigonometrical and inverse circular functions. The following are among the classes of functions whose integrals involve the elementary functions only: (i.) all rational functions; (ii.) all irrational functions of the form  $f(x, y)$ , where  $f$  denotes a rational algebraic function of  $x$  and  $y$ , and  $y$  is connected with  $x$  by an algebraic equation of the second degree; (iii.) all rational functions of  $\sin x$  and  $\cos x$ ; (iv.) all rational functions of  $e^x$ ; (v.) all rational integral functions of the variables  $x, e^{ax}, e^{bx}, \dots, \sin mx, \cos mx, \sin nx, \cos nx, \dots$ , in which  $a, b, \dots, m, n, \dots$  are any constants. The integration of a rational function is generally effected by resolving the function into partial fractions, the function being first expressed as the quotient of two rational integral functions. Corresponding to any simple root of the denominator there is a logarithmic term in the integral. If any of the roots of the denominator are repeated there are rational algebraic terms in the integral. The operation of resolving a fraction into partial fractions requires a knowledge of the roots of the denominator, but the algebraic part of the integral can always be found without obtaining all the roots of the denominator. Reference may be made to C. Hermite, *Cours d'analyse*, Paris, 1873. The integration of other functions, which can be integrated in terms of the elementary functions, can usually be effected by transforming the functions into rational functions, possibly after preliminary integrations by parts. In the case of rational functions of  $x$  and a radical of the form  $\sqrt{(ax^2+bx+c)}$  the radical can be reduced by a linear substitution to one of the forms  $\sqrt{(a^2-x^2)}$ ,  $\sqrt{(x^2-a^2)}$ ,  $\sqrt{(x^2+a^2)}$ . The substitutions  $x = a \sin \theta$ ,  $x = a \sec \theta$ ,  $x = a \tan \theta$  are then effective in the three cases. By these substitutions the subject of integration becomes a rational function of  $\sin \theta$  and  $\cos \theta$ , and it can be reduced to a rational function of  $t$  by the substitution  $\tan \frac{1}{2}\theta = t$ . There are many other substitutions by which such integrals can be determined. Sometimes we may have information as to the functional character of the integral without being able to determine it. For example, when the subject of integration is of the form  $(ax^2+bx^2+cx^2+dx+e)^{-1/2}$  the integral cannot be expressed explicitly in terms of elementary functions. Such integrals lead to new functions (see FUNCTION).

Methods of reduction and substitution for the evaluation of indefinite integrals occupy a considerable space in text-books of the integral calculus. In regard to the functional character of the integral reference may be made to G. H. Hardy's tract, *The Integration of Functions of a Single Variable* (Cambridge, 1905), and to the memoirs there quoted. A few results are added here

(i.)  $\int (x^2+a)^{-1} dx = \log |(x^2+a)|$ .

(ii.)  $\int \frac{dx}{(x-p)\sqrt{(ax^2+2bx+c)}}$  can be evaluated by the substitution  $x-p=1/z$ , and  $\int \frac{dx}{(x-p)\sqrt{(ax^2+2bx+c)}}$  can be deduced by differentiating  $(n-1)$  times with respect to  $p$ .

(iii.)  $\int \frac{(Hx+K)dx}{(ax^2+2bx+\gamma)\sqrt{(ax^2+2bx+c)}}$  can be reduced by the substitution  $y^2 = (ax^2+2bx+c)/(ax^2+2bx+\gamma)$  to the form  $A \int \frac{dy}{\sqrt{(\lambda_1-y^2)}} + B \int \frac{dy}{\sqrt{(y^2-\lambda_2)}}$

where  $A$  and  $B$  are constants, and  $\lambda_1$  and  $\lambda_2$  are the two values of  $\lambda$  for which  $(a-\lambda a)x^2+2(b-\lambda b)x+c-\lambda \gamma$  is a perfect square (see A. G. Greenhill, *A Chapter in the Integral Calculus*, London, 1888).

(iv.)  $\int e^{ax} (ax^2+b) dx$ , in which  $a, b, n, p$  are rational, can be reduced, by putting  $ax = bt$ , to depend upon  $\int t^n(1+t)^p dt$ . If  $p$  is an integer and  $a$  a fraction  $r/s$ , we put  $t = u^s$ . If  $q$  is an integer and  $p = r/s$  we put  $1+t = u^r$ . If  $p+q$  is an integer and  $p = r/s$  we put  $1+t = tu^r$ . These integrals, called "binomial integrals," were investigated by Newton (*De quadratura curvarum*).

(v.)  $\int \frac{dx}{\sin x} = \log \tan \frac{x}{2}$  (vi.)  $\int \frac{dx}{\cos x} = \log (\tan x + \sec x)$ .

(vii.)  $\int e^{ax} \sin (bx+a) dx = (a^2+b^2)^{-1/2} e^{ax} (a \sin (bx+a) - b \cos (bx+a))$ .

(viii.)  $\int \sin^m x \cos^n x dx$  can be reduced by differentiating a function of the form  $\sin^p x \cos^q x$ ;

e.g.  $\frac{d}{dx} \frac{\sin x}{\cos^2 x} = \frac{1}{\cos^2 x} - \frac{q \sin^2 x}{\cos^{2+2} x} = \frac{1-q}{\cos^2 x} + \frac{q}{\cos^{2+2} x}$ .

Hence

$$\int \frac{dx}{\cos^2 x} = \frac{\sin x}{(n-1)\cos^{n-1} x} + \frac{n-2}{n-1} \int \frac{dx}{\cos^{n-2} x}.$$

(ix.)  $\int_0^{1/2\pi} \sin^{2n} x dx = \int_0^{1/2\pi} \cos^{2n} x dx = \frac{1 \cdot 3 \cdot \dots \cdot (2n-1)}{2 \cdot 4 \cdot \dots \cdot 2n} \cdot \frac{\pi}{2}$ ; ( $n$  an integer).

(x.)  $\int_0^{1/2\pi} \sin^{2n+1} x dx = \int_0^{1/2\pi} \cos^{2n+1} x dx = \frac{2 \cdot 4 \cdot \dots \cdot 2n}{3 \cdot 5 \cdot \dots \cdot (2n+1)}$ ; ( $n$  an integer).

(xi.)  $\int \frac{dx}{(1+\epsilon \cos x)^n}$  can be reduced by one of the substitutions  $\cos \phi = \frac{e+\cos x}{1+\epsilon \cos x}$   $\cosh u = \frac{e+\cos x}{1+\epsilon \cos x}$ .

of which the first or the second is to be employed according as  $\epsilon < 0$  or  $\epsilon > 1$ .

50. Among the integrals of transcendental functions **New transcendents** which lead to new transcendental functions we may notice **constants**.

$\int_0^{\infty} \frac{dx}{\log^2 x}$  or  $\int_{-\infty}^{\infty} \frac{e^x}{x^2} dx$ ,

called the "logarithmic integral," and denoted by "Li  $x$ ," also the integrals

$$\int_0^{\infty} \frac{\sin x}{x} dx \text{ and } \int_{-\infty}^{\infty} \frac{\cos x}{x} dx,$$

called the "sine integral" and the "cosine integral," and denoted by "Si  $x$ " and "Ci  $x$ ," also the integral

$$\int_0^x e^{-t^2} dt$$

called the "error-function integral," and denoted by "Erf  $x$ ."

All these functions have been tabulated (see TABLES, MATHEMATICAL).

51. New functions can be introduced also by means of the definite integrals of functions of two or more variables with respect to one of the variables, the limits of integration being fixed. Prominent among such functions are the **Eulerian Integrals**, the Beta and Gamma functions expressed by the equations

$$B(l, m) = \int_0^1 x^{l-1} (1-x)^{m-1} dx,$$

$$\Gamma(n) = \int_0^{\infty} e^{-t} t^{n-1} dt.$$

When  $n$  is a positive integer  $\Gamma(n+1) = n!$ . The Beta function (or "Eulerian integral of the first kind") is expressible in terms of Gamma functions (or "Eulerian integrals of the second kind") by the formula

$$B(l, m) \cdot \Gamma(l+m) = \Gamma(l) \cdot \Gamma(m).$$

The Gamma function satisfies the difference equation

$$\Gamma(x+1) = x\Gamma(x),$$

and also the equation

$$\Gamma(x) \cdot \Gamma(1-x) = \pi / \sin(\pi x),$$

with the particular result

$$\Gamma(\frac{1}{2}) = \sqrt{\pi}.$$

The number

$$-\left[ \frac{d}{dx} \log \Gamma(1+x) \right]_{x=0}, \text{ or } -\Gamma'(1),$$

is called "Euler's constant," and is equal to the limit

$$\lim_{n \rightarrow \infty} \left[ \left( 1 + \frac{1}{2} + \frac{1}{3} + \dots + \frac{1}{n} \right) - \log n \right];$$

its value to 15 decimal places is 0.577 215 664 901 532. The function  $\log \Gamma(1+x)$  can be expanded in the series

$$\log \Gamma(1+x) = \frac{1}{2} \log \left( \frac{\pi x}{\sin \pi x} \right) - \frac{1}{2} \log \frac{1+x}{1-x} + (1+\Gamma'(1))x - \frac{1}{2} (S_2-1)x^2 - \frac{1}{6} (S_3-1)x^3 - \dots,$$

where

$$S_{2n+1} = 1 + \frac{1}{2^{2n+1}} + \frac{1}{3^{2n+1}} + \dots,$$

and the series for  $\log \Gamma(1+x)$  converges when  $x$  lies between  $-1$  and  $1$ .

52. Definite integrals can sometimes be evaluated when the limits of integration are some particular numbers, although the corresponding indefinite integrals cannot be found. For example, we have the result

$$\int_0^1 (1-x^2)^{-1} \log x dx = -\frac{1}{2} \pi \log 2,$$

although the indefinite integral of  $(1-x^2)^{-1} \log x$  cannot be found. Numbers of definite integrals are expressible in terms of the transcendental functions mentioned in § 50 or in terms of Gamma functions. For the calculation of definite integrals we have the following methods:—

(i.) Differentiation with respect to a parameter.

(ii.) Integration with respect to a parameter.

(iii.) Expansion in infinite series and integration term by term.

(iv.) Contour integration.

The first three methods involve an interchange of the order of two limiting operations, and they are valid only when the functions satisfy certain conditions of continuity, or, in case the limits of

integration are infinite, when the functions tend to zero at infinite distances in a sufficiently high order (see FUNCTION). The method of contour integration involves the introduction of complex variables (see FUNCTION: § Complex Variables).

A few results are added

- (i.)  $\int_0^{\infty} \frac{x^{a-1}}{1+x^a} dx = \frac{\pi}{\sin a\pi}, (1 > a > 0),$   
 (ii.)  $\int_0^{\infty} \frac{x^{a-1} - x^{b-1}}{1-x} dx = \pi(\cot a\pi - \cot b\pi), (0 < a < b < 1)$   
 (iii.)  $\int_0^{\infty} \frac{x^{a-1} \log x}{x-1} dx = \frac{\pi^2}{\sin^2 a\pi}, (a > 1),$   
 (iv.)  $\int_0^{\infty} x^2 \cos 2x \cdot e^{-x^2} dx = -\frac{1}{2} \sqrt{\pi},$   
 (v.)  $\int_0^1 \frac{1-x^2}{1+x^2} \frac{dx}{\log x} = \log \tan \frac{\pi}{8},$   
 (vi.)  $\int_0^{\infty} \frac{\sin mx}{e^x - 1} dx = \frac{1}{2} \left( \frac{1}{e^m - 1} - \frac{1}{m} + \frac{1}{2} \right),$   
 (vii.)  $\int_0^{\infty} \log(1 - 2a \cos x + a^2) dx = 0$  or  $2\pi \log a$  according as  $a < 1$  or  $a > 1,$   
 (viii.)  $\int_0^{\infty} \frac{\sin x}{x} dx = \frac{1}{2}\pi,$   
 (ix.)  $\int_0^{\infty} \frac{\cos ax}{x^2 + b^2} dx = \frac{1}{2}\pi b^{-1} e^{-ab},$   
 (x.)  $\int_0^{\infty} \frac{\cos ax - \cos bx}{x^2} dx = \frac{1}{2}\pi(b-a),$   
 (xi.)  $\int_0^{\infty} \frac{\cos ax - \cos bx}{x} dx = \log \frac{b}{a},$   
 (xii.)  $\int_0^{\infty} \frac{\cos x - e^{-mx}}{x} dx = \log m,$   
 (xiii.)  $\int_{-\infty}^{\infty} e^{-x^2 + iax} dx = \sqrt{\pi} \cdot e^{-a^2/4},$   
 (xiv.)  $\int_0^{\infty} x^{-1} \sin x dx = \int_0^{\infty} x^{-1} \cos x dx = \frac{1}{2}(\frac{1}{2}\pi).$

53. The meaning of integration of a function of  $n$  variables through a domain of the same number of dimensions is explained in the article FUNCTION. In the case of two variables  $x, y$  we integrate a function  $f(x, y)$  over an area; in the case of three variables  $x, y, z$  we integrate a function  $f(x, y, z)$  through a volume. The integral of a function  $f(x, y)$  over an area in the plane of  $(x, y)$  is denoted by

**Multiple Integrals.**

$\iint f(x, y) dx dy.$   
 The notation refers to a method of evaluating the integral. We may suppose the area divided into a very large number of very small rectangles by lines parallel to the axes. Then we multiply the value of  $f$  at any point within a rectangle by the measure of the area of the rectangle, sum for all the rectangles, and pass to a limit by increasing the number of rectangles indefinitely and diminishing all their sides indefinitely. The process is usually effected by summing first for all the rectangles which lie in a strip between two lines parallel to one axis, say the axis of  $y$ , and afterwards for all the strips. This process is equivalent to integrating  $f(x, y)$  with respect to  $y$ , keeping  $x$  constant, and taking certain functions of  $x$  as the limits of integration for  $y$ , and then integrating the result with respect to  $x$  between constant limits. The integral obtained in this way may be written in such a form as

$$\int_a^b dx \left\{ \int_{c_1(x)}^{c_2(x)} f(x, y) dy \right\},$$

and is called a "repeated integral." The identification of a surface integral, such as  $\iint f(x, y, z) dx dy dz$ , with a repeated integral cannot always be made, but implies that the function satisfies certain conditions of continuity. In the same way volume integrals are usually evaluated by regarding them as repeated integrals, and a volume integral is written in the form

$$\iiint f(x, y, z) dx dy dz.$$

Integrals such as surface and volume integrals are usually called "multiple integrals." Thus we have "double" integrals, "triple" integrals, and so on. In contradistinction to multiple integrals the ordinary integral of a function of one variable with respect to that variable is called a "simple integral."

A more general type of surface integral may be defined by taking an arbitrary surface, with or without an edge. We suppose in the first place that the surface is closed, or has no edge. We may mark a large number of points on the surface, and these tangent planes at all these points. These tangent planes form a polyhedron having a large number of faces, one to each marked point; and we may choose the marked points so that all the linear dimensions of any face are less than some

arbitrarily chosen length. We may devise a rule for increasing the number of marked points indefinitely and decreasing the lengths of all the edges of the polyhedra indefinitely. If the sum of the areas of the faces tends to a limit, this limit is the area of the surface. If we multiply the value of a function  $f$  at a point of the surface by the measure of the area of the corresponding face of the polyhedron, sum for all the faces, and pass to a limit as before, the result is a surface integral, and is written

$$\iint f ds.$$

The extension to the case of an open surface bounded by an edge presents no difficulty. A line integral taken along a curve is defined in a similar way, and is written

**Line Integrals.**

$\int f ds,$   
 where  $ds$  is the element of arc of the curve (§ 33). The direction cosines of the tangent of a curve are  $dx/ds, dy/ds, dz/ds$ , and line integrals usually present themselves in the form

$$\int \left( p \frac{dx}{ds} + q \frac{dy}{ds} + r \frac{dz}{ds} \right) ds \text{ or } \int (u dx + v dy + w dz).$$

In like manner surface integrals usually present themselves in the form

$$\iint (l x + m y + n z) ds$$

where  $l, m, n$  are the direction cosines of the normal to the surface drawn in a specified sense.

The area of a bounded portion of the plane of  $(x, y)$  may be expressed either as

$$\frac{1}{2} \int (x dy - y dx),$$

or as

$$\iint dx dy,$$

the former integral being a line integral taken round the boundary of the portion, and the latter a surface integral taken over the area within this boundary. In forming the line integral the boundary is supposed to be described in the positive sense, so that the included area is on the left hand.

53a. We have two theorems of transformation connecting volume integrals with surface integrals and surface integrals with line integrals. The first theorem, called "Green's theorem," is expressed by the equation

**Theorems of Green and Stokes.**

$$\iiint \left( \frac{\partial z}{\partial x} + \frac{\partial y}{\partial z} \right) dx dy dz = \iint (l x + m y + n z) ds,$$

where the volume integral on the left is taken through the volume within a closed surface  $S$ , and the surface integral on the right is taken over  $S$ , and  $l, m, n$  denote the direction cosines of the normal to  $S$  drawn outwards. There is a corresponding theorem for a closed curve in two dimensions, viz.,

$$\iint \left( \frac{\partial z}{\partial x} + \frac{\partial y}{\partial z} \right) dx dy = \int \left( \frac{\partial y}{\partial x} - \frac{\partial x}{\partial y} \right) ds,$$

the sense of description of  $s$  being the positive sense. This theorem is a particular case of a more general theorem called "Stokes's theorem." Let  $s$  denote the edge of an open surface  $S$ , and let  $S$  be covered with a network of curves so that the meshes of the network are nearly plane, then we can choose a sense of description of the edge of any mesh, and a corresponding sense for the normal to  $S$  at any point within the mesh, so that these senses are related like the directions of rotation and translation in a right-handed screw. This convention fixes the sense of the normal  $(l, m, n)$  at any point on  $S$  when the sense of description of  $s$  is chosen. If the axes of  $x, y, z$  are a right-handed system, we have Stokes's theorem in the form

$$\int (u dx + v dy + w dz) = \iint \left\{ \left( \frac{\partial w}{\partial y} - \frac{\partial v}{\partial z} \right) + m \left( \frac{\partial u}{\partial z} - \frac{\partial w}{\partial x} \right) + n \left( \frac{\partial v}{\partial x} - \frac{\partial u}{\partial y} \right) \right\} ds,$$

where the integral on the left is taken round the curve  $s$  in the chosen sense. When the axes are left-handed, we may either reverse the sense of  $l, m, n$  and maintain the formula, or retain the sense of  $l, m, n$  and change the sign of the right-hand member of the equation. For the validity of the theorems of Green and Stokes it is in general necessary that the functions involved should satisfy certain conditions of continuity. For example, in Green's theorem the differential coefficients  $\partial z/\partial x, \partial y/\partial z, \partial z/\partial y, \partial y/\partial x$  must be continuous within  $S$ . Further, there are restrictions upon the nature of the curves or surfaces involved. For example, Green's theorem, as here stated, applies only to simply-connected regions of space. The correction for multiply-connected regions is important in several physical theories.

54. The process of changing the variables in a multiple integral, such as a surface or volume integral, is divisible into two stages. It is necessary in the first place to determine the differential element expressed by the product of the differentials of the first set of variables in terms of the differentials of the second set of variables. It is necessary in the second place to determine the limits of integration which must be employed when the integral in terms of the new variables is evaluated as a repeated integral. The first part of the problem is solved at once by the introduction of the Jacobian. If the variables of one set are denoted by  $x_1, x_2, \dots, x_n$ , and those of the other set by  $u_1, u_2, \dots, u_n$ , we have the relation

$$dx_1 dx_2 \dots dx_n = \frac{\partial(x_1, x_2, \dots, x_n)}{\partial(u_1, u_2, \dots, u_n)} du_1 du_2 \dots du_n.$$

In regard to the second stage of the process the limits of integration must be determined by the rule that the integration with respect to the second set of variables is to be taken through the same domain as the integration with respect to the first set.

For example, when we have to integrate a function  $f(x, y)$  over the area within a circle given by  $x^2 + y^2 = a^2$ , and we introduce polar coordinates so that  $x = r \cos \theta$ ,  $y = r \sin \theta$ , we find that  $r$  is the value of the Jacobian, and that all points within or on the circle are given by  $a \geq r \geq 0$ ,  $2\pi > \theta \geq 0$ , and we have

$$\int_a dx \int_{-\sqrt{a^2-x^2}}^{\sqrt{a^2-x^2}} f(x, y) dy = \int_0^{2\pi} d\theta \int_0^a f(r \cos \theta, r \sin \theta) r dr.$$

If we have to integrate over the area of a rectangle  $a \geq x \geq 0$ ,  $b \geq y \geq 0$ , and we transform to polar coordinates, the integral becomes the sum of two integrals, as follows:—

$$\int_0^a dx \int_0^b f(x, y) dy = \int_0^a dx \int_0^{\sec \theta} f(r \cos \theta, r \sin \theta) r dr + \int_{\tan^{-1} b/a}^{\pi/2} d\theta \int_0^{b \csc \theta} f(r \cos \theta, r \sin \theta) r dr.$$

55. A few additional results in relation to line integrals and multiple integrals are set down here.

(i.) Any simple integral can be regarded as a line-integral taken along a portion of the axis of  $x$ . When a change of variables is made, the limits of integration with respect to the new variable must be such that the domain of integration is the same as before. This condition may require the replacing of the original integral by the sum of two or more simple integrals.

(ii.) The line integral of a perfect differential of a one-valued function, taken along any closed curve, is zero.

(iii.) The area within any plane closed curve can be expressed by either of the formulae

$$\int x^2 \theta d\theta \text{ or } \int x y ds,$$

where  $r, \theta$  are polar coordinates, and  $\theta$  is the perpendicular drawn from a fixed point to the tangent. The integrals are to be understood as line integrals taken along the curve. When the same integrals are taken between limits which correspond to two points of the curve, in the sense of line integrals along the arc between the points, they represent the area bounded by the arc and the terminal radii vectors.

(iv.) The volume enclosed by a surface which is generated by the revolution of a curve about the axis of  $x$  expressed by the formula

$$\pi \int y^2 dx,$$

and the area of the surface is expressed by the formula

$$2\pi \int y ds,$$

where  $ds$  is the differential element of arc of the curve. When the former integral is taken between assigned limits it represents the volume contained between the surface and two planes which cut the axis of  $x$  at right angles. The latter integral is to be understood as a line integral taken along the curve, and it represents the area of the portion of the curved surface which is contained between two planes at right angles to the axis of  $x$ .

(v.) When we use curvilinear coordinates  $\xi, \eta$  which are conjugate functions of  $x, y$ , that is to say such that

$$\partial \xi / \partial x = \partial \eta / \partial y \text{ and } \partial \xi / \partial y = -\partial \eta / \partial x,$$

the Jacobian  $\partial(\xi, \eta) / \partial(x, y)$  can be expressed in the form

$$\left( \frac{\partial \xi}{\partial x} \right)^2 + \left( \frac{\partial \eta}{\partial x} \right)^2,$$

and in a number of equivalent forms. The area of any portion of the plane is represented by the double integral

$$\iint J^{-1} dx dy,$$

where  $J$  denotes the above Jacobian, and the integration is taken through a suitable domain. When the boundary consists of portions of curves for which  $\xi = \text{const.}$ , or  $\eta = \text{const.}$ , the above is generally the simplest way of evaluating it.

(vi.) The problem of "rectifying" a plane curve, or finding its length, is solved by evaluating the integral

$$\int \sqrt{1 + \left( \frac{dy}{dx} \right)^2} dx.$$

or, in polar coordinates, by evaluating the integral

$$\int \sqrt{r^2 + \left( \frac{dr}{d\theta} \right)^2} d\theta.$$

In both cases the integrals are line integrals taken along the curve.

(vii.) When we use curvilinear coordinates  $\xi, \eta$  as in (v.) above, the length of any portion of a curve  $\xi = \text{const.}$  is given by the integral

$$\int \sqrt{1 d\eta^2}$$

taken between appropriate limits for  $\eta$ . There is a similar formula for the arc of a curve  $\eta = \text{const.}$

(viii.) The area of a surface  $z = f(x, y)$  can be expressed by the formula

$$\iint \sqrt{1 + \left( \frac{\partial z}{\partial x} \right)^2 + \left( \frac{\partial z}{\partial y} \right)^2} dx dy.$$

When the coordinates of the points of a surface are expressed as

functions of two parameters  $u, v$ , the area is expressed by the formula

$$\iint \left[ \left\{ \frac{\partial(x, y, z)}{\partial(u, v)} \right\}^2 + \left\{ \frac{\partial(x, x)}{\partial(u, v)} \right\}^2 + \left\{ \frac{\partial(x, y)}{\partial(u, v)} \right\}^2 \right]^{1/2} du dv.$$

When the surface is referred to three-dimensional polar coordinates  $r, \theta, \phi$  given by the equations

$$x = r \sin \theta \cos \phi, y = r \sin \theta \sin \phi, z = r \cos \theta,$$

and the equation of the surface is of the form  $r = f(\theta, \phi)$ , the area is expressed by the formula

$$\iint r \left\{ r^2 + \left( \frac{\partial r}{\partial \theta} \right)^2 \right\}^{1/2} \sin \theta \left\{ \frac{\partial r}{\partial \phi} \right\}^2 d\theta d\phi.$$

The surface integral of a function of  $(\theta, \phi)$  over the surface of a sphere  $r = \text{const.}$  can be expressed in the form

$$\int_0^{2\pi} d\phi \int_0^{\pi} F(\theta, \phi) r^2 \sin \theta d\theta.$$

In every case the domain of integration must be chosen so as to include the whole surface.

(ix.) In three-dimensional polar coordinates the Jacobian

$$\frac{\partial(x, y, z)}{\partial(r, \theta, \phi)} = r^2 \sin \theta.$$

The volume integral of a function  $F(r, \theta, \phi)$  through the volume of a sphere  $r = a$  is

$$\int_0^a dr \int_0^{2\pi} d\phi \int_0^{\pi} F(r, \theta, \phi) r^2 \sin \theta d\theta.$$

(x.) Integrations of rational functions through the volume of an ellipsoid  $x^2/a^2 + y^2/b^2 + z^2/c^2 = 1$  are often effected by means of a general theorem due to Lejeune Dirichlet (1839), which is as follows: when the domain of integration is that given by the inequality

$$\left( \frac{x_1}{a_1} \right)^{a_1} + \left( \frac{x_2}{a_2} \right)^{a_2} + \dots + \left( \frac{x_n}{a_n} \right)^{a_n} \leq 1,$$

where the  $a$ 's and  $a$ 's are positive, the value of the integral

$$\iint \dots x_1^{a_1-1} x_2^{a_2-1} \dots dx_1 dx_2 \dots$$

is

$$\frac{a_1! a_2! \dots \Gamma \left( \frac{a_1}{a_1} \right) \Gamma \left( \frac{a_2}{a_2} \right) \dots}{a_1! a_2! \dots \Gamma \left( 1 + \frac{a_1}{a_1} + \frac{a_2}{a_2} + \dots \right)}.$$

If, however, the object aimed at is the volume of an ellipsoid it is simpler to reduce the domain of integration to that within a sphere of radius unity by the transformation  $x = a\xi$ ,  $y = b\eta$ ,  $z = c\zeta$ , and then to perform the integration through the sphere by transforming to polar coordinates as in (ix).

56. Methods of approximate integration began to be devised very early. Kepler's practical measurement of the focal sectors of ellipses (1609) was an approximate integration, as also was the method for the quadrature of the hyperbola given by James Gregory in the appendix to his *Exercitationes geometricae* (1668). In Newton's *Methodus differentialis* (1711) the subject was taken up systematically. Newton's object was to effect the approximate quadrature of a given curve by making a curve of the type

$$y = a_0 + a_1 x + a_2 x^2 + \dots + a_n x^n$$

pass through the vertices of  $(n+1)$  equidistant ordinates of the given curve, and by taking the area of the new curve so determined as an approximation to the area of the given curve. In 1743 Thomas Simpson in his *Mathematical Dissertations* published a very convenient rule, obtained by taking the vertices of three consecutive equidistant ordinates to be points on the same parabola. The distance between the extreme ordinates corresponding to the abscissae  $x = a$  and  $x = b$  is divided into  $2n$  equal segments by ordinates  $y_1, y_2, \dots, y_{2n-1}$ , and the extreme ordinates are denoted by  $y_0, y_{2n}$ . The vertices of the ordinates  $y_0, y_1, y_2$  lie on a parabola with its axis parallel to the axis of  $x$ , so do also the vertices of the ordinates  $y_2, y_3, y_4$ , and so on. The area is expressed approximately by the formula

$\frac{1}{2}(b-a)/6n [y_0 + y_{2n} + 2(y_2 + y_4 + \dots + y_{2n-2}) + 4(y_4 + y_8 + \dots + y_{2n-4})]$ , which is known as Simpson's rule. Since all simple integrals can be represented as areas such rules are applicable to approximate integration in general. For the recent developments reference may be made to the article by A. Voss in *Ency. d. Math. Wiss.*, Bd. II., A., 2 (1899), and to a monograph by B. P. Moors, *Valeur approximative d'une integrale definie* (Paris, 1905).

Many instruments have been devised for registering mechanically the areas of closed curves and the values of integrals. The best known are perhaps the "planimeter" of J. Amsler (1854) and the "integrator" of Abdank-Abakanowicz (1882).

Bibliography.—For historical questions relating to the subject the chief authority is M. Cantor, *Geschichte d. Mathematik* (3 Bde., Leipzig, 1894-1901). For particular matters, or special periods, the following may be mentioned: H. G. Zeuthen, *Geschichte d. Math. im Altertum u. Mittelalter* (Copenhagen, 1896) and *Gesch. d. Math. im XVII. u. XVIII. Jahrhundert* (Leipzig, 1903); S. Horsley, *Isaac Newtoni opera quae exstant omnia* (5 vols., London, 1779-1785); C. I. Gerhardt, *Leibnizens math. Schriften* (7 Bde., Leipzig, 1849-1863); Joh. Bernoulli, *Opera omnia* (4 Bde., Lausanne and Geneva, 1742). Other writings of importance in the history of the subject

Approximate and Mechanical Integration.

are cited in the course of the article. A list of some of the more important treatises on the differential and integral calculus is appended. The list has no pretensions to completeness; in particular, most of the recent books in which the subject is presented in an elementary way for beginners or engineers are omitted.—L. Euler, *Institutiones calculi differentialis* (Petrop., 1755) and *Institutiones calculi integralis* (3 Bde., Petrop., 1768-1770); J. L. Lagrange, *Leçons sur le calcul des fonctions* (Paris, 1806, *Œuvres*, t. x.), and *Théorie des fonctions analytiques* (Paris, 1797, 2nd ed., 1813, *Œuvres*, t. ix.); S. F. Lacroix, *Traité de calcul diff. et de calcul int.* (3 tt., Paris, 1808-1819). There have been numerous later editions; a translation by Herschel, Peacock and Babbage of an abbreviated edition of Lacroix's treatise was published at Cambridge in 1816.

G. Peacock, *Examples of the Differential and Integral Calculus* (Cambridge, 1820); A. L. Cauchy, *Résumé des leçons . . . sur le calcul infinitésimal* (Paris, 1823), and *Leçons sur le calcul différentiel* (Paris, 1829; *Œuvres*, sér. 2, t. iv.); F. Minding, *Handbuch d. Diff.-u. Int.-Rechnung* (Berlin, 1836); F. Moigno, *Leçons sur le calcul diff.* (4 tt., Paris, 1840-1861); A. de Morgan, *Diff. and Int. Calc.* (London, 1842); D. Gregory, *Examples on the Diff. and Int. Calc.* (2 vols., Cambridge, 1841-1846); I. Todhunter, *Treatise on the Diff. Calc. and Treatise on the Int. Calc.* (London, 1852), numerous later editions; B. Price, *Treatise on the Infinitesimal Calculus* (2 vols., Oxford, 1854), numerous later editions; D. Bierens de Haan, *Tableaux d'intégrales définies* (Amsterdam, 1858); M. Stegmann, *Grundriss d. Diff.-u. Int.-Rechnung* (2 Bde., Hanover, 1862), numerous later editions; J. Bertrand, *Traité de calc. diff. et int.* (2 tt., Paris, 1864-1870); J. A. Serret, *Cours de calc. diff. et int.* (2 tt., Paris, 1868, 2nd ed., 1880, German edition by Harnack, Leipzig, 1884-1886, later German editions by Bohlmann, 1896, and Scheffers, 1906, incomplete); B. Williamson, *Treatise on the Diff. Calc.* (Dublin, 1872), and *Treatise on the Int. Calc.* (Dublin, 1874), numerous later editions of both; also the article "Infinitesimal Calculus" in the 9th ed. of the *Encyc. Brit.*; C. Hermite, *Cours d'analyse* (Paris, 1873); O. Schlömilch, *Compendium d. höheren Analysis* (2 Bde., Leipzig, 1874), numerous later editions; J. Thomae, *Einleitung in d. Theorie d. bestimmten Integrale* (Halle, 1875); R. Lipschitz, *Lehrbuch Analysis* (2 Bde., Bonn, 1877, 1880); A. Harnack, *Elemente d. Diff.-u. Int.-Rechnung* (Leipzig, 1882, Eng. trans. by Cathart, London, 1891); M. Pasch, *Einleitung in d. Diff.-u. Int.-Rechnung* (Leipzig, 1882); Genocchi and Peano, *Calcolo differenziale* (Turin, 1884, German edition by Bohlmann and Schepp, Leipzig, 1898, 1899); H. Laurent, *Traité d'analyse* (7 tt., Paris, 1885-1891); J. Edwards, *Elementary Treatise on the Diff. Calc.* (London, 1886), several later editions; A. G. Greenhill, *Diff. and Int. Calc.* (London, 1886, 2nd ed., 1891); É. Picard, *Traité d'analyse* (3 tt., Paris, 1891-1896); O. Stolz, *Grundzüge d. Diff.-u. Int.-Rechnung* (3 Bde., Leipzig, 1893-1899); C. Jordan, *Cours d'analyse* (3 tt., Paris, 1893-1896); L. Kronecker, *Vorlesungen u. d. Theorie d. einfachen u. vielfachen Integrale* (Leipzig, 1890); J. Perry, *The Calculus for Engineers* (London, 1897); H. Lamb, *An Elementary Course of Infinitesimal Calculus* (Cambridge, 1897); G. A. Gibson, *An Elementary Treatise on the Calculus* (London, 1901); É. Gourast, *Cours d'analyse mathématique* (2 tt., Paris, 1902-1905); C.-J. de la Vallée Poussin, *Cours d'analyse infinitésimale* (2 tt., Louvain and Paris, 1903-1906); A. E. H. Love, *Elements of the Diff. and Int. Calc.* (Cambridge, 1909); W. H. Young, *The Fundamental Theorems of the Diff. Calc.* (Cambridge, 1910). A résumé of the infinitesimal calculus is given in the articles "Diff.-u. Int.-Rechnung" by A. Voss, and "Bestimmte Integrale" by G. Brunel in *Ency. d. math. Wiss.* (Bde. ii. A. 2, and ii. A. 3, Leipzig, 1890, 1900). Many questions of principle are discussed exhaustively by E. W. Hobson, *The Theory of Functions of a Real Variable* (Cambridge, 1907). (A. E. H. L.)

**INFINITIVE**, a form of the verb, properly a noun with verbal functions, but usually taken as a mood (see GRAMMAR). The Latin grammarians gave it the name of *infinitus* or *infinitivus modus*, i.e. indefinite, unlimited mood, as not having definite persons or numbers.

**INFLEXION** (from Lat. *inflectere*, to bend), the action of bending inwards, or turning towards oneself, or the condition of being bent or curved. In optics, the term "inflexion" was used by Newton for what is now known as "diffraction of light" (*q.v.*). For inflexion in geometry see CURVE. Inflexion when used of the voice, in speaking or singing, indicates a change in tone, pitch or expression. In grammar (*q.v.*) inflexion indicates the changes which a word undergoes to bring it into correct relations with the other words with which it is used. In English grammar nouns, pronouns, adjectives (in their degrees of comparison), verbs and adverbs are inflected. Some grammarians, however, regard the inflexions of adverbs more as an actual change in word-formation.

**INFLUENCE** (Late Lat. *influentia*, from *influerē*, to flow in), word whose principal modern meaning is that of power, control or action affecting others, exercised either covertly or without

visible means or direct physical agency. It is one of those numerous terms of astrology (*q.v.*) which have established themselves in current language. From the stars was supposed to flow an ethereal stream which affected the course of events on the earth and the fortunes and characters of men. For the law as to "undue influence" see CONTRACT.

**INFLUENZA** (syn. "grip," *la grippe*), a term applied to an infectious febrile disorder due to a specific bacillus, characterized specially by catarrh of the respiratory passages and alimentary canal, and occurring mostly as an epidemic. The Italians in the 17th century ascribed it to the influence of the stars, and hence the name "influenza." The French name *grippe* came into use in 1743, and those of *petite peste* and *petit courier* in 1762, while *général* became another synonym in 1780. Apparently the scourge was common; in 1403 and 1557 the sittings of the Paris law courts had to be suspended through it, and in 1427 sermons had to be abandoned through the coughing and sneezing; in 1510 masses could not be sung. Epidemics occurred in 1580, 1676, 1703, 1732 and 1737, and their cessation was supposed to be connected with earthquakes and volcanic eruptions.

The disease is referred to in the works of the ancient physicians, and accurate descriptions of it have been given by medical writers during the last three centuries. These various accounts agree substantially in their narration of the phenomena and course of the disease, and influenza has in all times been regarded as fulfilling all the conditions of an epidemic in its sudden invasion, and rapid and extensive spread. Among the chief epidemics were those of 1762, 1782, 1787, 1803, 1833, 1837 and 1847. It appeared in fleets at sea away from all communication with land, and to such an extent as to disable them temporarily for service. This happened in 1782 in the case of the squadron of Admiral Richard Kempenfelt (1718-1782), which had to return to England from the coast of France in consequence of influenza attacking his crews.

Like cholera and plague, influenza reappeared in the last quarter of the 19th century, after an interval of many years, in epidemic or rather pandemic form. After the year 1848, in which 7063 deaths were directly attributed to influenza in England and Wales, the disease continued prevalent until 1860, with distinct but minor epidemic exacerbations in 1851, 1855 and 1858; during the next decade the mortality dropped rapidly though not steadily, and the diminution continued down to the year 1889, in which only 55 deaths were ascribed to this cause. It is not clear whether the disease ever disappears wholly, and the deaths registered in 1889 are the lowest recorded in any year since the registrar-general's returns began. Occasionally local outbreaks of illness resembling epidemic influenza have been observed during the period of abeyance, as in Norfolk in 1878 and in Yorkshire in 1887; but whether such outbreaks and the so-called "sporadic" cases are nosologically identical with epidemic influenza is open to doubt. The relation seems rather to be similar to that between Asiatic cholera and "cholera nostras." Individual cases may be indistinguishable, but as a factor in the public health the difference between sporadic and epidemic influenza is as great and unmistakable as that between the two forms of cholera. This fact, which had been forgotten by some since 1847 and never learnt by others, was brought home forcibly to all by the visitation of 1889.

According to the exhaustive report drawn up by Dr H. Franklin Parsons for the Local Government Board, the earliest appearances were observed in May 1889, and three localities are mentioned as affected at the same time, all widely separated from each other—namely, Bokhara in Central Asia, Athabasca in the north-west Territories of Canada and Greenland. About the middle of October it was reported at Tomsk in Siberia, and by the end of the month at St Petersburg. During November Russia became generally affected, and cases were noticed in Paris, Berlin, Vienna, London and Jamaica (?). In December epidemic influenza became established over the whole of Europe, along the Mediterranean, in Egypt and over a large area in the United States. It appeared in several towns in England, beginning with Portsmouth, but did not become generally



epidemic until the commencement of the new year. In London the full onset of unmistakable influenza dated from the 1st of January 1890. Everywhere it seems to have exhibited the same explosive character when once fully established. In St Petersburg, out of a government staff of 260 men, 220 were taken ill in one night, the 15th of November. During January 1890 the epidemic reached its height in London, and appeared in a large number of towns throughout the British Islands, though it was less prevalent in the north and north-west than in the south. January witnessed a great extension of the disease in Germany, Holland, Switzerland, Austria-Hungary, Italy, Spain and Portugal; but in Russia, Scandinavia and France it was already declining. The period of greatest activity in Europe was the latter half of December and the earlier half of January, with the change of the year for a central point. Other parts of the world affected in January 1890 were Cape Town, Canada, the United States generally, Algiers, Tunis, Cairo, Corsica, Sardinia, Sicily, Honolulu, Mexico, the West Indies and Montevideo. In February the provincial towns of England were most severely affected, the death-rate rising to 2.74, but in London it fell from 28.1 to 21.2, and for Europe generally the back of the epidemic was broken. At the same time, however, it appeared in Ceylon, Penang, Japan, Hong Kong and India; also in West Africa, attacking Sierra Leone, and Gambia in the middle of the month; and finally in the west, where Newfoundland and Buenos Aires were invaded. In March influenza became widely epidemic in India, particularly in Bengal and Bombay, and made its appearance in Australia and New Zealand. In April and May it was epidemic all over Australasia, in Central America, Brazil, Peru, Arabia and Burma. During the summer and autumn it reached a number of isolated islands, such as Iceland, St Helena, Mauritius and Réunion. Towards the close of the year it was reported from Yunnan in the interior of China, from the Shire Highlands in Central Africa, Shoa in Abyssinia, and Gilgit in Kashmir. In the course of fifteen months, beginning with its undoubted appearance in Siberia in October 1889, it had traversed the entire globe.

The localities attacked by influenza in 1889-1890 appear in no case to have suffered severely for more than a month or six weeks. Thus in Europe and North America generally the visitation had come to an end in the first quarter of 1890. The earliest signs of an epidemic revival on a large scale occurred in March 1891, in the United States and the north of England. It was reported from Chicago and other large towns in the central states, whence it spread eastwards, reaching New York about the end of March. In England it began in the Yorkshire towns, particularly in Hull, and also independently in South Wales. In London influenza became epidemic for the second time about the end of April, and soon afterwards was widely distributed in England and Wales. The large towns in the north, together with London and Wales, suffered much more heavily in mortality than in the previous attack, but the south-west of England, Scotland and Ireland escaped with comparatively little sickness. The same may be said of the European continent generally, except parts of Russia, Scandinavia and perhaps the north of Germany. This second epidemic coincided with the spring and early summer; it had subsided in London by the end of June. The experience of Sheffield is interesting. In 1890 the attack, contrary to general experience, had been undecided, lingering and mild; in 1891 it was very sudden and extremely severe, the death-rate rising to 73.4 during the month of April, and subsiding with equal rapidity. During the third quarter of the year, while Europe was free, the antipodes had their second attack, which was more severe than the first. As in England, it reversed the previous order of things, beginning in the provinces and spreading thence to the capital towns. The last quarter of the year was signalized by another recrudescence in Europe, which reached its height during the winter. All parts, including Great Britain, were severely affected. In England those parts which had borne the brunt of the epidemic in the early part of the year escaped. In fact, these two revivals may be regarded as one, temporarily interrupted by the summer quarter.

The recrudescence at the end of 1891 lasted through mid-winter, and in many places, notably in London, it only reached its height in January 1892, subsiding slowly and irregularly in February and March. Brighton suffered with exceptional severity. The continent of Europe seems to have been similarly affected. In Italy the notifications of influenza were as follow: 1891—January to October, 0; November, 30; December, 6461; 1892—January, 84,543; February, 55,352; March, 28,046; April, 7962; May, 1468; June, 223. Other parts of the world affected were the West Indies, Tunis, Egypt, Sudan, Cape Town, Teheran, Tongking and China. In August 1892 influenza was reported from Peru, and later in the year from various places in Europe.

A fourth recrudescence, but of a milder character, occurred in Great Britain in the spring of 1893, and a fifth in the following winter, but the year 1894 was freer from influenza than any since 1890. In 1895 another extensive epidemic took place. In 1896 influenza seemed to have spent its strength, but there was an increased prevalence of the disease in 1897, which was repeated on a larger scale in 1898, and again in 1899, when 12,417 deaths were recorded in England and Wales. This was the highest death-rate since 1892. After this the death-rate declined to half that amount and remained there with the slight upward variations until 1907, in which the total death-rate was 0.257. The experience of other countries has been very similar; they have all been subjected to periodical revivals of epidemic influenza at irregular intervals and of varying intensity since its reappearance in 1880, but there has been a general though not a steady decline in its activity and potency. Its behaviour is, in short, quite in keeping with the experience of 1874-1880, though the later visitation appears to have been more violent and more fatal than the former. Its diffusion was also more rapid and probably more extensive.

The foregoing general summary may be supplemented by some further details of the incidence in Great Britain. The number of deaths directly attributed to influenza, and the death-rates per million in each year in England and Wales, are as follow:—

Year.	Deaths.	Death-rates per million.	Year.	Deaths.	Death-rates per million.
1890	4,523	157	1899	12,417	380
1891	16,686	574	1900	16,245	504
1892	15,737	534	1901	5,666	174
1893	9,669	325	1902	7,366	223
1894	6,625	220	1903	6,322	180
1895	12,880	424	1904	5,694	168
1896	3,753	122	1905	6,653	204
1897	6,088	196	1906	6,310	183
1898	10,405	331	1907	9,257	265

It is interesting to compare these figures with the corresponding ones for the previous visitation:—

Year.	Deaths.	Death-rates per million.	Year.	Deaths.	Death-rates per million.
1847	4,881	285	1852	1,350	76
1848	7,963	460	1853	1,789	90
1849	1,611	92	1854	1,061	58
1850	1,380	78	1855	3,568	193
1851	2,152	120			

The two sets of figures are not strictly comparable, because, during the first period, notification of the cause of death was not compulsory; but it seems clear that the later wave was much the more deadly. The average annual death-rate for the nine years is 3.20 in the one case against 1.62 in the other, or as nearly as possible double. In both epidemic periods the second year was far more fatal than the first, and in both a marked revival took place in the ninth year; in both also an intermediate recrudescence occurred, in the fifth year in one case, in the sixth in the other. The chief point of difference is the sudden and marked drop in 1849-1850, against a persistent high mortality in 1892-1893, especially in 1892, which was nearly as fatal as 1891.

To make the significance of these epidemic figures clear, it should be added that in the intervening period 1861-1889 the average annual death-rate from influenza was only fifteen, and in the ten years immediately preceding the 1890 outbreak it was only three. Moreover, in epidemic influenza, the mortality directly attributed to that disease is only a fraction of that actually caused by it. For instance, in January 1890 the deaths from influenza in London were 304, while the excess of deaths from respiratory diseases was 1454 and from all causes 1958 above the average.

We have seen above that the mortality was far greater in the second epidemic year than in the first, and this applies to all parts of England, and to rural as well as to urban communities, as the following table shows:—

Deaths from Influenza.

	1890.	1891.
London . . . . .	624	2302
24 Great Towns over 80,000 population . . . . .	439	2417
35 Towns between 20,000 and 80,000 . . . . .	186	765
21 Towns between 10,000 and 20,000 . . . . .	46	196
60 Towns under 10,000 . . . . .	62	196
85 Rural Sanitary Districts . . . . .	317	841

In spite of these figures, it appears that the 1890 attack, which was in general much more sudden in its onset than that of 1891, also caused a great deal more sickness. More people were "down with influenza," though fewer died. For instance, the number of persons treated at the Middlesex Hospital in the two months' winter epidemic of 1890 was 1279; in the far more fatal three months' spring epidemic of 1891 it was only 726. One explanation of this discrepancy between the incidence of sickness and mortality is that in the second attack, which was more protracted and more insidious, the stress of the disease fell more upon the lungs. Another is that its comparative mildness, combined with the time of year, in itself proved dangerous, because it tempted people to disregard the illness, whereas in the first epidemic they were too ill to resist. On the whole, rural districts showed a higher death-rate than towns, and small towns a higher one than large ones in both years. This is explained by the age distribution in such localities; influenza being particularly fatal to aged people, though no age is exempt. Certain counties were much more severely affected than others. The eastern counties, namely, Essex, Suffolk and Norfolk, together with Hampshire and one or two others, escaped lightly in both years; the western counties, namely, North and South Wales, with the adjoining counties of Monmouth, Hereford and Shropshire, suffered heavily in both years.

It will be convenient to discuss *seriatim* the various points of interest on which light has been thrown by the experience described above.

The bacteriology of influenza is discussed in the article on PARASITIC DISEASES. The disease is often called "Russian" influenza, and its origin in 1889 suggests that the name may have some foundation in fact. A writer, who saw the epidemic break out in Bokhara, is quoted by him to the following effect:—"The summer of 1888 was exceptionally hot and dry, and was followed by a bitterly cold winter and a rainy spring. The dried-up earth was full of cracks and holes from drought and subsequent frost, so that the spring rains formed ponds in these holes, inundated the new railway cuttings, and turned the country into a perfect marsh. When the hot weather set in the water gave off poisonous exhalations, rendering malaria general." On account of the severe winter, the people were enfeebled from lack of nourishment, and when influenza broke out suddenly they died in large numbers. Europeans were very severely affected. Russians, hurrying home, carried the disease westwards, and caravans passing eastwards took it into Siberia. There is a striking similarity in the conditions described to those observed in connexion with outbreaks of other diseases, particularly typhoid fever and diphtheria, which have occurred on the super-vention of heavy rain after a dry period, causing cracks and fissures in the earth. Assuming the existence of a living poison

in the ground, we can easily understand that under certain conditions, such as an exceptionally dry season, it may develop exceptional properties and then be driven out by the subsequent rains, causing a violent outbreak of illness. Some such explanation is required to account for the periodical occurrence of epidemic and pandemic diffusions starting from an endemic centre. We may suppose that a micro-organism of peculiar robustness and virulence is bred and brought into activity by a combination of favourable conditions, and is then disseminated more or less widely according to its "staying power," by human agency. Whether central Asia is an endemic centre for influenza or not there is no evidence, but the disease seems to be more often prevalent in the Russian Empire than elsewhere. Extensive outbreaks occurred there in 1886 and 1887, and it is certain that the 1889 wave was active in Siberia at an earlier date than in Europe, and that it moved eastwards. The hypothesis that it originated in China is unsupported by evidence. But whatever may be the truth with regard to origin, the dissemination of influenza by human agency must be held to be proved. This is the most important addition to our knowledge of the subject contributed by recent research. The upshot of the inquiry by Dr Parsons was to negative all theories of atmospheric influence, and to establish the conclusion that the disease was "propagated mainly, perhaps entirely, by human intercourse."

He found that it prevailed independently of climate, season and weather; that it moved in a contrary direction to the prevailing winds; that it travelled along the lines of human intercourse, and not faster than human beings can travel; that in 1889 it travelled much faster than in previous epidemics, when the means of locomotion were very inferior; that it appeared first in capital towns, seaports and frontier towns, and only affected country districts later; that it never commenced suddenly with a large number of cases in a place previously free from disease, but that epidemic manifestations were generally preceded for some days or weeks by scattered cases; that conveyance of infection by individuals and its introduction into fresh places had been observed in many instances; that persons brought much into contact with others were generally the first to suffer; that persons brought together in large numbers in enclosed spaces suffered more in proportion than others, and that the epidemic and extent of the outbreak in institutions corresponded with the massing together of the inmates.

These conclusions, based upon the 1889-1890 epidemic, have been confirmed by subsequent experience, especially in regard to the complete independence of season and weather shown by influenza. It has appeared and disappeared at all seasons and in all weathers and only popular ignorance continues to ascribe its behaviour to atmospheric conditions. In Europe, however, it has prevailed more often in winter than in summer, which may be due to the greater susceptibility of persons in winter, or, more probably, to the fact that they congregate more in buildings and are less in the open air during that part of the year. No doubt is any longer entertained of its infectious character, though the degree of infectivity appears to vary considerably. Many cases have been recorded of individuals introducing it into houses, and of all or most of the other inmates then taking it from the first case. Difficulties in preventing the spread of infection are due to (1) the shortness of the period of incubation, (2) the disease being infectious in the earliest stages before the nature of the illness is recognized, (3) the milder varieties being equally infectious with the severe attacks, and the patient going to work and spreading the infection, (4) the diagnosis often being difficult, influenza being possibly confused with ordinary catarrhal attacks, typhoid fever and other diseases. Domestic animals seem to be free from any suspicion of being liable to human influenza. Sanitary conditions, other than overcrowding, do not appear to exercise any influence on the spread of influenza.

Influenza has been shown to be an acute specific fever having nothing whatever to do with a "bad cold." There may be some inflammation of the respiratory passages, and then symptoms of catarrh are present, but that is not necessarily the case, and in some epidemics such symptoms are quite exceptional. This had been recognized by various writers

before the 1889 visitation, but it had not been generally realized, as it has been since, and some medical authorities, who persisted in regarding influenza as essentially a "catarrhal" affection, were chiefly to blame for a widespread and tenacious popular fallacy.

Leichtenstern, in his masterly article in Nothnagel's *Handbuch*, divides the disease as follows:—(1) Epidemic influenza vera caused by Pfeiffer's bacillus; (2) Endemic-epidemic influenza vera, which occurs several years after a pandemic and is caused by the same bacillus; (3) Endemic influenza nostras or catarrhal fever, called *la grippe*, and bearing the same relation to true influenza as cholera nostras does to Asiatic cholera.

The "period of incubation" is one to four days. Susceptibility varies greatly, but the conditions that influence it are matters of conjecture only. It appears that the inhabitants of Great Britain are less susceptible than those of many other countries. Dr Parsons gives the following list, showing the proportion of the population estimated to have been attacked in the 1889-1890 epidemic in different localities:—

Place.	Per cent.	Place.	Per cent.
St Petersburg . . . .	50	Portugal . . . . .	90
Berlin . . . . .	33	Vienna . . . . .	30-40
Nuremberg . . . . .	67	Belgrade . . . . .	33
Grand-Duchy of Hesse . . . .	25-30	Antwerp . . . . .	33
Grand-Duchy, other Districts . . . . .	50-75	Gaeta . . . . .	50-77
Massachusetts . . . . .	39		
Heligoland . . . . .	50	Peking . . . . .	50
Budapest . . . . .	50	St Louis (Mauritius) . . . .	67

In and about London he reckoned roughly from a number of returns that the proportion was about 12½% among those employed out of doors and 25% among those in offices, &c. The proportion among the troops in the Home District was 9-3%. The General Post Office made the highest return with 33-6%, which is accounted for partly by the enormous number of persons massed together in the same room in more than one department, and partly by the facilities for obtaining medical advice, which would tend to bring very light cases, unnoticed elsewhere, upon the record. No public service was seriously disorganized in England by sickness in the same manner as on the continent of Europe. Some individuals appear to be totally immune; others take the disease over and over again, deriving no immunity, but apparently greater susceptibility from previous attacks.

The symptoms were thus described by Dr Bruce Low from observations made in St Thomas's Hospital, London, in January 1890:—

The invasion is sudden; the patients can generally tell the time when they developed the disease; e.g. acute pains in the back and loins came on quite suddenly while they were at work or walking in the street, or in the case of a medical student, while playing cards, rendering him unable to continue the game. A workman wheeling a barrow had to put it down and leave it; and an omnibus driver was unable to pull up his horses. This sudden onset is often accompanied by vertigo and nausea, and sometimes actual vomiting of bilious matter. There are pains in the limbs and general sense of aching all over; frontal headache of special severity; pains in the eyeballs, increased by the slightest movement of the eyes; shivering; general feeling of misery and weakness, and great depression of spirits; many patients, both men and women, giving way to weeping; nervous restlessness; inability to sleep, and occasionally delirium. In some cases catarrhal symptoms develop, such as running at the eyes, which are sometimes injected on the second day; sneezing and sore throat; and epistaxis, swelling of the parotid and submaxillary glands, tonsillitis, and spitting of bright blood from the pharynx may occur. There is a hard, dry cough of a paroxysmal kind, worst at night. There is often tenderness of the spleen, which is almost always found enlarged, and this persists after the acute symptoms have passed. The temperature is high at the onset of the disease. In the first twenty-four hours its range is from 100° F. in mild cases to 105° in severe cases.

Dr J. S. Bristowe gave the following description of the illness during the same epidemic:—

The chief symptoms of influenza are, coldness along the back,

with shivering, which may continue off and on for two or three days; severe pain in the head and eyes, often with tenderness in the eyes and pain in moving them; pains in the ears; pains in the small of the back; pains in the limbs, for the most part in the fleshy portions, but also in the bones and joints, and even in the fingers and toes; and febrile temperature, which may in the early period rise to 104° or 105° F. At the same time the patient feels excessively ill and prostrate, is apt to suffer from nausea or sickness and diarrhoea, and is for the most part restless, though often (and especially in the case of children and those advanced in age) drowsy. . . . In ordinary mild cases the above symptoms are the only important ones which present themselves, and the patient may recover in the course of three or four days. He may even have it so mildly that, although feeling very ill, he is able to go about his ordinary work. In some cases the patient may have additionally some dryness or soreness of the throat, or some stiffness and discharge from the nose, which may be accompanied by slight bleeding. And in some cases, for the most part in the course of a few days, and at a time when the patient seems to be convalescent, he begins to suffer from wheezing in the chest, cough, and perhaps a little shortness of breath, and before long spits mucus in which are contained pellets streaked or tinged with blood. . . . Another complication is diarrhoea. Another is a roseolous spotty rash. . . . Influenza is by no means necessarily attended with the catarrhal symptoms which the general public have been taught to regard as its distinctive signs, and in a very large proportion of cases no catarrhal condition whatever becomes developed at any time.

Several writers have distinguished four main varieties of the disease—namely, (1) nervous, (2) gastro-intestinal, (3) respiratory, (4) febrile, a form chiefly found in children. Clifford Allbutt says, "Influenza simulates other diseases." Many forms are of typhoid or comatose types. Cardiac attacks are common, not from organic disease but from the direct poisoning of the heart muscle by influenza.

Perhaps the most marked feature of influenza, and certainly the one which victims have learned to dread most, is the prolonged debility and nervous depression that frequently follow an attack. It was remarked by Nothnagel that "Influenza produces a specific nervous toxin which by its action on the cortex produces psychoses." In the Paris epidemic of 1890 the suicides increased 25%, a large proportion of the excess being attributed to nervous prostration caused by the disease. Dr Rawes, medical superintendent of St Luke's hospital, says that of insanities traceable to influenza melancholia is twice as frequent as all other forms of insanity put together. Other common after-effects are neuralgia, dyspepsia, insomnia, weakness or loss of the special senses, particularly taste and smell, abdominal pains, sore throat, rheumatism and muscular weakness. The feature most dangerous to life is the special liability of patients to inflammation of the lungs. This affection must be regarded as a complication rather than an integral part of the illness. The following diagram gives the annual death-rate per million in England and Wales, and is taken from an article by Dr Arthur Newsholme in *The Practitioner* (January 1907).

The deaths directly attributed to influenza are few in proportion to the number of cases. In the milder forms it offers hardly any danger to life if reasonable care be taken, but in the severer forms it is a fairly fatal disease. In eight London hospitals the case-mortality among in-patients in the 1890 outbreak was 34-5 per 1000; among all patients treated it was 1-6 per 1000. In the army it was rather less.

The infectious character of influenza having been determined, suggestions were made for its administrative control on the familiar lines of notification, isolation and disinfection, but this has not hitherto been found practicable. In March 1895, however, the Local Government Board issued a memorandum recommending the adoption of the following precautions wherever they can be carried out:—

1. The sick should be separated from the healthy. This is especially important in the case of first attacks in a locality or a household.
2. The sputa of the sick should, especially in the acute stage of the disease, be received into vessels containing disinfectants. Infected articles and rooms should be cleansed and disinfected.
3. When influenza threatens, unnecessary assemblages of persons should be avoided.
4. Buildings and rooms in which many people necessarily congregate should be efficiently aerated and cleansed during the intervals of occupation.

There is no routine treatment for influenza except bed. In all cases bed is advisable, because of the danger of lung complications, and in mild ones it is sufficient. Severe ones must be treated according to the symptoms. Quinine has been much used. Modern "anti-pyretic" drugs have also been extensively employed, and when applied with discretion they may be useful, but patients are not advised to prescribe them for themselves.

Sir Wm. Broadbent in a note on the prophylaxis of influenza recommends quinine in a dose of two grains every morning, and remarks: "I have had opportunities of obtaining extraordinary evidence of its protective power. In a large public school it was ordered to be taken every morning. Some of the boys in the school were home boarders, and it was found that while

practice were incorporated into one code and embodied in the rules of the Supreme Court (O. xvi. rr. 22-31). Now any person may be admitted to sue as a pauper, on proof that he is not worth £25, his wearing apparel and the subject matter of the cause or matter excepted. He must lay his case before counsel for opinion, and counsel's opinion thereon, with an affidavit of the party suing that the case contains a full and true statement of all the material facts to the best of his knowledge and belief, must be produced before the proper officers to whom the application is made. A person who desires to defend as a pauper must enter an appearance to a writ in the ordinary way and afterwards apply for an order to defend as a pauper. Where a person is admitted to sue or defend as a pauper, counsel and solicitor may be assigned to him, and such counsel and solicitor are not at liberty to refuse assistance unless there is some good reason for refusing. If any person admitted to sue or defend as a pauper agrees to pay fees to any person for the conduct of his business he will be dispaupered. Costs ordered to be paid to a pauper are taxed as in other cases. Appeals to the House of Lords in *formâ pauperis* were regulated by the Appeal (*Formâ Pauperis*) Act 1893, which gave the House of Lords power to refuse a petition for leave to sue.

**INFORMATION** (from Lat. *informare*, to give shape or form to, to represent, describe), the communication of knowledge; in English law, a proceeding on behalf of the crown against a subject otherwise than by indictment. A criminal information is a proceeding in the King's bench by the attorney-general without the intervention of a grand jury. The attorney-general, or, in his absence, the solicitor-general, has a right *ex officio* to file a criminal information in respect of any indictments, but not for treason, felonies or misprision of treason. It is, however, seldom exercised, except in cases which might be described as "enormous misdemeanours," such as those peculiarly tending to disturb or endanger the king's government, e.g. seditions, obstructing the king's officers in the execution of their duties, &c. In the form of the proceedings the attorney-general is said

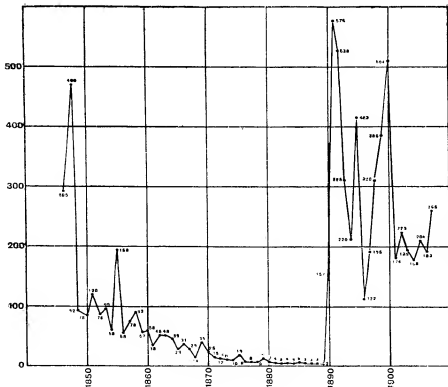

the boarders at the school took the quinine in the presence of a master every morning, there were scarcely any cases of influenza among them, although the home boarders suffered nearly as much as before." He continues, "In a large girls' school near London the same thing was ordered, and the girls and mistresses took their morning dose but the servants were forgotten. The result was that scarcely any girl or mistress suffered while the servants were all down with influenza."

The liability to contract influenza, and the danger of an attack if contracted, are increased by depressing conditions, such as exposure to cold and to fatigue, whether mental or physical. Attention should, therefore, be paid to all measures tending to the maintenance of health. Persons who are attacked by influenza should at once seek rest, warmth and medical treatment, and they should bear in mind that the risk of relapse, with serious complications, constitutes a chief danger of the disease.

In addition to the ordinary text-books, see the series of articles by experts on different aspects in *The Practitioner* (London) for January 1907.

**IN FORMÂ PAUPERIS** (Latin, "in the character of pauper"), the legal phrase for a method of bringing or defending a case in court on the part of persons without means. By an English statute of 1495 (11 Hen. VII. c. 12), any poor person having cause of action was entitled to have a writ according to the nature of the case, without paying the fees thereon. The statute of 1495 was repealed by the Statute Law Revision and Civil Procedure Act 1883, but its provisions, as well as the chancery

to "come into the court of our lord the king before the king himself at Westminster, and gives the court there to understand and be informed that, &c." Then follows the statement of the offence as in an indictment. The information is filed in the crown office without the leave of the court. An information may also be filed at the instance of a private prosecutor for misdemeanours not affecting the government, but being peculiarly flagrant and pernicious. Thus criminal informations have been granted for bribing or attempting to bribe public functionaries, and for aggravated libels on public or private persons. Leave to file an information is obtained after an application to show cause, founded on a sworn statement of the material facts of the case.

Certain suits might also be filed in Chancery by way of information in the name of the attorney-general, but this species of information was superseded by Order 1, rule 1 of the Rules of the Supreme Court, 1883, under which they are instituted in the ordinary way. Informations in the Court of Exchequer in revenue cases, also filed by the attorney-general, are still resorted to (see *A.-G. v. Williamson*, 1889, 60 L.T. 930).

**INFORMER**, in a general sense, one who communicates information. The term is applied to a person who prosecutes in any of the courts of law those who break any law or penal statute. Such a person is called a common informer when he furnishes evidence on criminal trials or prosecutes for breaches of penal laws solely for the purpose of obtaining the penalty recovered, or a share of it. An action by a common informer

is termed a *popular* or *qui tam* action, because it is brought by a person *qui tam pro domino rege quam pro se ipso sequitur*. A suit by an informer must be brought within a year of the offence, unless a specific time is prescribed by the statute. The term informer is also used of an accomplice in crime who turns what is called "king's evidence" (see ACCOMPLICE). In Scotland, informer is the term applied to the party who, in criminal proceedings, sets the lord advocate in motion.

**INFUSORIA**, the name given by Bütschli (following O.F. Ledermüller, 1763) to a group of Protozoa. The name arose

men, they included (1) Desmids, Diatoms and Schizomycetes, now regarded as essentially Plant Protista or Protophytes; (2) Sarcodina (excluding Foraminifera, as well as Radiolaria, which were only as yet known by their skeletons, and termed Polycystina), and (3) Rotifers, as well as (4) Flagellates and Infusoria in our present sense. F. Dujardin in his *Histoire des zoophytes* (1841) gave nearly as liberal an interpretation to the name; while C. T. Van Siebold (1845) narrowed it to its present limits save for the admission of several Flagellate families. O. Bütschli limited the group by removing the Flagellata, Dinoflagellata and Cystoflagellata (*q.v.*) under the name of "Mastigophora" proposed earlier by R. M. Diesing (1865). We now define it thus:—Protozoa bounded by a permanent plasmic pellicle and consequently of definite form, never using pseudopodia for locomotion or ingestion, provided (at least in the young state) with numerous cilia or organs derived from cilia and equipped with a double nuclear apparatus: the larger (mega-) nucleus usually dividing by constriction, and disappearing during conjugation; the smaller (micro-) nucleus (sometimes multiple) dividing by mitosis, and entering into conjugation and giving rise to the cycle of nuclei both large and small of the race succeeding conjugation.

Thus defined, the Infusoria fall into two groups:—(1) *Ciliata*, with cilia or organs derived from cilia throughout their lives, provided with a single permanent mouth (absent in the parasitic *Opalinopsidae*) flush with the body or at the base of an oral depression, and taking in food by active swallowing or by ciliary action: (2) *Suctorina*, rarely ciliated except in the young state, and taking in their food by suction through protrusible hollow tentacles, usually numerous.

The pellicle of the Infusoria is stronger and more permanent than in many Protozoa, and sometimes assumes the character of a mail of hard plates, closely fitting; but even in this case it undergoes solution soon after death. It is continuous with a firm ectosarc, highly differentiated in the Ciliata, and in both groups free from coarse movable granules. The endosarc is semifluid and rich in granules mostly "reserve" in nature, often showing proteid or fat reactions. One or more contractile vacuoles are present in some of the marine and all the freshwater species, and open to the surface by pores of permanent position: a system of canals in the deeper layers of the ectoplasm is sometimes connected with the vacuole. The body is often provided with not-living external formations "stalk" and "theca" (or "lorica").

The character of the nuclear apparatus excludes two groups both parasitic and mouthless: (1) the Trichonymphidae, with a single nucleus of Leidy, parasitic in Insects, especially Termites; (2) the Opalinidae, with several (often numerous) uniform nuclei, parasitic in the gut of Batrachia, &c., and producing 1-nuclear zoospores which conjugate. Both these families we unite into a group of *Flagellata (q.v.)*. Lankester in the last edition of this *Encyclopaedia* called attention to the doubtful position of *Opalina*, and DeLage and Hérouard placed Trichonymphidae among Flagellates.

The theca or shell is present in some pelagic species (figs. 3, 5) and in many of the attached species, notably among the Peritricha (figs. iii. 21, 22, 25, 26) and Suctorina (figs. iii. 11); and is found in some free-swimming forms (figs. iii. 3, 5); it is usually chitinous, and forms a cup into which the animal, protruded when at its utmost elongation, can retract itself. In *Melocinetula mystacina* it has several distinct slits (pylomes) for the passage of tufts of tentacles. In *Stentor* it is gelatinous; and in the Dictyocystids it is beautifully latticed.

The stalk is usually solid, and expanded at the base into a disk in Suctorina. In Peritrichaceae (figs. iii. 8-22, 25, 26), the only ciliate group with a stalk, it grows for some time after its formation, and on fission two new stalks continue the old one, so as to form a branched colony (fig. iii. 18). In *Vorticella* (fig. iii. 12, 14, &c.) the stalk is hollow and elastic, and attached to it along a spiral is a

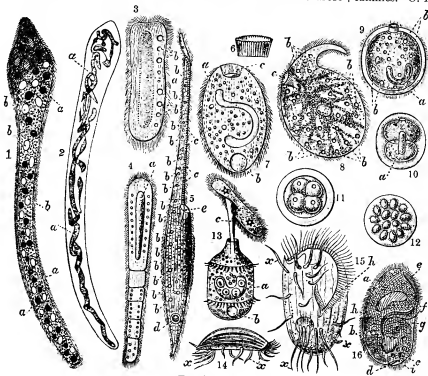

FIG. 1. Ciliata.

1. *Opalinopsis septata*, Foett.: a parasitic Holotrichous mouthless Ciliate from the liver of the Squid. *a*, branched meganucleus; *b*, vacuoles (non-contractile).
2. A similar specimen treated with picric acid, showing a remarkably branched and twisted meganucleus (*a*), in place of several nuclei.
3. *Anoplophrya nudos*, Duj.: a mouthless Holotrichous Ciliate parasitic in the worm *Nais*. *a*, the large axial meganucleus; *b*, contractile vacuoles.
4. *Anoplophrya prolifera*, C. and L.: from the intestine of *Clitellid*. Remarkable for the adhesion of incomplete fission-products in a metameric series. *a*, meganucleus.
5. *Amphileptus gigas*, C. and L. (Gymnostomaceae). *b*, contractile vacuoles; *c*, trichocysts (see fig. 2); *d*, meganucleus; *e*, pharynx.
6. 7. *Prorodon nicensis*, Ehr. (Gymnostomaceae). *a*, meganucleus; *b*, contractile vacuole; *c*, pharynx with horny cuticular lining.
6. The fasciulate cuticle of the pharynx isolated.
8. *Trachelius ovum*, Ehr. (Gymnostomaceae); showing the reticulate arrangement of the endosarc, *b*, contractile vacuoles; *c*, the cuticle-lined pharynx.
- 9, 10, 11, 12. *Icthyophthirus multifiliis*, Fouquet (Gymnostomaceae). Free individual and successive stages of division to form spores. *a*, meganucleus; *b*, contractile vacuoles.
13. *Didinium nasutum*, Müll. (Gymnostomaceae). The pharynx is everted and has seized a *Paramacium* as food. *a*, meganucleus; *b*, contractile vacuole; *c*, everted pharynx.
14. *Euplates charon*, Müll. (Hypotrichaceae); lateral view of the animal when using its great cirrhi, *x*, as ambulatory organs.
15. *Euplates harpa*, Stein (Hypotrichaceae); *h*, mouth; *x*, cirrhi.
16. *Heterotrichus cordiformis*, Stein (a Nectrotricheae), parasitic in the intestine of the Frog; *a*, meganucleus; *b*, contractile vacuole; *c*, food particle; *d*, anus; *e*, heterotrichous band of membranelles; *f*, *g*, mouth; *h*, pharynx; *i*, small cilia.

from the procedure adopted by the older microscopists to obtain animalcules. Infusions of most varied organic substances were prepared (hay and pepper being perhaps the favourite ones), the method of obtaining them including maceration and decoction, as well as infusion in the strict sense; they were then allowed to decompose in the air, so that various living beings developed therein. As classified by C. G. Ehrenberg in his monumental *Influsionstierchen als vollkommene Organismen*

prolongation of the ectosarc containing a bundle of myonemes, so that by the contractions of the bundle the stalk is pulled down to a corkscrew spiral, and on the relaxation of the muscle the elasticity of the hollow stalk straightens it out.

On fission the stalk may become branched, as the solid one of *Epistylis* and *Opercularia* (fig. iii, 20); and the myoneme also in the tubular stem of *Zoothamnium*; or the branch-myoneme for the one offspring may be inserted laterally on that for the other in *Carchesium* (fig. iii, 18). In several tubicolous Peritrichaceae there is some arrangement for closing their tubes. In *Thuricola* (fig. iii, 25-26) there is a valve which opens by the pressure of the animal on its protrusion, and closes automatically by elasticity on retraction. In *Lagenophrys* the animal adheres to the cup a little below the opening, so that its withdrawal closes the cup: at the adherent part the body mass is hardened, and so differentiated as to suggest the frame of the mouth of a purse. In *Pyxicola* (fig. iii, 21-22) the animal bears some way down the body a hardened shield ("operculum") which closes the mouth of the shell on retraction.

The cytoplasm of the Infusoria is very susceptible to injuries; and when cut or torn, unless the pellicle contracts rapidly to enclose the wounded surface, the substance of the body swells up, becoming frothy, with bubbles which rapidly enlarge and finally burst; the cell thus disintegrates, leaving only a few granules to mark where it was. This phenomenon, observed by Dujardin, is called "diffuence." The contractile vacuole appears to be one of the means by which diffuence is avoided in cells with no strong wall to resist the

cases the nucleus is so finely divided as to appear like a powder diffused uniformly through the medullary protoplasm (*Trachicleria*). Carmine staining, after treatment with absolute alcohol, has led to this remarkable discovery. The condition described by Foettinger in his *Opalinopsis* (fig. i, 1, 2) is an example of this pulverization of the nucleus. The condition of pulverization had led in some cases to a total failure to detect any nucleus in the living animal, and it was only by the use of reagents that the actual state of the case was revealed. Before fission, whatever the habitual character, the cell condenses, becomes oval, and divides by constriction; and though it usually is then fibrillated, only in a few cases does it approach the typical mitotic condition. The micronucleus described by older writers as the "nucleolus" or "paranucleus" ("endoplastule" of Huxley), may be single or multiple. When the meganucleus is bilobed there are always two micronuclei, and at least one is found next to every enlargement of the moniliform meganucleus. In the fission of the Infusoria, every micronucleus divides by a true mitotic process, during which, however, its wall remains intact. From their late sizes the meganucleus would appear to discharge during cell-life, exclusively, the functions of the nucleus in ordinary cells. Since in conjugation, however, the meganucleus degenerates and is in great part either digested or excreted as waste matter, while the new nuclear apparatus in both exconjugates arises, as we shall see, from a conjugation-nucleus of exclusively micronuclear origin, we infer that the micronucleus has for its function the carrying on of the nuclear functions of the race from one fission cycle to the next from which the meganucleus is excluded.

Fission is the ordinary mode of reproduction in the Infusoria, and is usually transverse, but oblique in *Sientora*, &c., as in Flagellata, long undinal in Peritrichaceae; in some cases it is always more or less unceasing owing to the differentiation of the body, and consequently it must be followed by a regeneration of the missing organs in either daughter-cell. In some cases it becomes very uneven, affording every transition to budding, which process assumes especial importance in the Suctorina. Multiple fission (brood-formation or sporulation) is exceptional in Infusoria, and when it occurs the broods rarely exceed four or eight—another difference from Flagellata. The nuclear processes during conjugation suggest the phylogenetic loss of a process of multiple fission into direct gametes. As noted, in fission the meganucleus divides by direct constriction; each micronucleus by the mode of mitosis. The process of fission is subject in its activity to the influences of nutrition and temperature, slackening as the food supply becomes inadequate or the temperature recedes from the optimum for the process. Moreover, if the descendants of a single animal be raised, it is found that the rapidity of fission, other conditions being the same, varies periodically, undergoing periods of depression, which may be followed by either (1) spontaneous recovery, (2) recovery under stimulating food, (3) recovery through conjugation, or (4) the death of the cycle, which would have ensued if 2 or 3 had been omitted at an earlier stage, but which ultimately seems inevitable, even the induction of conjugation failing to restore the normal physiological conditions were first studied by E. Maupas, librarian to the city of Algiers, in his pioneering work in the later 'eighties, and have been confirmed and extended by later observers, among whom we may especially cite G. N. Calkins.

Syngamy, usually termed conjugation or "karyogamy," is of exceptional character in the majority of this group—the Peritrichaceae alone evincing an approximation to the usual typical process of the permanent fusion of two cells (pairing-cells or gametes), cytoplasm to cytoplasm, nucleus to nucleus, to form a new cell (coupled cell, zygote).

This process was elucidated by E. Maupas in 1889, and his results, eagerly questioned and repeatedly tested, have been confirmed in every fact and in every generalization of importance.

Previously all that had been definitely made out was that under certain undetermined conditions a fit of pairing two and two occurred among the animals of the same species in a culture or in a locality in the open; that after a union prolonged over hours, and sometimes even days, the mates separated; that during the union the meganucleus underwent changes of a degenerative character; and that the micronucleus underwent repeated divisions, and that from the offspring thus produced the new nuclear apparatus was evolved for each mate. Maupas discovered the biological conditions leading to conjugation: (1) the presence of individuals belonging to distinct stocks; (2) their belonging to a generation sufficiently removed from previous conjugation, but not too far removed therefrom; (3) a deficiency of food. He also showed that during conjugation a "migratory" nucleus, the offspring of the divisions of the micronucleus, passes from either mate to the other, while its sister nucleus remains "stationary"; and that reciprocal fusion of the migratory nucleus of the one mate with the stationary nucleus of the other takes place to form a zygote nucleus in either mate; and that from this zygote nucleus the new nuclear apparatus is formed, at least two nuclei are formed, one of which enlarges to form meganucleus, while the other remains small as the first micronucleus of the new reorganized animal, which now separates as an "exconjugate" (fig. iv). Moreover, if pairing be prevented, or be not induced, the individuals produced by successive fissions become gradually weaker, their nuclear apparatus degenerates, and finally they cannot be induced

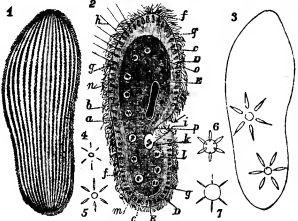

FIG. II.

1, Surface view of *Paramecium*, showing the disposition of the cilia in longitudinal rows.

2, a, mega-; b, micro-nucleus; c, junction of ecto- and endosarc; D, pellicle; E, endosarc; f, cilia (much too numerous and crowded); g, trichocysts; g', same with thread; h, discharged; i, pharynx; its undulating membrane not shown; k,

food granules collecting into a bolus; l, m, n, o, food vacuoles, their contents being digested as they pass in the endosarc along the path indicated by the arrows.

3, Outline showing contractile vacuoles in commencing diastole, surrounded by five afferent canals.

4-7 Successive stages of diastole of contractile vacuole.

absorption of water in excess; for after growing in size for some time, its walls contract suddenly, and its contents are expelled to the outside by a pore, which is, like the anus, usually invisible, but permanent in position. The contractile vacuole may be single or multiple; it may receive the contents of a canal, or of a system of canals, which only become visible at the moment of the contraction of the vacuole (fig. ii, 4-7), giving liquid time to accumulate in them, or when the vacuole is acting sluggishly or imperfectly, as in the approach of asphyxia (fig. ii, 3). Besides this function, since the system passes a large quantity of water from without through the substance of the cell, it must needs act as a means of respiration and excretion. In all Peritrichaceae it opens to the vestibule, and in some of them it discharges through an intervening reservoir, curiously recalling the arrangements in the Flagellate Euglenaceae.

The nuclear apparatus consists of two parts, the meganucleus, and the micronucleus or micronuclei (fig. iii, 17 d, iv, 1). The meganucleus alone regarded and described as "the nucleus" by older observers is always single, subjected to a few reservations. It is most frequently oval, and there is indicated by the micronucleus; but it may be lobed, the lobes lying far apart and connected by a slender bridge or moniliform, or horse-shoe-shaped (Peritrichaceae). It often contains darker inclusions, like nucleoli.

It has been shown, more especially by Gruber, that many Ciliata are multinucleate, and do not possess merely a single meganucleus and a micronucleus. In *Oxytricha* the nuclei are large and numerous (about forty), scattered through the protoplasm, whilst in other

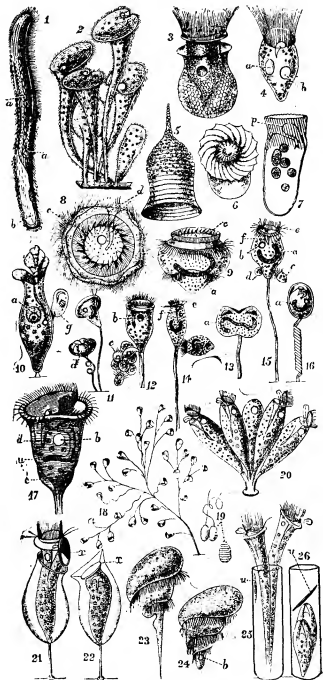

FIG. III.—Ciliata: 1, 2, Heterotrichaceae; 3-7, 23-24, Oligotrichaceae; 8-22, 25, 26, Peritrichaceae.

1. *Spirostomum ambiguum*, Ehr.; on its left side oral groove and wreath of membranelles; a, moniliform meganucleus; b, position of contractile vacuole.
2. Group of *Stentor polymorphus*, O. F. Müller; the twisted end of the peristome indicating the position of the mouth.
3. *Tintinnus lagenula*, Cl. and L., in free shell.
4. *Strombidium clapedonii*, S. Kent.
5. Shell of *Codonella campanella*, Haeck.
6. 7. *Torquaitella typica*, Lank. (= *Strombidium* according to Bütschli); p, oral tube seen through peristomial wreath of apparently coalescent membranelles.
8. Basal, and 9, side (inverted) views of *Trichodina pediculus*, Ehr.; a, meganucleus; c, basal collar and ring of hooks; d, mouth; contractile vacuole and oral tube seen by transparency in 8.
10. *Spirochona gammipara*, Stein; a, meganucleus; b, bud.
- 11, 12. *Forficella 'microstoma*, Ehr.; d, formation of a brood of 8 microgametes c by multiple fission; b, contr. vacuole.
13. Same sp. in binary fission; a, meganucleus.
14. *V. nebulifera*, Ehr.; bud swimming away by

under suitable conditions to pair normally, so that the cycle becomes extinct by senile decay. In Peritrichaceae the gametes are of unequal sizes (fig. iii. 11, 12), the smaller being formed by brood fissions (4 or 8); syngamy is here permanent, not temporary, the smaller (male) being absorbed into the body of the larger (female); and there are only two nuclei that pair. Thus we have a derived binary sexual process, comparable to that of ordinary bisexual organisms.

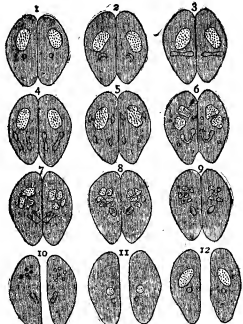

FIG. IV.—Diagrammatic Sketch of Changes during Conjugation in Ciliata. (From Hickson after Delage and Maupas.)

- 1, 2. Two individuals at commencement of conjugation showing meganucleus (dotted) and micronucleus; successive stages of the disintegration of the meganucleus shown in all figures up to 9.
- 2, 3. First mitotic division of micronuclei.
- 4, 5. Second ditto.
6. One of the four nuclei resulting from the second division again dividing to form the pairing-nuclei in either mate, while the other 3 nuclei degenerate.
7. Migration of the migratory nuclei.
- 8, 9. Fusion of the incoming migratory with the stationary nucleus in either mate.
10. Fission of Zygote nucleus into two, the new meganucleus and micronucleus whose differentiation is shown in 11, 12. The vertical dotted line indicates the separation of the mates.

CILIATA.—The Ciliate Infusoria represent the highest type of Protozoa. They are distinctly animal in function, and the Gymnostomaceae are active predaceous beings preying on other Infusoria or Flagellates. Some possess shells (fig. iii. 3, 5, 21, 22, 25, 26), most have a distinct swallowing apparatus, and in *Dysteria* there is a complex jaw—or tooth-apparatus, which needs new investigation. In the active Ciliata we find locomotive

- posterior wreath, peristome contracted; e, peristomial disk; f, oral tube.
15. *V. microstoma*; b, contr. vacuole; c, d, two microgametes seeking to conjugate.
16. *V. nebulifera*, contracted with body encysted.
17. Same sp. enlarged; c, myonemes converging posteriorly to muscle of stalk; d, micronucleus.
18. *Carchesium spectabile*, Ehr.
19. Nematocysts of *Epistylis flavicans*, Ehr. (after Greiff).
20. *Opercularia stenostoma*, St.; a small colony showing upstanding ("opercular") peristomial disk, protruded oral undulating membrane and cilia in oral tube.
- 21, 22. *Pyxicola affinis*, S.K., with stalk and theca; x, chitinous disk, or true "operculum" closing theca in retracted state.
- 23, 24. *Caenomorpha medusula*, Perty, with spiral peristomial wreath.
- 25, 26. *Thuricola valvata*, Str. Wright, in sessile theca, with internal valve (v) to close tube, as in gastropod *Clausilia*; owing to recent fission two animals occupy one tube.





animal after a few changes into a region where the solution is strong enough to kill it. This "motile reaction," first noted by H. S. Jennings, is the explanation of the general reactions of minute swimming animals to most stimuli of whatever character, including light; the practical working out is, as he terms it, a method of "trial and error." In the action of a current of electricity is distinctly and immediately directive, but such a stimulus is not to be found in nature. The motile reaction in the Hypotrichaceae which crawl or dart in a straight line is somewhat different, the swerve being a simple turn to the right hand—i.e. away from the mouth.

Parasitism in the Infusoria is by no means so important as among Flagellates. *Ichthyophthirius* alone causes epidemics among Fishes, and *Balanitidium coli* has been observed in intestinal disease in Man. The Isotrichae, among Aspirotrichaceae and the Ophryoscolicidae among Heterotrichaceae are found in abundance in the stomachs of Ruminants, and are believed to play a part in the digestion of cellulose, and thus to be rather commensals than parasites. A large number of attached species are epizoo commensals, some very indifferent in choice of their host, others particular not only in the species they infest, but also in the special organs to which they adhere. This is notably the case with the shelled Peritrichaceae. *Lichophora* and *Trichodina* (fig. iii, 8, 9) among Peritrichaceae are capable of locomotion by their permanent posterior wreath or of attaching themselves by the sucker which surrounds it; *Kerona polyzorum* glides habitually over the body of Hydra, as does *Trichodina pediculus*.

Several Suctorua are endoparasitic in Ciliata, and their occurrence led to the view that they represented stages in the life-history of these. Again, we find in the endosarc of certain Ciliates green nucleated cells, which have a cellulose envelope and multiply by fission inside or outside the animal. They are symbiotic Algae, or possibly the resting state of a Chlamydomonadine Flagellate (*Chloraria*), and have received the name *Zoochlorella*. They are of constant occurrence in *Paramecium bursaria*, frequent in *Stentor polymorphus* and *S. igneus*, and *Ophrydium versatile*, and a few other species, which become infected by swallowing them.

#### Classification.

Order 1.—Section A.—Gymnostomaceae. Mouth habitually closed; swallowing an active process; cilia (or membranellae) uniform, usually distributed evenly over the body; form variable, sometimes of circular transverse section.

Order 2.—Section B.—Trichostomata. Mouth permanently open against the endosarc, provided with 1 or 2 undulating membranes often prolonged into an intumed pharynx; ingestion by action of oral ciliary apparatus.

Order 2.—Subsection (a).—Aspirotrichaceae. Cilia nearly uniform, not associated with cirri or membranellae, nor forming a peristomal wreath. Form usually flattened, mouth unilateral. (N.B.—Orders 1, 2 are sometimes united into the single order Holotrichaceae.)

Subsection (b).—Spirotricha. Wreath of distinct membranellae—or of cilia fused at the base—enclosing a peristomal area and leading into the mouth.

§§ 1.—Wreath of separate membranellae.

Order 3.—Heterotrichaceae; body covered with fine uniform cilia, usually circular in transverse section.

Order 4.—Oligotrichaceae; body covering partial or wholly absent; transverse section usually circular.

Order 5.—Hypotrichaceae; body flattened; body circular represented clearly by stiff cirri in ventral rows, and fine motionless dorsal sensory hairs.

Order 6.—§§ 1.—Peritrichaceae. Peristomal ciliary wreath, spiral, of cilia united at the base; posterior wreath circular of long membranellae; body circular in section, cylindrical, taper, or bell-shaped.

#### Illustrative Genera (selected).

1. Gymnostomaceae. (a) Ciliation general or not confined to one surface. *Coleps* Ehr., with pellicle locally hardened into mailed plates; *Trachelocera* Ehr.; *Provoid* Ehr. (fig. i, 6, 7); *Trachelius* Ehr., with branching endosarc (fig. i, 8); *Lacrymaria* Ehr. (fig. i, 5), body produced into a long neck with terminal mouth surrounded by offensive trichocysts; *Dileptus* Duj., of similar form, but anterior process, blind, proreals; *Ichthyophthirius* Fouquet (fig. i, 9-12), (fig. i, 13), by two girdles of membranellae; *Didinium* St. (fig. i, 15), cilia on dorsal surface with numerous tentacles each with a strong terminal trichocyst; *Actinobolus* Stein, with one oral adoral tentacle; *Ilemona* Stokes. (b) Cilia confined to dorsal surface. *Chilodon* Ehr.; *Loxodes* Ehr., body flattened, ciliated on one side only, endosarc as in *Trachelius*; *Dysteria* Huxley, with the dorsal surface hardened and hinged along the median line into a bivalve shell, ciliated only on ventral surface, with a protrusible foot-like process, and a complex pharyngeal armature. (c) Cilia restricted to a single equatorial girdle, strong (probably membranellae). *Mesostoma*, mouth 4-10. 2. Aspirotrichostomata. *Paramecium* Hill (fig. ii, 1-3); *Ophryoglena* Ehr.; *Colpoda* O. F. Müller; *Colpidium* St.; *Lembus* Cohn, with posterior sulcus for springing; *Leucophrya* St.; *Urocentrum* Nitsch, bare, with polar and equatorial zones and a posterior tuft of

long cilia; *Opalinopsis* Foeltling (fig. i, 1, 2); *Anoplophrya* St. (fig. i, 3, 4). (The last two parasitic mouthless genera are placed here doubtfully.)

3. Heterotrichaceae. (a) Wreath spiral; *Stentor* Oken. (fig. iii, 2), oval when free, trumpet-shaped when attached by pseudopods at the apex, and the feet secreting a gelatinous tube; *Blepharisma* Perty, sometimes parasitic in Heliozoa; *Spirostomum* Ehr., cylindrical, up to 1" in length; (b) Wreath straight, often oblique; *Nyctotherus* Lédy, parasitic *ans* always viviparous; *Balanitidium* Cl. and L., parasitic (*B. coli* in man); *Bursaria*, O.F.M., hollowed into an oval pouch, with the wreath inside.

4. Oligotrichaceae. *Tintinnus* Schranck (fig. iii, 3); *Trichodinopsis* Cl. and L.; *Codonella* Haack. (fig. iii, 5); *Strombidium* Cl. and L. (fig. iii, 4), including *Torquellula* Lank. (fig. iii, 6, 7), according to Hitzschli; *Halteria* Du. with an equatorial circle of stiff bristle-like cilia; *Caenomorpha* Perty (fig. iii, 23, 24); *Ophryostellis* St., with straight digestive cavity, and visible anus, parasitic in Ruminants.

5. Hypotrichaceae. *Stylonychia* Ehr.; *Oxytricha* Ehr.; *Euploetes* Ehr. (fig. i, 14, 15); *Kerona* Ehr. (epizoo on Hydra).

6. Peritrichaceae. 1. Peristomal wreath projecting when expanded above a circular contractile collar-like rim.

(a) Fam. Urcularidae: posterior wreath permanently present around sucker-like base. *Trichodina* Ehr. (fig. iii, 8, 9), epizoo on Hydra; *Urcularia* Cl. and L.; *Cydochoetes* Hatchett; *Jackson*; *Gerda* Cl. and L.; *Scyphidia* Duj.

(b) Fam. Vorticellidae = Bell Animalcules: posterior wreath temporarily present, shed after fixation.

Subfam. 1. Vorticellinae animals naked. (i) Solitary; *Vorticella* Linn. (fig. iii, 11-17), stalk hollow with spiral muscle; *Psycidium* S. Kent, stalk non-contractile. (ii) Forming colonies by budding on a branched stalk; *Carchesium* Ehr., hollow branches and muscles discontinuous; *Zoothamnium* Ehr., branched hollow stem and muscle continuous through colony. *Epiplatys* Ehr., stalk rigid (the animal body in these three genera has the same characters as *Vorticella*)—*Campnella* Goldf., stalked like *Epiplatys*, wreath of many turns (nematocysts sometimes present) (fig. iii, 10); *Opercularia*, stalk of *Epiplatys*, disk supporting wreath obconical, very high (fig. iii, 20).

Subfam. 2. Vaginicolinae; body enclosed in a firm theca; *Vaginicola* Lam., shell simple, sessile; *Thuricola* St. Wright, shell sessile, with a valve opening inwards (fig. iii, 25-26); *Cothurnia* Ehr., shell studded, similar to *Psycidium* S. Kent, shell stalked, closed by an infraperistomal opercular thickening on the body (fig. iii, 21-22).

Subfam. 3. Shells gelatinous; those of the colony aggregate into a floating spheroidal mass several inches in diameter *Ophrydium* Bory, *O. versatile* contains *Zoochlorella*, which secretes oxygen, and the gas-bubbles float the colonies like green lumps of jelly.

2. Peristomal wreath, not protrusible, surrounded by a very high usually spiral collar.

Fam. Spirochona St. *Spirochona* St. (fig. iii, 10); *Kentrochona* Rempel; both genera epizoo on gills, &c., of small Crustacea.

SUCTORUA.—These are distinguished from Ciliata by their possession of hollow tentacles (one only in *Rhyncheta*, fig. viii, 1, and *Urnulla*) through which they ingest food, and by not possessing cilia, except in the young stage. Fission approximately equal is very rare. Usually it is unequal, or if nearly equal one of the halves remains attached, and the other, as an embryo or gemmule, develops cilia and swims off to attach itself elsewhere; *Sphaerophrya* (fig. viii, 2-6) alone, often occurring as an endoparasite in Ciliata, may be free, tentaculate and unattached.

The ectosarc is usually provided with a firm pellicle which shows a peculiar radiate milling in optical section, so fine that its true nature is difficult to make out; it may be due to radial rods, regularly imbedded, or may be the expression of radial vacuoles. The tentacles vary in many respects, but are always retractile. They are tubes covered by an extension of the pellicle; this is invaginated into the body round the base of the tentacle as a sheath, and then evaginated to form the outer layer of the tentacle itself, over which it is frequently raised into a spiral ridge, which may be traced down into the part sunk and enclosed within the body; in *Chaomphrya*, where the tentacles are largest, the pellicle is further continued into the inner part of the tentacle. The tentacles are pierced by a central canal opening at the apex, which may be (1) enlarged into a terminal capitate sucker, (2) slightly flared, (3) truncate and closed in the resting state to become widely opened into a funnel, or (4) pointed. The tentacles are always capable of being waved from side to side, or turned in a definite direction for the reception or prehension of food; in *Rhyncheta*, the movements of the long single tentacle recall those of an elephant's trunk, only they are more extensive and more varied. In the majority of cases the food consists of Ciliata; and the contents of the prey may be seen passing down the length of the sucker, beyond where it becomes free from the dorsal surface. In *Chaomphrya* the food appears to consist of the debris of the prey of the carnivorous host (*Cyclops*), which is sucked into the wide funnel-shaped mouths of the tentacles—by what mechanism is

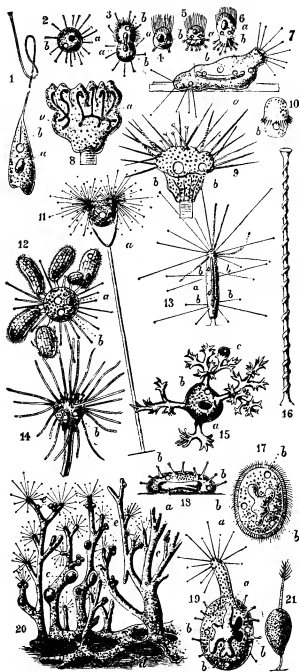

FIG. VIII.—Suctorioria (in all *a*, meganucleus; *b*, contractile vacuole).

- Rhyncheta cyclopum*, Zenker; only a single tentacle and that suctorial; epizoic on Cyclops.
- Sphaerophrya urostylae*, Maupas; normal adult; parasitic in Ciliate *Urostyla*.
- The same dividing by transverse fission, the anterior moiety with temporarily developed cilia.
- 5, 6. *Sphaerophrya stentorea*, Maupas. Parasitic in *Stentor*, and at one time mistaken for its young.
- Trichophrya epistylidis*, Cl. and L.
- Hemiphrya gemmipara*, Hertwig. Example with six buds, into each of which a branch of the meganucleus *a* is extended.
- The same species, showing the two kinds of tentacles (the suctorial and the pointed), and two contractile vacuoles *b*.
- Ciliated embryo of *Podophrya steinii*, Cl. and L.
- Acineta grandis*, Saville Kent; showing pedunculated cup, and animal with two bunches of entirely suctorial tentacles.
- Sphaerophrya magna*, Maupas. It has seized with its tentacles, and is in the act of sucking out the juices of six examples of the Ciliate *Colpoda parvifrons*.
- Podophrya elongata*, Cl. and L.

unknown. The endosarc is full of food-granules and reserve-granules (oil, colouring matter and proteid).

The meganucleus and the micronucleus are both usually single, but in *Dendrosoma* (fig. viii. 20), of which the body is branched, and the meganucleus with it, there are numerous micronuclei. In most cases the micronucleus has not been recorded, though from the similarity of conjugation, and its presence in most cases of fission and budding that have been accurately described, we may infer that it is always present. In unequal fission the meganucleus sends a process into the bud, while the micronucleus divides as in Ciliata. The bud may be nearly equal to the remains of the original animal, or much smaller, and in that case a depression surrounds it which may deepen so as to form a brood-cavity, either communicating by a mere "birth-pore" with the outside or entirely closed. In some cases the budding is multiple (fig. viii. 8), and a large number of buds are formed and liberated at the same time. In all cases the bud escapes without tentacles, and possesses a characteristic supply of cilia, whose arrangement is constant for the species.

In some cases an adult may withdraw its tentacles, moult its pellicle and develop an equipment of cilia and swim away; this is the case with *Dendrocometes*, parasitic on *Gammarus*, when its host moults.

The numerous species of Suctorioria, often so abundant on various species of Cyclops, are not found on the other fresh-water Copepoda, *Diaptomus* and *Canthocamptus*, belonging indeed to other families. Again, these Suctorioria affect different positions, those found on the antennae not being present on the mouth parts; the ventral part of the thorax has another set; and the inside of the pleural fold another. *Rhyncheta* occupies the front of the "couplers" or median downgrowths uniting the coxopodites of the swimming legs, and *Choanophrya* settles in the immediate neighbourhood of the mouth, preferably on the epistoma, labrum and metastomatium region, but also on the adoral appendages and in rare cases extends, when the settlement is extensive, to the bases of the two pairs of antennae; while distinct species of *Podophrya* settle on the antennae, the front of the thorax and the inside of the pleural folds. *Dendrocometes* is common on the gills of the fresh-water shrimp (Amphipod) *Gammarus* and *Silyocometes* on the gills and gill-covers of the Isopod *Asellus*, the water-slayer. The independence of the Suctorioria was threatened by the erroneous view of Stein that they were phases in the life-history of Vorticellidae. Small parasitic forms (*Sphaerophrya*) were also regarded erroneously as the "acinetiform young" of Ciliata. They now must be regarded as an extreme modification of the Protozoan series, in which the differentiation of organs in a unicellular animal reaches its highest point.

#### Principal Genera.

- Unstalked simple forms. *Urnulla* Cl. and L., permanently ciliate; *Rhyncheta* Zenker (fig. viii. 1), on the limb couplers of Cyclops; *Sphaerophrya* Cl. and L. (fig. viii. 2-6, 12), endoparasitic in Ciliata and formerly taken for embryos thereof, never attached; *Trichophrya* Cl. and L. (fig. viii. 7), of similar habits, but temporarily attached sessile.
  - Stalked simple forms; *Podophrya* Ehr. (fig. viii. 10, 13, 16), tentacles all knobbed or flared; *Ephelota* Strehli Wright, tentacles all pointed; *Hemiphrya* S. Kent (fig. viii. 8, 9, 14), tentacles of both kinds; *Choanophrya* Hartog, tentacles thick, truncate, very retractile, when expanded opening into funnels for aspiration of floating prey, never for attachment—epizoic on antero-ventral parts of Cyclops.
  - Cupped forms; *Solenophrya* Cl. and L., cup sessile; *Acineta* Ehr., cup stalked; *Acinetopsis* Bitschli, like *Acineta*, but the cup flattened, closed distally with only slit-like apertures ("pylomes") for the bundles of tentacles; *Podocycathus*, like *Acineta*, but with pointed as well as knobbed tentacles.
  - Tentacles in bundles at the tips of one or more processes or branches of the body. *Ophryodendron* Cl. and L., tentaculiferous process single (fig. viii. 21); *Dendrocometes* Stein (fig. viii. 15), body rounded, processes repeatedly branched, epizoic on gills of *Gammarus pulex*; *Dendrosoma* Ehr. (fig. viii. 17-20), body freely branched from a basal attached stolon, meganucleus branching with the body.
- BIBLIOGRAPHY.—(a) Infusoria in the widest sense; C. E. Ehrenberg, *Die Infusorienfauna als volkonomie. Organismus*, (1838); F. Dujardin, *Zoophytes infusoires* (1841). (b) Infusoria, including Mastigophora: M. Perty, *Zur Kenntniss Kleinsten Lebensformen* (1852); E. Claparède and J. Lachmann, *Études sur les infusoires*
- Hemiphrya benedenii*, Fraip.; the suctorial tentacles retracted.
  - Dendrocometes paradoxus*, Stein. Parasitic on *Gammarus pulex*; captured prey.
  - A single tentacle of *Podophrya*, R. Hertwig.
  - 17-20, *Dendrosoma radicans*, Ehr.—17, free-swimming ciliated embryo. 18, Earliest fixed condition of the embryo. 19, Later stage, a single tentaculiferous process now developed. 20, Adult colony; *c*, enclosed ciliated embryos; *d*, branching stolon; *e*, more minute reproductive (?) bodies.
  - Ophryodendron pedicellatum*, Hincks.

des *Rhizopodes* (1858-1861); F. von Stein, *Der Organismus der Infusionstiere* (1859-1883); W. Saville Kent, *A Manual of the Infusoria*, including a description of all known Flagellate, Ciliate and Tentaculiferous Protozoa (1880-1882). (c) Infusoria, as limited by Bütschli. O. Bütschli, *Bronn's Tierreich*, vol. i. *Protozoa*, pt. 3 *Infusoria* (1887-1889), the most complete work existing, but without specific diagnoses; S. J. Hickson, "The Infusoria" in Lankester's *Treatise on Zoology*, vol. 1, fasc. 2 (1903), a general account, well illustrated, with a diagnosis of all genera. See also DeLange and Hérouard, *Traité de Zoologie concrète*, vol. i. "La Cellule et les Protozoaires" (1896), with an illustrated conspectus of the genera; E. Maupas, "Recherches expérimentales sur la multiplication des Infusores ciliés," *Arch. zool. exp. vi.* (1888); and "Le Rajouissement karyogonique chez les Ciliés," *ib. viii.* (1889); R. Sand, *Etude monographique sur le groupe des Infusores tentaculifères* (Suctorina), (1899), with diagnoses of species; A. Lang, *Lehrb. der vergleich. Anatomie der wirbellosen Tiere*, vol. i. "Protozoa" (1901) (a view of comparative anatomy, physiology and bionomics); Marcus Hartog, "Protozoa," in *Cambridge Natural History*, i. (1906); H. S. Jennings, *Contributions to the Study of the Behaviour of Lower Organisms* (1904); G. N. Calkins, "Studies on the Life History of Protozoa" (Life cycle of Paramoecium), *i. Arch. Entw. Jv. Zool.*, *ii. Arch. Prot.* i. (1902), *III. Biol. Bull.* iii. (1902), *IV. J. Exp. Zool.* i. (1904). Numerous papers dealing especially with advances in structural knowledge have appeared in the *Archiv für Protistenkunde*, founded by F. Schaudinn in 1902. (M. HA.)

**INGEBORG** [INGEBURGE, INGELBURGE, INGELBORG, ISEM-BURGE, DAN. INGBJØRG] (c. 1176-1237 or 1238), queen of France, was the daughter of Valdemar I., king of Denmark. She married in 1193 Philip II. Augustus, king of France, but on the day after his marriage the king took a sudden aversion to her, and wished to obtain a separation. During almost twenty years he strained every effort to obtain from the church the declaration of nullity of his marriage. The council of Compiègne acceded to his wish on the 5th of November 1193, but the popes Celestine III. and Innocent III. successively took up the defence of the unfortunate queen. Philip, having married Agnes of Meran in June 1196, was excommunicated, and as he remained obdurate, the kingdom was placed under an interdict. Agnes was finally sent away, but Ingeborg, shut up in the château of Étampes, had to undergo all sorts of privations and vexations. The king attempted to induce her to solicit a divorce herself, or to enter a convent. At last, however (1213), hoping perhaps to justify by his wife's claims his pretensions to England, Philip was reconciled with Ingeborg, whose life from henceforth was devoted to religion. She survived him more than fourteen years, passing the greater part of the time in the priory of St Jean at Corbeil, which she had founded.

See Robert Davidson, *Philip II. August von Frankreich und Ingeborg* (Stuttgart, 1888); and E. Michael, "Zur Geschichte der Königin Ingeborg" in the *Zeitschrift für Katholische Theologie* (1890).

**INGELHEIM** (Ober-Ingelheim and Nieder-Ingelheim), the name of two contiguous market-towns of Germany, in the grand-duchy of Hesse-Darmstadt, on the Selz, near its confluence with the Rhine, 9 m. W. N. W. of Mainz on the railway to Coblenz. Ober-Ingelheim, formerly an imperial town, is still surrounded by walls. It has an Evangelical church with painted windows representing scenes in the life of Charlemagne, a Roman Catholic church and a synagogue. Its chief industry is the manufacture of red wine. Pop. (1900) 3402. Nieder-Ingelheim has an Evangelical and a Roman Catholic church, and, in addition to wine, manufactories of paper, chemicals, cement and malt. Pop. 3435.

Nieder-Ingelheim is, according to one tradition, the birthplace of Charlemagne, and it possesses the ruins of an old palace built by that emperor between 768 and 774. The building contained one hundred marble pillars, and was also adorned with sculptures and mosaics sent from Ravenna by Pope Adrian I. It was extended by Frederick Barbarossa, and was burned down in 1270, being restored by the emperor Charles IV. in 1354. Having passed into the possession of the elector palatine of the Rhine, the building suffered much damage during a war in 1462, the Thirty Years' War, and the French invasion in 1689. Only few remains of it are now standing; but of the pillars, several are in Paris, one is in the museum at Wiesbaden and another on the Schillerplatz in Mainz. Inside its boundaries there is

the restored Remigius Kirche, apparently dating from the time of Frederick I.

See Hiltz, *Der Reichspalast zu Ingelheim* (Ober-Ingelheim, 1868); and Clemen, "Der Karolingische Kaiserpalast zu Ingelheim," in *Westdeutsche Zeitschrift*, Band ix. (Trier, 1890).

**INGELOW, JEAN** (1820-1897), English poet and novelist, was born at Boston, in Lincolnshire, on the 17th of March 1820. She was the daughter of William Ingelow, a banker of that town. As a girl she contributed verses and tales to the magazines under the pseudonym of "Orris," but her first (anonymous) volume, *A Rhyming Chronicle of Incidents and Feelings*, did not appear until her thirtieth year. This Tennyson said had "very charming things" in it, and he declared he should "like to know" the author, who was later admitted to his friendship. Miss Ingelow followed this book of verse in 1851 with a story, *Allerton and Dreux*, but it was the publication of her *Poems* in 1863 which suddenly raised her to the rank of a popular writer. They ran rapidly through numerous editions, were set to music, and sung in every drawing-room, and in America obtained an even greater hold upon public estimation. In 1867 she published *The Story of Doom and other Poems*, and then gave up verse for a while and became industrious as a novelist. *Off the Skelligs* appeared in 1872, *Fated to be Free* in 1873, *Sarah de Berenger* in 1880, and *John Jerome* in 1886. She also wrote *Studies for Stories* (1864), *Stories told to a Child* (1865), *Mopsa the Fairy* (1869), and other excellent stories for children. Her third series of *Poems* was published in 1885. She resided for the last years of her life in Kensington, and somewhat outlived her popularity as a poet. She died on the 20th of July 1897. Her poems, which were collected in one volume in 1808, have often the genuine ballad note, and as a writer of songs she was exceedingly successful. "Sailing beyond Seas" and "When Sparrows build" in *Sapper at the Mill* were deservedly among the most popular songs of the day; but they share, with the rest of her work, the faults of affectation and stilted phraseology. Her best-known poem was the "High Tide on the Coast of Lincolnshire," which reached the highest level of excellence. The blemishes of her style were cleverly indicated in a well-known parody of Calverley's; a false archaism and a deliberate assumption of unfamiliar and unnecessary synonyms for simple objects were among the most vicious of her mannerisms. She wrote, however, in verse with a sweetness which her sentiment and her heart inspired, and in prose she displayed feeling for character and the gift of narrative; while a delicate underlying tenderness is never wanting in either medium to her sometimes tortured expression. Miss Ingelow was a woman of frank and hospitable manners, with a look of the Lady Bountiful of a country parish. She had nothing of the professional authoress or the "literary lady" about her, and, as with characteristic simplicity she was accustomed to say, was no great reader. Her temperament was rather that of the improvisatore than of the professional author or artist.

**INGEMANN, BERNHARD SEVERIN** (1789-1862), Danish poet and novelist, was born at Torkildstrup, in the island of Falster, on the 28th of May 1789. He was educated at the grammar school at Slagelse, and entered the university of Copenhagen in 1806. His studies were interrupted by the English invasion, and on the first night of the bombardment of the city Ingemann stood with the young poet Blicher on the walls, while the shells whistled past them, and comrades were killed on either side. All his early and unpublished writings were destroyed when the English burned the town. In 1817 he published his first volume of poems, and in 1812 his second, followed in 1813 by a book of lyrics entitled *Procné* and in 1814 the verse romance, *The Black Knights*. In 1815 he published two tragedies, *Masaniello* and *Blanca*, followed by *The Voice in the Desert*, *The Shepherd of Tolosa*, and other romantic plays. After a variety of publications, all very successful, he travelled in 1818 to Italy. At Rome he wrote *The Liberation of Tasso*, and returned in 1819 to Copenhagen. In 1820 he began to display his real power in a volume of delightful tales. In 1821 his dramatic career closed with the production of an unsuccessful

comedy, *Magnetism in a Barber's Shop*. In 1822 the poet was nominated lector in Danish language and literature at Sorø College, and he now married. *Valdemar the Great and his Men*, an historical epic, appeared in 1824. The next few years were occupied with his best and most durable work, his four great national and historical novels of *Valdemar Seier*, 1826; *Erik Menes's Childhood*, 1828; *King Erik*, 1833; and *Prince Otto of Denmark*, 1835. He then returned to epic poetry in *Queen Margaret*, 1836, and in a cycle of romances, *Holger Danske*, 1837. His later writings consist of religious and sentimental lyrics, epic poems, novels, short stories in prose, and fairy tales. His last publication was *The Apple of Gold*, 1856. In 1846 Ingemann was nominated director of Sorø College, a post from which he retired in 1849. He died on the 24th of February 1862. Ingemann enjoyed during his lifetime a popularity unapproached even by that of Öhlenschläger. His boundless facility and fecundity, his sentimentality, his religious melancholy, his direct appeal to the domestic affections, gave him instant access to the ear of the public. His novels are better than his poems; of the former the best are those which are directly modelled on the manner of Sir Walter Scott. As a dramatist he outlived his reputation, and his unwieldy epics are now little read.

Ingemann's works were collected in 41 vols. at Copenhagen (1843-1865). His autobiography was edited by Galskjör in 1862; his correspondence by V. Heise (1879-1881); and his letters to Grundtvig by S. Grundtvig (1882). See also H. Schwanenflügel, *Ingemanns Liv og Digtning* (1886); and Georg Brandes, *Essays* (1889).

**INGERSOLL, ROBERT GREEN** (1833-1899), American lawyer and lecturer, was born in Dresden, New York, on the 11th of August 1833. His father was a Congregational minister, who removed to Wisconsin in 1843 and to Illinois in 1845. Robert, who had received a good common-school education, was admitted to the bar in 1854, and practised law with success in Illinois. Late in 1861, during the Civil War, he organized a cavalry regiment, of which he was colonel, until captured at Lexington, Tennessee, on the 18th of December 1862, by the Confederate cavalry under General N. B. Forrest. He was paroled, waited in vain to be exchanged, and in June 1863 resigned from the service. He was attorney-general of Illinois in 1867-1869, and in 1876 his speech in the Republican National Convention, naming James G. Blaine for the Presidential candidate, won him a national reputation as a public speaker. As a lawyer he distinguished himself particularly as counsel for the defendants in the "Star-Route Fraud" trials. He was most widely known, however, for his public lectures attacking the Bible, and his anti-Christian views were an obstacle to his political advancement. Ingersoll was an eloquent rhetorician rather than a logical reasoner. He died at Dobbs Ferry, N.Y., on the 21st of July 1899.

His principal lectures and speeches were published under the titles: *The Gods and Other Lectures* (1876); *Some Mistakes of Moses* (1879); *Prose Poems* (1884); *Great Speeches* (1887). His lectures, entitled "The Bible," "Ghosts," and "Foundations of Faith," attracted particular attention. His complete works were published in 12 vols. in New York in 1900.

**INGERSOLL**, a town and port of entry of Oxford county, Ontario, Canada, 19 m. E. of London, on the river Thames and the Grand Trunk and Canadian Pacific railways. Pop. (1901) 4572. The principal manufactures are agricultural implements, furniture, pianos and screws. There is a large export trade in cheese and farm produce.

**INGHAM, CHARLES CROMWELL** (1796-1863), American artist, was born in Dublin, Ireland. He was a pupil of the Dublin Academy, emigrated to the United States at the age of twenty-one, and immediately became identified with the art life of that country, being one of the founders of the National Academy of New York in 1826 and its vice-president from 1845 to 1850. He painted portraits of the reigning beauties of New York and acquired considerable reputation, continuing to practise his profession until his death, in New York, on the 10th of December 1863.

**INGHIRAMI**, the name of an Italian noble family of Volterra. The following are its most important members:

**TOMMASO INGHIRAMI** (1470-1516), a humanist, is best known for his Latin orations, seven of which were published in 1777. His success in the part of Phædra in a presentation of Seneca's *Hippolytus* (or *Phædra*) led to his being generally known as *Fædra*. He received high honours from Alexander VI., Leo X. and Maximilian I.

**FRANCESCO INGHIRAMI** (1772-1846), a distinguished archaeologist, fought in the French wars (1799), and afterwards devoted himself especially to the study of Etruscan antiquities. He founded a college at Fiesole and collected, though without critical insight, a mass of valuable material in his *Monumenti etruschi* (10 vols., 1820-1827), *Galleria etrusca* (3 vols., 1820), *Pitture di vasi fittili* (1831-1837), *Museo etrusco chiusino* (2 vols., 1833), and the incomplete *Storia della Toscana* (1841-1845): these works were elaborately illustrated.

His brother, **GIOVANNI INGHIRAMI** (1779-1851), was an astronomer of repute. He was professor of astronomy at the Institute founded by Ximenes in Florence and published beside a number of text-books *Efemeridi dell' occultazione delle piccole stelle sotto la luna* (1809-1830); *Efemeridi di Venese e Giove all' uso de' naviganti* (1821-1824); *Tavole astronomiche universali portatili* (1811); *Base trigonometrica misurata in Toscana* (1818); *Carta topografica e geometrica della Toscana* (1830).

**INGLEBY, CLEMENT MANSFIELD** (1823-1886), English Shakespearian scholar, was born at Edgbaston, Birmingham, on the 29th of October 1823, the son of a solicitor. After taking his degree at Trinity College, Cambridge, he entered his father's office, eventually becoming a partner. In 1850 he abandoned the law and left Birmingham to live near London. He contributed articles on literary, scientific and other subjects to various magazines, but from 1874 devoted himself almost entirely to Shakespearian literature. His first work in this field had been an exposure of the manipulations of John Payne Collier, entitled *The Shakespeare Fabrications* (1859); his work as a commentator began with *The Still Lion* (1874), enlarged in the following year into *Shakespeare Hermeneutics*. In this book many of the then existing difficulties of Shakespeare's text were explained. In the same year (1875) he published the *Centurie of Prose*, a collection of references to Shakespeare and his works between 1592 and 1692. His *Shakespeare: the Man and the Book* was published in 1877-1881; he also wrote *Shakespeare's Bones* (1882), in which he suggested the disinterment of Shakespeare's bones and an examination of his skull. This suggestion, though not due to vulgar curiosity, was regarded, however, by public opinion as sacrilegious. He died on the 26th of September 1886, at Ilford, Essex. Although Ingleby's reputation now rests solely on his works on Shakespeare, he wrote on many other subjects. He was the author of hand-books on metaphysics and logic, and made some contributions to the study of natural science. He was at one time vice-president of the New Shakspeare Society, and one of the original trustees of the "Birthplace."

**INGLEFIELD, SIR EDWARD AUGUSTUS** (1820-1894), British admiral and explorer, was born at Cheltenham, on the 27th of March 1820, and educated at the Royal Naval College, Portsmouth. His father was Rear-Admiral Samuel Hood Inglefield (1783-1848), and his grandfather Captain John Nicholson Inglefield (1748-1828), who served with Lord Hood against the French. The boy went to sea when fourteen, took part in the naval operations on the Syrian Coast in 1840, and in 1845 was promoted to the rank of commander for gallant conduct at Obligado. In 1852 he commanded Lady Franklin's yacht "Isabel" on her cruise to Smith Sound, and his narrative of the expedition was published under the title of *A Summer Search for Sir John Franklin* (1853). He received the gold medal of the Royal Geographical Society on his return, and was given command of the "Phoenix" in which he made three trips to the Arctic, bringing home part of the Belcher Arctic expedition in 1854. In that year he was again sent out on the last attempt made by the Admiralty to find Sir John Franklin.

In the Crimean War Captain Inglefield took part in the siege

of Sevastopol. He was knighted in 1877, and nominated a Knight Commander of the Bath ten years later. He was promoted admiral in 1879. Besides being an excellent marine artist, he was the inventor of the hydraulic steering gear and the Ingfield anchor. He died on the 5th of September 1894. His son, Captain Edward Fitzmaurice Ingfield (b. 1861), became secretary of Lloyds in 1906. Sir Edward Ingfield's brother, Rear-Admiral V. O. Ingfield, was the father of Rear-Admiral Frederick Samuel Ingfield (b. 1854), director of naval intelligence in 1902-1904, and of two other sons distinguished as soldiers.

**INGLE-NOOK** (from Lat. *igniculus*, dim. of *ignis*, fire), a corner or seat by the fireside, within the chimney-breast. The open Tudor or Jacobean fire-place was often wide enough to admit of a wooden settle being placed at each end of the embrasure of which it occupied the centre, and yet far enough away not to be inconveniently hot. This was one of the means by which the builder sought to avoid the draughts which must have been extremely frequent in old houses. English literature is full of references, appreciative or regretful, to the cosy ingle-nook that was killed by the adoption of small grates. Modern English and American architects are, however, fond of devising them in houses designed on ancient models, and owners of old buildings frequently remove the modern grates and restore the original arrangement.

**INGLIS, SIR JOHN EARDLEY WILMOT** (1814-1862), British major-general, was born in Nova Scotia on the 15th of November 1814. His father was the third, and his grandfather the first, bishop of that colony. In 1833 he joined the 32nd Foot, in which all his regimental service was passed. In 1837 he saw active service in Canada, and in 1848-1849 in the Punjab, being in command at the storming of Mooltan and at the battle of Gujrat. In 1857, on the outbreak of the Indian Mutiny, he was in command of his regiment at Lucknow. Sir Henry Lawrence being mortally wounded during the siege of the residency, Inglis took command of the garrison, and maintained a successful defence for 87 days against an overwhelming force. He was promoted to major-general and made K.C.B. After further active service in India, he was, in 1860, given command of the British troops in the Ionian Islands. He died at Hamburg on the 27th of September 1862.

**INGLIS, SIR WILLIAM** (1764-1835), British soldier, was born in 1764, a member of an old Roxburghshire family. He entered the army in 1781. After ten years in America he served in Flanders, and in 1796 took part in the capture of St Lucia. In 1800 he commanded a brigade in the Peninsula, taking part in the battle of Busaco (1810) and the first siege of Badajoz. At Albuera his regiment, the 57th, occupied a most important position, and was exposed to a deadly fire. "Die hard! Fifty-Seventh," cried Inglis, "Die hard!" The regiment's answer has gone down to history. Out of a total strength of 579, 23 officers and 415 rank and file were killed and wounded. Inglis himself was wounded. On recovering, he saw further Peninsular service. In two engagements his horse was shot under him. His services were rewarded by the thanks of parliament and in 1825 he became lieutenant-general, and was made a K.C.B. After holding the governorships of Kinsale and Cork, he was, in 1830, appointed colonel of the 57th. He died at Ramsgate on the 20th of November 1835.

**INGOLSTADT**, a fortified town of Germany, in the kingdom of Bavaria, on the left bank of the Danube at its confluence with the Schutter, 52 m. north of Munich, at the junction of the main lines of railway, Munich, Bamberg and Regensburg-Augsburg. Pop. (1900) 22,207. The principal buildings are the old palace of the dukes of Bavaria-Ingolstadt, now used as an arsenal; the new palace on the Danube; the remains of the earliest Jesuits' college in Germany, founded in 1555; the former university buildings, now a school; the theatre; the large Gothic Frauenkirche, founded in 1425, with two massive towers, containing several interesting monuments, among them the tomb of Dr Eck, Luther's opponent; the Franciscan convent and nunnery; and several other churches and hospitals. Ingol-

stadt possesses several technical and other schools. In 1472 a university was founded in the town by the Bavarian duke, Louis the Rich, which at the end of the 16th century was attended by 4000 students. In 1800 it was removed to Landshut, whence it was transferred to Munich in 1826. Its newer public buildings include an Evangelical church, a civil hospital, an arsenal and an orphanage. The industries are cannon-founding, manufacture of gunpowder and cloth, and brewing.

Ingolstadt, known as *Aureatum* or *Chrysopolis*, was a royal villa in the beginning of the 9th century, and received its charter of civic incorporation before 1255. After that date it grew in importance, and became the capital of a dukedom which merged in that of Bavaria-Munich. The fortifications, erected in 1539, were put to the test during the contests of the Reformation period and in the Thirty Years' War. Gustavus Adolphus vainly besieged Ingolstadt in 1632, when Tilly, to whom there is a monument in the Frauenkirche, lay mortally wounded within the walls. In the War of the Spanish Succession it was besieged by the margrave of Baden in 1704. In 1743 it was surrendered by the French to the Austrians, and in 1800, after three months' siege, the French, under General Moreau, took the town, and dismantled the fortifications. They were rebuilt on a much larger scale under King Louis I., and since 1870 Ingolstadt has ranked as a fortress of the first class. In 1872 even more important fortifications were constructed, which include têtes-de-pont with round towers of massive masonry, and the redoubt Tilly on the right bank of the river.

See Gerstner, *Geschichte der Stadt Ingolstadt* (Munich, 1853); and Prantl, *Geschichte der Ludwig Maximilians Universität* (Munich, 1870).

**INGOT**, originally a mould for the casting of metals, but now a mass of metal cast in a mould, and particularly the small bars of the precious metals, cast in the shape of an oblong brick or wedge with slightly sloping sides, in which form gold and silver are handled as bullion at the Bank of England and the Mint. Ingots of varying sizes and shapes are cast of other metals, and "ingot-steel" and "ingot-iron" are technical terms in the manufacture of iron and steel (see IRON AND STEEL). The word is obscure in origin. It occurs in Chaucer ("The Canon's Yeoman's Tale") as a term of alchemy, in the original sense of a mould for casting metal, and, as the *New English Dictionary* points out, an English origin for such a term is unlikely. It may, however, be derived from *in* and the O. Eng. *gotan* to pour; cf. Ger. *giessen* and *Einguss*, a mould. The Fr. *lingot*, with the second English meaning only, has been taken as the origin of "ingot" and derived from the Lat. *lingua*, tongue—with a supposed reference to the shape. This derivation is wrong, and French etymologists have now accepted the English origin for the word, *lingot* having coalesced from *lingot*.

**INGRAM, JAMES** (1774-1850), English antiquarian and Anglo-Saxon scholar, was born near Salisbury on the 21st of December 1774. He was educated at Westminster and Winchester schools and at Trinity College, Oxford, of which he became a fellow in 1803. From 1805 to 1808 he was Rawlinsonian professor of Anglo-Saxon at Oxford, and in 1824 was made President of Trinity College and D.D. His time, however, was principally spent in antiquarian research, and especially in the study of Anglo-Saxon, in which field he was the pre-eminent scholar of his time. He published in 1823 an edition of the *Saxon Chronicle*. His other works include admirable *Memorials of Oxford* (1832-1837), and *The Church in the Middle Centuries* (1842). He died on the 5th of September 1850.

**INGRAM, JOHN KELLS** (1823-1907), Irish scholar and economist, was born in Co. Donegal, Ireland, on the 7th of July 1823. Educated at Newry School and Trinity College, Dublin, he was elected a fellow of his college in 1846. He held the professorship of Oratory and English Literature in Dublin University from 1852 to 1866, when he became regius professor of Greek. In 1879 he was appointed librarian. Ingram was remarkable for his versatility. In his undergraduate days he had written the well-known poem "Who fears to speak of Ninety-eight?" and his *Sonnets and other Poems* (1900) reveal the

poetic sense. He contributed many important papers to mathematical societies on geometrical analysis, and did much useful work in advancing the science of classical etymology, notably in his *Greek and Latin Etymology in England*, *The Etymology of Liddell and Scott*. His philosophical works include *Outlines of the History of Religion* (1900), *Human Nature and Morals according to A. Comte* (1901), *Practical Morals* (1904), and *The Final Transition* (1905). He contributed to the 9th edition of the *Encyclopædia Britannica* an historical and biographical article on political economy, which was translated into nearly every European language. His *History of Slavery and Serfdom* was also written for the 9th edition of the *Encyclopædia Britannica*. He died in Dublin on the 18th of May 1907.

**INGRES, JEAN AUGUSTE DOMINIQUE** (1780-1867), French painter, was born at Montauban, on the 29th of August 1780. His father, for whom he entertained the most tender and respectful affection, has described himself as *sculpteur en pâte*; he was, however, equally ready to execute every other kind of decorative work, and now and again eked out his living by taking portraits or obtained an engagement as a violin-player. He brought up his son to command the same varied resources, but in consequence of certain early successes—the lad's performance of a concerto of Viotti's was applauded at the theatre of Toulouse—his attention was directed chiefly to the study of music. At Toulouse, to which place his father had removed from Montauban in 1792, Ingres had, however, received lessons from Joseph Roques, a painter whom he quitted at the end of a few months to become a pupil of M. Vigan, professor at the academy of fine arts in the same town. From Vigan, Ingres, whose vocation became day by day more distinctly evident, passed to M. Briant, a landscape-painter who insisted that his pupil was specially gifted by nature to follow the same line as himself. For a while Ingres obeyed, but he had been thoroughly aroused and enlightened as to his own objects and desires by the sight of a copy of Raphael's "Madonna della Sedia," and, having ended his connexion with Briant, he started for Paris, where he arrived about the close of 1796. He was then admitted to the studio of David, for whose lofty standard and severe principles he always retained a profound appreciation. Ingres, after four years of devoted study, during which (1800) he obtained the second place in the yearly competition, finally carried off the Grand Prix (1801). The work thus rewarded—the "Ambassadors of Agamemnon in the Tent of Achilles" (École des Beaux Arts)—was admired by Flaxman so much as to give umbrage to David, and was succeeded in the following year (1802) by the execution of a "Girl after Bathing," and a woman's portrait; in 1804 Ingres exhibited "Portrait of the First Consul" (Musée de Liège), and portraits of his father and himself; these were followed in 1806 by "Portrait of the Emperor" (Lувалides), and portraits of M. Mme, and Mlle Rivière (the first two now in the Louvre). These and various minor works were executed in Paris (for it was not until 1809 that the state of public affairs admitted of the re-establishment of the Academy of France at Rome), and they produced a disturbing impression on the public. It was clear that the artist was some one who must be counted with; his talent, the purity of his line, and his power of literal rendering were generally acknowledged; but he was reproached with a desire to be singular and extraordinary. "Ingres," writes Frau v. Hasler (*Leben und Kunst in Paris, 1806*) "wird nach Italien gehen, und dort wird er vielleicht vergessen dass er zu etwas Grosse geboren ist, und wird eben darum ein hohes Ziel erreichen." In this spirit, also, Chausard violently attacked his "Portrait of the Emperor" (*Pausanias Français, 1806*), nor did the portraits of the Rivière family escape. The points on which Chausard justly lays stress are the strange discordances of colour—such as the blue of the cushion against which Mme Rivière leans, and the want of the relief and warmth of life, but he omits to touch on that grasp of his subject as a whole, shown in the portraits of both husband and wife, which already evidences the strength and sincerity of the passionless point of view which marks all Ingres's best productions. The very year after his arrival in Rome (1808) Ingres produced "Oedipus and

the Sphinx" (Louvre; lithographed by Sudre, engraved by Gaillard), a work which proved him in the full possession of his mature powers, and began the "Venus Anadyomene" (Collection Rieset; engraving by Pollet), completed forty years later, and exhibited in 1855. These works were followed by some of his best portraits, that of M. Bochet (Louvre), and that of Mme la Comtesse de Tournon, mother of the prefect of the department of the Tiber; in 1811 he finished "Jupiter and Thetis," an immense canvas now in the Musée of Aix; in 1812 "Romulus and Acron" (École des Beaux Arts), and "Virgil reading the *Æneid*"—a composition very different from the version of it which has become popular through the engraving executed by Pradier in 1832. The original work, executed for a bedchamber in the Villa Aldobrandini-Miollis, contained neither the figures of Mæcenas and Agrippa nor the statue of Marcellus; and Ingres, who had obtained possession of it during his second stay in Rome, intended to complete it with the additions made for engraving. But he never got beyond the stage of preparation, and the picture left by him, together with various other studies and sketches, to the Musée of his native town, remains half destroyed by the process meant for its regeneration. The "Virgil" was followed by the "Betrothal of Raphael," a small painting, now lost, executed for Queen Caroline of Naples; "Don Pedro of Toledo Kissing the Sword of Henry IV." (Collection Deymié; Montauban), exhibited at the Salon of 1814, together with the "Chapelle Sistine" (Collection Legentil; lithographed by Sudre), and the "Grande Odalisque" (Collection Seillière; lithographed by Sudre). In 1815 Ingres executed "Raphael and the Fornarina" (Collection Mme N. de Rothschild; engraved by Pradier); in 1816 "Aretin" and the "Envoiy of Charles V." (Collection Schroth), and "Aretin and Tintoret" (Collection Schroth); in 1817 the "Death of Leonardo" (engraved by Richomme) and "Henry IV. Playing with his Children" (engraved by Richomme), both of which works were commissions from M. le Comte de Blacas, then ambassador of France at the Vatican. "Roger and Angelique" (Louvre; lithographed by Sudre), and "Francesca di Rimini" (Musée of Angers; lithographed by Aubry Lecomte), were completed in 1819, and followed in 1820 by "Christ giving the Keys to Peter" (Louvre). In 1815, also, Ingres had made many projects for treating a subject from the life of the celebrated duke of Alva, a commission from the family, but a loathing for "cet horrible homme" grew upon him, and finally he abandoned the task and entered in his diary—"J'étais forcé par la nécessité de peindre un pareil tableau; Dieu a voulu qu'il restât en ébauche." During all these years Ingres's reputation in France did not increase. The interest which his "Chapelle Sistine" had aroused at the Salon of 1814 soon died away; not only was the public indifferent, but amongst his brother artists Ingres found scant recognition. The strict classicists looked upon him as a renegade, and strangely enough Delacroix and other pupils of Guérin—the leaders of that romantic movement for which Ingres, throughout his long life, always expressed the deepest abhorrence—alone seem to have been sensible of his merits. The weight of poverty, too, was hard to bear. In 1813 Ingres had married; his marriage had been arranged for him with a young woman who came in a business-like way from Montauban, on the strength of the representations of her friends in Rome. Mme Ingres speedily acquired a faith in her husband which enabled her to combat with heroic courage and patience the difficulties which beset their common existence, and which were increased by their removal to Florence. There Bartolini, an old friend, had hoped that Ingres might have materially bettered his position, and that he might have avoided the Florentine school—a weak offshoot from that of David—to a sense of its own shortcomings. These expectations were disappointed. The good offices of Bartolini, and of one or two other persons, could only alleviate the miseries of this stay in a town where Ingres was all but deprived of the means of gaining daily bread by the making of those small portraits for the execution of which, in Rome, his pencil had been constantly in request. Before his departure he had, however, been commissioned to paint for M. de Pastoret the "Entry of

Charles V. into Paris," and M. de Pastoret now obtained an order for Ingres from the Administration of Fine Arts; he was directed to treat the "Vœu de Louis XIII." for the cathedral of Montauban. This work, exhibited at the Salon of 1824, met with universal approbation: even those sworn to observe the unadulterated precepts of David found only admiration for the "Vœu de Louis XIII." On his return Ingres was received at Montauban with enthusiastic homage, and found himself celebrated throughout France. In the following year (1825) he was elected to the Institute, and his fame was further extended in 1826 by the publication of Sudre's lithograph of the "Grande Odalisque," which, having been scorned by artists and critics alike in 1819, now became widely popular. A second commission from the government called forth the "Apotheosis of Homer," which, replaced by a copy in the decoration of the ceiling for which it was designed, now hangs in the galleries of the second storey of the Louvre. From this date up till 1834 the studio of Ingres was thronged, as once had been thronged the studio of David, and he was a recognized *chef d'école*. Whilst he taught with despotic authority and admirable wisdom, he steadily worked; and when in 1834 he produced his great canvas of the "Martyrdom of Saint Symphorien" (cathedral of Autun; lithographed by Trichot-Garneri), it was with angry disgust and resentment that he found his work received with the same doubt and indifference, if not the same hostility, as had met his earlier ventures. The suffrages of his pupils, and of one or two men—like Decamps—of undoubted ability, could not soften the sense of injury. Ingres resolved to work no longer for the public, and gladly availed himself of the opportunity to return to Rome, as director of the *École de France*, in the room of Horace Vernet. There he executed "La Vierge à l'Hostie" (Imperial collections, St Petersburg), "Stratonice," "Portrait of Cherubini" (Louvre), and the "Petite Odalisque" for M. Marcotte, the faithful admirer for whom, in 1814, Ingres had painted the "Chapelle Sistine." The "Stratonice," executed for the duke of Orleans, had been exhibited at the Palais Royal for several days after its arrival in France, and the beauty of the composition produced so favourable an impression that, on his return to Paris in 1841, Ingres found himself received with all the deference that he felt to be his due. A portrait of the purchaser of "Stratonice" was one of the first works executed after his return; and Ingres shortly afterwards began the decorations of the great hall in the Château de Dampierre, which, unfortunately for the reputation of the painter, were begun with an ardour which gradually slackened, until in 1849 Ingres, having been further discouraged by the loss of his faithful and courageous wife, abandoned all hope of their completion, and the contract with the duc de Luynes was finally cancelled. A minor work, "Jupiter and Antiope," marks the year 1851, but Ingres's next considerable undertaking (1853) was the "Apotheosis of Napoleon I.," painted for the ceiling of a hall in the Hôtel de Ville; "Jeanne d'Arc" (Louvre) appeared in 1854; and in 1855 Ingres consented to rescind the resolution, more or less strictly kept since 1834, in favour of the International Exhibition, where a room was reserved for his works. Prince Napoleon, president of the jury, proposed an exceptional recompense for their author, and obtained from the emperor Ingres's nomination as grand officer of the Legion of Honour. With renewed confidence Ingres now took up and completed one of his most charming productions—"La Source" (Louvre), a figure of which he had painted the torso in 1823; and which seen with other works in London (1862) there renewed the general sentiment of admiration, and procured him, from the imperial government, the dignity of senator. After the completion of "La Source," the principal works produced by Ingres were with one or two exceptions ("Molière" and "Louis XIV.," presented to the Théâtre Français, 1858; "Le Bain Turc," 1859), of a religious character; "La Vierge de l'Adoption," 1858 (painted for Mlle Roland-Gosselin), was followed by "La Vierge Couronnée" (painted for Mme la Baronne de Larinthe) and "La Vierge aux Enfants" (Collection Blanc); in 1859 these were followed by repetitions of "La Vierge à l'Hostie"; and

in 1862 Ingres completed "Christ and the Doctors" (Musée Montauban), a work commissioned many years before by Queen Marie Amélie for the chapel of Bizy.

On the 17th of January 1867 Ingres died in his eighty-eighth year, having preserved his faculties in wonderful perfection to the last. For a moment only—at the time of the execution of the "Bain Turc," which Prince Napoleon was fain to exchange for an early portrait of the master by himself—Ingres's powers had seemed to fail, but he recovered, and showed in his last years the vigour which marked his early maturity. It is, however, to be noted that the "Saint Symphorien" exhibited in 1834 closes the list of the works on which his reputation will chiefly rest; for "La Source," which at first sight seems to be an exception, was painted, all but the head and the extremities, in 1821; and from those who knew the work well in its incomplete state we learn that the after-painting, necessary to fuse new and old, lacked the vigour, the precision, and the something like touch which distinguished the original execution of the torso. Touch was not, indeed, at any time a means of expression on which Ingres seriously calculated; his constant employment of local tint, in mass but faintly modelled in light by half tones, forbade recourse to the shifting effects of colour and light on which the Romantic school depended in indicating those fleeting aspects of things which they rejoiced to put on canvas;—their methods would have disturbed the calculations of an art wholly based on form and line. Except in his "Sistine Chapel," and one or two slighter pieces, Ingres kept himself free from any preoccupation as to depth and force of colour and tone; driven, probably by the excesses of the Romantic movement into an attitude of stricter protest, "ce que l'on sait" he would repeat, "il faut le savoir l'épée à la main." Ingres left himself therefore, in dealing with crowded compositions, such as the "Apotheosis of Homer" and the "Martyrdom of Saint Symphorien," without the means of producing the necessary unity of effect which had been employed in due measure—as the Stanze of the Vatican bear witness—by the very master whom he most deeply revered. Thus it came to pass that in subjects of one or two figures Ingres showed to the greatest advantage: in "Oedipus," in the "Girl after Bathing," the "Odalisque" and "La Source"—subjects only animated by the consciousness of perfect physical well-being—we find Ingres at his best. One hesitates to put "Roger and Angelique" upon this list, for though the female figure shows the finest qualities of Ingres's work,—deep study of nature in her purest forms, perfect sincerity of intention and power of mastering an ideal conception—yet side by side with these the effigy of Roger on his hippogriff bears witness that from the passionless point of view, which was Ingres's birthright, the weird creatures of the fancy cannot be seen.

A graphic account of "Ingres, sa vie et ses travaux," and a complete catalogue of his works, were published by M. Delaborde in 1870, and dedicated to Mme Ingres, née Ramel, Ingres's devoted second wife, whom he married in 1852. Allusions to the painter's early days will be found in Delcœur's *Louis David*; and amongst less important notices may be cited that by Théophile Silvestre in his series of living artists. Most of Ingres's important works are engraved in the collection brought out by Magimel. (E. F. S. D.)

**INGRESS** (Lat. *ingressus*, going in), entrance as opposed to exit or egress; in astronomy, the apparent entrance of a smaller body upon the disk of a larger one, as it passes between the latter and the observer; in this sense it is applied especially to the beginning of a transit of a satellite of Jupiter over the disk of the planet.

**INHAMBANE**, a seaport of Portuguese East Africa in 23° 50' S., 35° 25' E. The town, which enjoys a reputation for healthiness, is finely situated on the bank of a river of the same name which empties into a bay also called Inhambane. Next to Mozambique Inhambane, which dates from the middle of the 16th century, is architecturally the most important town in Portuguese East Africa. The chief buildings are the fort, churches and mosque. The principal church is built with stone and marble brought from Portugal. The population, about 4000 in 1909, is of a motley character: Portuguese and other Europeans, Arabs, Banyans, half-castes and negroes. Its commerce was formerly

mostly in ivory and slaves. In 1834 Inhambane was taken and all its inhabitants save ten killed by a Zulu horde under Manikusa (see GAZALAND). It was not until towards the close of the 19th century that the trade of the town revived. The value of exports and imports in 1907 was about £150,000. The chief exports are wax, rubber, mafureira and other nuts, mealies and sugar. Cotton goods and cheap wines (for consumption by natives) are the principal imports. The harbour, about 9 m. long by 5 wide, accommodates vessels drawing 10 to 12 ft. of water. The depth of water over the bar varies from 17 to 28 ft., and large vessels discharge into and load from lighters. Inhambane is the natural port for the extensive and fertile district between the Limpopo and Sabi rivers. This region is the best recruiting ground for labourers in the Rand gold mines. Mineral oils have been found within a short distance of the port.

**INHERITANCE.** In English law, inheritance, heir and other kindred words have a meaning very different from that of the Latin *haeres*, from which they are derived. In Roman law the heir or heirs represented the entire legal personality of the deceased—his *universum jus*. In English law the heir is simply the person on whom the real property of the deceased devolves by operation of law if he dies intestate. He has nothing to do as heir with the personal property; he is not appointed by will; and except in the case of coparceners he is a single individual. The Roman *haeres* takes the whole estate; his appointment may or may not be by testament; and more persons than one may be associated together as heirs.

The devolution of an inheritance in England is now regulated by the rules of descent, as altered by the Inheritance Act 1833, amended by the Law of Property Amendment Act 1850.

1. The first rule is that inheritance shall descend to the issue of the last "purchaser." A purchaser in law means one who acquires an estate otherwise than by descent, e.g. by will, by gratuitous gift, or by purchase in the ordinary meaning of the word. This rule is one of the changes introduced by the Inheritance Act, which further provides that "the person last entitled to the land shall be considered the purchaser thereof unless it be proved that he inherited the same." Under the earlier law descent was traced from the last person who had "seisin" or feudal possession, and it was occasionally a troublesome question whether the heir or person entitled had ever, in fact, acquired such possession. Now the only inquiry is into title, and each person entitled is presumed to be in by purchase unless he is proved to be in by descent, so that the stock of descent is the last person entitled who cannot be shown to have inherited.

2. The male is admitted before the female. 3. Among males of equal degree in consanguinity to the purchaser, the elder excludes the younger; but females of the same degree take together as "coparceners." 4. Lineal descendants take the place of their ancestor. Thus an eldest son dying and leaving issue would be represented by such issue, who would exclude their father's brothers and sisters. 5. If there are no lineal descendants of the purchaser, the next to inherit is his nearest lineal ancestor. This is a rule introduced by the Inheritance Act. Under the former law inheritance never went to an ancestor—collaterals, however remote of the person last seized being preferred even to his father. Various explanations have been given of this seemingly anomalous rule—Bracton and Blackstone being content to say that it rests on the law of nature, by which heavy bodies gravitate downwards. Another explanation is that estates were granted to be descendible in the same way as an ancient inheritance, which having passed from father to son *ex necessitate* went to collaterals on failure of issue of the person last seized. 6. The sixth rule is thus expressed by Joshua Williams in his treatise on *The Law of Real Property*:—

"The father and all the male paternal ancestors of the purchaser and their descendants shall be admitted before any of the female paternal ancestors or their heirs; all the female paternal ancestors and their heirs before the mother or any of the maternal ancestors or her or their descendants; and the mother and all the male maternal ancestors and her and their descendants before any of the female maternal ancestors or their heirs."

7. Kinsmen of the half-blood may be heirs; such kinsmen shall inherit next after a kinsman in the same degree of the whole blood, and after the issue of such kinsman where the common ancestor is a male and next after the common ancestor where such ancestor is a female. The admission of kinsmen of the half-blood into the chain of descent is an alteration made by the Inheritance Act. Formerly a relative, however nearly connected in blood with the purchaser through one only and not both parents, could never inherit—a half-brother for example. 8. In the admission of female paternal ancestors, the mother of the more remote male paternal ancestor and her heirs shall be preferred to the mother of the less remote male paternal and her heirs; and, in the case of female maternal ancestors, the mother of the more remote male maternal ancestor shall be preferred to the mother of a less remote male maternal ancestor. This rule, following the opinion of Blackstone, settles a point much disputed by text-writers, although its importance was little more than theoretical. 9. When there shall be a total failure of heirs of the purchaser, or when any lands shall be descendible as if an ancestor had been the purchaser thereof, and there shall be a total failure of the heirs of such ancestor, then and in every such case the descent shall be traced from the person last entitled to the land as if he had been the purchaser thereof. This rule is enacted by the Law of Property Amendment Act 1850. It would apply to such a case as the following: Purchaser dies intestate, leaving a son and no other relations, and the son in turn dies intestate; the son's relations through his mother are now admitted by this rule. If the purchaser is illegitimate, his only relations must necessarily be his own issue. Failing heirs of all kinds, the lands of an intestate purchaser, not alienated by him, would revert by "escheat" to the next immediate lord of the fee, who would generally be the crown. If an intermediate lordship could be proved to exist between the crown and the tenant in fee simple, such intermediate lord would have the escheat. But escheat is a matter of rare occurrence.

The above rules apply to all freehold land whether the estate therein of the intestate is legal or equitable. Before 1884, if a sole trustee had the legal estate in realty, and his *cestui que trust* died intestate and without heirs, the land escheated to the trustee. This distinction was abolished by the Intestate Estates Act 1884.

The descent of an estate in tail would be ascertained by such of the foregoing rules as are not inapplicable to it. By the form of the entail the estate descends to the "issue" of the person to whom the estate was given in tail—in other words, the last purchaser. The preceding rules after the fourth, being intended for the ascertainment of heirs other than those by lineal descent, would therefore not apply; and a special limitation in the entail, such as to heirs male or female only, would render unnecessary some of the others. When the entail has been barred, the estate descends according to these rules. In copyhold estates descent, like other incidents thereof, is regulated by the custom of each particular manor; e.g. the youngest son may exclude the elder sons. How far the Inheritance Act applies to such estates has been seriously disputed. It has been held in one case (*Mugleton v. Barnet*) that the Inheritance Act, which orders descent to be traced from the last purchaser, does not override a manorial custom to trace descent from the person last seized, but this position has been controverted on the ground that the act itself includes the case of customary holdings.

Husband and wife do not stand in the rank of heir to each other. Their interests in each other's real property are secured by courtesy and dower.

The personal property of a person dying intestate devolves according to an entirely different set of rules (see *INTESTACY*).

In Scotland the rules of descent differ from the above in several particulars. Descent is traced, as in England before the Inheritance Act, to the person last seized. The first to succeed are the lineal descendants of the deceased, and the rules of primogeniture, preference of males to females, equal succession of females (heirs-partioners), and representation of ancestors are generally the same as in English law. Next to the lineal descendants, and failing them,



come the brothers and sisters, and their issue as collaterals. Failing collaterals, the inheritance ascends to the father and his relations, to the entire exclusion of the mother and her relations. Even when the estate has descended from mother to son, it can never revert to the maternal line. As to succession of brothers, a distinction must be taken between an estate of heritage and an estate of conquest. Conquest is where the deceased has acquired the land otherwise than as heir, and corresponds to the English term purchase in the technical sense explained. Heritage is land acquired by deceased as heir. The distinction is important only in the case when the heir of the deceased is to be sought among his brothers; when the descent is lineal, conquest and heritage go to the same person. And when the brothers are younger than the deceased, both conquest and heritage go to the brother (or his issue) next in order of age. But when the deceased leaves an elder and a younger brother (or their issues), the elder brother takes the conquest, the younger takes the heritage. Again, when there are several elder brothers, the one next in age to the deceased takes the conquest before the more remote, and when there are several younger brothers, the one next to the deceased takes the heritage before the more remote. When heritage of the deceased goes to an elder brother (as might happen in certain eventualities), the younger of the elder brothers is preferred. The position of the father, after the brothers and sisters of the deceased, will be noticed as an important point of difference from the English axioms; so also is the total exclusion of the mother and the maternal line. As between brothers and sisters the half-blood only succeeds after the full blood. Half-blood is either consanguinean, as between children by the same father, or uterine, as between children having the same mother. The half-blood uterine is excluded altogether. Half-blood consanguinean succeeds thus: if the issue is by a former marriage, the youngest brother (being nearest to the deceased of the consanguinean) succeeds first; if by a later marriage than that from which the deceased has sprung, the eldest succeeds first.

*United States.*—American law has borrowed its rules of descent considerably more from the civil law than the common law. "The 118 novel of Justinian has a striking resemblance to American law in giving the succession of estates to all legitimate children without distinction and disregarding all considerations of primogeniture. There is one particular in which the American law differs from that of Justinian, that while generally in this country lineal descendants if they stand in an equal degree from the common ancestor share equally *per capita*, under the Roman law regard was had to the right of representation, each lineal branch of descendants taking only the portion which their parent would have taken had he been living, the division being *per stirpes* and not *per capita*. But in some of the states the rule of the Roman law in this respect has been adopted and retained. Among these are Rhode Island, New Jersey, North and South Carolina, Alabama and Louisiana" (3 Washburn's *Real Property*, pp. 408, 409; 4 Kent's *Comm.* p. 375). When such lineal descendants stand in unequal degrees of consanguinity the inheritance is *per stirpes* and not *per capita* (*In re Prote*, 1907; 104, N.Y. Supplement 581). This is the rule in practically all the states. But as in no two states or territories are the rules of descent identical, the only safe guides are the statutes and decisions of the particular state in which the land to be inherited is situated. The law of primogeniture as understood in England is generally abolished throughout the United States, and male and female relatives inherit equally. In some states, as in Massachusetts, relatives of the half-blood inherit equally with those of the whole-blood of the same degree; in others, like Maryland, they can inherit only in case none of whole-blood exist. In some of the states the English rule that natural children have no inheritable blood has been greatly modified. In Louisiana, if duly acknowledged, they may inherit from both father and mother in the absence of lawful issue. Degrees of kindred in the United States generally are computed according to the civil law, *i.e.* by adding together the number of degrees between each of the two persons whose relationship is to be ascertained and the common ancestor. Thus, relationship between two brothers is in the second degree; between uncle and nephew in the third degree; between cousins, in the fourth. &c.

In a few states such degrees are computed according to the common law, *i.e.* by counting from the common ancestor to the most remote descendant of the two from him—thus, brothers would be related in the first degree, uncle and nephew in the second, &c. In most states representation amongst collaterals is restricted—in some to the descendants of brothers and sisters, in others to their children only.

In some states, *e.g.* in California, Louisiana and Texas, the law of "community property" of husband and wife prevails. This is derived from the French and Spanish law existing in the territories out of which those states were formed, as the result of the conquest of Mexico by Spain and the colonizing of Louisiana by France. The foundation idea is an equal division at death of either party of all property acquired during their marriage except by gift, devise or descent. In general the husband has the control and management thereof during the marriage, and either survivor has the administration of the moiety of the one deceased. There is a conflict in the laws in such states as to the exact definition and as to whether or not the gains or profits of such property are to be deemed separate property or community property [Succession of Dielman (Louisiana, 1907), 43 Southern Rep. 972].

**INHIBITION** (from Lat. *inhibere*, to restrain, prevent), an act of restraint or prohibition, an English legal term, particularly used in ecclesiastical law, for a writ from a superior to an inferior court, suspending proceedings in a case under appeal, also for the suspension of a jurisdiction of a bishop's court on the visitation of an archbishop, and for that of an archdeacon on the visitation of a bishop. It is more particularly applied to a form of ecclesiastical *censure*, suspending an offending clergyman from the performance of any service of the Church, or other spiritual duty, for the purpose of enforcing obedience to a monition or order of the bishop or judge. Such inhibitions are at the discretion of the ordinary if he considers that scandal might arise from the performance of spiritual duties by the offender (Church Discipline Act 1866, re-enacted by the Clergy Discipline Act 1892, sect. 10). By the Sequestration Act 1871, sect. 5, similar powers of inhibition are given where a sequestration remains in force for more than six months, and also, by the Benefices Act 1898, in cases where a commission reports that the ecclesiastical duties of a benefice are inadequately performed through the negligence of the incumbent.

**INISFAIL**, a poetical name for Ireland. It is derived from *Faol* or *Lia-fail*, the celebrated stone, identified in Irish legend with the stone on which the patriarch Jacob slept when he dreamed of the heavenly ladder. The *Lia-fail* was supposed to have been brought to Ireland by the Dedannans and set up at Tara as the "inauguration stone" of the Irish kings; it was subsequently removed to Scone where it became the coronation stone of the Scottish kings, until it was taken by James VI. of Scotland to Westminster and placed under the coronation chair in the Abbey, where it has since remained. Inisfail was thus the island of the Fail, the island whose monarchs were crowned at Tara on the sacred inauguration stone.

**INITIALS** (Lat. *initialis*, of or belonging to a beginning, *initium*), the first letters of names. In legal and formal documents it is usually the practice in appending a signature to write the name in full. But this is by no means necessary, even in cases where a signature is expressly required by statute. It has been held that it is sufficient if a person affixes to a document the usual form in which he signs his name, with the intent that it shall be treated as his signature. So, signature by initials is a good signature within the Statute of Frauds (*Phillimore v. Barry*, 1818, 1 Camp. 513), and also under the Wills Act 1837 (*In re Blewitt*, 1880, 5 P.D. 116).

**INITIATION** (Lat. *initium*, beginning, entrance, from *inire*, to go in), the process of formally entering, and especially the rite of admission into, some office, or religious or secret society, &c. Among nearly all primitive races initiatory rites of a bloody character were and are common. The savage pays homage to strength, and the purpose of his initiatory rites is to test physical vigour, self-control and the power of enduring pain. Initiation is sometimes religious, sometimes social, but in primitive society it has always the same character. Thus, in Whydah (West Africa) the young girls consecrated to the worship of the serpent, "the brides of the Serpent," had figures of flowers and animals burnt into their skins with hot irons; while in the neighbouring Yorubaland the power of enduring a sound thrashing is the qualification for the throne. In no country was the practice of initiatory rites more general than in the Americas. The Colombian Indians compelled their would-be chief to submit to terrible tests. He had first to bear severe beatings without a murmur. Then, placed in a hammock with his hands tied,

venomous ants were placed on his naked body. Finally a fire was lit beneath him. All this he had to bear without flinching. In ancient Mexico there were several orders of chivalry, entry into which was only permitted after brutal initiation. The nose of the candidate was pierced with an eagle's talon or a pointed lance, and he was expected to dig knives into his body. In Peru the young Inca princes had to fast and live for weeks without sleep. Among the North American Indians initiatory rites were universal. The Mandans held a feast at which the young "braves" supported the weight of their bodies on pieces of wood skewered through the muscles of shoulders, breasts and arms. With the Sioux, to become a medicine-man, it was necessary to submit to the ordeal known as "looking at the sun." The sufferer, nearly naked, was bound on the earth by cords passed through holes made in the pectoral muscles. With bow and arrow in hand, he lay in this position all day gazing at the sun. Around him his friends gathered to applaud his courage.

Religious brotherhoods of antiquity, too, were to be entered only after long and complicated initiation. But here the character of the ordeal is rather moral than physical. Such were the rites of admission to the Mysteries of Isis and Eleusis. Secret societies of all ages have been characterized by more or less elaborate initiation. That of the Femgericht, the famous medieval German secret tribunal, took place at night in a cave, the neophyte kneeling and making oath of blind obedience. Imitations of such tests are perpetuated to-day in freemasonry; while the Maña, the Cainorra, the Clan-na-Gael, the Molly Maguires, the Ku-Klux Klan, are among more recent secret associations which have maintained the old idea of initiation.

**INJECTOR** (from Lat. *injicere*, to throw in), an appliance for supplying steam-boilers with water, and especially used with locomotive boilers. It was invented by the French engineer H. V. Giffard in 1858, and presents the paradox that by the pressure of the steam in the boiler, or even, as in the case of

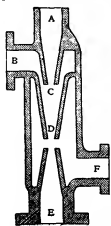

the exhaust steam injector, by steam at a much lower pressure, water is forced into the boiler against that pressure. A diagrammatic section illustrating its construction is shown in figure. Steam enters at A and blows through the annular orifice C, the size of which can be regulated by a valve not shown in the figure. The feed water flows in at B and meeting the steam at C causes it to condense. Hence a vacuum is produced at C, and consequently the water rushes in with great velocity and streams down the combining cone D, its velocity being augmented by the impact of steam on the back of the column. In the lower part of the nozzle E the stream expands; it therefore loses velocity and,

by a well-known hydrodynamic principle, gains pressure, until at the bottom the pressure is so great that it is able to enter the boiler through a check valve which opens only in the direction of the stream. An overflow pipe F, by providing a channel through which steam and water may escape before the stream has acquired sufficient energy to force its way into the boiler, allows the injector to start into action. Means are also provided for regulating the amount of water admitted between D and C. In the *exhaust-steam injector*, which works with steam from the exhaust of non-condensing engines, the steam orifice is larger in proportion to other parts than in injectors working with boiler steam, and the steam supply more liberal. In *self-starting injectors* an arrangement is provided which permits free overflow until the injector starts into action, when the openings are automatically adjusted to suit delivery into the boiler.

**INJUNCTION** (from Lat. *injungere*, to fasten, or attach to, to lay a burden or charge on, to enjoin), a term meaning generally a command, and in English law the name for a judicial process whereby a party is required to refrain from doing a particular thing according to the exigency of the writ. Formerly it was a remedy peculiar to the court of chancery, and was one

of the instruments by which the jurisdiction of that court was established in cases over which the courts of common law were entitled to exercise control. The court of chancery did not presume to interfere with the action of the courts, but, by directing an injunction to the person whom it wished to restrain from following a particular remedy at common law, it effected the same purpose indirectly. Under the present constitution of the judicature, the injunction is now equally available in all the divisions of the high court of justice, and it can no longer be used to prevent an action in any of them from proceeding in the ordinary course.

Although an injunction is properly a restraining order, there are instances in which, under the form of a prohibition, a positive order to do something is virtually expressed. Thus in a case of nuisance an injunction was obtained to restrain the defendant from preventing water from flowing in such regular quantities as it had ordinarily done before the day on which the nuisance commenced. But generally, if the relief prayed for is to compel something to be done, it cannot be obtained by injunction, although it may be expressed in the form of a prohibition—as in the case in which it was sought to prevent a person from discontinuing to keep a house as an inn. The injunction was used to stay proceedings in other courts "wherever a party by fraud, accident, mistake or otherwise had obtained an advantage in proceeding in a court of ordinary jurisdiction, which must necessarily make that court an instrument of injustice." As the injunction operates personally on the defendant, it may be used to prevent applications to foreign judicatures; but it is not used to prevent applications to parliament, or to the legislature of any foreign country, unless such applications be in breach of some agreement, and relate to matters of private interest. In so far as an injunction is used to prohibit acts, it may be founded either on an alleged contract or on a right independent of contract. The jurisdiction of the court to prevent breaches of contract has been described as supplemental to its power of compelling specific performance; *i.e.* if the court has power to compel a person to perform a contract, it will interfere to prevent him from doing anything in violation of it. But even when it is not within the power of the court to compel specific performance, it may interfere by injunction; thus, *e.g.* in the case of an agreement of a singer to perform at the plaintiff's theatre and at no other, the court, although it could not compel her to sing, could by injunction prevent her from singing elsewhere in breach of her agreement.

An injunction may as a general rule be obtained to prevent acts which are violations of legal rights, except when the same may be adequately remedied by an action for damages at law. Thus the court will interfere by injunction to prevent waste, or the destruction by a limited owner, such as a tenant for life, of things forming part of the inheritance. Injunctions may also be obtained to prevent the continuance of nuisances, public or private, the infringement of patents, copyrights and trade marks. Trespass might also in certain cases be prevented by injunction. Under the Common Law Procedure Act of 1854, and by other statutes in special cases, a limited power of injunction was conferred on the courts of common law. But the Judicature Act, by which all the superior courts of common law and chancery were consolidated, enacts that an injunction may be granted by an interlocutory order of the court in all cases in which it shall appear to be just or convenient; . . . and, if an injunction is asked either before or at or after the hearing of any cause or matter, to prevent any threatened or apprehended waste or trespass, such injunction may be granted whether the person against whom it is sought is or is not in possession under any claim of title or otherwise, or if not in possession does or does not claim to do the act sought to be restrained under colour of any title, and whether the estates claimed are legal or equitable.

An injunction obtained on interlocutory application during the progress of an action is superseded by the trial. It may be continued either provisionally or permanently. In the latter case the injunction is said to be perpetual. The distinction

between "special" and "common" injunctions—the latter being obtained as of course—is now abolished in English law.

In the courts of the United States the writ of injunction remains purely an equitable remedy. It may be issued at the instance of the president to prevent any organized obstruction to inter-state commerce or to the passage of the mails (*in re Debs*, 158 United States Reports, 564). Temporary restraining orders may be issued, *ex parte*, pending an application for a temporary injunction. In the state courts temporary injunctions are often issued, *ex parte*, subject to the defendant's right to move immediately for their dissolution. Generally, however, notice of an application for a temporary injunction is required.

For the analogous practice in Scots law see INTERDICT.

**INK** (from Late Lat. *encaustum*, Gr. *ἐγκαστρον*, the purple ink used by Greek and Roman emperors, from *ἐγκαίω*, to burn in), in its widest signification, a substance employed for producing graphic tracings, inscriptions, or impressions on paper or similar materials. The term includes two distinct conditions of pigment or colouring matter: the one fluid, and prepared for use with a pen or brush, as writing ink; the other a glutinous adhesive mass, printing ink, used for transferring to paper impressions from types, engraved plates and similar surfaces.

The ancient Egyptians prepared and used inks (Flinders Petrie discovered a papyrus bearing written characters as old as 2500 B.C.), and in China the invention of an ink is assigned to Tien-Tcheu, who lived between 2697 B.C. and 2597 B.C. These early inks were prepared from charcoal or soot mixed with gum, glue or varnish. *Sepia* (*q.v.*), the black pigment secreted by the cuttle-fish, was used as a writing fluid by the Romans. The iron-gall ink, *i.e.* an ink prepared from an iron salt and tannin, appears to have been first described by the monk Theophilus, who lived in the 11th century A.D., although Pliny, in the 1st century A.D., was acquainted with the blackening of paper containing green vitriol by immersion in an infusion of nut-galls. Iron-gall inks, prepared by mixing extracts of galls, barks, &c., with green vitriol, subsequently came into common use, and in the 16th century recipes for their preparation were given in domestic encyclopaedias. Their scientific investigation was first made by William Lewis in 1748. The earlier iron-inks were essentially a suspension of the pigment in water. In the early part of the 19th century the firm of Stephens introduced the first of the so-called blue-black inks under the name of "Stephens' writing fluid." Solutions of green vitriol and tannin, coloured by indigo and logwood, were prepared, which wrote with a blue tint and blackened on exposure, this change being due to the production of the pigment within the pores of the paper. The "alizerine" inks, patented by Leonhardt in 1856, are similar inks with the addition of a little madder. The application of aniline colours to ink manufacture in England dates from Croc's patent of 1861.

**Writing Inks.**—Writing inks are fluid substances which contain colouring matter either in solution or in suspension, and commonly partly in both conditions. They may be prepared in all shades of colour, and contain almost every pigment which can be dissolved or suspended in a suitable medium. The most important of all varieties is black ink, after which red and blue are most commonly employed. Apart from colour there are special qualities which recommend certain inks for limited applications, such as marking inks, inerasicible ink, sympathetic ink, &c. A good writing ink for ordinary purposes should continue limpid, and flow freely and uniformly from the pen; it should not throw down a thick sludgy deposit on exposure to the air; nor should a coating of mould form on its surface. It should yield distinctly legible characters immediately on writing, not fading with age; and the fluid ought to penetrate into the paper without spreading, so that the characters will neither wash out nor be readily removed by erasure. Further, it is desirable that ink should be non-poisonous, that it should be as little as possible corrode steel pens, that characters traced in it should dry readily on the application of blotting paper

without smearing, and that the writing should not present a glossy, varnished appearance.

**Tannin Inks.**—These inks are prepared from galls, or other sources of tannin, and a salt of iron, with the addition of some agglutinant in the case of the so-called oxidized inks, or a colouring matter in the case of unoxidized inks. Such mixtures form the staple black inks of commerce; they are essentially an insoluble iron gallate in extremely fine division held in suspension in water or a soluble compound dissolved in water.

On long exposure to air, as in inks, or otherwise, tannin inks gradually become thick and ropy, depositing a slimy sediment. This change on exposure is inevitable, resulting from the gradual oxidation of the ferrous compound, and it can only be retarded by permitting access of air to as small surfaces as possible. The inks also have a tendency to become mouldy, an evil which may be obviated by the use of a minute proportion of carbolic acid; or salicylic acid may be used.

The essential ingredients of ordinary black ink are—first, tannin-yielding bodies, for which Aleppo or Chinese galls are the most eligible materials; second, a salt of iron, ferrous sulphate (green vitriol) being alone employed; and third, a gummy or mucilaginous agent to keep in suspension the insoluble tinctorial matter of the ink. For ink-making the tannin has first to be transformed into gallic acid. In the case of Aleppo galls this change takes place by fermentation when the solution of the galls is exposed to the air, the tannin splitting up into gallic acid and sugar. Chinese galls do not contain the ferment necessary for inducing this change; and to induce the process yeast must be added to their solution. To prepare a solution of Aleppo galls for ink-making, the galls are coarsely powdered, and intimately mixed with chopped straw. This mixture is thrown into a narrow deep oak vat, provided with a perforated false bottom, and having a tap at the bottom for drawing off liquid. Over the mixture is poured lukewarm water, which, percolating down, extracts and carries with it the tannin of the galls. The solution is drawn off and repeatedly run through the mixture to extract the whole of the tannin, the water used being in such proportion to the galls as will produce as nearly as possible a solution having 5% of tannin. The object of using straw in the extraction process is to maintain the porosity of the mixture, as powdered galls treated alone become so slimy with mucilaginous extract that liquid fails to percolate the mass. For each litre of the 5% solution about 45 grammes of the iron salt are used, or about 100 parts of tannin for 90 parts of crystallized green vitriol. These ingredients when first mixed form a clear solution, but on their exposure to the air oxidation occurs, and an insoluble blue-black ferrosferic gallate in extremely fine division, suspended in a coloured solution of ferrous gallate, is formed. To keep the insoluble portion suspended, a mucilaginous agent is employed, and those most available are gum senegal and gum arabic. An ink so prepared develops its intensity of colour only after some exposure; and after it has partly sunk into the paper it becomes oxidized there, and so mordanted into the fibre. As the first faintness of the characters is a disadvantage, it is a common practice to add some adventitious colouring matter to give immediate distinctness, and for that purpose either extract of logwood or a solution of indigo is used. When logwood extract is employed, a smaller proportion of extract of galls is required, logwood itself containing a large percentage of tannin. For making an unoxidized or blue-black ink indigo is dissolved in strong sulphuric acid, and the ferrous sulphate, instead of being used direct, is prepared by placing in this indigo solution a proper quantity of scrap iron. To free the solution from excess of uncombined acid, chalk or powdered limestone is added, whereby the free acid is fixed and a deposit of sulphate of lime formed. A solution so prepared, mixed with a tannin solution, yields a very limpid sea-green writing fluid, and as all the constituents remain in solution, no gum or other suspending medium is necessary. In consequence the ink flows freely, is easily dried and is free from the glossy appearance which arises through the use of gum.

*China ink* or *Indian ink* is the form in which ink was earliest prepared, and in which it is still used in China and Japan for writing with small brushes instead of pens. It is extensively used by architects, engineers and artists generally, and for various special uses. China ink is prepared in the form of sticks and cakes, which are rubbed down in water for use. It consists essentially of lamp-black in very fine condition, baked up with a glutinous substance; and the finer Oriental kinds are delicately perfumed. The following description of the manufacture as conducted in Japan is from a native source:—

"The body of the ink is soot obtained from pine wood or rosin, and lamp-black from sesamum oil for the finest sort. This is mixed with liquid glue made of ox-skin. This operation is effected in a large round copper bowl, formed of two spherical vessels, placed 1 in. apart, so that the space between can be filled up with hot water to prevent the glue from hardening during the time it is being mixed by hand with the lamp-black. The cakes are formed in wooden moulds, and dried between paper and ashes. Camphor, or a peculiar mixture of scents which comes from China, and a small quantity of carthame (the red colouring substance of safflower), are added to the best kind for improving the colour as well as for scenting the ink. There is a great difference both in price and in quality of the various kinds of ink, the finest article being rather costly."

It is said that the size used in Chinese kinds is of vegetable origin.

*Logwood Ink.*—Under the name of chrome ink a black ink was discovered by Runge, which held out the promise of cheapness combined with many excellent qualities. It is prepared by dissolving 15 parts of extract of logwood in 900 parts of water, to which 4 parts of crystallized sodium carbonate are added. A further solution of 1 part of potassium chromate (not bichromate) in 100 parts of water is prepared, and is added very gradually to the other solution with constant agitation. The ink so obtained possesses an intense blue-black colour, flows freely and dries readily, is neutral in reaction and hence does not corrode steel pens, and adheres to and sinks into paper so that manuscripts written with it may be freely washed with a sponge without danger of smearing or spreading. It forms a good copying ink, and it possesses all the qualities essential to the best ink; but on exposure to air it very readily undergoes decomposition, the colouring matter separating in broad flakes, which swim in a clear menstruum. It is affirmed by Vietd that this drawback may be overcome by the use of soda, a method first suggested by Böttger.

Logwood forms the principal ingredient in various other black inks used, especially as copying ink. A very strong decoction of logwood or a strong solution of the extract with ammonium-alum yields a violet ink which darkens slowly on exposure. Such an ink is costly, on account of the concentrated condition in which the logwood must be used. If, however, a metallic salt is introduced, a serviceable ink is obtained with the expenditure of much less logwood. Either sulphate of copper or sulphate of iron may be used, but the former, which produces a pleasing blue-black colour, is to be preferred. The following is the formula most highly recommended for this ink. A clear solution of 20 kilos of extract of logwood in 200 litres of water is obtained, to which is added, with agitation, 10 kilos of ammonium-alum dissolved in 20 litres of boiling water. The solution is acidified with 2 kilo of sulphuric acid, which has the effect of preventing any deposit, and finally there is added a solution of 1.5 kilos of sulphate of copper dissolved in 20 litres of water. This compound is exposed to the air for a few days to allow the colour to develop by oxidation, after which it is stored in well-corked bottles. The acid condition of this ink has a corrosive influence on steel pens; in all other respects it is a most valuable writing fluid.

*Aniline Inks.*—Solutions of aniline dye-stuffs in water are widely used as inks, especially coloured varieties. They are usually fugitive. Nigrosine is a black ink, which, although not producing a black so intense as common ink, possesses various advantages. Being perfectly neutral, it does not attack pens; it can easily be kept of a proper consistency by making up with water; and its colour is not injuriously affected by the

action of acids. Its ready flow from stylographic pens led to the name "stylographic ink." Other aniline inks are mentioned below.

*Copying Ink.*—Ink which yields by means of pressure an impression, on a sheet of damped tissue paper, of characters written in it is called copying ink. Any ink soluble in water, or which retains a certain degree of solubility, may be used as copying ink. Runge's chrome ink, being a soluble compound, is, therefore, so available; and the other logwood inks as well as the ordinary ferrous gallate inks contain also soluble constituents, and are essentially soluble till they are oxidized in and on the paper after exposure to the air. To render these available as copying inks it is necessary to add to them a substance which will retard the oxidizing effect of the air for some time. For this purpose the bodies most serviceable are gum arabic or senegal, with glycerin, dextrin or sugar, which last, however, renders the ink sticky. These substances act by forming a kind of glaze or varnish over the surface of the ink which excludes the air. At the same time when the damp sheet of tissue paper is applied to the writing, they dissolve and allow a portion of the yet soluble ink to be absorbed by the moistened tissue. As copying ink has to yield two or more impressions, it is necessary that it should be made stronger, i.e. that it should contain more pigment or body than common ink. It, therefore, is prepared with from 30 to 40% less of water than non-copying kinds; but otherwise, except in the presence of the ingredients above mentioned, the inks are the same. Copying ink pencils consist of a base of graphite and kaolin impregnated with a very strong solution of an aniline colour, pressed into sticks and dried.

*Red Ink.*—The pigment most commonly employed as the basis of red ink is Brazil-wood. Such an ink is prepared by adding to a strong decoction of the wood a proportion of stannous chloride (tin spirits), and thickening the resulting fluid with gum arabic. In some instances alum and cream of tartar are used instead of the stannous chloride. Cochineal is also employed as the tinctorial basis of red ink; but, while the resulting fluid is much more brilliant than that obtained from Brazil-wood, it is not so permanent. A very brilliant red ink may be prepared by dissolving carmine in a solution of ammonia, but this preparation must be kept in closely stoppered bottles. A useful red ink may also be made by dissolving the rosin of Brook, Simpson and Spiller in water, in the proportion of 1 to from 150 to 200 parts.

*Blue Ink.*—For the production of blue ink the pigment principally used is Prussian blue. It is first digested for two or three days with either strong hydrochloric acid, sulphuric acid or nitric acid, the digested mass is next very largely diluted with water, and after settling the supernatant liquid is siphoned away from the sediment. This sediment is repeatedly washed, till all traces of iron and free acid disappear from the water used, after which it is dried and mixed with oxalic acid in the proportion of 8 parts of Prussian blue to 1 of the acid, and in this condition the material is ready for dissolving in water to the degree of colour intensity necessary. An aniline blue ink may be prepared by dissolving 1 part of bleu de Paris in from 200 to 250 parts of water.

*Marking Ink.*—The ink so called, used principally for marking linen, is composed of a salt of silver, usually the nitrate, dissolved in water and ammonia, with a little provisional colouring matter and gum for thickening. The colour resulting from the silver salt is developed by heat and light; and the stain it makes, although exceedingly obstinate, gradually becomes a faint brownish-yellow. The following yields a good marking ink. Equal parts of nitrate of silver and dry tartaric acid are triturated in a mortar, and treated with water, when a reaction takes place, resulting in the formation of tartrate of silver and the liberation of nitric acid. The acid is neutralized, and at the same time the silver tartrate is dissolved by the addition of ammonia, and this solution with colouring matter and gum forms the ink, which may be used with an ordinary steel pen.

Many vegetable juices, e.g. of *Coriaria thymifolia*, *Semecarpus*

*macardium*, *Anacardium occidentale* (Cashew), are inks of this type.

Gold and silver inks are writing fluids in which gold and silver, or imitations of these metals, are suspended in a state of fine division. In place of gold, Dutch leaf or mosaic gold is frequently substituted, and bronze powders are used for preparing a similar kind of ink. The metallic foil is first carefully triturated into a fine paste with honey, after which it is boiled in water containing a little alkali, and then repeatedly washed in hot water and dried at a gentle heat. A solution is prepared consisting of 1 part of pure gum arabic and 1 part of soluble potash glass in 4 parts of distilled water, into which the requisite quantity of the metallic powder prepared is introduced. Owing to the superior covering nature of pure gold, less of the metal is required than is necessary in the case of silver and other foils. In general 1 part of foil to 3 or 4 parts of solution is sufficient. The metallic lustre of writing done with this solution may be greatly heightened by gently polishing with a burnishing point. Another gold ink depends upon the formation of purple of Cassius; the linen is mordanted with stannous chloride, and the gold applied as a gummy solution of the chloride.

*Indelible or incorrodible ink* is the name given to various combinations of lamp-black or other carbonaceous material with resinous substances used for writing which is exposed to the weather or to the action of strong acids or alkaline solutions. An ink having great resisting powers may be conveniently prepared by rubbing down Indian ink in common ink till the mixture flows easily from the pen. Other combinations have more the character of coloured varnishes.

*Sympathetic inks* are preparations used for forming characters which only become visible on the application of heat or of some chemical reagent. Many chemicals which form in themselves colourless solutions, but which develop colour under the influence of reagents, may be used as sympathetic ink, but they are of little practical utility. Characters written in a weak solution of galls develop a dark colour on being treated with a solution of copperas; or, vice versa, the writing may be done in copperas and developed by the galls solution. Writing done in various preparations develops colour on heating which fades as the paper cools. Among such substances are solutions of the chlorides of cobalt and of nickel. Very dilute solutions of the mineral acids and of common salt and a solution of equal parts of sulphate of copper and sal-ammoniac act similarly. Writing with rice water and developing with iodine was a device much used during the Indian Mutiny.

*Printing Inks.*—Printing inks are essentially mixtures of a pigment and a varnish. The varnish is prepared from linseed oil, rosin and soap; the oil must be as old as possible; the rosin may be black or amber; and the soap, which is indispensable since it causes the ink to adhere uniformly to the type and also to leave the type clean after taking an impression, is yellow, or turpentine soap for dark inks, and curd soap for light inks. The varnish is prepared as follows: The oil is carefully heated until it "strings" properly, i.e. a drop removed from the vessel on a rod, when placed upon a plate and the rod drawn away, forms a thread about  $\frac{1}{2}$  in. long. The rosin is carefully and slowly added and the mixture well stirred. The soap is then stirred in. The ink is prepared by mixing the varnish with the pigment, and grinding the mass to impalpable fineness either in a levigating mill or by a stone and muller. For black ink, lamp-black mixed with a little indigo or Prussian blue is the pigment employed; for wood engravings it may be mixed with ivory black, and for copper plates with ivory or Frankfurt black; for lithographic reproductions Paris black is used. Red inks are made with carmine or cochineal; red lead is used in cheap inks, but it rapidly blackens. Blue inks are made with indigo or Prussian blue; yellow with lead chromate or yellow ochre; green is made by mixing yellow and blue; and purple by mixing red and blue.

See C. A. Mitchell and T. C. Hepworth, *Inks, their Composition and Manufacture* (1904); S. Lehner, *Ink Manufacture* (1902); A. F. Gouillon, *Encres et cirages* (1906); L. E. Anklès, *Schreib-, Kopier- und andere Tinten* (1906).

**INKERMAN, BATTLE OF**, fought on the 5th of November 1854 between a portion of the Allied English and French army besieging Sevastopol and a Russian army under Prince Menshikov (see CRIMEAN WAR). This battle derives its name from a ruin on the northern bank of the river Tchernaya near its mouth, but it was fought some distance away, on a nameless ridge (styled Mount Inkerman after the event) between the Tchernaya and the Careenage Ravine, which latter marked the right of the siegeworks directed against Sevastopol itself. Part of this ridge, called Home Ridge and culminating in a knoll, was occupied by the British, while farther to the south, facing the battleground of Balaklava, a corps under General Bosquet was posted to cover the rear of the besiegers against attacks from the direction of Traktir Bridge. The Russians arranged for a combined attack on

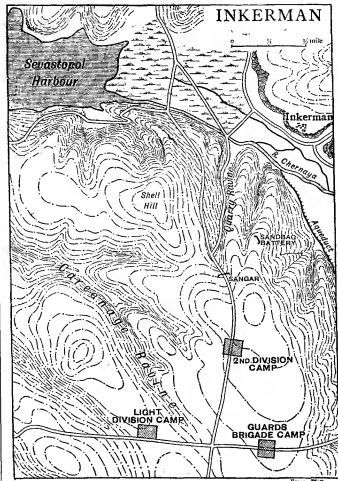

the ridge above-mentioned by part of Menshikov's army (16,000) and a corps (19,000) that was to issue from Sevastopol. This attack was to have, beside its own field artillery, the support of fifty-four heavy guns, and the Russian left wing on the Balaklava battleground was to keep Bosquet occupied. If successful, the attack on the ridge was to be the signal for a general attack all along the line. It was apparently intended by Menshikov that the column from the field army should attack the position from the north, and that the Sevastopol column should advance along the west side of the Careenage Ravine. But he only appointed a commander to take charge of both columns at the last moment, and the want of a clear understanding as to what was to be done militated against success from the first. General Soimonov, with the Sevastopol column, after assembling his troops before dawn on the 5th, led them on to the upland east of Careenage Ravine, while the field army column, under General Pavlov, crossed the Tchernaya near its mouth, almost at right angles to Soimonov's line of advance.

The British troops on or near the ground were the 2nd Division, 3000, encamped on the ridge; Codrington's brigade of the Light Division, 1400, on the slopes west of the Careenage Ravine; and the Guards' brigade, 1350, about  $\frac{1}{4}$  m. in rear of the 2nd Division camp. No other forces, French or British, were within 2 m. except another part of Sir George Brown's Light Division. A mist overhung the field and the hillsides were slippery with mud. Soimonov, with his whole force deployed in a normal attack formation (three lines of battalion columns covered by a few hundred skirmishers) pushed forward along the ridge (6 A.M.) without waiting for Pavlov or for Dannenberg, the officer appointed to command the whole force. Shell Hill, guarded only by a picquet, was seized at once. The heavy guns that had been brought from the fortress were placed in position on this hill, and opened fire (7 A.M.) on the knoll, 1400 yds. to the S., behind which the 2nd Division was encamped. The Russian infantry halted for the guns to prepare the way, and the heavy projectiles both swept the crest of the British knoll and destroyed the camp in rear. But already General Pennefather, commanding the division, had pushed forward one body of his infantry after another down the forward slope, near the foot of which they encountered the Russians in great force. On his side, Soimonov had been compelled to break up his regular lines of columns at the narrowest part of the ridge and to push his battalions forward a few at a time. This and the broken character of the ground made the battle even in the beginning a *mélée*. The obscurity of the mist, which had at first allowed the big battalions to approach unobserved, now favoured the weaker side. Soimonov himself, however, formed up some 9000 men, who drove back the British left wing—for the whole of Pennefather's force at the time was no more than 3600 men. But the right wing, not as yet attacked, either by Soimonov or by Pavlov, held on to its positions on the forward slope, and a column of Russian sailors and marines, who had been placed under Soimonov's command and had moved up the Careenage Ravine to turn the British left, were caught, just as they emerged on to the plateau in rear of Pennefather's line, between two bodies of British troops hurrying to the scene of action. On the front, too, the Russian attack came to a standstill and ebbed, for Soimonov's overcrowded battalions jostled one another and dissolved on the narrow and broken plateau. Soimonov himself was killed, and the disciplined confidence and steady volleys of the defenders dominated the chaotic *élan* of the Russians. Thus 3300 defenders were able to repulse and even to "expunge from the battlefield" the whole of the Sevastopol column, except that portion of it which drifted away to its left and joined Pavlov. This stage of the battle had lasted about forty minutes. But, brilliant as was this overtone, it is the second stage of the battle that gives it its epic interest.

The first attack made by Pavlov's advanced guard, aided by parts of Soimonov's corps, was relatively slight, but General Dannenberg now arrived on the field, and arranged for an assault on the British centre and right, to be delivered by 10,000 men (half his intact forces) chiefly by way of the Quarry Ravine, the attack to be prepared by the guns on Shell Hill. Pennefather had been reinforced by the Guards' brigade and a few smaller units. Not the least extraordinary feature of the battle that followed is the part played by a sangar of stones at the head of Quarry Ravine and a small battery, called the Sandbag Battery, made as a temporary emplacement for two heavy guns a few days before. The guns had done their work and been sent back whence they came. Nevertheless these two insignificant works, as points to hold and lines to defend on an otherwise featureless battlefield, became the centres of gravity of the battle.

The sangar at first fell into the hands of the Russians, but they were soon ejected, and small British detachments reoccupied and held it, while the various Russian attacks flowed up and past it and ebbed back into the Quarry Ravine. Possession of the Sandbag Battery was far more fiercely contested. The right wing was defended by some 700 men of the 2nd Division, who were reinforced by 1,300 of the Guards. The line of defence adjacent

to the battery looked downhill for about 300 yds., giving a clear field of fire for the new Enfield rifle the English carried; but a sharp break in the slope beyond that range gave the assailants plenty of "dead ground" on which to form up. For a time, therefore, the battle was a series of attacks, delivered with great fierceness by the main body of Pavlov's corps, the repulse of each being followed by the disappearance of the assailants. But the arrival of part of the British 4th Division under Sir George Cathcart gave the impulse for a counter-attack. Most of the division indeed had to be used to patch up the weaker parts of the line, but Cathcart himself with about 400 men worked his way along the lower and steeper part of the eastern slope so as to take the assailants of the battery in flank. He had not proceeded far, however, when a body of Russians moving higher up descended upon the small British corps and scattered it, Cathcart himself being killed. Other counter-strokes that his arrival had inspired were at the same time made from different parts of the defensive front, and had the effect of breaking up what was a solid line into a number of disconnected bands, each fighting for its life in the midst of the enemy. The crest of the position was laid open and parts of the Russian right wing seized it. But they were flung back to the lower slopes of the Quarry Ravine by the leading French regiment sent by Bosquet. This regiment was quickly followed by others. The last great assault was delivered with more precision, if with less fury than the others, and had Dannenberg chosen to employ the 9000 bayonets of his reserve, who stood idle throughout the day, to support the 6000 half-spent troops who made the attack, it would probably have been successful.

As it was, supported by the heavy guns on Shell Hill, the assailants, though no longer more than slightly superior in numbers, carried not only the sangar, but part of the crest line of the allied position. But they were driven back into the Quarry Ravine, and, relieving the exhausted British, the French took up the defence along the edge of the ravine, which, though still not without severe fighting, they maintained till the close of the battle. Inkerman, however, was not a drawn battle. The allied field artillery, reinforced by two long 18-pr. guns of the British siege train and assisted by the bold advance of two French horse-artillery batteries which galloped down the forward slope and engaged the Russians at close range, gained the upper hand. Last of all, the dominant guns on Shell Hill thus silenced, the resolute advance of a handful of British infantry decided the day, and the Russians retreated. The final shots were fired about 1.30 P.M.

The total British force engaged was 8500, of whom 2357 were killed and wounded. The French lost 939 out of about 7000 who came on to the field, though not all these were engaged. The Russians are said to have lost 11,000 out of about 42,000 present. The percentage (27.7) of loss sustained by the British is sufficient evidence of the intensity of the conflict, and provides a convincing answer to certain writers who have represented the battle as chiefly a French affair. On the other hand, the reproaches addressed by some British writers to General Bosquet for not promptly supporting the troops at Inkerman with his whole strength are equally unjustifiable, for apparently Sir George Brown and Sir George Cathcart both declined his first offers of support, and he had Prince Gorchakov with at least 20,000 Russians in his own immediate front. He would therefore have risked the failure of his own mission in order to take part in a battle where his intervention was not, so far as he could tell, of vital importance. When Lord Raglan definitely asked him for support, he gave it willingly and eagerly, sending his troops up to the double, and it must be remembered that several British divisions took no part in the action for the same reason that actuated Bosquet. But, in spite of the seemingly inevitable controversies attendant on an "allied" battle, it is now generally admitted that, as a "soldiers' battle," Inkerman is scarcely to be surpassed in modern history.

**INLAYING**, a method of ornamentation, by incrusting or otherwise inserting in one material a substance or substances differing therefrom in colour or nature. The art is practised in the fabrication of furniture and artistic objects in all varieties of wood, metal, shell, ivory and coloured and hard stone, and in compound substances; and the combinations, styles and varieties of effect are exceedingly numerous. Several special classes of inlaying may be here enumerated and defined, details

regarding most of which will be found under their separate headings. In the ornamental treatment of metal surfaces *Niello* decoration, applied to silver and gold, is an ancient and much-practised species of inlaying. It consists in filling up engraved designs with a composition of silver, copper, lead and sulphur incorporated by heat. The composition is black, and the finished work has the appearance of a drawing in black on a metallic plate. An art, analogous in effect, called *bidri*, from Bidler in the Deccan, is practised in India. In *bidri* work the ground is an alloy of zinc, with small proportions of copper and lead, in which shallow patterns and devices are traced, and filled up with thin plates of silver. When the surface has been evened and smoothed, the *bidri* ground is stained a permanent black by a paste the chief ingredients of which are sal-ammoniac and nitre, leaving a pleasing contrast of bright metallic silver in a dead black ground. The inlaying of gold wire in iron or steel is known as **DAMASCENING** (*q.v.*). It has been very largely practised in Persia and India for the ornamentation of arms and armour, being known in the latter country as *Kuft* work or *Kuftgari*. In Kashmir, vessels of copper and brass are very effectively inlaid with tin—an art which, like many other decorative arts, appears to have originated in Persia. In the ornamental inlaying of metal surfaces the Japanese display the most extraordinary skill and perfection of workmanship. In the inlaying of their fine bronzes they use principally gold and silver, but for large articles and also for common cast hollow ware commoner metals and alloys are employed. In inlaying bronzes they generally hollow out and somewhat undercut the design, into which the ornamenting metal, usually in the form of wire, is laid and hammered over. Frequently the lacquer work of the Japanese is inlaid with mother-of-pearl and other substances, in the same manner as is practised in ornamenting lacquered *papier-mâché* among Western communities. The Japanese also practise the various methods of inlaying referred to under **DAMASCENING**. The term *Mosaic* (*q.v.*) is generally applied to inlaid work in hard stones, marble and glass, but the most important class of mosaics—those which consist of innumerable small separate pieces—do not properly come under the head of inlaying. Inlaid mosaics are those in which coloured designs are inserted in spaces cut in a solid ground or basis, such as the modern Florentine mosaic, which consists of thin veneers of precious coloured stones set in slabs of marble. The Taj Mahal at Agra is an example of inlaid mosaic in white marble, and the art, carried to that city by a French artist, is still practised by native workmen. *Pietra dura* is a fine variety of inlaid mosaic in which hard and expensive stones—agate, cornelian, amethyst and the like—are used in relief. Certain kinds of enamel might also be included among the varieties of inlaying. (See also **MARQUETRY** and **BOMBAY FURNITURE**.)

**INMAN, HENRY** (1801–1846), American artist, was born in Utica, New York, on the 20th of October 1801. Apprenticed to the painter John W. Jarvis at the age of fourteen, he left him after seven years and set up for himself, painting portraits, genre and landscape. He was one of the organizers of the National Academy of Design in New York and its first vice-president (from 1826 until 1832). As a portrait painter he was highly successful both in New York and Philadelphia, and going to England in 1844, he had for sitters the Lord Chancellor (Cottenham), the poet Wordsworth, Doctor Chalmers, Lord Macaulay and others. His American sitters included President Van Buren and Chief Justice Marshall. He died in New York City on the 17th of January 1846.

**INN**, a river of Europe, an important right bank tributary of the Danube. It rises at an elevation of 7800 ft., in a small lake under the Piz Longhino, in the Swiss canton of the Grisons. After flowing for a distance of 55 m., through the Engadine it leaves Swiss territory at Martinsbruck and enters Austria. It next plunges through the deep ravine of Finstermünz, and, continuing in the main a north-easterly direction, receives at Landeck the Rosanna. Hence its course becomes more rapid, until, after swirling through the narrow and romantic

Oberinntal, it enters the broader and pastoral Unterinntal. It next passes Innsbruck and from Hall, a few miles lower down, begins to be navigable for barges. At Kufstein, down to which point it has still pursued a north-easterly direction, it breaks through the north Tirol limestone formation, and, now keeping a northerly course, enters at Rosenheim the Bavarian high plateau. Its bed is now broad, studded with islands and enclosed by high banks. Its chief tributaries on this last portion of its course are the Alz and the Salzach, and at Passau, 309 m. from its source, it joins the Danube, which river down to that point it equals in length and far exceeds in volume of water. Its rapid current does not permit of extensive navigation, but timber rafts are floated down from above Innsbruck.

See Greinz, *Eine Wanderung durch das Unterinntal* (Stuttgart, 1902).

**INN** and **INNKEEPER**. An inn is a house where travellers are fed and lodged for reward. A distinction has been drawn between tavern, inn and hotel, the tavern supplying food and drink, the hotel lodging, the inn both; but this is fanciful. "Hotel" now means "inn," and "inn" is often applied to a mere public-house, whilst "tavern" is less used. "Inn," still the legal and best, as it is the oldest, is a form of the word "in" or "within." This sense is retained in the case of the English legal societies still known as **INNS OF COURT** (*q.v.*). In the Bible "inn" means "lodging-place for the night." Hospitality has always been a sacred duty in the East. The pilgrim or the traveller claims it as a right. But some routes were crowded, as that from Bagdad to Babylon. On these, *khan*s (in or near a town) and *caravanserais* (in waste places) were erected at the expense of the benevolent. They consisted of a square building surrounded by a high wall; on the roof there was a terrace and over the gateway a tower; inside, was a large court surrounded by compartments in which was some rude provision for the animals and baggage of the traveller as well as for himself. The latter purchased his own food where he chose, and had to "do for himself." In some such place Jesus was born. Tavern is mentioned once in Scripture (Acts xviii. 15) where it is said the brethren from Rome met Paul at "the Three Taverns." This was a station on the Appian Way, referred to also in Cicero's *Letters* (*Ad Att.* ii. 12). So, in modern London, stations are called "Elephant and Castle," or "Bricklayers' Arms," from adjacent houses of entertainment. Among the Greeks inns and innkeepers were held in low repute. The houses were bad and those who kept them had a bad name. A self-respecting Greek entered them as seldom as possible; if he travelled he relied on the hospitality of friends. In Rome under the emperors something akin to the modern inn grew up. There is, however, scarcely any mention of such institutions in the capital as distinguished from mere wine-shops or eating-houses. Ambassadors were lodged in apartments at the expense of the state. But along the great roads that radiated from Rome there were inns. Horace's account of his journey to Brundisium (*Sat.* i. 5), that brilliant picture of contemporary travel, tells us of their existence, and the very name of the Three Taverns shows that there was sufficient custom to support a knot of these institutions at one place. Under the Roman law, the innkeeper was answerable for the property of his guests unless the damage was due to *damnum fatale* or *vis major*, in modern language the act of God or the king's enemies. He was also liable for damage done by his servant or his slave or other inhabitant of the house.

In the middle ages hospitality was still regarded as a duty, and provision for travellers was regularly made in the monasteries. People of rank were admitted to the house itself, others sought the guest-chamber, which sometimes stood (as at Battle Abbey) outside the precincts. It consisted of a hall, round which were sleeping-rooms, though the floor of the hall itself was often utilized. Again, hospitality was rarely denied at the castle or country house. The knight supped with his host at the dais or upper part of the great hall, and retired with him into his own apartment. His followers, or the meaner strangers, sat lower down at meat, and after the tables had been removed stretched themselves to rest upon the floor. In desolate parts hospices

were erected for the accommodation of pilgrims. Such existed in the Alps and on all the great roads to the Holy Land or to famous shrines, notably to that of Canterbury. The still impressive remains of the Travellers' Hospital at Maidstone, founded by Archbishop Boniface in 1260, give an idea of the extent of such places. The mention of Canterbury recalls two inns celebrated by Chaucer. The pilgrims started from the "Tabard" at Southwark under the charge of Harry Bailly the host, and they put up at the "Chequers of the Hope," in Mercery Lane, Canterbury. It is easy to infer that, as time went on, the meagre hospitality of the monastery or the hospice was not sufficient for an increasing middle class, and that the want was met by the development of the mere ale-house into the inn. The "ale-house," to give it the old English name, was always in evidence, and even in pre-Reformation days was a favourite subject for the satirist. In Langland's *Piers the Plowman* and in Skelton's *Elymour Rummyng* we have contemporary pictures of ale-houses of the 14th and 16th centuries, but the Tabard is quite a modern inn, with a *table d'hôte* supper, a sign, a landlord ("right a mery man") and a reckoning!

It has been conjectured (Larwood and Hotten, *History of Signboards*, 1874) that the inn sign was taken or imitated from that displayed on the town houses or inns of noblemen and prelates. The innkeeper alone of tradesmen retains his individual sign. The inn shared with the tavern the long projecting pole garnished with branches. These poles had become of such inordinate length in London that in 1375 they were restricted to 7 ft. But the inn of those times was still a simple affair. In each room there were several beds, the price of which the prudent traveller inquired beforehand. Extortion was frequent, though it was forbidden by a statute of Edward III. The fare was simple; bread, meat and beer, with fish on Fridays. The tavern sentiment is strong in Elizabethan literature. The "Boar's head" in Eastcheap is inseparably connected with Sir John Falstaff and Dame Quickly. "Shall I not take mine ease in mine Inn?" (1 Henry IV., Act iii. sc. 3) is well-nigh the most famous word of the famous knight. A passage in Holinshed's *Chronicle* (1587, i. 246) explains the inner meaning of this. He assures us that the inns of England are not as those of other lands. Abroad the guest is under the tyranny of the host, but in England your inn is as your own house; in your chamber you can do what you will, and the host is rather your servant than your master. The "Mermaid" in Bread Street is associated with the memory of many wits and poets—Raleigh, Shakespeare, Beaumont, Fletcher, Ben Jonson—who frequented it and praised it.

Shenstone's lines as to "the warmest welcome at an inn" vent a common but rather cheap cynicism. Doctor Johnson was a great frequenter of inns and was outspoken in praise and blame. In the time immediately preceding railways the inn, which was also a post-house where the public coach as well as that of the private traveller changed horses, was a place of much importance. We have it presented over and over again in the pages of Dickens. The "Maypole" in *Barnaby Rudge* may be singled out for mention; it survives at Chigwell, Essex, as the "King's Head."

The effect of railways was to multiply hotels in great centres and gradually increase their size till we have the huge structures so plentiful to-day. The bicycle and later the motor car, through the enormous traffic they caused on the country roads, have restored the old wayside inns to more than their former prosperity.

In Scotland a statute (1424) of James I. ordained inns for man and beast, with food and drink at reasonable prices, in each borough, and a subsequent act prohibited lodging in private houses in places where there were inns, under a penalty of 40s. But for centuries the Scots inn was a poor affair. The Clachan of Aberfoyle in *Rob Roy*, kept by the widow MacAlpine, was probably typical. In *St Ronan's Well* Scott gives the more pleasing picture of the Cleikum Inn, kept by the delightful Meg Dods, and mention should be made of St Mary's Cottage, with its hostess Tibby Shiels, the scene of one of the *Noctes Ambrosianae*, with memories not merely of Scott but of Christopher

North and the Ettrick Shepherd. Burns had much to do with inns and taverns. If Poosie Nancie's, where the Jolly Beggars held wild revel, is long vanished, the Globe at Dumfries still exists, a fair sample of an inn of the period. As late as 1841 Dickens, writing to John Foster during his first visit to Scotland, describes the Highland inns as very poor affairs, "a mere knot of little outhouses" he says of one; and even in Queen Victoria's *Leaves from the Journal of Our Life in the Highlands* the inn is described as invariably small and unassuming. Thus the development of hotels in Scotland did not begin much before the middle of the 19th century.

In America the first hotel mentioned in New York is "Kriger's Tavern" about 1642, replaced in 1703 by the "King's Arms." When the town came to be English a proclamation was issued regulating the inns. Meals were not to cost more than 8d. or beer 2d. per quart.

*Law Relating to Innkeepers.*—Whether any special building is an inn is a question of fact. A temperance hotel is an inn, but a mere public-house is not. An innkeeper is bound to receive, lodge and feed travellers if he has accommodation, if they are able and willing to pay, and are not obviously objectionable. If he refuse he is liable at common law to indictment, or an action will lie against him at the suit of the would-be guest. Under the Army Act soldiers of all kinds may be billeted on the innkeeper, even beyond his power to provide in his own house; he must find accommodation for them elsewhere. An innkeeper must keep the goods and chattels of his guest in safety, unless they are destroyed by the act of God or the king's enemies. Under this last the king's rebellious subjects are not included. He is not liable for goods stolen or destroyed by the companion of the guest or through the guest's own negligence. There are two theories as to the origin of this common law liability of the innkeeper: (1) it was a survival of the liability of the common trader, or (2) specially imposed from the nature of his calling. Old English law held him to some extent suspect. The traveller amongst strangers seemed forlorn and unprotected, and conspiracy with thieves was dreaded. In modern times the landlord's responsibilities were cut down by the Innkeepers Liability Act 1863. He is not liable (save for horses and other live animals with their gear and carriages) to a greater extent than £30, unless the loss is caused by the default or neglect of himself or his servants, or the goods have been formally deposited with him. He must conspicuously exhibit a copy of the material parts of the act. The innkeeper may contract himself out of his common law obligation, and, apart from negligence, he is not liable for injury to the person or clothes of his guest. In return for these responsibilities the law gives him a lien over his guest's goods till his bill be paid. This is a particular and not a general lien. It attaches only to the special goods brought by the guest to the inn, and housed by the innkeeper with him. When several guests go together, the lien extends to all their goods. The innkeeper is only bound to take ordinary care of goods thus held, but he cannot use them or charge for their house-room. By the custom of London and Exeter, "when a horse eats out the price of his head," namely, when the cost of keep exceeds value, the host may have him as his own. By the Innkeepers Act 1878, if goods have been kept for six weeks they may be advertised and then sold after the interval of a month. Although an advertisement in a London paper is directed, this act (it would seem) applies to Scotland (J.A. Fleming, in Green's *Encyclopaedia of the Law of Scotland*, vi. 363). In that country the law is generally the same as in England, though it has been held that the innkeeper is not responsible for loss by accidental fire. Nor is his refusal to receive a guest a criminal offence. In the United States the common law follows that of England, though laws of the various states have diminished the liability of the innkeeper in much the same fashion as in England. Innkeepers as retailers of intoxicating liquors are subject to the provisions of the Licensing Laws.

See Angus, *Bible Handbook* (new ed., 1904); Beckmann's *Inventions*, tr. by Johnson (1846); Jusserand, *Les Anglais au moyen âge* (1884); Liebenau, *Das Gasthof- und Wirtshauswesen der Schweiz*



in *alterer Zeit* (1891); Kempt, *Convivial Caledonia* (1893); F. W. Hackwood, *Inns, Ales and Drinking Customs of Old England* (1909); Jeff and Hurst, *The Law of Innkeepers* (1904). English and Roman law are compared in Pymar's *Law of Innkeepers* (1892). For Scots law, see Bell's *Principles*. An American treatise is S. H. Wandell, *Law of Inns, Hotels and Boarding Houses* (1888). (F. WA.)

**INNERLEITHEN**, a police burgh and health resort of Peebles-shire, Scotland, on Leithen Water, near its junction with the Tweed, 6½ m. S.E. of Peebles by the North British railway. Pop. (1901) 2181. In olden times it seems to have been known as Hornchuntersland, and to have been mentioned as early as 1159, when a son of Malcolm IV. (the Maiden) was drowned in a pool of the Tweed, close to Leithenfoot. Its chief industry is the manufacture of tweeds and fine yarns, which, together with the fame of its medicinal springs, brought the burgh into prominence towards the end of the 18th century. The spa, alleged to be the St Roman's well of Scott's novel of that name, has a pump-room, baths, &c. The saline waters are useful in minor cases of dyspepsia and liver complaints. The town is flanked on the W. by the hill fort of Caerlee (400 ft. long) and on the E. by that of the Firn (350 ft. long). Farther E., close to the village of Walkerburn, are Purvis Hill terraces, a remarkable series of earthen banks, from 50 ft. to more than 100 ft. wide, and with a length varying up to 900 ft., the origin and purpose of which are unknown. Traquair House, or Palace, on the right bank of the Tweed, is believed to be the oldest inhabited house in Scotland, the most ancient portion dating from the 10th century, and including a remnant of the castle. It was largely added to by Sir John Stewart, first earl of Traquair (d. 1659) and is a good example of the Scottish Baronial mansion with high-pitched roof and turreted angles. To the west of the house was the arbour which formed the "bush aboon Traquair" of the songs by Robert Crawford (d. 1733) and John Campbell Shairp, its site being indicated by a few birch trees. James Nicol (1769-1819), the poet, was minister of Traquair, and his son James Nicol (1810-1870), the geologist and professor of natural history in Aberdeen University, was born in the manse.

**INNESS, GEORGE** (1825-1894), American landscape painter, was born near Newburgh, N.Y., on the 1st of May 1825. Before he was five years of age his parents had moved to New York and afterwards to Newark, N.J., in which latter city his boyhood was passed. He would not "take education" at the town academy, nor was he a success as a greengrocer's boy. He had a strong bent towards art, and his parents finally placed him with a drawing-master named Barker. At sixteen he went to New York to study engraving, but soon returned to Newark, where he continued sketching and painting after his own initiative. In 1843 he was again in New York, and is said to have passed a month in Gignoux's studio. But he was too impetuous, too independent in thought, to accept teaching; and, besides, the knowledge of his teachers must have been limited. Practically he was self-taught, and always remained a student. In 1851 he went to Europe, and in Italy got his first glimpse of real art. He was there two years, and imbibed some traditions of the classic landscape. In 1854 he went to France, and there studied the Barbizon painters, whom he greatly admired, especially Daubigny and Rousseau. After his return to America he opened a studio in New York, then went to Medfield, Mass., where he resided for five years. A pastoral landscape near this town inspired the characteristic painting "The Medfield Meadows." Again he went abroad and spent six years in Europe. He came back to New York in 1876, and lived there, or near there, until the year of his death, which took place at Bridge of Allan on the 3rd of August 1894 while he was travelling in Scotland. He was a National Academician, a member of the Society of American Artists, and had received many honours at home and abroad. He was married twice, his son, George Inness (b. 1854), being also a painter. Inness was emphatically a man of temperament, of moods, enthusiasms, convictions. He was fond of speculation and experiment: in metaphysics and religion, as in poetry and art. Swedenborgianism, symbolism, socialism, appealed to him as they might to a mystic or an idealist. He aspired to the perfect unities, and was impatient of structural foundations. This was

his attitude towards painting. He sought the sentiment, the light, air, and colour of nature, but was put out by nature's forms. How to subordinate form without causing weakness was his problem, as it was Corot's. His early education gave him no great technical facility, so that he never was satisfied with his achievement. He worked over his pictures incessantly, retouching with paint, pencil, coal, ink—anything that would give the desired effect—yet never content with them. In his latter days it was almost impossible to get a picture away from him, and after his death his studio was found to be full of experimental canvases. He was a very uneven painter, and his experiments were not always successful. His was an original—a distinctly American—mind in art. Most of his American subjects were taken from New York state, New Jersey and New England. His point of view was his own. At his best he was often excellent in poetic sentiment, and superb in light, air and colour. He had several styles: at first he was somewhat grandiloquent in Roman scenes, but sombre in colour; then under French influence his brush grew looser, as in the "Grey Lowering Day"; finally he broke out in full colour and light, as in the "Niagara" and the last "Delaware Water-Gap." Some of his pictures are in American museums, but most of them are in private hands. (J. C. VAN D.)

**INNOCENT** (INNOCENTIUS), the name of thirteen popes and one anti-pope.

**INNOCENT I.**, pope from 402 to 417, was the son of Pope Anastasius I. It was during his papacy that the siege of Rome by Alaric (408) took place, when, according to a doubtful anecdote of Zosimus, the ravages of plague and famine were so frightful, and help seemed so far off, that papal permission was granted to sacrifice and pray to the heathen deities; the pope was, however, absent from Rome on a mission to Honorius at Ravenna at the time of the sack in 410. He lost no opportunity of maintaining and extending the authority of the Roman see as the ultimate resort for the settlement of all disputes; and his still extant communications to Victorius of Rouen, Exuperius of Toulouse, Alexander of Antioch and others, as well as his action on the appeal made to him by Chrysostom against Theophilus of Alexandria, show that opportunities of the kind were numerous and varied. He took a decided view on the Pelagian controversy, confirming the decisions of the synod of the province of pro-consular Africa held in Carthage in 416, which had been sent to him. He wrote in the same year in a similar sense to the fathers of the Numidian synod of Mileve who, Augustine being one of their number, had addressed him. Among his letters are one to Jerome and another to John, bishop of Jerusalem, regarding annoyances to which the first named had been subjected by the Pelagians at Bethlehem. He died on the 12th of March 417, and in the Roman Church is commemorated as a confessor along with Saints Nazarius, Celsus and Victor, martyrs, on the 28th of July. His successor was Zosimus.

**INNOCENT II.** (Gregorio Paparesci dei Guidoni), pope from 1130 to 1143, was originally a Benedictine monk. His ability, pure life and political connexions raised him rapidly to power. Made cardinal deacon of Sant Angelo in Pescheria by Paschal II. he was employed in various diplomatic missions. Calixtus II. appointed him one of the ambassadors who made peace with the Empire and drew up the Concordat of Worms (1122), and in the following year, with his later enemy Cardinal Peter Pierleoni, he was papal legate in France. On the 13th of February 1130 Honorius II. died, and on that night a minority of the Sacred College elected Paparesci, who took the name of Innocent II. After a hasty consecration he was forced to take refuge with a friendly noble by the faction of Pierleoni, who was elected pope under the name of Anacletus II. by a majority of the cardinals. Declaring that the cardinals had been intimidated, Innocent refused to recognize their choice; by June, however, he was obliged to flee to France. Here his title was recognized by a synod called by Bernard of Clairvaux at Étampes. Similar action was taken in Germany by the synod of Würzburg. In January 1131 Innocent held a personal interview with King Henry I. of England at Chartres, and in March, at Liège, with

the German King Lothair, whom he induced to undertake a campaign against Anacletus. The German army invaded Italy in August 1132, and occupied Rome, all except St Peter's church and the castle of St Angelo which held out against them. Lothair was crowned emperor at the Lateran in June 1133, and as a further reward Innocent gave him the territories of the Countess Mathilda as a fief, but refused to surrender the right of investiture. Left to himself Innocent again had to flee, this time to Pisa. Here he called a council which condemned Anacletus. A second expedition of Lothair expelled Roger of Sicily (to whom Anacletus had given the title of king in return for his support) from southern Italy, but a quarrel with Innocent prevented the emperor attacking Rome. At this crisis, in January 1138, Anacletus died, and a successor elected by his faction, as Victor IV., resigned after two months. The Lateran council of 1139 restored peace to the Church, excommunicating Roger of Sicily, against whom Innocent undertook an expedition which proved unsuccessful. In matters of doctrine the pope supported Bernard of Clairvaux in his prosecution of Abelard and Arnold of Brescia, whom he condemned as heretics. The remaining years of Innocent's life were taken up by a quarrel with the Roman commune, which had set up an independent senate, and one with King Louis VII. of France, about an appointment. France was threatened with the interdict, but before matters came to a head Innocent died on the 22nd of September 1143.

See Herzog-Hauck, *Realencyklopädie*, "Innocenz II.," with full references. Gregorovius, *History of Rome in the Middle Ages*, trans. by Hamilton (London, 1896), vol. iv. part. ii. pp. 420-453. (P. SM.)

INNOCENT III. (Lando da Sezza), antipope (1170-1180), sprang from a noble Lombard family. Opponents of Alexander III. tried to make him pope in September 1170. Alexander, however, bribed his partisans to give him up, and imprisoned him in the cloister of La Cava in January 1180.

INNOCENT III. (Lotario de' Conti di Segni), pope from 1198 to 1216, was the son of Trasimondo, count of Segni, and of Clarcia, a Roman lady of the noble family of Scotti, and was born at Anagni about 1160. His early education he received at Rome, whence he went to the university of Paris and subsequently to that of Bologna. At Paris, where he attended the lectures of Peter of Corbeil, he laid the foundations of his profound knowledge of the scholastic philosophy; at Bologna he acquired an equally profound knowledge of the canon and civil law. Thus distinguished by birth, intellect and attainments, on his return to Rome he rose rapidly in the church. He at once became a canon of St Peter's; he was made subdeacon of the Roman Church by Gregory VIII.; and in 1190 his uncle, Pope Clement III., created him cardinal-deacon of Santi Sergio e Baccho. The election of Celestine III. in the following year withdrew Lotario for a while from the active work of the Curia, the new pope belonging to the family of the Orsini, who were at feud with the Scotti. Lotario, however, employed his leisure in writing several works: *Mysteriorum evangelicæ legis ac sacramentorum eucharisticæ libri VI.*, *De contentu mundi, sive de miseria humanæ conditionis*, and *De quadrupartita specie nuptiarum*. Of these only the two first are extant; they are written in the scholastic style, a sea of quotations balanced and compared, and they witness at once to the writer's profound erudition and to the fact that his mind had not yet emancipated itself from the morbid tendencies characteristic of one aspect of mediæval thought. Yet Lotario was destined to be above all things a man of action, and, though his activities to the end were inspired by impracticable ideals, they were in their effects intensely practical; and Innocent III. is remembered, not as a great theologian, but as a great ruler and man of affairs.

On the 8th of January 1198 Celestine III. died, and on the same day Lotario, though not even a priest, was unanimously elected pope by the assembled cardinals. He took the name of Innocent III. On the 21st of February he was ordained priest, and on the 22nd consecrated bishop. Innocent was but thirty-seven years old at this time, and the vigour of youth, guided by a master mind, was soon apparent in the policy of the papacy.

His first acts were to restore the prestige of the Holy See in Italy, where it had been overshadowed by the power of the emperor Henry VI. As pope it was his object to shake off the imperial yoke, as an Italian prince to clear the land of the hated Germans. The circumstances of the time were highly favourable to him. The early death of Henry VI. (September 1197) had left Germany divided between rival candidates for the crown, Sicily torn by warring factions of native and German barons. It was, then, easy for Innocent to depose the imperial prefect in Rome itself and to oust the German feudatories who held the great Italian fiefs for the Empire. Spoleto fell; Perugia surrendered; Tuscany acknowledged the leadership of the pope; papal *rectores* once more governed the patrimony of St Peter. Finally, Henry's widow, Constance, in despair, acknowledged the pope as overlord of the two Sicilies, and on her death (November 27, 1198) appointed him guardian of her infant son Frederick. Thus in the first year of his pontificate Innocent had established himself as the protector of the Italian nation against foreign aggression, and had consolidated in the peninsula a secure basis on which to build up his world-power.

The effective assertion of this world-power is the characteristic feature of Innocent's pontificate. Other popes before him—from Gregory VII. onwards—had upheld the theory of the supremacy of the spiritual over the temporal authority, with various fortune; it was reserved for Innocent to make it a reality. The history of the processes by which he accomplished this is given elsewhere. Here it will suffice to deal with it in the broadest outline. In Germany his support of Otto IV. against Philip of Swabia, then of Philip against Otto and finally, after Philip's murder (June 21, 1208), of the young Frederick II. against Otto, effectually prevented the imperial power, during his pontificate, from again becoming a danger to that of the papacy in Italy. Concessions at the cost of the Empire in Italy were in every case the price of his support (see GERMANY: *History*). In his relations with the German emperors Innocent acted partly as pope, partly as an Italian prince; his victories over other and more distant potentates he won wholly in his spiritual capacity. Thus he forced the masterful Philip Augustus of France to put away Agnes of Meran and take back his Danish wife Ingeborg, whom he had wrongfully divorced; he compelled Peter of Aragon to forgo his intended marriage with Bianca of Navarre and ultimately (1204) to receive back his kingdom as a vassal of the Holy See; he forced Alphonso IX. of Leon to put away his wife Berengaria of Castile, who was related to him within the prohibited degrees, though he pronounced their children legitimate. Sancho of Portugal was compelled to pay the tribute promised by his father to Rome, and Ladislaus of Poland to cease from infringing the rights of the church. Even the distant north felt the weight of Innocent's power, and the archbishop of Trondhjem was called to order for daring to remove the ban of excommunication from the repentant King Haakon IV., as an infringement of the exclusive right of the pope to impose or remove the ban of the church in the case of sovereigns. So widespread was the prestige of the pope that Kaloyan, prince of Bulgaria, hoping to strengthen himself against internal feuds and the aggressions of the Eastern Empire, submitted to Rome and, in November 1204, received the insignia of royalty from the hands of the papal legates as the vassal of the Holy See.

Meanwhile Innocent had been zealous in promoting the crusade which ultimately, under the Doge Dandolo, led to the Latin occupation of Constantinople (see CRUSADES). This diversion from its original object was at first severely censured by Innocent; but an event which seemed to put an end to the schism of East and West came to wear a different aspect; he was the first pope to nominate a patriarch of Constantinople, and he expressed the hope that henceforth the church would be "one fold under one shepherd." By a bull of October 12, 1204, moreover, Innocent proclaimed the same indulgences for a crusade to Livonia as the Holy Land. The result was the "conversion" of the Livonians (1206) and the Letts (1208) by the crusaders headed by the knights of the Teutonic Order. The organization of the new provinces thus won for the church

Innocent kept in his own hands, instituting the new archbishopric of Riga and defining the respective jurisdictions of the archbishops and the Teutonic Knights, a process which, owing to the ignorance at Rome of the local geography, led to curious confusion.

Another crusade, horrible in its incidents and momentous in its consequences, was that proclaimed by Innocent in 1207 against the Albigenses. In this connexion all that can be said in his favour is that he acted from supreme conviction; that the heresies against which he appealed to the sword were really subversive of Christian civilization; and that he did not use force until for ten years he had tried all the arts of persuasion in vain (see ALBIGENSES).

Of all Innocent's triumphs, however, the greatest was his victory over King John of England. The quarrel between the pope and the English king arose out of a dispute as to the election to the vacant see of Canterbury, which Innocent had settled by nominating Stephen Langton over the heads of both candidates. John refusing to submit, Innocent imposed an interdict on the kingdom and threatened him with a crusade; and, to avert a worse fate, the English king not only consented to recognize Langton but also to hold England and Ireland as fiefs of the Holy See, subject to an annual tribute (May 1213). The submission was no idle form; for years the pope virtually ruled England through his legates (see ENGLISH HISTORY and JOHN, king of England). So great had the secular power of the papacy become that a Byzantine visitor to Rome declared Innocent to be "the successor not of Peter but of Constantine."

As in the affairs of the world at large, so also in those of the church itself, Innocent's authority exceeded that of all his predecessors. Under him the centralization of the ecclesiastical administration at Rome received a great impulse, and the independent jurisdiction of metropolitans and bishops was greatly curtailed. In carrying out this policy his unrivalled knowledge of the canon law gave him a great advantage. To his desire to organize the discipline of the church was due the most questionable of his expedients: the introduction of the system of provisions and reservations, by which he sought to bring the patronage of sees and benefices into his own hands—a system which led later to intolerable abuses.

The year before Innocent's death the twelfth ecumenical council assembled at the Lateran under his presidency. It was a wonderful proof at once of the world-power of the pope and of his undisputed personal ascendancy. It was attended by the plenipotentiaries of the emperor, of kings and of princes, and by some 1500 archbishops, bishops, abbots and other dignitaries. The business before it, the disciplining of heretics and Jews, and the proclamation of a new crusade, &c., vitally concerned the states represented; yet there was virtually no debate and the function of the great assembly was little more than to listen to and endorse the decretals read by the pope (see LATERAN COUNCILS). Shortly after this crowning exhibition of his power the great pope died on the 16th of July 1216.

Innocent III. is one of the greatest historical figures, both in the grandeur of his aims and the force of character which brought him so near to their realization. An appreciation of his work and personality will be found in the article PAPACY; here it will suffice to say that, whatever judgment posterity may have passed on his aims, opinion is united as to the purity of the motives that inspired them and the tireless self-devotion with which they were pursued. "I have no leisure," Innocent once sighed, "to meditate on supermundane things; scarce I can breathe. Yea, so much must I live for others, that almost I am a stranger to myself." Yet he preached frequently, both at Rome and on his journeys—many of his sermons, inspired by a high moral earnestness, have come down to us—and, towards the end of his life, he found time to write a pious exposition of the Psalms. His views on the papal supremacy are best explained in his own words. Writing to the patriarch of Constantinople (*Inn. III., lib. ii. ep. 200*) he says: "The Lord left to Peter the governance not of the church only but of the whole world;"

and again in his letter to King John of England (*ib. xvi. ep. 131*): "The King of Kings . . . so established the kingship and the priesthood in the church, that the kingship should be priestly, and the priesthood royal (*ut sacerdotale sit regnum et sacerdotium sit regale*), as is evident from the epistle of Peter and the law of Moses, setting one over all, whom he appointed his vicar on earth." In his answer to the ambassadors of Philip Augustus he states the premises from which this stupendous claim is logically developed:—

To princes power is given on earth, but to priests it is attributed also in heaven: to the former only over bodies, to the latter also over souls. Whence it follows that by so much as the soul is superior to the body, the priesthood is superior to the kingship. . . . Single rulers have single provinces, and single kings single kingdoms; but Peter, as in the plenitude, so in the extent of his power is pre-eminent over all, since he is the Vicar of Him whose is the earth and the fullness thereof, the whole wide world and all that dwell therein."

To the emperor of Constantinople, who quoted 1 Peter ii. 13, 14, to the contrary, he replied in perfect good faith that the apostle's admonition to obey "the king as supreme was addressed to lay folk and not to the clergy." The more intelligent laymen of the time were not convinced even when coerced. Even so pious a Catholic as the minnesinger Walther von der Vogelweide, giving voice to the indignation of German laymen, ascribed Innocent's claims, not to soundness of his scholastic logic, but to the fact that he was "too young" (*ovêr der babest ist wê junc*).

The literature on Innocent III. is very extensive; a carefully analysed bibliography will be found in Herzog-Hauck, *Realencyclopädie* (3rd ed., 1901) s. "Innocenz III." In A. Potthast, *Bibliotheca hist. med. ævi* (2nd ed., Berlin, 1896), p. 650, is a bibliography of the literature on Innocent's writings. In the *Corpus juris canonici*, ed. Aemilius Friedberg (Leipzig, 1881), vol. ii., pp. xiv-xvii., are lists of the official documents of Innocent III. excerpted in the *Decretales Gregorii IX.* The most important later works on Innocent III. are Achille Luchaire's *Innocent III., Rome et l'Italie* (Paris, 1904), *Innocent III., la croisade des Albigeois* (ib. 1905), *Innocent III., le pape et l'empire* (ib. 1906), *Innocent III., la question d'orient* (ib. 1906); *Innocent III., les revués ecclésiastiques du Saint-Siège* (ib. 1908); and *Innocent III., le concile de Lyon et la réforme de l'église* (1908); *Innocent the Great*, by C. H. C. Pirie-Gordon (London, 1907); is the only English monograph on this pope and contains some useful documents, but is otherwise of little value. See also H. H. Milman, *History of Latin Christianity*, vol. v.; F. Gregorovius, *Rome in the Middle Ages*, translated by A. Hamilton (1896), vol. v. pp. 5-110; J. C. L. Gieseler, *Ecclesiastical Hist.*, translated by J. W. Hull, vol. iii. (Edinburgh, 1853), which contains numerous excerpts from his letters, &c. Innocent's works are found in Migne, *Patrologiae Cursus Completus, Series Latina*, vols. ccxiv-ccxvii. For a translation of Innocent's answer to King John on the interdict, and John's surrender of England and Ireland to Innocent, see Gee and Hardy, *Documents illustrative of Church History* (London, 1896), pp. 73 et seq. (W. A. P.).

INNOCENT IV. (Sinibaldo Fiesco), pope 1243-1254, belonged to the noble Genoese family of the counts of Lavagna. Born at Genoa, he was educated under the care of his uncle Epizo, bishop of Parma. After taking orders at Parma, when he was made canon of the cathedral, he studied jurisprudence at Bologna. His first recorded appearance in political affairs was in 1218-1219, when he was associated with Cardinal Hugolinus (afterwards Gregory IX.) in negotiating a peace between Genoa and Pisa. This led to his rapid promotion. In 1223 Pope Honorius III. gave him a benefice in Parma, and in 1226 he was established at the curia as *auditor contradiclarum literarum* of the pope, a post he held also under Gregory IX., until promoted (1227) to be vice-chancellor of the Roman Church. In September of the same year he was created cardinal priest of San Lorenzo in Lucina. He was papal *rector* (governor) of the March of Ancona from 1235 to 1240. On the 25th of June 1243 he was elected pope by the cardinals assembled at Anagni.

Innocent was raised to the Holy See when it was at deadly feud with the emperor Frederick II., who lay under excommunication. Frederick at first greeted the elevation of a member of an imperialist family with joy; but it was soon clear that Innocent intended to carry on the traditions of his predecessors. Embassies and courtesies were, indeed, interchanged, and on the 31st of March 1244 a treaty was signed at Rome, whereby the emperor undertook to satisfy the pope's claims in return for his own abolition from the ban. Neither side, however,

was prepared to take the first steps to carry out the agreement, and Innocent, who had ventured back to Rome, began to feel unsafe in the city, where the imperial partisans had the ascendancy. Fearing a plan to kidnap him, he left Rome, ostensibly to meet the emperor, and from Sutri fled by night on horseback, pursued by 300 of the emperor's cavalry, to Civitavecchia, whence he took ship for Genoa and thence proceeded across the Alps to Lyons, at that time a merely nominal dependence of the Empire. Thence he wrote to the French king, Louis IX., asking for an asylum in France; but this Louis cautiously refused. Innocent, therefore, remained at Lyons, whence he issued a summons to a general council, before which he cited Frederick to appear in person, or by deputy. The council, which met on the 5th of June 1245, was attended only by those prepared to support the pope's cause; and though Frederick condescended to be represented by his justiciar, Thaddeus of Susseca, the judgment was a foregone conclusion. On the 17th of July Innocent formally renewed the sentence of excommunication on the emperor, and declared him deposed from the imperial throne and that of Naples. Frederick retorted by announcing his intention of reducing "the clergy, especially the highest, to a state of apostolic poverty," and by ordaining the severest punishments for those priests who should obey the papal sentence. Innocent thereupon proclaimed a crusade against the emperor and armed his ubiquitous agents, the Franciscan and Dominican friars, with special indulgences for all those who should take up the cross against the imperial heretic. At the same time he did all in his power to undermine Frederick's authority in Germany and Italy. In Naples he fomented a conspiracy among the feudal lords, who were discontented with the centralized government established under the auspices of Frederick's chancellor, Piero della Vigna. In Germany, at his instigation, the archbishops with a few of the secular nobles in 1246 elected Henry Raspe, landgrave of Thuringia, German king; but the "priests' king," as he was contemptuously called, died in the following year. William II., count of Holland, being after some delay elected by the papal party in his stead.

Innocent's relentless war against Frederick was not supported by the lay opinion of his time. In Germany, where it wrought havoc and misery, it increased the already bitter resentment against the priests. From England the pope's legate was driven by threats of personal violence. In France not even the saintly King Louis IX., who made several vain attempts to mediate, approved the pope's attitude; and the failure of the crusade which, in 1248, he led against the Mussulmans in Egypt, was, with reason, ascribed to the deflection of money and arms from this purpose to the war against the emperor. Even the clergy were by no means altogether on Innocent's side; the council of Lyons was attended by but 150 bishops, mainly French and Spanish, and the deputation from England, headed by Robert Grosseteste of Lincoln and Roger Bigod, came mainly in order to obtain the canonization of Edmund of Canterbury and to protest against papal exactions. Yet, for better or for worse, Innocent triumphed. His financial position was from the outset strong, for not only had he the revenue from the accustomed papal dues but he had also the support of the powerful religious orders; e.g. in November 1245 he visited the abbey of Cluny and was presented by the abbot with gifts, the value of which surprised even the papal officials. At first the war went in Frederick's favour; then came the capture of the strategically important city of Parma by papal partisans (June 16th, 1247). From this moment fortune changed. On the 18th of February 1248 Frederick's camp before Parma (the temporary town of Vittoria) was taken and sacked, the imperial insignia—of vast significance in those days—being captured. From this blow the emperor never recovered; and when on the 13th of December 1250 he died Innocent greeted the news by quoting from Psalm xvi. 11, "Let the heavens rejoice and let the earth be glad."

On the 10th of April 1251 Innocent left Lyons, which had suffered severely from his presence, and returned to Italy. He continued the struggle vigorously with Frederick's son and

successor, Conrad IV., who in 1252 descended into Italy, reduced the rebellious cities and claimed the imperial crown. Innocent, determined that the Hohenstaufen should not again dominate Italy, offered the crown of Sicily in turn to Richard of Cornwall, Charles of Anjou, and Henry III. of England, the last of whom accepted the doubtful gift for his son Edmund. Even after Conrad's capture of Naples Innocent remained inexorable; for he feared that Rome itself might fall into the hands of the German king. But fortune favoured him. On the 20th of May 1254 Conrad died, leaving his infant son Conradin, as Henry VI. had left Frederick II., under the pope's guardianship. Innocent accepted the charge and posed as the champion of the infant king. He held, indeed, to his bargain with Henry III. and, with all too characteristic nepotism, exercised his rights over the Sicilian kingdom by nominating his own relations to its most important offices. Finally, when Manfred, who by Frederick's will had been charged with the government of the two Sicilies, felt obliged to acknowledge the pope's suzerainty, Innocent threw off the mask, ignored Conradin's claims, and on the 24th of October formally asserted his own claims to Calabria and Sicily. He entered Naples on the 27th; but meanwhile Manfred had fled and had raised a considerable force; and the news of his initial successes against the papal troops reached Innocent as he lay sick and hastened his end. He died on the 7th of December 1254.

Innocent IV. is comparable to his greater predecessor Innocent III. mainly in the extreme assertion of the papal claims. "The emperor," he wrote, "doubts and denies that all men and all things are subject to the See of Rome. As if we who are judges of angels are not to give sentence on earthly things. . . . The ignorant assert that Constantine first gave temporal power to the See of Rome; it was already bestowed by Christ Himself, the true King and Priest, as inalienable from its nature and absolutely unconditional. Christ established not only a pontifical but a royal sovereignty (*principatus*) and committed to blessed Peter and his successors the empire both of earth and heaven, as is sufficiently proved by the plurality of the keys" (*Codex epist. Vatic.* No. 4057, 49, quoted in Raumer, *Hohenstaufen*, iv. 78). But this language, which in the mouth of Innocent III. had been consecrated by the greatness of his character and aims, was less impressive when it served as a cloak for an unlimited personal ambition and a family pride which displayed itself in unblushing nepotism. Yet in some respects Innocent IV. carried on the high traditions of his great predecessors. Thus he admonished Sancho II. of Portugal to turn from his evil courses and, when the king disobeyed, absolved the Portuguese from their allegiance, bestowing the crown on his brother Alphonso. He also established an ecclesiastical organization in the newly converted provinces of Prussia, which he divided into four dioceses; but his attempt to govern the Baltic countries through a legate broke on the opposition of the Teutonic Order, whose rights in Prussia he had confirmed.

It was Innocent IV. who, at the council of Lyons, first bestowed the red hat on the Roman cardinals, as a symbol of their readiness to shed their blood in the cause of the church.

Innocent was a canon lawyer of some eminence. His small work *De exceptionibus* was probably written by him because pope; but the *Apparatus in quinque libros decretalium*, which displays both practical sense and a remarkable mastery of the available materials, was written at Lyons immediately after the council. His *Apologeticus*, a defence of the papal claims against the Empire, written—as is supposed—in refutation of Piero della Vigna's argument in favour of the independence of the Empire, has been lost. Innocent was also a notable patron of learning; he encouraged Alexander of Hales to write his *Summa universae theologiae*, did much for the universities, notably the Sorbonne, and founded law schools at Rome and Piacenza.

Innocent's letters, the chief source for his life, are collected by E. Berger in *Les Registres d'Innocent IV.* (3 vols., Paris, 1884-1887). For English readers the account in Milman's *Latin Christianity*, vol. vi. (3rd ed., 1864) is still useful. Full references will be found in Herzog-Hauck, *Realencyklopädie*, vol. ix. (1901). (W. A. P.)

INNOCENT V. (Pierre de Champagni or de Tarentaise), pope from the 21st of January to the 22nd of June 1276, was born about 1225 in Savoy and entered the Dominican order at an early age. He studied theology under Thomas Aquinas, Albertus Magnus and Bonaventura, and in 1262 was elected provincial of his order in France. He was made archbishop of Lyons in 1271; cardinal-bishop of Ostia and Velletri, and grand penitentiary in 1275; and, partly through the influence of Charles of Anjou, was elected to succeed Gregory X. As pope he established peace between the republics of Luca and Pisa, and confirmed Charles of Anjou in his office of imperial vicar of Tuscany. He was seeking to carry out the Lyons agreement with the Eastern Church when he died. His successor was Adrian V. Innocent V., before he became pope, prepared, in conjunction with Albertus Magnus and Thomas Aquinas, a rule of studies for his order, which was accepted in June 1259. He was the author of several works in philosophy, theology and canon law, including commentaries on the Scriptures and on the Sentences of Peter Lombard, and is sometimes referred to as *famosissimus doctor*. He preached the funeral sermon at Lyons over St Bonaventura. His bulls are in the Turin collection (1559).

See F. Gregorovius, *Rome in the Middle Ages*, vol. 5, trans. by Mrs G. W. Hamilton (London, 1900-1902); A. Potthast, *Regesta pontific. Roman.* vol. ii. (Berlin, 1875); E. Bourgeois, *Le Bienheureux Innocent V.* (Paris, 1899); J. E. Borel, *Notice biogr. sur Pierre de Tarentaise* (Chambéry, 1890); P. J. Béthaz, *Pierre, ses Cours de la Salle, pape sous le nom Innocent V.* (Augustae, 1891); L. Carboin, *De Innocentio V. Romano pontifice* (1894). (C. H. HA.)

INNOCENT VI. (Étienne Aubert), pope from the 18th of December 1352 to the 12th of September 1362, was born at Mions in Liximous. He became professor of civil law at Toulouse and subsequently chief judge of the city. Having taken orders, he was raised to the see of Noyon and translated in 1340 to that of Clermont. In 1342 he was made cardinal-priest of St Giovanni e Paolo, and ten years later cardinal-bishop of Ostia and Velletri, grand penitentiary, and administrator of the bishopric of Avignon. On the death of Clement VI., the cardinals made a solemn agreement imposing obligations, mainly in favour of the college as a whole, on whichever of their number should be elected pope. Aubert was one of the minority who signed the agreement with the reservation that in so doing he would not violate any law, and was elected pope on this understanding; not long after his accession he declared the agreement null and void, as infringing the divinely-bestowed power of the papacy. Innocent was one of the best Avignon popes and filled with reforming zeal; he revoked the reservations and commendations of his predecessor and prohibited pluralities; urged upon the higher clergy the duty of residence in their sees, and diminished the luxury of the papal court. Largely through the influence of Petrarch, whom he called to Avignon, he released Cola di Rienzo, who had been sent a prisoner in August 1352 from Prague to Avignon, and used the latter to assist Cardinal Albornoz, vicar-general of the States of the Church, in tranquillizing Italy and restoring the papal power at Rome. Innocent used Charles IV. to be crowned emperor at Rome in 1355, but protested against the famous "Golden Bull" of the following year, which prohibited papal interference in German royal elections. He renewed the ban against Peter the Cruel of Castile, and interfered in vain against Peter IV. of Aragon. He made peace between Venice and Genoa, and in 1360 arranged the treaty of Breigny between France and England. In the last years of his pontificate he was busied with preparations for a crusade and for the reunion of Christendom, and sent to Constantinople the celebrated Carmelite monk, Peter Thomas, to negotiate with the claimants to the Greek throne. He instituted in 1354 the festival of the Holy Lance. Innocent was a strong and earnest man of monastic temperament, but not altogether free from nepotism. He was succeeded by Urban V.

The chief sources for the life of Innocent VI. are in Baluzius, *Vitae Pap. Avinion.* vol. i. (Paris, 1693); *Magnus bullariv. Roman.* vol. iv. (Turin, 1859); E. Werunsky, *Excerpta ex registris Clementis VI. et Innocentii VI.* (Innsbruck, 1885). See also L. Pastor, *History of the Popes*, vol. i, trans. by F. I. Antrobus (London,

1899); F. Gregorovius, *Rome in the Middle Ages*, vol. 6, trans. by Mrs G. W. Hamilton (London, 1900-1902); D. Cerri, *Innocenzo Papa VI* (Turin, 1873); J. B. Christophe, *Histoire de la papauté pendant le XIV<sup>e</sup> siècle*, vol. 2 (Paris, 1853); M. Souchon, *Die Papstwahl* (Brunswick, 1888); G. Daumet, *Innocent VI. et Blanche de Bourbon* (Paris, 1899); E. Werunsky, *Gesch. Kaiser Karls IV.* (Innsbruck, 1892). There is an excellent article by M. Naumann in Hauck's *Realencyclopädie*, 3rd ed. (C. H. HA.)

INNOCENT VII. (Cosimo dei Migliorati), pope from the 17th of October 1404 to the 6th of November 1406, was born of middle-class parentage at Sulmona in the Abruzzi in 1330. On account of his knowledge of civil and canon law, he was made papal vice-chamberlain and archbishop of Ravenna by Urban VI., and appointed by Boniface IX. cardinal priest of Sta Croce in Gerusalemme, bishop of Bologna, and papal legate to England. He was unanimously chosen to succeed Boniface, after each of the cardinals had solemnly bound himself to employ all lawful means for the restoration of the church's unity in the event of his election, and even, if necessary, to resign the papal dignity. The election was opposed at Rome by a considerable party, but peace was maintained by the aid of Ladislus of Naples, in return for which Innocent made a promise, inconsistent with his previous oath, not to come to terms with the antipope Benedict XIII., except on condition that he should recognize the claims of Ladislus to Naples. Innocent issued at the close of 1404 a summons for a general council to heal the schism, and it was not the pope's fault that the council never assembled, for the Romans rose in arms to secure an extension of their liberties, and finally maddened by the murder of some of their leaders by the pope's nephew, Ludovico dei Migliorati, they compelled Innocent to take refuge at Viterbo (6th of August 1405). The Romans, recognizing later the pope's innocence of the outrage, made their submission to him in January 1406. He returned to Rome in March, and, by bull of the 1st of September, restored the city's decayed university. Innocent was extolled by contemporaries as a lover of peace and honesty, but he was without energy, guilty of nepotism, and showed no favour to the proposal that he as well as the antipope should resign. He died on the 6th of November 1406 and was succeeded by Gregory XII.

See L. Pastor, *History of the Popes*, vol. i., trans. by F. I. Antrobus (London, 1899); M. Creighton, *History of the Papacy*, vol. i. (London, 1899); N. Vaisois, *La France et le grand schisme d'occident* (Paris, 1890-1902); Louis Gayet, *Le Grand Schisme d'occident* (Paris, 1898); J. Loserth, *Geschichte des späteren Mittelalters* (1903); Theodorici de Nymen, *De schismate libri tres*, ed. by G. Erler (Leipzig, 1890); K. I. von Hefele, *Conciliengeschichte*, Bd. 6, 2nd ed.; J. von Haller, *Papsttum u. Kirchenerneuerung* (Berlin, 1903). (C. H. HA.)

INNOCENT VIII. (Giovanni Battista Cibo), pope from the 20th of August 1484 to the 25th of July 1492, successor of Sixtus IV., was born at Genoa (1432), the son of Arano Cibo, who under Calixtus III. had been a senator of Rome. His youth, spent at the Neapolitan court, was far from blameless, and it is not certain that he was married to the mother of his numerous family. He later took orders, and, through the favour of Cardinal Calandrini, half-brother of Nicholas V., obtained from Paul II. the bishopric of Savona. Sixtus IV. translated him to the see of Molfetta, and in 1473 created him cardinal-priest of Sta Balbina, subsequently of Sta Cecilia. As pope, he addressed a fruitless summons to Christendom to unite in a crusade against the infidels, and concluded in 1489 a treaty with Bayezid II., agreeing in consideration of an annual payment of 40,000 ducats and the gift of the Holy Lance, to detain the sultan's fugitive brother Jen in close confinement in the Vatican. Innocent excommunicated and deposed Ferdinand, king of Naples, by bull of the 11th of September 1480, for refusal to pay the papal dues, and gave his kingdom to Charles VIII. of France, but in 1492 restored Ferdinand to favour. He declared (1486) Henry VII. to be lawful king of England by the threefold right of conquest, inheritance and popular choice, and approved his marriage with Elizabeth, the daughter of Edward IV. Innocent, like his predecessor, hated heresy, and in the bull *Summus desiderantes* (5th of December 1484) he instigated very severe measures against magicians and witches in Germany; he

prohibited (1486) on pain of excommunication the reading of the propositions of Pico della Mirandola; he appointed (1487) T. Torquemada to be grand inquisitor of Spain; and he offered plenary indulgence to all who would engage in a crusade against the Waldenses. He took the first steps towards the canonization of Queen Margaret of Scotland, and sent missionaries under Portuguese auspices to the Congo. An important event of his pontificate was the capture of Granada (2nd of January 1492), which was celebrated at Rome with great rejoicing and for which Innocent gave to Ferdinand of Aragon the title of "Catholic Majesty." Innocent was genial, skilled in flattery, and popular with the Romans, but he lacked talent and relied on the stronger will of Cardinal della Rovere, afterwards Julius II. His Curia was notoriously corrupt, and he himself openly practised nepotism in favour of his children, concerning whom the epigram is quoted: "Octo nocens pueros genitum, toidemque puellas:—Hunc merito poterit dicere Roma patrem." Thus he gave to his undeserving son Franceschetto several towns near Rome and married him to the daughter of Lorenzo de' Medici. Innocent died on the 25th of July 1492, and was succeeded by Alexander VI.

The sources for the life of Innocent VIII. are to be found in L. Muratori, *Rerum Italicarum Scriptores*, vol. 3, and in Raynaldus, a. 1484-1492. See also L. Pastor, *History of the Popes*, vol. 5, trans. by F. I. Antrobus (London, 1898); M. Creighton, *History of the Popes*, vol. 4 (London, 1901); F. Gregorovius, *Rome in the Middle Ages*, vol. 7, trans. by Mrs. G. W. Hamilton (London, 1900-1902); T. Hagen, *Die Papsstuehlen von 1484 u. 1492* (Brizen, 1885); S. Riezler, *Die Hexenprozesse* (1896); G. Viani, *Memorie della famiglia Cybo* (Pisa, 1808); F. Serdonati, *Vita e fatti d'Innocenzo VIII.* (Milan, 1829). (C. H. HA.)

INNOCENT IX. (Giovanni Antonio Fachinetti) was born in 1510. He filled the offices of apostolic vicar of Avignon, legate at the council of Trent, nuncio to Venice, and president of the Inquisition. He became cardinal in 1583; and under the invalid Gregory XIV. assumed almost the entire conduct of affairs. His election to the papacy, on the 20th of October 1591, was brought about by Philip II., who profited little by it, however, inasmuch as Innocent soon succumbed to age and feebleness, dying on the 30th of December 1591.

See Ciaconius, *Vitae et res gestae summorum Pontif. Rom.* (Rome, 1601-1602); Cicarella, continuator of Platina, *De Vitis Pontif. Rom.* (both contemporaries of Innocent); Ranke, *Popes* (Eng. trans., Austin), ii. 233 sq. (all brief accounts). (T. F. C.)

INNOCENT X. (Giovanni Battista Pamfilj) was born in Rome on the 6th of May 1574, served successively as auditor of the Rota, nuncio to Naples, legate apostolic to Spain, was made cardinal in 1627, and succeeded Urban VIII. as pope on the 15th of September 1644. Throughout his pontificate Innocent was completely dominated by his sister-in-law, Donna Olimpia Maidalchini, a woman of masculine spirit. There is no reason to credit the scandalous reports of an illicit attachment. Nevertheless, the influence of Donna Olimpia was baneful; and she made herself thoroughly detested for her inordinate ambition and rapacity. Urban VIII. had been French in his sympathies; but the papacy now shifted to the side of the Habsburgs, and there remained for nearly fifty years. Evidences of the change were numerous: Innocent promoted pro-Spanish cardinals; attacked the Barberini, protégés of Mazarin, and sequestered their possessions; aided in quieting an insurrection in Naples, fomented by the duke of Guise; and refused to recognize the independence of Portugal, then at war with Spain. As a reward he obtained from Spain and Naples the recognition of ecclesiastical immunity. In 1649 Castro, which Urban VIII. had failed to take, was wrested from the Farnese and annexed to the Papal States. The most worthy efforts of Innocent were directed to the reform of monastic discipline (1652). His condemnation of Jansenism (1653) was met with the denial of papal infallibility in matters of fact, and the controversy entered upon a new phase (see JANSENISM). Although the pontificate of Innocent witnessed the conversion of many Protestant princes, the most notable being Queen Christina of Sweden, the papacy had nevertheless suffered a perceptible decline in prestige; it counted for little in the negotiations at Münster, and its solemn protest against the peace of Westphalia was entirely ignored.

Innocent died on the 7th of January 1655, and was succeeded by Alexander VII.

For contemporary lives of Innocent see Oldoin, continuator of Ciaconius, *Vitae et res gestae summorum Pontif. Rom.*; and Palazzi, *Gesta Pontif. Rom.* (Venice, 1687-1688) iv. 570 sqq.; Ciampi's *Innoc. X. Pamfilj, et la sua Corte* (Rome, 1878), gives a very full account of the period. "Gualdus" (pseud. of Gregorio Leti); v. bibliog. note, art. "SIXTUS V.") *Vita de Donna Olimpia Maidalchina* (1666) is gossip and untrustworthy; Capranica's *Donna Olympia Pamfilj* (Milan, 1875, 3rd ed.) is fanciful and historically of no value. See also Ranke, *Popes* (Eng. trans., Austin), iii. 40 sqq.; v. Reumont, *Gesch. der Stadt Rom* iii. 2, p. 623 sqq.; Brosch, *Gesch. des Kirchenstaates* (1880) i. 409 sqq.; and the extended bibliography in Herzog-Hauck, *Realencyklopädie*, s.v. "Innocenz X." (T. F. C.)

INNOCENT XII. (Benedetto Odescalchi), pope from 1676 to 1689, was born at Como on the 16th of May 1611. He studied law in Rome and Naples, entered the Curia under Urban VIII. (his alleged military service seems to be questionable), and became successively protonotary, president of the Apostolic Chamber, governor of Macerata and commissary of Ancona. Innocent X. made him a cardinal (1647), legate to Ferrara, and, in 1650, bishop of Novara. His simple and blameless life, his conscientious discharge of duty, and his devotion to the needs of the poor had won for him such a name that, despite the opposition of France, he was chosen to succeed Clement X. on the 21st of September 1676. He at once applied himself to moral and administrative reform; declared against nepotism, introduced economy, abolished sinecures, wiped out the deficit (at the same time reducing rents), closed the gaming-houses, and issued a number of sumptuary ordinances. He held monks strictly to the performance of their vows; took care to satisfy himself of the fitness of candidates for bishoprics; enjoined regular catechetical instruction, greater simplicity in preaching, and greater reverence in worship. The moral teaching of the Jesuits incurred his condemnation (1676) (see LIGUORI), an act which the society never forgave, and which it partially revenged by forcing, through the Inquisition, the condemnation of the quietistic doctrines of Molinos (1687), for which Innocent entertained some sympathy (see MOLINOS).

The pontificate of Innocent fell within an important period in European politics, and he himself played no insignificant rôle. His protest against Louis XIV.'s extended claim to regalain rights called forth the famous Declaration of Gallican Liberties by a subservient French synod under the lead of Bossuet (1682), which the pope met by refusing to confirm Louis's clerical appointments. His determination to restrict the ambassadorial right of asylum, which had been grossly abused, was resented by Louis, who defied him in his own capital, seized the papal territory of Avignon, and talked loudly of a schism, without, however, shaking the pope in his resolution. The preponderance of France Innocent regarded as a menace to Europe. He opposed Louis's candidate for the electorate of Cologne (1688), approved the League of Augsburg, acquiesced in the designs of the Protestant William of Orange, even in his supplanting James II., whom, although a Roman Catholic, he distrusted as a tool of Louis. The great object of Innocent's desire was the repulse of the Turks, and his unremitting efforts to that end entitled him to share in the glory of relieving Vienna (1683).

Innocent died on the 12th of August 1689, lamented by his subjects. His character and life were such as to suggest the propriety of canonization, but hostile influences have defeated every move in that direction.

The life of Innocent has been frequently written. See Guarnacci, *Vitae et res gestae Pontif. Rom.* (Rome, 1751), i. 105 sqq.; Palazzi, *Gesta Pontif. Rom.* (Venice, 1690); also the lives by Albrizzi (Rome, 1693); Buonamici (Rome, 1776); and Imnich (Berlin, 1900). Particular phases of Innocent's activity have been treated by Michaud, *Louis XIV. et Innoc. XI.* (Paris, 1882 sqq., 4 vols.); Duboulet, *La Correspondance de Card. Carlo Pio*, &c. (see *Rev. des quest. hist.* lxxv. (1904) 602 sqq.); and Gerin, in *Rev. des quest. hist.*, 1876, 1878, 1886. For correspondence of Innocent see Colombo, *Notizie biogr. e lettere di P. Innoc. XI.* (Turin, 1878); and Berthier, *Innoc. PP. XI. Epp. ad Principes* (Rome, 1890 sqq.). An extended bibliography may be found in Herzog-Hauck, *Realencyklopädie*, s.v. "Innocenz XI." (T. F. C.)

**INNOCENT XII.** (Antonio Pignatelli), pope from 1691 to 1700 in succession to Alexander VIII., was born in Naples on the 13th of March 1615, was educated at the Jesuit College in Rome, entered upon his official career at the age of twenty, and became vice-legate of Urbino, governor of Perugia, and nuncio to Tuscany, to Poland and to Austria. He was made cardinal and archbishop of Naples by Innocent XI., whose pontificate he took as a model for his own, which began on the 12th of July 1691. Full of reforming zeal, he issued ordinances against begging, extravagance and gambling; forbade judges to accept presents from suitors; built new courts of justice; prohibited the sale of offices, maintaining the financial equilibrium by reducing expenses; and, an almost revolutionary step, struck at the root of nepotism, in a bull of 1692 ordaining that thenceforth no pope should grant estates, offices or revenues to any relative. Innocent likewise put an end to the strained relations that had existed between France and the Holy See for nearly fifty years. He adjusted the difficulties over the regalia, and obtained from the French bishops the virtual repudiation of the Declaration of Gallican Liberties. He confirmed the bull of Alexander VIII. against Jansenism (1696); and, in 1699, under pressure from Louis XIV., condemned certain of Fénelon's doctrines which Bossuet had denounced as quietistic (see FÉNELON). When the question of the Spanish succession was being agitated he advised Charles II. to make his will in favour of the duke of Anjou. Innocent died, on the eve of the great conflict, on the 27th of September 1700. Moderate, benevolent, just, Innocent was one of the best popes of the modern age.

See Guarnacci, *Vite et res gestae Pontific. Rom.* (Rome, 1751), i. 389 sqq.; Ranke, *Popes* (Eng. trans., Austin), iii. 186 sqq.; v. Reumont, *Gesch. der Stadt Rom.* iii. 2, p. 640 sqq.; and the *Bullarium Innoc. XII.* (Rome, 1697). (T. F. C.)

**INNOCENT XIII.** (Michele Angelo Conti), pope from 1721 to 1724, was the son of the duke of Poli, and a member of a family that had produced several popes, among them Innocent III., was born in Rome on the 13th of May 1655, served as nuncio in Switzerland, and, for a much longer time, in Portugal, was made cardinal and bishop of Osimo and Viterbo by Clement XI., whom he succeeded on the 8th of May 1721. One of his first acts was to invest the emperor Charles VI. with Naples (1722); but against the imperial investiture of Don Carlos with Parma and Piacenza he protested, albeit in vain. He recognized the Pretender, "James III.," and promised him subsidies conditional upon the re-establishment of Roman Catholicism in England. Moved by deep-seated distrust of the Jesuits and by their continued practice of "Accommodation," despite express papal prohibition (see CLEMENT XI.), Innocent forbade the Order to receive new members in China, and was said to have meditated its suppression. This encouraged the French Jansenist bishops to press for the revocation of the bull *Unigenitus*; but the pope commanded its unreserved acceptance. He weakly yielded to pressure and bestowed the cardinal's hat upon the corrupt and debauched Dubois. Innocent died on the 7th of March 1724, and was succeeded by Benedict XIII.

See Guarnacci, *Vite et res gestae Pontific. Rom.* (Rome, 1751), ii. 137 sqq.; 381 sqq.; Sandini, *Vite Pontific. Rom.* (Padua, 1739); M. v. Mayer, *Die Papstwahl Innocenz XIII.* (Vienna, 1874); Michaud, "La Fin du Clement XI. et le commencement du pontificat d'Innocent XIII." in the *Journal. Theol. Zeitschr.* v. 42 sqq., 304 sqq. (T. F. C.)

**INNOCENTS' DAY**, or **CHILDERMAS**, a festival celebrated in the Latin church on the 28th of December, and in the Greek church on the 20th (O.S.) in memory of the massacre of the children by Herod. The Church early regarded these little ones as the first martyrs. It is uncertain when the day was first kept as a saint's day. At first it seems to have been absorbed into the celebration of the Epiphany, but by the 5th century it was kept as a separate festival. In Rome it was a day of fasting and mourning. In the middle ages the festival was the occasion for much indulgence to the children. The boy-bishop (*q.v.*), whose tenure of office lasted till Childermas, had his last exercise of authority then, the day being one of the series of days which were known as the Feast of Fools. Parents temporarily abdicated

authority, and in nunneries and monasteries the youngest nun and monk were for the twenty-four hours allowed to masquerade as abess and abbot. These mockeries of religion were condemned by the Council of Basel (1431); but though shorn of its extravagances the day is still observed as a feast day and merry-making for children in Catholic countries, and particularly as an occasion for practical joking like an April Fool's Day. In Spanish-America when such a joke has been played, the phrase equivalent to "You April fool!" is *Que la inocencia le valga!* May your innocence protect you! The society of Lincoln's Inn specially celebrated Childermas, annually electing a "king of the Cockneys." Innocents' Day was ever accounted unlucky. Nothing was begun and no marriages took place then. Louis XI. prohibited all state business. The coronation of Edward IV., fixed for a Sunday, was postponed till the Monday when it was found the Sunday fell on the 28th of December. In rural England it was deemed unlucky to do housework, put on new clothes or pare the nails. At various places in Gloucestershire, Somerset and Worcestershire muffled peals were rung (*Notes and Queries*, 1st series, vol. viii. p. 617). In Northampton the festival was called "Dyzemas Day" (possibly from Gr. *δύω* - "ill" and "mass"), and there is a proverb "What is begun on Dyzemas will never be finished." The Irish call the day *La Croasna na bliana*, "the cross day of the year," or *Diar dasin darg*, "blood Thursday," and many legends attach to it (*Notes and Queries*, 4th series, vol. xii. p. 185). In medieval England the children were reminded of the mournfulness of the day by being whipped in bed on Innocents' morning. This custom survived to the 17th century.

**INNSBRUCK**, the capital of the Austrian province of Tirol, and one of the most beautifully situated towns in Europe. In 1900 the population was 26,866 (with a garrison of about 2000 men), mainly German-speaking and Romanist. Built at a height of 1880 ft., in a wide plain formed by the middle valley of the Inn and on the right bank of that river, it is surrounded by lofty mountains that seem to overhang the town. It occupies a strong military position (its commercial and industrial importance is now but secondary) at the junction of the great highway from Germany to Italy over the Brenner Pass, by which it is by rail 100½ m. from Munich and 174½ m. from Verona, with that from Bregenz in the Vorarlberg, distant 122 m., by rail under the Arlberg Pass. It takes its name from its position, close to the chief bridge over the Inn. It is the seat of the supreme judicial court of the Tirol, the Diet of which meets in the Landhaus. The streets are broad, there are several open places and the houses are handsome, many of those in the old town dating from the 17th and 18th centuries, and being adorned with frescoes, while the arcades beneath are used as shops.

The principal monument is the Franciscan or Court church (1553-1563). In it is the magnificent 16th-century cenotaph (his body is elsewhere) of the emperor Maximilian (d. 1510), who, as count of the Tirol from 1490 onwards, was much beloved by his subjects. It represents the emperor kneeling in prayer on a gigantic marble sarcophagus, surrounded by twenty-eight colossal bronze statues of mourners, of which twenty-three figure ancestors, relatives or contemporaries of Maximilian, while five represent his favourite heroes of antiquity—among these five are the two finest statues (both by Peter Vischer of Nuremberg), those of King Arthur of Britain and of Theodorich, the Ostrogothic king. On the sides of the sarcophagus are twenty-four marble reliefs, depicting the principal events in the life of Maximilian, nearly all by Alexander Colin of Malines, while the general design of the whole monument is attributed to Gilg Sesselschreiber, the court painter. In one of the aisles of the same church is the Silver Chapel, so called from a silver Madonna and silver bas-reliefs on the altar; it contains the tombs of Archduke Ferdinand, count of the Tirol (d. 1595) and his non-royal wife, Philippine Welsper of Augsburg (d. 1580), whose happy married life spent close by is one of the most romantic episodes in Tirolese history. In the other aisle are the tombs, with monuments, of the heroes of the War of Independence of 1809, Hofer, Haspinger and Speckbacher. It was in this church

that Queen Christina of Sweden, daughter of Gustavus Adolphus, abjured Protestantism, in 1655. There are also several other churches and convents, among the latter the first founded (1593) in Germany by the Capuchins.

The university of Innsbruck was formally founded in 1677, and refounded (after two periods of suspension, 1782-1792 and 1810-1826) in 1826. It is attended by about 1000 students and has a large staff of professors, the theological faculty being controlled by the Jesuits. It has a library of 176,000 books, and 1040 MSS. The University or Jesuit church dates from the early 17th century. The Ferdinandum is the provincial museum (founded in 1823, though the present building is later). The house known as the Goldne Dachl has its roof covered with gilded copper tiles; it was built about 1425, by Frederick, count of the Tirol, nicknamed "with the empty pockets," but the balcony and gilded roof were added in 1500 by the emperor Maximilian. Among the other monuments of Innsbruck may be mentioned the Pillar of St Anne, erected in 1706 to commemorate the repulse of the French and the Bavarians in 1703; the Triumphal Arch, built in 1765, on the occasion of the marriage of the future emperor Leopold II. with the Infanta Maria Louisa of Spain; and a fountain, with a bronze statue of Archduke Leopold V., set up in 1863-1877, in memory of the five-hundredth anniversary of the union of the Tirol with Austria.

The Roman station of Veldidena was succeeded by the Premonstratensian abbey of Wilten, both serving to guard the important strategical bridge over the Inn. In 1180 the count of Andechs (the local lord) moved the market-place over to the right bank of the river (where is the convent), and in 1187 we first hear of the town by its present name. Between 1233 and 1235 it was fortified, and a castle built for the lord. But it was only about 1420 that Archduke Frederick IV. ("with the empty pockets") built himself a new castle in Innsbruck, which then replaced Meran as the capital of Tirol. The county of Tirol was generally held by a cadet line of the Austrian house, the count being almost an independent ruler. But the last princeling of this kind died in 1665, since which date Innsbruck and Tirol have been governed from Vienna. In 1552 Maurice of Saxony surprised and nearly took Innsbruck, almost capturing the emperor Charles V. himself, who escaped owing to a mutiny among Maurice's troops. In the patriotic war of 1809, Innsbruck played a great part and suffered much, while in 1848, at the time of the revolution in Vienna, it joyfully received the emperor Ferdinand. (W. A. B. C.)

**INNS OF COURT.** The Inns of Court and Chancery are voluntary non-corporate legal societies seated in London, having their origin about the end of the 13th and the commencement of the 14th century.

Dugdale (*Origines Juridicales*) states that the learned in English law were anciently persons in holy orders, the justices of the king's court being bishops, abbots and the like. But in 1207 the clergy were prohibited by canon from acting in the temporal courts. The result proving prejudicial to the interests of the community, a commission of inquiry was issued by Edward I. (1209), and this was followed up (1202) by a second commission, which among other things directed that students "apt and eager" should be brought from the provinces and placed in proximity to the courts of law now fixed by Magna Carta at Westminster (see INN). These students were accordingly located in what became known as the Inns of Court and Chancery, the latter designated by Fortescue (*De Laudibus*) as "the earliest settled places for students of the law," the germ of what Sir Edward Coke subsequently spoke of as our English juridical university. In these Inns of Court and Chancery, thus constituted, and corresponding to the ordinary college, the students, according to Fortescue, not only studied the laws and divinity, but further learned to dance, sing and play instrumental music, "so that these hostels, being nurseries or seminaries of the court, were therefore called Inns of Court."

Stow in his *Survey* (1598) says: "There is in and about this city a whole university, as it were, of students, practisers or pleaders and judges of the laws of this realm"; and he goes

on to enumerate the several societies, fourteen in number, then existing, corresponding nearly with those recognized in the present day, of which the Inns of Court, properly so-called, are and always have been four, namely *Lincoln's Inn*, the *Inner Temple*, the *Middle Temple* and *Gray's Inn*. To these were originally attached as subordinate Inns of Chancery, *Furnival's Inn*, *Thavie's Inn* (to *Lincoln's Inn*), *Clifford's Inn*, *Clement's Inn* (to the *Inner Temple*), *New Inn* (to the *Middle Temple*), *Staple's Inn*, *Barnard's Inn* (to *Gray's Inn*), but they were cut adrift by the older Inns and by the middle of the 18th century had ceased to have any legal character (*vide infra*). In addition to these may be specified *Serjeant's Inn*, a society composed solely of serjeants-at-law, which ceased to exist in 1877. Besides the Inns of Chancery above enumerated, there were others, such as *Lyon's Inn*, which was pulled down in 1868, and *Scrope's Inn* and *Chester or Strand Inn*, spoken of by Stow, which have long been removed, and the societies to which they belonged have disappeared. The four Inns of Court stand on a footing of complete equality, no priority being conceded to or claimed by one inn over another. Their jurisdictions and privileges are equal, and upon affairs of common interest the benchers of the four Inns meet in conference. From the earliest times there has been an interchange of fellowship between the four houses; nevertheless the *Middle Temple* and *Lincoln's Inn*, and the *Inner Temple* and *Gray's Inn*, have maintained a closer alliance.

The members of an Inn of Court consist of benchers, barristers and students. The benchers are the senior members of the society, who are invested with the government of the body to which they belong. They are more formally designated "masters of the bench," are self-elected and unrestricted as to numbers. Usually a member of an inn, on attaining the rank of king's counsel, is invited to the bench. Other members of long standing are also occasionally chosen, but no member by becoming a king's counsel or by seniority of standing acquires the right of being nominated a bencher. The benchers vary in number from twenty in *Gray's Inn* to seventy and upwards in *Lincoln's Inn* and the *Inner Temple*. The powers of the benchers are practically without limit within their respective societies; their duties, however, are restricted to the superintendence and management of the concerns of the inn, the admission of candidates as students, the calling of them to the bar and the exercise of discipline generally over the members. The meetings of the benchers are variously denominated a "parliament" in the *Inner* and *Middle Temples*, a "pension" in *Gray's Inn* and a "council" in *Lincoln's Inn*. The judges of the superior courts are the visitors of the inns, and to them alone can an appeal be had when either of the societies refuses to call a member to the bar, or to reinstate in his privileges a barrister who has been disbarred for misconduct. The presiding or chief officer is the treasurer, one of the benchers, who is elected annually to that dignity. Other benchers fulfil the duties of master of the library, master of the walks or gardens, dean of the chapel and so forth, while others are readers, whose functions are referred to below.

The usages of the different inns varied somewhat formerly in regard both to the term of probationary studentship enforced and to the procedure involved in a "call" to the bar by which the student is converted into the barrister. In the present day the entrance examination, the course of study and the examinations to be passed on the completion of the curriculum are identical and common to all the inns (see ENGLISH LAW). When once called to the bar, no hindrance beyond professional etiquette limits a barrister's freedom of action; so also members may on application to the benchers, and on payment of arrears of dues (if any), leave the society to which they belong, and thus cease altogether to be members of the bar likewise. A member of an Inn of Court retains his name on the lists of his inn for life by means of a small annual payment varying from £1 to £5, which at one or two of the inns is compounded for by a fixed sum taken at the call to the bar.

The ceremony of the "call" varies in detail at the different inns. It takes place after dinner (before dinner at the *Middle Temple*, which is the only inn at which students are called in



their wigs and gowns), in the "parliament," "pension" or "council" chamber of the benchers. The benchers sit at a table round which are ranged the students to be called. Each candidate being provided with a glass of wine, the treasurer or senior bencher addresses them and the senior student briefly replies. "Call Parties" are also generally held by the new barristers; at the Middle Temple they are allowed in hall.

During the reign of Edward III. the Inns of Court and Chancery, based on the collegiate principle, prospered under the supervision and protection of the crown. In 1381 Wat Tyler invaded the Temple, and in the succeeding century (1450) Jack Cade meditated pulling down the Inns of Court and killing the lawyers. It would appear, moreover, that the inmates of the inns were themselves at times disorderly and in conflict with the citizens. Fortescue (c. 1464) describing these societies thus speaks of them: "There belong to the law ten lesser inns, which are called the Inns of Chancery, in each of which there are one hundred students at least, and in some a far greater number, though not constantly residing. After the students have made some progress here they are admitted to the Inns of Court. Of these there are four, in the least frequented of which there are about two hundred students. The discipline is excellent, and the mode of study well adapted for proficiency." This system had probably existed for two centuries before Fortescue wrote, and continued to be enforced down to the time of Sir Thomas More (1498), of Chief Justice Dyer (1537) and of Sir Edward Coke (1571). By the time of Sir Matthew Hale (1629) the custom for law students to be first entered to an Inn of Chancery before being admitted to an Inn of Court had become obsolete, and thenceforth the Inns of Chancery have been abandoned to the attorneys. Stow in his *Survey* succinctly points out the course of reading enforced at the end of the 16th century. He says that the Inns of Court were replenished partly by students coming from the Inns of Chancery, who went thither from the universities and sometimes immediately from grammar schools; and, having spent some time in studying the first elements of the law, and having performed the exercises called "bolts," "moots" and "putting of cases," they proceeded to be admitted, and become students in, one of the Inns of Court. Here continuing for the space of seven years or thereabouts, they frequented readings and other learned exercises, whereby, growing ripe in the knowledge of the laws, they were, by the general consent either of the benchers or of the readers, called to the degree of barrister, and so enabled to practise in chambers and at the bar. This ample provision for legal study continued with more or less vigour down to nearly the commencement of the 18th century. A languor similar to that which affected the church and the universities then gradually supervened, until the fulfilment of the merest forms sufficed to confer the dignity of advocate and pleader. This was maintained until about 1845, when steps were taken for reviving and extending the ancient discipline and course of study, bringing them into harmony with modern ideas and requirements.

The fees payable vary slightly at the different inns, but average about £150. This sum covers all expenses from admission to an inn to the call at the bar, but the addition of tutorial and other expenses may augment the cost of a barrister's legal education to £400 or £500. The period of study prior to call must not be less than twelve terms, equivalent to about three years. Solicitors, however, may be called without keeping any terms if they have been in practice for not fewer than five consecutive years.

It has been seen that the studies pursued in ancient times were conducted by means of "readings," "moots" and "bolts." The readings were deemed of vital importance, and were delivered in the halls with much ceremony; they were frequently regarded as authorities and cited as such at Westminster in argument. Some statute or section of a statute was selected for analysis and explanation, and its relation to the common law pointed out. Many of these readings, dating back to Edward I., are extant, and well illustrate the importance of the subjects and the exhaustive and learned manner in which they were treated. The function of "reader" involved the holder in very weighty

expenses, chiefly by reason of the profuse hospitality dispensed—a constant and splendid table being kept during the three weeks and three days over which the readings extended, to which were invited the nobility, judges, bishops, the officers of state and sometimes the king himself. In 1688 the readers were paid £200 for their reading, but by that time the office had become a sinecure. In the present day the readership is purely honorary and without duties. The privilege formerly assumed by the reader of calling to the bar was taken away in 1664 by an order of the lord chancellor and the judges. *Moots* were exercises of the nature of formal arguments on points of law raised by the students and conducted under the supervision of a bencher and two barristers sitting as judges in the halls of the inns. *Bolts* were of an analogous character, though deemed inferior to moots.

In the early history of the inns discrimination was exercised in regard to the social status of candidates for admission to them. Sir John Ferne, a writer of the 16th century, referred to by Dugdale, states that none were admitted into the houses of court except they were gentlemen of blood. So also Pliny, writing in the 1st century of the Christian era (*Letters*, ii. 14), says that before his day young men even of the highest families of Rome were not admitted to practice except upon the introduction of some man of consular rank. But he goes on to add that all barriers were then broken down, everything being open to everybody—a remark applicable to the bar of England and elsewhere in the present day. It may here be noted that no dignity or title confers any rank at the bar. A privy councillor, a peer's son, a baronet, the speaker of the House of Commons or a knight—all rank at the bar merely according to their legal precedence. Formerly orders were frequently issued both by the benchers and by the crown on the subject of the dress, manners, morals and religious observances of students and members. Although some semblance of a collegiate discipline is still maintained, this is restricted to the dining in hall, where many ancient usages survive, and to the closing of the gates of the inns at night.

Each inn maintains a chapel, with the accompaniment of preachers and other clergy, the services being those of the Church of England. The Inner and the Middle Temple have joint use of the Temple church. The office of preacher is usually filled by an ecclesiastic chosen by the benchers. The principal ecclesiastic of the Temple church is, however, constituted by letters patent by the crown without episcopal institution or induction, enjoying, nevertheless, no authority independently of the benchers. He bears the title of Master of the Temple.

It has already been stated, on the authority of Fortescue, that the students of the Inns of Court learned to dance, sing and play instrumental music; and those accomplishments found expression in the "masques" and "revels" for which the societies formerly distinguished themselves, especially the Inner Temple and Gray's Inn. These entertainments were of great antiquity and much magnificence, involving very considerable expense. Evelyn (*Diary*) speaks of the revels at the Middle Temple as an old and riotous custom, having relation neither to virtue nor to policy. The last revel appears to have been held at the Inner Temple in 1734, to mark the occasion of the elevation of Lord Chancellor Talbot to the woollack. The plays and masques performed were sometimes repeated elsewhere than in the hall of the inn, especially before the sovereign or court. A master of the revels was appointed, commonly designated Lord of Misrule. There is abundant information as to the scope and nature of these entertainments: one of the festivals is minutely described by Gerard Leigh in his *Accidence of Armorie*, 1612; and a tradition ascribes the first performance of Shakespeare's *Twelfth Night* to a revel held in the Middle Temple hall in February 1601. The hospitality of the inns now finds expression mainly in the "Grand Day," held once in each of the four terms, when it is customary for the judges and other distinguished visitors to dine with the benchers (who sit apart from the barristers and students on a dais in some state), and "Readers' Feast," on both which occasions extra commons and wine are served to the members attending. But the old customs also found some renewal in the shape of balls, concerts, garden-parties

and other entertainments. In 1887 there was a revival (the first since the 17th century) of the Masque of Flowers at both the Inner Temple and Gray's Inn. The Royal Horticultural Society's annual exhibition of flowers and fruit is held in May in the Temple Gardens. Plays are also occasionally performed in the Temple, Robert Browning's *Sordello* being acted in 1902 by a company of amateurs, most of whom were either members of the bar or connected with the legal profession.

The *Inner* and the *Middle Temple*, so far as their history can be traced, have always been separate societies. Fortescue, writing between 1461 and 1470, makes no allusion to a previous junction of the two inns. Dugdale (1671) speaks of the Temple as having been one society, and states that the students so increased in number that at length they divided, becoming the Inner and Middle Temple respectively. He does not, however, give any authority for this statement, or furnish the date of the division. The first trustworthy mention of the Temple as an inn of court is found in the *Paston Letters*, where, under date November 1440, the Inner Temple is spoken of as a college, as is also subsequently the Middle Temple. The Temple had been the seat in England of the Knights Templars, on whose suppression in 1312 it passed with other of their possessions to the crown, and after an interval of some years to the Knights Hospitallers of St John of Jerusalem, who in the reign of Edward III. arranged the masons' lodges to certain parts of the Temple, and the common law who came from Thavie Inn. Notwithstanding the destruction of the monuments of the Temple by fire or by popular commotion, sufficient testimony is attainable to show that in the reigns of Edward III. and Richard II. the Temple had become the residence of the legal communities which have since maintained there a permanent footing. The two societies continued as tenants to the Knights Hospitallers of St John until the dissolution of the order in 1539; they then became the lessees of the crown, and so remained until 1609, when James I. made a grant by letters patent of the premises in perpetuity to the benchers of the respective societies on a yearly payment by each of £10, a payment bought up in the reign of Charles II. In this grant the two inns are described as "the Inner and the Middle Temple or New Temple," and as "being two out of those four colleges the most famous of all Europe" for the study of the law. Excepting the church, nothing remains of the edifices belonging to the Knights Templars, the present buildings having been almost wholly erected since the reign of Queen Elizabeth or since the Great Fire, of which the major part of the Inner Temple perished. The church has been divided into the eastern half of the Inner and Middle Temple from time immemorial—the former taking the southern and the latter the northern half. The round portion of the church was consecrated in 1185, the nave or choir in 1240. It is the largest and most complete of the four remaining round churches in England, and is built on the plan of the church of the Holy Sepulchre at Jerusalem. Narrowly escaping the ravages of the fire of 1666, this beautiful building is one of the most perfect specimens of early Gothic architecture in England. In former times the lawyers awaited their clients for consultation in the Round Church, as similarly the sergeants-at-law were accustomed to resort to St Paul's Cathedral, where each serjeant had a pillar assigned him.

The *Inner Temple*, comprehending a hall, parliament chamber, library and other buildings, occupies the site of the ancient mansion of the Knights Templars, built about the year 1240, and has from time to time been more or less rebuilt and extended, the present handsome range of buildings, including a new dining hall, being completed in 1870. The library owes its existence to William Percy, keeper of the Tower records in the time of Queen Anne, who was also a benefactor to the library of the Middle Temple, the greatest addition by gift was made by the Baron F. Masers in 1825. The number of volumes now in the library is 37,000. Of the Inns of Chancery belonging to the Inner Temple *Clifford's Inn* was anciently the town residence of the Barons Clifford, and was demised in 1345 to a body of students of the law. It was the most important of the Inns of Chancery, and numbered among its members Coke andelden. At its dinners a table was specially set aside for the "Kentish Men," though it is not clear what connexion there was between the Inn and the county of Kent. It was destroyed by a principal and twelve jurors. *Clement's Inn* was an Inn of Chancery before the reign of Edward IV., taking its name from the parish church of St Clement Danes, to which it had formerly belonged. Clement's Inn was the inn of Shakespeare's Master Shallow, and was the Shepherd's Inn of Thackeray's *Pendennis*. The buildings of Clifford's Inn survive (1910), but of Clement's Inn there are left but a few fragments.

The *Middle Temple* possesses in its hall one of the most stately of existing Elizabethan buildings. Commenced in 1562, under the auspices of Edmund Plowden, then treasurer, it was not completed until 1572, the richly carved screen at the east end in the style of the Renaissance being put up in 1575. The belief that the screen was constructed of timber taken from ships of the Spanish Armada (1588) is baseless. The hall, which has been preserved unaltered, has been the scene of numerous historic incidents, notably the entertainments given within its walls to regal and other personages from Queen Elizabeth downwards. The library, which contains about

28,000 volumes, dates from 1641, when Robert Ashley, a member of the society, bequeathed his collection of books in all classes of literature to the inn, together with a large sum of money; other benefactors were Ashmole (the antiquary), William Petyt (a benefactor of the Inner Temple) and Lord Stowell. From 1711 to 1826 the library was greatly neglected; and many of the most scarce and valuable books were lost. The present handsome library building, which stands on the east side of the hall, was completed in 1826, the first stone of Wales (afterwards Edward VII.) attending the inauguration ceremony on October 31st of that year, and becoming a member and benchman of the society on the occasion. He afterwards held the office of treasurer (1882). The MSS. in the collection are few and of no special value. In civil, canon and international law, as also in divinity and ecclesiastical history, the library is very rich; it contains also some curious works on witchcraft and demonology. There was but one Inn of Chancery connected with the Middle Temple, that of *New Inn*, which, according to Dugdale, was formed by a society of students previously settled at St George's Inn, situated near St Sepulchre's Church without Newgate; but the date of this transfer is not known. The buildings have now been pulled down.

*Lincoln's Inn* stands on the site partly of an episcopal palace erected in the time of Henry III. by Ralph Nevill, bishop of Chichester and chancellor of England, and partly of a religious house, called Black Friars House, in Holborn. In the reign of Edward II., Henry Lacy, earl of Lincoln, possessed the place, which from him acquired the name of Lincoln's Inn, probably becoming an Inn of Court soon after his death (in 1310); though of its origin as a place of legal study there is little authentic record until the time of Henry VI. (1424), to which date the existing muniments reach back. The fee simple of the inn would appear to have remained vested in the see of Chichester; and it was not until 1580 that the society which for centuries had occupied the inn as tenants acquired the absolute ownership of it. The old hall, built about 1506, still remains, but has given place to a modern structure designed by Philip Hardwick, R.A., which, along with the buildings containing the library, was completed in 1845, Queen Victoria attending the inauguration ceremony (October 13). The chapel, built after the designs of Inigo Jones, was consecrated in 1623. The library—was a collection of law books the most complete in the country—owes its foundation to a bequest of John Nethersale, a member of the society, in 1497, and is the oldest of the existing libraries in London. Various entries in the records of the inn relate to the library, and notably in 1608, when an effort was made to extend the collection, and the first appointment of a master of the library (an office now held in annual rotation by the Queen's Counsel) were recorded. The collection enriched by donations and by the acquisition by purchase of collections of books on special subjects. It includes also an extensive and valuable series of MSS., the whole comprehending 50,000 volumes. The prince of Wales (George V.), a benchman of the society, filled the office of treasurer in 1904. The Inns of Chancery affiliated to Lincoln's Inn were Thavie's Inn and Furnival's Inn. *Thavie's Inn* was a residence of students of the law in the time of Edward III., and is mentioned by Fortescue as having been one of the lesser houses of Lincoln's Inn for some centuries. It thus continued down to 1769 when the inn was sold by the benchers, and thenceforth ceased to have any character as a place of legal education. *Furnival's Inn* became the resort of students about the year 1406, and was purchased by the society of Lincoln's Inn in 1547. It was governed by a principal and twelve antiens. In 1817 the Inn was rebuilt, but from that date it ceased to exist as a legal community and is now demolished.

The exact date of *Gray's Inn* becoming the residence of lawyers is not known, though it was so occupied before the year 1370. The inn is the site of a palace of the 15th century, which has long in ancient times to the dean and chapter of St Paul's, but subsequently the property of the family of Grey de Wilton and eventually of the crown, from which a grant of the manor or inn was obtained, many years since discharged from any rent or payment. The hall of the inn is of handsome design, similar to the Middle Temple hall in its general character and arrangements, and was completed about the year 1560. The chapel, of much earlier date than the hall, has, notwithstanding its antiquity, little to recommend it to notice, being small and insignificant, and lacking of architectural ornaments of any value. The library, including about 13,000 volumes, contains a small but important collection of MSS. and missals, and also some valuable works on divinity. Little is known of the origin or early history of the library, though mention is incidentally made of it in the society's records in the 16th and 17th centuries. The gardeners, laid out about 1597, it is believed under the auspices of the lord chancellor Bacon, at that time treasurer of the society, continue to this day as then planned, though with some curtailment owing to the erection of additional buildings. Among many curious customs maintained in this inn is that of drinking "toys on grand day" "the glorious pious and immortal memory of Queen Elizabeth." Of the special circumstances originating this display of loyalty there is no record. The Inns of Chancery connected with Gray's Inn are Staple and Barnard's Inns. *Staple Inn* was an Inn of Chancery in the reign of Henry V., and is probably of yet earlier date. Readings and moots were observed here with regularity. Sir Simonds d'Ewes mentions attending a moot in February 1624. The inn, with its

picturesque Elizabethan front, faces Holborn. It was sold by the antients in 1884 for £68,000. It is in a very good state of preservation, and it is the intention of the purchasers, the Prudential Assurance Company, to preserve it as a memorial of vanishing London. *Bar-nard's Inn*, anciently designated Mackworth Inn, was an Inn of Chancery in the reign of Henry VI. It was bequeathed by him to the dean and chapter of Lincoln. It is now the property of the Mercer's Company and is used as a school.

The *King's Inns, Dublin*, the legal school in Ireland, corresponds closely to the English Inns of Court, and is in many respects in unison with them in its regulations with regard to the admission of students into the society, and to the degree of barrister-at-law, as also in the scope of the examinations enforced. Formerly it was necessary to keep a number of terms at one of the Inns in London—the stipulation dating as far back as 1542 (33 Henry VIII. c. 3). Down to 1866 the course of education pursued at the King's Inns differed from that of the English Inns of Court in that candidates for admission to the legal profession as attorneys and solicitors carried on their studies with those studying for the higher grade of the bar in the same building under a professor specially appointed for this purpose,—herein following the usage anciently prevailing in the Inns of Chancery in London. This arrangement was put an end to by the Attorneys and Solicitors Act (Ireland) 1866. The origin of the King's Inns may be traced to the reign of Edward I., when a legal society designated Collett's Inn was established without the walls of the city; it was dissolved by the reign of Henry III. In the reign of Edward I. Sir Robert Preston, chief baron of the exchequer, gave up his residence within the city to the legal body, which then took the name of Preston's Inn. In 1542 the land and buildings known as Preston's Inn were restored to the family of the original donor, and in the same year Henry VIII. granted the monastery of Friars Preachers for the use of the professors of the law in Ireland. The legal body removed to the new site, and thenceforward were known by the name of the King's Inns. Possession of this property having been resumed by the government in 1742, and the present Four Courts erected thereon, a plot of ground at the top of Henrietta Street was purchased by the society, and the existing hall built in the year 1800. The library, numbering over 50,000 volumes, with a few MSS., is housed in buildings specially provided in the year 1831, and is open, not only to the members of the society, but also to strangers. The collection comprises all kinds of literature. It is based principally upon a purchase made in 1787 of the large and valuable library of Mr Justice Robinson, and is maintained chiefly by an annual payment made from the Consolidated Fund to the society in lieu of the right to receive copyright works which was conferred by an Act of 1801, but abrogated in 1836.

In discipline and professional etiquette the members of the bar in Ireland differ little from their English brethren. The same style of costume is enforced, the same gradations of rank—attorney-general, solicitor-general, king's counsel and ordinary barristers—being found. There are also sergeants-at-law limited, however, to three in number, and designated 1st, 2nd and 3rd serjeant. The King's Inns do not provide chambers for business purposes; there is consequently no aggregation of counsel in certain localities, as is the case in London in the Inns of Court and their immediate vicinity.

The corporation known as the *Faculty of Advocates* in Edinburgh corresponds with the Inns of Court in London and the King's Inns in Dublin (see *ADVOCATES, FACULTY OF*).

**AUTHORITIES.**—Fortescue, *De laudibus legum Angliæ*, by A. Amos (1825); Dugdale, *Origines Juridicæ* (2nd ed., 1671); *History and Antiquities of the Four Inns of Court*, &c. (1780, 2nd ed.); Foss, *Judges of England* (1848—1864, 9 vols.); Herbert, *Antiquities of the Inns of Court* (1804); Pearce, *History of the Inns of Court* (1848); *Report of the Commissioners appointed to inquire into the Inns of Court and Chancery*, 1855; Ball, *Student's Guide to the Bar* (1878); Stow, *Survey of London and Westminster*, by Strype (1754—1755); Nichols, *Progresses of Elizabeth and James I.*; Lane, *Student's Guide through Lincoln's Inn* (2nd ed., 1805); Spilsbury, *Lincoln's Inn, with an Account of the Library* (2nd ed., 1873); Douthwaite, *Notes illustrative of the History and Antiquities of Gray's Inn* (1876), and *Gray's Inn, its History and Associations* (1886); *Paston Letters* (1872); *Law Magazine*, 1859—1860; *Quarterly Review*, October, 1871; Cowell, *Law Dictionary* (1727); Duhaig, *History of the King's Inns in Ireland* (1861); Mackay, *Practice of the Court of Session* (1879); Bellot, *The Inner and Middle Temple* (1902); Inderwick, *The King's Peace* (1895); Fletcher, *The Pension Book of Gray's Inn* (1901); Loftie, *The Inns of Court* (1895); Hope, *Chronicles of an Old Inn* (Gray's Inn) (1887); *A Calendar of the Inner Temple Records* (ed. F. A. Inderwick, 3 vols.). (J. C. W.)

**INNUENDO** (Latin for "by nodding," from *innuere*, to indicate by nodding), an insinuation, suggestion, in *prima facie* innocent words, of something defamatory or disparaging of a person. The word appears in legal documents in Medieval Latin, to explain, in parenthesis, that to which a preceding word refers; thus, "he, *innuendo*, the plaintiff, is a thief." The word is still found in pleadings in actions for libel and slander. The *innuendo*, in the plaintiff's statement of claim, is an avowment that words

written or spoken by the defendant, though *prima facie* not actionable, have, in fact, a defamatory meaning, which is specifically set out (see *LIBEL AND SLANDER*).

**INOUE, KAORU, MARQUESS** (1835— ), Japanese statesman, was born in 1835, a *samurai* of the Chōshū fief. He was a bosom friend of his fellow-clansman Prince Ito, and the two youths visited England in 1863, serving as common sailors during the voyage. At that time all travel abroad was forbidden on pain of death, but the veto did not prove deterrent in the face of a rapidly growing conviction that, as a matter of self-protection, Japan must assimilate the essentials of Western civilization. Shortly after the departure of Inouye and Ito, the Chōshū fief, having fired upon foreign vessels passing the strait of Shimonoseki, was menaced by war with the Yedo government or with the insulted powers, and Inouye and Ito, on receipt of this news, hastened home hoping to avert the catastrophe. They repaired to the British legation in Yedo and begged that the allied squadron, then about to sail for Shimonoseki to call Chōshū to account, should be delayed that they might have an opportunity of advising the fief to make timely submission. Not only was this request complied with, but a British frigate was detailed to carry the two men to Shimonoseki, and, pending her departure, the British legation assisted them to lie *perdu*. Their mission proved futile, however, and Inouye was subsequently waylaid by a party of conservative *samurai*, who left him covered with wounds. This experience did not modify his liberal views, and, by the time of the Restoration in 1867, he had earned a high reputation as a leader of progress and an able statesman. Finance and foreign affairs were supposed to be the spheres specially suited to his genius, but his name is not associated with any signal practical success in either, though his counsels were always highly valued by his sovereign and his country alike. As minister of foreign affairs he conducted the long and abortive negotiations for treaty revision between 1883 and 1886, and in 1885 he was raised to the peerage with the title of count, being one of the first group of *Meiji* statesmen whose services were thus rewarded. Prior to his permanent retirement from office in 1898, he held the portfolios of foreign affairs, finance, home affairs, and agriculture and commerce, and throughout the war with Russia he attended all important state councils, by order of the emperor, being also specially designated adviser to the minister of finance. In 1907 he was raised to the rank of marquess. His name will go down in his country's history as one of the five *Meiji* statesmen, namely, Princes Ito and Yamagata, Marquesses Inouye and Matsukata and Count Okuma.

**INOWRAZLAW**, the Polish form of the German *Jung-Breslau*, by which the place was formerly known, a town in the Prussian province of Posen, situated on an eminence in the most fertile part of the province, 21 m. S.W. of Thorn. Pop. (1900) 26,141. Iron-founding, the manufacture of machinery and chemicals, and an active trade in cattle and country produce are carried on. In the vicinity are important salt works and a sulphur mine, and since 1876 a brine bath has been within the town. Inowrazlaw is mentioned as early as 1185, and in 1772 it passed to Prussia.

**INQUEST** (O. Fr. *enquête*, modern *enquête*, from Lat. *inquisitum*, *inquirere*, to inquire), an inquiry, particularly a formal legal inquiry into facts. The word is now chiefly confined to the inquiry held by a coroner and jury into the causes of certain deaths, in matters of treasure trove, and, in the city of London, in cases of fires (see *CORONER*). Formerly the term was applied to many formal and official inquiries for fixing prices, &c.

**INQUISITION, THE** (Lat. *inquisitio*, an inquiry), the name given to the ecclesiastical jurisdiction dealing both in the middle ages and in modern times with the detection and punishment of heretics and all persons guilty of any offence against Catholic orthodoxy. It is incorrect to say that the Inquisition made its appearance in the 13th century complete in all its principles and organs. It was the result of, or rather one step in, a process of evolution, the beginnings of which are to be traced back to the origins of Christianity. St Paul (1 Tim

Punishment of heresy in the Roman Empire.

i. 20) "delivered unto Satan" Hymenaeus and Alexander, "that they might learn not to blaspheme." The penalty of death by stoning inflicted by the book of Deuteronomy upon those who deserted the true faith (Deut. xiii. 6-9, xvii. 1-6) is thus reduced to a purely spiritual excommunication. During the first three centuries of the Church there is no trace of any persecution, and the earlier Fathers, especially Origen and Lactantius, reject the idea of it. Constantine, by the edict of Milan (313), inaugurated an era of official tolerance, but from the time of Valentinian I. and Theodosius I. onwards, laws against heretics began to appear, and increased with astonishing regularity and rapidity. We can count sixty-eight distributed over fifty-two years; heretics are subjected to exile or confiscation, disqualified from inheriting property, and even, in the case of a few groups of Manichaeans and Donatists, condemned to death; but it should be noticed that these penalties apply only to the outward manifestations of heresy, and not, as in the middle

ages, to crimes of conscience. Within the Church, St Optatus alone (*De schismate Donatistarum*, lib. iii. cap. iii.) approved of this violent repression of the Donatist heresy; St Augustine only admitted a

*temperata severitas*, such as scourging, fines or exile, and at the end of the 4th century the condemnation of the Spanish heretic Priscillian, who was put to death in 385 by order of the emperor Maximus, gave rise to a keen controversy. St Martin of Tours, St Ambrose and St Leo vigorously attacked the Spanish bishops who had obtained the condemnation of Priscillian. St John Chrysostom considered that a heretic should be deprived of the liberty of speech and that assemblies organized by heretics should be dissolved, but declared that "to put a heretic to death would be to introduce upon earth an inexpressible crime." From

the 6th to the 9th century the heterodox, with the exception of the Manichaean sects in certain places, were hardly subjected to persecution. They were, moreover, rare and generally isolated, for groups of sectaries only began to appear to any extent at the time of the earliest appearances of Catharism. However, at the end of the 10th century, the disciples of Vilgard, a heretic of Ravenna, were destroyed in Italy and Sardinia, according to Glaber. *ferro et incendio*, probably by assimilation to the Manichaeans. Perhaps this was the precedent for the punishment of the thirteen Cathari who were burnt at Orleans in 1022 by order of King Robert, a sentence which has been commonly quoted as the first action of the "secular arm" (or lay power) against heresy in the West during the middle ages. However that may be, after 1022 there were numerous cases of the execution of heretics, either by burning or strangling, in France, Italy, the Empire and England. Up till about 1200 it is not quite easy to determine what part was taken by the Church and its bishops and doctors in this series of executions. At Orleans the people, supported by the Crown, were responsible for the death of the heretics; the historians give only the faintest indications of any direct intervention of the clergy, except perhaps for the examination of doctrine. At Goslar (1051-1052) the proceedings were the same. At Asti (1034) the bishop's name appears side by side with those of the other lords who attacked the Cathari, but it seems clear that it was not he who had the chief voice in their execution; at Milan, it was again the civil magistrates, and this time against the wish of the archbishop—who gave the heretics the choice between the adoration of the cross and death. At Soissons (1114) the mob, distrustful of the weakness of the clergy, took advantage of their bishop's absence to burn heretics at the stake. It was also the mob who, infuriated at seeing him destroy and burn crosses, burnt the hegoumen Peter of Bruis (c. 1110). At Liège (1144) the bishop saved from the flames certain persons whom the faithful were attempting to burn. At Cologne (1163) the archbishop was less successful, and the mob put the heretics to death without even a trial. The condemnation of Arnold of Brescia was entirely political, though he was denounced as a heretic to the secular arm by Bernard of Clairvaux, and his execution was the act of the prefect of Rome (1155). At Vézelay, on the contrary (1167), the

heretics were burnt after ecclesiastical judgment had been pronounced by the abbot and several bishops. From 1183 to 1206 Hugh, bishop of Auxerre, took upon himself the discretionary power of exiling, dispossessing or burning heretics, while about the same time William of the White Hands, archbishop of Reims, in concert with Philip, count of Flanders, stamped out heresy from his diocese by fire. There was a similar unanimity between the lay and ecclesiastical authorities in the famous condemnation of the disciples of Amalric of Bena, who were burnt at Paris in 1209 by order of Philip Augustus after an ecclesiastical inquiry and judgment. The theory in these matters was at first as uncertain as the practice; in the 11th century one bishop only, Theodwin of Liège (d. 1075), affirms the necessity for the punishment of heretics by the secular arm (1050). His predecessor, Wazo, bishop of Liège from 1041 to 1044, had expressly condemned any capital punishment and advised the bishop of Chalons to resort to peaceful conversion.

In the 12th century Peter the Cantor<sup>1</sup> protested against the death penalty, admitting at the most imprisonment. It was imprisonment again, or exile, but not death, which the German abbot Gerhoh of Reichersberg (1063-1169) demanded in the case of Arnold of Brescia, and in dealing with the heretics of Cologne, St Bernard, who cannot be accused of leniency where heterodoxy was concerned, recommended pacific refutation, followed by excommunication or prison, but never the death penalty (see BERNARD, ST, of Clairvaux). In the councils, too, it is clear that the appeal to the secular arm was equally guarded: at Reims (1049) excommunication alone is decreed against heretics; and when, as at

Toulouse (1110) and the Lateran council (1139), it is laid down that heretics, in addition to excommunication, should be dealt with *per potestates externas*, or when, as at the council of Reims (1148), the secular princes are forbidden to support or harbour heretics, there is never any suggestion of capital punishment. But it must be noticed that from the opening years of the 12th century date the beginnings of a decided evolution in the canon law, continuing up to the time of Innocent III., which substituted for arbitrary decisions according to circumstances an

organized and particularized legislation, in which judgment was given *secundum canonicas et legitimas sanctiones*. Anselm of Lucca and the *Panormia* attributed to Ivo of Chartres reproduced word for word under the rubric *De edicto imperatorum in dampnationem haereticorum*, law 5 of the title *De hereticis* of Justinian's code, which pronounces the sentence of death against the Manichaeans; and we should remember that the Cathari, and in general all heretics in the West in the 11th and 12th centuries were considered by contemporary theologians as Manichaeans. Gratian in the *Decretum* proclaims the views of St Augustine (exile and fines). Certain of his commentators (*2<sup>a</sup> pars Caus. xxiii.*), and notably Rufinus Johannes Teutonicus, and the anonymous glossator (in Ugucchio's Great Summa of the *Decretum*) declare that impenitent heretics may, or even should, be punished by death. As early as

1163, the council of Tours suggested to the ecclesiastical authorities definite penalties to be inflicted on heretics, namely, imprisonment and loss of all their property. Pope Alexander III., who had attended the council of Tours of 1163, renewed at the Lateran council (1179) the decisions which had already been made with regard to the heterodox in the south of France, and at Verona in 1184

Pope Lucius III., in concert with the emperor Frederick Barbarossa, took still more severe measures: obstinate heretics were to be excommunicated, and then handed over to the secular arm, which would inflict a suitable penalty. The emperor, on his side, laid them under the imperial ban (exile, confiscation, demolition of their houses, *infamia*, loss of civil rights, disqualification from

**Conflicting views as to the punishment of heresy.**

**The Church Councils.**

**Influence of the Canon Law.**

**The Council of Tours, 1163.**

**Definition of the procedure under Lucius III and the Emperor Frederick**

<sup>1</sup> Pierre du Beauvoisin (?), choir-master (*grand-chantre*) of the university of Paris (1181), bishop of Tournai (1191), of Paris (1196); died as a Cistercian in 1197. He was beatified.

public offices, &c.). The usage, then, was already quite clear; but the death penalty had not as yet been demanded or inflicted. Possibly it was Count Raymond V. of Toulouse, in whose territories heretics abounded, who in 1104 enacted a law threatening them with the penalty of death; but the authenticity of this act has been questioned. It was more probably Peter II. of Aragon who was the first to decree, in 1107, the punishment of death by burning against the heretics who should not have left his kingdom within a given time. But it was Innocent III. who gave the most powerful impetus to the anti-heretical movement in the secular world by his frequent exhortations (beginning in 1108) to the secular princes (letters of March 25th, 1109, and September 22nd, 1207). As a jurist he henceforward assimilated the crime of high treason against God to that of high treason against temporal rulers, and admitted all the terrible consequences of this assimilation.

It is therefore incorrect to believe that the Inquisition arose out of, and at the time of, the crusade against the Albigenes.

These executions *en masse* certainly created a definitive precedent for violent repression, but there was still no regular organization: the council of Toulouse, held in November 1229 by the Roman legate after the treaty of peace, attempted to organize one, and constituted itself the tribunal. But the procedure was still uncertain; in the north, from 1200 to 1222, at Paris (execution of the disciples of Amalric of Bena), at Strassburg, Cambrai, Troyes and Besançon executions took place, after trials in which the bishops were the judges, the exercise of the secular power being based on vague phrases in the decrees of Louis VIII. (that heretics be punished *animadversione debita*), or in those of Louis IX., ordering his *ballifs* or barons to do to them *quod debuerunt*. The emperor Frederick II. defined his jurisprudence more clearly: from 1220 to 1230, supported by Pope Honorius III., and above all by Gregory IX., he established against the heretics of the Empire in general a legislation in which the penalties of death, banishment and confiscation of property were formulated so clearly as to be henceforth incontestable. Gregory IX. felt his influence, and also that of the Dominican Guala, bishop of Brescia, who had subjected his episcopal town to the full rigour of the imperial laws. The pope no longer hesitated as to the principle or the degree of repression; but introduced new methods of inquiry and judgment: he created out of the material furnished him by the mendicant orders, and especially the Dominicans, who were more disciplined than the rest and better theologians, the monastic inquisition, which was more elastic, more constant in its activities and more numerous than the inquisition by legate, and better disciplined than the episcopal inquisition. In November 1232 the Dominican Alberic went round Lombardy with the title of *Inquisitor hereticæ pravitatis*. In 1231 a similar commission was given to the Dominicans of Friesland and to the terrible Conrad of Marburg, whose zeal in Germany even exceeded the pope's wishes. In 1233 Gregory IX. addressed a letter to the bishops in the south of France, in which he announced his intention of employing the preaching friars in future for the discovery and repression of heresy.

The inquisition was now regularly instituted, but its jurisprudence was elaborated by successive additions or limitations, by the force of custom and the detailed prescriptions added by the papal constitutions. The pope's commissioners "in the matter of heresy" at first travelled from place to place. On arriving in a district they addressed its inhabitants, called upon them to confess, if they were heretics, or to denounce those whom they knew to be heretics: a "time of grace" was opened, during which those who freely confessed were dispensed from all penalties, or only given a secret and very light penance; while those whose heresy had been openly manifested were exempted from the penalties of death and perpetual imprisonment. But this time

could not exceed one month. After that began the inquisition. As soon as their mission was at an end, and heresy was considered to be stamped out, the inquisitors left the country. Later, inquisitorial districts were formed. The seat of the Inquisition in each district was the monastery of the order (Dominican or Franciscan) to which the inquisitors for that part belonged. There was never any special court or prison: the *mirus* (prison) was lent to the Inquisition by the ecclesiastical or secular authorities. The maintenance of the prisoners and the duty of providing the prison fell in principle upon the bishops (council of Toulouse, 1220), but they tried to evade it. The kings of France, and in particular Louis VIII., granted subsidies to the inquisitors. For each district the inquisitors were chosen by the provincials of their order, approved or rejected by the pope, and removable by him only. Their discretionary powers were absolute. They conducted their interrogations before two persons (laymen or ecclesiastics) and only pronounced their sentence after consultation with leading men in the district (*communicatio bonorum virorum consilio*). This was the only protection for the accused. It was in vain that the civil lawyers tried to prove that the secular authorities had a right to see the documents bearing on the case; the Inquisition always succeeded in setting aside these claims. The share taken in the proceedings by the bishops, the accused or their representatives, though admitted in principle, was as a rule merely illusory. The Inquisition had in addition to these *boni viri* certain other lay assistant officials, its sworn notaries, messengers and familiars, all of whom were closely bound to it.

Bernard Guy (Bernardus Guidonis),<sup>1</sup> one of the earliest and most complete exponents of the theory of the Inquisition, admits distinctly that in its procedure *multa sunt specialia*. The procedure was secret and in the highest degree arbitrary, proceeding *sine strepitu et figura iudicii*, its object being to ascertain not so much particular offences as tendencies: the murderers of the inquisitor Peter Martyr<sup>2</sup> were tried, not as assassins, but as guilty of heresy and adversaries of the Inquisition; and on the other hand, external acts of piety and verbal professions of faith were held of no value. Moreover the Inquisition was not bound by the ordinary rules of procedure in its inquiries: the accused was surprised by a sudden summons, and as a rule imprisoned on suspicion. All the accused were presumed to be guilty, the judge being at the same time the accuser. Absence was naturally considered as contumacy, and only increased the presumption of guilt by seeming to admit it. The accused had the right to demand a written account of the offences attributed to him (*captiva accusacionis*), but the names of the witnesses were withheld from him (Innocent IV.; bulls *Cum negotium* and *Licet sicut accepimus*), he did not know who had denounced him, nor what weight was attached by the judges to the denunciations made against him. The utmost that was allowed him was the unsatisfactory privilege of the *recusaciones divinatorias*, i.e. at his first examination he was asked for the names of any enemies of whom he knew, and the causes of their enmity. Heretics or persons deprived of civil rights (*infames*) were admitted as witnesses in cases of heresy. Women, children or slaves could be witnesses for the prosecution, but not for the defence, and cases are even to be found in which the witnesses were only ten years of age. Langhino Ugolini states that a witness who should retract his hostile evidence should be punished for false witness; but that his evidence should be retained, and have its full effect on the sentence. No witness might refuse to give evidence, under pain of being considered guilty of heresy. The prosecution went on in the utmost secrecy. The accused swore that he would tell the whole truth, and was bound to denounce all those

<sup>1</sup> He was born c. 1261, was a Dominican at Limoges in 1279, successively prior of Albi (1294), Carcassonne (1297), Castres (1301) and Limoges (1305), inquisitor at Toulouse (1307), bishop of Tui (1323) and of Lodève (1325). He died in 1331.

<sup>2</sup> Peter, a Dominican, born at Verona, was murdered near Milan in 1252 and canonized in 1253.

Inquisitorial districts.

The inquisitors and their auxiliaries.

Procedure of the Inquisition.

The death penalty.

Innocent III.

Albigensian Crusade. No regular inquisition.

The Emperor Frederick II.

Gregory IX. creates the monastic inquisition.

The Dominicans.

Beginning of the inquisition.

who were partners of his heresy, or whom he knew or suspected to be heretics. If he confessed, and denounced his accomplices, relatives or friends, he was "reconciled" with the Church, and had to suffer only the humiliating penalties prescribed by the canon law. If further examination proved necessary, it was continued by various methods. Bernardus Guidonis enumerates many ways of obtaining confessions, sometimes by means of moral subterfuges, but sometimes also by a process of weakening the physical strength. And as a last expedient torture was resorted to. The Church was originally opposed to torture, and the canon law did not admit confessions extorted by that means; but by the bull *Ad extirpanda* (1252) Innocent IV. approved its use for the discovery of heresy, and Urban IV. confirmed this usage, which had its origin in secular legislation (cf. the Veronese Code of 1228, and Sicilian Constitution of Frederick II. in 1231). In 1312 excessive cruelty had to be suppressed by the council of Vienna. Canonically the torture could only be applied once, but it might be "continued." The next step was the torture of witnesses, a practice which was left to the discretion of the inquisitors. Moreover, all confessions or depositions extorted in the torture-chamber had subsequently to be "freely" confirmed. The confession was always considered as voluntary. The procedure was of course not litigious; any lawyer defending the accused would have been held guilty of heresy. The inquiry might last a long time, for it was interrupted or resumed according to the discretion of the judges, who disposed matters so as to obtain as many confessions or denunciations as possible. After the different phases of the examination, the accused were divided into two categories: (1) those who had confessed and abjured, (2) those who had not confessed and were consequently convicted of heresy. There was a third class, by no means the least numerous, namely, those who having previously confessed and abjured had relapsed into error. Next came the moment of the sentence: "there was never any case of an acquittal pure and simple" (H. C. Lea). The formula for full and complete acquittal given by Bernardus Guidonis in his *Practica*, should, he says, never or very rarely be employed. The sentences were solemnly pronounced on a Sunday, in a church or public place,

Use of torture.

Punishments.

in the presence of the inquisitors, their auxiliaries, the bishops, the secular magistrates and the people. This was the *sermo generalis* (see AUTO DA FÉ). The accused who had confessed were reconciled, and the penalties were then pronounced; these were, in order of severity, penances, fasting, prayers, pilgrimages (Palestine, St James of Compostella, Canterbury, &c.), public scourging, the compulsory wearing on the breast or back of crosses of yellow felt sewn on to the clothes or sometimes of tongues of red, letters, &c. These were the *poenae confusibiles* (humiliating). The inquisitors eventually acquired the right of inflicting fines at discretion. In 1244 and 1251 Innocent IV. revoked them for their exactions. All these minor penalties could be commuted for payments in money in the same way as absolution from the crusader's vow, and the council of Vienna tried to put an end to these extortions. Beyond these minor penalties came the severer ones of imprisonment for a period of time, perpetual imprisonment and imprisonment of various degrees of severity (*murus largus*, *murus strictus* vel *strictissimus*). The *murus strictus* consisted in the deepest dungeon, with single or double fetters, and "the bread and water of affliction"; but the severity of the prison régime varied very much. The *murus largus*, especially for a rich prisoner, amounted to a fairly mild imprisonment, but the mortality among those confined in the *murus strictus* became so high that Clement V. ordered an inquiry to be made into the prison régime in Languedoc, in spite of Bernard Guy's protest against the investigation as likely to diminish the prestige of the inquisitors. After the sentences had been pronounced, the obstinate heretics and renegades were for the last time called upon to submit and to confess and abjure. If they consented, they were received as penitents, and condemned on the spot to perpetual imprisonment; if they did not consent, they were handed over to the secular arm. When the heretic was handed over to the secular arm,

the agents of the secular power were recommended to punish him *debita animadversione*, and the form of recommending him to mercy was gone through. But, as M. Vacandard says, "If the secular judges had thought fit to take this formula literally, they would soon have been brought back to a recognition of the true state of affairs by excommunication." In effect, handing over to the secular arm was equivalent to a sentence of death, and of death by fire. The Dominican Jacob Sprenger, provincial of his order in Germany (1494) and inquisitor, does not hesitate to speak of the victims *quos incinerari fecimus* ("whom we [the inquisitors] caused to be burnt to ashes"). But we must accept the conclusions of H. C. Lea and Vacandard that comparatively few people suffered at the stake in the medieval Inquisition. Between 1308 and 1323, Bernard Guy, who cannot be accused of inactivity, only handed over to the secular arm 42 persons, out of 030 who were convicted of heresy.

"Handing over to the secular arm."

From the point of view of jurisprudence of the Inquisition, the confiscation of the condemned man's property by the ecclesiastical and secular powers is only the accompaniment to the more severe penalties of perpetual imprisonment or death; but from the point of view of its economic history the importance of the confiscation is supreme. The practice originated in the Roman law, and all secular princes had already, in their own interest, recognized it as lawful (Frederick Barbarossa, Decree of Verona; Louis VIII., ordinances of 1226, 1229; Louis IX., ordinance of 1234; Raymond VII. of Toulouse, &c.). In the kingdom of France there was a special official, the *procurateur des encours* (confiscation in the matter of heresy), whose duty it was to collect the personal property of the heretics, and to incorporate their landed estates in the royal domain; in Languedoc crying abuses arose, especially under the reign of Alphonse of Poitiers. Soon the papacy managed to gain a share of the spoils, even outside the states of the Church, as is shown by the bulls *ad extirpanda* of Innocent IV.

Punishment by confiscation of goods.

Abuse of the system.

and Alexander IV., and henceforward the inquisitors had, in varying proportions, a direct interest in these spoliation. In Spain this division only applied to the property of the clergy and vassals of the Church, but in France, Italy and Germany, the property of all those convicted of heresy was shared between the lay and ecclesiastical authorities. Venice alone decided that all the receipts of the Holy Office should be handed over in full to the state. Clement V., in his attempted reform and regularization of inquisitorial procedure, endeavoured to reduce the confiscations to a fairly reasonable minimum, and in 1337-1338 a series of papal inquiries was held into this financial aspect of the matter. The Assize of Clarendon, the Constitutions of Frederick II. (1232) and of Count Raymond of Toulouse (1234) had also come to a joint decision with the councils on this question. King Charles V. of France prevailed upon the papacy to abolish this regulation (1378). Confiscation was, indeed, most profitable to the secular princes, and there is no doubt that the hope of considerable gain was what induced many princes to uphold the inquisitorial administration, especially in the days of the decay of faith. The resistance of the south of France to the Capetian monarchs was to a large extent broken owing to the decimation of the bourgeoisie by the Inquisition and their impoverishment by the extortions of the *encours*. The same was the case in certain of the Italian republics; while in districts such as the north of France, where heretics were both poor and few and far between, the Inquisition did not easily take root, nor did it prove very profitable. These confiscations, the importance of which in the political and economic history of the middle ages was first shown fully by H. C. Lea, were a constant source of uncertainty in transactions of all kinds; there was, for instance, always a risk in entering into a contract in a place where the existence of heretics was suspected, since any contract entered into with a heretic was void in itself. Nor was there any more security in the transmission of inheritances for posthumous trials were frequent;

Economic and political importance of the system.

the *Liber sententiarum inquisitionis* of Bernardus Guidonis (1307-1323) records sentences pronounced after death against 39 persons during a period of 15 years. But not only was their property confiscated and their heirs disinherited; they were subject to still further penalties. Frederick II. extended to heresy the application of the Roman law disqualifying from holding office, and even included under its operation the children and grandchildren of the guilty man. Alexander IV. and Boniface VIII. lightened the severity of this law, and removed certain disqualifications, notably in the case of ecclesiastical offices and property.

Among other accessory penalties, we must notice the condemnation of books. There were many precedents for this: Constantine had had the Arian writings burnt, Theodosius II. and Valentinian III. those of the Nestorians and Manichaeans, Justinian the Talmud. In 1210 were burnt the books of David of Dinant and the *Periphysson* of Aristotle. In 1255 the *De periculis novissimorum temporum* of William of St Amour<sup>1</sup> was burnt by order of Pope Alexander IV., and from 1248 to 1310 was pronounced a series of condemnations of the Talmud. Nicholas Eymerich (c. 1320-1399), the Spanish inquisitor, demanded from Pope Gregory XI. the condemnation of Raymond Lully's books, and in 1376 obtained it, but before long the Lullists returned into favour with the pope and Eymerich was banished. This rebuff suffered by an inquisitor shows how uncertain the censure of books still was, even in a country where in less than two centuries' time it was to become one of the chief spheres of inquisitorial activity.

The definite object of the Inquisition was the prosecution of heresy; but its sphere of action was gradually extended by the theologians and casuists until sorcery and magic ranked with dogmatic heresy. The council of Valence (1248) dealt with sorcerers as well as sacrilegious persons, but did not treat them as heretics. Alexander IV. went further, declaring that divination and sorcery should only come within the competence of the inquisitor when they directly affected the unity or faith of the Church (9th December 1257; cf. bull *Quod super nonnullis*, 10th January 1260). Cases of simple sorcery were left to be dealt with by the ordinary judges. The distinction was very subtle, but it was not tampered with until 1451, at which date Nicholas V. gave the inquisitor Hugues Lenoir the cognizance of cases of divination, even when the crime did not savour of heresy. In dealing with such a subtle question, great variations had naturally arisen in practice, and the repression of sorcery was carried on jointly by the inquisitors, the bishops and the secular courts. John XXII., in consequence of a perfect epidemic of sorcery about 1320, handed over to the inquisitors for a time (1320-1333) all cases of crimes involving magic; but this measure was temporary and exceptional and only confirms the rule. There were various occasions during the middle ages when men's minds became infatuated, and it seemed as if the scourge of magic were likely entirely to destroy the Catholic faith; and during such times, morbidly infected with fear and the spirit of persecution, the ecclesiastical judges regained all their prestige. One of these crises culminated in the affair of the "Vauderie"<sup>2</sup> of Arras (1459), in which twelve unfortunates perished at the stake; and there were similar occurrences at the same period in Dauphiné and Gascony; of this nature again was the violent persecution in the Germanic countries begun by the bull *Summis desiderantes* of Innocent VIII. (5th December 1484), in the course of which the two authors of the *Malleus maleficorum*, the inquisitors Sprenger and Institoris (Heinrich Krämer), distinguished themselves as much by their knowledge of theoretical demonology as by their zeal as persecutors. In France

the secular authority was not long in claiming and obtaining jurisdiction over sorcerers (parlement of Paris, 1374), and as early as 1378 the university of Paris gave judgment in a case of demonology. Those unfortunates who were charged with sorcery gained, however, nothing by this change of jurisdiction, for they were invariably put to death.

The inquisitors could not take proceedings against Jews as such. They might profess their religion and observe its rites without being in a state of heresy; they were only heretic when they attacked the Christian faith or community, made proselytes, or returned to Judaism after being converted. Further, those who practised usury were "suspected of not holding very orthodox doctrine as to theft" (Vacandard), and on this account the Inquisition gained a hold on them. Pope Martin V. (6th November 1419) authorized inquisitors to take proceedings against usurers.

But these are merely extensions of competence resulting from the works of the casuists; the Inquisition was primarily the instrument for the repression of all kinds of breaches of orthodoxy. Its work in this capacity we will now describe in outline for each of the great countries of medieval Christendom. England, whether before or after the establishment of the Inquisition, had but few trials for heresy and, particularist in this as in all her religious activity, judged them according to her own discipline, without asking Rome for laws or special judges. In 1166, a few heretics having been apprehended, Henry II. called a council at Oxford and summoned them to appear before it; they all confessed, and were condemned to be scourged, branded on the face with the mark of a key, and expelled from the country, and by the 21st article of the Assize of Clarendon the king forbade any one to harbour on their lands or in the house any "of that sect of renegades who had been excommunicated at Oxford." Any one offending against this law was to be "at the king's mercy" and his house was to be "carried outside the town and burnt." The sheriffs were obliged to swear observance of this law and to require a similar oath from all barons' stewards, knights and free tenants. This was the first civil law against heresy since the end of the Roman empire, and preceded the famous rescripts of Frederick II. against sectaries in the 13th century. It should, however, be noted that the political acts of Henry II. and Frederick II. drew down the most explicit condemnation of the church. Orthodoxy remained almost unimpaired in England up till the time of Wycliffe. Apparently neither the Catharist, Waldensian nor Pantheistic heresies gained any footing in Great Britain. The affair of the Templars in France, which was quite political, was repeated in England: Clement V. having ordered their arrest, Edward II., after much hesitation, gave orders to the sheriffs to execute it and then decided that the *ecclesiastical* law should be applied. The papal inquisitors sent to England met with a bad reception, and the pope was obliged to forbid them to use torture, which was contrary to the laws of the kingdom. It was found impossible to establish the Templars' guilt and only canonical penalties were inflicted on them. The rising of the Lollards having alarmed both the church and the state, the article *De haeretico comburendo* was established by statute in 1401, and gained a melancholy notoriety during the religious struggles of the 16th century; it seems to have been not so much a measure for the safeguarding of dogma as a violent assertion of the secular absolutism. It was not till 1676 that Charles II. caused it to be abrogated, and obtained a decision that in cases of atheism, blasphemy, heresy, schism and other religious offences, the ecclesiastical courts should be confined to the penalties of excommunication, removal from office, degradation and other ecclesiastical means of censure, to the exclusion of the death penalty. Scotland was much later than England in giving up persecution and blood-

shed; and so late as 1696 a student of medicine aged eighteen and named Aikenhead was accused of heresy and hanged at Edinburgh. In Ireland Richard de Lederede or Ledred, a Franciscan and bishop of Ossory, in 1324 prosecuted on suspicion of heresy and for sorcery a certain Dame Alice

Condemnation of books.

Sorcery and magic.

The Inquisition and the Jews.

Treatment of heresy in the various countries.

England.

<sup>1</sup> Guillaume de St Amour (d. 1272), named after his birthplace in the Jura, was canon of Beauvais and rector of the university of Paris. He was conspicuous as the mouthpiece of the secular clergy in their attacks on the mendicant orders, the Dominicans in particular.

<sup>2</sup> The name of *vauderie*, i.e. the Vaudois or Waldensian heresy, had come to be used of witchcraft.

Kettle or Kyteler and her accomplices, Petronilla of Meath and her daughter Bassilla, who were accused of holding "nightly *ireland.* conference with a spirit called Robert Artisson, to whom she sacrificed in the high way nine red cocks and nine peacocks' eyes." The lady had powerful connexions, and her brother-in-law, Arnold le Powre, seneschal of Kilkenny, even went so far as to imprison the bishop. But in spite of the refusal of the secular authorities to co-operate with him, the bishop was strong enough to force them in 1325 to burn some of the accused. Dame Kettle herself, however, who had been cited to appear at Dublin before the dean of St Patrick's, escaped with the assistance of some of the nobles to England. Meanwhile the bishop, who had attempted to involve Arnold le Powre in the same charge, became involved in a quarrel with the administrators of the English government in Ireland; counter charges were brought against him, he was excommunicated by his metropolitan, Alexander de Bicknor, archbishop of Dublin; and in defiance of the king's commands, after publishing counter charges against the archbishop, he appealed to Rome and left the country. In 1335 Benedict XII. wrote to Edward III. deploring the absence of any inquisition in the king's dominions, and exhorting him to lend the aid of the secular arm in repressing heresy. Archbishop Alexander, who in 1347 was denounced as an abettor of heresy, died in 1349, and his successor was ordered to chastise those heretics who had taken refuge in the diocese from Richard de Lederede's violence, and whom his predecessor had protected. Finally, in 1354, Richard de Lederede himself was allowed to return to his diocese, where his zeal for persecution does not, however, seem to have found much further scope. He died in 1360.

The scene of the activities of the monastic Inquisition in France lay chiefly in the south. The repression of the Albigensian *France.* heresy (see ALBIGENSES) went on even when its importance had quite disappeared. The chronicle of the inquisitor Guilhem Pelhissou (d. 1268) shows us the most tragic episodes of the reign of terror which wasted Languedoc for a century. Guillaume Arnaud, Peter Cella, Bernard of Caux, Jean de St Pierre, Nicholas of Abbeville, Fouiques de St Georges, were the chief of the inquisitors who played the part of absolute dictators, burning at the stake, attacking both the living and the dead, confiscating their property and land, and enclosing the inhabitants both of the towns and the country in a network of suspicion and denunciation. The secular authorities were of the utmost assistance to them in this task; owing to the confiscations, the crown had too direct an interest in the success of the inquisitorial trials not to connive at all their abuses. Under the regency of Alphonse of Poitiers Languedoc was regularly laid under contribution by the *procureur des encours*. There were frequent attempts at retaliation, directed for the most part against the inquisitors, and isolated attacks were made on Dominicans. In 1234-1235 there were regular risings of the people at Albi and Narbonne, which forced the inquisitors to retreat. In 1235 the inquisitors were driven out of Toulouse. These risings were followed by terrible measures of repression, which, in turn, led to violent outbreaks on the part of the relatives, friends or compatriots of the sufferers. During the night of the 28th or 29th of May 1242 the inquisitors and their agents were massacred at the castle of Avignonet. This massacre led to a persecution which went on without opposition and almost without a lull for nearly fifty years. At the beginning of the 14th century the terrified people found a defender in the heroic Franciscan Bernard Delicieux. For a moment King Philip the Fair and Pope Clement V. seemed to interest themselves in the misfortunes of Languedoc, and the king of France sent down reformers; but they had no effect, their activity being restrained by the king himself, who was alarmed at a separatist movement which was arising in Languedoc. The work of repression which followed this moment of hope was carried out, between 1308 and 1323, by the inquisitor Bernard Guy, and completed the destruction of the Catharist heresy, the appearances of which after the middle of the 14th century became less and less frequent. Other heretics, for a time at least,

took their place, namely the Spirituals, who had developed out of a branch of the Franciscans, and were remotely disciples of Joachim, abbot of Floris (*q.v.*), and whom their rigid rule of absolute poverty led, by a reaction against the cupidity of the ordinary ecclesiastics, to repudiate any hierarchy and to uphold the doctrines of Peter John de Oliva against the word of the pope. On the 17th of February 1317 John XXII. condemned all these irregular followers of St Francis, "*fraticelli, fratres de paupere vita, bisochi or beghini*," and the Inquisition of Languedoc was at once set in motion against them. Four *spirituals* were burnt at Marseilles in 1318, and soon the persecution was extended to the Franciscan *beguins* or *tertiarii*, many people being burnt about 1320 at Narbonne, Lunel, Béziers, Carcassonne, &c. The persecution stopped for lack of an object, for the small groups of beguins were soon destroyed, and those of the *Spirituals* who were not sent to the stake or to prison were compelled by the papacy to enter other orders than the Franciscan. The Waldenses (*q.v.*) were more difficult to destroy: originally less dangerous to the church than the Cathari, they resisted longer, and their dispersal in scattered communities aided their long resistance.

In the north of France the workings of the Inquisition were very intermittent; for there were fewer heretics there than in the south, and as they were poorer, there was less zeal on the part of the secular arm to persecute them. At its outset, however, the Inquisition in the north of France was marked by a series of melancholy events: the inquisitor Robert le Bougre, formerly a Catharist, spent six years (1233-1239) in going through the Nivernais, Burgundy, Flanders and Champagne, burning at the stake in every place unfortunates whom he condemned without a judgment, supported as he was by the ecclesiastical authorities and by princes such as Theobald of Champagne. The pope was forced to put a check on his zeal, and, after an inquiry, condemned him to imprisonment for life. We know that there were inquisitors settled in Île de France, Orléanais, Touraine, Lorraine and Burgundy during the 12th century, but we know next to nothing of what they did. In the 14th century, the Flemish and German heresies of the Free Spirit made their appearance in France; in 1310 a heretic named Marguerite Porette was burnt at Paris, and in 1373 another named Jeanne Daubenton, both of whom seem to have professed a kind of rudimentary pantheism, the latter being the head of a sect called the Turlupins. The Turlupins reappeared in 1421 at Arras and Douai and were persecuted in a similar way. But in the 15th century, with the exception of a few condemnations aimed against the Hussites, the Inquisition acted but feebly against heresy, which, as in the famous case of the "Vauderie" of Arras, was often nothing but fairly ordinary sorcery.

From the middle of the 14th century onward, the parlement had taken upon itself the right of hearing appeals from persons sentenced by the Inquisition. And the University again, by its faculty of theology, escaped the jurisdiction of the Inquisition. It was these two great bodies which at the time of the Reformation took the place of the Inquisition in dealing with heresy.

In Italy heresy not infrequently took on a social or political character; it was sometimes almost indistinguishable from the opposition of the Ghibellines or the communalist *Italy.* spirit of independence. Lombardy, besides a number of Cathari, contained a certain number of vaguely-defined sects against whom the efforts of the Apostolic Visitors sent by Innocent III. were not of much effect. From the very earliest days of the Inquisition, John of Vicenza, Roland of Cremona and Rassiario Sacchoni directed their persecutions against Lombardy, and especially against Milan. St Peter Martyr, who was conspicuous for his bigoted violence, was assassinated in 1252. On the 20th of March 1256 Alexander IV. ordered the provincial of the friar preachers of Lombardy to increase the number of inquisitors in that province from four to eight. At Florence both heresy and Ghibellinism were alike crushed by the terrible severities of Fra Ruggieri, and indulgences were promised to all who should aid in the extinction of heresy in



Tuscany. Certain districts revolted against this violence, which threatened to devastate Italy as it had devastated Provence; in 1277 Fra Corrado Pagano was killed on an expedition against the heretics of the Vattelline, and two years after the people of Parma rose against the inquisitors. Besides, this reign of terror only raised to a furious pitch the passionate and independent piety of the Italian peoples. The body of a heretic, Armano Ponzilupo, who was killed at Ferrara in 1269, was venerated by the people, and his mediation was even invoked, until the Inquisition had to suppress this cult. But it had a harder struggle against the successes of Gerard Legarelli, and especially Dolcino (see APOSTOLIC), which only came to an end after a long and difficult trial of the adepts of the Messianist sect of Guglielmo, some of whom belonged to the noble families of Lombardy. Up till the beginning of the 14th century, however, the power of the Inquisition steadily increased, and at this period Zanghino Ugolini appeared as the most skillful exponent of its theory and procedure. About the same time Charles of Anjou introduced the Inquisition into the Two Sicilies, but it could rarely effect anything there; the religious cohesion of the country was weak, and refugees were sure of safe hiding, both Waldenses and Fraticelli being frequently harboured there. When Sicily passed into the hands of Peter III. of Aragon, moreover, it came into a position of open hostility to the Holy See and became a refuge for heretics.

Venice always preserved its autonomy as regards the repression of heresy; she was perfectly orthodox, but remained entirely independent of Rome; Innocent IV. sent inquisitors there, but the heretics continued actually to be subject to the secular tribunals. In 1288 a compromise was arrived at, and the papal Inquisition was admitted into the republic, but only on condition that it should remain under the control of the secular power; thus there was established a mixed régime which survived till the last days of the Venetian state. In Savoy the Inquisition constantly carried on severe measures against the Waldenses of the Alps. During the 14th and 15th centuries there was an uninterrupted succession of trials.

As regards the papal states, "it was in the nature of things that, by a confusion of the two personages, the pope should consider all opposition to him *qua* Italian prince as resistance offered to the head of the church, *i.e.* to the church" (Ch.V. Langlois). The Colonna had a personal animosity against the Gaetani; therefore Boniface VIII., a Gaetao, declared the Colonna to be heretics. Rienzi was accused of heresy for having questioned the temporal sovereignty of the pope at Rome. The Venetians, who in 1300 opposed the annexation of Ferrara by Clement V. to the detriment of the house of Este, were proclaimed heretics and placed under the ban of Christendom. Savonarola was attacked because he interfered with the policy of Alexander VI. at Florence. It was this same desire for the hegemony of Italy which inspired the attitude of the popes throughout the middle ages, causing them to excommunicate, apparently without reason so far as doctrine was concerned, the Visconti of Milan, the Della Scala of Verona, the Maffredi of Faenza, &c., and prompting them to lay under an interdict or preach a crusade against certain rebellious great towns (Clement V. against Venice, John XXII. against Milan). Further, in each of the great cities of Lombardy and Tuscany, the papal party directed the local inquisition, and this power was rarely abused.

In Germany heresies, especially of a mystical character, were numerous in the middle ages; some of them affected the mass of the people, and led to religious and social movements of no little importance. The repression of heresy went on by fits and starts, and the Inquisition was never exercised so regularly in the Germanic as in certain of the Latin countries. At the outset of the 13th century persecutions of the Waldenses and Ortlibarii (followers of Ortlib of Strassburg, c. 1200) took place at Strassburg; measures were taken locally until, in 1231, Gregory IX. issued definite instructions to the German prelates with a view to a regular repression of heresy, and gave full powers to execute them to Conrad of Marburg. Certain

nobles having offered him resistance, he preached a crusade against them, but died by the hand of an assassin. The council of Mainz (April 1234) dealt gently with Conrad's murderers, but severely with the false witnesses whom he had employed. Shortly before (February 1234), the diet of Frankfurt had decided, in spite of the pope's injunctions, that the destruction of heresy should be entrusted to the ordinary magistrates. And besides, thanks to the struggle between the Empire and the papacy, the German prelates always limited the prerogatives of the papal Inquisition. Again, by the municipal laws of the north (*Sachsenspiegel*) the ecclesiastical jurisdiction in the matter of heresy was very much limited, while the *Schwabenspiegel* (municipal laws for southern Germany) does not seem to be aware of the existence of any inquisitorial jurisdiction or procedure. When in the 14th century communities of Beghards developed with extraordinary rapidity, it was the episcopal authority, both at Cologne and Strassburg, which undertook to deal with these groups of sectaries, and at the very height of the conflict between the Empire and the papacy. Marsilius of Padua, the theoretical exponent of the imperial rights, attributes to the secular judge the right and obligation to punish heresy, the priest's rôle being merely advisory. In 1353 Innocent VI. tried to implant the papal Inquisition in Germany once for all; its success was but short, and Urban V.'s attempt in 1362 succeeded little better, in spite of the fact that Charles IV. (edicts of Lucca, June 1366) gave him the support of the secular power. Towards 1372, however, Gregory XI. succeeded in regularizing the exercise of the powers of the papal inquisitors on German soil; and the latter, notably Kerlinger, Hetstede, &c., set to work to destroy the communities of the Beghards, to burn their books, to close those *beguinages* which were under suspicion, and to check by more or less violent means mystical epidemics such as those of the "flagellants," "dancers," &c. But these measures provoked angry protests from the people, the secular magistrates and even the bishops, so that Gregory XI., perceiving that he was face to face with the popular party, invited the bishops to control the inquiries of his own envoys. At the end of the 15th century the two inquisitions were acting concurrently.

In Bohemia and the provinces subject to it the Waldenses had found their chosen country, and by the middle of the 13th century their propagation was very flourishing. In **Bohemia.** 1245 Innocent IV. ordered the bishops to prosecute them with the aid of the secular arm, and in 1257, at the request of King Přemysl Ottokar II., Alexander IV. introduced the Inquisition into Bohemia. But from this date till 1335 inquisitorial missions succeeded one another without effecting any sensible diminution in the material and moral strength of the heresy. The Waldenses had been joined by other sectaries, the Luciferani, and especially the Brethren of the Free Spirit. It was in vain that the bishops of Bohemia and Silesia carried on during the second half of the 14th century an active campaign against heresy; the spirit of criticism which had arisen with regard to the morals, and even to the dogmas of the church, was already preparing the way for Hussitism.

In the regions east of the Adriatic, Catharism, the first communities of which had very probably settled here, was supreme in the time of Innocent III. and Honorius III. The first Dominicans who established themselves in these parts had much to suffer from the aggression of those very heretics whom they had come to convert. Gregory XI., implacable in his persecution of Catharism, preached a crusade against them in 1234, and Bosnia was laid waste by fire and sword. But in spite of these violent measures Catharism only gained strength in the churches of Bulgaria, Rumania, Slavonia and Dalmatia. In 1298 Boniface VIII. tried to organize the Inquisition there, but the project remained fruitless. The attempt was revived in 1323 by John XXII. with doubtful success. The persecutions undertaken in the 14th and 15th centuries merely resulted in binding the Cathari to the invading Turks, with whom they found more tolerance than with the Slav princes converted to Roman orthodoxy.

**States of the Church.**

**Bohemia.**

**The Balkan States.**

In Spain the papal Inquisition could gain no solid footing in the middle ages. Spain had been, in turn or simultaneously, *Spain*. Arian under the Visigoths, Catholic under the Hispano-Romans, Mussulman by conquest, and under a régime of religious peace Judaism had developed there. After the reconquest, and even at the height of the influence of the Cathari its heresies had been of quite minor importance. At the end of the 12th century Alphonso II, and Peter II. had on principle promulgated cruel edicts against heresy, but the persecution seemed to be dormant. By the bull *Declinante* of the 26th of May 1232 inquisitors were sent to Aragon by Gregory IX. on the request of Raymond of Penaforte, and by 1237-1238 the Inquisition was practically founded. But as early as 1233 King James I. had promulgated an edict against the heretics which quite openly put the Inquisition in a subaltern position, and secularized a great part of its activities. The people, moreover, showed great hostility towards it. The inquisitor Fray Pedro de Cadrayta was murdered by the mob, and in 1235 the Cortes, with the consent of King James, prohibited the use of inquisitorial procedure and of the torture, as constituting a violation of the *Fueros*, though they made no attempt to give effect to their prohibition. In Castile Alphonso the Wise had, by establishing in his *Fuero Real* and his *Siete Partidas* an entirely independent secular legislation with regard to heretics (1255), removed his kingdom from all papal interference. At the opening of the 14th century Castile and Portugal had still no Inquisition. But at that time in Spain orthodoxy was generally threatened only by a few Fraticelli and Waldenses, who were not numerous enough to call for active repression. The Spanish inquisitor Nicholas Eymerich, the author of the famous *Directorium Inquisitorum*, had rarely to exercise his functions during the whole of his long career (end of 14th century). It was not against heresy that the church had to direct its vigilance. A mutual tolerance between the different religions had in fact sprung up, even after the conquest; the Christians in the north recognized the Mahomedan and Jewish religions, and Alphonso VI. of Castile took the title of *emperador de los dos cultos*. But for a long time past both the decisions of councils and papal briefs had proclaimed their surprise and indignation at this ominous indifference. As early as 1077 the third council of Rome, and in 1081 Gregory VII., protested against the admission of Jews to public offices in Spain. Clement IV., in a brief of 1266, exhorted James I. of Aragon to expel the Moors from his dominions. In 1278 Nicholas III. blamed Peter III. for having made a truce with them. One of the canons of the council of Vienne (1311-1312) denounces as intolerable the fact that Mahomedan prayers were still proclaimed from the top of the mosques, and under the influence of this council the Spanish councils of Zamora (1313) and Valladolid (1322) came to decisions which soon led to violent measures against the Mudegares (Mussulmans of the old Christian provinces). Already in 1210 massacres of Jews had taken place under the inspiration of Arnold of Narbonne, the papal legate; in 1276 fresh disturbances took place as a result of James I.'s refusal to obey the order of Clement IV., who had called upon him to expel the Jews from his dominions. In 1278 Nicholas IV. commanded the general of the Dominicans to send friars into all parts of the kingdom to work for the conversion of the Jews, and draw up lists of those who should refuse to be baptized. It was in vain that a few princes such as Peter III. or Ferdinand of Castile interfered; the Spanish clergy directed the persecution with ever increasing zeal. In the 14th century the massacres increased, and during the year 1301 whole towns were destroyed by fire and sword, while at Valencia eleven thousand forced baptisms took place. In the 15th century the persecution continued in the same way; it can only be said that the years 1449, 1462, 1470, 1473 were marked by the greatest bloodshed. Moreover, the Mudegares were also subjected to these baptisms and massacres *en masse*. From those, or the children of those who had escaped death by baptism, was formed the class of *Conversos* or *Marranos*, the latter name being confined to the converted Jews. This class was still further increased after the conquest of the kingdom of

Granada and the completion of the conquest by Ferdinand and Isabella, and after the pacification of the kingdoms of Aragon and Valencia by Charles V. The Mahomedans and Jews in these parts were given the choice between conversion and exile. Being of an active nature, and desiring some immediate powers as a recompense for their moral sufferings, the Jewish or Mussulman *Conversos* soon became rich and powerful. In addition to the hatred of the church, which feared that it might quickly become Islamized or Judaized in this country which had so little love for theology, hatred and jealousy arose also among laymen and especially in the rich and noble classes. *Limpieza*, i.e. purity of blood, and the fact of being an "old Christian" were made the conditions of holding offices. It is true, this mistrust had assumed a theological form even before the Mahomedan conquest. As early as 633 the council of Toledo had declared heretics such converts, forced or voluntary, as returned to their old religion. When this principle was revived and, whether through secular jealousy, religious dislike or national pride, was applied to the *Conversos*, an essentially national Inquisition, directed against local heretics, was founded in Spain, and founded without the help of the papacy. It was created in 1480 by Ferdinand and Isabella. Sixtus IV. had wished the papal Inquisition to be established after the form and spirit of the middle ages; but Ferdinand, in his desire for centralization (his efforts in this direction had already led to the creation of the Holy Hermandad and the extension of the royal jurisdiction) wished to establish an inquisition which should be entirely Spanish, and entirely royal. Rome resisted, but at last gave way. Sixtus IV., Alexander VI., Innocent VIII., Julius II. and after them all the popes of the 16th century, saw in this secular attempt a great power in favour of orthodoxy, and approved it when established, and on seeing its constant activity. The Inquisition took advantage of this to claim an almost complete autonomy. The decisions of the Roman Congregation of the Index were only valid for Spain if the Holy Office of Madrid (thought good to countersign them; consequently there were some books approved at Rome and proscribed in the peninsula, such as the *Historia pelagiana* of Cardinal Nores, and some which were forbidden at Rome and approved in the peninsula, such as the writings of Fathers Mateo Moya and Juan Bautista Pozza. The Spanish Holy Office perceived long before Rome the dangers of mysticism, and already persecuted the mystics, the *Alumbrados* while Rome (impervious to Molinism) still favoured them. "During the last few centuries the church of Spain was at once the most orthodox and the most independent of the national churches" (Ch. V. Langlois). There was even a financial dispute between the Inquisition and the papacy, in which the Inquisition had the better of the argument; the Roman Penitentiary sold exemptions from penalties (involving loss of civil rights), such as prison, the galleys and wearing the *sambenio*, and dispensations from the crime of *Marrania* (secret Judaism). The inquisitors tried to gain control of this sale, and at a much higher price, and were seconded in this by the kings of Spain, who saw that it was to their own interest. At first they tried a compromise; the unfortunate victims had to pay twice, to the pope and to the Inquisition. But the payment to the pope was held by the Inquisition to reduce too much its own share of the confiscated property, and the struggle continued throughout the first half of the 16th century, the Curia finally triumphing, thanks to the energy of Paul III. Since, however, the Inquisition continued to threaten the holders of papal dispensations, most of them found it prudent to demand a definite rehabilitation, in return for payments both to the king and the Inquisition. As a national institution the Inquisition had first of all the advantage of a very strong centralization and very rapid procedure, consisting as it did of an organization of local tribunals with a supreme council at Madrid, the *Suprema*. The grand inquisitor was *ex officio* president for life of the royal council of the Inquisition. It was the grand inquisitor, General Jimenez de Cisneros, who set in motion the inquisitorial tribunals of Seville, Cordova, Jaen, Toledo, Murcia, Valladolid and Calahorra. There was no such tribunal at Madrid till the time of Philip IV. The inquisitor-

general of Aragon established inquisitors at Saragossa, Barcelona, Valencia, Majorca, Sardinia, Sicily and Pampeluna (moved later to Calahorra). From the very beginning the papacy strengthened this organization by depriving the Spanish metropolitans, by the bull of the 25th of September 1487, of the right of receiving appeals from the decisions given jointly by the bishops of the various dioceses, their suffragans and the apostolic inquisitors, and by investing the inquisitor-general with this right. And, more than this, Torquemada actually took proceedings against bishops, for example, the accusation of heresy against Don Pedro Aranda, bishop of Calahorra (1498); while the inquisitor Lucero prosecuted the first archbishop of Granada, Don Fernando de Talavera. Further, when once the Inquisition was closely allied to the crown, no Spaniard, whether clerk or layman, could escape its power. Even the Jesuits, though not till after 1660, were put under the authority of the Suprema. The highest nobles were kept constantly under observation; during the reigns of Charles III. and Charles IV. the duke of Almodovar, the count of Aranda, the great writer Campomanes, and the two ministers Melchior de Jovellanos and the count of Florida-Alanca, were attacked by the Suprema. But the descendants of Moors and Jews, though they were good Christians, or even nobles, were most held in suspicion. Even during the middle ages the descendants of the Paterenes were known, observed and denounced. In the eyes of the Inquisition the taint of heresy was even more indelible. A family into which a forced conversion or a mixed marriage had introduced Moorish or Jewish blood was almost entirely deprived of any chance of public office, and was bound, in order to disarm suspicion, to furnish agents or spies to the Holy Office. The Spaniards were very quick to accept the idea of the Inquisition to such an extent as to look upon heresy as a national scourge to be destroyed at all costs, and they consequently considered the Inquisition as a powerful and indispensable agent of public protection; it would be going too far to state that this conception is unknown to orthodox present-day historians of the Inquisition, and especially certain Spanish historians (cf. the preface to Menendez y Pelayo's *Heterodoxos españoles*). As had happened among the Albigenses, commerce and industry were rapidly paralysed in Spain by this odious régime of suspicion, especially as the *Conversos*, who inherited the industrial and commercial capacity of the Moors and Jews, represented one of the most active elements of the population. Besides, this system of wholesale confiscations might reduce a family to beggary in a single day, so that all transactions were liable to extraordinary risks. It was in vain that the counsellors of Charles V., and on several occasions the Cortes, demanded that the inquisitors and their countless agents should be appointed on a fixed system by the state; the state, and above all the Inquisition, refused to make any such change. The Inquisition preferred to draw its revenues from heresy, and this is not surprising if we think of the economic aspect of the Albigensian Inquisition; the system of *encours* was simply made general in Spain, and managed to exist there for three centuries. In the case of the Inquisition in Languedoc, there still remained the possibility of an appeal to the king, the inquisitors, or more rarely the pope, against these extortions; but there was nothing of the kind in Spain. The Inquisition and the Crown could refuse each other nothing, and appeals to the pope met with their united resistance. As early as the reign of Ferdinand certain rich *Conversos* who had bought letters of indulgence from the Holy See were nevertheless prosecuted by Ferdinand and Torquemada, in spite of the protests of Sixtus IV. The papacy met with the most serious checks under the Bourbons. Philip V. forbade all his subjects to carry appeals to Rome, or to make public any papal briefs without the royal *executatur*.

The political aspect of the work and character of the Inquisition has been very diversely estimated; it is a serious error to attribute to it, as has too often been done, extreme ideas of equality, or even to represent it as having favoured centralization and a royal absolutism to the same extent as the Inquisition of the 13th and 14th centuries in Languedoc. "It was a mere

coincidence," says H. C. Lea, "that the Inquisition and absolutism developed side by side in Spain." The Suprema did not attack all nobles as nobles; it attacked certain of them as *Conversos*, and the Spanish feudal nobles were sure enough of their *limpieza* to have nothing to fear from it. But it is undeniable that it frequently tended to constitute a state within the state. At the time of their greatest power, the inquisitors paid no taxes, and gave no account of the confiscations which they effected; they claimed for themselves and their agents the right of bearing arms, and it is well known that their declared adversaries, or even those who blamed them in some respects, were without fail prosecuted for heresy. But that was not the limit to their pretensions. In 1574, under Philip II., there was an idea of instituting a military order, that of Santa Maria de la Espada Blanca, having as its head the grand inquisitor, and to him all the members of the order, *i.e.* all Spaniards distinguished by *limpieza* of blood, were to swear obedience in peace and in war. Moreover, they were to recognize his jurisdiction and give up to him the reversion of their property. Nine provinces had already consented, when Philip II. put a stop to this theocratic movement, which threatened his authority. It was, however, only the Bourbons, who had imbibed Gallician ideas, who by dint of perseverance managed to make the Inquisition subservient to the Crown, and Charles III., "the philosopher king," openly set limits to the privileges of the inquisitors. Napoleon, on his entry into Madrid (December 1808), at once suppressed the Inquisition, and the extraordinary general Cortes on the 12th of February 1813 declared it to be incompatible with the constitution, in spite of the protests of Rome. Ferdinand VII. restored it (July 21, 1814) on his return from exile, but it was impoverished and almost powerless. It was again abolished as a result of the Liberal revolution of 1820, was restored temporarily in 1823 after the French military intervention under the duc d'Angoulême, and finally disappeared on the 15th of July 1834, when Queen Christina allied herself with the Liberals. "It was not, however, till the 8th of May 1869 that the principle of religious liberty was proclaimed in the peninsula; and even since then it has been limited by the constitution of 1876, which forbids the public celebration of dissident religions" (S. Reinach). In 1816 the pope abolished torture in all the tribunals of the Inquisition. It is a too frequent practice to represent as peculiar to the Spanish Inquisition modes of procedure in use for a long time in the inquisitorial tribunals of the rest of Europe. There are no special manuals, or *practica*, for the inquisitorial procedure in Spain; but the few distinctive characteristics of this procedure may be mentioned. The Suprema allowed the accused an advocate chosen from among the members or familiars of the Holy Office; this privilege was obviously illusory, for the advocate was chosen and paid by the tribunal, and could only interview the accused in presence of an inquisitor and a secretary. The theological examination was a delicate and minute proceeding; the "qualifiers of the Holy Office," special functionaries, whose equivalent can, however, easily be found in the medieval Inquisition, charged those books or speeches which had incurred "theological censures," with "slight, severe or violent" suspicion. There was no challenging of witnesses; on the contrary, witnesses who were objected to were allowed to give evidence on the most important points of the case. The torture, to the practice of which the Spanish Inquisition certainly added new refinements, was originally very much objected to by the Spaniards, and Alphonso X. prohibited it in Aragon; later, especially in the 15th, 16th and 17th centuries it was applied quite shamelessly on the least suspicion. But by the end of the 18th century, according to Llorente, it had not been employed for a long time; the *fiscal*, however, habitually demanded it, and the accused always went in dread of it. The punishment of death by burning was much more often employed by the Spanish than by the medieval Inquisition; about 2000 persons were burnt in Torquemada's day. Penitents were not always reconciled, as they were in the middle ages, but those condemned to be burnt were as a rule strangled previously.

With the extension of the Spanish colonial empire the

Inquisition spread throughout it almost contemporaneously with the Catholic faith. Ferdinand IV. decreed the establishment of the Inquisition in America, and Jimenes in 1516 appointed Juan Quevedo, bishop of Cuba, inquisitor-general delegate with discretionary powers. Excesses having been committed by the agents of the Holy Office, Charles V. decreed (October 15, 1538) that only the European colonists should be subject to the jurisdiction of the inquisition; but Philip II. increased the powers of the inquisitors' delegate and, in 1541, established on a permanent basis three new provinces of the Inquisition at Lima, Mexico and Cartagena. The first *auto-da-fé* took place at Mexico in 1574, the year in which Hernando Cortez died. The Inquisition of Portugal was no less careful to ensure the orthodoxy of the Portuguese colonies. An Inquisition of the East Indies was established at Goa, with jurisdiction over all the dominions of the king of Portugal beyond the Cape of Good Hope. Finally Philip II. even wished to establish an **itinerant** Inquisition, and at his request the pope created, by a brief of the 21st of July 1571, the "Inquisition of the galleys," or "of fleets and armies."

After the expulsion of the Jews under Isabella the Catholic (1492), followed under Philip III. by that of the Moriscos (1600), the Inquisition attacked especially Catholics descended from infidels, the *Marranes* and *Conversos*, who were, not without reason, suspected of often practising in secret the rites of their ancestral religions. As late as 1715 a secret association was discovered at Madrid, consisting of twenty families, having a rabbi and a synagogue. In 1727 a whole community of Moriscos was denounced at Granada, and prosecuted with the utmost rigour. Again, a great number of people were denounced, sent to the galleys, or burnt, for having returned to their ancestral religion, on the flimsiest of evidence, such as making ablutions during the day time, abstaining from swine's flesh or wine, using henna, singing Moorish songs, or possessing Arabic manuscripts. During the 16th and 17th centuries the Inquisition in Spain was directed against Protestantism. The inquisitor-general, Fernando de Valdés, archbishop of Seville, asked the pope to condemn the Lutherans to be burnt even if they were not backsliders, or wished to be reconciled, while in 1560 three foreign Protestants, two Englishmen and a Frenchman were burnt in defiance of all international law. But the Reformation never had enough supporters in Spain to occupy the attention of the Inquisition for long. After the *Marranes* the mystics of all kinds furnished the greatest number of victims to the terrible tribunal. Here again we should not lose sight of the tradition of the medieval Inquisition; the mysticism of the Beghards, the Brethren of the Free Spirit and the innumerable pantheist sects had been pitilessly persecuted by the inquisitors of Germany and France during the 14th and 15th centuries. The Illuminati (*alumbrosos*), who were very much akin to the medieval sectaries, and the mystics of Castile and Aragon were ruthlessly examined, judged and executed. Not even the most famous persons could escape the suspicious zeal of the inquisitors Valdés and Melchior Cano. The writings of Luis de Granada were censured as containing *cosas de alumbrosos*. St Ignatius de Loyola was twice imprisoned at the beginning of his career; St Theresa was accused of misconduct, and several times denounced; one of her works, *Conceptos del amor divino*, was prohibited by the Inquisition, and she was only saved by the personal influence of Philip II. Countless numbers of obscure visionaries, devotees both men and women, clerks and laymen, were accused of Illuminism and perished in the fires or the dungeons of the Inquisition. From its earliest appearance Molinism was persecuted with almost equal rigour. Molinos himself was arrested and condemned to perpetual imprisonment (1685-1687), and during the 18th century, till 1781, several Molinists were burnt. The Inquisition also attacked Janensism, freemasonry (from 1738 onwards; cf. the bull *In eminenti*) and "philosophism," the learned naturalist José Clavigo y Faxarcho (1730-1806), the mathematician Benito Bails (1730-1797),

the poet Tomas de Iriarte, the ministers Clavigo Ricla, Aranda and others being prosecuted as "philosophers." Subject also to the tribunal of the Holy Office were bigamists, blasphemers, usurers, sodomites, priests who had married or broken the secrecy of the confessional, laymen who assumed ecclesiastical costume, &c. "In all these matters, though the Inquisition may have been indiscreet in meddling with affairs which did not concern it, it must be confessed that it was not cruel, and that it was always preferable to fall into the hands of the Inquisition rather than those of the secular judges, or even the Roman inquisitors" (S. Reinach). Apart from certain exceptional cruelties such as those of the Inquisition of Calahorra, perhaps the greatest number of executions of sorcerers took place in the colonies, in the Philippines and Mexico. In Spain the persecution was only moderate; at certain times it disappeared almost completely, especially in the time of the clear-sighted inquisitor Salazar.

Two features of the Spanish Inquisition are especially noteworthy: the prosecutions for "speeches suspected of heresy" and the censure of books. The great scholar Pedro de Lerma, who after fifty years at Paris (where he was dean of the faculty of theology) had returned to Spain as abbot of Compluto, was called upon in 1537 to abjure eleven "Erasmanian" propositions, and was forced to return to Paris to die. Juan de Vergara and his brother were summoned before the Inquisition for favouring Erasmus and his writings, and detained several years before they were acquitted. Fray Alonso de Virues, chaplain to Charles V., was imprisoned on an absurd charge of depreciating the monastic state, and was only released by the pope at the instance of the emperor. Mateo Pascual, professor of theology at Alcalá, who had in a public lecture expressed a doubt as to purgatory, suffered imprisonment and the confiscation of his goods. A similar fate befell Montemayor, Las Brozas and Luis de la Cadena.

The censure of books was established in 1502 by Ferdinand and Isabella as a state institution. All books had to pass through the hands of the bishops; in 1521 the Inquisition took upon itself the examination of books suspected of Lutheran heresy. In 1554 Charles V. divided the responsibility for the censorship between the Royal Council, whose duty it was to grant or refuse the *imprimatur* to manuscripts and the Inquisition, which retained the right of prohibiting books which it judged to be pernicious; but after 1527 it also gave the licence to print. In 1547 the Suprema produced an Index of prohibited books, drawn up in 1546 by the university of Louvain; it was completed especially as regards Spanish books, in 1551, and several later editions were published. Moreover, the *revisores de libros* might present themselves in the name of the Holy Office in any private library or bookshop and confiscate prohibited books. In 1558 the penalty of death and confiscation of property was decreed against any bookseller or individual who should keep in his possession condemned books. The censure of books was eventually abolished in 1812.

BIBLIOGRAPHY.—A critical bibliography was drawn up by P. Fredericq in the preface to the French translation (1900) of H. C. Lea's important standard work: *History of the Inquisition in the Middle Ages* (3 vols., London, 1888). See also J. Havet, *L'Hérésie et le bras séculier au moyen âge jusqu'au XIII<sup>e</sup> siècle*, in *Œuvres complètes*, vol. II. (Paris, 1896); Ch. V. Langlois, *L'Inquisition d'après des travaux récents* (Paris, 1891); Douais, *L'Inquisition* (Paris, 1907); E. Vacandard, *L'Inquisition* (Paris, 1907); Douais, *Documents pour servir à l'histoire de l'Inquisition dans le Languedoc* (2 vols., Paris, 1900); Dellinger, *Beiträge zur Sektengeschichte des Mittelalters* (2 vols., Munich, 1890). The second volume is composed of documents; Molinier, *L'Inquisition dans le midi de la France au XIII<sup>e</sup> et au XIV<sup>e</sup> siècle. Étude sur les sources de son histoire* (Paris, 1880); P. Fredericq, *Corpus documentorum inquisitionis haereticae pravitatis neerlandicae (1205-1525)* (4 vols., Ghent, 1889-1900); Tanon, *Histoire des tribunaux de l'inquisition en France* (Paris, 1893); Hansen, *Inquisition, Hexenwahn und Hexenerfolgung* (Munich, 1900); Liorente, *Histoire critique de l'Inquisition d'Espagne* (4 vols., Paris, 1818); H. C. Lea, *History of the Inquisition of Spain* (5 vols., London, 1905-1908); S. Reinach, articles on Lea's *History of the Inquisition of Spain* in the *Revue critique* (1906, 1907, 1908) and *Cultes, mythes et religions* (Paris, 1908), tome III. (P. A.)

**INSANITY** (from Lat. *in*, not, and *sanus*, sound), a generic term applied to certain morbid mental conditions produced by defect or disease of the brain. The synonyms in more or less frequent use are *lunacy* (from a supposed influence of the moon), *mental disease*, *alienation*, *derangement*, *aberration*, *madness*, *unsoundness of mind*. The term *Psychiatri* (ψυχή, mind, and *larpeia*, treatment) is applied to the study and treatment of the condition.

### I. MEDICAL AND GENERAL

There are many diseases of the general system productive of disturbance of the mental faculties, which, either on account of their transient nature, from their being associated with the course of a particular disease, or from their slight intensity, are not included under the head of insanity proper. From a strictly scientific point of view it cannot be doubted that the fever patient in his delirium, or the drunkard in his excitement or stupor, is insane; the brain of either being under the influence of a morbid agent or of a poison, the mental faculties are deranged; yet such derangements are regarded as functional disturbances, *i.e.* disturbances produced by agencies which experience tells will, in the majority of cases, pass off within a given period without permanent results on the tissues of the organ. The comprehensive scientific view of the position is that all diseases of the nervous system, whether primary or secondary, congenital or acquired, should, in the words of Griesinger, be regarded as one inseparable whole, of which the so-called mental diseases comprise only a moderate proportion. However important it may be for the physician to keep this principle before him, it may be freely admitted that it cannot be carried out fully in practice, and that social considerations compel the medical profession and the public at large to draw an arbitrary line between such functional diseases of the nervous system as *hysteria*, *hypochondriasis* and *delirium* on the one hand, and such conditions as *mania*, *melancholia*, *stupor* and *dementia* on the other.

All attempts at a short definition of the term "insanity" have proved unsatisfactory; perhaps the nearest approach to accuracy is attained by the rough statement that it is a *symptom of disease of the brain inducing disordered mental symptoms*—the term disease being used in its widest acceptance. But even this definition is at once too comprehensive, as under it might be included certain of the functional disturbances alluded to, and too exclusive, as it does not comprehend certain rare transitory forms. Still, taken over all, this may be accepted as the least defective short definition; and moreover it possesses the great practical advantage of keeping before the student the primary fact that insanity is the result of disease of the brain (see BRAIN, and NEUROPATHOLOGY), and that it is not a mere immaterial disorder of the intellect. In the earliest epochs of medicine the corporeal character of insanity was generally admitted, and it was not until the superstitious ignorance of the middle ages had obliterated the scientific, though by no means always accurate, deductions of the early writers, that any theory of its purely psychical character arose. At the present day it is unnecessary to combat such a theory, as it is universally accepted that the brain is the organ through which mental phenomena are manifested, and therefore that it is impossible to conceive of the existence of an insane mind in a healthy brain. On this basis insanity may be defined as consisting in *morbid conditions of the brain, the results of defective formation or altered nutrition of its substance induced by local or general morbid processes, and characterized especially by non-development, obliteration, impairment or perversion of one or more of its psychical functions*. This insanity is not a simple condition; it comprises a large number of diseased states of the brain, gathered under one popular term, on account of mental defect or aberration being the predominant symptom.

The insanities are sharply divided into two great classes—the *Congenital* and the *Acquired*. Under the head of *Congenital* insanity must be considered all cases in which, from whatever cause, brain development has been arrested, with consequent

impotentiality of development of the mental faculties; under that of *Acquired Insanity* all those in which the brain has been born healthy but has suffered from morbid processes affecting it primarily, or from diseased states of the general system implicating it secondarily. In studying the causation of these two great classes, it will be found that certain remote influences exist which are believed to be commonly predisposing; these will be considered as such, leaving the proximate or exciting causes until each class with its subdivisions comes under review.

In most treatises on the subject will be found discussed the bearing which civilization, nationality, occupation, education, &c., have, or are supposed to have, on the production of insanity. Such discussions are as a rule eminently unsatisfactory, founded as they are on common observation, broad generalizations, and very imperfect statistics. As they are for the most part negative in result, at the best almost entirely irrelevant to the present purpose, it is proposed merely to summarize shortly the general outcome of what has been arrived at by those authorities who have sought to assess the value to be attached to the influence exercised by such factors, without entering in any detail on the theories involved. The causes of insanity may be divided into (a) general, and (b) proximate.

(a) **GENERAL CAUSES.**—1. *Civilization*.—Although insanity is by no means unknown amongst savage races, there can be no reasonable doubt that it is much more frequently developed in civilized communities; also that, as the former come under the influence of civilization, the percentage of lunacy is increased. This is in consonance with the observation of disease of whatever nature, and is dependent in the case of insanity on the wear and tear of nerve tissue involved in the struggle for existence, the physically depressing effects of pauperism, and on the abuse of alcoholic stimulants; each of which morbid factors falls to be considered separately as a proximate cause. In considering the influence of civilization upon the production of insanity, regard must be had to the more evolved ethical attitude towards disease in general which exists in civilized communities as well as to the more perfect recognition and registration of insanity.

2. *Nationality*.—In the face of the imperfect social statistics afforded by most European and American nations, and in their total absence or inaccessibility amongst the rest of mankind, it is impossible to adduce any trustworthy statement under this head.

3. *Occupation*.—There is nothing to prove that insanity is in any way connected with the prosecution of any trade or profession *per se*. Even if statistics existed (which they do not) showing the proportion of lunatics belonging to different occupations to the 1000 of the population, it is obvious that no accurate deduction could be drawn.

4. *Education*.—There is no evidence to show that education has any influence over either the production or the prevention of insanity. The general result of discussions on the above subjects has been the production of a series of arithmetical statements, which have either a misleading bearing or no bearing at all on the question. In the study of insanity statistics are of slight value from the scientific point of view, and are only valuable in its financial aspects.

5. *Innate causes*.—The hereditary transmission of liability to mental disease must be reckoned as the most important among all predisposing causes of insanity. It is probably well within the mark to say that at least 50% of the insane have a direct or collateral hereditary tendency towards insanity. The true significance of this factor cannot as yet be explained or described shortly and clearly, but it cannot be too definitely stated that it is not the insanity which is inherited, but only the predisposition to the manifestation of mental symptoms in the presence of a sufficient exciting cause. The most widely and generally accepted view of the exciting cause of insanity is that the predisposed brain is breaking down under mental stress or bodily privations. There is, however, another view which has been recently advanced to the effect that the majority of mental diseases are secondary to bodily disorders, hereditary predisposition being the equally predisposing causal factor. There is probably truth in both these views, and such an admission accentuates the complexity of the factorship of heredity. If insanity can be induced by physical disorders, which must essentially be of the nature of toxic action or of mechanical agency which can alter or influence the functional powers of the brain, then it is probable that hereditary predisposition to insanity means, not only the transmission of an unstable nervous system, but also a constitution which is either peculiarly liable to the production of such toxic or poisonous substances, or incapable of effectively dealing with the toxins or poisonous substances normally formed during metabolic processes. Such a view broadens our conception of the factorship of hereditary transmission and offers

Classification.

Causation.

explanation as to the manner in which insanity may appear in families previously free from the taint. Very frequently we find in the history of insane patients that although there may be no insanity in the family there are unfoubted indications of nervous alongside of physical instability, the parental nervous defects taking the form of extreme nervousness, vagabondage, epilepsy, want of mental balance, inequality in mental development or enervation, extreme mental instability, or in direction associated with marked deficiency in others, the physical defects showing themselves in the form of insanity; liability to tubercular and rheumatic infections. The failure of constitutional power which allows of the invasion of the tubercle bacillus and the micrococcus rheumaticus in certain members of a family is apparently closely allied to that which favours the development of mental symptoms in others.

6. *Consanguinity*.—It has been strongly asserted that consanguineous marriage is a prolific source of nervous instability. There is considerable diversity of opinion on this subject; the general outcome of the investigations of many careful inquirers appears to be that the offspring of healthy cousins of a healthy stock is not more liable to nervous disease than that of unrelated parents, but that evil consequences follow where there is a strong tendency in the family to degeneration, not only in the direction of the original diathesis, but also towards instability of the nervous system. The objection to the marriage of blood relations does not arise from the bare fact of their relationship, but has its ground in the fear of their having a vicious variation of constitution, which, in their children, is prone to become intensified. There is sufficient evidence adducible to prove that close breeding is productive of degeneration; and when the multifarious functions of the nervous system are taken into account, it may almost be assumed, not only that it suffers concomitantly with other organs, but that it may also be the first to suffer independently.

7. *Parental Weakness*.—Of the other causes affecting the parents which appear to have an influence in engendering a predisposition to insanity in the offspring, the abuse of alcoholic stimulants and opium, over-exertion of the mental faculties, advanced age and weak health may be cited. Great stress has been laid on the influence exercised by the first of these conditions, and many extreme statements have been made regarding it. Such statements must be accepted with reserve, for, although there is reason for attaching considerable weight to the history of ancestral intemperance as a probable causating influence, it has been generally assumed as the proved cause by those who have treated of the subject, without reference to other agencies which may have acted in common with it, or quite independently of it. However unsatisfactory from a scientific point of view it may be, the general statement must stand that whatever tends to lower the nervous energy of a parent may modify the development of the progeny. Constitutional tendency to nervous instability once established in a family may make itself felt in various directions—epilepsy, hysteria, hypochondriasis, neuralgia, certain forms of paralysis, insanity, eccentricity. It is asserted that exceptional genius in an individual member is a phenomenal indication. Confined to the question of insanity, the morbid inheritance may manifest itself in two directions—in defective brain organization manifesting from birth, or from the age at which its faculties are potential, *i.e.* congenital insanity; or in the neurotic diathesis, which may be present in a brain to all appearance congenitally perfect, and may present itself merely by a tendency to break down under circumstances which would not affect a person of originally healthy constitution.

8. *Periodic Influence*.—The evolutionary periods of puberty, adolescence, utero-gestation, the climacteric period and old age exercise an effect upon the nervous system. It may be freely admitted that the nexus between physiological processes and mental states is as regular in certain of these periods, obscure, and that the causal relation is dependent more on its want than on demonstration; but it may be pleaded that it is not more obscure in respect of insanity than of many other diseases. The pathological difficulty obtains mostly in the relation of the earlier evolutionary periods, puberty and adolescence, to insanity; in the others a physiologic-pathological nexus may be traced; but in regard to the former there is nothing to take hold of except the purely physiological process of development of the sexual function, the expansion of the intellectual powers, and rapid increase of the bulk of the body. Although in thoroughly stable subjects due provision is made for these evolutionary processes, it is not difficult to conceive that in the nervously unstable a considerable risk is run by the brain in consequence of the strain laid on it. Between the adolescent and climacteric periods the constitution of the nervous, as of the other systems, becomes established, and disturbance is not likely to occur, except from some accidental circumstances apart from evolution. In the most healthily constituted individuals the "change of life" expresses itself by some loss of vigour. The nourishing (trophæic) nutrition becomes less active, and either vigour decays or is wasted or there is a tendency towards restitution in bulk of tissues by a less highly organized material. The most important instance of the latter tendency is fatty degeneration of muscle, to which the arterial system is very liable. In the mass of mankind those changes assume no pathological

importance: the man or woman of middle life passes into advanced age without serious constitutional disturbance; on the other hand, there may be a break down of the system due to involutional changes in special organs, as, for instance, fatty degeneration of the heart. In all probability the insanity of the climacteric period may be referred to two pathological conditions: it may depend on structural changes in the brain due to fatty degeneration of its substance, and also it may be a secondary result of general systemic disturbance, as indicated by cessation of menstruation in the female and possibly by some analogous modification of the sexual function in men. The senile period brings with it further reduction of formative activity; all the tissues waste, and are liable to fatty and calcareous degeneration. Here again, the arteries of the brain are very generally implicated; atheroma in some degree is almost always present, but is by no means necessarily followed by insanity.

The various and profound modifications of the child which attend the periods of utero-gestation, pregnancy and child-bearing do not leave the nervous centres unaffected. Most women are liable to slight changes of disposition and temper, morbid longings, strange likes and dislikes during pregnancy, more especially during the earlier months; but these are universally accepted as accompaniments of the condition not involving any doubts as to sanity. But there are various factors at work in the system during pregnancy which have grave influence on the nervous system, more especially in those hereditarily predisposed, and in those gravid for the first time. There is modification of direction of the blood towards a new focus, intensification of changes in the system of the capillary fibrin and water and a decrease of albumen. To such physical influences are superadded the discomfort and uneasiness of the situation, mental anxiety and anticipation of danger, and in the unmarried the horror of disgrace. In the puerperal (recently delivered) woman there are to be taken into pathological account, in addition to the dangers of sepsis, the various depressing influences of child-bed, its various accidents reducing vitality, the sudden return to ordinary physiological conditions, the rapid call for a new focus of nutrition, the translation as it were of the blood supply from the uterus to the mammae—all physical influences liable to affect the brain. These influences may act independently of moral shock; but, where this is coincident, there is a condition of the nervous system unprepared to resist its action.

(b) *PROXIMATE CAUSES*.—The proximate causes of insanity may be divided into (1) toxic agents, (2) mechanical injury to the brain, including apoplexies and tumours, and (3) arterial degeneration.

1. *Toxic Agents*.—The definite nature of the symptoms in the majority of the forms of acute insanity leave little reason to doubt that in their origin they are due to the invasion of the system of various kinds. The symptoms referred to may be briefly indicated as follows: (i.) Pyrexia, or fever generally of an irregular type; (ii.) Hyperleucocytosis, or an increase of the white blood corpuscles, which is the chief method by which the animal organism protects itself against the noxious influence of micro-organisms and their toxins. In such cases as typhoid fever, which is caused by a bacillus, or Malta fever which is caused by a coccus, it is found that if the blood serum of the patient is mixed *in vitro* with a broth culture of the infecting organism in a dilution of 1 in 50, that the bacilli or the cocci, as the case may be, when examined microscopically, are seen to run into groups or clusters. The organisms are said to be agglutinated, and the substance in the serum which produces this reaction is termed an agglutinine. In many of the forms of insanity which present the symptom of hyperleucocytosis there can also be demonstrated the fact that the blood serum of the patients contains agglutinines to certain members of a group of streptococci (so called on account of their tendency to grow in the form of a chain, *σπέρτροι*); (iii.) the rapid organic affection of the special nerve elements of the brain from the violence of the toxins; (iv.) the resistance of the individual to its influence; (v.) the marked physical deterioration as indicated by emaciation and other changes in nutrition; (v.) the close analogy between the character of many of the mental symptoms, *e.g.* delirium, hallucinations or depression, and the symptoms produced artificially by the administration of certain poisonous drugs.

The toxic substances which are generally believed to be associated with the causation of mental disorders may be divided into three great classes: (a) those which arise from the morbid products of metabolism within the body itself, the auto-intoxicants; (b) those due to the invasion of the blood or tissues by micro-organisms; (c) organic or inorganic poisons introduced into the system voluntarily or accidentally.

(a) Auto-intoxication may be due to defective metabolism or to physiological instability, or to both combined. The results of defective metabolism are most clearly manifested in the mental symptoms which not infrequently accompany such diseases as gout, diabetes or obesity, all of which depend primarily upon a defective chemical elaboration of the products of metabolism. The association of gout and rheumatism with nervous and mental diseases is historical, and the gravest forms of spinal and cerebral degeneration have been found in association with diabetes. Until the pathology of these affections is better understood we are not in a position to determine the nature of the toxins which appear to be the cause of these diseases and of their accompanying nervous

symptoms. Physiological instability is usually manifested by neurotic persons under the strain of any unusual change in their environment. If, for instance, any material change in the food supply consisting either in a decrease of its quality or quantity, or in a failure to assimilate it properly, the nerve-cells become exhausted and irritable, sleep is diminished and a condition known as the delirium of collapse or exhaustion may supervene. An extreme instance of this condition is presented by the delirium occurring in shipwrecked persons, who having to take to the boats are suddenly deprived of food, water or both. Poisoning of the nervous system may also result from the defective action of special glands such as the thyroid, the liver or the kidneys. These conditions are especially exemplified in the mental disturbances which accompany exophthalmic goitre, uraemic poisoning, and the conditions of depression which are observed in jaundice and other forms of hepatic insufficiency.

The results of modern research point to a growing belief in the frequency of infection of the nervous system from the hosts of micro-organisms which infest the alimentary tract. No definite or substantiated discoveries have as yet been formulated which would justify us in treating this source of infection as more than a highly probable causative influence.

(b) When we turn, however, to the potentiality of infection by micro-organisms introduced from without into the system we are upon surer if not upon entirely definite ground. A special form of insanity called by Weber, who first described it, the delirium of collapse, was observed by him to follow certain infectious diseases such as typhus fever and pneumonia. In later years it has been frequently observed following attacks of influenza. Recently our views have broadened and we find that the delirium of collapse is an acute, confusional insanity which may arise without any previous febrile symptoms, and is in fact one of the common forms of acute insanity. The nature of the physical symptoms, the mental confusion and hallucinations which accompany it, as well as the fact that it frequently follows some other infective disease, leave no doubt as to its toxic origin. A similar and analogous condition is presented by incidence of general paralysis after a previous syphilitic infection. The symptoms of general paralysis coupled with the extensive and rapid degeneration of not only the nervous but of the whole of the body tissues point to a microbial disease of intense virulence which, though probably not syphilitic, is yet induced, and enhanced in its action by the previous devitalizing action of the syphilitic toxin. There is abundant evidence to show that emotions which powerfully affect the mind, if long continued, conduce towards a condition of metabolic change, which in its turn deleteriously affects the nervous system, and which may terminate in inducing a true toxic insanity.

One of the best examples of insanity arising from micro-organisms is that form which occurs after childbirth, and which is known as puerperal mania. Other insanities may, in truth, arise at this period, but those which occur within the first fourteen days after parturition are generally of infective origin. The confusional nature of the mental symptoms, the delirium and the physical symptoms are sufficient indications of the analogy of this form of mental aberration with such other toxic forms of insanity as we find arising from septic wounds and which sometimes accompany the early toxic stages of virulent infective diseases such as typhus, diphtheria or malignant scarlet fever.

The infective origin of puerperal mania is undoubted, though, as yet, no special pathogenic organism has been isolated. Dr. Douglas (*Ed. Med. Journ.*, 1897, i. 413) found the staphylococcus pyogenes aureus present in the blood in one case; Jackman (quoted *loc. cit.*) found the micrococcus pneumoniae croupose in one case; while Haultain (*Ed. Med. Journ.*, 1897, ii. 131) found only the bacillus coli communis in the blood and secretions of several cases. From our experience of similar mental and physical symptoms produced as a result of septic wounds or which succeed surgical operations there seems to be no doubt that several forms of micrococci or streptococci of a virulent character are capable by means of the toxins they exude of causing acute delirium or mania of a confusional clinical type when introduced into the body.

(c) Accidental and voluntary poisonings of the system which result in insanity are illustrated by the forms of insanity which follow phosphorus or lead poisoning and by Pellagra. The voluntary intoxication of the system by such drugs as morphia and alcohol will be treated of below.

2 and 3. Mechanical injuries to the brain arise from direct violence to the skull, from apoplectic hemorrhage or embolism, or from rapidly growing tumours, or from arterial degeneration.

The forms of insanity may be divided into (I.) Congenital Mental Defect and (II.) Acquired Insanity.

**Forms of Insanity.**  
I. *Congenital Mental Defect.*—The morbid mental conditions which fall to be considered under this head are *Idiocy* (with its modification, *Imbecility*) and *Cretinism* (q.v.).

**IDIOCY** (from Gr. *ἰδιότης*, in its secondary meaning of a deprived person). In treating of idiocy it must be carefully

borne in mind that we are dealing with mental phenomena dissociated for the most part from active bodily disease, and that, in whatever degree it may exist, we have to deal with a brain condition fixed by the pathological circumstances under which its possessor came into the world or by such as had been present before full cerebral activity could be developed, and the symptoms of which are not dependent on the intervention of any subsequent morbid process. From the earliest ages the term *Amentia* has been applied to this condition, in contradistinction to *Dementia*, the mental weakness following on acquired insanity.

The causes of congenital idiocy may be divided into four classes: (1) hereditary predisposition, (2) constitutional conditions of one or both parents affecting the constitution of the infant, (3) injuries of the infant prior to or at birth, and (4) injuries or diseases affecting the infant head during infancy. All these classes of causes may act in two directions: they may produce either non-development or abnormal development of the cranial bones as evidenced by microcephalism, or by deformity of the head; or they may induce a more subtle morbid condition of the constituent elements of the brain. As a rule, the pathological process is more easily traceable in the case of the last three classes than in the first. For instance, in the case of constitutional conditions of the parents we may have a history of syphilis, a disease which often leaves its traces on the bones of the skull; and in the third case congenital malformation of the brain may be produced by mechanical causes acting on the child in utero, such as an attempt to procure abortion, or deformities of the maternal pelvis rendering labour difficult and instrumental interference necessary. In such cases the bones of the skull may be injured; it is only fair, however, to say that more brains are saved than injured by instrumental interference. With regard to the fourth class, it is evident that the term congenital is not strictly applicable; but, as the period of life implicated is that prior to the potentiality of the manifestation of the intellectual powers, and as the result is identical with that of the other classes of causes, it is warrantable to connect it with them, on pathological principles more than as a mere matter of convenience.

Dr Ireland, in his work *On Idiocy and Imbecility* (1877), classifies idiots from the standpoint of pathology as follows: (1) Genetous idiocy: in this form, which he holds to be complete before birth, he believes the presumption of heredity to be stronger than in other forms; the vitality of the general system is stated to be lower than normal; the palate is arched and narrow, the teeth misshapen, irregular and prone to decay and the patient dwarfish in appearance; the head is generally unsymmetrical and the commissures occasionally atrophied; (2) Microcephalic idiocy, a term which explains itself; (3) Eclamptic idiocy, due to the effects of infantile convulsions; (4) Epileptic idiocy; (5) Hydrocephalic idiocy, a term which explains itself; (6) Paralytic idiocy, a rare form, due to the brain injury causing the paralysis; (7) Traumatic idiocy, a form produced by the third class of causes above mentioned; (8) Inflammatory idiocy; (9) Idiocy by deprivation of one or more of the special senses.

The general conformation of the idiot is generally imperfect; he is sometimes deformed, but more frequently the frame is merely awkwardly put together, and he is usually of short stature. Only about one-fourth of all idiots have heads smaller than the average. Many cases are on record in which the cranial measurements exceed the average. It is the irregularity of development of the bones of the skull, especially at the base, which marks the condition. Cases, however, often present themselves in which the skull is perfect in form and size. In such the mischief has begun in the brain matter. The palate is often highly arched; hare-lip is not uncommon; in fact congenital defect or malformation of other organs than the brain is more commonly met with among idiots than in the general community. Of the special senses, hearing is most frequently affected. Sight is good, although co-ordination may be defective. Many are mute. On account of the mental dullness it is difficult to determine whether the senses of touch, taste and smell suffer

impairment; but the impression is that their acuteness is below the average. It is needless to attempt a description of the mental phenomena of idiots, which range between utter want of intelligence and mere weakness of intellect.

The term *Imbecility* has been conventionally employed to indicate the less profound degrees of idiocy, but in point of fact no distinct line of demarcation can be drawn between the conditions. As the scale of imbeciles ascends it is found that the condition is evidenced not so much by obtuseness as by irregularity of intellectual development. This serves to mark the difference between the extreme stupidity of the lowest of the healthy and the highest forms of the morbidly deprived type. The two conditions do not merge gradually one into the other. Absolute stupidity and sottishness mark many cases of idiocy, but only in the lowest type, where no dubiety of opinion can exist as to its nature, and in a manner which can never be mistaken for the dulness of the man who is less talented than the average of mankind. Where in theory the morbid (in the sense of deprivation) and the healthy types might be supposed to approach each other, in practice we find that, in fact, no debatable ground exists. The uniformity of dulness of the former stands in marked opposition to the irregularity of mental conformation in the latter. Comparatively speaking, there are few idiots or imbeciles who are uniformly deprived of mental power; some may be utterly sottish, living a mere vegetable existence, but every one must have heard of the quaint and crafty sayings of manifest idiots, indicating the presence of no mean power of applied observation. In institutions for the treatment of idiots and imbeciles, children are found not only able to read and write, but even capable of applying the simpler rules of arithmetic. A man may possess a very considerable meed of receptive faculty and yet be idiotic in respect of the power of application; he may be physically disabled from relation, and so be manifestly a deprived person, unfit to take a position in the world on the same platform as his fellows.

Dr Ireland subdivides idiots, for the purpose of education, into five grades, the first comprising those who can neither speak nor understand speech, the second those who can understand a few easy words, the third those who can speak and can be taught to work, the fourth those who can be taught to read and write, and the fifth those who can read books for themselves. The treatment of idiocy and imbecility consists almost entirely of attention to hygiene and the building up of the enfeebled constitution, along with endeavours to develop what small amount of faculty exists by patiently applied educational influences. The success which has attended this line of treatment in many public and private institutions has been very considerable. It may be safely stated that most idiotic or imbecile children have a better chance of amelioration in asylums devoted to them than by any amount of care at home.

In the class of idiots just spoken of, imperfect development of the intellectual faculties is the prominent feature, so prominent that it masks the arrest of potentiality of development of the moral sense, the absence of which, even if noticed, is regarded as relatively unimportant; but, in conducting the practical study of congenital idiots, a class presents itself in which the moral sense is wanting or deficient, whilst the intellectual powers are apparently up to the average. It is the custom of writers on the subject to speak of "intellectual" and "moral" idiots. The terms are convenient for clinical purposes, but the two conditions cannot be dissociated, and the terms therefore severally only imply a specially marked deprivation of intellect or of moral sense in a given case. The everyday observer has no difficulty in recognizing as a fact that deficiency in receptive capacity is evidence of imperfect cerebral development; but it is not so patent to him that the perception of right or wrong can be compromised through the same cause, or to comprehend that loss of moral sense may result from disease. The same difficulty does not present itself to the pathologist; for, in the case of a child born under circumstances adverse to brain development, and in whom no process of education can develop an appreciation of what is right or wrong, although the intellectual faculties appear

to be but slightly blunted, or not blunted at all, he cannot avoid connecting the physical peculiarity with the pathological evidence. The world is apt enough to refer any fault in intellectual development, manifested by imperfect receptivity, to a definite physical cause, and is willing to base opinion on comparatively slight data; but it is not so ready to accept the theory of a pathological implication of the intellectual attributes concerned in the perception of the difference between right and wrong. Were, however, two cases pitted one against another—the first one of so-called intellectual, the second one of so-called moral idiocy—it would be found that, except as regards the psychological manifestations, the cases might be identical. In both there might be a family history of tendency to degeneration, a peculiar cranial conformation, a history of previous symptoms during infancy, and of a series of indications of mental incapacities during adolescence, differing only in this, that in the first the prominent indication of mental weakness was inability to add two and two together, in the second the prominent feature was incapacity to distinguish right from wrong. What complicates the question of moral idiocy is that many of its subjects can, when an abstract proposition is placed before them, answer according to the dictates of morality, which they may have learnt by rote. If asked whether it is right or wrong to lie or steal they will say it is wrong; still, when they themselves are detected in either offence, there is an evident non-recognition of its concrete nature. The question of moral idiocy will always be a moot one between the casuist and the pathologist; but, when the whole natural history of such cases is studied, there are points of differentiation between their morbid depravation and mere moral depravity. Family history, individual peculiarities, the general bizarre nature of the phenomena, remove such cases from the category of crime.

*Statistics.*—According to the census returns of 1901 the total number of persons described as idiots and imbeciles in England and Wales was 48,882, the equality of the sexes being remarkable, namely, 24,480 males and 24,402 females. Compared with the entire population the ratio is 1 idiot or imbecile to 665 persons, or 15 per 10,000 persons living. Whether the returns are defective, owing to the sensitiveness of persons who would desire to conceal the occurrence of idiocy in their families, we have no means of knowing; but such a feeling is no doubt likely to exist among those who look upon mental infirmity as humiliating, rather than as one of the many physical evils which afflict humanity. Dr. Ireland estimates that there is 1 idiot or imbecile to every 500 persons in countries that have a census. The following table shows the number of idiots according to official returns of the various countries:—

	Males.	Females.	Total.	Proportion to 100,000 of Pop.
England and Wales	24,480	24,402	48,882	150
Scotland . . . . .	3,246	3,377	6,623	148
Ireland . . . . .	2,946	2,270	5,216	117
France (including cretins) (1872)	20,456	14,677	35,133	97
Germany (1871) . . . . .	—	—	33,739	82
Sweden (1870) . . . . .	—	—	1,632	38
Norway (1891) . . . . .	1,357	1,074	2,431	121
Denmark (1888-89) . . . . .	2,166	1,751	3,857	200

For the United States there are no later census figures than 1890 when the feeble-minded or idiotic were recorded as 95,571 (52,940 males and 42,631 females). In 1904 (*Special Report of Bureau of Census, 1906*) the "feeble-minded" were estimated at 150,000.

The relative frequency of congenital and acquired insanity in various countries is shown in the following table, taken from Koch's statistics of insanity in Württemberg, which gives the number of idiots to 100 lunatics:—

Prussia . . . . .	158	France . . . . .	66
Bavaria . . . . .	154	Denmark . . . . .	58
Saxony . . . . .	162	Sweden . . . . .	22
Austria . . . . .	53	Norway . . . . .	65
Hungary . . . . .	140	England and Wales . . . . .	74
Canton of Bern . . . . .	117	Scotland . . . . .	68
America . . . . .	79	Ireland . . . . .	69

It is difficult to understand the wide divergence of these figures, except it be that in certain states, such as Prussia and Bavaria, dements have been taken along with aments and in others cretins.



This cannot, however, apply to the case of France, which is stated to have only 66 idiots to every 100 lunatics. In many districts of France cretinism is common; it is practically unknown in England, where the proportion of idiots is stated as higher than in France; and it is rare in Prussia, which stands at 158 idiots to 100 lunatics. Manifestly imperfect as this table is, it shows how important an element idiocy is in social statistics; few are aware that the number of idiots and that of lunatics approach so nearly.

II. *Acquired Insanity*.—So far as the mental symptoms of acquired insanity are concerned, Pinel's ancient classification, *Acquired Insanity*, into *Mania*, *Melancholia* and *Dementia*, is still applicable to every case, and although numerous classifications have been advanced they are for the most part merely terminological variations. Classifications of the insanities based on pathology and etiology have been held out as a solution of the difficulty, but, so far, pathological observations have failed to fulfil this ideal, and no thoroughly satisfactory pathological classification has emerged from them.

Classifications are after all matters of convenience; the following system admittedly is so:—

Melancholia.

Mania.

Delusional Insanity.

Katonia.

Hebephrenia.

Traumatic Insanity.

Insanity following upon arterial degeneration.

Insanities associated or caused by: General Paralysis; Epilepsy;

Insanities associated with or caused by Alcoholic and Drug intoxication; Delirium Tremens, Chronic Alcoholic Insanity, Dipomania, Morphism.

Senile Insanity.

The general symptoms of acquired insanity group themselves naturally under two heads, the physical and the mental.

The physical symptoms of mental disease generally, if not invariably, precede the onset of the mental symptoms, and the patient may complain of indefinite symptoms of malaise for weeks and months before it is suspected that the disorder is about to terminate in mental symptoms.

*General symptoms.*

The most general physical disorder common to the onset of all the insanities is the failure of nutrition, *i.e.* the patient rapidly and apparently without any apparent cause loses weight. Associated with this nutritional failure it is usual to have disturbances of the alimentary tract, such as loss of appetite, dyspepsia and obstinate constipation. During the prodromal stage of such conditions as mania and melancholia the digestive functions of the stomach and intestine are almost or completely in abeyance. To this implication of other systems consequent on impairment of the trophical (nourishment-regulating) function of the brain can be traced a large number of the errors which exist as to the causation of idiopathic melancholia and mania. Very frequently this secondary condition is set down as the primary cause; the insanity is referred to derangements of the stomach or bowels, when in fact these are, concomitantly with the mental disturbance, results of the cerebral mischief. Doubtless these functional derangements exercise considerable influence on the progress of the case by assisting to deprave the general economy, and by producing depressing sensations in the region of the stomach. To them may probably be attributed, together with the apprehension of impending insanity, that phase of the disease spoken of by the older writers as the *stadium melancholicum*, which so frequently presents itself in incipient cases.

The skin and its appendages—the hair and the nails—suffer in the general disorder of nutrition which accompanies all insanities. The skin may be abnormally dry and scurfy or moist and offensive. In acute insanities rashes are not uncommon, and in chronic conditions, especially conditions of depression, crops of papules occur on the face, chest and shoulders. The hair is generally dry, loses its lustre and becomes brittle. The nails become deformed and may exhibit either excessive and irregular or diminished growth.

Where there are grave nutritional disorders it is to be expected that the chief excretions of the body should show departures from the state of health. In this article it is impossible

to treat this subject fully, but it may suffice to say that in many states of depression there is a great deficiency in the excretion of the solids of the urine, particularly the nitrogenous waste products of the body; while in conditions of excitement there is an excessive output of the nitrogenous waste products. It has lately been pointed out that in many forms of insanity indoxyl is present in the urine, a substance only present when putrefactive processes are taking place in the intestinal tract.

The nervous system, both on the sensory and motor side, suffers very generally in all conditions of insanity. On the sensory side the special senses are most liable to disorder of their function, whereby false sense impressions arise which the patient from impairment of judgment is unable to correct, and hence arise the psychical symptoms known as hallucinations and delusions. Common sensibility is generally impaired.

On the motor side, impairment of the muscular power is present in many cases of depression and in all cases of dementia. The incontinence of urine so frequently seen in dementia and in acute insanity complicated with the mental symptom of confusion depends partly on impairment of muscular power and partly on disorder of the sensory apparatus of the brain and spinal cord.

The outstanding mental symptom in nearly all insanities, acute and recent or chronic, is the failure of the capacity of judgment and loss of self-control. In early acute insanities, however, the two chief symptoms which are most evident and easily noted are depression on the one hand and excitement or elevation on the other. Some distinction ought to be made between these two terms, excitement and elevation, which at present are used synonymously. Excitement is a mental state which may be and generally is associated with confusion and mental impairment, while elevation is an exaltation of the mental faculties, a condition in which there is no mental confusion, but rather an unrestrained and rapid succession of fleeting mental processes.

The symptoms which most strongly appeal to the lay mind as conclusive evidence of mental disorder are hallucinations and delusions. Hallucinations are false sense impressions which occur without normal stimuli. The presence of hallucinations certainly indicates some functional disorder of the higher brain centres, but is not an evidence of insanity so long as the sufferer recognizes that the hallucinations are false sense impressions. So soon, however, as conduct is influenced by hallucinations, then the boundary line between sanity on the one hand and insanity on the other has been crossed. The most common hallucinations are those of sight and hearing.

Delusions are not infrequently the result of hallucinations. If the hallucinations of a melancholic patient consist in hearing voices which make accusatory statements, delusions of sin and unworthiness frequently follow. Hallucinations of the senses of taste and smell are almost invariably associated with the delusion that the patient's food is being poisoned or that it consists of objectionable matter. On the other hand, many delusions are apparently the outcome of the patient's mental state. They may be pleasant or disagreeable according as the condition is one of elevation or depression. The intensity and quality of the delusions are largely influenced by the intelligence and education of the patient. An educated man, for instance, who suffers from sensory disturbances is much more ingenious in his explanations as to how these sensory disturbances result from electricity, marconigrams, X-rays, &c., which he believes are used by his enemies to annoy him, than an ignorant man suffering from the same abnormal sensations. Loss of self-control is characteristic of all forms of insanity. Normal self-control is so much a matter of race, age, the state of health, moral and physical upbringing, that it is impossible to lay down any law whereby this mental quality can be gauged, or to determine when deficiency has passed from a normal to an abnormal state. In many cases of insanity there is no difficulty in appreciating the pathological nature of the deficiency, but there are others in which the conduct is otherwise so rational that one is apt to attribute the deficiency to physiological rather than to pathological causes. Perversion of the moral sense is common to all the insanities, but is often the only symptom to be noticed in cases of imbecility and idiocy, and it as a rule may be the earliest symptom noticed in the early stages of the excitement of manic-depressive insanity and general paralysis.

The tendency to commit suicide, which is so common among the insane and those predisposed to insanity, is especially prevalent in patients who suffer from depression, sleeplessness and delusions of persecution. Suicidal acts may be divided into accidental, impulsive and premeditated. The accidental suicides occur in patients who are partially or totally unconscious of their surroundings, and are generally the result of terrifying hallucinations, to escape

from which the patient jumps through a window or runs blindly into water or some other danger. Impulsive suicides may be prompted by suddenly presented opportunities or means of self-destruction, such as the sight of water, fire, a knife, cord or poison. Premeditated suicides most frequently occur in states of long continued depression. Such patients frequently devote their attention to only one method of destruction and fail to avail themselves of others equally practicable. As a rule the more educated the patient, the more ingenious and varied are the methods adopted to attain the desired result.

The faculty of attention is variously affected in the subjects of insanity. In some the attention is entirely subjective, being occupied by sensations of misery, depression or sensory disturbances. In others the attention is objective, and attracted by every accidental sound or movement. In most of the early acute insanities the capacity of attention is wholly abolished, while in hebephrenia the stage of exhaustion which follows acute excitement, and the condition known as secondary dementia, loss of the power of attention is one of the most prominent symptoms. The memory for both recent and remote events is impaired or abolished in all acute insanities which are characterized by confusion and loss of impairment of consciousness. In the excited stage of manic-depressive insanity it is not uncommon to find that the memory is abnormally active. Loss of memory for recent but not remote events is characteristic of chronic alcoholism and senility and even the early stage of general paralysis.

Of all the functions of the brain that of sleep is the most liable to disorder in the insane. Sleeplessness is the earliest symptom in the onset of insanity; it is universally present in all the acute forms, and the return of natural sleep is generally the first symptom of recovery. The causes of sleeplessness are very numerous, but in the majority of acute cases the sleeplessness is due to a state of toxæmia. The toxins act either directly on the brain cells producing a state of irritability incompatible with sleep, or indirectly, producing physical symptoms which of themselves alone are capable of preventing the condition of sleep. These symptoms are high arterial tension and a rapid pulse-rate. The arterial tension of health ranges between 110 and 120 millimetres of mercury, and when sleep occurs the arterial tension falls and is rarely above 100 millimetres. In observations conducted by Bruce (*Scottish Medical and Surgical Journal*, August 1900) on cases of insanity suffering from sleeplessness the arterial tension was found to be as high as 140 and 150 millimetres. When such sleep was obtained the tension always sank at once to 110 millimetres or even lower. In a few cases suffering from sleeplessness the arterial tension was found to be below 100 millimetres accompanied by a rapid pulse-rate. When sleep set in, in these cases, no alteration was noted in the arterial tension, but the pulse was markedly diminished.

**MELANCHOLIA.**—Melancholia is a general term applied to all forms of insanity in which the prevailing mental symptom is that of depression and dates back to the time of Hippocrates. Melancholic patients, however, differ very widely from one another in their mental symptoms, and as a consequence a perfectly unwarrantable series of subdivisions have been invented according to the prominence of one or other mental symptoms. Such terms as delusional melancholia, resistive melancholia, stuporose melancholia, suicidal melancholia, religious melancholia, &c. have so arisen; they are, however, more descriptive of individual cases than indicative of types of disease.

So far as our present knowledge goes, at least three different and distinct disease conditions can be described under the general term melancholia. These are, acute melancholia, excited melancholia and the state of depression occurring in *Folie circulaire* or alternating insanity, a condition in which the patient is liable to suffer from alternating attacks of excitement and depression.

**Acute Melancholia** is a disease of adult life and the decline of life. Women appear to be more liable to be attacked than men. Hereditary predisposition, mental worry, exhausting occupations, such as the sick-nursing of relatives, are the chief predisposing causes, while the direct exciting cause of the condition is due to the accumulation in the tissues of waste products, which so load the blood as to act in a toxic manner on the cells and fibres of the brain.

The onset of the disease is gradual and indefinite. The patient suffers from malaise, indigestion, constipation and irregular, rapid and forcible action of the heart. The urine become scanty and high coloured. The nervous symptoms are irritability, sleeplessness and a feeling of mental confusion. The actual onset of the acute mental symptoms may be sudden,

and is not infrequently heralded by distressing hallucinations of hearing, together with a rise in the body temperature. In the fully developed disease the patient is flushed and the skin hot and dry; the temperature is usually raised 1° above the normal in the evening. The pulse is hard, rapid and often irregular. There is no desire for food, but dryness of the mouth and tongue promote a condition of thirst. The bowels are constipated. The urine is scanty and frequently contains large quantities of indoxyl. The blood shows no demonstrable departure from the normal. The patient is depressed, the face has a strained, anxious expression, while more or less mental confusion is always present. Typical cases suffer from distressing aural hallucinations, and the function of sleep is in abeyance.

Acute melancholia may terminate in recovery either gradually or by crises, or the condition may pass into chronicity, while in a small proportion of cases death occurs early in the attack from exhaustion and toxæmia. The acute stage of onset generally lasts for from two to three weeks, and within that period the patient may make a rapid and sudden recovery. The skin becomes moist and perspiration is often profuse. Large quantities of urine are excreted, which are laden with waste products. The pulse becomes soft and compressible, sleep returns, and the depression, mental confusion and hallucinations pass away. In the majority of untreated cases, however, recovery is much more gradual. At the end of two or three weeks from the onset of the attack the patient gradually passes into a condition of comparative tranquillity. The skin becomes moister, the pulse less rapid, and probably the earliest symptom of improvement is return of sleep. Hallucinations accompanied by delusions persist often for weeks and months, but as the patient improves physically the mental symptoms become less and less prominent.

If the patient does not recover, the physical symptoms are those of mal-nutrition, together with chronic gastric and intestinal disorder. The skin is dull and earthy in appearance, the hair dry, the nails brittle and the heart's action weak and feeble. Mentally there is profound depression with delusions, and persistent or recurring attacks of hallucinations of hearing. When death occurs, it is usually preceded by a condition known as the "typhoid state." The patient rapidly passes into a state of extreme exhaustion, the tongue is dry and cracked, sordes form upon the teeth and lips, diarrhoea and congestion of the lungs rapidly supervene and terminate life.

**Treatment.**—The patient in the early stage of the disease must be confined to bed and nursed by night as well as day. The food to begin with should be milk, diluted with hot water or aerated water, given frequently and in small quantities. The large intestine should be thoroughly cleared out by large enemata and kept empty by large normal saline enemata administered every second day. Sleep may be secured by lowering the blood pressure with half-grain doses of erythrol-tetra-nitrate. If a hypnotic is necessary, as it will be if the patient has had no natural sleep for two nights in succession, then a full dose of paraldehyde or veronal may be given at bed-time. Under this treatment the majority of cases, if treated early, improve rapidly. As the appetite returns great care must be taken that the patient does not suddenly resume a full ordinary dietary. A sudden return to a full dietary invariably means a relapse, which is often less amenable to treatment than the original attack. Toast should first be added to the milk, and this may be followed by milk puddings and farinaceous foods in small quantities. Any rise of temperature or increase of pulse-rate or tendency to sleeplessness should be regarded as a threatened relapse and treated accordingly.

**Excited Melancholia.**—Excited melancholia is almost invariably a disease of old age or the decline of life, and it attacks men and women with equal frequency. Chronic gastric disorders, deficient food and sleep, unhealthy occupations and environments, together with worry and mental stress, are all more or less predisposing causes of the disease. The direct exciting cause or causes have not as yet been demonstrated, but there is no doubt that the disease is associated with, or caused by, a condition of bacterial toxæmia, analogous to the bacterial toxæmias of acute and chronic rheumatism.

The onset of the disease is always gradual and is associated with mal-nutrition, loss of body weight, nervousness, depression, loss of the capacity for work, sleeplessness and attacks of

restlessness. These attacks of restlessness become more and more marked as self-control diminishes, and as the depression increases the disease passes the borderland of sanity.

In the fully developed disease the appearance of the patient is typical. The expression is drawn, depressed, anxious or apprehensive. The skin is yellow and parchment like. The hair is often dry and stands out stiffly from the head. The hands are in constant movement, twisting and untwisting, picking the skin, pulling at the hair or tearing at the clothes. The patient moans continuously, or emits cries of grief and wanders aimlessly. Mentally the patient, although depressed, miserable and self-absorbed, is not confused. There is complete consciousness except during the height of a paroxysm of restlessness and depression, and the patient can talk and answer questions clearly and intelligently, but takes no interest in the environment. Some of the patients suffer from delusions, generally a sense of impending danger, but very few suffer from hallucinations.

Physically there is loss of appetite, constipation and rapid heart action, a great increase in the number of the white blood corpuscles, particularly of the multinucleated cells which are frequently increased in bacterial infections. In the blood serum also there can be demonstrated the presence of agglutinins to certain members of the streptococci group.

The course of the disease is prolonged and chronic. The acute symptoms tend to remit at regular intervals, the patient becoming more quiet and less demonstratively depressed; but as a rule these remissions are extremely temporary. Excited melancholia is a disease characterized by repeated relapses, and recoveries are rare in cases above the age of forty.

*Treatment.*—There is no curative treatment for excited melancholia. The patient must be carefully nursed; kept in bed during the exacerbations of the disease and treated with graduated doses of nepoche or tincture of opium, to secure some amelioration of the acute symptoms. Careful dieting, tonics and baths are of benefit during the remissions of the disease, and in a few cases seem to promote recovery.

*Folie circulaire*, or alternating insanity, was first described by Falret and Ballarger, and more recently Kraepelin has considerably widened the conception of this class of disease, which he describes under the term "manic-depressive insanity." Of the two terms (*folie circulaire* and manic-depressive insanity) the latter is the more correct. *Folie circulaire* implies that the disease invariably passes through a complete cycle, which description is only applicable to very few of the cases. Manic-depressive insanity implies that the patient may either suffer from excitement or depression which do not necessarily succeed one another in any fixed order. As a matter of fact, the majority of patients who suffer from the disease either have marked excited attacks with little or no subsequent depression, or marked attacks of depression with a subsequent period of such slight exaltation as hardly to be distinguished from a state of health.

Depression of the manic-depressive variety, therefore, may either precede or follow upon an attack of maniacal excitement, or it may be the chief and only obvious symptom of the disease and may recur again and again. The disease attacks men and women with equal frequency, and as a rule manifests itself either late in adolescence or during the decline of life. Hereditary predisposition has been proved to exist in over 50% of cases, beyond which no definite predisposing cause is at present known. A considerable number of cases follow upon attacks of infective disease such as typhoid fever, scarlet fever or rheumatic fever. The actual exciting cause is probably an intestinal toxæmia of bacterial origin; at all events, mal-nutrition, gastric and intestinal symptoms not infrequently precede an attack, and the condition of the blood—the increase in number in the multinucleated white blood corpuscles and the presence of agglutinins to certain members of the streptococci group of bacteria—are symptoms which have been definitely demonstrated by Bruce in every case so far examined.

If the depression is the sequel to an attack of excitement, the onset may be very sudden or it may be gradual. If, on the other hand, the depression is not the sequel of excitement, the onset is very gradual and the patient complains of lassitude,

incapacity for mental or physical work, loss of appetite, constipation and sleeplessness often for months before the case is recognized as one of insanity. In the fully developed disease the temperature is very rarely febrile, on the contrary it is rather subnormal in character. The stomach is disordered and the bowels confined. The urine is scanty, turbid and very liable to rapid decomposition. The heart's action is slow and feeble and the extremities become cold, blue and livid. In extreme cases gangrene of the lower extremities may occur, but in all there is a tendency to oedema of the extremities. The skin is greasy, often offensive, and the palms of the hands and the soles of the feet are sodden.

Mentally there is simple depression, without, in the majority of cases, any implication of consciousness. Many patients pass through attack after attack without suffering from hallucinations or delusions, but in rare cases hallucinations of hearing and sight are present. Delusions of unworthiness and unpardonable sin are not uncommon, and if once expressed are liable to recur again during the course of each successive attack. The disease is prolonged and chronic in its course, and the condition of the patient varies but little from day to day. When the depression follows excitement, the patient as a rule becomes fat and flabby. On the other hand, if the illness commences with depression, the chief physical symptoms are mal-nutrition and loss of body weight, and the return to health is always preceded by a return of nutrition and a gain in body weight.

The attacks may last from six months to two or three years. The intervals between attacks may last for only a few weeks or months or may extend over several years. During the interval the patient is not only capable of good mental work but may show capacity of a high order. In other words this form of mental disorder does not tend to produce dementia; the toxæmia probably being that between the attacks there is no toxæmia.

*Treatment.*—There is no known curative treatment for the depression of manic-depressive insanity, but the depression, the sleeplessness and the gastric disorder are to some extent mitigated by common sense attention to the general health of the body. If the patient is thin and wasted, then treatment is best conducted in bed. The diet should be bland, consisting largely of milk, eggs and farinaceous food, given in small quantities and frequently. Defecation should be maintained by enemata, and the skin kept clean by daily warm baths. What is of much more importance is the fact that in some instances subsequent attacks can be prevented by impressing upon the patient the necessity for attending to the state of the bowels, and of discontinuing work when the slightest symptoms of an attack present themselves. If these symptoms are at all prominent, rest in bed is a wise precaution, butcher-meat should be discontinued from the dietary and a tonic of arsenic or quinine and acid prescribed.

**MANIA.**—The term mania, meaning pathological elevation or excitement, has, like the term melancholia, been applied to all varieties of morbid mental conditions in which *Mania.* the prevailing mental symptom is excitement or elevation. As in melancholia so in mania various subdivisions have been invented, such as delusional mania, religious mania, homicidal mania, according to the special mental characteristics of each case, but such varieties are of accidental origin and cannot be held to be subdivisions.

Under the term mania two distinct diseased conditions can be described, viz. acute mania, and the elevated stage of *folie circulaire* or manic-depressive insanity.

*Acute Mania.*—Acute mania is a disease which attacks both sexes at all ages, but its onset is most prevalent during adolescence and early adult life. Hereditary predisposition, physical and mental exhaustion, epileptic seizures and childbirth are all predisposing causes. The direct exciting cause or causes are unknown, but the physical symptoms suggest that the condition is one of acute toxæmia or poisoning, and the changes in the blood are such as are consequent on bacterial toxæmia.

The onset is gradual in the large majority of cases. Histories of sudden outbursts of mania can rarely be relied on, as the illness is almost invariably preceded by loss of body weight, sleeplessness, bad dreams, headaches and symptoms of general malaise, sometimes associated with depression. The actual onset of the mental symptoms themselves, however, are frequently sudden.

A typical case of the fully developed disease is not easily mistaken. The patient is usually anaemic and thin, the expression of the face is unnatural, the eyes widely opened and bright; and there is great motor restlessness, the muscular movements being purposeless and inco-ordinate. This inco-ordination of movement affects not only the muscles of the limbs and trunk but also those of expression, so that the usual aspect of the face becomes entirely altered. The temperature is generally slightly febrile. The tongue and lips are cracked and dry through excessive shouting or speaking. There is often no desire for food or drink. The heart's action is rapid and forcible. The skin is soft and moist. The urine is scanty, turbid and loaded with urates. The white blood corpuscles per cubic millimetre of blood are markedly increased, and the blood serum contains agglutinines to certain strains of streptococci which are not present in healthy persons. Sensibility to pain is lost or much impaired. Such patients will swing and jerk a broken limb apparently unaware that it is broken. Sleep is absent or obtained in short snatches, and even when asleep the patient is often restless and talkative as if the disease processes were still active.

Mentally the patient is excited, often wildly so, quite confused and unable to recognize time or place. Answers to questions may sometimes be elicited by repeated efforts to engage the attention of the patient. The speech is incoherent, and for all practical purposes the patient is mentally inaccessible. This state of acute excitement lasts usually for two or three weeks and gradually passes into a condition of chronic restlessness and noise, in which the movements are more co-ordinate and purposeful. The confusion of the acute stage passes off and the attention can be more readily attracted but cannot be concentrated on any subject for any length of time. The patient will now recognize friends, but the affections are in abeyance and the memory is defective. The appetite becomes insatiable, but the patient does not necessarily gain in weight. This stage of subacute excitement may last for months, but as a rule favourable cases recover within six months from the onset of the disease. A recovering patient gradually gains weight, sleeps soundly at night and has periods of partial quiescence during the day, particularly in the morning after a good night's sleep. These lucid intervals become more and more prolonged and finally pass into a state of sanity. Some cases on the other hand, after the acute symptoms decline, remain confused, and this state of confusion may last for months; by some alienists it is described as secondary stupor.

The symptoms detailed above are those typical of an attack such as is most frequently met with in adult cases. Acute mania, however, is a disease which presents itself in various forms. Adolescent cases, for instance, very commonly suffer from recurrent attacks, and the recurrent form of the disease is also to be met with in adults. The recurrent form at the onset does not differ in symptoms from that already described, but the course of the attack is shorter and more acute, so that the patient after one or two weeks of acute excitement rapidly improves, the mental symptoms pass off and the patient is apparently perfectly recovered. An examination of the blood, however, reveals the fact that the patient is still suffering from some disorder of the system, inasmuch as the white blood corpuscles remain increased above the average of health. Subsequent attacks of excitement come on without any obvious provocation. The pulse becomes fast and the face flushed. The patient frequently complains of fullness in the head, ringing in the ears and a loss of appetite. Sleeplessness is an invariable symptom. Self-control is generally lost suddenly, and the patient rapidly passes into a state of delirious excitement, to recover again, apparently, in the course of a few weeks. Recurrent mania might therefore be regarded as a prolonged toxæmia, complicated at intervals by outbursts of delirious excitement. Acute mania in the majority of cases ends in recovery. In the continuous attack the recovery is gradual. In the recurrent cases the intervals between attacks become longer and the attacks less severe until they finally cease. In such recovered cases very frequently a persistent increase in the number of the white blood corpuscles is found, persisting for a period of two or three years of apparently

sound mental health. A few cases die, exhausted by the acuteness of the excitement and inability to obtain rest by the natural process of sleep. When death does occur in this way the patient almost invariably passes into the typhoid state.

The residue of such cases become chronic, and chronicity almost invariably means subsequent dementia. The chronic stage of acute mania may be represented by a state of continuous subacute excitement in which the patient becomes dirty and destructive in habits and liable from time to time to exacerbations of the mental symptoms. Continuous observation of the blood made in such cases over a period extending for weeks reveals the fact that the leucocytosis, if represented in chart form, shows a regular sequence of events. Just prior to the onset of an exacerbation the leucocytosis is low. As the excitement increases in severity the leucocytosis curve rises, and just before improvement sets in there may be a decided rise in the curve and then a subsequent fall; but this fall rarely reaches the normal line. In other cases, which pass into chronicity, a state of persistent delusion, rather than excitement, is the prevailing mental characteristic, and these cases may at recurrent intervals become noisy and dangerous.

*Treatment.*—Acute mania can only be treated on general lines. During the acute stage of onset the patient should be placed in bed. If there is difficulty in inducing the patient to take a sufficient quantity of food, this difficulty can be got over by giving food in liquid form, milk, milk-tea, eggs beaten up in milk, meat juice and thin gruel, and it is always better to feed such a patient with small quantities given frequently. Cases of mania following childbirth are those which most urgently demand careful and frequent feeding, artificially administered if necessary. If there is any tendency to exhaustion, alcoholic stimulants are indicated, and in some cases strychnine, quinine and cardiac tonics are highly beneficial. The bowels should be unloaded by large enemata or the use of saline purgatives. The continuous use of purgatives should as a rule be avoided, as they drain the system of fluids. On the other hand, the administration of one large normal saline enema by supplying the tissues with fluids, and probably thereby diluting the toxins circulating in the system, gives considerable relief. A continuous warm bath frequently produces sleep and reduces excitement. The sleeplessness of acute mania is best treated by warm baths wherever possible, and if a drug must be administered, then paraldehyde is the safest and most certain, unless the patient is also an alcoholic, when chloral and bromide is probably a better sedative.

*The Elevated Stage of Folie Circulaire or Manic Depressive Insanity.*—As previously mentioned in the description of the depressed stage of this mental disorder, the disease is equally prone to attack men and women, generally during late adolescence or in early adult life, and in a few cases first appears during the decline of life. Hereditary predisposition undoubtedly plays a large part as a predisposing cause, and after that is said it is difficult to assign any other definite predisposing causes and certainly no exciting causes. As in the stage of depression, so in the stage of excitement the first attack may closely follow upon typhoid fever, erysipelas or rheumatic fever. On the other hand many cases occur without any such antecedent disease. Another fact which has been commented upon is that these patients at the onset of an attack of excitement often appear to be in excellent physical health.

The earliest symptoms of onset are moral rather than physical. The patient changes in character, generally for the worse. The sober man becomes intemperate. The steady man of business enters into foolish, reckless speculation. There is a tendency for the patient to seek the society of inferiors and to ignore the recognized conventionalities of life and decency. The dress becomes extravagant and vulgar and the speech loud, boastful and obscene. These symptoms may exist for a considerable period before some accidental circumstance or some more than usually extravagant departure from the laws and customs of civilization draws public attention to the condition of the patient. The symptoms of the fully developed disease differ in degree in different cases. The face is often flushed and the expression unnatural. There is constant restlessness, steady loss of body weight, and sleeplessness. In very acute attacks there are frequently symptoms of gastric disorder, while in other cases the appetite is enormous, gross and perverted. The leucocytosis is above that usually met with in health, and the increase in the

early stages is due to the relative and absolute increase in the multinucleated or polymorphonuclear leucocytes. The hyperleucocytosis is not, however, so high as it is in acute mania, and upon recovery taking place the leucocytosis always falls to normal. In the serum of over 80% of cases there are present agglutinins to certain strains of streptococci, which agglutinins are not present in the serum of healthy persons. The changes in the urine are those which one would expect to find in persons losing weight; the amount of nitrogenous output is in excess of the nitrogen ingested in the food.

Mentally there is always exaltation rather than excitement, and when excitement is present it is never of a delirious nature, that is to say, the patient is cognizant of the surroundings, and the special senses are abnormally acute, particularly those of sight and hearing. Hallucinations and delusion are sometimes present, but many cases pass through several attacks without exhibiting either of these classes of symptoms. The patient is always garrulous and delighted to make any chance acquaintance the confidant of his most private affairs. The mood is sometimes expansive and benevolent, interruption in the flow of talk may suddenly change the subject of the conversation or the patient may with equal suddenness fly into a violent rage, use foul and obscene language, ending with loud laughter and protestations of eternal friendship. In other words the mental processes are easily stimulated and as easily diverted into other channels. The train of thought is, as it were, constantly being changed by accidental associations. Although consciousness is not impaired, the power of work is abolished as the attention cannot be directed continuously to any subject, and yet the patient may be capable of writing letters in which facts and fiction are most ingeniously blended. A typical case will pass through the emotions of joy, sorrow and rage in the course of a few minutes. The memory is not impaired and is often hyperacute. The speech may be rambling but is rarely incoherent.

The course of the attack is in some cases short, lasting for from one to three weeks, while in others the condition lasts for years. The patient remains in a state of constant restlessness, both of body and mind, untidy or absurd in dress, noisy, amorous, vindictive, boisterously happy or virulently abusive. As time passes a change sets in. The patient sleeps better, begins to lay on flesh, the sudden mental fluctuations become less marked and finally disappear. Many of these patients remember every detail of their lives during the state of elevation, and many are acutely ashamed of their actions during this period of their illness. As a sequel to the attack of elevation there is usually an attack of depression, but this is not a necessary sequel.

The majority of patients recover even after years of illness, but the attacks are always liable to recur. Even recurrent attacks, however, leave behind them little if any mental impairment.

*Treatment.*—General attention to the health of the body, and an abundance of nourishing food, and, where necessary, the use of sedatives such as bromide and sulphonal, sum up the treatment of the elevated stage of manic-depressive insanity. In Germany it is the custom to treat such cases in continuous warm baths, extending sometimes for weeks. The use of warm baths of several hours duration has not proved satisfactory.

**DELUSIONAL INSANITY.**—Considerable confusion exists at the present day regarding the term delusional insanity. It is

not correct to define the condition as a disease in which fixed delusions dominate the conduct and are the chief mental symptom present. Such a definition would include many chronic cases of melancholia and mania. All patients who suffer from attacks of acute insanity and who do not recover tend to become delusional, and any attempt to include and describe such cases in a group by themselves and term them delusional insanity is inadmissible. The fact that delusional insanity has been described under such various terms as progressive systematized insanity, mania of persecution and grandeur, monomanias of persecution, unseen agency, grandeur and paranoia, indicates that the disease is obscure in its origin, probably passing through various stages, and in some instances having been confused with the terminal

stages of mania and melancholia. If this is admitted, then probably the best description of the disease is that given by V. Magnan under the term of "systematized delusional insanity," and it may be accepted that many cases conform very closely to Magnan's description.

The disease occurs with equal frequency in men and women, and in the majority of cases commences during adolescence or early adult life. The universally accepted predisposing cause is hereditary predisposition. As to the exciting causes nothing is known beyond the fact that certain forms of disease, closely resembling delusional insanity, are apparently associated or caused by chronic alcoholism or occur as a sequel to syphilitic infection. In the vast majority of cases the onset is lost in obscurity, the patient only drawing attention to the diseased condition by insane conduct after the delusional state is definitely established. The friends of such persons frequently affirm that the patient has always been abnormal. However this may be, there is no doubt that in a few cases the onset is acute and closely resembles the onset of acute melancholia. The patient is depressed, confused, suffers from hallucinations of hearing and there are disturbances of the bodily health. There is generally mal-nutrition with dyspepsia and vague neuralgic pains, often referred to the heart and intestines. Even at this stage the patient may labour under delusions. These acute attacks are of short duration and the patient apparently recovers, but not uncommonly both hallucinations and delusions persist, although they may be concealed.

The second or delusional stage sets in very gradually. This is the stage in which the patient most frequently comes under medical examination. The appearance is always peculiar and unhealthy. The manner is unnatural and may suggest a state of suspicion. The nutrition of the body is below par, and the patient frequently complains of indefinite symptoms of malaise referred to the heart and abdomen. The heart's action is often weak and irregular, but beyond these symptoms there are no special characteristic symptoms.

Mentally there may be depression when the patient is sullen and uncommunicative. It will be found, however, that he always suffers from hallucinations. At first hallucinations of hearing are the most prominent, but later all the special senses may be implicated. These hallucinations constantly annoy the patient and are always more troublesome at night. Voices make accusations through the walls, floors, roofs or door. Faces appear at the window and make grimaces. Poisonous gases are pumped into the room. Electricity, Röntgen rays and marconigrams play through the walls. The food is poisoned or consists of filth. In many cases symptoms of visceral discomfort are supposed to be the result of nightly surgical operations or sexual assaults. All these persecutions are ascribed to unknown persons or to some known person, sect or class. Under the influence of these sensory disturbances the patient may present symptoms of angry excitement, impulsive violence or of carefully-thought-out schemes of revenge; but the self-control may be such that although the symptoms are concealed the behaviour is peculiar and unreasonable. It is not uncommon to find that such patients can converse rationally and take an intelligent interest in their environments, but the implication of the capacity of judgment is at once apparent whenever the subject of the persecutions is touched upon.

All cases of delusional insanity at this stage are dangerous and their actions are not to be depended upon. Assaults are common, houses are set on fire, threatening letters are written and accusations are made which may lead to much worry and trouble before the true nature of the disease is realized.

This, the second or persecutory stage of delusional insanity, may persist through life. The patient becomes gradually accustomed to the sensory disturbances, or possibly a certain amount of mental enfeeblement sets in which reduces the mental vigour. In other cases, the disease goes on to what Magnan calls the third stage or stage of grandiose delusions. The onset of this stage is in some cases gradual. The patient, while inveighing against the persecutions, hints at a possible cause. One man is an inventor and his enemies desire to deprive him of the results of his inventions.

Another is the rightful heir to a peerage, of which he is to be deprived. Women frequently believe themselves to be abducted princesses or heirs to the throne. Others of both sexes, even more ambitious, assume divine attributes and proclaim themselves Virgin Marys, Gabriels, Holy Ghosts and Messiahs. Cases are recorded in which the delusions of grandeur were of sudden onset, the patient going to bed persecuted and miserable and rising the following morning elated and grandiose. In this stage the hallucinations persist but appear to change in character and become pleasant. The king hears that arrangements are being made for his coronation and waits quietly for the event. The angel Gabriel sees visions in the heavens. The heirs and heiresses read of their prospective movements in the court columns of the daily papers and are much soothed thereby. In short, no delusion is too grotesque and absurd for such patients to believe and express.

Cases of delusional insanity never become demented in the true sense of the word, but their mental state might be described as a dream in which an imaginary existence obliterates the experiences of their past lives.

**Treatment.**—No treatment influences the course of the disease. During the stage of persecution such patients are a danger to themselves, as they not infrequently commit suicide, and to their supposed persecutors, whom they frequently assault or otherwise annoy.

**KATATONIA.**—This disease, so called on account of the symptom of muscular spasm or rigidity which is present during certain of its stages, was first described and named by K. L. Kahlbaum in 1874. Many British alienists refuse to accept katatonia as a distinct disease, but as it has been accepted and further elaborated by such an authority as E. Kraepelin reference to it cannot be avoided.

Katatonias attacks women more frequently than men, and is essentially a disease of adolescence, but typical cases occasionally occur in adults. Hereditary predisposition is present in over 50% of the cases and is the chief predisposing cause. Childbirth, worry, physical strain and mental shocks are all advanced as secondary predisposing causes. The disease is one of gradual onset, with loss of physical and mental energy. Probably the earliest mental symptom is the onset of aural hallucinations. For convenience of description the disease may be divided into (1) the stage of onset; (2) the stage of stupor; (3) the stage of excitement.

The symptoms of the stage of onset are disorders of the alimentary tract, such as loss of appetite, vomiting after food and obstinate constipation. The pulse is rapid, irregular and intermittent. The skin varies between extreme dryness and drenching perspiration. In women the menstrual function is suppressed. At uncertain intervals the skeletal muscles are thrown into a condition of rigidity, but this symptom does not occur invariably. The instincts of cleanliness are in abeyance, owing to the mental state of the patient, and as a result these cases are inclined to be wet and dirty in their habits.

Mentally there is great confusion, vivid hallucinations, which apparently come on at intervals and are of a terrifying nature, for the patient often becomes frightened, endeavours to hide in corners or escape by a window or door. A very common history of such a case prior to admission is that the patient has attempted suicide by jumping out of a window, the attempt being in reality an unconscious effort on the part of the patient to escape from some imaginary danger. During these attacks the skin pours with perspiration. The patient is oblivious to his surroundings and is mentally inaccessible. In the intervals between these attacks the patient may be conscious and capable of answering simple questions. This acute stage, in which sleep is abolished, lasts from a few days to four or six weeks and then, generally quite suddenly, the patient passes into the state of stupor. In some cases a sharp febrile attack accompanies the onset of the stupor, while in others this symptom is absent; but in every case examined by Bruce during the acute stage there was an increase in the number of the white blood corpuscles, which, just prior to the onset of stupor, were sometimes enormously increased; the increase being entirely due to multiplication of the multinucleated or polymorphonuclear leucocytes.

In the second or stuporose stage of the disease the symptoms are characteristic. The patient lies in a state of apparent placidity, generally with the eyes shut. Consciousness is never entirely abolished, and many of the patients give unmistakable evidence that they understand what is being said in their presence. Any effort at passive movement of a limb immediately sets up muscular resistance, and throughout this stage the sternomastoid and the abdominal muscles are more or less in a state of over-tension, which is increased to a condition of rigidity if the patient is interfered with in any way. This symptom of restiveness or negativism is one of the characteristics of the disease. The patient resists while being fed, washed, dressed and undressed, and even the normal stimuli which in a healthy man indicate that the bladder or rectum require to be emptied are resisted, so that the bladder may become distended and the lower bowel has to be emptied by enemata. The temperature is low, often subnormal, the pulse is small and weak, and the extremities cold and livid. This symptom is probably due in some part to spasm of the terminal arterioles. Mentally the symptoms are negative. Though conscious, the patient cannot be got to speak and apparently is oblivious to what is passing around. Upon recovery, however, these cases can often recount incidents which occurred to them during their illness, and may also state that they laboured under some delusion. Coincidentally with the onset of the stupor sleep returns, and many cases sleep for the greater part of the twenty-four hours. The duration of the stuporose state is very variable. In some cases it lasts for weeks, in others for months or years, and may be the terminal stage of the disease, the patient gradually sinking into dementia or making a recovery. The third stage or stage of excitement comes on in many cases during the stage of stupor: the stages overlap; while in others a distinct interval of convalescence may intervene between the termination of the stupor and the onset of the excitement. The excitement is characterized by sudden impulsive actions, rhythmical repetition of words and sounds (verbigeration), and by rhythmical movements of the body or limbs, such as swaying the whole frame, nodding the head, swinging the arms, or walking in circles. The patient may be absolutely mute in this stage as in the stage of stupor. Others again are very noisy, singing, shouting or abusive. The speech is staccato in character and incoherent. Physically the patient, who often gains weight in the stage of stupor, again becomes thin and haggard in appearance owing to the incessant restlessness and sleeplessness which characterize the stage of excitement. The patient may, during the stage of onset, die through exhaustion, or accidentally and unconsciously commit suicide usually by leaping from a window. During the stuporose stage symptoms of tubercular disease of the lungs may commence. All the adolescent insane are peculiarly liable to contract and die from tubercular disease. Accidental suicide is also liable to occur during this stage. The stage of excitement, if at all prolonged, invariably ends in dementia. According to Kraepelin 13% of the cases recover, 27 make partial recoveries, and 60% become more or less demented.

**Treatment.**—No treatment arrests or diverts the course of katatonia, and the acute symptoms of the disease as they arise must be treated on hospital principles.

**HEBEPHRENIA.**—This is a disease of adolescence (Gr.  $\eta\epsilon\beta\eta$ ) which was first described by Hecker and Kahlbaum and more recently by Kraepelin and other foreign workers. Hebephrenia is not yet recognized by British alienists. The descriptions of the disease are indefinite and confusing, but there are some grounds for the belief that such an entity does exist, although it is probably more correct to say that as yet the symptoms are very imperfectly understood. Hebephrenia is always a disease of adolescence and never occurs during adult life. It attacks women more frequently than men, and according to Kahlbaum hereditary predisposition to insanity is present in over 50% of the cases attacked. The onset of the disease is invariably associated with two symptoms. On the physical side an arrested or delayed development and on the mental a gradual failure of the power of attention and

*Hebephrenia.*

concentrated thought. The onset of the condition is always gradual and the symptoms which first attract attention are mental. The patient becomes restless, is unable to settle to work, becomes solitary and peculiar in habits and sometimes dissolute and mischievous. As the disease advances the patient becomes more and more enfeebled, laughs and mutters to himself and wanders aimlessly and without object. There is no natural curiosity, no interest in life and no desire for occupation. Later, delusions may appear and also hallucinations of hearing, and under their influence the patient may be impulsive and violent. Physically the subjects are always badly developed. The temperature is at times slightly elevated and at intervals the white blood corpuscles are markedly increased. The menstrual function in women is suppressed and both male and female cases are addicted to masturbation. According to Kraepelin 5% of the cases recover, 15% are so far relieved as to be able to live at home, but are mentally enfeebled, the remaining 80% become hopelessly demented. The patients who recover frequently show at the onset of their disease acute symptoms, such as mild excitement, slightly febrile temperature and quick pulse-rate. When recovery does take place there is marked improvement in development. The subjects of hebephrenia are peculiarly liable to tubercular infection and many die of phthisis.

There is no special treatment for hebephrenia beyond attention to the general health.

**INSANITY FOLLOWING UPON INJURIES TO THE BRAIN, OR APOPLEXIES OR TUMOURS OR ARTERIAL DEGENERATION.** (a) *Traumatic Insanity.*—Insanity following blows on the head is divided into (1) the forms in which the insanity immediately follows the accident; (2) the form in which there is an intermediate prodromal stage characterized by

*Traumatic Insanity.* strange conduct and alteration in disposition; and (3) in which the mental symptoms occur months or years after the accident, which can have at most but a remote predisposing causal relation to the insanity. The cases which immediately succeed injuries to the head are in all respects similar to confusional insanity after operations or after fevers. There is generally a noisy incoherent delirium, accompanied by hallucinations of sight or of hearing, and fleeting unsystematized delusions. The physical symptoms present all the features of severe nervous shock.

In those cases in which there is an intervening prodromal condition, with altered character and disposition, there is usually a more or less severe accidental implication of the cortex cerebri, either by depression of bone or local hemorrhage, or meningitic sub-inflammatory local lesions. Most of the cases during the prodromal stage are sullen, morose or suspicious, and indifferent to their friends and surroundings. At the end of the prodromal stage there most usually occurs an attack of acute mania of a furious impulsive kind. The cases which for many years after injury are said to have remained sane will generally be found upon examination and inquiry to exhibit symptoms of hereditary degeneration or of acquired degeneracy, which may or may not be a consequence of the accident.

The most common site of vascular lesion is one of the branches of the middle cerebral artery within the sylvian fissure, or of one of the smaller branches of the same artery which go directly to supply the chief basal ganglia. When an artery like the middle cerebral or one of its branches becomes either through rupture or blocking of its lumen, incapable of performing its function of supplying nutrition to important cerebral areas, there ensues devitality of the nervous tissues, frequently followed by softening and chronic inflammation. It is these secondary changes which give rise to and maintain those peculiar mental aberrations known as post-apopleptic insanity.

Various characteristic physical symptoms, depending upon the seat of the cerebral lesion, are met with in the course of this form of insanity. These consist of paraplegias, hemiplegias and muscular contractures. Speech defects are very common, being due either to the enfeebled mental condition, to paralysis of the nerve supplying the muscles of the face and tongue,

or to aphasia caused by implication of those parts of the cortex which are intimately associated with the faculty of speech. Mental symptoms vary considerably in different cases and in accordance with the seat and extent of the lesion. There is almost always present, however, a certain degree of mental enfeeblement, accompanied by loss of memory and of judgment, often by mental confusion. Another very general mental symptom is the presence of emotionalism which leads the patient to be affected either to tears or to laughter upon trifling and inadequate occasions.

Cerebral tumours do not necessarily produce insanity. Indeed it has been computed that not one half of the cases become insane. When insanity appears it is met with in all degrees varying from slight mental dulness up to complete dementia, and from mere moral perversion up to the most intense form of maniacal excitement. On the physical side the various symptoms of cerebral tumour such as coma, ataxia, paralysis, headache, vomiting, optic neuritis and epileptiform convulsions are met with. All forms of so-called moral changes and of changes of disposition are met with as mental symptoms and all the ordinary forms of insanity may occur in varying intensity; but by far the most common mental change occurring in connexion with cerebral tumour is a progressive enfeeblement of the intelligence, unattended with any more harmful symptoms than mental deterioration which ends in complete dementia.

(b) *Arterial Degeneration.*—Arterial degeneration is a common cause of mental impairment, especially of that form of mental affection known as "Early" dementia. *Insanity due to Arterial Degeneration.* It also predisposes to embolism and thrombosis, which often results in the paralytic and aphasic groups of nerve disturbance, and which are always accompanied by more or less marked interference with normal cerebral action.

The commonest seat for atheroma of the cerebral vessels is the arteries at the base of the brain and their main branches, especially the middle cerebral. As a general rule the other arteries of the cerebrum are not implicated to the same extent, although in a not inconsiderable number of cases of the disease all the arteries of the brain may participate in the change. When this is so, we obtain those definite symptoms of slowly advancing dementia commencing in late middle life and ending in complete dementia before the usual period for the appearance of senile dementia. The same appearances are met with in certain patients who have attained the age in which senile changes in the arteries are not unexpected. As a rule atheroma in the cerebral vessels is but a part of a general atheroma of all the arteries of the body. Atheroma is common after middle life and increases in frequency with age. The chief causes are syphilis, alcoholism, the gouty and rheumatic diatheses and above all Bright's disease of the kidneys. Perhaps certain forms of Bright's disease, owing to the tendency to raise the blood pressure, are of all causes the most common.

It is not easy to say to what extent, alone, the arteriosclerosis is effectual in inducing the gradual failure of the mental powers, and to what extent it is assisted in its operation by the action on the brain-cells of the general toxic substances which give rise to the arterial atheroma. In any case there can be no question that the gradual mechanical diminution of the blood-supply to the cortex caused by the occlusion of the lumen of the arteries is a factor of great importance in the production of mental incapacity.

**GENERAL PARALYSIS OF THE INSANE** (syn. General Paralysis, dementia paralytica, progressive dementia) is a disease characterized by symptoms of progressive degeneration of the central nervous system, more particularly of the motor centres. The disease is almost invariably fatal. *General Paralysis.* Apparent recoveries do very occasionally occur, though this is denied by the majority of alienists. The disease is in every case associated with gradually advancing mental enfeeblement, and very frequently is complicated by attacks of mental disease.

General paralysis, which is a very common disease, was first recognized in France; it was identified by J. E. D. Esquirol, and further described and elaborated by A. L. J. Bayle, Delaye and J. L. Calmeil, the latter giving it the name of *paralyse générale des aliénés*.

As first described by the earlier writers the disease was regarded as being invariably associated with delusions of grandeur. At the present day this description does not apply to the majority of cases admitted into asylums. The change may be explained as being either due to an alteration in the type of the disease, or more probably the disease is better understood and more frequently diagnosed than formerly, the diagnosis being now entirely dependent on the physical and not on the mental symptoms. This latter may also be the explanation why general paralysis is much more common at the present day in British asylums than it was. The total death-rate from this disease in English and Scottish asylums rose from 1321 in 1894 to 1705 in 1904.

General paralysis attacks men much more frequently than women, and occurs between the ages of 35 and 50 years. It is essentially a disease of town life. In asylums which draw their patients from country districts in Scotland and Ireland, the disease is rare, whereas in those which draw their population from large cities the disease is extremely common.

Considerable diversity of opinion exists at present regarding the causation of general paralysis. Hereditary predisposition admittedly plays a very small part in its causation. There is, however, an almost universal agreement that the disease is essentially the result of toxæmia or poisoning, and that acquired or inherited syphilitic infection is an important predisposing factor. A history of syphilitic infection occurs in from 70 to 90% of the patients affected. At first it was held that general paralysis was a late syphilitic manifestation, but as it was found that no benefit followed the use of anti-syphilitic remedies the theory was advanced that general paralysis was a secondary auto-intoxication following upon syphilitic infection. The latest view is that the disease is a bacterial invasion, to which syphilis, alcoholism, excessive mental and physical strain, and a too exclusively nitrogenous diet, only act as predisposing causes. This latter theory has been recently advanced and elaborated by Ford Robertson and McRae of Edinburgh.

Whatever the cause of general paralysis may be, the disease is essentially progressive in character, marked by frequent remissions and so typical in its physical symptoms and pathology that we regard the bacterial theory with favour, although we are far from satisfied that the actual causative factor has as yet been discovered.

For descriptive purposes the disease is most conveniently divided into three stages,—called respectively the first, second and third,—but it must be understood that no clear line of demarcation divides these stages from one another.

The onset of general paralysis is slow and gradual, and the earliest symptoms may be either physical or mental. The disease may commence either in the brain itself or the spinal cord may be primarily the seat of lesion, the brain becoming affected secondarily. When the disease originates in the spinal cord the symptoms are similar to those of locomotor ataxia, and it is now believed that general paralysis and locomotor ataxia are one and the same disease; in the one case the cord, in the other the brain, being the primary seat of lesion. The early physical symptoms are generally motor. The patient loses energy, readily becomes tired, and the capacity for finely co-ordinated motor acts, such as are required in playing games of skill, is impaired. Transient attacks of partial paralysis of a hand, arm, leg or one side of the body, or of the speech centre are not uncommon. In a few cases the special senses are affected early and the patient may complain of attacks of dimness of vision or impairment of hearing. Or the symptoms may be purely mental and affect the highest and most recently acquired attributes of man, the moral sense and the faculty of self-control. The patient then becomes irritable, bursts into violent passions over trifles, changes in character and habits, frequently takes alcohol to excess and behaves in an

extravagant, foolish manner. Theft is often committed in this stage and the thefts are characterized by an open, purposeless manner of commission. The memory is impaired and the patient is easily influenced by others, that is to say he becomes facile. In other cases a wild attack of sudden excitement, following upon a period of restlessness and sleeplessness may be the first symptom which attracts attention. Whatever the mode of onset the physical symptoms which characterize the disease come on sooner or later. The speech is slurred and the facial muscles lose their tone, giving the face a flattened expression. The muscular power is impaired, the gait is straddling and the patient sways on turning. All the muscles of the body, but particularly those of the tongue, upper lip and hands, which are most highly innervated, present the symptom of fine fibrillary tremors. The pupils become irregular in outline, often unequal in size and either one or both fail to react normally to the stimuli of light, or of accommodation for near or distant vision.

As the disease advances there is greater excitability and a tendency to emotionalism. In classical cases the general exaltation of ideas becomes so great as to lead the patient to the commission of insanely extravagant acts, such as purchases of large numbers of useless articles, or of lands and houses far beyond his means, numerous indiscriminate proposals of marriage, the suggestion of utterly absurd commercial schemes, or attempts at feats beyond his physical powers. The mental symptoms, in short, are very similar to those of the elevated stage of manic-depressive insanity.

Delusions of the wildest character may also be present. The patient may believe himself to be in possession of millions of money, to be unsurpassed in strength and agility, to be a great and overruling genius, and the recipient of the highest honours. This grandiose condition is by no means present in every case and is not in itself diagnostic of the disease. But mental facility, placid contentment, complete loss of judgment and affection for family and friends, with impaired memory, are symptoms universally present. As the disease advances the motor symptoms become more prominent. The patient has great difficulty in writing, misses letters out of words, words out of sentences, and writes in a large laboured hand. The expression becomes fatuous. The speech is difficult and the facial muscles are thrown into marked tremors whenever any attempt at speech is made. The voice changes in timbre and becomes high-pitched and monotonous. The gait is weak and uncertain and the reflexes are exaggerated. In the first stage the patient, through restlessness and sleeplessness, becomes thin and haggard. As the second stage approaches sleep returns, the patient lays on flesh and becomes puffy and unhealthy in appearance. The mental symptoms are marked by greater facility and enfeeblement, while the paralysis of all the muscles steadily advances. The patient is now peculiarly liable to what are called congestive seizures or epileptiform attacks. The temperature rises, the face becomes flushed and the skin moist. Twitchings are noticed in a hand or arm. These twitchings gradually spread until they may involve the whole body. The patient is now unconscious, bathed in perspiration, which is offensive. The bowels and bladder empty themselves reflexly or become distended, and bedsores are very liable to form over the heels, elbows and back. Congestive seizures frequently last for days and may prove fatal or, on the other hand, the patient may have recurrent attacks and finally die of exhaustion or some accidental disease, such as pneumonia. In the second stage of the disease the patient eats greedily, and as the food is frequently swallowed unchewed, choking is not an uncommon accident. The special senses of taste and smell are also much disordered. We have seen a case of general paralysis, in the second stage drink a glass of quinine and water under the impression that he was drinking whisky.

The third stage of the disease is characterized by sleeplessness and rapid loss of body weight. Mentally the patient becomes quite demented. On the physical side the paralysis advances rapidly, so that the patient becomes bed-ridden and speechless. Death may occur as the result of exhaustion, or a congestive seizure, or of some intercurrent illness.



The duration of the disease is between eighteen months and three years, although it has been known to persist for seven.

No curative measures have so far proved of any avail in the treatment of general paralysis.

**INSANITY ASSOCIATED WITH EPILEPSY.**—The term "epileptic insanity," which has for many years been in common use, is now regarded as a misnomer. There is in short no such disease as epileptic insanity. A brain, however, which is so unstable as to exhibit the sudden discharges of nervous energy which are known as epileptic seizures, is prone to be attacked by insanity also, but there is no form of mental disease exclusively associated with epilepsy. Many epileptics suffer from the disease for a lifetime and never exhibit symptoms of insanity. The majority of patients, however, who suffer from epilepsy are liable to exhibit certain mental symptoms which are regarded as characteristic of the disease. Some suffer from recurrent attacks of depression, ill-humour and irritability, which may readily pass into violence under provocation. Others are emotionally fervid in religious observances, though sadly deficient in the practice of the religious life. A third class are liable to attacks of semi-consciousness which may either follow upon or take the place of a seizure, and during these attacks actions are performed automatically and without consciousness on the part of the patient.

When epileptics do become insane the insanity is generally one of the forms of mania. Either the patient suffers from sudden furious attacks of excitement in which consciousness is entirely abolished, or the mania is of the type of the elevated stage of folie circulaire (manic-depressive insanity) and alternates with periods of deep depression. In the elevated period the patient shows exaggerated self-esteem, with passionate outbursts of anger, and periods of religious emotionalism. While in the stage of depression the patient is often actively suicidal.

Epileptic patients who suffer from recurrent attacks of delirious mania are liable to certain nervous symptoms which indicate that not only are the motor centres in the brain damaged, but that the motor tracts in the spinal cord are also affected. The gait becomes awkward and laboured, the feet being lifted high off the ground and the legs thrown forward with a jerk. The tendon reflexes are at the same time exaggerated. These symptoms indicate descending degeneration of the motor tracts of the cord.

If the mental attacks partake of the character of elevation or depression the mental functions suffer more than the motor. These patients, in course of time, become delusional, enfeebled and childish, and in some cases the enfeeblement ends in complete dementia of a very degraded type.

Where insanity is superadded to epilepsy the prognosis is unfavourable.

**INSANITY ASSOCIATED WITH OR CAUSED BY ALCOHOLIC AND DRUG INTOXICATION.**—The true rôle of alcoholic indulgence in the production of insanity is at present very imperfectly understood. In many cases the alcoholism is merely a symptom of the mental disease—a result, not a cause.

In others, alcohol seems to act purely as a predisposing factor, breaking down the resistance of the patient and disordering the metabolism to such an extent that bodily disorders are engendered which produce well-marked and easily recognized mental symptoms. In others, again, alcohol itself may possibly act as a direct toxin, disordering the functions of the brain. In the latter class may be included the nervous phenomena of drunkenness, which commence with excitement and confusion of ideas, and terminate in stupor with partial paralysis of all the muscles. Certain brains which, either through innate weakness or as the result of direct injury, have become peculiarly liable to toxic influences, under the influence of even moderate quantities of alcohol pass into a state closely resembling delirious mania, a state commonly spoken of as *mania a potu*.

**Delirium Tremens.**—Delirium tremens is the form of mental disorder most commonly associated with alcoholic indulgence in the lay mind. Considerable doubt exists, however, as to whether the disease is directly or secondarily the result of

alcoholic poisoning. Much evidence exists in favour of the latter supposition. Delirium tremens may occur in persons who have never presented the symptom of drunkenness, or it may occur weeks after the patient has ceased to drink alcohol, and in such cases the actual exciting cause of the disease may be some accidental complication, such as a severe accident, a surgical operation, or an attack of pneumonia or erysipelas.

The early symptoms are always physical. The stomach is disordered. The desire for food is absent, and there may be abdominal pain and vomiting. The hands are tremulous, and the patient is unable to sleep. At this stage the disease may be checked by the administration of an aperient and some sedative such as bromide and chloral. The mental symptoms vary greatly in their severity. In a mild case one may talk to the patient for some time before discovering any mental abnormality, and then it will be found that confusion exists regarding his position and the identity of those around him, while the memory is also impaired for recent events. Hallucinations of sight and hearing may be present. The hallucinations of sight may be readily induced by pressure upon the eyeballs. If the symptoms are more acute they usually come on suddenly, generally during the evening or night. The patient becomes excited, suffers from vivid hallucinations of sight and hearing which produce great fear, and these hallucinations may be so engrossing as to render him quite oblivious to the environment. The hallucinations of sight are characterized by the false sense impressions taking the forms of animals or insects which surround or menace the patient. Visions may also appear in the form of flames, goblins or fairies. The hallucinations of hearing rarely consist of voices, but are more of the nature of whistlings, and ringings in the ears, shouts, groans or screams which seem to fill the air, or emanate from the walls or floors of the room. All the special senses may be affected, but sight and hearing are always implicated. Delirium tremens is a short-lived disease, generally running its course in from four to five days. Recovery is always preceded by the return of the power of sleep.

The patient must be carefully nursed and constantly watched, as homicidal and suicidal impulses are liable to occur under the terrifying influence of the hallucinations. The food should be concentrated and fluid, given frequently and in small quantities.

**Chronic Alcoholic Insanity.**—Almost any mental disorder may be associated with chronic alcoholism, but the most characteristic mental symptoms are delusions of suspicion and persecution which resemble very closely those of the persecution stage of systematized delusional insanity. The appearance of the patient is bloated and heavy; the tongue is furred and tremulous, and symptoms of gastric and intestinal disorder are usually present. The gait is awkward and dragging, owing to the partial paralysis of the extensor muscles of the lower limbs. All the skeletal muscles are tremulous, particularly those of the tongue, lips and hands. The common sensibility of the skin is disordered so that the patient complains of sensory disturbances, such as tinglings and prickings of the skin, which may be interpreted as electric shocks. In some cases the mental symptoms may be concealed, but delusions and hallucinations, particularly hallucinations of sight and hearing, are very commonly present.

The delusions are often directly the outcome of the physical state; the disordered stomach suggesting poisoning, and the disturbances of the special senses being interpreted as various forms of persecution. The patient hears voices shouting foul abuse at him; all his thoughts are read and repeated aloud; electric shocks are sent through him at night; gases are pumped into his room. Sexual delusions are very common and frequently affect marital relations by arousing suspicions regarding the fidelity of wife or husband; or the delusions may be more gross and take the form of belief in actual attempts at sexual mutilations. The memory is always impaired.

Patients who in addition to chronic alcoholism are also insane are always dangerous and liable to sudden and apparently causeless outbursts of violence.

**Dipsomania.**—Dipsomania is a condition characterized by recurrent or periodic attacks of an irresistible craving for

stimulants. The general bodily condition has a great deal to do with the onset of the attack, that is to say, the patient is more liable to an attack when the bodily condition is low than when the health is good. The attacks may be frequent or recur at very long intervals. They generally last for a few weeks, and may be complicated by symptoms of excitement, delusions or hallucinations.

*Treatment* consists in attention to the general health between attacks, with the use of such tonics as arsenic and strychnine. During the attack the patient should be confined to bed and treated with sedatives.

*Morphinism.*—The morphia habit is most commonly contracted by persons of a neurotic constitution. The mental symptoms associated with the disease may arise either as the result of an overdose, when the patient suffers from hallucinations, confusion and mild delirium, frequently associated with vomiting. On the other hand, mental symptoms very similar to those of delirium tremens may occur as the result of suddenly cutting off the supply of morphia in a patient addicted to the habit. Finally, chronic morphia intoxication produces mental symptoms very similar to those of chronic alcoholism. This latter condition, characterized by delusions of persecution, mental enfeeblement and loss of memory, is hopelessly incurable. The patient is always thin and anaemic on account of digestive disturbances. There is weakness or slight paralysis of the lower limbs, and the skeletal muscles are tremulous.

*Treatment.*—The quantity of the drug used must be gradually reduced until it is finally discontinued, and during treatment the patient must be confined to bed.

**SENILE INSANITY.**—States of mental enfeeblement are always the result of failure of development or of structural changes in the cortical grey matter of the brain. If the enfeeblement is due to failure of development or brain damage occurring in early life, it is spoken of as *idiotcy* or *imbecility*. Every form of insanity which occurs after a certain period of life is apt to be regarded by some observers as senile, but although the failing mental power may colour the character of the symptoms it cannot be regarded as correct to designate, for instance, a recurrent form of mania as senile merely because it necessarily manifests itself in a subject who has lived into the senile period. On the other hand, many persons first suffer from mental derangement at an advanced period of life without at the same time manifesting any marked failure of mental power, while others only manifest their insanity as a result of the decay of their mental faculties.

*Senile Insanity.* From this statement it will be seen that senile insanity is a complex of different conditions, some of them accompanied by dementia, others without dementia.

*Senile Dementia* is distinguished occasionally into "senile" properly so called, and "presenile" dementia, which supervenes at middle age or even earlier.

The occurrence of dementia is sometimes preceded by an acute hallucinatory phase, accompanied by mania or melancholia; but as a general rule, in the presenile cases, by neurasthenia, indifference, and mental apathy which extends to a disregard for the ordinary conventions and the means of subsistence.

It has pithily been remarked that the age of a man is the age of his blood-vessels. The two conditions of senile and presenile dementia cannot therefore be separated scientifically. From a clinical point of view, however, the two are distinguishable in so far as their symptoms are concerned, for the presenile cases are more complete and the process of dementia achieves its consummation earlier and quicker, while in the senile the gradual disease of the arteries and the slow decay of the mental faculties offer a different background for the manifestation of mental symptoms. Moreover, the senile patients more frequently present symptoms of recurrent attacks of acute insanity, a more pronounced emotionalism, and a greater tendency to restlessness at night. The presenile cases, on the other hand, except at the commencement of their malady, are usually free from acute and troublesome symptoms and present chiefly an apathetic indifference and irresponsiveness on the mental side, and on the

physical side a neurasthenic and enfeebled bodily state. In both conditions senile memory is greatly impaired.

Added to senile dementia there is often found a condition of mania or melancholia or even of systematized delusional insanity. The chief symptoms of the maniacal attacks are the great motor restlessness and excitement, which are worst during the night time. Sleep is almost always seriously disturbed, and the patients rapidly become exhausted unless carefully nursed and tended. The actions of senile maniacs are often puerile and foolish, and they may exhibit impulses of a homicidal, suicidal or sexual character. The melancholic cases are also extremely restless, and their emotion is loudly expressed in an uncontrollable manner. They often have delusions of persecution. They cries and groans have an automatic character, as if the patient, though compelled to utter them, did not experience the mental pain which he expressed. They also, many of them, eat their food ravenously, although a few obstinately refuse it. The senile delusional cases may manifest any of the classical forms of paranoia described above, but their delusions are of a rudimentary and unfinished type. The most common of all senile delusions is that they are being robbed. They therefore often hide their small valuables in corners and out-of-the-way places, and as their memories are very defective they are afterwards unable to find them. Others, who live alone, barricade their doors and try to prevent any one entering for fear of thieves. Delusions of ambition in senile subjects are usually of a very improbable and childish character. Hallucinations are generally present in the senile delusional cases.

The *treatment* of senile insanity is from the medical point of view not hopeful; it resolves itself largely into instructions for careful nursing, suitable feeding, and the protection of the patient from all the physical dangers to which he may be exposed.

*Statistics.*—The statistics of lunacy are merely of interest from a sociological point of view; for under that term are comprised all forms of insanity. It is needless to produce tables illustrative of the relative numbers of lunatics in the various countries of Europe, the systems of registration being so unequal in their working as to afford no trustworthy basis of comparison.

Even in Great Britain, where the systems are more perfect than in any other country, the tables published in the Blue Books of the three countries can only be regarded as approximately correct, the difficulty of registering all cases of lunacy being insuperable. On the 1st of January 1907, according to the returns made to the offices of the Commissioners in Lunacy, the numbers of lunatics stood thus on the registers:—

	Males.	Females.	Totals.
England and Wales . . .	57,176	66,812	123,988
Scotland . . . . .	8,594	8,999	17,593
Ireland . . . . .	12,254	11,300	23,554
Gross total . . . . .	78,024	87,111	165,135

These figures show the ratio of lunatics to 100,000 of the population to be 354 in England and Wales, 312 in Scotland, and 538 in Ireland.

*Numbers of Lunatics on the 1st of January of the years 1857-1907 inclusive, according to Returns made to the Offices of the Commissioners in Lunacy for England and Wales, Scotland and Ireland.*

Years.	England and Wales.	Scotland.	Ireland.
1858	..	5,823	..
1859	36,762	6,072	..
1860	38,058	6,273	..
1861	39,647	6,377	..
1862	41,129	6,398	8,055
1863	43,118	6,386	7,862
1864	44,795	6,422	8,272
1865	45,950	6,533	8,845
1866	47,648	6,730	8,964
1867	49,086	6,888	8,962
1868	51,000	7,055	9,086
1869	53,177	7,310	9,454
1870	54,713	7,571	10,082
1871	56,755	7,729	10,257
1872	58,640	7,849	10,767
1873	60,296	7,982	10,958

Years.	England and Wales.	Scotland.	Ireland.
1874	60,027	8,069	11,326
1875	63,793	8,225	11,583
1876	64,916	8,509	11,777
1877	66,636	8,862	12,123
1878	68,538	9,067	12,380
1879	69,885	9,386	12,585
1880	71,101	9,624	12,819
1881	73,113	10,012	13,062
1882	74,842	10,355	13,444
1883	76,765	10,510	13,882
1884	78,528	10,739	14,088
1885	79,704	10,918	14,279
1886	80,156	11,187	14,590
1887	80,891	11,309	14,702
1888	82,643	11,609	15,263
1889	84,340	11,954	15,685
1890	86,067	12,302	16,159
1891	86,795	12,595	16,281
1892	87,848	12,799	16,688
1893	89,822	13,058	17,124
1894	92,067	13,300	17,276
1895	94,081	13,852	17,665
1896	96,446	14,093	18,357
1897	99,365	14,500	18,966
1898	101,972	14,906	19,590
1899	105,086	15,399	20,304
1900	106,636	15,663	20,863
1901	109,644	15,899	21,469
1902	110,713	16,288	21,630
1903	113,964	16,658	22,138
1904	117,199	16,894	22,794
1905	119,829	17,241	22,996
1906	121,979	17,550	23,365
1907	123,988	17,453	23,554

There is thus an increased ratio in England and Wales of lunatics to the population (which in 1859 was 19,686,701, and in 1907 was estimated at 34,945,600) of 186·8 per 100,000 as against 354·8, and in Scotland of 157 as against 312 per 100,000. The Irish figures on the same basis have increased from 130·9 in 1862 to 538·1 in 1907. The publication of these figures has given rise to the question whether lunacy has actually become more prevalent during the last twenty years, whether there is real increase of the disease. There is a pretty general consensus of authority that if there has been an increase it is very slight, and that the apparent increase is due, first to the improved systems of registration, and secondly (a far more powerful reason) to the increasing tendency among all classes, and especially among the poorer class, to recognize the less pronounced forms of mental disorder as being of the nature of insanity. Thirdly, the grant of four shillings per week which in 1876 was made by parliament from imperial sources for the maintenance of pauper lunatics has induced parochial authorities to regard as lunatics a large number of weak-minded paupers, and to force them into asylums in order to obtain the benefit of the grant and to relieve the rates. These views receive support from the fact that the increase of private patients, i.e. patients who are provided for out of their own funds or those of the family, has advanced in a vastly smaller ratio. In their case the increase, small as it is, can be accounted for by the growing disinclination on the part of the community to tolerate irregularities of conduct due to mental disease. And again, careful inquiry has failed to show a proportional increase of admissions into asylums of such well-marked forms as general paralysis, puerperal mania, &c. The main cause of the registered increase of lunatics is thus to be sought for in the improved registration, and parochial and family convenience. If there is an actual increase, and there is reason for believing that there is a slight actual increase, it is due to the tendency of the population to gravitate towards towns and cities, where the conditions of health are inferior to those of rural life, and where there is therefore a greater disposition to disease of all kinds.

The utility of seeking for accurate figures bearing on the relative number of lunatics in other countries is illustrated by the tables set forth in a report by the United States Census Bureau. They show that the number of registered lunatics in 1903 was 150,151; in 1890, 74,082; and in 1880, 40,942. An attempt was made in 1890 to estimate the number of insane persons outside of hospitals, which was stated to be 32,457. In 1903 no such attempt was made, as it was admitted that so many sources of fallacy existed as to render it useless. Thus the mere statement that of every 100,000 of the population (calculated at 80,000,000) 186·2 were registered as insane is of no value.

**BIBLIOGRAPHY.**—The following are systematic works: Bucknill and Tuke, *Psychological Medicine* (4th edition, 1879); Griesinger, *On Mental Diseases* (New Sydenham Society, 1867); Maudsley,

*The Pathology of Mind* (1895); Bevan Lewis, *A Text-Book of Mental Diseases* (1899); Clouston, *Clinical Lectures on Mental Diseases* (1892); Kraepelin, *Psychiatrie* (1893); Kraft-Ebing, *Lehrbuch der Psychiatrie* (1893); Regis, *A Practical Manual of Mental Medicine* (London, 1895); Magnan, *Leçons cliniques sur les maladies mentales* (1897); Mendil, *Leitfaden der Psychiatrie* (1902); Mercier, *A Text-Book of Insanity* (1902); Lewis C. Bruce, *Studies in Clinical Psychiatry* (1906); Macpherson, *Mental Affections* (1899); Brower-Bannister, *Practical Manual of Insanity* (1902); Ford Robertson, *Text-Book of Pathology in Relation to Mental Diseases* (1900). (J. B. T.; J. M.; L. C. B.)

## II. LEGAL ASPECTS

The effect of insanity upon responsibility and civil capacity has been recognized at an early period in every system of law.

**Roman Law.**—In the Roman jurisprudence its consequences were very fully developed, and the provisions and terminology of that system have largely affected the subsequent legal treatment of the subject. Its leading principles were simple and well marked. The insane person having no intelligent will, and being thus incapable of consent or voluntary action, could acquire no right and incur no responsibility by his own acts (see Sohm's *Inst. Roman Law*, 3rd ed. pp. 216, 217, 219); his person and property were placed after inquiry by the magistrate under the control of a *curator*, who was empowered and bound to manage the property of the lunatic on his behalf (Sohm, p. 513; Hunter, *Roman Law*, pp. 732–735). The different terms by which the insane were known, such as *demens*, *furiosus*, *fatusus*, although no doubt signifying different types of insanity, did not in Roman law infer any difference of legal treatment. They were popular names, which all denoted the complete deprivation of reason.

**Medieval Law.**—During the middle ages the insane were little protected. Their legal acts were annulled, and their property placed under control, but little or no attempt was made to supervise their personal treatment. In England the wardship of idiots and lunatics, which was annexed before the reign of Edward II. to the king's prerogative, had regard chiefly to the control of their lands and estates, and was only gradually elaborated into the systematic control of their persons and property now exercised under the jurisdiction in lunacy. Those whose means were insignificant were left to the care of their relations or to charity. In criminal law the plea of insanity was unavailing except in extreme cases. About the beginning of the 19th century a very considerable change commenced. The public attention was strongly attracted to the miserable condition of the insane incarcerated in asylums without any efficient check or inspection; and at the same time the medical knowledge of insanity entered on a new phase. The possibility and advantages of a better treatment of insanity were illustrated by eminent physicians, Philippe Pinel in France, H. Tuke in England, Bond, B. Rush and I. Ray in the United States; its physical origin became generally accepted; its mental phenomena were more carefully observed, and its relation was established to other mental conditions.

**Modern Law.**—From this period we date the commencement of legislation such as that known in England as the Lunacy Acts, which aimed at the regulation and control of all constraint applied to the insane. Hitherto, the criteria of insanity had been very rude, and the evidence was generally of a loose and popular character; but, whenever it was fully recognized that insanity was a disease with which physicians who had studied the subject were peculiarly conversant, expert evidence obtained increased importance, and from this time became prominent in every case. The newer medical views of insanity were thus brought into contact with the old narrow conception of the law courts, and a controversy arose in the field of criminal law which in England, at least, still continues.

**Relations between Insanity and Law.**—The fact of insanity may operate in law—(1) by excluding responsibility for crime; (2) by invalidating legal acts; (3) by affording ground for depriving the insane person by a legal process of the control of his person and property; or (4) by affording ground for putting him under restraint.

**Legal Terminology.**—Before proceeding, however, to deal with

these matters in succession, it may be desirable to say something with regard to the chief legal terms respecting persons suffering under mental disabilities. The subject is now of less importance than formerly, because the modern tendency of the law is to determine the capacity or responsibility of a person alleged to be insane by considering it with reference to the particular matter or class of matters which brings his mental condition *sub judice*. But the literature of the law of lunacy cannot be clearly understood unless the distinctions between the different terms employed to describe the insane are kept in view. The term *non compos mentis* is as old as the statute *De praerogativa regis* (1325), and is used sometimes, as in that statute, to indicate a species contrasted with idiot, sometimes (e.g. in Co. Litt. 246 (b)) as a genus, and afterwards, chiefly in statutes relating to the insane, in connexion with the terms "idiot" and "lunatic" as a word *ejusdem generis*. The word "idiot" (Gr. *ἰδιωτ*, a private person, one who does not hold any public office, and *ἰδιωτῆς*, an ignorant and illiterate person) appears in the statute *De praerogativa regis* as *fatus naturalis*, and it is placed in contradistinction to *non compos mentis*. The "idiot" is defined by Sir E. Coke (4 *Rep.* 124 (b)) as one who from his nativity, by a perpetual infirmity, is *non compos mentis*, and Sir M. Hale (*Pleas of the Crown*, i. 29) describes idiocy as "fatuity a *nativitate vel dementia naturalis*." In early times various artificial criteria of idiocy were suggested. Fitzherbert's test was the capacity of the alleged idiot to count twenty pence, or tell his age, or who were his father and mother (*De natura brevium*, 233). Swinburne proposed as a criterion of capacity, *inter alia*, to measure a yard of cloth or name the days in the week (*Testaments*, 42). Hale propounded the sounder view that "idiocy or not is a question of fact triable by jury and sometimes by inspection" (*Pleas of the Crown*, i. 29). The legal incidents of idiocy were at one time distinct in an important particular from those of lunacy. Under the statute *De praerogativa regis* the king was to have the rents and profits of an idiot's lands to his own use during the life of the idiot, subject merely to an obligation to provide him with necessaries. In the case of the lunatic the king was a trustee, holding his lands and tenements for his benefit and that of his family. It was on account of this difference in the legal consequences of the two states that on inquisitions distinct writs, one of *idiota inquirendo*, the other of *lunatico inquirendo*, were framed for each of them. But juries avoided finding a verdict of idiocy wherever they could, and the writ of *idiota inquirendo* fell into desuetude. A further blow was struck at the distinction when it came to be recognized even by the legislature (see the Idiots Act 1886) that idiots are capable of being educated and trained, and it was practically abolished when the Lunacy Regulation Act 1862, in a provision reproduced in substance in the Lunacy Act 1890, limited the evidence admissible in proof of unsoundness of mind on an inquisition (without special leave of the Master trying the case) to a period of two years before the date of the inquiry, and raised a uniform issue, viz. the state of mind of the alleged lunatic at the time when the inquisition is held.

The term "lunatic," derived from the Latin *luna* in consequence of the notion that the moon had an influence on mental disorders,<sup>1</sup> does not appear in the statute-book till the time of Henry VIII. (1541). Coke defines a lunatic as a "person who has sometimes his understanding and sometimes not, *qui gaudet lucidus intervalis*, and therefore he is called *non compos mentis* so long as he has not understanding" (Co. Litt. 247 (a), 4 *Rep.* 124 (b)). Hale defines "lunacy" as "interpolated" (*i.e.* intermittent) *dementia accidentalis vel adventitia*, whether total or (as a description, it will be observed, of "partial insanity") *quoad hoc vel illud* (*Pleas of the Crown*, i. 29). In modern times, the word "lunacy" has lost its former precise signification. It is employed sometimes in the strict sense, sometimes in contradistinction to "idiocy" or "imbecility"; once at least—viz. in the Lunacy Act 1890—as including "idiot"; and frequently

in conjunction with the vague terms "unsound mind" (non-sane memory) and "insane." Section 116 of the Lunacy Act 1890 has by implication extended the meaning of the term lunacy so as to include for certain purposes the incapacity of a person to manage his affairs through mental infirmity arising from disease or age. "Imbecility" is a state of mental weakness "between the limits of absolute idiocy on the one hand and of perfect capacity on the other" (see 1 Haggard, *Eccles. Rep.* p. 401).

1. *The Criminal Responsibility of the Insane.*—The law as to the criminal responsibility of the insane has pursued in England a curious course of development. The views of Coke and Hale give the best exposition of it in the 17th century. Both were agreed that in criminal causes the act and wrong of a madman shall not be imputed to him; both distinguished, although in different language, between *dementia naturalis* (or *a natiuitate*) and *dementia accidentalis* or *adventitia*; and the main points in which the writings of Hale mark an advance on those of Coke are in the elaboration by the former of the doctrine of "partial insanity," and his adoption of the level of understanding of a child of fourteen years of age as the test of responsibility in criminal cases (*Pleas of the Crown*, i. 29, 30; and see Co. 4 *Rep.* 124 (b)). In the 18th century a test, still more unsatisfactory than this "child of fourteen" theory, with its identification of "healthy immaturity" with "diseased maturity" (Steph. *Hist. Crim. Law*, ii. 150), was prescribed. On the trial of Edward Arnold in 1723 for firing at and wounding Lord Onslow, Mr Justice Tracy told the jury that "a prisoner, in order to be acquitted on the ground of insanity, must be a man that is totally deprived of his understanding and memory, and doth not know what he is doing, no more than an infant, than a brute or wild beast." In the beginning of the 19th century a fresh statement of the test of criminal responsibility in mental disease was attempted. On the trial of Hadfield for shooting at George III. in Drury Lane Theatre on 15th May 1800, Lord Chief Justice Kenyon charged the jury in the following terms: "If a man is in a deranged state of mind at the time, he is not criminally answerable for his acts; but the material part of the case is whether at the very time when the act was committed the man's mind was sane." The practical effect of this ruling, had it been followed, would have been to make the question of the amenability of persons alleged to be insane to the criminal law very much one of fact, to be answered by juries according to the particular circumstances of each case, and without being aided or embarrassed by any rigid external standard. But in 1812, on the trial of Bellingham for the murder of Mr Perceval, the First Lord of the Treasury, Sir James Mansfield propounded yet another criterion of criminal responsibility in mental disease, viz. whether a prisoner has, at the time of committing an offence, a sufficient degree of capacity to distinguish between good and evil. The objection to this doctrine consisted in the fact, to which the writings of Continental and American jurists soon afterwards began to give prominence, that there are very many lunatics whose general ideas on the subject of right and wrong are quite unexceptionable, but who are yet unable, in consequence of delusions, to perceive the wrongness of particular acts. Sir James Mansfield's statement of the law was discredited in the case *4 State Tri.* (n.s.) 847; 10 Cl. and Fin. 200) of Daniel Macnaughton, who was tried in March 1843, before Chief Justice Tindal, Mr Justice Williams and Mr Justice Coleridge, for the murder of Mr Drummond, the private secretary of Sir Robert Peel. Mr (afterwards Lord Chief Justice) Cockburn, who defended the prisoner, used Hale's doctrine of partial insanity as the foundation of the defence, and secured an acquittal, Chief Justice Tindal telling the jury that the question was whether Macnaughton was capable of distinguishing right from wrong with respect to the act with which he stood charged. This judicial approval of the doctrine of partial insanity formed the subject of an animated debate in the House of Lords, and in the end certain questions were put by that House to the judges, and answered by Chief Justice Tindal on behalf of all his colleagues except Mr Justice Maule, who gave

<sup>1</sup> The word for "lunatic" in several other languages has a similar etymology. Cp. Ital. *lunatico*, Span. *alunado*, Gr. *αεραμαχος* (epileptic), Ger. *mondsichtig*.

independent replies. The answers to those questions are commonly called "The Rules in Macnaughton's case," and they still nominally contain the law of England as to the criminal responsibility of the insane. The points affirmed by the Rules that must be noted here are the propositions that knowledge of the nature and quality of the particular criminal act, at the time of its commission, is the test of criminal responsibility, and that delusion is a valid exculpatory plea, when, and only when, the fancies of the insane person, if they had been facts, would have been so. The Rules in Macnaughton's case are open to serious criticism. They ignore, at least on a literal interpretation, those forms of mental disease which may, for the present purpose, be roughly grouped under the heading "moral insanity," and in which the moral faculties are more obviously deranged than the mental—the affections and the will, rather than the reason, being apparently disordered. The test propounded with reference to delusions has also been strenuously attacked by medical writers, and especially by Dr Maudsley in his work on *Responsibility in Mental Disease*, on the ground that it first assumes a man to have a delusion in regard to a particular subject, and then expects and requires him to reason sanely upon it. It may be pointed out, however, that in thus localizing the range of the immunity which insane delusion confers, the criminal law is merely following the course which, *mutatis mutandis*, the civil law has, with general acceptance, adopted in questions as to the contractual and testamentary capacity of the insane.

The Rules in Macnaughton's case have, as regards moral insanity, undergone considerable modification. Soon after they were laid down, Sir (then Mr) James Fitz-James Stephen, in an article in the *Juridical Papers*, i. 67, on the policy of maintaining the existing law as to the criminal responsibility of the insane, foreshadowed the view which he subsequently propounded in his *History of the Criminal Law*, ii. 163, that no man who was deprived by mental disease of the power of passing a fairly rational judgment on the moral character of an act could be said to "know" its nature and quality within the meaning of the Rules; and it has in recent years been found possible in practice so to manipulate the test of the criminal responsibility which they prescribed as to afford protection to the accused in the by no means infrequent cases of insanity which in its literal interpretation it would leave without excuse.

In Scotland the Rules in Macnaughton's case are recognized, but, as in England, there is a tendency among judges to adopt a generous construction of them. Mental unsoundness insufficient to bar trial, or to exempt from punishment, may still, it is said, be present in a degree which is regarded as reducing the offence from a higher to a lower category,—a doctrine first practically applied in Scotland, it is believed, in 1867 by Lord Deas; and the fact that a prisoner is of weak or ill-regulated mind is often urged with success as a plea in mitigation of punishment. The Indian Penal Code (Act XLV. of 1860, § 84) expressly adopts the English test of criminal responsibility, but the qualifications noted in the case of Scotland have received some measure of judicial acceptance (see Mayne, *Crim. Law Ind.*, 3rd ed., pp. 493-410; Nelson, *Ind. Pen. Code*, 3rd ed., pp. 135 et seq.). The Rules in Macnaughton's case have also been adopted in substance in those colonies which have codified the criminal law. The following typical references may be given: 55 and 56 Vict. (Can.) c. 20, § 11; 57 Vict. (N.Z.), No. 56 of 1893, § 23; No. 101 of 1888 (St. Lucia), § 50; No. 5 of 1876 (Gold Coast), § 40 (b); No. 2 of 1883, art. 77 (Ceylon); No. 4 of 1871, art. 84 (Straits Settlements). On the other hand, a departure towards a recognition of "moral insanity" is made by the Queensland Criminal Code (No. 9 of 1890), § 27 of which provides that "a person is not criminally responsible for an act" if at the time of doing it "he is in such a state of mental disease . . . as to deprive him . . . of capacity to control his actions"; and the law has been defined in the same sense in the Cape of Good Hope in the case of *Queen v. Hay* (1890, 16 S.C.R. 200). The Rules were rapidly reproduced in the United States, but the modern trend of American judicial opinion is adverse to them (see Clevenger, *Med. Jur. of Ins.* p. 125; *Parsons v. State* (1887) 81 Ala. 577).

On the Continent of Europe moral insanity and irresistible impulse are freely recognized as exculpatory pleas (see the French *Code Penal*, § 64; Belgian *Code Penal*, § 71; German *Penal Code*, § 51; Italian *Penal Code*, §§ 46, 47).

Not only is insanity at the time of the commission of an offence a valid exculpatory plea, but supervening insanity stays the action of the criminal law at every stage from arrest up to punishment. High treason was formerly an exception, but the statute making it so (33 Hen. VIII. c. 20) was repealed in the time of Philip and Mary. The Home Secretary has power, under the Criminal Lunatics Act 1884 to order by warrant the removal of a prisoner, certified to be insane, to a lunatic asylum, before trial or after trial, whether under sentence of death or not. Prisoners dealt with under these provisions are styled "Secretary of State's lunatics." On the other hand, a prisoner who on arraignment appears, or is found by the jury to be unfit to plead, or who is found "guilty but insane" at the time of committing the offence—a verdict substituted by the Trial of Lunatics Act 1883 for the old verdict of "acquitted on the ground of insanity," in the hope that the formal conviction recorded in the new finding might have a deterrent effect on the mentally unstable—is committed to a criminal lunatic asylum by the order of the judge trying the case, to be detained there "during the king's pleasure." Lunatics of this class are called "king's pleasure lunatics." There was no doubt at common law as to the power of the courts to order the detention of criminal lunatics in safe custody, but, prior to 1800, the practice was varying and uncertain. On the acquittal of Hadfield, however, in that year for the attempted murder of George III., a question arose as to the provision which was to be made for his detention, and the Criminal Lunatics Act 1800, part of which is still in force, was passed to affirm the law on the subject.

The Criminal Lunatics Act contains provisions similar to those of the Lunacy Act 1800, as to the discharge (conditional or absolute) and transfer of criminal lunatics and the detention of persons becoming pauper lunatics. The expenses of the maintenance of criminal lunatics are defrayed out of moneys provided by Parliament (Crim. Lun. Act 1884, and Hansard, 3rd series, vol. cxcx. p. 75; 139 Com. Jo. pp. 336, 340, 344). The Lunatics' Removal (India) Act 1851 provides for the removal to a criminal lunatic asylum in Great Britain of persons found guilty of crimes and offences in India, and acquitted on the ground of insanity. Similar provisions with regard to colonial criminal lunatics are contained in the Colonial Prisoners' Removal Act 1884; and the policy of this statute has been followed by No. 5. of 1894 (New South Wales), and Ord. No. 2 of 1895 (Falkland Islands). Indian law (see Act V. of 1808, §§ 464-475) and the laws of the colonies (the Cape Act No. 1 of 1897 is a typical example) as to the trial of lunatics are similar to the English. In Scotland all the criminal lunatics, except those who may have been removed to the ordinary asylums or have been discharged, are confined in the Criminal Asylum established at Perth in connexion with H.M.'s General Prison, and regulated by special acts (23 & 24 Vict. c. 105, and 40 & 41 Vict. c. 53). Provision similar to the English has been made for prisoners found insane as a bar to trial, or acquitted on the ground of insanity or becoming insane in confinement. In New York, Michigan and other American states there are criminal lunatic asylums. Elsewhere insane criminals are apparently detained in state prisons, &c. The statutory rules as to the maintenance of criminal lunatic asylums, the treatment of the criminal insane, and the plea of insanity in criminal courts in America, closely resemble English practice.

It has sometimes been stated that this power, which ought clearly, in the interests alike of prisoners and of the public, to be exercised with caution, is in fact exerted in an unduly large number of cases. The following figures, taken from the respective volumes of the *Criminal Judicial Statistics*, show the number of criminal lunatics certified insane before trial. In 1884-1885, out of a total of 938 criminal lunatics, 169 were so certified; in 1885-1886, 149 out of 890; in 1889-1890, 108 out of 926; in 1890-1891, 95 out of 900; in 1894, 78 out of 738; in 1895, 84 out of 759; in 1896, 88 out of 769; in 1897, 85 out of 764; in 1898, 17 out of 209; in 1899, 13 out of 159; in 1900, 12 out of 185; in 1901, 15 out of 205; in 1902, 7 out of 235; in 1903, 11 out of 229.

The only special point in Continental law calling for notice is the system by which official experts report for the guidance of the tribunals on questions of alleged criminal irresponsibility (see, e.g., the German Code of Penal Procedure, § 203, and cp. § 81).

2. *Insanity and Civil Capacity.*—The law as to the civil capacity of the insane was for some time influenced in Great Britain by the view propounded by Lord Brougham in 1848 in the case of *Waring v. Waring*, and by Sir J. P. Wilde in a later case, raising the question of the validity of a marriage, that, as the mind is one and indivisible, the least disorder of its faculties was fatal to civil capacity. In the leading case of *Banks v. Goodfellow* in 1870, the court of queen's bench, in an elaborate judgment delivered by Chief Justice Cockburn, disapproved of this doctrine, and in effect laid down the principle that the question of capacity must be considered with strict reference to the act which has to be or has been done. Thus a certain degree of unsoundness of mind is not now, in the absence of undue influence, a bar to the formation of a valid marriage, if the party whose capacity is in question knew at the time of the marriage the nature of the engagement entered into (but see 51 Geo. III. c. 37 as to the marriage of lunatics so found by inquisition). Again, a man whose mind is affected may make a valid will, if he possesses at the time of executing it a memory sufficiently active to recall the nature and extent of his property, the persons who have claims upon his bounty, and a judgment and will sufficiently free from the influence of morbid ideas or external control to determine the relative strength of those claims. So far has this rule been carried, that in 1893 probate was granted of the will of a lady who was a Chancery lunatic at the date of its execution, and died without the inquisition having been superseded. (*Roe v. Nix*, 1893, p. 55.) It is also now settled that the simple contract of a lunatic is voidable and not void, and is binding upon him, unless he can show that at the time of making it he was, to the knowledge of the other party, so insane as not to know what he was about. (*Imperial Loan Co. v. Goodfellow*, 1891, 1 Q.B. 590.) The test established by *Banks v. Goodfellow* is applied also in a number of minor points in which civil capacity comes into question, e.g. competency of the insane as witnesses. The law implies, on the part of a lunatic, whether so found or not, an obligation to pay a reasonable price for "necessaries" supplied to him; and the term "necessaries" means goods suitable to his condition in life and to his actual requirements at the time of sale and delivery. (*Sale of Goods Act 1893*).

The question of the liability of an insane person for tort appears still to be undecided (see Pollock on *Torts*, 7th ed. p. 53; Clerk and Lindsell on *Torts*, 2nd ed. pp. 39, 40; *Law Quart. Rev.* vol. xiii. p. 325). Supervening insanity is no bar to proceedings by or against a lunatic husband or wife for divorce or separation for previous matrimonial offences. It does not avoid a marriage nor constitute *per se* a ground either for divorce or for judicial separation. But cruelty does not cease to be a cause of suit if it proceeds from disorderly affections or want of moral control falling short of positive insanity; and possibly even cruelty springing from intermittent or recurrent insanity might be held a ground for judicial separation, since in such case the party offended against cannot obtain protection by securing the permanent confinement of the offending spouse. Whether insanity at the time when an alleged matrimonial offence was committed is a bar to a suit for divorce or separation is an open question; and in any event, in order that it may be so, the insanity must be of such a character as to have prevented the insane party from knowing the nature and consequences of the act at the time of its commission. The laws of Scotland, Ireland, India (see, e.g., Act IX. of 1872, § 12), the colonies and the United States are substantially identical with English law on the subject of the civil capacity of the insane. The German Civil Code (§1560) recognizes the lunacy of a spouse as a ground for divorce, but only where the malady continues during at least three years of the union, and has reached such a pitch that intellectual intercourse between the spouses is impossible, and that every prospect of a restoration of such association is excluded. If one of the spouses obtains a divorce on the ground of the lunacy of the other

the former has to allow alimony, just as a husband declared to be the sole guilty party in a divorce suit would have to do (§§ 1585, 1578).

3. *The Jurisdiction in Lunacy.*—In order to effect a change in the status of persons alleged to be of unsound mind, and to bring their persons and property under control, the aid of the jurisdiction in lunacy must be invoked. Under the unreppealed statute *De Prærogativa Regis* (1325) the care and custody of lunatics belong to the Crown. But the Crown has, at least since the 16th century, exercised this branch of the prerogative by delegates, and principally through the Lord Chancellor—not as head of the Court of Chancery, but as the representative and delegate of the sovereign. Under the Lunacy Acts 1800 and 1891, the jurisdiction in lunacy is exercised first by the Lord Chancellor and such of the Lords Justices and other judges as may be invested with it by the sign-manual; and, secondly, by the two Masters in Lunacy, appointed by the Lord Chancellor, from members of the bar of at least ten years' standing, whose duties include the holding of inquisitions and summary inquiries, and the making of most of the consequential orders dealing with the persons and estates of lunatics. County court judges may also exercise a limited jurisdiction in lunacy in the case of lunatics as to whom a reception order has been made, if their entire property is under £200 in value, and no relative or friend is willing to undertake the management of it; in partnership cases where the assets do not exceed £500; and upon application by the guardians of any union for payment of expenses incurred by them in relation to any lunatic.

Persons of unsound mind are brought under the jurisdiction in lunacy either by an inquisition *de lunatico inquirendo*, or, in certain cases which will be adverted to below, by proceedings instituted under §116 of the Lunacy Act 1890, which is now the great practice section in the Lunacy Office. Prior to 1853 a special commission was issued to the Masters in each alleged case of lunacy. But by the Lunacy Regulation Act of that year a general commission was directed to the Masters, empowering them to proceed in each case in which the Lord Chancellor by order required an inquisition to be held. This procedure is still in force. A special commission would now be issued only where both Masters were personally interested in the subject of the inquiry, or for some other similar reason. An inquisition is ordered by the judge in lunacy (a term which does not, for this purpose, at present include the Masters, although this is one of the points in regard to which a change in the law has been suggested, on the petition generally of a near relative of the alleged lunatic. The inquiry is held before one of the Masters, and a jury may be summoned if the alleged lunatic, being within the jurisdiction, demands it, unless the judge is satisfied that he is not competent to form and express such a wish; and even in that case the Master has power to direct trial by jury if he thinks fit on consideration of the evidence. Where the alleged lunatic is not within the jurisdiction the trial must be by jury; and the judge in lunacy may direct this mode of trial to be adopted in any case whatever.

A few points of general interest in connexion with inquisitions must be noted. In practice thirty-four jurors are summoned by the sheriff, and not more than twenty-four are empanelled. Twelve at least must concur in the verdict. Counsel for the petitioner ought to act in the judicial spirit expected from counsel for the prosecution in criminal cases. The issue to be determined on an inquisition is "whether or not the alleged lunatic is at the time of the inquisition of unsound mind, and incapable of managing himself and his affairs" (a special verdict may, however, be found that the lunatic is capable of managing himself, although not his affairs, and that he is not dangerous to others); and without the direction of the person holding the inquisition, no evidence as to the lunatic's conduct at any time being more than two years before the inquisition is to be receivable. This limitation, both of the issue and of the evidence, was imposed with a view to preventing the recurrence of such cases as that of Mr Windham in 1861-1862, when the inquiry ranged over the whole life of an alleged lunatic, forty-eight witnesses being

examined on behalf of the petitioners and ninety-one on behalf of the respondents, while the hearing lasted for thirty-four days. For the purpose of assisting the Master or jury in arriving at a decision, provision is made for the personal examination of the alleged lunatic by them on oath or otherwise, and either in open court or in private, as may be directed. The proceedings on inquisition are open to the public. When a person has been found lunatic by inquisition he becomes subject to the jurisdiction in lunacy, and remains so (unless he succeeds in setting aside the verdict by a "traverse"—a proceeding which ultimately comes before, and is determined by, the King's Bench Division in London or at the assizes) until his recovery, when the inquisition may be put an end to by a procedure technically known as "supersedes," or by his death. The results of the inquisition are worked out in the Lunacy Office. The control of the estate, and, except where he was found incapable of managing his property only, of the person of the lunatic is entrusted to committees of the estate and person, who are appointed by, and accountable to, the Master in Lunacy, and whose legal position corresponds roughly with that of the tutors and curators of the civil law. The committee of the estate in particular exercises over the property of the lunatic, with the sanction or by the order of the Master, very wide powers of management and administration, including the raising of money by sale, charge or otherwise, to pay the lunatic's debts, or provide for his past or future maintenance, charges for permanent improvements, the sale of any property belonging to the lunatic, the execution of powers vested in him and the performance of contracts relating to property.

The alternative method of bringing a person of unsound mind under lunacy jurisdiction was created by § 116 of the Lunacy Act 1890. The effect of that section briefly is to enable the Master, on a summons being taken out in his chambers and heard before him, to apply the powers of management and administration summarized in the last preceding paragraph, without any inquisition, to the following classes of cases: lunatics not so found by inquisition, for the protection or administration of whose property any order was made under earlier acts; every person lawfully detained, within the jurisdiction of the English courts, as a lunatic, though not so found by inquisition; persons not coming within the foregoing categories who are "through mental infirmity arising from disease or age" incapable of managing their affairs; persons of unsound mind whose property does not exceed £2000 in value, or does not yield an annual income of more than £100; and criminal lunatics continuing insane and under confinement.

In Scotland the insane are brought under the jurisdiction in lunacy by alternative methods, similar to the English inquisition and summary procedure, viz. "cognition," the trial taking place before the Lord President of the Court of Session, or any judge of that court to whom he may remit it, and a jury of twelve—see § 31 & 32 Vict. c. 100, and Act of Sederunt of 3rd December 1868—and an application to the Junior Lord Ordinary of the Court of Session or (43 & 44 Vict. c. 4, § 4) to the Sheriff Court, when the estate in question does not exceed £100 a year, for the appointment of a *curator bonis* or judicial factor.

The powers of the Lord Chancellor of Ireland with regard to lunatics are generally similar to those of the English Chancellor (see the Lunacy Regulations (Ireland) Act 1871, 34 & 35 Vict. c. 22, and the Lunacy (Ireland) Act 1901, 1 Ed. VII. c. 17; also Colles on *The Lunacy Regulation (Ireland) Act*).

The main feature of the French system is the provision made by the Civil Code (arts. 489-512) for the interdiction of an insane person by the Tribunal of First Instance, with a right of appeal to the Court of Appeal, after a preliminary inquiry and a report by a family council (arts. 407, 408), consisting of six blood relatives in as near a degree of relationship to the lunatic as possible, or, in default of such relatives, of six relatives by marriage. The family council is presided over by the *Juge de Paix* of the district in which the lunatic is domiciled. This system is also in force in Mauritius.

There are provisions, it may be noted, in Scots law for the interdiction of lunatics, either voluntarily or judicially (see

Bell's *Principles*, § 2123). The German Civil Code provides for insane persons being made subject to guardianship (*vormundung*), on conditions similar to those of Scots and French law (see Civil Code, §§ 6, 104 (1896, 1906), 645-679). In the United States the fundamental procedure is an inquisition conducted on practically the same lines as in England. (Cf. *Indiana, Rev. Stats.* (1894) §§ 2715 et seq.; *Missouri, Annot. Code* (1892) §§ 2835 et seq.; *New Mexico, General Laws* (1880) c. 74 §§ 1 et seq.).

4. *Asylum Administration.*—Asylum administration in England is now regulated by the Lunacy Acts 1890 and 1891. Receptacles for the insane are divisible into the following classes: (i.) Institutions for lunatics, including asylums, registered hospitals and licensed houses. The asylums are provided by counties or boroughs, or by union of counties or boroughs. Registered hospitals are hospitals holding certificates of registration from the Commissioners in Lunacy, where lunatics are received and supported wholly or partially by voluntary contributions or charitable bequests, or by applying the excess of the payments of some patients towards the maintenance of others. Licensed houses are houses licensed by the Commissioners, or, beyond their immediate jurisdiction, by justices; (ii.) Workhouses—see article POOR LAW; (iii.) Houses in which patients are boarded out; (iv.) Private houses (unlicensed) in which not more than a single patient may be received. A person, not being a pauper or a lunatic so found by inquisition, cannot, in ordinary cases, be received and detained as a lunatic in any institution for the insane, except under a "reception order" made by a county court judge or stipendiary magistrate or specially appointed justice of the peace. The order is made on a petition presented by a relative or friend of the alleged lunatic, and supported by two medical certificates, and after a private hearing by the judicial authority. The detention of a lunatic is, however, justifiable at common law, if necessary for his safety or that of others; and the Lunacy Act 1890, borrowing from the lunacy law of Scotland, provides for the reception of a lunatic not a pauper into an asylum, where it is expedient for his welfare or the public safety that he should be confined without delay, upon an "urgency order," made if possible by a near relative and accompanied by one medical certificate. The urgency order only justifies detention for seven days (the curtailment of this period to four days is proposed), and before the expiration of that period the ordinary procedure must be followed. "Summary reception orders" may be made by justices otherwise than on petition. There are four classes of cases in which such orders may be made, viz.: (i.) lunatics (not paupers and not wandering at large) who are not under proper care and control, or are cruelly treated or neglected; (ii.) resident pauper lunatics; (iii.) lunatics, whether pauper or not, wandering at large; (iv.) lunatics in workhouses. (As to pauper lunatics generally, see article POOR LAW.) A lunatic may also be received into an institution under an order by the Commissioners in Lunacy; and a lunatic so found by inquisition under an order signed by the committee of his person.

The chief features of English asylum administration requiring notice are these. Mechanical restraint is to be applied only when necessary for surgical or medical purposes, or in order to prevent the lunatic from injuring himself or others. The privacy of the correspondence of lunatics with the Lord Chancellor, the Commissioners in Lunacy, &c., is secured. Provision is made for regular visits to patients by their relatives and friends. The employment of males for the custody of females is, except on occasions of urgency, prohibited. Pauper lunatics may be boarded out with relatives and friends. Elaborate provision is made for the official visitation of every class of receptacle for the insane. The duties of visitation are divided between the Commissioners in Lunacy, the Chancery Visitors and various other visitors and visiting committees. There are ten Commissioners in Lunacy—four unpaid and six paid, three of the latter being barristers of not less than five years' standing at the date of appointment, and three medical. The Commissioners in Lunacy, who are appointed by the Lord Chancellor, visit every class of lunatics except persons so found by inquisition. These are

visited by the Chancery Visitors. There are three Chancery Visitors, two medical and one legal (a barrister of at least five years' standing at the date of his appointment), who are appointed and removable by the Lord Chancellor. The Chancery Visitors (together with the Master in Lunacy) form a Board, and have offices in the Royal Courts of Justice. In addition to these two classes of visitors, every asylum has a Visiting Committee of not less than seven members, appointed by the local authority; and the justices of every county and quarter-sessions borough not within the immediate jurisdiction of the Commissioners in Lunacy annually appoint three or more of their number as visitors of licensed houses.

Provision is made for the discharge of lunatics from asylums, &c., on recovery, or by *habeas corpus*, or by the various visiting authorities. Any person who considers himself to have been unjustly detained is entitled on discharge to obtain, free of expense, from the secretary to the Lunacy Commissioners a copy of the documents under which he was confined.

The Irish [Lunacy Acts 1821-1890; Lunacy (Ireland) Act 1901] and Scottish [Lunacy Acts 1857 (20 & 21 Vict. c. 71), 1887 (50 & 51 Vict. c. 30)] asylum systems present no feature sufficiently different from the English to require separate notice, except that in Scotland "boarding out" is a regular, and not merely an incidental, part of asylum administration. The "boarding out" principle has, however, received its most extended and most successful application in the Gheel colony in Belgium. The patients, after a few days' preliminary observation, are placed in families, and, except that they are under ultimate control by a superior commission, composed of the governor of the province, the Procureur du Roi and others, enjoy complete liberty indoors as well as out of doors. The patients are visited by nurses from the infirmary, to which they may be sent if they become seriously ill or unmanageable. They are encouraged to work. The accommodation provided for them is prescribed, and is to be of the same quality as that of the household in which they live. Clothing is provided by the administration.

In the French (see laws of 30th June 1838 and 18th December 1839) and German (see *Journal of Comparative Legislation*, n.s. vol. i. at pp. 271, 272) asylum systems the main features of English administration are also reproduced.

The lunacy laws of the British colonies have also closely followed English legislation (cf. Ontario, R.S. 1897, cc. 317, 318; Manitoba, R.S. 1902, c. 80; Victoria (No. 1113, 1890); New Zealand (No. 34 of 1882 and Amending Acts); Mauritius (No. 37 of 1858).

In America the different states of the Union have each their own lunacy legislation. The national government provides only for the insane of the army and navy, and for those residing in the District of Columbia and in Alaska. The various laws as to the reception, &c., of the insane into asylums closely resemble English procedure. But in several states the verdict of a jury finding lunacy is a necessary preliminary to the commitment of private patients (Kentucky, Act of 1883, c. 900, § 14; Maryland, R.S. 1878, c. 53, § 21; Illinois, R.S. 1874, c. 85, § 22).

**AUTHORITIES.**—The following works may be consulted: Collinson on the *Law of Lunatics and Idiots* (2 vols., London, 1812); Shelford on the *Law of Lunatics and Idiots* (London, 1847). On all points relating to the history and development of the law these two treatises are invaluable. Pope on *Lunacy* (2nd ed., London, 1890); Archbold's *Lunacy* (4th ed., London, 1895); Elmer on *Lunacy* (7th ed., London, 1892); Wood Renton on *Lunacy* (London and Edinburgh, 1896); Fry's *Lunacy Laws* (3rd ed., London, 1890); Pitt-Lewis, Smith and Hawke, *The Insane and the Law* (London, 1895); Hack-Tuke, *Dictionary of Psychological Medicine* (London, 1892), and the bibliographies attached to the various legal articles in that work; Clevenger, *Medical Jurisprudence of Insanity* (2 vols., New York, 1899); Semelaigne, *Les Aliénés français* (Paris 1849); Bertrand, *Loi sur les aliénés* (Paris, 1872), presents a comparative view of English and foreign legislations. In forensic medicine the works of Taylor, *Medical Jurisprudence* (5th ed., London, 1905); Dixon Mann, *Foreign Medicine and Toxicology* (3rd ed., London, 1902); and Wharton and Stillé, *A Treatise on Medical Jurisprudence* (Philadelphia, 1873); Hamilton and Godkin, *System of Legal Medicine* (New York, 1895); are probably the English authorities in most common use. See also Casper and Liman, *Praktisches Handbuch*

*der gerichtlichen Medicin* (Berlin, 6th ed., 1876); Tardieu, *Étude médico-légale sur la folie* (Paris, 1827); Legrand du Saulle, *La Folie devant les tribunaux* (Paris, 1864); Dubrac, *Traité de jurisprudence médicale* (Paris, 1894); Tourdes, *Traité de médecine légale* (Paris, 1897); and especially Kraft-Ebing, *Lehrbuch der gerichtlichen Psychopathologie* (Stuttgart, 1899). (A. W. R.)

### III. HOSPITAL TREATMENT

The era of real hospitals for the insane began in the 19th century. There had been established here and there in different parts of the world, it is true, certain asylums or places of restraint before the beginning of the 19th century. We find mention in history of such a place established by monks at Jerusalem in the latter part of the 5th century. There is evidence that even earlier than this in Egypt and Greece the insane were treated as individuals suffering from disease. Egyptian priests employed not only music and the beautiful in nature and art as remedial agents in insanity, but recreation and occupation as well. A Greek physician protested against mechanical restraint in the care of the insane, and advocated kindly treatment, the use of music, and of some sorts of manual labour. But these ancient beneficent teachings were lost sight of during succeeding centuries. The prevailing idea of the pathology of insanity in Europe during the middle ages was that of demoniacal possession. The insane were not sick, but possessed of devils, and these devils were only to be exorcised by moral or spiritual agencies. Medieval therapeutics in insanity adapted itself to the etiology indicated. Torture and the cruellest forms of punishment were employed. The insane were regarded with abhorrence, and were frequently cast into chains and dungeons. Milder forms of mental disease were treated by other spiritual means—such as pilgrimages to the shrines of certain saints who were reputed to have particular skill and success in the exorcism of evil spirits. The shrine of St Dymphna at Gheel, in Belgium, was one of these, and seems to have originated in the 7th century, a shrine so famed that lunatics from all over Europe were brought thither for miraculous healing. The little town became a resort for hundreds of insane persons, and as long ago as the 17th century acquired the reputation, which still exists to this day, of a unique colony for the insane. At the present time the village of Gheel and its adjacent farming hamlets (with a population of some 13,000 souls) provides homes, board and care for nearly 2000 insane persons under medical and government supervision. Numerous other shrines and holy wells in various parts of Europe were resorted to by the mentally afflicted—such as Glen-na-Galt in Ireland, the well of St Winifred, St Nun's Pool, St Fillans, &c. At St Nun's the treatment consisted of plunging the patient backwards into the water and dragging him to and fro until mental excitement abated. Not only throughout the middle ages, but far down into the 17th century, demonology and witchcraft were regarded as the chief causes of insanity. And the insane were frequently tortured, scourged, and even burned to death.

Until as late as the middle of the 18th century, mildly insane persons were cared for at shrines, or wandered homeless about the country. Such as were deemed a menace to the community were sent to ordinary prisons or chained in dungeons. Thus large numbers of lunatics accumulated in the prisons, and slowly there grew up a sort of distinction between them and criminals, which at length resulted in a separation of the two classes. In time many of the insane were sent to cloisters and monasteries, especially after these began to be abandoned by their former occupants. Thus "Bedlam" (Bethlehem Royal Hospital) was originally founded in 1247 as a priory for the brethren and sisters of the Order of the Star of Bethlehem. It is not known exactly when lunatics were first received into Bedlam, but some were there in 1403. Bedlam was rebuilt as an asylum for the insane in 1676. In 1815 a committee of the House of Commons, upon investigation, found it in a disgraceful condition, the medical treatment being of the most antiquated sort, and actual inhumanity practised upon the patients. Similarly the Charenton Asylum, just outside Paris, near the park of Vincennes, was an old monastery which had been given over to the insane. Numerous



like instances could be cited, but the interesting point to be borne in mind is, that with a general tendency to improvement in the condition of imbeciles upon public charge, idiots and insane persons came gradually to be separated from criminals and other paupers, and to be segregated. The process of segregation was, however, very slow. Even after it had been accomplished in the larger centres of civilization, the condition of these unfortunates in provincial districts remained the same. Furthermore, the transfer to asylums provided especially for them was not followed by any immediate improvement in the patients.

Twenty-five years after Pinel had, in 1792, struck the chains from the lunatics huddled in the Salpêtrière and Bicêtre of Paris, and called upon the world to realize the horrible injustice done to this wretched and suffering class of humanity, a pupil of Pinel, Esquirol, wrote of the insane in France and all Europe: "These unfortunate people are treated worse than criminals, reduced to a condition worse than that of animals. I have seen them naked, covered with rags, and having only straw to protect them against the cold moisture and the hard stones they lie upon; deprived of air, of water to quench thirst, and all the necessaries of life; given up to mere gaolers and left to their surveillance. I have seen them in their narrow and filthy cells, without light and air, fastened with chains in these dens in which one would not keep wild beasts. This I have seen in France, and *the insane are everywhere in Europe treated in the same way.*" It was not until 1838 that the insane in France were all transferred from small houses of detention, workhouses and prisons to asylums specially constructed for this purpose.

In Belgium, in the middle ages, the public executioner was ordered to expel from the towns, by flogging, the poor lunatics who were wandering about the streets. In 1804 the Code Napoleon "punished those who allowed the insane and mad criminals to run about free." In 1841 an investigation showed in Belgium thirty-seven establishments for the insane, only six of which were in good order. In fourteen of them chains and irons were still being used. In Germany, England and America, in 1841, the condition of the insane was practically the same as in Belgium and France.

These facts show that no great advance in the humane and scientific care of the insane was made till towards the middle of the 19th century. Only then did the actual metamorphosis of asylums for detention into hospitals for treatment begin to take place. Hand in hand with this progress there has grown, and still is growing, a tendency to subdivision and specialization of hospitals for this purpose. There are now hospitals for the acutely insane, others for the chronic insane, asylums for the criminal insane, institutions for the feeble-minded and idiots, and colonies for epileptics. There are public institutions for the poor, and well-appointed private retreats and homes for the rich. All these are presided over by the best of medical authorities, supervised by unsalaried boards of trustees or managers, and carefully inspected by Government lunacy commissioners, or boards of charities—a contrast, indeed, to the goals, shrines, holy wells, chains, tortures, monkish exorcisms, &c., of the past!

The statistics of insanity have been fairly well established. The ratio of insane to normal population is about 1 to 300 among civilized peoples. This proportion varies within narrow limits in different races and countries. It is probable that intemperance in the use of alcohol and drugs, the spread of venereal diseases, and the over-stimulation in many directions induced by modern social conditions, have caused an increase of insanity in the 19th as compared with past centuries. The amount of such increase is probably very small, but on superficial examination might seem to be large, owing to the accumulation of the chronic insane and the constant upbuilding of asylums in new communities. The imperfections of census-taking in the past must also be taken into account.

The modern hospital for the insane does credit to latter-day civilization. Physical restraint is no longer practised. The day of chains—even of wristlets, covered cribs and strait-jackets—is past. Neat dormitories, cosy single rooms, and sitting- and

dining-rooms please the eye. In the place of bare walls and floors and curtainless windows, are pictures, plants, rugs, birds, curtains, and in many asylums even the barred windows have been abolished. Some of the wards for milder patients have unlocked doors. Many patients are trusted alone about the grounds and on visits to neighbouring towns. An air of busy occupation is observed in sewing-rooms, schools, shops, in the fields and gardens, employment contributing not only to economy in administration, but to improvement in mental and physical conditions. The general progress of medical science in all directions has been manifested in the department of psychiatry by improved methods of treatment, in the way of sleep-producing and alleviating drugs, dietetics, physical culture, hydrotherapy and the like. There are few asylums now without pathological and clinical laboratories. While it is a far cry from the prisons and monasteries of the past to the modern hospital for the insane, it is still possible to trace a resemblance in many of our older asylums to their ancient prototypes, particularly in those asylums built upon the so-called corridor plan. Though each generation contributed something new, antecedent models were more or less adhered to. Progress in asylum architecture has hence advanced more slowly in countries where monasteries and cloisters abounded than in countries where fixed models did not exist. Architects have had a freer hand in America, Australia and Germany, and even in Great Britain, than in the Catholic countries of Europe.

Germany approaches nearest to an ideal standard of provision for the insane. The highest and best idea which has yet been attained is that of small hospitals for the acutely insane in all cities of more than 50,000 inhabitants, and of colonies for the chronic insane in the rural districts adjacent to centres of population. The psychopathic hospital in the city gives easy and speedy access to persons taken suddenly ill with mental disease, aids in early diagnosis, places the patients within reach of the best specialists in all departments of medicine, and associated, as it should be, with a medical school or university, affords facilities not otherwise available for scientific research and for instruction in an important branch of medical learning. A feature of the psychopathic hospital should be the reception of patients for a reasonable period of time, as sufferers from disease, without the formality of legal commitment papers. Such papers are naturally required for the detention and restraint of the insane for long periods of time, but in the earlier stages they should be spared the stigma, delay and complicated procedure of commitment for at least ten days or two weeks, since in that time many may convalesce or recover, and in this way escape the public record of their infirmities, unavoidable by present judicial procedures.

There should be associated with such hospitals for the acutely insane in cities out-door departments or dispensaries, to which patients may be brought in still earlier stages of mental disorder, at a period when early diagnosis and preventive therapeutics may have their best opportunities to attain good results. In Germany a psychopathic hospital now exists in every university town, under the name of *Psychiatrische Klinik*.

Colonies for the chronic insane are established in the country, but in the neighbourhood of the cities having psychopathic hospitals, to receive the overflow of the latter when the acute stage has passed. The true colony is constructed on the principle of a farming hamlet, without barracks, corrugated buildings, or pavilions. It is similar in most respects to any agricultural community. The question here is one of humane care and economical administration. Humane care includes medical supervision, agreeable home-life, recreation, and, above all things, regular manual and out-of-door occupation in garden, farm and dairy, in the quarry, clay-pit or well-ventilated shop. Employment for the patients is of immense remedial importance, and of great value from the standpoint of economical administration. In the colony system the small cottage homes of the patients are grouped about the centres of industry. The workers in the farmstead live in small families about the farmstead group of buildings; the tillers of the soil adjacent to the fields,

meadows and gardens; the brickmakers, quarrymen and artisans in still other cottages in the neighbourhood of the scenes of their activities. In addition to these groups of cottages, which constitute the majority of the buildings in the village, an infirmary for bedridden, excited and crippled patients is required, and a small hospital for the sick. All the inhabitants of the colony are under medical supervision. A laboratory for scientific researches forms a highly important part of the equipment. The colony is not looked upon as a refuge for the incurable; it is still a hospital for the sick, where treatment is carried on under the most humane and most suitable conditions, and wherein the percentage of recoveries will be larger than in asylums and hospitals as now conducted. In respect of the establishment of colonies for the insane upon the plan outlined here, Germany has, as in the case of the psychopathic hospital, led the world. It has been less difficult for that country to set the example, because she had fewer of the conditions of the past to fight, and with her the progress of medical science and of methods of instruction in all departments of medicine has been more pronounced and rapid.

Among the German colonies for the insane, that at Alt-Scherbitz, near Leipzig, is the oldest and most successful, and is pre-eminent in its close approach to the ideal village or colony system. In 1899 Professor Kraepelin of Heidelberg stated (*Psychiatrie*, 6th edition) that the effort was made everywhere in Germany to give the exterior of asylums, by segregation of the patients in separate home-like villas, rather the appearance of hamlets for working-people than prisons for the insane, and he said, further, that the whole question of the care of the insane had found solution in the colony system, the best and cheapest method of support. "I have myself," he writes, "had opportunity to see patients, who had lived for years in a large closed asylum, improve in the most extraordinary manner under the influence of the freer movement and more independent occupation of colony life."

In America the colony scheme has been successfully adopted by the state of New York at the Craig Colony for Epileptics at Sonycia and elsewhere.

That the tendency nowadays, even outside of Germany, in the direction of the ideal standard of provision for the insane is a growing one is manifested in all countries by a gradual disintegration of the former huge cloister-like abodes. More asylums are built on the pavilion plan. Many asylums have, as it were, thrown off detached cottages for the better care of certain patients. Some asylums have even established small agricultural colonies a few miles away from the parent plant, like a vine throwing out feelers. What is called the boarding-out system is an effort in a similar direction. Patients suffering from mild forms of insanity are boarded out in families in the country, either upon public or private charge. Ghel is an example of the boarding-out system practised on a large scale. But the ideal system is that of the psychopathic hospital and the colony for the insane.

AUTHORITIES.—Sir J. B. Tuke, *Dictionary of Psychological Medicine* (London and Philadelphia, 1892); W. P. Leitchworth, *The Insane in Foreign Countries* (New York, 1889); *Care and Treatment of Epileptics* (New York, 1900); F. Peterson, *Mental Diseases* (Philadelphia, 1899); "Annual Address to the American Medico-Psychological Association," *Proceedings* (1899). (F. P.)\*

**INSCRIPTIONS** (from Lat. *inscribere*, to write upon), the general term for writings cut on stone or metal, the subject matter of epigraphy. See generally **WRITING** and **PALEOGRAPHY**. Under this heading it is convenient here to deal more specifically with four groups of ancient inscriptions, Semitic, Indian, Greek and Latin, but further information will be found in numerous separate articles on philological subjects. See especially **CUNEIFORM**, **BABYLONIA** AND **ASSYRIA**, **SUMER**, **BEHISTUN**, **EGYPT** (*Language and Writing*), **ETHIOPIA**, **PHOENICIA**, **ARABIA**, **HITTITES**, **SABAEANS**, **MINEAENS**, **ETRURIA**, **AEGEAN CIVILIZATION**, **CRETE**, **CYPRUS**, **BRITAIN**, **SCANDINAVIAN LANGUAGES**, **TEUTONIC LANGUAGES**, **CENTRAL AMERICA**: *Archaeology*, &c.

## I. SEMITIC INSCRIPTIONS

Excluding cuneiform (*q.v.*), the inscriptions known as Semitic are usually classed under two main heads as North and South Semitic. The former class includes Hebrew (with Moabite), Phoenician (with Punic and neo-Punic), and Aramaic (with Nabataean and Palmyrene). The South Semitic class includes the Minaean and Sabaeen inscriptions of South Arabia. In most of these departments there has been a very large increase of material during recent years, some of which is of the highest historical and palaeographical importance. The North Semitic monuments have received the greater share of attention because of their more general interest in connexion with the history of surrounding countries.

1. *North Semitic*.—The earliest authority for any North Semitic language is that of the Tel-el-Amarna tablets (15th century B.C.) which contain certain "Canaanite glosses,"<sup>1</sup> i.e. North Semitic words written in cuneiform characters. From these to the first inscription found in the North Semitic alphabet, there is an interval of about six centuries. The stele of Mesha, commonly called the Moabite Stone, was set up in the 9th century B.C. to commemorate the success of Moab in shaking off the Israelitish rule. It is of great value, both historically as relating to events indicated in 2 Kings i. 1, iii. 5, &c., and linguistically as exhibiting a language almost identical with Hebrew—that is to say, another form of the same Canaanitish language. It was discovered in 1868 by the German missionary, Klein, on the site of Dibon, intact, but was afterwards broken up by the Arabs. The fragments,<sup>2</sup> collected with great difficulty by Clermont-Ganneau and others, are now in the Louvre. Its genuineness was contested by A. Löwy (*Scottish Review*, 1887; republished, Berlin, 1903) and recently again by G. Jahn (appendix to *Das Buch Daniel*, Leipzig, 1904), but, although there are many difficulties connected with the text, its authenticity is generally admitted.

Early Hebrew inscriptions are at present few and meagre, although it cannot be doubted that others would be found by excavating suitable sites. The most important is that discovered in 1880 in the tunnel of the pool of Siloam, commemorating the piercing of the rock. It is generally believed to refer to Hezekiah's scheme for supplying Jerusalem with water (2 Kings xx. 20), and therefore to date from about 700 B.C. It consists of six lines in good Hebrew, and is the only early Hebrew inscription of any length. The character does not differ from that of the Moabite Stone, except in the slightly cursive tendency of its curved strokes, due no doubt to their having been traced for the stone-cutter by a scribe who was used to writing on parchment. There are also a few inscribed seals dating from before the Exile, some factory marks and an engraved capital at al-Amwās, which last may, however, be Samaritan. Otherwise this character is only found (as the result of an archaizing tendency) on coins of the Hasmoneans, and, still later, on those of the first and second (Bar Kokhba's) revolts.

The new Hebrew character, which developed into the modern square character, is first found in a name of five letters at 'Arāq-al-amir, of the 2nd century B.C. Somewhat later, but probably of the 1st century B.C., is the tombstone of the B'nē Hezān ("Tomb of St James") at Jerusalem. An inscription on a ruined synagogue at Kafr Bir'im, near Safed, perhaps of about A.D. 300, or earlier, shows the fully developed square character.

Since the publication of the *Corpus Inscr. Sem.* it has been customary to treat papyri along with inscriptions, and for palaeographical reasons it is convenient to do so. Hebrew papyri are few, all in square character and not of great interest. The longest, and probably the earliest (6th century A.D.), is one now in the Bodleian Library at Oxford, containing a private

<sup>1</sup> See Winkler in Schrader's *Keilschr. Bibl.* v. (Berlin, &c., 1896).

<sup>2</sup> A nearly complete text has been made from these with the help of a squeeze taken before its destruction. See the handbooks mentioned below.

letter<sup>1</sup> written in a character closely resembling that of the *Kafr Bir'im* inscription. Other fragments were published by *Steinschneider*<sup>2</sup> (perhaps 8th century), and by *D. H. Müller* and *Kaufmann*.<sup>3</sup>

Hebrew inscriptions outside Palestine are the cursive graffiti in the catacombs at *Venosa* (2nd–5th century), the magical texts on Babylonian bowls (7th–8th century), and the numerous tombstones<sup>4</sup> in various parts of Europe, of all periods from the 6th century to the present time.

The few Samaritan inscriptions in existence are neither early nor interesting.

Closely related to the Hebrews, both politically and in language, were the Phoenicians in North Syria. Their monuments in Phoenicia itself are few and not earlier than the Persian period. The oldest yet found, dating probably from the 5th or 4th century B.C., is that of *Yehaw-milk*, king of *Gebal* (modern *Jebel*) or *Byblus*, where it was found. It records at some length the dedication of buildings, &c., to the goddess of *Gebal*. Of the 3rd century B.C. are the inscriptions on the sarcophagi of *Tabnith* and his son *Eshmun'azar*, kings of *Sidon*, and some records of other members of the same family, *Bod-ashtar* and his son *Yathan-milk*, found in 1902 a short distance north of *Sidon*.

Outside Phoenicia the inscriptions are numerous and widely scattered round the Mediterranean coasts, following the course of Phoenician trade. The earliest is that on some fragments of three bronze bowls, dedicated to *Baal of Lebanon*, found in *Cyprus*. The character is like that of the *Moabite Stone*, and the date is probably the 8th century B.C., though some scholars would put it nearer to 1000 B.C. In the latter case, the *Hiram*, king of *Sidon*, mentioned in the inscriptions would be the same as *Hiram*, king of *Tyre*, in *Solomon's* time. Similar bowls (of about 700 B.C.) found at *Nimrud* sometimes bear the maker's name in Phoenician characters.

Many monumental inscriptions have also been found in *Cyprus*, at *Kition*, *Idalion*, *Tamassos*, &c. They are chiefly votive, some dated in the 4th century, and some being perhaps as late as the 2nd century B.C., so that they afford valuable evidence as to the succession of the local kings. Several also are bilingual, and it was one of these which supplied *George Smith* with the clue to the *Cypriote* syllabic system of writing Greek. Similar memorials of Phoenician settlements were found at *Athens* (*Piræus*), in *Egypt*, *Sardinia*, *Malta* and *Gozo*. Most interesting of all is the celebrated sacrificial tablet of *Marseilles*, giving an elaborate tariff of payments at or for the various offerings, and showing some striking analogies with the directions in the book of *Leviticus*. For the information it gives as to civil and priestly organization, it is the most important Phoenician text in existence. It was probably brought from *Carthage*, where similar tariffs have been found. On the site of that important colony, and indeed throughout the parts of North Africa once subject to its rule, Punic inscriptions are, as might be expected, very numerous. By far the majority are votive tablets, probably belonging to the period between the 4th and the 2nd centuries B.C., many of them in a wonderfully perfect state of preservation. One of the most interesting, recently discovered, mentions a high-priest who was head of the college of priests, and whose husband's family had been *suffetes* for four generations. Later inscriptions, called neo-Punic, dating from the fall of *Carthage* to about the 1st century A.D., are written in a debased character and language differing in several respects from the earlier Punic, and presenting many difficulties.

In *Aramaic* the earliest inscriptions are three found in 1800–1801 at and near *Zinjirli* in North-west Syria, dating from the 8th century B.C. Of these, one was set up by *Panammû*, king of *Ya'dli*, in honour of the god *Hadad*, and is inscribed on a

statue of him, the other two were set up by *Bar-rekub*, son of *Panammû*, one in honour of his father and on his statue, the second commemorating the erection of his new house. They are remarkable as being engraved in relief, a peculiarity which has been thought to be due to "Hittite" influence. Otherwise the character resembles that of the *Moabite Stone*. The texts consist of 77 lines (not all legible), giving a good deal of information about an obscure place and period hitherto known only from cuneiform sources. The ornamentation is Assyrian in style, as also is that of the inscriptions of *Nerab* (near *Aleppo*), commemorative texts engraved on statues of priests, of about the 7th century.

Of shorter inscriptions there is a long series from about the 8th century B.C., on bronze weights found at *Nineveh* (generally accompanied by an Assyrian version), and as "dockets"<sup>5</sup> to cuneiform contract-tablets, giving a brief indication of the contents. *Aramaic*, being the commercial language of the East, was naturally used for this purpose in business documents. For the same reason it is found in the 6th–4th centuries B.C. sporadically in various regions, as in *Cilicia*, in *Lycia*<sup>6</sup> (with a Greek version), at *Abydos* (on a weight). At *Taimâ*, also, in North Arabia, an important trading centre, besides shorter texts, a very interesting inscription of twenty-three lines was found, recording the foundation and endowment of a new temple, probably in the 5th century B.C. But by far the most extensive collection of early *Aramaic* texts comes from *Egypt*, where the language was used not only for trade purposes, as elsewhere, but also officially under the Persian rule. From *Memphis* there is a funeral inscription dated in the fourth year of *Xerxes* (482 B.C.), and a dedication on a bowl of about the same date. A stele recently published by *de Vogüé*<sup>7</sup> is dated 458 B.C. Another which is now at *Carpentras* in France (place of origin unknown) is probably not much later. At *Elephantine* and *Assuân* in Upper *Egypt*, a number of ostraka have been dug up, dating from the 5th century B.C. and onward, all difficult to read and explain, but interesting for the popular character of their contents, style and writing. There was a Jewish (or Israelitish<sup>8</sup>) settlement there in the 5th century (from which emanated most, if not all, of the papyrus documents edited in the *C.I.S.*). Since the appearance of this part of the *Corpus*, more papyri have come to light. One published by *Euting*<sup>9</sup> is dated 411 B.C. and is of historical interest, eleven others,<sup>10</sup> containing legal documents, mostly dated, were written between 471 and 411 B.C.; another (408 B.C.) is a petition to the governor of *Jerusalem*.<sup>11</sup> The fragments in the *C.I.S.* are in the same character and clearly belong to the same period. The language continued to be used in *Egypt* even in Ptolemaic times, as shown by a papyrus<sup>12</sup> (accounts) and ostrakon<sup>13</sup> containing Greek names, and belonging to judge from the style of the writing, to the 3rd century B.C. The latest fragments<sup>14</sup> are of the 6th–8th century A.D., written in a fully developed square character. They are Jewish private letters, and do not prove anything as to the use of *Aramaic* in *Egypt* at that time.

*Nabataean* inscriptions are very numerous. They are written in a peculiar, somewhat cursive character, derived from the square, and date from the 2nd century B.C. The earliest dated is of the year 40 B.C., the latest dated is of A.D. 95. The *Nabataean* kingdom proper had its centre at *Petra* (= *Sela* in 2 Kings xiv. 7), which attained great importance as the emporium on the trade route between *Arabia* and the *Persian Gulf* on the

<sup>5</sup> These have been collected by *J. H. Stevenson*, *Babyl. and Assyri. Contracts* (New York, 1902). A more complete collection has been prepared by Professor *A. T. Clay*.

<sup>6</sup> For the literature see *Kalinka*, *Tituli Lyciae*, No. 152 (Vienna, 1901).

<sup>7</sup> *Répertoire d'épigr. sémi.*, No. 438.

<sup>8</sup> So *Bacher* in *J. Q. R.* xix. 441.

<sup>9</sup> In *Mém. Acad. inscr.* 1<sup>re</sup> sér. xi. 297. See also *Rép. d'épigr. sémi.*, for some smaller fragments, Nos. 244–248.

<sup>10</sup> *Sayce* and *Cowley*, *Aramaic Papyri* (London, 1906).

<sup>11</sup> *Sachau*, "Drei aram. Papyrusurkunden" *Abh. d. kgl. Preuss. Akad.* (Berlin, 1907).

<sup>12</sup> See *P.-S.-A.* (1907), p. 260.

<sup>13</sup> See *Lidzbarski*, *Ephemeris*, ii. 247.

<sup>14</sup> *J. Q. R.* xvi. 7.

<sup>1</sup> Published with other fragments in the *Jeto. Quart. Review*, xvi. 1.

<sup>2</sup> *Zeitsch. f. Aegypt. Spr.* (1879). These were the first specimens found. See also *Erman* and *Krebs*, *Aus den Papyrus d. kgl. Mus.* p. 290 (Berlin, 1899).

<sup>3</sup> *Mittheilungen . . . Rainer*, i. 38 (Wien, 1886).

<sup>4</sup> Those in France were collected by *Schwab* in *Nouvelles archives*, xii. 3. See also *Chwolson*, *Corpus Inscr. Hebr.* (St Petersburg, 1882).

one side and Syria and Egypt on the other. The commercial activity of the people, however, was widely extended, and their monuments are found not only round Petra and in N. Arabia, but as far north as Damascus, and even in Italy, where there was a trading settlement at Puteoli. The inscriptions are mostly votive or sepulchral, and are often dated, but give little historical information except in so far as they fix the dates of Nabataean kings.

A distinct subdivision of Nabataean is found in the Sinaitic peninsula, chiefly in the Wādī Firān and Wādī Mukattib, which lay on the caravan route. The inscriptions are rudely scratched or punched on the rough rock, without any sort of order, and some of them are accompanied by rude drawings. A few only are dated, but, as shown by de Vogüé in the *C.I.S.* (ii. 1, p. 353), they must all belong to the 2nd and 3rd centuries A.D. This accounts for the fact that already in the 6th century Cosmas Indicopleustes<sup>1</sup> has no correct account of their origin, and ascribes them to the Israelites during their wanderings in the wilderness.<sup>2</sup> They were first correctly deciphered as Nabataean by Beer in 1848, when they proved to consist chiefly of proper names (many of them of Arabic formation), accompanied by ejaculations or blessings. It is clear that they are not the work of pilgrims either Jewish or Christian,<sup>3</sup> nor are they of a religious character. The frequent recurrence of certain names shows that only a few generations of a few families are represented, and these must have belonged to a small body of Nabataeans temporarily settled in the particular Wādīs, no doubt for purposes connected with the caravan-traffic. The form of the Nabataean character in which they are written is interesting as being the probable progenitor of the Kufic Arabic alphabet.

Another important trading centre was Tadmor or Palmyra in northern Syria. Numerous inscriptions found there, and hence called Palmyrene, were copied by Waddington in 1861 and published by de Vogüé in his great work *Syrie Centrale* (1868, &c.), which is still the most extensive collection of them. The difficulties of exploration have hitherto prevented any further increase of the material, but much more would undoubtedly be found if excavation were possible. The texts are mostly sepulchral and dedicatory, some of them being accompanied by a Greek version. The language is a form of western Aramaic, and the character, which is derived from the Hebrew and Aramaic square, is closely related to the Syriac estrangelo alphabet. The inscriptions are mostly dated, and belong to the period between 0 B.C. and A.D. 271. The most important is the tariff of taxes on imports, dated A.D. 137. Nearly all were found on the surface at or round Palmyra and remain *in situ*. Of the very few in other places, one (with a Latin version) was found at South Shields, the tombstone of *Regina liberta et conjux* of a native of Palmyra.

Syriac inscriptions are few. The earliest is that on the sarcophagus of Queen Šaddan (in the Hebrew version, Šadda), perhaps of about A.D. 40, found at Jerusalem. Others were found by Sachau<sup>4</sup> at Edessa, of the 2nd and 3rd centuries, and by Pognon.<sup>5</sup>

2. *South Semitic.*—The South Semitic class of inscriptions comprises the Minaean, Sabaeans, Himyaritic and Lihyanitic in South Arabia, the Thamudic and Safaitic in the north and the Abyssinian. A great deal of material has been collected by Halévy, Glaser and Euting, and much valuable work has been done by them and by D. H. Müller, Hommel and Littmann. Many of the texts, however, are still unpublished and the rest is not very accessible (except so far as it has appeared in the *C.I.S.*), so that South Semitic has been less widely studied than North Semitic.

The successive kingdoms of South Arabia (Yemen) were essentially commercial. Their country was the natural intermediary

between Asia (India), Africa and Syria, and this position, combined with its natural fertility, made the south far more prosperous than the north. In language, the two most important peoples, the Minaeans and Sabaeans, differ only dialectically, both writing forms of southern Arabic. The Minaean capital was at Ma'in, about 300 m. N. of Aden and 200 m. from the west coast. Here and in the neighbourhood numerous inscriptions were found, as well as in the north at al-'Ōla.<sup>6</sup> Their chronology is much disputed. D. H. Müller makes the Minaean power contemporary with the Sabaeans, but Glaser (with whom Hommel and D. S. Margolouth agree) contends that the Sabaeans followed the Minaeans, whom they conquered in 820 B.C. Mention is made in a cuneiform text (Annals of Sargon, 715 B.C.) of Ithamar the Sabaeans, who must be identical with one (it is not certain which) of the kings of that name mentioned in the Sabaeans inscriptions. Their capital was Marib, a little south of Ma'in, and here they appear to have flourished for about a thousand years. In the 1st century A.D., with the establishment of the Roman power in the north, their trade, and consequently their prosperity, began to decline. The rival kingdom of the Himyarites, with its capital at Zafar, then rose to importance, and this in turn was conquered by the Abyssinians in the 6th century A.D. With the spread of Islām the old Arabic language was supplanted by the northern dialects from which classical Arabic was developed. A peculiarity of the South Arabian inscriptions is that many of them are engraved on bronze tablets. Besides being historically important, they are of great value for the study of early Semitic religion. The gods most often named in Sabaeans are 'Ahtār Wadd and Nakrah, the first being the male counterpart of the Syrian Ashtorah. The term denoting the priests and priestesses who are devoted to the temple-service is identified by Hommel and others with the Hebrew "Levite."

Closely connected with South Arabia is Abyssinia. Indeed a considerable number of Sabaeans inscriptions have been found at Yeha and Aksum, showing that merchants from Arabia must at some time have formed settlements there. D. H. Müller<sup>7</sup> thinks that some of these belong to the earliest and others to the latest period of Sabaeans power. The inscriptions hitherto found in Ethiopic (the alphabet of which is derived from the Sabaeans) date from the 4th century A.D. onward. They are few in number, but long and of great historical importance. There can be no doubt that exploration, if it were possible, would bring many more to light.

From time to time emigrants from the southern tribes settled in the north of Arabia. Mention has already been made of Minaean inscriptions found at al-'Ōla, which is on the great pilgrim road, about 70 m. south of Taimā. In recent years a number of others has been collected belonging to the people of Lihyan and dating from about A.D. 250. Nearly related to the Lihyanitic are the Thamudic (so called from the tribe of the Thamūd mentioned in them), and the Safaitic, both of which, though found in the north, belong in character to south Arabia and no doubt owe their origin to emigrants from the south. The Thamudic inscriptions, collected by Euting (called Proto-Arabian by Halévy),<sup>8</sup> are carelessly scrawled graffiti very like those of the Sinai peninsula. Their date is uncertain, but they cannot be much earlier than the Safaitic, which resemble them in most respects. These last are called after the mountainous district about 20 m. S.E. of Damascus. The inscriptions are, however, found not in Mount Šafā itself but in the desert of al-Jarrah to the west and south and in the fertile plain of ar-Rubbah to the east. They were first deciphered by Halévy,<sup>9</sup> whose work has been carried on and completed by Littmann.<sup>10</sup> Their date is again uncertain, since graffiti of this kind give very few facts from which dates can be deduced. Littmann thinks that one of his inscriptions refers to Trajan's campaign of A.D. 106,

<sup>1</sup> ed. E. O. Winstedt (Camb. 1909), p. 154.

<sup>2</sup> A view revived by C. Forster, even after Beer, in *The Israelitish Authorship of the Sinaitic Inscriptions* (London, 1856) and other works.

<sup>3</sup> The cross and other Christian symbols often found with the inscriptions have been added later by pilgrims.—*C.I.S.* ii. 1, p. 352.

<sup>4</sup> *Reise in Syrien* (Leipzig, 1883).

<sup>5</sup> *Inscriptions sém. de la Syrie, &c.* i. (Paris, 1907).

<sup>6</sup> J. H. Mordtmann, "Beitr. zur Mänaischen Epigraphik," in *Semitische Studien*, 12 (Weimar, 1807).

<sup>7</sup> In *Bent's Sacred City of the Ethiopians* (London, 1893).

<sup>8</sup> *Revue sémitique* (1901).

<sup>9</sup> *Journ. As. x.*, xvii., xix.

<sup>10</sup> *Zur Entzifferung d. Safa-Inschr.* (Leipzig, 1901).

and that they all belong to the first three centuries. They are found together with the earlier Greek and Latin graffiti of Roman soldiers and with later Moslem remarks in Kufic. Many of them are not yet published.

**BIBLIOGRAPHY**—The best introductions are, for North Semitic, Lidzbarski's *Handbuch d. nordsemitischen Epigraphik* (Weimar, 1898); and G. A. Cooke's *Text-book of North-Semitic Inscriptions* (Oxford, 1903); for South Semitic, Hommel's *Süd-arabische Christomathie* (Munich, 1893); Alphabets and facsimiles in Berger, *Histoire de l'écriture*, 2nd ed. (Paris, 1892). The parts of the *Corpus Inscr. Sem.* published up to 1910 are: pars I., tom. I., and tom. II., fasc. 1-3, 1881-1908 (Phoenician); pars II., tom. I., 1889-1902 (Aramaic with Nabataean), tom. II., fasc. I., 1907 (Sinitic); pars IV., tom. I., fasc. 1-4, 1889-1908 (Himyaritic, including Minaean and Sabaean). In all these parts a full bibliography is given. For Palmyrene see de Vogüé's *Syrie Centrale* (Paris, 1868-1877). Works on special departments of the subject have already been mentioned in the notes. (A. Cy.)

## II. INDIAN INSCRIPTIONS

The inscriptions of India are extremely numerous, and are found, on stone and other substances, in a great variety of circumstances. They were mostly recorded by incision.

**Materials on which the inscriptions were recorded.** But we have a few, referable to the 2nd or 3rd century B.C., which were written with ink on earthenware, and some others, of later times, recorded by paint,—one on a rock, the others on the walls of Buddhist cave-temples. Those, however, were exceptional methods; and equally so was the process of casting, with the result of bringing the letters out in relief, of which we know at present only one instance,—the Sôhgaurâ plate, mentioned again below. The Mussulman inscriptions on stone were, it is believed, nearly always carved in relief; and various Hindu inscriptions were done in the same way in the Mussulman period; but only one instance of a stone record prepared in that manner can as yet be cited for the earlier period; it is an inscription on the pedestal of an image of Buddha, of the Gupta period, found in excavations made not long ago at Sârâñh.

Amongst the inscriptions on metal there is one that stands out by itself, in respect of the peculiarity of having been incised on iron: it is the short poem, constituting the epitaph of the Gupta king Chandragupta II., which was composed in or about A.D. 415, and was placed on record on the iron column, measuring 23 ft. 8 in. in height, and estimated to weigh more than six tons, which stands at Meharauli near Delhi. We have a very small number of short Buddhist votive inscriptions on gold and silver, a larger number of records of various kinds on brass, and a larger number still on bronze. The last-mentioned consist chiefly of seals and stamps for making seals. And one of these seal-stamps, belonging to about the commencement of the Christian era, is of particular interest in presenting its legend in Greek characters as well as in the two Indian alphabets which were then in use. For the period, indeed, to which it belongs, there is nothing peculiar in the use of the Greek characters; those characters were freely used on the coins of India and adjacent territories, sometimes along with the native characters, sometimes alone, from about 325 B.C. to the first quarter of the 2nd century A.D.; but this seal-stamp, and the coins of the Kshaharâ king Nahapâna (A.D. 78 to about 125), furnish the only citable good instances of the use of the three alphabets all together. For the most part, however, the known inscriptions on metal were placed on sheets of copper, ranging in size from about 2½ in. by 1½ in. in the case of the Sôhgaurâ plate to as much as about 2 ft. 6 in. square in the case of a record of 46 B.C. obtained at Suê-Vihâr in the neighbourhood of Bahâwâlpur in the Punjab. Some of these records on copper were commemorative and dedicatory, and were deposited inside the erections—relic-mounds, and, in the case of the Suê-Vihâr plate, a tower—to which they belonged. The usual copper record, however, was a donative charter, in fact a title-deed, and passed as soon as it was issued into private personal custody; and many of the known records of this class have come to notice through being produced by the modern possessors of them before official authorities, in the expectation of establishing privileges which (it is hardly necessary to say) have long since

ceased to exist through the lapse of time, the dying out of families of original holders, rights of conquest, and the many changes of government that have taken place: but others have been found buried in fields, and hidden in the walls and foundations of buildings. The plates on which these inscriptions were incised vary greatly in the number of the leaves, in the size and shape of them, and in the arrangement of the records on them; partly, of course, according to the lengths of individual records, but also according to particular customs and fashions prevalent in different parts of the country and in different periods of time. In some cases a single plate was used; and it was inscribed sometimes on only one side of it, sometimes on both. More often, however, more plates than one were used, and were connected together by soldered rings; and the number ranges up to as many as thirty-one in the case of a charter issued by the Chôla king Râjendra Chôla I. in the period A.D. 1011 to 1037. It was customary that such of the records on copper as were donative charters should be authenticated. This was sometimes done by incising on the plates what purports to be more or less an autograph signature of the king or prince from whom a charter emanated. More usually, however, it was effected by attaching a copper or bronze reproduction of the royal seal to the ring or to one of the rings on which the plates were strung; and this practice has given us another large and highly interesting series of Indian seals, some of them of an extremely elaborate nature. In this class of records we have a real curiosity in a charter issued in A.D. 1272 by Râmachandra, one of the Yâdava kings of Dêvâgiri: this record is on three plates, each measuring about 1 ft. 3 in. in width by 1 ft. 8½ in. in height, which are so massive as to weigh 59 lb. 2 oz.; and the weight of the ring on which they were strung, and of an image of Garuḍa which was secured to it by another ring, is 11 lb. 12 oz.; thus, the total weight of this title-deed, which conveyed a village to fifty-seven Brâhmins, is no less than 70 lb. 14 oz.; appreciably more than half a hundredweight.

Amongst substances other than metal we can cite only one instance in which crystal was used; this material was evidently found too hard for any general use in the inscriptional line: the solitary instance is the case of a short record found in the remains of a Buddhist stûpa or relic-mound at Bhaṭṭiprôlu in the Kistna district, Madras. In various parts of India there are found in large numbers small tablets of clay prepared from stamens, sometimes baked into terra-cotta, sometimes left to harden naturally. Objects of this class were largely used as votive tablets, especially by the Buddhists; and their tablets usually present the so-called Buddhist formula or creed: "Of those conditions which spring from a cause, Tathâgata (Buddha) has declared the cause and the suppression of them; it is of such matters that he, the great ascetic, discourses"; but others, from Sunet in the Ludhiâna district, Punjab, show by the legends on them that the Śaivas and Vaishnavas also habitually made pious offerings of this kind on occasions of visiting sacred places. Recent explorations, however, in the Gorâkhpûr and Muzaffarpûr districts have resulted in the discovery, in this class of records, of great numbers of clay seals bearing various inscriptions, which had been attached to documents sent to and fro between administrative offices, both royal and municipal, between religious establishments, and between private individuals; and amongst these we have seals of the monastery at Kusinârâ, one of the places at which the eight original portions of the corporeal relics of Buddha were enshrined in relic-mounds, and also a seal-stamp used for making seals of the monastery at Vethadpâ, another of those places. And from Kâthiawâr we have a similar seal-stamp which describes itself as the property "of the prince and commander-in-chief Pushyêna, son of the illustrious prince Ahivarmn, whose royal pedigree extends back unbroken to Jayadratha." There are no indications that the use of brick for inscriptional purposes was ever at all general in India, as it was in some other eastern lands; but there have been found in the Ghâzipur district numerous bricks bearing the inscription "the glorious Kumârâgupta," with reference to either the first or the second Gupta king of that name, of the 5th century A.D.; in the Gorâkhpûr district there have been found

brick tablets bearing Buddhist texts, one of which is a version in Sanskrit of a short sermon preached by Buddha; and from the Jaunpūr district we have a brick tablet bearing an inscription which registers a mortgage, made in A.D. 1217, of some lands as security for a loan. Inscribed earthenware relic-receptacles have been found in the Bhōpāl state: donative earthenware jars, bearing inscriptions, have been obtained near Chārsadda in the North-West Frontier province; and from Kāthiāwār we have a piece of earthenware, apparently a fragment of a huge pot, bearing an inscription which presents a date in A.D. 566-67 and the name of "the glorious Guhasēna," one of the Maitraka princes of Valabhi. For the great bulk of the inscriptions, however, stone was used: but limitation of space prevents us from entering into any details here, and only permits us to say that in this class the records are found all over India on rocks, on isolated monolith columns and pillars, of which some were erected simply to bear the records that were published on them, others were placed in front of temples as flagstaffs of the gods, and others were set up as pillars of victory in battle; on relic-receptacles hidden away in the interiors of Buddhist stūpas; on external structural parts of stūpas; on façades, walls, and other parts of caves; on pedestals and other parts of images and statues, sometimes of colossal size; on moulds for making seals; on walls, beams, pillars, pilasters, and other parts of temples; and on specially prepared slabs and tablets, sometimes built into the walls of temples and other erections, sometimes set up inside temples or in the courtyards of them, or in conspicuous places in village-sites and fields, where they have occasionally in the course of time become buried.

The inscriptional records of India which thus come down to us do not, as far as they are known at present, pretend to the antiquity of the Greek inscriptions of the Hellenic world; much less to that of the inscriptions of Egypt and Assyria. But they are no less important; since we are dependent on them for almost all our knowledge of the ancient history of the country.

The primary reason for this is that the ancient Hindus, though by no means altogether destitute of the historical instinct, were not writers of historical books. In some of the *Purāṇas*, indeed, they have given us chapters which purport to present the succession of their kings from the commencement of the present age, the Kālyuga, in 3102 B.C.: but the chronological details of those chapters disclose the fault of treating contemporaneous dynasties, belonging to different parts of India, as successive dynasties ruling over one and the same territory; with the result that they would place more than three centuries in the future from the present time the great Gupta kings who reigned in Northern India from A.D. 320 to about 530. They have given us, for Kashmir the *Rājatarāṅgiṇī*, the first eight cantos of which, written by Kalhaṇa in A.D. 1148-49, purport to present the general history of that country, with occasional items relating to India itself, from 2448 B.C., and to give the exact length, even to months and days, of the reign of each king of Kashmir from 1182 B.C.: but, while we may accept Kalhaṇa as fairly correct for his own time and for the preceding century or so, an examination of the details of his work quickly exposes its imaginative character and its unreliability for any earlier period; notably, he places towards the close of the period 2448 to 1182 B.C. the great Maurya king Aśoka, whose real initial date was 264 B.C.; and he was obliged to allot to one king, Raṇādītya I., a reign of three centuries (A.D. 222 to 522, as placed by him) simply in order to save his own chronology. They have given us historical romances, such as the *Harshacharita* of Bāṇa, written in the 7th century, the *Vikramāditya-charita* of Bilhana, written about the beginning of the 12th century, and the Tamil poems, the *Kaṭavaḷi*, the *Kaliṅgatu-Parani*, and the *Vikrama-Chōlan-Uḷa*, the first of which may be of somewhat earlier date than Bāṇa's work, while the second and third are of much the same time with Bilhana's: but, while these present some charming reading in the poetical line, with much of interest, and certainly a fair amount of important matter, they give us no dates, and so no means without extraneous help of applying the

information that is deducible from them. Again, they have given us, especially in Southern India, a certain amount of historical details in the introductions and colophons of their literary works; and here they have often furnished dates which give a practical shape to their statements: but we quickly find that the historical matter is introduced quite incidentally, to magnify the importance of the authors themselves rather than to teach us anything about their patrons, and is not handled with any particular care and fulness; and it would be but a sketchy and imperfect history, and one relating to only a limited and comparatively late period, that we could piece together even from these more precise sources. The ancient Hindus, in short, have not bequeathed to us anything that can in any way compare with the historical writings of their Greek and Roman contemporaries. They have not even given us anything like the *Dipavamsa* of Ceylon, which, while it contains a certain amount of fabulous matter, can be recognized as presenting a real and reliable historical account of that island, taken from records written up during the progress to the events themselves, from at any rate the time of Aśoka to about A.D. 350; or like the *Mahāvamsa*, which, commenting on and amplifying the details of the *Dipavamsa*, takes up a similar account from the end of the period covered by that work. Even the Greek notices of India, commencing with the accounts of the Asiatic campaign of Alexander the Great, have told us more about its political history and geography during the earlier times than have the Hindus themselves: and in fact, in mentioning Sandrokottos, *i.e.* Chandragupta, the grandfather of Aśoka, and in furnishing details which fix his initial date closely about 320 B.C., the Greeks gave us the first means of making a start towards arranging the chronology of India on accurate lines. It is in these circumstances, in the absence of any indigenous historical writings of a plain, straightforward, and authentic nature, that the inscriptions of India are of such great value. They are supplemented—and to an important extent for at any rate the period from the end of Aśoka's reign in 227 B.C. to the commencement of the reign of Kanishka in 58 B.C., and again from about a century later to the rise of the Gupta dynasty in A.D. 320—by the numismatic remains. But the coins of India present no dates until nearly the end of the 2nd century A.D.; the case of Parthia, which has yielded dated coins from only 38 B.C., illustrates well the difficulty of arranging undated coins in chronological order even when the assistance of historical books is available; and what we may deduce from the coins of India is still to be put into a final shape in accordance with what we can determine from the inscriptions. In short, the inscriptions of India are the only sure grounds of historical results in every line of research connected with its ancient past; they regulate everything that we can learn from coins, architecture, art, literature, tradition, or any other source.

That is one reason why the inscriptions of India are so valuable; they fill the void caused by the absence of historical books. Another reason is found in the great number of them and the wide area that is covered by them. They come from all parts of the country: from Shāhbāzgarh in the north, in the Yūsufzai subdivision of the Peshāwar district, to the ancient Pāṇḍya territory in the extreme south of the peninsula; and from Assam in the east to Kāthiāwār in the west. For the time anterior to about A.D. 400, we already have available in published form, more or less complete, the contents of between 1100 and 1200 records, large and small; and the explorations of the Archaeological Department are constantly bringing to light; particularly from underground sites, more materials for that period. For the time onwards from that point, we have similarly available the contents of some 10,000 or 11,000 records of Southern India, and of at any rate between 700 and 800 records of Northern India where racial antagonism came more into play and worked more destruction of Hindu remains than in the south.

Another reason is found in the fact that from the first century B.C. the inscriptions are for the most part specifically dated: some in various eras the nature and application of which are now thoroughly well understood, often with also a mention of the

year of the twelve-years or of the sixty-years cycle of the planet Jupiter; others in the regnal years of kings whose periods are now well fixed. And, in addition to usually stating the month and the day along with the year, the inscriptions sometimes give, under the influence of Hindu astrology, other details so exact that we can determine, even to the actual hour, the occurrence of the event registered by a particular record.

A final reason is found in the precise nature of the inscriptions. A certain proportion of them consists of plain statements of events,—recitals of the pedigrees and achievements of kings, records of the carrying out of public works, epitaphs of kings, heroes, and saints, compacts of political alliance, and so on; and some of these present, in fact, short historical compositions which illustrate well what the ancient Hindus might have done if they had felt any special call to write plain and veracious chronicles on matter-of-fact lines. But we are indebted for the great bulk of the inscriptions, not to any historical instinct, but to the religious side of the Hindu character, and to the constant desire of the Hindus to make donations on every possible occasion. The inscriptions devoted simply to the propagation of morality and religion are not very numerous: the most notable ones in this class are the edicts of Aśoka, which we shall notice again farther on. The general object of the inscriptions was to register gifts and endowments, made sometimes to private individuals, but more usually to gods, to priests on behalf of temples and charitable institutions, and to religious communities. And, as the result of this, in the vast majority of the inscriptional remains we have a mass of title-deeds of real property, and of certificates of the right to duties, taxes, fees, perquisites, and other privileges. Now, the essential part of the records was of course the specification of the details of the donor, of the donee, and of the donation. And we have to bear in mind that not only are the donative records by far the most abundant of all, but also, among them, by far the most numerous are those which we may call the records of royal donations; by which we mean grants that were made either by the kings themselves, or by the great feudatory nobles, or by provincial governors and other high officials who had the royal authority to alienate state lands and to assign allotments from the state revenues; also, that many of them register, not simply the gift of small holdings, but grants of entire villages, and large and permanent assignments from the public revenues. It is to these facts that we are indebted for the great value of the records from the historical point of view. The donor of state lands or of an assignment from the public revenues must show his authority for his acts. A provincial governor or other high official must specify his own rank and territorial jurisdiction, and name the king under whom he holds office. A great feudatory noble will often give a similar reference to his paramount sovereign, in addition to making his own position clear. And it is neither inconsistent with the dignity of a king, nor unusual, for something to be stated about his pedigree in charters and patents issued by him or in his name. The records give from very early times a certain amount of genealogical information. More and more information of that kind was added as time went on. The recital of events was introduced, to magnify the glory and importance of the donors, and sometimes to commemorate the achievements of recipients. And it was thus, not with the express object of recording history, but in order to intensify the importance of everything connected with religion and to secure grantees in the possession of properties conveyed to them, that there was gradually accumulated almost the whole of the great mass of inscriptional records upon which we are so dependent for our knowledge of the ancient history of India in all its branches.

Coming now to a survey of the inscriptions themselves, we must premise that India is divided, from the historical point of view, though not so markedly in some other respects, into two well-defined parts, Northern and Southern. A classical name of Northern India is *Āryāvarta*, "the abode of the Āryas, the excellent or noble people." Another name, which figures both in literature and in the inscriptions, is *Uttarāpatha*, "the path of the north, the northern road."

And, as a classical name of Southern India answering to that we have *Dakṣiṇāpatha*, "the path of the south, the southern road," from the first component of which name comes our modern term *Deccan*, *Dekkan*, or *Dekhan*. Sanskrit literature names as the dividing-line between *Āryāvarta* or the *Uttarāpatha* and the *Dakṣiṇāpatha*, i.e. between Northern and Southern India, sometimes the *Vindhya* mountains, sometimes the river *Nerbudda* (*Narmadā*, *Narbada*) which, flowing close along the south of the *Vindhya* range, empties itself into the gulf of *Cambay* near *Broach*, in *Gujarāt*, *Bombay*. The river seems, on the whole, to furnish the better dividing-line of the two. But it does not reach, any more than the range exactly extends, right across India from sea to sea. And, to complete the dividing-line beyond the sources of the *Narbada*, which are in the *Māikal* range and close to the *Amaraṅṭak* hill in the *Rēwā* State, *Baghēlkhāṇḍ*, we have to follow some such course as first the *Maniārī* river, from its sources, which are in that same neighbourhood but on the south of the *Māikal* range, to the point where, after it has joined the *Seonāth*, the united rivers flow into the *Mahānadi*, near *Scor*-*Nārāyan* in the *Bilāspūr* district, *Central Provinces*, and then the *Mahānadi* itself, which flows into the bay of *Bengal* near *Cuttack* in *Orissa*. Even so, however, we have only a somewhat rough dividing-line between the historical Northern and Southern India; and the distinction must not be understood too strictly in connexion with the territories lying close on the north and the south of the line sketched above. In Western India, *Kāthiāwār* and all the portions of *Gujarāt* above *Broach* lie to the north of the *Narbada*; but from the palaeographic point of view, if not so much from the historical, they belong essentially to Southern India. Our modern Central India lies entirely in Northern India, but has various palaeographic connexions with Southern India. Our *Central Provinces* extend in the *Saugar* district into Northern India; and that portion of them presents in ancient times both northern and southern characteristics. Eastern India may be defined as consisting of *Bengal*, with *Orissa* and *Assam*: it belongs to Northern India.

The inscriptional remains of India, as known at present, practically begin with the records of *Aśoka*, the great *Maurya* king of Northern India,—grandson of that king *Chandragupta* whose name was written by the Greeks as *Sandrokottos*,—who reigned 264 to 227 B.C. The state of the alphabets, indeed, in the time of *Aśoka* renders it certain that the art of writing must have been practised in India for a long while before his period; and it gives us every reason to hope that systematic exploration, especially of buried sites, will eventually result in the discovery of records framed by some of his predecessors or by their subjects. But those discoveries have still to be made; and matters stand just now as follows. From before the time of *Aśoka* we have an inscription on a relic-vase from a stūpa or relic-mound at *Piprahwa* in the north-east corner of the *Bastī* district, *United Provinces*, which preserves the memory of the slaughtered kinsmen of *Buddha*, the *Sākyas* of *Kapilavastu* according to the subsequent traditional nomenclature. We may perhaps place before his time the record on the *Sōhgaurā* plate, from the *Gorākhpūr* district, *United Provinces*, which notifies the establishment of two public storehouses at a junction of three great highways of vehicular traffic to meet any emergent needs of persons using these roads. And we may possibly decide hereafter to refer to the same period a few other records which are not at present regarded as being quite so early. But, practically, the known inscriptions of India begin with the records of that king who calls himself in them "the king *Dēvānampiya-Piyadassi*, the Beloved of the Gods, He of Gracious Mien," but who is best known as *Aśoka* by the name given to him in the literature of India and Ceylon and in an inscription of A.D. 150 at *Junāgaḍh* (*Junagarh*) in *Kāthiāwār*. From his time onwards we have records from all parts in constantly increasing numbers, particularly during the earlier periods, from caves, rock-cut temples, and Buddhist stūpas. Many of them, however, are of only a dedicatory nature, and, valuable as they are for purposes of religion, geography, and other miscellaneous lines of research, are not very helpful in the

historical line. We are interested here chiefly in the historical records; and we can notice only the most prominent ones even among them.

Of this king Aśoka we have now thirty-five different records, some of them in various recessions. Amongst them, the most famous ones are the seven pillar-edicts and the fourteen rock-edicts, found in various versions, and in a more or less complete state, at different places from Shāhhāzgarh in the Yūsufzai country in the extreme north-west, to Radhā, Mathia, and Rāmpūrwa in the Champāran district, Bengal, at Dhauli in the Cuttack district of Orissa, at Jaugada in the Gañjām district, Madras, at Gīrnār (Junāgaḍh) in Kāthiāwār, and even at Sopāra in the Thāpa district, Bombay. These edicts were thus published in conspicuous positions in or near towns, or close to highways frequented by travellers and traders, or in the neighbourhood of sacred places visited by pilgrims, so that they might be freely seen and perused. And the object of them was to proclaim the firm determination of Aśoka to govern his realm righteously and kindly in accordance with the duty of pious kings, and with considerateness for even religious beliefs other than the Brāhmaṇical faith which he himself at first professed, and to acquaint his subjects with certain measures that he had taken to that end, and to explain to them how they might co-operate with him in his objects. But, in addition to mentioning certain contemporaneous foreign kings, Antiochus II. (Theos) of Syria, Ptolemy Philadelphus of Egypt, Antigonus Gonatas of Macedonia, Magas of Cyrene, and Alexander II. of Epirus, they yield items of internal history, in detailing some of Aśoka's administrative arrangements; in locating the capital of his empire at Pāṭaliputra (Patna), and seats of viceroys at Ujjeni (Ujjain) and Takhasilā (Taxila); in giving the names of some of the leading peoples of India, particularly the Chōlas, the Pāṇdyas, and the Andhras; and in recording the memorable conquest of the Kālīnga country, the attendant miseries of which first directed the thoughts of the king to religion and to solicitude for the welfare of all his subjects. Another noteworthy record of Aśoka is that notification, containing his Last Edict, his dying speech, issued by local officials just after his death, which is extant in various recensions at Sahasrām, Rūpnāth, and Bairāt in Northern India, and at Brahmagiri, Siddhāpura, and Jātīnga-Rāmēśvara in Mysore. Some three years before the end of his long reign of thirty-seven years, Aśoka became a convert to Buddhism, and was admitted as an Upāsaka or lay-worshipper. Eventually, he formally joined the Buddhist order; and, following a not infrequent custom of ancient Indian kings, he abdicated, took the vows of a monk, and withdrew to spend his remaining days in religious retirement in a cave-dwelling on Suvarnagiri (Sōngri), one of the hills surrounding the ancient city of Girivraja, below Rājagriha (Rājgir), in the Patna district in Behār. And there, about a year later, in his last moments, he delivered the address incorporated in this notification, proclaiming as the only true religion that which had been promulgated by Buddha, and expanding the topic of the last words of that great teacher: "Work out your salvation by diligence!" This record, it may be added, is also of interest because, whereas such of the other known records of Aśoka as are dated at all are dated according to the number of years elapsed after his anointment to the sovereignty, it is dated 256 years after the death of Buddha, which event took place in 483 B.C.

For the two centuries or nearly so next after the end of the reign of Aśoka, we have chiefly a large number of short inscriptions which are of much value in miscellaneous lines of research—paleography, geography, religion, and so on. But historical records are by no means wanting; and we may mention in particular the following. From the caves in the Nāgarjunī Hills in the Gayā district, Bengal, we have (along with three of the inscriptions of Aśoka himself) three records of a king Dasaratha who, according to the *Vishnu-Purāna*, was a grandson of Aśoka. From the stūpa at Bharaut in the Nāgōd state, Central India, we have a record which proves the existence of the dynasty of the Śuṅga kings, for whom the *Purānas*, placing them next after the line of Chandragupta and Aśoka, indicate

the period 183 to 71 B.C. Two of the records from the stūpa at Bhaṭṭiprōlu in the Kistna district, Madras, give us a king of those parts, reigning about 200 B.C., whose name appears both as Kubiraka and as Khubiraka. From Bēsnagar in the Gwālior state we have an inscription, referable to the period 175 to 135 B.C., which mentions a king of Central India, by name Bhāgabhādra, and also mentions, as his contemporary, one of the Greek kings of the Punjab, Antialcidas, whose name is familiar from his coins in the form Antialkidas. From the Hāthigumphā cave near Cuttack, in Orissa, we have a record, to be placed about 140 B.C., of king Khāravela, a member of a dynasty which reigned in that part of India. From a cave at Pabhōsā in the Allahābād district, United Provinces, we have two records which make known to us a short succession of kings of Adhi-chātrā, otherwise known as Abichchhattra. From a cave at the Nānāghāt Pass in the Poona district, Bombay, we have a record of queen Nayanikā, wife of one of the great Sātāvāhana-Sātakarṇi kings of the Deccan. And from the stūpa No. 1 at Sāchi in the Bhōpāl state, Central India, we have a record of a king Śrī-Sātakarṇi, belonging to perhaps another branch of the same great stock.

The historical records become more numerous from the time of the Kushan king Kanishka or Kānishka, who began to reign in 58 B.C., and of the so-called Vikrama era, the great historical era of Northern India, beginning in that year. For the period of him and his immediate successors, Vāishka, Huviska and Vasudeva, we have now between seventy and eighty inscriptions, ranging from 54 B.C. to A.D. 42, and disclosing a sway which reached at its height from Bengal to Kābul: we are indebted for some of these to the Buddhists, in connexion with whose faith the memory of Kanishka was preserved by tradition, but for most of them to the Jains, who seem to have been at that time the more numerous sect in the central part of his dominions.

The dynasty of Kanishka was succeeded by another foreign ruler, Gondophērēs, popularly known as Gondophares, whose coins indicate that, in addition to a large part of north-western India and Sind, his dominions included Kābul, Kandahār, and Sēstān. This king is well known to Christian tradition, in connexion with the mission of St Thomas the Apostle to the East. And the tradition is substantially supported by an inscription from Takht-i-Bahāi in the Yūsufzai country on the north-west frontier, which, like some of his coins, mentions him as Guduphara or Gunduphara, and proves that he was reigning there in A.D. 47.

Gondophērēs was followed by the Kadphīsēs kings, belonging to another branch of the Kushan tribe, who perhaps extended their sway farther into India, as far at least as Mathurā (Muttra), and reigned for about three-quarters of a century. For their period, and in fact for the whole time to the rise of the Guptas in A.D. 320 we have as yet but scanty help from the inscriptions in respect of the political history of Northern India: we are mostly dependent on the coins, which tend to indicate that that part of India was then broken up into a number of small sovereignties and tribal governments. An inscription, however, from Panjtar in the Yūsufzai territory mentions, without giving his name, a Kushan king whose dominion included that territory in A.D. 66. And an inscription of A.D. 242 from Mathurā has been understood to indicate that some descendant of the same stock was then reigning there. The inscriptional records for that period belong chiefly to Southern India.

Meanwhile, however, in the south-west corner of Northern India, namely in Kāthiāwār, there arose another foreign king, apparently of Parthian extraction, by name Nahapāna, described in his records, whether by a family name or by a tribal appellation, as a Chhaharāta or Kshaharāta, in whom we have the

<sup>1</sup> It may be remarked that there are about twelve different views regarding the date of Kanishka and the origin of the Vikrama era. Some writers hold that Kanishka began to reign in A.D. 78: one writer would place his initial date about A.D. 123; others would place it in A.D. 278. The view maintained by the present writer was held at one time by Sir A. Cunningham; and, as some others have already begun to recognize, evidence is now steadily accumulating in support of the correctness of it.



founder of the so-called Śaka era, the principal era of Southern India, beginning in A.D. 78: in respect of him we learn from the *Periplus of the Erythraean Sea* that he was reigning between A.D. 80 and 80, and from inscriptions that he was still reigning in A.D. 120 and 124: at the latter time, his dominions included Nāsik and other territories on the south of the Narbadā; and the *Periplus* names as his capital a town which it calls Minnagar, and which Ptolemy would locate in such a manner as to suggest that it may be identified with the modern Dōhad in the Pañch Mahāls district of Gujarāt, Bombay. Nahapāna was overthrown, and his family was entirely wiped out, soon after A.D. 125, by the great Śātāvāhana king Gautamputra-Śrī-Sātākarnī, who thereby recovered the territories on the south of the Narbadā. On the north of that river, however, he was followed by a line of kings founded by his viceroy Chashṭāna, son of Ghasmotika, to whom Ptolemy, mentioning him as Tīastanēs, assigns Ujjain as his capital: these names, again, show a foreign origin; but, from the time of his son Jayadāman, the descendants of Chashṭāna became Hinduized, and mostly bore purely Indian appellations. The coins show that the descendants of Chashṭāna ruled till about A.D. 388, when they were overthrown by the great Gupta dynasty of Northern India. Only a few of their inscriptional records have been discovered: but amongst them a very noteworthy one is the Junāgadh (Junagarh) inscription of Chashṭāna's grandson, Rudradāman, bearing a date in A.D. 150; it is remarkable as being the earliest known long inscription written entirely in Sanskrit.

From Southern India we have, at Nāsik, inscriptions of the Śātāvāhana king Gautamputra-Śrī-Sātākarnī, mentioned just above, and of his son Vāsīṣṭhputra-Śrī-Pulumāyī, and of another king of that line named Gautamputra-Śrī-Yājña-Sātākarnī; and other records of the last-mentioned king come from Kapheri near Bombay, and from the Kistna district, Madras, and testify to the wide extent of the dominions of the line to which he belonged. The records of this king carry us on to the opening years of the 3rd century, soon after which time, in those parts at any rate, the power of the Śātāvāhana kings came to an end. And we have next, also from Nāsik, an inscription of an Ābhīra king named Īśvarasena, son of Śivadatta; in this last-mentioned person we probably have the founder of the so-called Kalachuri or Chēdi era, beginning in A.D. 248 or 240, which we trace in Western India for some centuries before the time when it was transferred to, or revived in, Central India, and was invested with its later appellation: we trace it notably in the records of a line of kings who called themselves Traikūṭakas, apparently from Trikūṭa as the ancient name of the great mountain Harischandra-gad in the Western Ghats, in the Ahmadnagar district.

We can, of course, mention in this account only the most prominent of the inscriptional records. Keeping for the present to Southern India, we have from Banawāsi in the North Kanara district, Bombay, and from Malajāvi in the Shimoga district, Mysore, two inscriptions of a king Hārīt putra-Sātākarnī of the Vīṇhukādga-Chutu family, reigning at Vaijayanti, i.e. Banawāsi, which disclose the existence there of another branch, apparently known as the Chuṭu family and having its origin at a place named Vishnugarta, of the great stock to which the Śātāvāhana-Sātākarnīs belonged. And another Malajāvi inscription, of a king Śiva-Skandavarman, shows that the Sātākarnīs of that locality were followed by a line of kings known as the Kadambas, who left descendants who continued to rule until about A.D. 650. From the other side of Southern India, an inscription from the stūpa at Jaggayāpēṭa in the Kistna district, Madras, referable to the 3rd century A.D., gives us a king Māḍharīputra-Śrī-Vīra-Purushadatta, of the race of Ikshvāku. And some Prakṛit copperplate inscriptions from the same district, referable to the 4th century, disclose a line of Pallava kings at Kāñchi, the modern Conjeeveram near Madras, whose descendants, from about A.D. 550, are well known from the later records.

Reverting to Northern India, we have from the extreme north-west a few inscriptions dated in the era of 58 B.C. which carry us on to A.D. 322. The tale is then taken up chiefly by the records of the great Gupta kings of Pāṭāliputra, i.e. Patna, who

rose to power in A.D. 320, and gradually extended their sway until it assumed dimensions almost commensurate with those of Aśōka and Kapishka: the records of this series are somewhat numerous; and a very noteworthy one amongst them is the inscription of Samudragupta, incised at some time about A.D. 375 on one of the pillars of Aśōka now standing at Allahābād, which gives us a wide insight into the political divisions, with their contemporaneous rulers, of both Northern and Southern India: it is also interesting because it, or another record of the same king at Ēraṇ in the Saugar district, Central Provinces, marks the commencement of the habitual use of Sanskrit for inscriptional purposes. The inscriptions of the Gupta series run on to about A.D. 530. But the power of the dynasty had by that time become much curtailed, largely owing to an irruption of the Hūns under Tōramāpa and Mihirakula, who established themselves at Siālkōt, the ancient Śākala, in the Punjab. We have inscriptional records of these two persons, not only from Kura in the Salt Range, not very far from Siālkōt, but also from Ēraṇ and from Gwālīor. And next after these we have inscriptions from Mandasor in Mālwā, notably on two great monolith pillars of victory, of a king Vishvuvardhana-Yasōdharman, which show that he overthrew Mihirakula shortly before A.D. 532, and, describing him as subjugating territories to which not even the Guptas and the Hūns had been able to penetrate, indicate that he in his turn established for a while another great paramount sovereignty in Northern India.

We have thus brought our survey of the inscriptions of India down to the 6th century A.D. There then arose various dynasties in different parts of the country: in Northern India, i.e. Kāñchi-āwār, the Maitrakas of Valabhī; at Kanauj, the Maukharis, who, after no great lapse of time, were followed by the line to which belonged the great Harshavardhana, "the warlike lord (as the southern records style him) of all the region of the north;" and, in Behār, another line of Guptas, usually known as the Guptas of Magadha: in Southern India, the Chalukyas, who, holding about A.D. 625 the whole northern part of Southern India from sea to sea, then split up into two branches, the Western Chalukyas of Bādāmi in the Bijāpūr district, Bombay, and the Eastern Chalukyas of Vengi in the Godāvāri district, Madras; and, below them, the successors of the original Pallavas of Kāñchi (Conjeeveram). These all had their time, and passed away. And they and their successors have left us so great a wealth of inscriptional records that no further detailed account can be attempted within the limits available here. We must pass on to a few brief remarks about the language of the records and the characters in which they were written.

The inscriptions of Aśōka present two alphabets, which differ radically and widely: one of them is known as the Brāhmī; the other, as the Kharōṣṭhī or Kharōṣṭrī. For the decipherment of the Brāhmī alphabet we are indebted to James Prinsep, who determined the value of practically all the letters between 1834 and 1837. The decipherment of the Kharōṣṭhī alphabet was a more difficult and a longer task: it was virtually finished, some twenty years later, by the united efforts of C. Masson, Prinsep, H. L. Lassen, H. H. Wilson, E. Norris, Sir A. Cunningham, and John Dowson; but there are still a few points of detail in respect of which finality has not been attained.

The Kharōṣṭhī script was written from right to left, and it is undeniably of Semitic origin; and the theory about it, based on the known fact that the valley of the Indus was a Persian satrapy in the time of Darius (521-485 B.C.), is that the Aramaic script was then introduced into that territory, and that the Kharōṣṭhī is an adaptation of it. Except in a few intrusive cases, the use of the Kharōṣṭhī in India was limited to the valley of the Indus, and to the Punjab as defined on the south by the territory watered by the Bās (Beas) and the Satlaj (Sutlej); and the eastern locality of the meeting of the two alphabets is marked by coins bearing Kharōṣṭhī and Brāhmī legends which come from the districts of the Jālandhar (Jullundur) division, and by two short rock-cut records, each presented in both the alphabets, at Pathyār and Kanhiāra in the Kāngra valley. Outside India, this script was notably current in Afghanistan; and documents written in it have in recent years been found in Chinese Turkestan. In India it continued in use, as far as our present knowledge goes, down to A.D. 343.

The Brāhmī alphabet, written from left to right, belonged to the remainder of India; but it must also have been current in learned circles even in the territory where popular usage favoured the other script. Various views about its origin have been advanced: amongst

them is the theory that it was derived from the oldest north-Semitic alphabet, which prevailed from Phoenicia to Mesopotamia, and may, it is held, have been introduced into India by traders at some time about 800 B.C. It is, however, admitted that the earliest known form of the Brāhmī is a script framed by Brāhmins for writing Sanskrit. Also, the theory is largely based on a coin from Eraṇ, in the Saugar district, Central Provinces, presenting a Brāhmī legend running retrograde from right to left; from which it is inferred that that was the original direction of this writing, and that the script eventually assumed the other direction, which alone it has in the inscriptions, after passing, like the Greek, through a stage in which the lines were written in both directions alternately. But we can cite many instances in which ancient die-sinkers were careless, wholly or partially, in the matter of reversing the legends on their dies, with the result that not only syllables frequently, but sometimes entire words, stand in reverse on the coins themselves; moreover, the Eraṇ coin, being one of the earliest known Indian coins bearing a legend at all, may quite possibly belong to a period before the time when the desirability of working in reverse on the dies presented itself to the Indian die-sinkers. In all the circumstances, the evidence of the Eraṇ coin cannot be regarded as conclusive; and we require some inscription on stone, or at least some longer record on metal than a brief legend of five syllables, to satisfy us that the Brāhmī writing ever had a direction different from that which it has in the inscriptions. Further, if there is any radical connexion between the Brāhmī and the Semitic alphabet indicated above, so many curious and apparently capricious changes must have been made, in adapting that alphabet, that it would seem more probable that the two scripts were derived from a joint original source. In view of the high state of civilization to which the Hindus had evidently attained even before the time of Chandragupta, the grandfather of Aśoka, it must still be regarded as possible that they were the independent inventors of that which was emphatically their national alphabet. The Brāhmī alphabet is the parent of all the modern Hindu scripts, including on one side the Nāgarī or Devanāgarī, and on the other the widely dissimilar round letters of the Kanarese, Tamil, Telugu, and other southern alphabets; and the inscriptions enable us to trace clearly the gradual development of all the modern forms.

The great classical Indian language, Sanskrit, is not found in any inscriptions records of the earliest times. It is not, however, to be supposed therefrom that the use and cultivation of Sanskrit ever lay dormant, and that there was a revival of this language when it did eventually come to be used in the inscriptions; the case simply is that, during the earlier periods, Sanskrit was not known much, if at all, outside the Brāhmanical and other literary and priestly circles, and so was not recognized as a suitable medium for the inscriptions, which were put on record in the inscriptions for the information of the people at large.

In Northern India, the inscriptions of the period before 58 B.C. present various early Prakṛits, i.e. vernaculars more or less derived from Sanskrit or brought into it by use with it. From 58 B.C., however, the influence of Sanskrit began to manifest itself in the inscriptions, with the result that the records present from that time a language which is conveniently known as the mixed dialect, meaning neither exactly Prakṛit nor exactly Sanskrit, but Prakṛit with an intermixture of Sanskrit terminations and some other features; and we have, in fact, from Mathurā (Mutturā), a locality which has yielded interesting remains in various directions, a short Brāhmanical inscription of 43 B.C., which was written wholly in Sanskrit. The mixed dialect appears to have been the general one for inscriptions purposes in Northern India until about A.D. 320. But a remarkable exception is found in the inscription of Rudradāman, dated in A.D. 150, at Junagadh in Kāthiāwār (mentioned on a preceding page), which is a somewhat lengthy record composed in thoroughly good literary Sanskrit prose. Also, the extant inscriptions of the descendants of Rudradāman—(but only four of their records, ranging from A.D. 181 to 205, are at present available for study)—are in almost quite correct Sanskrit; and this suggests that, from his time, the language may have been habitually used for inscriptions purposes in the dominions of his dynasty. That, however, is a matter of conjecture; and elsewhere pure and good Sanskrit, without any Prakṛit forms, appears next, and is found in verse as well as in prose, in the two inscriptions from Eraṇ and Allahābād, referable to the period about A.D. 340 to 375, of the great Gupta king Samudragupta. From that time onwards, as far as our present knowledge goes, Sanskrit, with a very rare introduction of Prakṛit or vernacular forms, was practically the only inscriptions language in the northern parts of India. We can, however, cite a record of A.D. 862 from the neighbourhood of Jōdhpur in Rājputānā, the body of which was written in Māhārāshṭrī Prakṛit.

In Southern India we have an instance of the mixed dialect in the Nāgī inscription, referable to A.D. 257 or 258, of the Chōla king Išvarasēna, son of Svādātā, which has been mentioned on a preceding page. With the exception, however, of that record and of the few which are mentioned just below, the inscriptions language of Southern India appears to have been generally Prakṛit of one kind or another until about A.D. 400, or perhaps even somewhat later. Sanskrit figures first in one of the records at Nāsik of Śiśabhaddata (Ushavādātā), son-in-law of the Kshaharāta king Nahapāna, which consequently gives it almost as early an appearance in the south

as that which is established for it in the north; but it is confined in this instance to a preamble which recites the previous donations and good works of Śiśabhaddata; the record passes into Prakṛit for the practical purpose for which it was framed. Sanskrit figures next, in an almost correct form, in the short inscription of not much later date at Kāgheri, near Bombay, of the queen (her name is not extant) of Vaiśiṭhiputra-Sri-Sātakargi. It next appears in certain formulae, and benedictive and imprecatory verses, which stand at the end of some of the Prakṛit records of the Pallava series referable to the 4th century; but here we have quotations from books, not instances of original composition. We have a Sanskrit record, obtained in Kāhndēsh, but probably belonging to some part of Gujārāt, of a king named Rudradāsa, which is perhaps dated in A.D. 367. But the next southern inscription in Sanskrit, of undoubted date, is a record of A.D. 456, belonging to the Vyārā subdivision of the Baroda state in Gujārāt, of the Trakōtaka king Dahrasēna. The records of the early Kadamba kings of Banawāsī in North Kanara, Bombay, exhibit the use of Sanskrit from an early period in the 6th century; and records of the Pallava kings show it from perhaps a somewhat earlier time on the other side of India. The records of the Chalukya kings present Sanskrit from A.D. 578 onwards. And from this latter date the language figures freely in the southern records. But some of the vernaculars, in their older forms, shortly begin to present themselves alongside of it; and, without entirely superseding Sanskrit even to the latest times, the use of them for inscriptions purposes became rapidly more and more extensive. The vernacular that first makes its appearance is Kanarese, in a record of the Chalukya king Maṅgalēsa, of the period A.D. 597 to 608, at Bādāmi in the Bijāpūr district, Bombay. Tamil appears next, between about A.D. 610 and 675, in records of the Pallava king Mahēndravarmā I. at Vallam in the Chingalpat (Chingleput) district, Madras, and of his great-grandson Paramēśvaravarmā I. from Kūram in the same district. Telugu appears certainly in A.D. 1011, in a record of the Eastern Chalukya king Vimalāditya; and it is perhaps given to us in A.D. 843 or 844 by a record of his ancestor Vishuvardhana V.; in the latter case, however, the authenticity of the document is not certain. Malayālam appears about A.D. 1150, in inscriptions of the rulers of Kēraja from the Travancore state. And on the colossal image of Gommatēśvara at Sravāna-Belgoḷa, in Mysore, there are two lines of Marāṭhī, notifying for the benefit of pilgrims from the Marāṭhā country the names of the persons who caused the image and the enclosure to be made, which are attributed to the first quarter of the 12th century; this language, however, figures first for certain in a record of A.D. 1207, of the time of the Dēvagrīri-Yādava king Śiṅghapa, from Kāhndēsh in the north of Bombay.

**BIBLIOGRAPHY.**—The systematic publication of the Indian inscriptions has not yet begun. Cunningham inaugurated a *Corpus Inscriptionum Indicarum*, by giving us in 1877 the first volume of it, dealing with the records of Aśoka; but the only other volume which has been published is vol. iii., by Fleet, dealing with the records of the Gupta series. The other published materials are mostly to be found here and there in the *Journals* of the Royal Asiatic Society of London, its Bombay branch, and the Asiatic Society of Bengal, in the *Reports* of the various Archaeological Surveys, and in the *Indian Antiquary*, the *Epigraphia Indica* and the *Epigraphia Carnatica*; and much work has still to be done in bringing them together according to the periods and dynasties to which they relate, and in revising some of them in the light of new discoveries and the teachings of later research. The authority on Indian palaeography is Bühler's work, published in 1896 as part 2 of vol. i. of the *Grundriss der Indo-Arischen Philologie und Altertumskunde*; an English version of it was issued in 1904 as an appendix to the *Indian Antiquary*, vol. xxxiii. (J. F. F.)

### III. GREEK INSCRIPTIONS

Etymologically the term inscription (ἐπιγραφή) would include much more than is commonly meant by it. It would include words engraved on rings, or stamped on coins,<sup>1</sup> vases, lamps, wine-jar handles,<sup>2</sup> &c. But Boeckh was clearly right in excluding this *varia supplex* from his *Corpus Inscriptionum Graecarum*, or only admitting it by way of appendix. Giving the term inscription a somewhat narrower sense, we still include within it a vast store of documents of the greatest value to the student of Greek civilization. It happens, moreover, that Greek inscriptions yield the historian a richer harvest than those of Rome. Partly from fashion, but partly from the greater abundance

<sup>1</sup> The legends on coins form part of numismatics, though closely connected with inscriptions.

<sup>2</sup> The amphorae which conveyed the wine and other products of various localities have imprinted on their handles the name of the magistrate and other marks of the place and date. Large collections have been made of them, and they repay inquiry. See Dumont, *Inscriptions céramiques* (1872); Paul Becker, *Henkelinschriften* (Leipzig, pt. i. 1862, pt. ii. 1863); Hiller v. Gaertringen, *I.G.* xii. 1065-1441.

of the material, the Romans engraved their public documents (treaties, laws, &c.) to a large extent on bronze. These bronze tablets, chiefly set up in the Capitol, were melted in the various conflagrations, or were carried off to feed the mint of the conqueror. In Greece, on the contrary, the mountains everywhere afforded an inexhaustible supply of marble, and made it the natural material for inscriptions. Some Greek inscribed tablets of bronze have come down to us,<sup>1</sup> and many more must have perished in the sack of cities and burning of temples. A number of inscriptions on small thin plates of lead, rolled up, have survived; these are chiefly imprecations on enemies<sup>2</sup> or questions asked of oracles.<sup>3</sup> An early inscription recently discovered (1905) at Ephesus was on a plate of silver. But as a rule the material employed was marble. These marble monuments are often found *in situ*; and, though more often they were used up as convenient stones for building purposes, yet they have thus survived in a more or less perfect condition.<sup>4</sup>

Inscriptions were usually set up in temples, theatres, at the side of streets and roads, in *τεμένη* or temple-precincts, and near public buildings generally. At Delphi and Olympia were immense numbers of inscriptions—not only those engraved upon the gifts of victorious kings and cities, but also many of a more public character. At Delphi were inscribed the decrees of the Amphictyonic assembly, at Olympia international documents concerning the Peloponnesian cities; the Parthenon and Acropolis were crowded with treaties, laws and decrees concerning the Athenian confederation; the Heraeum at Samos, the Artemisium at Ephesus, and indeed every important sanctuary, abounded with inscriptions. It is a common thing for decrees (*ψηφίσματα*) to contain a clause specifying where they are to be set up, and what department of the state is to defray the cost of inscribing and erecting them. Sometimes duplicates are ordered to be set up in various places; and, in cases of treaties, arbitrations and other international documents, copies were always set up by each city concerned. Accordingly documents like the *Marmor Ancyranum* and the *Edict of Diocletian* have been restored by a comparison of the various fragments of copies set up in diverse quarters of the empire.

Greek inscribed marbles varied considerably in their external appearance. The usual form was the *στήλη*, the normal type of which was a plain slab, from 3 to 4 or even 5 ft. high,<sup>5</sup> 3 or 4 in. thick, tapering slightly upwards from about 2 ft. wide at bottom to about 18 in. at the top, where it was either left plain or often had a slight moulding, or still more commonly was adorned with a more or less elaborate pediment; the slab was otherwise usually plain. Another form was the *βωμός* or altar, sometimes square, often circular, and varying widely in size. Tombstones were either *στήλαι* (often enriched beneath the pediment with simple groups in relief, commemorative of the deceased), or *κίονες*, pillars, of different size and design, or sarcophagi plain and ornamental. To these must be added statue-bases of every kind, often inscribed, not only with the names and honours of individuals, but also with decrees and other documents. All these forms were intended to stand by themselves in the open air. But it was also common to inscribe state documents upon the surface of the walls of a temple, or other public building. Thus the antae and external face of the walls of the proaegs of the temple of Athena Polias at Priene were covered

with copies of the awards made concerning the lands disputed between Samos and Priene (see *Gk. Inscr. in Brit. Mus.* iii. § 1); similarly the walls of the Artemisium at Ephesus contained a number of decrees (*ibid.* iii. § 2), and the *proscenium* of the Odeum was lined with *crustae*, or "marble-venering," under 1 in. thick, inscribed with copies of letters from Hadrian, Antoninus and other emperors to the Ephesian people (*ibid.* p. 151). The workmanship and appearance of inscriptions varied considerably according to the period of artistic development. The letters incised with the chisel upon the wall or the *στήλη* were painted in with red or blue pigment, which is often traceable upon newly unearthed inscriptions. When Thucydides, in quoting the epigram of Peisistratus the younger (vi. 54), says "it may still be read *ἀμυρόσι γράμμασι*," he must refer to the fading of the colour; for the inscription was brought to light in 1877 with the letters as fresh as when they were first chiselled (see Kumanudes in *Ἀθήναιον*, no. 149; *I.G.* suppl. to vol. i. p. 41). The Greeks found no inconvenience, as we should, in the bulkiness of inscriptions as a means of keeping public records. On the contrary they made every temple a monument room; and while the innumerable *στήλαι*, *Heraeae*, bases and altars served to adorn the city, it must also have encouraged and educated the sense of patriotism for the citizen to move continually among the records of the past. The history of a Greek city was literally written upon her stones.

The primary value of an inscription lay in its documentary evidence (so Euripides, *Suppl.* 1202, fol.). In this way they are continually cited and put in evidence by the orators (e.g. see Demost. *Fals. Leg.* 428; Aeschin. *In Ctes.* § 75). But the Greek historians also were not slow to recognize their importance. Herodotus often cites them (iv. 88, 90, 91, v. 58 sq., vii. 228); and in his account of the victory of Plataea he had his eye upon the tripod-inscription (ix. 81; cf. Thuc. i. 132). Thucydides's use of inscriptions is illustrated by v. 18 fol., 23, 47, 77, vi. 54, 59. Polybius used them still more. In later Greece, when men's thoughts were thrown back upon the past, regular collections of inscriptions began to be made by such writers as Philochorus (300 B.C.), Polemon (2nd century B.C., called *σθηλοκόπας* for his devotion to inscriptions), Aristodemus, Craterus of Macedonia, and many others.

At the revival of learning, the study of inscriptions revived with the renewed interest in Greek literature. Cyriac of Ancona, early in the 15th century, copied a vast number of inscriptions during his travels in Greece and Asia Minor; his MS. collections were deposited in the Barberini library at Rome, and have been used by other scholars. (See *Bull. Corr. Hellén.* i.; Larfeld in Müller's *Handbuch* i<sup>2</sup>, p. 368 f.; Ziebarth, "de ant. Inscript. Syllogis" in *Ephem. Epigr.* ix.). Succeeding generations of travellers and scholars continued to collect and edit, and Englishmen in both capacities did much for this study.

Thus early in the 19th century the store of known Greek inscriptions had so far accumulated that the time had come for a comprehensive survey of the whole subject. And it was the work of one great scholar, Augustus Boeckh, to raise Greek epigraphy into a science. At the request of the Academy of Berlin he undertook to arrange and edit all the known inscriptions in one systematic work, and vol. i. of the *Corpus Inscriptionum Graecarum* was published in 1828, vol. ii. in 1833. He lived to see the work completed, although other scholars were called in to help him to execute his great design; vol. iii., by Franz, appeared in 1853; vol. iv., by Kirchhoff, in 1856.<sup>1</sup> The work is a masterpiece of lucid arrangement and profound learning, of untinged industry and brilliant generalization. Out of the publication of the *Corpus* there grew up a new school of students, who devoted themselves to discovering and editing new texts, and working up epigraphical results into monographs upon the many-sided history of Greece. In the *Corpus* Boeckh had settled for ever the methods of Greek epigraphy; and in his *Staatsverwaltung der Athener* (3rd ed. of vols. i. ii. by Fränkel, 1886; well known to English readers from Sir G. C. Lewis's translation, *The Public Economy of Athens*, 2nd ed., 1842) he had given a palmary specimen of the application of epigraphy to historical studies. At the same time Franz drew up a valuable introduction to the study of inscriptions in his *Elementa Epigraphica Graecae* (1840).

<sup>1</sup> An index to the four volumes was long wanting; it was at length completed and appeared in 1877.

<sup>1</sup> Cf. Treaty between Elis and the Heraeans, about 550-500 B.C., from Olympia (Boeckh, *C.I.G.* 11, Hicks, 29, and others in Dittenberger-Purgold, *Inscr. v. Olympia*, 1-43); a similar bronze treaty from the Locri Ozolae (Dittenberger, *I.G.* ix. 334); bronze plate from Dodona, recording the victory of Athens over the Laedaemonians in a sea-fight, probably 429 B.C. (Dittenberger, *Syll.* 2, 30).

<sup>2</sup> See Wünsch *I.G.* iii., App.; Audollent, *Defixionum Tabellae* (1904).

<sup>3</sup> See Karapanos, *Dodone et ses ruines*; Hoffman, *Gr. Dial. Inscr.* 1558-1598.

<sup>4</sup> What was done by Themistocles under stress of public necessity (Thucyd. i. 93) was done by others with less justification elsewhere; and from Byzantine times onward Greek temples and inscriptions were found convenient quarries.

<sup>5</sup> It appears from Cicero, *De Legibus*, ii. 26, 27, that the size of Athenian gravestones was limited by law.

visiting the Levant combined to encourage the growth of the subject, which has been advanced by the labours of many scholars, and chiefly Ludwig Ross, Leake, Pittakys, Rangabé, Le Bas and later by Meier, Sauppe, Kirchhoff, Kumanudis, Waddington, Köhler, Dittenberger, Homolle, Haussoullier, Wilhelm and others. Together with the development of this school of writers there has gone on a systematic exploration of some of the most famous sites of antiquity, with the result of exhuming vast numbers of inscriptions. To mention only some of the most important: Cyrene, Rhodes, Cos, Cnidus, Halicarnassus, Miletus, Priene, Ephesus, Magnesia on the Maeander, Pergamum, Delos, Thera, Athens, Eleusis, Epidaurus, Olympia, Delphi, Dodona, Sparta, have been explored or excavated by the Austrians, English, French, Germans and Greeks. French, British, Austrian and American institutes have been established at Athens, to a great extent engaged in the study of inscriptions. From every part of the Greek world copies of inscriptions are brought home by the students of these institutes and by other travellers. And still the work proceeds at a rapid rate. For indeed the yield of inscriptions is practically inexhaustible: each island, every city, was a separate centre of corporate life, and it is significant to note that in the island of Calymnos alone C. T. Newton collected over one hundred inscriptions, many of them of considerable interest.

The result of this has been that Boeckh's great work, though it never can be superseded, yet has ceased to be what its name implies. The four volumes of the *C.I.G.* contain about 10,000 inscriptions. But the number of Greek inscriptions now known is probably more than three or four times as great. Many of these are only to be found published in the scattered literature of dissertations, or in Greek, German and American periodicals. But even these have not been completely gathered and parts of others have appeared (by 1906) representing Attica, Argolis, Megaris, Boeotia, Phocis, Locris, Aetolia, Acarnania, Ionian Islands, Aegean Islands (exc. Delos), Sicily, Italy and western Europe; they are edited by Kirchhoff, Köhler, Dittenberger, Fränkel, Hiller von Gaertringen, Kaibel and others. Of a similar Austrian publication dealing with Asia Minor (*Tituli Asiae Minoris*) only the first part (Lycian inscriptions) has appeared. Of general collections of inscriptions on a smaller scale it is necessary to mention: Dittenberger, *Sylloge Inscriptionum Graec.* (2nd ed., 1898-1901, 3 vols.); the same, *Oriens Graecum Inscr. Selectae* (2 vols., 1893-1905); Hicks, *Greek Historical Inscriptions* (1st ed., 1882; 2nd ed., 1901); Michel, *Recueil d'inscriptions grecques* (1900); Roberts and Gardner, *Introduct. to Gk. Epigraphy* (2 vols., 1887-1905); Röhl, *Inscr. gr. antiquissimae* (1882), and *Imagines Inscriptionum* (2nd ed., 1898).

The oldest extant Greek inscriptions appear to date from the middle of the 7th century B.C. During the excavations at

Olympia a number of fragments of very ancient inscriptions were found (see *Olympia, Textband v.*); and other very early inscriptions from various places, as

Thera and Crete, have been published (see Röhl, *op. cit.*).

But what is wanted is a sufficient number of very early inscriptions of fixed date. One such exists upon the leg of a colossal Egyptian statue at Abu-Simbel on the upper Nile, where certain Greek mercenaries in the service of King Psammetichus recorded their names, as having explored the river up to the second cataract (*C.I.G.* 5126; Röhl, 482; Hicks<sup>2</sup>, 3). Even if Psammetichus II. is meant, the inscription dates between 594 and 580 B.C. Another, but later, instance is to be found in the fragmentary inscriptions on the columns dedicated by Croesus in the Ephesian temple (c. 550 B.C.; *Gk. Inscr. in the Brit. Mus.* 518). Documents earlier than the Persian War are not very frequent; but after that period the stream of Greek inscriptions goes on, generally increasing in volume, down to late Byzantine times.

Greek inscriptions may most conveniently be classified under the following heads: (1) those which illustrate political history; (2) those connected with religion; (3) those of a private character.

1 Foremost among the inscriptions which illustrate Greek history and politics are the decrees of senate and people (*νόμοισινα βουλήσιν, ἐκθέσεις, &c.*) upon every subject which could concern the interests of the state. These abound from every part of Greece. It is true that a large number of them are honorary, i.e. merely decrees granting to strangers, who have done service to the particular city, public honours (crowns, statues, citizenship and other privileges). One of these privileges

was the *proxenia*, an honour which entailed on the recipient the burthen of protecting the citizens of the state which granted it when they came to his city. But the importance of an honorary decree depends upon the individual and the services to which it refers. And even the mere headings and datings of the decrees from various states afford curious and valuable information upon the names and titles of the local magistrates, the names of months and other details. On the formulae, see Swoboda, *Die gr. Volksbeschlüsse* (1890). Droysen in his *Hellenismus* (1877-1878) has shown how the history of Alexander and his successors is illustrated by contemporary *νόμοισινα*. And when the student of Athenian politics of the 5th and 4th centuries turns to the 1st and 2nd volumes of the *I.G.*, he may wonder at the abundance of material before him; it is like turning over the minutes of the Athenian parliament. One example out of many must suffice.—No. 17 in *I.G.* ii. pt. 1 (Hicks<sup>2</sup>, 101) is the famous decree of the archonship of Nausiclus (378 B.C.) concerning the reconstruction of the Athenian confederacy. The terms of admission to the league occupy the face of the marble; at the bottom and on the left edge are inscribed the names of states which had already joined.

Inscribed laws (*νόμοισινα*) occur with tolerable frequency. The following are examples.—A citation of a law of Draco's from the *ἐπιγράμματα* of Solon's laws (*I.G.* i. 61; cf. Dittenberger, *Syll.*<sup>2</sup> 52); the Civil Codes of Gortyna (5th century, Daresse, &c., *Inscr. jurid.* gr. i. 352 ff.); a reassessment of the tribute payable by the Athenian allies in 425 B.C. (*I.G.* i. 37; Köhler *Urkunden und Untersuchungen zur Geschichte des delisch-attischen Bundes*, 1870, p. 63; Hicks<sup>2</sup>, 64); a law passed by the Amphictyonic council at Delphi, 380 B.C. (Boeckh, *C.I.G.* 688; *I.G.* ii. 545); law concerning Athenian weights and measures (Boeckh, *Staatshaush.* 3, 118; *I.G.* ii. 51); the decree of the futile summary law of Diocletian concerning the maximum prices for all articles sold throughout the empire (Mommson-Blümmner, *Der Maximaltarif des Diocletian*, 1893). For a collection of such legal documents, see Daresse, Haussoullier and Reinach, *Recueil des inscr. juridiques gr.* (1891-1898).

Besides the inscribed treaties previously referred to, we may instance the following:—between Athens and Chalcid in Bulgaria, 446 B.C. (*I.G.* suppl. vol. 77A); between Athens and Rhegium, 433 B.C. (Hicks<sup>2</sup>, 51); between Athens and Leontini, dated the same day as the preceding (*ibid.* 52); between Athens and Boeotia, 395 B.C. (*ibid.* 84); between Athens and Chalcis, 377 B.C. (*ibid.* 102); between Athens and Sparta, 271 B.C. (*I.G.* ii. No. 532); between Hermias of Atarneus and the Ionian Erythrae, about 350 B.C. (Hicks<sup>2</sup>, 138); treaties in the local dialect between the Eleans and the Argives (*ibid.* 139); treaties between the confederating states, e.g. Rhodian award cities of Crete, 3rd century B.C. (*C.I.G.* 2554-2556; *Griech. Dial. Inscr.* 5039-5041, 5075). Eger's *Études historiques sur les traités publics chez les Grecs et chez les Romains* (Paris, 1866) embraces a good many of these documents; see also R. von Scola, *Die Staatsverträge des Altertums*, pt. i. (1898).

The international relation of Greek cities is further illustrated by awards of disputed lands, delivered by a third city called in (*ἐκδοχῶν πόλις*) to arbitrate between the contending states, e.g. Rhodian award as between Samos and Priene (*Gk. Inscr. in Brit. Mus.* 405; Dittenberger, *Syll.*<sup>2</sup> 315); Milesian between Messanians and Spartans, discovered at Olympia (*ibid.* 314; see Tac. *Ann.* iv. 43); and many others. Akin to these are decrees in honour of judges called in from a neutral city to try suits between citizens which were complicated by political partiality (see *C.I.G.* No. 23498, with Boeckh's remarks; *I.G.* xii. 722). On the general subject, E. Sonne, *De arbitris extraneis* (1888).

Letters from kings are frequent; as from Darius I. to the satrap Gadates, with reference to the shrine of Apollo at Magnesia (Hicks<sup>2</sup>, 20); from Alexander the Great to the Chians (*ibid.* 158); from Lysimachus to the Samians (*C.I.G.* 2254; Hicks<sup>2</sup>, 152); from Antigonus I. directing the transfer of the population of Lebedus to Teos (Dittenberger, *Syll.*<sup>2</sup> 177); from the same to the Scopians (Dittenberger, *Or. Inscr. Sel.* 5). Letters from Roman emperors are commoner still; such as Dittenberger, *Syll.*<sup>2</sup> 350, 356, 373, 384-388, 404.

The internal administration of Greek towns is illustrated by the minute and complete lists of the treasures in the Parthenon of the time of the Peloponnesian War (Boeckh, *Staatshaush.*<sup>3</sup> vol. ii.); public accounts of Athenian expenditure (*ibid.*); records of the Athenian navy in the 4th century, forming vol. iii. of the 1840 ed. Athenian tribute lists which are really lists of the quota (of the tribute paid by the Athenian allies) which was due to the treasury of Athens (*ἀναρχαὶ τῆ θωπῶν καὶ ἀπὸ ἑλλήνων*). Being arranged according to the tributary cities, they throw much light on the constitution of the Athenian empire at the time (*I.G.* i. 226-272 and suppl. p. 71 f.; Köhler, *Urkunden und Untersuchungen zur Gesch. des attisch-delischen Seebundes* 1870; Boeckh, *Staatshaush.*<sup>3</sup> ii. 332-398). The management of public funds and the mint is specially illustrated by inscriptions (Boeckh, *op. cit.* vol. i. *passim*); and the political constitution of different cities often receives light from inscriptions which cannot be gained elsewhere (e.g. see the document from Cyzicus, *C.I.G.* 3665, and Boeckh's note, or that from Mytilene, Dittenberger, *Or. Inscr.* 2, and the inscriptions from Ephesus, *Gk. Inscr. in Brit. Mus.* pt. iii. § 2).

Inscriptions in honour of kings and emperors are very common. The *Marmor Ancremarum* (ed. Mommsen,† 1883) has already been mentioned; but an earlier example is the *Monumentum Aulidianum* (from Abyssinia, C.I.G. 5127A); Dittenberger, (*Inscr. or. Gr.* 54) reciting the achievements of Ptolemy III. Euergetes I.

Offerings in temples (*ἀσθεῖα*) are often of great historical value, e.g. the dedications on the columns of Croesus at Ephesus mentioned above, Gelo's temple at Olympia (1473); and the temple of Hiero, now in the British Museum, dedicated at Olympia after his victory over the Etruscans, 474 B.C. (C.I.G. 16; Hicks' 22); and the bronze base of the golden tripod dedicated at Delphi after the victory of Plataea, and carried off to Constantinople by Constantine (Dethier and Mordtmann, *Epigraphik von Byzanzion*, 1874; Hicks' 19).

2. The religion of Greece in its external aspects is the subject of a great number of inscriptions (good selections in Dittenberger, *Syll.* 550-816, and Michel 660-1330). The following are a few specimens. (1) Institution of festivals, with elaborate ritual directions; see Sauppe, *Die Mysterieninschriften aus Andania* (1860); Dittenberger, *Syll.* 653, and the singular document from the Ephesian theatre in *Gk. Inscr. in Brit. Mus.* 481; the following also relate to festivals—C.I.G. 1845, 2360, 2715, 3059, 3599, 3641b; Dittenberger, *Syll.* 634 (the lesser Panathenaea) and *Or. Gr. Inscr.* 383 (law of Antiochus I. of Commagene).

(2) Laws defining the appointment, duties or perquisites of the priesthood: Dittenberger, *Syll.* 601; Boeckh, *Staatsbuch.* ii. 109 seq. (3) Curious calendar of sacrifices from Myconus: Dittenberger, *Syll.* 615. (4) Fragment of augury rules, Ephesus, 6th century B.C.; *Ibid.* 803. (5) Laws about andracted lands (C.I.G. 1845, 2360, 2715, 3059, 3599, 3641b; Dittenberger, *Syll.* 634 (the lesser Panathenaea) and *Or. Gr. Inscr.* 383 (law of Antiochus I. of Commagene)).

(6) Impressions written on lead, and placed in tombs or in temples: Wünsch, *I.G.* iii. App.; Audoulet *Defixionum tabellae* (1904). (7) Oracles are referred to *I.G.* xii. 248; Michel 840-856. (8) Among the inscriptions from Delphi few are more curious than those relating to the enfranchisement of slaves under the form of sale to a god (see *Gr. dial. Inscr.* nos. 1684-2342; for enfranchisement of inscriptions of various kinds, Dareste, &c., *Inscr. jur. Gr.* 11-228, 835, 853).

(9) Inscriptions relating to dramatic representations at public festivals: A. Wilhelm, *Urkunden dramatischer Aufführungen in Athen* (Vienna, 1906). This catalogue might be enlarged indefinitely.

3. There remain a large number of inscriptions of a more strictly private character. The famous Parian marble (*I.G.* xii. 444) falls under this head; it was a system of chronology drawn up, perhaps by a schoolmaster, in the 3rd century B.C.

The excessive devotion of the later Greeks to athletic and other competitions at festivals is revealed by the numerous dedications made by victorious competitors who record their successes (see Michel 915-960; Dittenberger, *Syll.* 683 f.). The dedications and honorary inscriptions relating to the Ephebi of later Athens (which occupy half of *I.G.* iii. pt. 1), dreary as they seem, have yet thrown a curious light upon the academic life of Roman Athens (see A. Dumont, *Essai sur l'éphébie antique*; Rei, *act. Trait.* pp. 408-418; Roberts and Gardner ii. 145); and from these and similar late inscriptions the attempt has been made to construct *Fasts* of the later archons (von Schöffer in Pauly-Wissowa, *Realencyclopädie*, s.v. "Archontes"; W. S. Ferguson in *Cornell Studies*, x).

The sepulchral monuments have been beautifully illustrated in Stackelberg's *Gräber der Hellenen*; for the Attic stelae see Conze, *Die attischen Grabreliefs* (1893 f.). Some of the most interesting epitaphs in the C.I.G. are from Aphrodisias and Smyrna. Kumanudis's collection of Attic epitaphs has been mentioned above; see also Gutschet, *Die attischen Grabschr.* (1889); they yield a good deal of information about the Attic demes, and some of them are of high importance, e.g. the epitaph on the slain in the year 458 B.C. (Dittenberger, *Syll.* 683), and the epitaph on the eldest son of C. 440 B.C. (Hicks' 46), or the metrical inscriptions see Kiebel, *Epigrammata Graeca* (1878). Closely connected with sepulchral inscriptions is the famous "Will of Epicteta" (*I.G.* xii. 330). It was also customary at Athens for lands mortgaged to be indicated by boundary-stones inscribed with the names of mortgagor and mortgagee, and the amount (*I.G.* ii. 1103-1153; Dareste, &c., *Inscr. jur. l.* pp. 107-142); and other *δδοι* are common enough.

The names of sculptors inscribed on the bases of statues have been collected by E. Löwy (*Inscriptionen Gr. Bildhauer*, 1885). In most cases the artists are unknown to fame. Among the exceptions are the names of Pythagoras of Rhegium, whom we now know to have been a native of Samos (Löwy 23, 24); Pyrrhus, who made the statue of Athena Hygieia dedicated by Pericles (*Plut. Per.* 13; Löwy 53); Polyclitus the younger (Löwy 90 f.), Paeonius of Mende, who sculptured the marble Nike at Olympia (Löwy 49); Praxiteles (Löwy 76), &c.

The bearing of inscriptions upon the study of dialects is very obvious. A handy selection has been made by Cauer (*Delectus inscr.* Gr. 2nd ed., Leipzig, 1883) of the principal inscriptions illustrating this subject, along with a collection of the collection is in course of publication (Collitz and others, *Sammlung der griechischen Dialekt-Inschriften*, Göttingen, 1884 f.).

See also R. Meister, *Die griech. Dialekte* (1882-1886), and O. Hoffman, *Die griech. Dialekte* (1891-1898). The grammar of Attic inscriptions

is treated by Meisterhans, *Grammatik der att. Inscr.* (3rd ed. by Schwyzler, 1900).

The date of inscriptions is determined partly by the internal evidence of the subject, persons, and events treated of, and the character of the dialect and language. But the most important evidence is the form of the letters and style of execution. For the Attic inscriptions the development from the earliest times to about A.D. 500 is elaborately treated by Larfeld, *Handbuch der att. Inscr.* (1902), bk. ii. Much of the evidence is of a kind difficult to appreciate by mere description. Yet—besides the *βονητογράφον* writing of many early documents—we may mention the contrast between the stiff, angular characters which prevailed before 500 or 450 B.C. and the graceful yet simple forms of the Periclean age. This development was part of the general movement of the time. Inscriptions of this period are usually written *στρογγύλον*, i.e. the letters are in line vertically as well as horizontally. From the archonship of Euclides (403 B.C.) onwards the Athenians officially adopted the fuller alphabet which had obtained in Ionia since the 6th century. Before 403 B.C. ε and ψ were expressed in Attic inscriptions by Ξ and ΦΞ, while Ε did duty for η, ε, and sometimes α, Ο for ο, ο, and ω—H being used for the aspirate. There is, however, occasional use of the Ionic alphabet in Attica, even in official inscriptions, as early as the middle of the 5th century. The Macedonian period betrays a falling off in neatness and firmness of execution—the letters being usually small and scratchy, excepting in inscriptions relating to a great personage, when the characters are very large and have isolated forms. In the 2nd century came in the regular use of *apices* as an ornament of letters. These tendencies increased during the period of Roman dominion in Greece, and gradually, especially in Asia Minor, the *iota adscriptum* was dropped. The Greek characters of the Augustan age indicate a period of restoration; they are uniformly clear, handsome, and adorned with *apices*. The lunate epsilon and sigma (ε, σ) establish themselves in this period; so does the square form τ, and the cursive ω is also occasionally found. The inscriptions of Hadrian's time show a tendency to eclectic imitation of the classical lettering. But from the period of the Antonines (when we find a good many pretty inscriptions) the writing grows more coarse and clumsy until Byzantine times, when the forms appear barbarous indeed beside an inscription of the Augustan or even Antonine age.

The finest collections of inscribed Greek marbles are of course at Athens. There are also good collections, public and private, at Smyrna and Constantinople. The British Museum contains the best collection out of Athens (see the publication mentioned above); the Louvre contains a good many (edited by Fröhner, *Les Inscriptions grecques du musée de Louvre*, 1862; Oxford collection is very valuable, and fairly large; and there are some valuable inscriptions also at Cambridge).

**BIBLIOGRAPHY.**—The following essays give good outlines of the whole subject:—Boeckh, *C.I.G.*, preface to vol. i.; C. T. Newton, *Essays on Art and Archaeology* (1880), pp. 95, 209; S. Reinach, *Traité d'épigraphie grecque* (Paris, 1885). Besides the works already quoted the following should be mentioned:—Boeckh's *Kleine Schriften*; Michaelis, *Der Parthenon*; Waddington, *Fastes des provinces asiatiques*, part i. (1872), and *Mémoire sur la chronologie de la vie du rhéteur Aristide*; Kirchhoff, *Studien zur Geschichte des griechischen Alphabets* (4th ed. 1887); Schulbert, *De proemia* (Leipzig, 1881); Monceaux, *Les Proxénètes* (Paris, 1886); Latyshev, *Inscr. ant. ora septentr. Ponti Euxini Gr. et Lat.* (2 vols., St. Petersburg, 1885-1890); Bechtel, *Inscriften des ionischen Dialekts* (Göttingen, 1887); Paton and Hicks, *Inscriptions of Cos* (Oxford, 1891); Fränkel and others, *Inscriften von Pergamon* (2 vols., Berlin 1890-1895); Compagetti, *Le leggi di Gortyna*, &c. (*Monum. antich. iii.*, 1893); E. Hoffmann, *Sylloge epigrammatum Graec.* (Halle a. S., 1893); O. Kern, *Inscriften von Magnesia am Maeander* (Berlin, 1899); S. Chabouy, *Recherches sommaires des études d'épigraphie grecque* (Paris, 1906); Hackl, *Merkanthile Inscr. auf attischen Vasen* (*Münch. arch. Stud.*, 1909); Wilhelm, *Beiträge zur griech. Inscriftenkunde* (Vienna, 1909). (E. L. H.; G. F. H.)\*

**COLLECTIONS OF MARBLES.**

The finest collections of inscribed Greek marbles are of course at Athens. There are also good collections, public and private, at Smyrna and Constantinople. The British Museum contains the best collection out of Athens (see the publication mentioned above); the Louvre contains a good many (edited by Fröhner, *Les Inscriptions grecques du musée de Louvre*, 1862; Oxford collection is very valuable, and fairly large; and there are some valuable inscriptions also at Cambridge).

**BIBLIOGRAPHY.**—The following essays give good outlines of the whole subject:—Boeckh, *C.I.G.*, preface to vol. i.; C. T. Newton, *Essays on Art and Archaeology* (1880), pp. 95, 209; S. Reinach, *Traité d'épigraphie grecque* (Paris, 1885). Besides the works already quoted the following should be mentioned:—Boeckh's *Kleine Schriften*; Michaelis, *Der Parthenon*; Waddington, *Fastes des provinces asiatiques*, part i. (1872), and *Mémoire sur la chronologie de la vie du rhéteur Aristide*; Kirchhoff, *Studien zur Geschichte des griechischen Alphabets* (4th ed. 1887); Schulbert, *De proemia* (Leipzig, 1881); Monceaux, *Les Proxénètes* (Paris, 1886); Latyshev, *Inscr. ant. ora septentr. Ponti Euxini Gr. et Lat.* (2 vols., St. Petersburg, 1885-1890); Bechtel, *Inscriften des ionischen Dialekts* (Göttingen, 1887); Paton and Hicks, *Inscriptions of Cos* (Oxford, 1891); Fränkel and others, *Inscriften von Pergamon* (2 vols., Berlin 1890-1895); Compagetti, *Le leggi di Gortyna*, &c. (*Monum. antich. iii.*, 1893); E. Hoffmann, *Sylloge epigrammatum Graec.* (Halle a. S., 1893); O. Kern, *Inscriften von Magnesia am Maeander* (Berlin, 1899); S. Chabouy, *Recherches sommaires des études d'épigraphie grecque* (Paris, 1906); Hackl, *Merkanthile Inscr. auf attischen Vasen* (*Münch. arch. Stud.*, 1909); Wilhelm, *Beiträge zur griech. Inscriftenkunde* (Vienna, 1909). (E. L. H.; G. F. H.)\*

**COLLECTIONS OF MARBLES.**

The finest collections of inscribed Greek marbles are of course at Athens. There are also good collections, public and private, at Smyrna and Constantinople. The British Museum contains the best collection out of Athens (see the publication mentioned above); the Louvre contains a good many (edited by Fröhner, *Les Inscriptions grecques du musée de Louvre*, 1862; Oxford collection is very valuable, and fairly large; and there are some valuable inscriptions also at Cambridge).

**BIBLIOGRAPHY.**—The following essays give good outlines of the whole subject:—Boeckh, *C.I.G.*, preface to vol. i.; C. T. Newton, *Essays on Art and Archaeology* (1880), pp. 95, 209; S. Reinach, *Traité d'épigraphie grecque* (Paris, 1885). Besides the works already quoted the following should be mentioned:—Boeckh's *Kleine Schriften*; Michaelis, *Der Parthenon*; Waddington, *Fastes des provinces asiatiques*, part i. (1872), and *Mémoire sur la chronologie de la vie du rhéteur Aristide*; Kirchhoff, *Studien zur Geschichte des griechischen Alphabets* (4th ed. 1887); Schulbert, *De proemia* (Leipzig, 1881); Monceaux, *Les Proxénètes* (Paris, 1886); Latyshev, *Inscr. ant. ora septentr. Ponti Euxini Gr. et Lat.* (2 vols., St. Petersburg, 1885-1890); Bechtel, *Inscriften des ionischen Dialekts* (Göttingen, 1887); Paton and Hicks, *Inscriptions of Cos* (Oxford, 1891); Fränkel and others, *Inscriften von Pergamon* (2 vols., Berlin 1890-1895); Compagetti, *Le leggi di Gortyna*, &c. (*Monum. antich. iii.*, 1893); E. Hoffmann, *Sylloge epigrammatum Graec.* (Halle a. S., 1893); O. Kern, *Inscriften von Magnesia am Maeander* (Berlin, 1899); S. Chabouy, *Recherches sommaires des études d'épigraphie grecque* (Paris, 1906); Hackl, *Merkanthile Inscr. auf attischen Vasen* (*Münch. arch. Stud.*, 1909); Wilhelm, *Beiträge zur griech. Inscriftenkunde* (Vienna, 1909). (E. L. H.; G. F. H.)\*

**COLLECTIONS OF MARBLES.**

I. Latin or Roman Inscriptions (by which general name are designated, in classical archaeology, all non-literary remains of the Latin language, with the exception of coins, letters and journals) fall into two distinct classes, viz. (1) those which were written upon other objects of various kinds, to denote their peculiar purpose, and in this way have been preserved along with them; and (2) those which themselves are the objects, written, to be durable, as a rule, on metal or stone. The first class is that of *inscriptions* in the stricter sense of the word (styled by the Romans *tituli*, by the Germans *Aufschriften*); the second is that of instruments or charters, public and private (styled by the Romans *first leges*, afterwards *instrumenta* or *labeula*, and by the Germans *Urkunden*).

No ancient Latin authors have professedly collected and explained or handed down to us Roman inscriptions. Some of

the orators and historians, such as Cicero, Livy, Pliny the elder, and Suetonius among the Latins, and Polybius, Dionysius of Halicarnassus and Josephus among the Greeks, occasionally mention inscriptions of high historical interest. A few grammarians, as, for example, Varro, Verrius Flaccus and Valerius Probus of Berytus, quote ancient words or *formulae* from them, or explain the abbreviations used in them. Juridical instruments, laws, constitutions of emperors, *senatus consulta* and the like appear in the various collections of Roman jurisprudence.

Inscriptions (in the wider sense, as we shall henceforth call them without regard to the distinction which has been drawn) have been found in nearly every centre of ancient Roman life, but, like many other remains of antiquity, only seldom in their original sites. The great mass of them has to be sought for in the large European museums of ancient art, and in the smaller local collections of ancient remains which occur nearly everywhere in the European provinces of the former Roman empire as well as in the north of Africa, and also here and there in Asia Minor.

Only those copies of inscriptions are to be received with full confidence which are furnished by experienced and well-equipped scholars, or which have been made with the help of mechanical methods (casts, photographs, moist and dry rubbings), not always applicable with equal success, but depending on the position and the state of preservation of the monuments.<sup>1</sup> From the first revival of classical learning in the Carolingian age attention was paid anew, by pilgrims to Rome and other places worth visiting, to epigraphic monuments also. In the time of the Renaissance, from the end of the 14th century downwards, some of the leading Italian scholars, like Poggio and Signorilli, and the antiquarian traveller Cyriacus of Ancona, collected inscriptions, Greek and Latin.<sup>2</sup> In the 15th century large collections of the inscriptions of all countries, or of limited districts, were made by Giovanni Marcanova, Fra Felice Feliciano, Fra Michele Ferrarino, Fra Giocondo the architect of Verona, Marino Sanudo the Venetian polyhistor, and others. At the end of the 15th and the beginning of the 16th, the first printed collections can be recorded (Spreti's for Ravenna, 1489; Peuting'er's for Augsburg, 1508; Huttich's for Mainz, 1520; Francesco degli Albertini's for Rome, printed in 1521 by Jacopo Mazochi), while during the same century a long list of epigraphic travellers, like Pighius, Rambertus and Accursus, or antiquarian collectors, like Sigonius, Panvinius, Antonius Augustinus with his collaborators Ursinus and Metellus, and many others, were busy in augmenting the stock of epigraphic monuments. The series of printed epigraphic *Corpora* begins with that of Apianus (Ingolstadt, 1534), the only one arranged in geographical order, and is continued in those of Smetius (1558, but edited only after the author's death by Justus Lipsius, 1588), Gruter (with Joseph Scaliger's *Indices*, 1603, and re-edited by Graevius, 1707), Gudian (about 1660, edited by Hessel, 1731), Reinesius (1682), Fabretti (1699), Gori (1726), Doni (1731), Muratori (1739), Maffei (1749), Donati (1765-1775). These collections, manuscript and printed, will never altogether lose their value, as great numbers of inscriptions known to the ancient collectors have since been lost or destroyed. But, inasmuch as even towards the beginning of the 15th century, as well as afterwards, especially from the 16th down to a very recent period, all sorts of inaccuracies, interpolations and even downright falsifications, found their way into the *Corpora*, these can be employed only with the greatest caution. Modern critical research in the field of epigraphy began with the detection of those forgeries (especially of the very extensive and skillful ones of Pirro Ligorio, the architect to the house of Este) by Maffei, Olivieri and Marini. The last-named scholar opens a new era of truly critical and scientific handling of Roman inscriptions (especially in his standard work on the *Atti dei fratelli arvali*, Rome, 1705); his disciple and successor, Count Bartolomeo Borghesi (who died at San Marino in 1860), may be rightly called the founder of the modern science of Roman

epigraphy.<sup>3</sup> Orelli's handy collection of Roman inscriptions (2 vols., Zurich, 1828) is a first attempt to make accessible to a larger scientific public the results of the researches of Marini and his successors; but it was not completed (and thoroughly corrected) until nearly thirty years later, by Henzen (Orelli, iii., with the indispensable *Indices*, Zurich, 1856), who, with Mommsen and De Rossi, carried out the plan of a universal *Corpus inscriptionum Latinarum*, previously projected by Maffei (1732), by Kellermann and Sarti (1832), with Borghesi's help, and by Letronne and Egger (1843). After the appearance of Mommsen's *Inscriptiones regni Neapolitani Latinae* (Leipzig, 1852) and his *Inscriptiones confederationis Helveticae Latinae* (vol. x. of the publications of the Zurich Antiquarian Society, 1854), the publication of the *C.I.L.*, following the similar work of the Greek inscriptions, was undertaken by the Royal Academy of Sciences of Berlin.

This work, in which the previous literature is fully described and utilized, consists of the following parts:—vol. i., *Inscriptiones antiquissimae a C. Caesaris morte* (1863; 2nd ed., part i., 1893); Ritschl's *Priscae Latinitatis monumenta epigraphica* (Berlin, 1862, fol.) form the graphic illustration to vol. i., giving all extant monuments of the republican epoch (with five *Supplementa*, Bonn, 1862-1865; B. Garrucci's *Syllage inscriptionum Latinarum aevi Romani reipublicae aequae ad C. Iulium Caesarem ultimum*, 2 vols., Turin, 1875-1877, must be used with caution); vol. ii., *Inscr. Hispaniae* (1869; with Supplement, 1892); vol. iii., *Inscr. Asiae, provinciarum Europae Graecarum, Illyrici* (1873; with Supplements and Index, 1889-1902); vol. iv., *Inscr. patriariae Pompeianae Heracleenses Stabianae* (the scratched and painted inscriptions chiefly of Pompeii) (1871; with Supplement, part i., 1898; part ii., 1909); vol. v., *Inscr. Galliae cisalpinae* (1872-1877; with Suppl., Et. Pais, *C.I.L. suppl. Italica*); vol. vi., *Inscr. urbis Romae* (1876-1902; with Supplement, 1902); vol. vii., *Inscr. Britanniae* (1873); vol. viii., *Inscr. Africae* (1881; with Supplement, 1891-1894, 1904); vol. ix., *Inscr. Calabriae, Apuliae, Samnii, Sabinorum, Piceni* (1883); vol. x., *Inscr. Bruttiorum, Lucaniae, Campaniae, Siciliae, Sardiniae* (vol. xi., *Inscr. Aemiliae, Umbriae, Etruriae* 1888; part ii., 1901 sqq.); vol. xii., *Inscr. Galliae Narbonensis* (1888); vol. xiii., *Inscr. trium Galliarum et duarum Germaniarum* (1899 sqq.; part ii., 1905 sqq.); vol. xiv., *Inscr. Latii antiqui*; vol. xv., *Inscr. laterum* (1891) (part ii., *Insulae, lucernae, fistulae*, 1899). The arrangement observed in the *Corpus* is the geographical (as in Apianus); within the single towns the order of subjects (*tituli sacri, magistraturum, privatorum*, &c., as in Smetius) is followed, with some few exceptions, where the monuments are so numerous (as in the *forum* of Rome and at Pompeii and Lambaese) that they can be assigned to their original places. Running supplements to the *C.I.L.* are given in the *Ephemeris epigraphica*, *Corporis Inscr. Latinarum supplementum* (Berlin, 1872 sqq.); and the new discoveries of each year are recorded in Cagnat's *L'Année épigraphique*.

The inscriptions in the other Italian dialects have been published by Conway, *Italic Dialects* (Cambridge, 1897); cf. vol. ii. of von Planta, *Grammatik der oshisch-umbrischen Dialekte* (Strassburg, 1897). A *Corpus* of the Etruscan inscriptions was begun in 1893 by Pauli and is now nearly complete. The inscriptions of the Veneti, a N. Italian people of the Illyrian stock, will be found in vol. iii. of Pauli, *Altitalische Forschungen* (Leipzig, 1891). For the Christian inscriptions see De Rossi's *Inscr. Christianae urbis Romae septimo saeculo antiquiores*, vol. i. (Rome, 1857), vol. ii. (1888); the *Inscriptions chrétiennes de la Gaule de Le Blanc* (2 vols., Paris, 1857-1865; new edition, 1892); the *Altchristliche Inschriften der Rheinlande* of Kraus (1890); the *Christliche Inschriften der Schweiz vom IV.-IX. Jahrhundert* of Egli (1895); and the *Inscr. Hispaniae Christianae* and *Inscr. Britanniae Christianae* of Hübnér (Berlin, 1871, 1876). As splendidly illustrated works on the Latin inscriptions of some districts Alphonse de Boissieu's *Inscriptiones antiquae de Lyon* (Lyons, 1846-1854), Ch. Robert's *Épigraphie romaine de la Moselle* (Paris, 1875), and J. C. Bruce's *Lapidarium septentrionale* (London, 1875) may be recommended. Besides the above-mentioned Orelli-Henzen collection, G. Wilmanns's *Exempla inscriptionum Latinarum* (2 vols., Berlin, 1873, with copious indexes), and Dessau's *Inscriptiones Latinae selectae* (vol. i., 1892; vol. ii., 1903; iii., 1906) give a general synopsis of the materials. Inscriptions of interest to students of history are collected in Rushforth's *Latin Historical Inscriptions* (Oxford, 1893); Leroux, *Revue des publications épigraphiques relatives à l'antiquité romaine*, records those which bear on antiquities. Of other works may be mentioned Ruggiero, *Dizionario epigraphico di antichità romane* (1886); Olcott, *Thesaurus linguae Latinae epigraphicae* (1904 sqq.).

II. Information regarding the forms of letters used on Roman inscriptions will be found under the articles LATIN LANGUAGE, PALAEOGRAPHY AND WRITING (cf. Hübnér, *Exempla scripturae*

<sup>1</sup> See E. Hübner, *Über mechanische Copieen von Inschriften* (Berlin, 1881).

<sup>2</sup> Compare De Rossi, *Bullettino dell' Instituto archeologico* (1871), p. 1 sqq.

<sup>3</sup> His works have been published by the French government in several volumes 4to (Paris, 1862 sqq.).

*epigraphicae Latinae*, 1895). The forms of the single letters vary not inconsiderably according to the material of the monuments, their age and their origin. Carefully cut letters, especially when on a large scale, naturally differ from those scratched or painted on walls by non-professional hands, or hewn on rocks by soldiers; and small incised (or dotted) letters on metal or ivory and bone, and those painted on earthenware, or impressed on it or on glass before burning, are also necessarily of a different character. The letters, ordinarily drawn with *minium* on the monument before being cut (and also often painted, after having been cut, with the same colour), sometimes have been painted with a brush, and thence receive a peculiar form. To save space, on coins first and afterwards in inscriptions also, two or three or even more letters were joined, especially at the end of the lines, to a *nexus* or a *ligatura*. This system of compendious writing, very rare in the republican epoch, and slowly extending itself during the 1st century, became rather frequent in the 2nd and 3rd, especially in Spain and Africa. There is no constant system in these *nexus litterarum*, but generally the rule is observed that no substantial element of a single letter is to be counted for twice (thus e.g.  $\ddot{\text{t}}$  is *tt* or *ll*, not *tttt*). Numerals are usually distinguished from letters in the ancient period, down to the end of the republic, by a stroke drawn through them, as in  $\text{†VIR}$ ,  $\text{duo(m) vir(om)}$   $\text{†S duo semis}$  (*aesterius*),  $\text{†500}$ ; it was afterwards put above them, as in  $\text{IIVIR}$ ,  $\text{XVIR}$ ,  $\text{IIMIVIR}$ ,  $\text{duovir}$ ,  $\text{decemvir}$ ,  $\text{scvir}$ .<sup>1</sup>

The direction of the writing is in the very oldest inscriptions from right to left and from left to right in alternate lines, an arrangement technically called  $\beta\omicron\upsilon\sigma\tau\omicron\phi\omicron\theta\omicron\upsilon\beta$  (D. Comparetti, *Iscrizione arcaica del Foro Romano*, Florence, 1900; H. Jordan, *Hermes*, vol. xv. p. 5, 1880), and in the Sabellic inscriptions similar arrangements are not infrequent. In all others it is from left to right. Each word is separated from the other by a sign of interpunction, which is not wanted, therefore, at the end of lines or of the whole text. Exceptions to this rule occur only in the later period (from the 2nd century downwards), and sometimes under special conditions, as when abridged words form the end of the line. Here and there even the different syllables of each word are separated by interpunction. The interpunction is formed by a single dot (except in some very ancient inscriptions, such as the recently found Forum inscription of the regal period and those of Pisaurum, where, as in Greek and other Italian monuments, three dots : are used). According to the technical skill of the different periods in stone-cutting this dot is in some very ancient inscriptions quadrangular, or similar to an oblique cross (X), or oblong (as a bold stroke), but, as a rule, triangular, and never circular. This triangular dot changes, by ornamentation, into a hook (Z) or a leaf (P); the ivy-leaf-shaped dot is especially frequent in inscriptions from about the 2nd century downwards. The dot is always placed at the middle height of the letters, not, as now, at the foot of the line. In large texts of instruments the interpunction is often omitted; in the later period it is often entirely wanting; and in short texts, in the disposition of the lines, in the varying sizes of the letters employed, in the division of words at the end of the lines, &c., certain rules are observed, which cannot be detailed here. In some instances older inscriptions have been cancelled and more recent ones substituted (e.g. on milestones), especially in the case of the *damnatio memoriae* (in cases of high treason), in consequence of which the names of consuls and emperors are often cancelled; but in modern times also inscriptions have been deliberately destroyed or lost ones restored.

For understanding the texts of the inscriptions an accurate knowledge of the system of abbreviations used in them is necessary (see Cagnat, *Cours d'Épigraphie latine*, 3rd ed., 1898). These are almost invariably *litterae singulares*; that is to say, the initial letter is employed for the entire word (in all its grammatical forms), or if one initial, as belonging to more than one word, is not sufficiently clear, the first two or even the first three letters are employed; rarely more than three. Abbrevia-

tions in the true sense of the word (by dropping some letters at the end) are to be found, in the older period, only at the end of lines, and not frequently. In the later period some instances of them have been observed. The *litterae singulares*, as Valerius Probus taught, are either generally employed (*usus generalis*) in all classes of written documents (and so in literature also), as, for instance, those of the individual names (the *praenomina*), the names of days and feasts (*kal. for kalendae*), and those of the chief magistrates (*cos. for consuls*) and the like; or they belong chiefly (but not exclusively) to certain classes of documents, such as those used in juridical acts (*l. for lex, h. for heres, s. d. m. for sine dolo malo, and so on*), in sepulchral inscriptions (*h. s. e., hic situs est*) or in dedicatory inscriptions (*v. s. l. m., votum solviti libens merito*), &c.<sup>2</sup>

It may be observed here that the *praenomina* are, as a rule, always written in the universally known abbreviations (in the few instances where they are written in full it is a consequence of Greek influence or of peculiar circumstances). The *gentilia* in *-us* are abridged, in the republican period, in *-i* (in the nominative, perhaps for *-is*). In the always abbreviated indications of ancestors or patrons (in the case of slaves and freedmen), as *C. J., Gaius filius, M. L., Marci libertus* (s. for *servus* is not frequent), the feminine gender is sometimes indicated by inversion of the letters. Thus  $\text{O. L.}$  (or *lib.*) or  $\text{W}$  (an inverted *M*) *l.* designates a *mulieris libertas*;  $\text{?}$  and  $\text{?}$  are used for *filia*, *pupilla*. On the *tribus* and their abbreviations, and on the so-called military *tribus* (which are names of colonies allocated, for the sake of symmetry, at the place usually occupied, in the nomenclature, by the *tribus*), and on the other indications of origin used in the designation of individuals, the indexes to the above-named works give sufficient information; on the geographical distribution of the *tribus* see Grotefend's *Imperium Romanum tributum descriptum* (Hanover, 1863). For the abbreviations of official charges, urban and municipal, and, in the imperial period, civil and military (to which, beginning with the 4th century, some Christian designations are to be added), see also the explanations given in the indexes. Among these abbreviations the first instances are to be found of the indication of the plural number by doubling the last letter; thus *Augg., Caesss., coss., dd. nn.* (*domini nostri*), are used from the 3rd century downwards (see De Rossi's preface to the *Inscriptiones Christ. urbis Romae*) to distinguish them from *Aug., Caes.,* as designating the singular. In the later period, a dot or a stroke over the abridged word, like that upon numerals, here and there indicates the abbreviation.

III.—1. Among the inscriptions in the stricter sense (the *tituli*), perhaps the oldest, and certainly the most frequent, are the *sepulchral inscriptions* (*tituli sepulchrales*). Of the different forms of Roman tombs, partly depending upon the difference between burial and cremation, which were in use side by side, a very complete account is given in Marquardt's *Handbuch der römischen Altertümer* (vol. vii. part i., Leipzig, 1879, p. 330 seq.). The most ancient examples are those of a *sepulchrum* at Praeneste (*C.I.L.* i. 74, 165, 1501 a-d; *Ephem. epigr.* i. 25-131; *Wil.* 153); the oldest of these contain nothing but the name of the deceased in the nominative; those of more recent date give it in the genitive. The oldest and simplest form remained always in use down to Christian times: it is that used on the large tectonic monuments of the Augustan age (e.g. that of Caecilia Metella, *C.I.L.* vi. 1274) and in the *mausolea* of most of the emperors, and is still frequent in the *tituli* of the large *columbaria* of the same age (*C.I.L.* vi. part ii.). It was early succeeded by the lists of names, given also in the nominative, when more than one individual, either dead or alive, were to be indicated as sharers of a tomb. To distinguish the members still alive, a *v* (*vivus*, *vivi*) was prefixed to their names (e.g. *C.I.L.* l. 1020, 1195, 1277); the deceased were sometimes marked by the *obitus nigrum* (*C.I.L.* i. 1032; *Wil.* 158; see also *C.I.L.* vi. 10251 seq.). Only the names in the nominative are shown, too, on the *sarcophagi* of the *Turpelli* and *Fourii* at

<sup>2</sup> On the system of Roman nomenclature and the abbreviations employed in it see Cagnat's textbook, and for more detail Mommsen in *Römische Forschungen*, i. 1 seq. and in *Hermes*, iii. (1869), p. 70, W. Schulze, *Zur Geschichte lateinischen Eigennamen* (Berlin, 1904); on the *cognomina* (but only those occurring in ancient literature), Ellendt, *De cognomine et agnomine Romano* (Königsberg, 1853), and on the local *cognomina* of the Roman patriciate, Mommsen, *Röm. Forsch.* ii. 290 seq.; on the *nomen gentilitia*, Höbner (*Ephem. epigr.* ii. 25 seq.). The indexes to the works of Orelli, Wilmanns, and the volumes of the *Corpus* may also be consulted.

<sup>1</sup> For other details of numerical notation, fractions, &c., see the manuals of metrology.

Tusculum (C.I.L. i. 65-72; Wil. 152), and in the oldest inscriptions on those of the *Scipiones*, painted with *minium* (C.I.L. i. 29; Wil. 537), to which were added afterwards the insignia of the *magistratus curules* (C.I.L. i. 31; Wil. 538) and the poetical *elogia*. Of a somewhat different kind are the inscriptions scratched without much care on very simple earthen vessels which belonged to a *sepulchrum* of the lower class, situated outside the *porta Capena* at Rome, on the Appian road, near the old church of San Cesario (C.I.L. i. 882-1005, 1539, 1539 *a-d*-C.I.L. vi. 8211-8397; Wil. 176); they can be ascribed to the period of the Gracchi. On these *olla*, besides the name of the deceased, also for the most part in the nominative, but often the more rarely in the genitive, the date of a day, probably that of the death, is noted; here and there *obit (or a)* is added. About the same epoch, at the beginning of the 6th century, along with the growing taste for tectonic ornamentation of the tombs in the Greek style, poetical epigrams were added to the simple sepulchral *titulus*, especially amongst the half-Greek middle class rapidly increasing in Rome and Italy; Saturnian (C.I.L. i. 1006), iambic (1007-1010) and dactylic (1011) verses become more and more frequent in epitaphs (see Buecheler, *Anthologia Latina*, ii.). In prose also short designations of the mental qualities of the deceased (*homo bonus, misericors, amans pasperum, or uxor frugi, bona, pudica* and the like), short dialogues with the passer-by (originally borrowed from Greek *epigrammata*, see *satira*, *de die, in die, rogatus, pariteris dicas "si hic terra lenis,"* &c. (Wil. 180), then indications of his condition in his lifetime, chiefly among the Greek tradesmen and workmen, e.g. *Ianius de colle Vininale* (C.I.L. i. 1011), *margaritarius de sacra via* (1027) and the like, and some formulae, such as *ossa hie sita sunt, hie cubat, hie situs est* (in republican times mostly written in full, not abridged) were added (J. Church "Zur Phraseologie der lat. Grabinchriften" in *Arch. lat. Lexikogr.* 12. 215 sqq.). The habit of recording the measurement of the sepulchre, on the sepulchral *cippus*, by such formulae as *locus patet in fronte pedes tot, in agro (or in via, or retro) pedes tot*, seems not to be older than the Augustan age (C.I.L. i. 1021, with Mommsen's note; Wil. 188). About the same time also the epitaphs more frequently state how long the deceased lived, which was formerly added only on certain occasions (e.g. in the case of a premature death), and mostly in poetical form. The worship of the *dei Manes*, though undoubtedly very ancient, is not alluded to in the sepulchral inscriptions themselves until the close of the republic. Here and there, in this period, the tomb is designated as a (*locus*) *deum Manium* (e.g. at Hispellum, C.I.L. i. 1410); or, it is said, as on a *cippus* from Corduba in Spain (C.I.L. ii. 2255; Wil. 218), *C. Sentio Sat(ur)urno cor(n)u(n)s(ule)*—that is, in the year 19 B.C.—*dei Manes receperunt Abullium Numerium (I)bertam*) *Nigeliam*. In the Augustan age the *titulus sepulchralis* begins to be confounded with the *titulus sacer*; it adopts the form of *consecratio* or *consecratus* (e.g. *deus Manes, or dei infori Manes, the dei parentum* being the *Manes* of the parents of the deceased (see Orel. 4351; Wil. 217-228)). This formula, afterwards so common, is still very rare at the end of the republic, and is usually written in full, while in later times it is employed, both simply and in many varied forms (as *dis manibus sacrum, or d. m. et memoriae, d. m. et genio, or memoriae aeternae, paci et quieti, quieti aeternae, somno aeternali* and so on; Wil. 246), in thousands of monuments. By similar degrees the *titulus sepulchralis* adopts many of the elements of the *titulus honorarius* (the indication of the *cursum honorum*, of the military charges, &c., as e.g. in the inscription of Cn. Calpurnius Piso, C.I.L. i. 598-5 v. 1276, Wil. 1105, on the pyramid of Cestius, C.I.L. i. 1374, and on the monument at Ponte Lévato, P. Flavius Silvanus Aelianus, consul a. d. 74 Orel. 759, Wil. 114, and many others), of the *tituli operum publicorum* (e.g. *monumentum fecit, sibi et suis*, &c.), and of the *instrumenta*. Testaments (like those of Dasumius of the year A.D. 109—C.I.L. vi. 10229; Wil. 314; and T. Flavius Syntrophus—C.I.L. vi. 10239; Henz. 7321; Wil. 313), or parts of them (like that on the tomb of a Gaul of the tribe of the Lingones, belonging to Vespasian's time, Wil. 315), funeral orations (as those on Turia—C.I.L. vi. 1527; *Notizie degli scavi* (1898), p. 412; Hirschfeld, *Wiener Studien Bormannheft*, p. 283; Fowler, *Classical Review*, xix. 261; or Murda—C.I.L. vi. 10230; Orel. 4860; Rudolfi, *Abhandlungen der König. Akademie der Wissenschaften zu Berlin* (1868), p. 217, seq.), and that of Plautian on the elder Matidia, found at Tivoli—Mommsen in the same *Abhandlungen* (1863), p. 483 seq.; Dehner, *Laudatio Matidia*, Neuwied (1891), numerous statements relating to the construction and the employment of the monuments (C.I.L. vi. 10249; Wil. 287-290), to their remaining within the family of the deceased—from which came the frequent formula "*h(oc) monumentum (h)eredem (n)on (s)equetur*" and the like (Wil. 280; cf. Hor. Sat. i. 8. 13),—and relating to the annual celebration of *parentalia* (Wil. 305 seq.), down to the not uncommon prohibition of violation or profanation of the monument *noli violare*, &c., with many other particulars (on which the index of Vol. p. 678 seq. may be consulted), form the text of the sepulchral inscriptions of the later epoch from Augustus downwards. The thoroughly pagan sentiment *non fui non sum, curam, or n. f. n. s. n. s. n. s. n. s.* common, apparently a translation of the Greek *ὄχι ἦν, οὐκ ἔβην, ὄχι ἔβην, ὄχι ἔβην, ὄχι ἔβην*. Another type of epitaph, much affected by the poorer classes (like our "Affliction sore" &c.), is: *noli dolere mater eventum merum, Propreravit aetas, hoc voluit fatus (sic) mihi (Lier, "Topica carminum sepulchralium Latinorum" in *Philologus*, 62. 445 sqq.).*

To these are to be added many local peculiarities of provinces (as Spain and Africa), districts (as the much-disputed *sub aeda dedicare* of the stones of Lyons and other parts of Gaul), and towns, of which a full account cannot be given here.

2. Of the *dedicatory inscriptions* (*or tituli sacri*), the oldest known are the short indications painted (along with representations of winged *genii*, in the latest style of Graeco-Italian vase painting), with white colour on black earthen vessels, by which those vessels (*puscula*) are declared to be destined for the worship, public or private, of a certain divinity (C.I.L. i. 43-50; *Ephem. epigr.* i. 5-6; V. 1. 2827-2870); they give the name of the deity, as that of the goddesses in the genitive (e.g. *Saturni pocolom, Lavernae pocolom*). The proper form of the dedication, the simple dative of the name of a divinity and often nothing else (as *Polonei, Fide, Junone, &c.*, which are all datives), is shown on the very primitive altars found in a sacred wood near Pisaurum (C.I.L. i. 167-180; Wil. 1-14); but also the name of the dedicants (*matrona, matrona Pissaurae*, which are nomin. plur.) and the formulae of the offering (*dono dedot or dedo, donu dat*, where *dono* and *donu* are accus.) are already added to them. This most simple form (the verb in the perfect or in the present) never disappeared entirely; it occurs not infrequently also in the later periods. Nor did the dative alone, without any verb or formula, go entirely out of use (see C.I.L. i. 630; Wil. 36; C.I.L. i. 814 and vi. 96; Orel. 1850; Wil. 101; Henz. 5733; Wil. 142 and C.I.L. ii. 1044); so, but not before the time of Augustus (see C.I.L. i. 1462=iii. 1772), the solemn formula of the dedicatory inscriptions of the later period, *v. s. i. m.* or *v. s. i. l. m.* arose. To the same effect, and of equally ancient origin with the solemn words *dare* and *donum dare*, the word *sacrum* (or other forms of it, as *sacra lar(a)*), conjoined with the name of a divinity in the dative, indicates a gift to it (e.g. C.I.L. i. 814; Wil. 32; C.I.L. i. 1200-1201; Wil. 33 a b); the same form is to be found also in the later period (e.g. C.I.L. i. 1124; Henz. 5624-5637), and gave the model for the numerous sepulchral inscriptions with *dis Manibus sacrum* mentioned before. *Sacrum* combined with a genitive verb seldom occurs (Orel. 1824; Wil. 34); its use is found more frequently (as *ara Nevae sacrum, Lavernae sacrum*, Orel. 1340). Dedications were frequently the results of vows of individual soldiers (such as L. Mummium, the conqueror of Corinth—C.I.L. i. 541 seq.; Orel. 563; Wil. 27), and prosperous merchants (e.g. the brothers Vertuleii—C.I.L. i. 1175; Henz. 5733; Wil. 142) vowing a tenth part of their booty (*de praedaa*, as is said on the basis erected by one of the Fourii of Tusculum—C.I.L. i. 63, 64; Henz. 5674; Wil. 18) in gain, and out of this dedicate a gift to Hercules or other divinities (see also C.I.L. i. 1503; Wil. 24; C.I.L. 1113; Wil. 43). Again, what one man had vowed, and had begun to erect, is, by his will, executed after his death by others (as the *propylaeum Cereris et Proserpinae* on the Eleusian temple, which Apollus Claudius in the year Cicero's well-known predicator in the Cilician proconsulate, began—C.I.L. i. 619=iii. 347; Wil. 31); or the statue that an *aedilis* vowed is erected by himself as *aedilis* (C.I.L. iii. 50; Henz. 5684); what slaves had promised they fulfil as freedmen (C.I.L. 1233, *servos vocit liber solvit*; C.I.L. 816, Wil. 51, "*servos vocit liber solvit solv(it)*"), and so on. The different acts into which an offering, according to the circumstantially detailed Roman ritual, is to be divided (the *consecratio* being fulfilled only by the solemn *dedicatio*) are also specified on dedicatory inscriptions (see for instance, *consecrare* or *consecrare*, Orel. 2503, and Henz. 6124, 6128; for *dedicare*, C.I.L. i. 1159, Henz. 7024, Wil. 1782, and compare Catullus's *hunc libum tibi dedico consecroque Priape*; for *dicare* see the *ara laeae Albani dicata* to Veduvio by the *gentiles Titiae*, C.I.L. i. 808; Orel. 128; Wil. 101; Neuvied, *Laternae dicata*, but only mentioning the origin of the gift, are the inscriptions on the pedestals of offerings (*avabithura, donaria*) out of the booty, like those of M. Claudius Marcellus from Enna (C.I.L. i. 530; Wil. 25, "*Hinnad cepit*") or of M. Fulvius Nobilior, the friend of the poet Ennius, from Astola (C.I.L. i. 534; Orel. 562; Wil. 26 a, and *Bullettino dell'Istituto*, 1869, p. 8; C.I.L. vi. 1307; Wil. 26 b, "*Aetolia cepit*" and "*Ambracia cepit*"); they contain only the name of the dedicant, not that of the divinity. Of the similar offerings of L. Mummium, already mentioned, two only are preserved in their original poetical form, the Roman in Saturnian verses of a *carmen triumphale* (C.I.L. i. 541; Orel. 563; Wil. 27 a) and that found at Reate in dactylic hexameters (C.I.L. ii. 1212; Wil. 27 b); the latter contain only the name of the dedicant and the dative of the community to which they were destined (C.I.L. i. and Wil. l.c.). Of a peculiar form is the very ancient inscription on a bronze tablet, now at Munich, probably from Rome, where two *aediles*, whose names are given at the beginning as in the other *donaria*, "*vicesma(m) partim*(m) [or] [*ex*] *vicesma*



*partii Apollones* (that is, *Apollinisi dederi* (that is, *dedere*)" (*C.I.L.* i. 187; *Orel.* 1433). Many, but not substantial, varieties arise, when old offerings are restored (e.g. *C.I.L.* i. 638, 632 = *Orel.* 2135, and *Wil.* 48; *C.I.L.* i. 803; *Henz.* 5669, 6122); or the source of the offering (e.g. *de stippe*, *C.I.L.* i. 1105; *Henz.* 5633 a; *ex reditu* *domus, ex postamento suo, ex ludis, de munere gladiatorio*, and so on); or the motive (*ex iussu, ex imperio, ex visu, ex oraculo, monitu, viso montis, somnio admonitus* and the like) or the person or object, for which the offering was made (*C.I.L.* i. 188; *pro populo, Epheum, epigr.* ii. 208, *pro tribubus*, in the British Museum; *pro se, pro salute, in honorem domus divinae*, &c.), are indicated; or, as in the *tituli operum publicorum*, the order of a magistrate (*de senati sententia*, *C.I.L.* i. 560 = vi. 1306; *Orel.* 5351; i. 632 = vi. 110; *Orel.* 2135; *Wil.* 48; *decurionum decreto*, &c.), and the magistrates or private persons executing or controlling the work, the place where and the time when it was erected, are added. On all these details the indexes, especially that of *Wil.* (ii. 675), give further information. The objects themselves which are erected or erected begin to be named only in the later period just as in the *tituli operum publicorum* ("basim domum danti," *C.I.L.* i. 1167; "signum basim," *C.I.L.* i. 1154; "aram," *C.I.L.* i. 1468; *Orel.* 1466; *Wil.* 52; *C.I.L.* i. 1109; *Wil.* 54); in the later period this custom becomes more frequent. It is hardly necessary to observe that all kinds of offerings have very frequently also been adorned with poetry; these *carmina dedicatoria* are given by Buechler, *Anthologia Latina*, ii.; cf. *Wil.* 142-151.

Statues to mortals, whether living or after their death (but not on their tombs), with *honorary inscriptions* (*tituli honorarii*), were introduced into the Roman Republic after the Greek model and only at a comparatively late date. One of the oldest inscriptions of this class comes from Greek soil and is itself Greek in form, with the name in the accusative governed by some (suppressed) verb like "honoured" (*C.I.L.* i. 533; *Wil.* 649). "Italicæ L. Cornelium Scipionem (i.e. *Asiagenum*) honoris causa," lost and of not quite certain reading, belonging to 561 A.U.C. (193 B.C.); the same form (in the accusative) appears in other (Latin or Latin and Greek) inscriptions from Greece (*C.I.L.* i. 596 = iii. 582; *Wil.* 1103; *C.I.L.* i. 595, 724) and compare also *C.I.L.* i. 587, 588; *Orel.* 3036). The noble house of the Scipios introduced the use of poetical *elogia* in the 6th century in elegiac distichs. They were added to the short *tituli*, painted only with *minium* on the sarcophagi, giving the name of the deceased (in the nominative) and his curial offices (exclusively), which were copied perhaps from the well-known *imagines* preserved in the atrium of the house (*C.I.L.* i. 29 sq.; *Orel.* 550 sq.; *Wil.* 537 sq., and elsewhere). They hold, by their contents, an intermediate place between the sepulchral inscriptions, to which they belong properly, and the honorary ones, and therefore are rightly styled *elogia*. What the Scipios intended thus privately for themselves was in other cases done publicly at a public and sacred place. The first instance preserved of such a usage, of which Pliny the elder speaks (*Hist. nat.* xxxv. § 17 sq.), is the celebrated *columna rostrata* of C. Duilius, of which only a copy exists, made in or before the time of the emperor Claudius (*C.I.L.* i. 195 = vi. 1300; *Orel.* 549; *Wil.* 600). Then follow the *elogia* inscribed at the base of public works like the *Arcus Fabianus* (*C.I.L.* i. 606, 607 and 278, *elg.* i.-iii. = vi. 1303, 1304; *Wil.* 610), or of statues by their descendants, as those belonging to a *sacramentum domus Augustae* (*C.I.L.* i. *elg.* iv.-vi. = *C.I.L.* i. 1311 and others belonging to men celebrated in politics or in letters, as Scipio, Hortensius, and Cicero, and in Rome either on marble tablets (*C.I.L.* i. vii.-xii. = *C.I.L.* vi. 1312-1279, 1283, 1271, 1273; *Wil.* 611-613), or on busts (*C.I.L.* i. xv.-xviii. = *C.I.L.* vi. 1327, 1295, 1320, 1309, 1325, 1326; *Wil.* 618-621; see also *C.I.L.* i. 40 = vi. 1280; *Wil.* 1101; and *C.I.L.* i. 631 = vi. 1278; i. 640 = vi. 1323, vi. 1321, 1322, where *T. Quinti* seems to be the nominative), and in divers other places (*C.I.L.* i. xiii., xiv.; *Wil.* 614, 615). This custom seems to have been resumed by Augustus (*Suet.* Aug. 61) with a political and patriotic aim, praised by the poet Horace (*Sat.* i. 8, 13, "iusticiae namq. marmora publicis, per quae spiritus et vita redit bonis post mortem ductus"), for he adorned his *forum* with the statues of celebrated men from Aeneas and Romulus downwards (*C.I.L.* i. xxiv., xxv., xxvii., xxix. = *C.I.L.* vi. 1272, 1308, 1275, 1318; *Wil.* 625, 626, 627, 632), and other towns followed his example (so Pompeii, *C.I.L.* i. xx., xxii. = *Wil.* 622, 623; *Lavinium*, *C.I.L.* i. xi.; *Wil.* 617; *Arretium*, *C.I.L.* i. xiii., xviii., xxix., xxx., xxxii., xxxiii., xxxiv. = *Wil.* 624, 625, 629-633). In all these *elogia* are written in the nominative. In the same way in the colonies statues seem to have been erected to their founders or other eminent men, as in Aquileia (*C.I.L.* i. 538 = v. 873; *Wil.* 650; compare also *C.I.L.* v. 874, 875) and in Lyons (*C.I.L.* i. 539 = *Wil.* 651).

But along with this primitive and simple form of the *titulus honorarius* another form of it, equivalent to the dedicatory inscription, with the name of the person honoured in the dative, begins to prevail from the age of Sulla onwards. For the oldest examples of this form seem to be the inscriptions on statues dedicated to the dictator at Rome (*C.I.L.* i. 584 = vi. 1297; *Orel.* 567; *Wil.* 1102a) and at other places (Caieta and Clusium, *C.I.L.* i. 585, 586; *Wil.* 1102b, c), in which the whole set of honours and offices is not enumerated as in the *elogia*, but only the *honores praesentes*; compare also the inscription belonging to about the same date, of a *quaestor urbanus*

(*C.I.L.* i. 636). Within the Greek provinces also, at the same period, this form is adopted (*C.I.L.* i. 591 = iii. 531; *Henz.* 5294; *Wil.* 1104). Similar dedications were offered to Pompey the Great at Auximium and Clusium, *C.I.L.* i. 615, 616; *Orel.* 574; *Wil.* 1107) and to his legate L. Afranius (at Bologna, but erected by the citizens of the Spanish colony Valentia, *C.I.L.* i. 601; *Henz.* 5127; *Wil.* 1106). They are succeeded by the statues raised to Caesar (at Bovianum, *C.I.L.* i. 620; *Orel.* 582; *Wil.* 1108), and after his death, *iussu populi Romani*, in virtue of a special law, at Rome (*C.I.L.* i. 622; *Orel.* 586; *Wil.* 877). With him, as is well known, in this same form other historical persons of high merit also begin to be honoured by posterity, as, for example, Scipio the elder at Saguntum (*C.I.L.* ii. 385; *Wil.* 653), Marius at Cerretum (the Marianum of the place which bears his name (*C.I.L.* x. 5782; *Wil.* 654). Of statues erected by the community of a municipium to a private person, that of L. Popillius Flaccus at Ferentinum seems to be the oldest example (*C.I.L.* i. 1164; *Wil.* 655, and his note). In Rome, Augustus and his successors in this way permitted the erection of statues, especially to *triumphatores*, in the *nova fora*, including that of Augustus (*C.I.L.* vi. 1380; *Orel.* 3187; *Wil.* 634; *C.I.L.* vi. 1444; *Henz.* 5448; *Wil.* 638) and that of Trajan (*C.I.L.* vi. 1377; *Henz.* 5478; *Wil.* 636; vi. 1549; *Henz.* 5497; *Wil.* 639; iv. 1549; *Orel.* 1386; *Wil.* 637; *C.I.L.* 1565, 1566; *Wil.* 637). This custom lasted to a late period (*C.I.L.* vi. 1599; *Henz.* 3574; *Wil.* 637) as shown by the statues of Symmachus the orator (*C.I.L.* vi. 1698, 1699; *Orel.* 1186, 1187; *Wil.* 641), Claudian the poet (*C.I.L.* vi. 1710; *Orel.* 1182; *Wil.* 642), Nicomachus Flavianus (*C.I.L.* vi. 1782, 1783; *Orel.* 1188; *Henz.* 5593; *Wil.* 645, 645a), and many other eminent men down to Stilicho (*C.I.L.* vi. 1730, 1731; *Orel.* 1133, 1141; *Wil.* 648, 648a), who died in the year 408. In similar forms are conceived the exceedingly numerous dedications to the emperors and their families, in which the names and titles, according to the different historical periods, are exhibited in the main with the greatest regularity. They are specified in detailed indexes by Henzen and Wilmanns, as well as in each volume of the *Corpus*. In the provinces, of course, the usages of the capital were speedily imitated. Perhaps the oldest example of a *titulus honorarius* in the form of an *elogium* (but in the dative), with the full *cursum honorum* of the person honoured, is a *bilinguis* from Athens, of the Augustan age (*C.I.L.* iii. 531; *Henz.* 6456 a; *Wil.* 1122); the honours are here other instances the highest, and the first, and the others follow in order. In the older examples the *titulus honorarius* is "virtutis ergo (*Hermes*, iv., 1871, p. 6), is added at the end of an inscription of Mytilene belonging to the consul of the year 723 A.U.C., i.e. 31 B.C. (*C.I.L.* iii. 455; *Orel.* 4111; *Wil.* 1104 b); the same abbreviated (*h.c.*) occurs on an inscription of about the same age from Circa in Africa (*C.I.L.* vii. 7099; *Wil.* 2384). Shortly afterwards the honour of a statue became as common in the Roman *municipia* as it was in Athens and other Greek cities in the latter period. Each province furnishes numerous examples, partly with peculiar formulae, on which the indexes of Wilmanns (pp. 673, 696 sq.) may be consulted. Special mention may be made of the numerous honorary inscriptions belonging to *aurigae, histriones et gladiatores*; for those found in Rome see *C.I.L.* vi. 10, 44-10, 210.

He who erects a temple or a public building, or constructs a road, a bridge, an aqueduct or the like, by inscribing his name on the work, honours himself, and, as permission to do so has to be given by the public authorities, is also honoured by the community. Therefore the *tituli operum publicorum*, though in form only short official statements, at least in the older period) of the origin of the partake of the style of the older honorary inscriptions, of the ancient and almost universally employed method of erecting public buildings by means of the *locatio censoria* one monument has preserved traces (*Ephem. epigr.* ii. 199). The oldest instance of this class is that commemorating the restoration of the temple of the Capitoline Jupiter, begun, after its destruction by fire in the year 671 (83 B.C.), by Sulla and continued five years later by the well-known orator and poet Q. Lutatius Catulus, but completed only about twenty years afterwards. Here, after the name of Catulus in the nominative and the indication of the single parts of the building (as, for example, *substructionem et tabularium*), follows the solemn formula *de senati (sententia) faciendum coarctat eidemque* (*C.I.L.* i. 592 = vi. 1314; *Orel.* 31, 3267; *Wil.* 700). With the same formula the praetor Calpurnius Piso Frugi (of about the same period) dedicated an unknown building (*C.I.L.* i. 594 = vi. 1275), restored afterwards by Trajan. On a work executed by the *collegium tribunorum plebis* (*C.I.L.* i. 593 = vi. 1299; *Wil.* 787), perhaps the public streets within the town, the sum employed for it is also inscribed. Precisely similar is the oldest inscription of one of the bridges of Rome, the *ponte dei quattro capi*, still preserved, though partly restored, on its original site, which commemorates its builder, the tribune of the year 692

This observation, applied to a large number of monuments, gave rise to many of the splendid epigraphical labours of Borghesi (see e.g. his dissertation upon the inscription of the consul L. Burbeulius, *Œuvres*, iv. 103 sq.).

(62 B.C.), L. Fabricius (*C.I.L.* i. 600 = vi. 1305; Orel. 50; Wil. 788); it was restored by the consuls of the year 733 (21 B.C.).<sup>1</sup> On privately erected buildings the founder after his name puts a simple *fecit* (as also on sepulchral inscriptions); so, possibly, did Pompey, when he dedicated his theatre as a temple of Venus Victrix and, on Cicero's clever advice, as Varro and Tiro had it from Cicero himself, inscribed on it *COS-TERT* (*not tertium or tertio*) (see Gellius, *Noct. Att.* x. 1). So Agrippa, when he dedicated his Pantheon in the year 77 (27 B.C.), inscribed on it only the words *M. Agrippa, L. f. cos. tertium fecit* (*C.I.L.* vi. 890; Orel. 34; Wil. 731), as all who visit the Eternal City know. Of municipal examples it will be sufficient to mention those of the majestic temple of Cora (*C.I.L.* i. 1149-1150; Wil. 722, 723), of Ferentinum, with the measurements of the foundation (*C.I.L.* i. 1161-1163; Wil. 708), of the walls and towers at Aclanum (*C.I.L.* i. 1230; Orel. 566; Henz. 6583; Wil. 699), of the theatre, amphitheatre, baths and other structures at Pompeii (*C.I.L.* i. 1246, 1247, 1251, 1252; Orel. 2416, 3294; Henz. 6153; Wil. 730, 1899-1901). At Alatrium a municipal citizen gives an enumeration of a number of works executed by him in the period of the Gracchi, in his native town ("hoc quae infra scripta sunt de senatu sententia facienda cotrauit," *C.I.L.* i. 1166; Orel. 3892; Wil. 706); and, more than a century later, the same is done at Carthage, a small Spanish town near Málaga, by a rich woman (*C.I.L.* ii. 1086; Wil. 746). Military works, executed by soldiers, especially frequent in the Danubian provinces, Africa, Germany and Britain, give, in this way, manifold and circumstantial information as to the military administration of the Romans. On a column found near the bridge over the Minho at Aque Flaviana, the modern Chaves in northern Portugal, ten communities inscribed their names, probably as contributors to the work, with those of the emperors (Vespasian and his sons), the imperial legate of the province, the legate of the legion stationed in Spain, the imperial procurator, and the name of the legion itself (*C.I.L.* ii. 2477; Wil. 803); and similarly, with the name of Trajan, on the famous bridge over the Tagus at Alcántara, in Spanish Estremadura, the names of the *municipia provinciae Lusitaniae sive conlata quae opus pontis perfecerunt* are inscribed (*C.I.L.* ii. 759-762; Orel. 161, 162; Wil. 804).

As in some of the already-mentioned inscriptions of public works the measurements of the work to which they refer (especially, as may be supposed, in the case of works of great extent, such as walls of towns or lines of fortification, like the walls of Hadrian and Antoninus Pius in Britain) are indicated, so it early became a custom in the Roman republic to note on *milestones* the name of the founder of the road and, especially at the extremities of it and near large towns, the distances. So in the *via di Diana* in Lucania P. Popilius Laenas, the consul of the year 622 (132 B.C.), at the end of a road built in the *municipium Popilianum* (*C.I.L.* i. 551; Orel. 3308; Wil. 671), which is a general name for himself, in which he speaks in the first person (*viam fecit ab Regno ad Capuam*, &c.). One of the single *miliaria* set up by him is also preserved (*C.I.L.* i. 550; Henz. 7174 d; Wil. 808), which contains only his name and the number of miles. In the same brief style are conceived the other not very frequent republican *miliaria* found in Italy (*C.I.L.* i. 535-537; Henz. 5348; Wil. 567; *C.I.L.* i. 540; Henz. 5350, 6226; Wil. 807; *C.I.L.* i. 558, 559; Henz. 5353; Wil. 808; *C.I.L.* i. 561; Henz. 5180; Wil. 811; *C.I.L.* i. 633; Wil. 812) down to the time of Augustus (*C.I.L.* x. 6895, 6897, 6899; Wil. 813), and also the even more rare specimens from the provinces (from Asia—*C.I.L.* i. 557 = iii. 479, Wil. 808; *C.I.L.* i. 622 = iii. 462, Wil. 827; from Spain—*C.I.L.* i. 1484-1486 = iii. 4920-4925, 4956; Wil. 829, 830). Augustus is described on each milestone ("in itinere road across Spain" a *Baete et Jano Augusto ad Oceanum*) (e.g. *C.I.L.* ii. 4701; Wil. 832), Claudius on those of a road in Upper Italy founded by his father Drusus ("viam Claudiam Augustam quam Drusus pater Alpius bello pacificus decesserat nuntii ab Altino (or a Rume) Pado ad flumen Danavium" (*C.I.L.* v. 8002, 8003; Orel. 648, 708; Henz. 5400; Wil. 818)). The later milestones vary greatly in form, but all contain most precious materials for ancient geography and topography; in the volumes of the *Corpus* they are taken together under the special head *viae publicae* (and here and there *privatae*) at the end of each chapter.

A similar character, resulting from the combination of a mere æsthetic record with the peculiar form of the honorary inscription, belongs to the kindred classes of *inscriptions of the aqueducts* and of the different *boundary-stones*. The large dedicatory inscriptions of the celebrated aqueducts of Rome (as the *Aquae Marcia*, *Tepula* and *Julia*, *C.I.L.* vi. 1244-1246, Orel. 51-53, Wil. 765; the *Virgo*, *C.I.L.* vi. 1252, Orel. 703, Wil. 763; the *Claudia*, &c., *C.I.L.* vi.

1256-1258, Orel. 54-56, Wil. 764) have quite the character of honorary inscriptions, while the various *cippi terminales*, which mark the ground belonging to the aqueduct, show the greatest analogy to the milestones (e.g. *C.I.L.* vi. 1243 a-g; Henz. 6635, 6636; Wil. 775-779). The other Italian and provincial varieties cannot be specified here. Of boundary-stones, or *cippi terminales*, some very ancient specimens have been preserved. To the age preceding the Second Punic War belong two, found at Venusia and erected by municipal magistrates (*C.I.L.* i. 185, 186; Orel. 3527, 3528; Wil. 863); they give a short relation of a *decessor*, by which certain localities were declared to be sacred or public ("ad sacrum and publicum locum esse"). Then follow the *cippi Gracchani*, which Gaius Gracchus and his two colleagues, as *tres viri agris indicandis assignandis*, measured the *ager Campanus*, by their division among the plebs. They contain the names of the *tres viri* in the nominative, and in addition, on the top, the lines and angles of the *cardo* and *decumanus*, according to the rules of the *agrimensores*, or the boundary lines between the *ager publicus* and *privatus* (*C.I.L.* i. 552-556; Henz. 6464; Wil. 859-861). From the age of Sulla we still have various boundary-stones giving the line of demarcation between different communities (between Fanum and Pisaurum—*C.I.L.* i. 583, Orel. 570, Wil. 861; between *terram Italiae* and *Latavium*—*C.I.L.* i. 549, 548; Orel. 3110, Henz. 5114, 5115, Wil. 865, 866). To the town of Kornt belonging the *termini ripae Fiveris* (*C.I.L.* i. 608-614 = vi. 1234 a-d), beginning in the Augustan age, and the *termini of the pomerium* of Claudius and Vespasian as censors, and of the *collegium augurum* under Hadrian (*C.I.L.* vi. 1231-1233; Orel. 710, 811; Wil. 843, 844), while others, of the consuls of the year A.D. 4 (*C.I.L.* vi. 1263; Orel. 3260; Wil. 856), of Augustus (*C.I.L.* vi. 1265; Henz. 6455; Wil. 852), &c., show the boundary between the *ager publicus* and *privatus*. With similar objects boundary-stones were erected by the emperors, or, under their authority, by magistrates, mostly military, in the rest of Italy also (as in Capua—*C.I.L.* x. 3825, Orel. 3683, Wil. 858; at Pompeii—*C.I.L.* x. 1018, Wil. 864) and in the provinces (e.g. in Syria—*C.I.L.* iii. 183; and Macedonia—*C.I.L.* iii. 59; in Dalmatia—*C.I.L.* iii. 2883; in Africa—*C.I.L.* viii. 7084-7090, 8211, 8268, 10,803, 10,838, Wil. 869, 870; in Spain—*C.I.L.* ii. 2349, 2916, Wil. 871—where the *pratum* of a legion is divided from the territory of a *municipium*; in Gaul—Wil. 867; in Germany, in the column found at Miltenberg on the Main, *Bonner Jahrbücher*, vol. lxxv., 1878, p. 46, &c.). Private grounds (*pedaturae*) were unfrequently marked off by terminal *cippi*. To this class of *tituli* must be added also the curious inscriptions incised upon the steps of Roman circuses, theatres and amphitheatres (see Hübner, *Annali dell' Istituto archeologico*, vol. xxviii., 1856, p. 52, &c., and vol. xxxi., 1859, p. 122, &c.), as also for instance, upon the steps of the Colosseum at Rome (*C.I.L.* vi. 1727-1737; compare R. Lanciani, *Bullettino archeologico municipale*, 1881).

4. We now come to the last class of *tituli*, viz. those which in the *Corpus* are arranged, at the end of each volume, under the head of *Instrumentum*. By this very comprehensive term are designated objects which vary greatly among themselves, but which are of such a character as not to fall within any of the classes of *tituli* described before, or the class of the *instrumenta* in the proper sense of that word, —the laws, &c. The *tituli* of the *instrumentum* embrace movable objects, destined for public and private use, and illustrate almost every side of the life of the ancient Romans. As systematic treatment of them is hardly possible, a simple enumeration only of their different classes can be given, without citing special examples. The first species of them is metrological, comprehending the inscriptions on measures and weights. The gold and silver plate used in the best Roman houses was also always marked with a note of its weight,—as is seen, for instance, on the different objects belonging to the Hildesheim find (see *Hermes*, iii., 1868, p. 469 sq.); *Philologus*, xxvii., 1869, p. 369), the Corbridge *lanx* in Northumberland House (*C.I.L.* vi. 1268) and many others. A second species is formed by the *teserae*, tokens or marks, mostly in bronze, bone and ivory, but also earthen, of which the most interesting are the so-called *teserae gladiatoria*, little slabs of bone with holes at the top, and with names of slaves or freedmen and consular dates upon them, the relation of which to the *munera gladiatoria* is by no means certain (see *C.I.L.* i. 717 sq., and *Hermes*, xxi. p. 266; *Rhein. Mus.* xli. p. 517; xlii. p. 122; *Berl. phil. Woch.*, 1888, p. 24). The other circular *teserae* (the so-called *teserae theatrales*) of ivory or bone, with emblems and short inscriptions, partly Greek and Latin, used to be attributed to the *Iudi scaenici* (see Henzen, *Annali dell' Istituto archeologico*, vol. xx., 1848, p. 273 sq., and vol. xli., 1850, p. 357 sq.) and to other *Iudi*; but this account has been questioned (Huelsén, *Bullett. dell' Istituto*, 1896, p. 227). A third species is that of inscriptions carved, inscribed, painted or stamped upon various materials, raw or manufactured, for trade or household use. Such are, to be mentioned, dating from the year 745 (9 B.C.) (*C.I.L.* vi. 1246; Orel. 626), and the similar one on the *tropaeum Augusti* (*la Turbia*) (*C.I.L.* v. 7817) of the year 747 (7 B.C.), which Phly also (*Hist. Nat.* iii. § 136) records, and those of the other emperors at Rome, of which only that of Claudius, the conqueror of Britain (*C.I.L.* vi. 920, 921; Orel. 715; Wil. 899), with the statues of himself and his family, need be mentioned.

<sup>1</sup> The character of an *elogium* is assumed in a special way by the inscriptions on triumphal arches, such as that of Augustus at the arch of Susa in Piedmont, dating from the year 745 (9 B.C.) (*C.I.L.* vi. 1246; Orel. 626), and the similar one on the *tropaeum Augusti* (*la Turbia*) (*C.I.L.* v. 7817) of the year 747 (7 B.C.), which Phly also (*Hist. Nat.* iii. § 136) records, and those of the other emperors at Rome, of which only that of Claudius, the conqueror of Britain (*C.I.L.* vi. 920, 921; Orel. 715; Wil. 899), with the statues of himself and his family, need be mentioned.

<sup>2</sup> See the important work of R. Lanciani, *Commentari di Frontino intorno le acque e gli acquedotti*, &c. (Rome, 1880).

character are the inscriptions, mostly stamped or engraved in the mould, of pigs of silver, bronze and lead (and pewter), found in the Roman mines in Spain and England (see Hübner, "Römische Bleigruben in Britannien," in *Rheinisches Museum für Philologie*, vol. xii, 1857, p. 347 sq., and *C.I.L.* vii. 220 sq.; A. Way, *Archaeological Journal*, vol. xvii, 1859, p. 23, and vol. xxiii, 1866, p. 63).—A fourth species of *tituli* of this class is strictly related to the military institutions of the Roman Empire. Many of its specimens, stamped with the names of the bearer and of the military corps to which he belonged,—so, for example, the buckles of their shields (see Hübner, "Römische Schildbuckel," in *Archäologisch-epigraphische Mittheilungen aus Österreich*, vol. ii., 1878, p. 105 sq.; by far the best extant specimen is the umbo of a legionary soldier of the eighth legion found in the Tyne near South Shields, *C.I.L.* vii. 495), and sometimes the swords, as that of Tiberius from Mainz (now in the British Museum, see *Bonner Winkelmaßprogramm* of 1848). The leaden *glanides* used by the *Judiciores*, the *clingers*, in the Roman army bear curious historical inscriptions (see *C.I.L.* i. 642 sq., *Ephem. epigr.* vi. 47), and on the question of the authenticity of many of them—Zange-meister, *C.I.L.* ix., 35\* sq. 4.). Special mention must be made also of the leaden seals or marks (*bulinae*), evidently of military origin (perhaps to be borne by the soldiers as a countersign), which have been found in many parts of England (*C.I.L.* vii. 1269; *Ephem. epigr.* iii. 144, 318, iv. 209, vii. 346). Of the highest interest are the manifold productions of the Roman tile and brick kilns (*C.I.L.* xv. *Inscriptiones laterum*; cf. Desceinet in the *Bibliothèque des écoles françaises*, vol. xv.). Next to the tiles with consular dates made at Veleia (*C.I.L.* i. 777 sq.), the tiles signed with the names of legions and their military units and employed in the various military buildings of these, are especially worthy of mention; they form an important chapter in every geographical part of the *Corpus*. But private persons, too, especially the rich landed proprietors, and afterwards the emperors and their kinsmen, kept large *figulinae*, and their manufactures—tiles of every description and other earthenware—were spread over the Roman empire (Dressel, *Untersuchungen über die Chronologie der Ziegelstempel der Gens Domitia*, 1888; *C.I.L.* xv.). The different sorts of earthen vessels and lamps, the fragments of which are found in great quantities wherever Roman settlements occurred, are named at the end of each volume of the *Corpus*, and are collected in vol. xv. part ii. p. i. On the maker's marks on earthenware, see Habert, *La Poterie antique parlante* (1893); Dragendorf, "Terra Sigillata," in *Bonn. Jahrbuch* xvii. 18. On Roman lamps and their inscriptions the accurate catalogue of the Vienna collection by Kenner ("Die antiken Thonlampen des K. K. Münz- und Antiken-Cabinetes und der K. K. Ambraser Sammlung," in the *Archiv für Kunde österreichischer Geschichtsquellen*, vol. xx., Vienna, 1858) may be consulted with advantage. The chief deposit of earthenware fragments—the *Fontana testacea*—is to be seen in Rome, and by Sp. Cassius Vecellinus with the Latini of the year 261 (493 b.c.), which Cicero seems to have seen still in the *forum* behind the *rostra*, written on a bronze column (*Pro Balbo*, 23, 53; see also Livy ii. 33; Festus p. 166; and Mommsen's *Römische Forschungen* ii. 153 sq.); and by the *foedus Atradinum* of 310 (444 b.c.) mentioned by Livy (iv. 7). Of all these documents nothing has been preserved in an authentic form, save some few words quoted from them by the ancient grammarians. Of one *foedus* only is there a fragment still in existence, relating to the Oscan *crivias* Ibera Bantia (*C.I.L.* i. 197); it contains the *lausus* of the *foedus*, which was written in Latin and in Oscan (see APULIA). On account of this peculiar circumstance, the document gave occasion to Klenze, and afterwards to Mommsen, to resume (for the sake of Roman jurisprudence, in the first instance) inquiry into the Oscan and other Italian dialects. Some other Roman *foedera* are preserved only in Greek, e.g. that with the Jews of the year 594 (160 b.c.) (Josephus, *Ant. xii.* 6, 110). Some others, made with the same nation between 610 and 615 (144 and 139 b.c.) (Jos. *Ant.* xiii. 5, 6 and 7, 8), are mentioned in an abridged form only, or given in that of a *senatus consultum*, in which they must formally be fixed in the *actūs*. Amongst the *foedera* may be reckoned also the curious oath, sworn, perhaps, according to a general rule obtaining for all *civitates foederatae*, by the citizens of a Lusitanian *oppidum*, Aritium, to Gaius Caesar on his accession to the throne in A.D. 37 (*C.I.L.* ii. 172; Wil. 2839).

*nei cimiteri dei cristiani primitivi di Roma*, Rome, 1858); on the makers' marks on bronze objects, Mowat, *Marques de bronziers sur objets trouvés ou rapportés en France* (1884) (extracted from *Bulletin épigraphique*, 1883-1884). The last species of *tituli* is formed by the stamps themselves with which the inscriptions on many of the objects already named are produced. They are mostly of bronze, and contain names; but it is not easy to say what sort of objects were marked with them, as scarcely any example of a stamp of this kind or existing stamp has been found. Amongst the materials stamped leather also is to be mentioned. One class only of stamps differs widely from the rest,—the oculists' stamps, engraved mostly on steatite (or similar stones), and containing remedies against diseases of the eyes, to be stamped on the glass bowls in which such remedies were sold, or on the medicaments themselves (see Grotefend, *Die Stempel der römischen Augenärzte gesammelt und erklärt* (Göttingen, 1867); de Villefosse and Thédenat, *Cachets d'oculistes romains* (1882); Espérandieu, *Recueil des cachets d'oculistes romains* (1894).

IV. The other great class of inscriptions above referred to, the *instrumenta* or *leges*, the laws, deeds, &c., preserved generally on metal and stone, from the nature of the case have to be considered chiefly with regard to their contents; their form is not regulated by such constant rules as that of the *tituli*, so far as may be inferred from the state of completeness in which they have been preserved. The rules for each special class therefore, though, generally speaking, maintained—as was to be expected of Roman institutions—with remarkable steadiness from the earliest times down to a late period, must be based upon facts, as completely as possible, and including those preserved by ancient writers, and not in the monumental form. These documents are, as a rule, incised on bronze plates (only some private acts are preserved on wood and lead), and therefore have their peculiar form of writing, abbreviation, interpunction, &c., as has been already explained. The older Roman laws are now collected, in trustworthy texts, in the *Corpus*, vol. i.; of the documents belonging to the later period a very comprehensive *sylloge* is given in C. G. Brun's *Fontes juris Romani antiqui*.

Among the earliest occasions for committing to writing agreements which may be supposed to have been originally verbal only, must certainly be reckoned international transactions (*leges foederis* or *foedera*). At the head of the prose records written in the Latin language we find the treaties of alliance of Tullius Hostilius with the Sabini (Dionysius Halic. iii. 33), of Servius Tullius with the Latini (Dionysius iv. 26; Festus p. 169); this was, partly, at the same time, as will afterwards appear, the oldest document of the sacred class), of the second Tarquinius with Gabii (Dionysius iv. 58; Festus, *Epit.* p. 56). They are followed, in the oldest republican period, by the celebrated *foedera* with the *crivias* of the year 594 (160 b.c.), which Cicero seems to have seen still in the *forum* behind the *rostra*, written on a bronze column (*Pro Balbo*, 23, 53; see also Livy ii. 33; Festus p. 166; and Mommsen's *Römische Forschungen* ii. 153 sq.); and by the *foedus Atradinum* of 310 (444 b.c.) mentioned by Livy (iv. 7). Of all these documents nothing has been preserved in an authentic form, save some few words quoted from them by the ancient grammarians. Of one *foedus* only is there a fragment still in existence, relating to the Oscan *crivias* Ibera Bantia (*C.I.L.* i. 197); it contains the *lausus* of the *foedus*, which was written in Latin and in Oscan (see APULIA). On account of this peculiar circumstance, the document gave occasion to Klenze, and afterwards to Mommsen, to resume (for the sake of Roman jurisprudence, in the first instance) inquiry into the Oscan and other Italian dialects. Some other Roman *foedera* are preserved only in Greek, e.g. that with the Jews of the year 594 (160 b.c.) (Josephus, *Ant. xii.* 6, 110). Some others, made with the same nation between 610 and 615 (144 and 139 b.c.) (Jos. *Ant.* xiii. 5, 6 and 7, 8), are mentioned in an abridged form only, or given in that of a *senatus consultum*, in which they must formally be fixed in the *actūs*. Amongst the *foedera* may be reckoned also the curious oath, sworn, perhaps, according to a general rule obtaining for all *civitates foederatae*, by the citizens of a Lusitanian *oppidum*, Aritium, to Gaius Caesar on his accession to the throne in A.D. 37 (*C.I.L.* ii. 172; Wil. 2839).

Closely related to the *foedera* are the pacts between communities and private individuals, respecting *patronatus* or *hospitium* (*tabulae patronatus* et *hospitii*, also, when in small portable form, *lesserae hospitales*; cf. Plautus, *Poen.* 1047, of which many specimens from the end of the republic—due to a late period of the empire—have been preserved. See *Actūs* of the *tabulae* *Acadumia* at Torino, vol. xxv. 1831, p. 1 sq., and Mommsen, *Römische Forschungen*, i. 341 sq.). Of the numerous examples scattered through the different volumes of the *Corpus* may be quoted the *lessera Fundana*, containing the pact of hospitality between the community of Fundi and a certain Ti. Claudius (who cannot, with certainty, be identified), the oldest hitherto known, in the form of a bronze fish (*C.I.L.* i. 532; Henz. 7000; Wil. 2849); the *tabula* of the *pagus Garsulensis* in Africa, delivering the patronate to L. Domitius Ahenobarbus, Nero's grandfather, in 742 (2 b.c.), in the afterwards solemn form of a *tabula ferrea* to be fixed in the *actūs* (*Actūs* *Acadumia* at Torino, vol. xxv. 1831, p. 1 sq., and Mommsen, *Römische Forschungen*, i. 341 sq.). Of the numerous examples scattered through the different volumes of the *Corpus* may be quoted the *lessera Fundana*, containing the pact of hospitality between the community of Fundi and a certain Ti. Claudius (who cannot, with certainty, be identified), the oldest hitherto known, in the form of a bronze fish (*C.I.L.* i. 532; Henz. 7000; Wil. 2849); the *tabula* of the *pagus Garsulensis* in Africa, delivering the patronate to L. Domitius Ahenobarbus, Nero's grandfather, in 742 (2 b.c.), in the afterwards solemn form of a *tabula ferrea* to be fixed in the *actūs* (*Actūs* *Acadumia* at Torino, vol. xxv. 1831, p. 1 sq., and Mommsen, *Römische Forschungen*, i. 341 sq.). Of the numerous examples scattered through the different volumes of the *Corpus* may be quoted the *lessera Fundana*, containing the pact of hospitality between the community of Fundi and a certain Ti. Claudius (who cannot, with certainty, be identified), the oldest hitherto known, in the form of a bronze fish (*C.I.L.* i. 532; Henz. 7000; Wil. 2849); the *tabula* of the *pagus Garsulensis* in Africa, delivering the patronate to L. Domitius Ahenobarbus, Nero's grandfather, in 742 (2 b.c.), in the afterwards solemn form of a *tabula ferrea* to be fixed in the *actūs* (*Actūs* *Acadumia* at Torino, vol. xxv. 1831, p. 1 sq., and Mommsen, *Römische Forschungen*, i. 341 sq.). Of the numerous examples scattered through the different volumes of the *Corpus* may be quoted the *lessera Fundana*, containing the pact of hospitality between the community of Fundi and a certain Ti. Claudius (who cannot, with certainty, be identified), the oldest hitherto known, in the form of a bronze fish (*C.I.L.* i. 532; Henz. 7000; Wil. 2849); the *tabula* of the *pagus Garsulensis* in Africa, delivering the patronate to L. Domitius Ahenobarbus, Nero's grandfather, in 742 (2 b.c.), in the afterwards solemn form of a *tabula ferrea* to be fixed in the *actūs* (*Actūs* *Acadumia* at Torino, vol. xxv. 1831, p. 1 sq., and Mommsen, *Römische Forschungen*, i. 341 sq.).

Christian classes that of Garrucci (*Vetri ornati di figure in oro trionfanti*

*Hermes*, v., 1871, p. 371 seq.); that of *Lacibula*, in Spain, with one Q. Marius Balbus, of A.D. 5 (C.I.L. ii. 1393); that of the *Bochhoritani* on the island of Majorca, of A.D. 6 (C.I.L. ii. 3695; Wil. 2851); the four relating to C. Silius Aviola, dating from A.D. 27 to 28, all found at Brescia (C.I.L. v. 4919-4922); that of the *colonia Julia Augusta*, *legionis vii. Tarpuntina*, in Africa, with the imperial legate Q. Julius Secundus, of A.D. 55 (C.I.L. viii. 8837; Wil. 2851); that of two *gentilitates*, the *Desonici* and *Troveri*, of the gens of the *Coese*, in Spain, now in the museum at Berlin which contains an older all. of the year 27, and another more recent of the year A.D. 127 (C.I.L. ii. 2633; Orel. 156); that of the *respublica Pompeianensis* (Pampeluna in Spain) of A.D. 185 (C.I.L. ii. 2960; Wil. 2854); that of the *Segisamnonenses*, in Spain, of A.D. 239, now in the museum at Burgos (Ephem. epigr. ii. 322); that of the *fabri subdiani* (i.e. subaediani, qui sub aede consistent) of Cordova, of A.D. 348 (C.I.L. ii. 2211; Wil. 2861); and, in addition to many others, those found together at Rome, on the site of the palace of Q. Aradius Valerius Proculus, and belonging to him and other members of his family, from divers African cities and executed in A.D. 321 and 322 (C.I.L. vi. 1684-1688; Orel. 1079, 3058).

Hardly inferior in antiquity, and of superior value, are the remains of laws in the stricter sense of the word (*leges* and *plebiscita*), preserved to us in the originals, although unfortunately only in fragments more or less extensive. Of those laws the oldest and most important are the *lex Acilia* (for so it is in all probability to be styled) *repetundarum* of the year 631 (C.I.L. i. 198), which is incised on a bronze table about 2 metres broad, in 90 lines of about 200 to 240 letters each, and therefore extremely inconvenient to read, and the *lex agraria* of 643 (111 B.C.), written on the reverse of the *lex Acilia*, abrogated shortly afterwards (C.I.L. i. 200); this is the third of the celebrated laws of C. Gracchus bearing upon the division of public lands. Then follow the *lex Cornelia de viginti quaestoribus*, a fragment of Sulla's legislation, the eighth table only, of the whole set, being preserved (C.I.L. i. 202); the *plebiscitum de Thermensibus*, on the autonomy of Thermessus in Pisidia, proposed by the tribune *plebis*, in 682 (72 B.C.), one of four or five large bronze plates (C.I.L. i. 204); the *lex Rubria de convicente Galliae cisalpiniae* of 705 (49 B.C.), written in a new and more convenient form (belonging as it does to Caesar's legislation), in two columns, with numbered divisions, being the fourth out of six unknown fragments of plates; the *lex Julia municipalis*, or, from the place where it was found, the *tabulae Heracleenses* of 709 (45 B.C.), written on the reverse of the much older Greek law of that community, preserved partly at Naples, partly in the British Museum (C.I.L. i. 206), also a fragment of Caesar's general municipal institutions; it contains a curious passage relating to the public promulgation of laws (v. 15). These are the laws of the Roman republic preserved in important fragments; some minor ones (brought together in C.I.L. i. 207-211) may be left out of account here. In the imperial age, laws in general were replaced by *senatus consulta* or by imperial edicts, and the latter in the form of a *senatus consultum*, that the *leges de imperio*, on the accession of the emperors, seem to have been promulgated. An example of such a law, preserved in part on a bronze tablet found at Rome, is the *lex de imperio Vespasiani* (C.I.L. vi. 930; Orel. i. 567). There is, besides, one special category of imperial constitutions which continued to be named *leges*, viz. the constitutions given by the emperors to the divers classes of *civitates*, based upon the ancient traditional rules of government applied to Rome itself as well as to the *coloniae* and *municipia*. Of this sort of *leges* some very valuable specimens have come from Spanish soil, viz. the *lex coloniae Juliae Genetivae Urbinorum* and the *diversa (coloniae Juliae)* given to that colony by a praetor in 710 (44 B.C.), but incised, with some alterations, in the time of Vespasian, of which three bronze tables out of a much larger number remain (Hübner and Mommsen, *Ephem. epigr.* ii. 150 sq. and 221 sq.); the *lex Salpensana* and the *lex Malacitana*, given to a large bronze plate, written respectively in two and in five columns, with the single chapters numbered and rubricated (C.I.L. ii. 1963, 1964; compare Mommsen, "Die Stadtrechte der lateinischen Gemeinden Salpensae und Malacca in der Provinz Baetica," in the *Abhandlungen der sächsischen Gesellschaft der Wissenschaften philol.-histor. Class.* vol. ii. 1857, p. 36 sq.); the *lex metalli Vipascensis*, given, with all probability, by one of the three Flavii, as a constitution to a mining district of southern Portugal, one bronze plate numbered iii.—three or more, therefore, being lost (see Hübner, *Ephem. epigr.* iii. 165 sq. and, for a popular account, the *Deutsche Rundschau*, August 1877, p. 196 sq.). The so-called military diplomas, although in certain respects nearly related to the *leges* of the later period, are better placed along with the imperial decrees.

3. A third species of official documents is formed by decrees of the senate of Rome or of the analogous corporations in the *coloniae* and *municipia*, and in the divers *coloniae* and *sodalitates*, constituted, as a rule, after a similar fashion and debating in nearly the same way as the Roman and the municipal senates. The oldest Roman *senatus consulta* are those translated into the Greek language and containing treaties of alliance, as already mentioned. They are preserved either on monuments or by ancient authors, as Josephus: e.g. the fragment found at Delphi, from the year 568 (186 B.C.), and the *senatus consultum Thibaeum*, from Thibe in Boeotia, 584 (170 B.C.) (*Ephem. epigr.* i. 278 sq. ii. 102, and Joh. Schmidt, *Zeit-*

*schrift der Savigny-Stiftung*, vol. iii., 1881), those of 616, 619, 621, 649 (138-105 B.C.) (C. I. Graec. 2905, 2908, ii. 2485, 2737; Le Bas and Waddington iii. 195-198; *Annali dell' Istituto*, vol. xix. 1847, p. 113; *Ephem. epigr.* iv. 213 sq.), and those relating to the Jews, dating from 615, 621 and 710 (139, 133 and 44 B.C.) (Josephus, *Ant. xiii.* 9, 2, xiv. 8, 5 and 10, 9). The two oldest *senatus consulta* written in Latin are also preserved in a more or less complete form only by ancient authors: they are the *sc. de philostrophis et rhetoribus* of 593 (161 B.C.) (Gellius, *Noct. Att.* xv. 11), and that of *habeant Martius* of 655 (99 B.C.) (Gellius iv. 6, 2). The only one belonging to the oldest period preserved in the original Latin form, of which only a part exists, together with the Greek translation, is the *sc. Lutatianum*, relating to Aesclepiades of Clazomenae and his companions, dating from 676 (77 B.C.) (C.I.L. i. 203). The rest, belonging to the later epoch from Cicero downwards, about twenty in number, are mostly preserved only in an abridged form by ancient writers,—such as Cicero, Frontinus, Macrobius,—or in Leupin's *Digesta* (see Hübner, *De senatus populique Romani actis*, Leipzig, 1859, p. 66 sq.); a few exist, however, in a monumental form, complete or in fragments—such as the two *sc. on the ludii saeculares*, dating from 17 B.C. and A.D. 47, preserved on a marble slab found at Rome (C.I.L. vi. 877); the fragments of two *sc.* in honour of Germanicus and the younger Drusus, from Rome, on bronze tablets (C.I.L. vi. 911-912; Henz. 5381-5282); the two *sc. Hosidiana* and *Volusianum*, containing regulations for the demolition and rebuilding of houses in Rome, incised on the same bronze plate, found at Herculaneum, dating from Nero's time, between A.D. 41 and 46 and from 56 (Orel. 3115; Mommsen, *Beitrag der sächs. Gesellschaft der Wissenschaften, philol.-histor. Class.* 1856, p. 272 sq.); the *sc. de praetore*, of the period, the *senatus or Neronianum* of A.D. 38, containing a model regulation for the *saltus Beguensis* in Africa, where it has been found preserved in two examples on stone slabs (*Ephem. epigr.* ii. 271 sq., not complete in Wil. 2838), and the fragment of that for Cyzicus, belonging to the reign of Antoninus Pius (*Ephem. epigr.* iii. 156 sq.). There exists, besides, a chapter of a *sc.*, relating to the *collegia*, inserted in the decree of a *collegium* at Lanuvium, to be mentioned below. Of the municipal decrees, of which a greater number is preserved (see Hübner, *De sen. populique Rom. actis*, p. 71 sq.), only a few of the more important may be mentioned here: the *lex Puteolana de iudiciis*, containing 649 (105 B.C.) (C.I.L. i. 57; Orel. 207, vi. 607); the two *decretis* or *senatus consulta* of Pisanus in honour of Lucius and Gaius Caesar, the grandsons of Augustus, of A.D. 3 (C.I.L. xi. 1420, 1421; Orel. 642, 643; Wil. 883); the *decretum Lanuvianum* of A.D. 133, containing the regulations of a *collegium funeraticum*, styled *collegium salutare Dianae et Antinoi* (Orel. 6086; Wil. 319); and the *decretum Terestinum*, belonging to the time of Antoninus Pius (C.I.L. v. 532; Henz. 7167; Wil. 693). There are, however, more than thirty others preserved, some of them, such as those from Naples, written in the Greek language. Of the third speciality, the *leges collegiorum*, only the *collegii veteris* of the time of the praetor (Marini, *Atti de fratelli arabi*, p. 70; Rudolfo and Mommsen, *Zeitschrift für Rechtsgeschichte*, vol. xv., 1859, pp. 203, 345 sq.), and the *lex collegii Aesculapii et Hygieae*, of 153 (C.I.L. vi. 10,234; Orel. 2417; Wil. 320) need be mentioned here; many more exist. One of them, the *lex collegii Jovis Corneni*, dating from A.D. 167, found at Alburnus major in Dacia, is preserved on the original *tabella cerata* on which it was written (C.I.L. iii. 924; Henz. 6087; Wil. 321).

4. The fourth species of *instrumenta* are the decrees, sometimes in the form of letters, of Roman and municipal magistrates, and of the emperors and their functionaries, in the rule, or on bronze tablets. The oldest decree in the Latin language which has been preserved is that of L. Aemilius Paulus, when praetor in Hispania Baetica, dating from 189 B.C., for the Turris Lascutana in southern Spain (C.I.L. ii. 5041; Wil. 2837); of the same date is a Greek one of Cn. Manlius, consul of the year 565, for the Heracleenses Cariae (Le Bas and Waddington n. 588). Then follow the famous *epistula consulum* (falsely styled *senatus consultum*) *ad Teiranos de bacchanatibus*, dated 568 (186 B.C.) (C.I.L. i. 196); the sentence of the two Minucii, the delegates of the senate, on a dispute concerning the boundaries between the Genuates and Viturii, 117 B.C. (C.I.L. i. 199; Orel. 3121; Wil. 2841); and the *epistulae* of the praetor L. Cornelius (perhaps Sienna), the praetor of 676 (78 B.C.) *ad Tiburtes* (C.I.L. i. 201). These belong to the republican age. From the imperial period a great many more have come down to us of varying quality. Some of them are decrees or constitutions of the emperors themselves. Such are the decree of Augustus on the aqueduct of Venafrum (C.I.L. x. 4842; Henz. 6428; Wil. 784); that of Claudius, found in the Val di Nona, belonging to A.D. 46 (C.I.L. v. 5050; Wil. 2842); of Vespasian for Sabora in Spain (C.I.L. ii. 1423); and for the Vanacini in Corsica (Orel. 4931); of Domitian for Aleria (Orel. 3148); of Trajan, in the form of a rule, for the praetor in Phoenicia, added to a Greek decree of Avidius Quinctus (C.I.L. iii. 355; Henz. 9955), and relating to Smyrna, in Greek, with a short one of Antoninus Pius, in Latin (C.I.L. iii. 411; Orel. 3119); the decrees of Commodus relating to the *saltus Burunitanus* in Africa (C.I.L. viii. 10,570; cf. *Ephem. epigr.* v. 471); of Severus and Caracalla for Tyra (Akkerman in Moesia). Latin and Greek (C.I.L. iii. 781; Henz. 6429); of Valerian and Gallienus for Smyrna, also Latin and Greek (C.I.L. iii. 412); of Diocletian de *preiis rerum venalium*, containing a long list of prices for all kinds of merchandise,

preserved in divers copies more or less complete, in Latin and Greek (*C.I.L.* iii. 801 sq.; compare *Ephem. epigr.* iv. 180, and, as similar monuments, the *lex portus* of Cirra, of A. D. 202 *Wil.* 2738, and the fragment of a regulation for the importation of wines into Rome, Henz. 5089, *Wil.* 2739); and some of the age of Constantine, as that relating to Hispanum in Umbria (*Henz.* 5589; *Wil.* 2843), that of Julian found at Anargos (*C.I.L.* iii. 459; *Henz.* 6431), and some others of which copies exist also in the judicial collections. Of two imperial rescripts of a still later age A. D. 413, fragments of the originals, written on papyri, have been found in Egypt (see Mommsen and Jaffé, *Jahrbuch des gemeinen deutschen Rechts*, vol. vi., 1861, p. 398; *Henz.* *Corpus legum*, p. 281). Imperial decrees, granting diverse privileges to soldiers, are the *diplomata militaria* also, mentioned above, incised on two combined bronze tablets in the form of *diptycha* (L. Kenier, "Recueil de diplômes militaires"; *C.I.L.* iii. 842 sq., 1955 sq.; *Wil.* 2862-2869), belonging to nearly all emperors from Claudius down to Diocletian. Though not a decree, yet as a publication going back directly to the emperor, and as being preserved in the monumental form, the speech of the emperor Claudius, delivered in the senate, relating to the Roman citizenship of the Gauls, of which Tacitus gives an abstract (*Ann.* xi. 23), ought also to be mentioned here; it was engraved on large bronze slabs by the public authority of Lugudunum (Lyons), where a large fragment of it is still preserved (Boissieu, *Inscriptions antiques de Lyon*, p. 132 sq.). Another sort of decrees, relating to a great variety of subjects, has to be mentioned, emanating, not directly from the emperors, but from their functionaries, as the decree of the prefect of Egypt, L. Helvius Agrippa, of the year A. D. 68, on the boundaries of some tribes on the island of Sardinia (*C.I.L.* x. 7852; *Wil.* 872 a); that of the prefect of Egypt, Tiberius Julius Alexander, written in Greek, the same year (*C. I. Graec.* 4957); that of C. Helvidius Priscus, on a similar question relating to Histonium, belonging perhaps to the end of the 1st century (*Wil.* 873); that of the legate of Trajan, C. Avidius Nigrinus, found at Delphi, in Greek and Latin (*C.I.L.* iii. 567; *Orel.* 3671; *Wil.* 874); a rescript of Claudius Quartinus, perhaps the imperial legate of the Tarracensis, of the year A. D. 119, found at Pamplona (*C.I.L.* iii. 2055; *Orel.* 4032); the epistle of the *praefectus praetorio* to the magistrate of Saesenna, about the year 166-169 (*C.I.L.* ix. 2438; *Wil.* 2841); the decree of L. Novius Rufus, another legate of the Tarracensis, who *ex Italia restituit*, of A. D. 193 (*C.I.L.* i. 4125; *Orel.* 897; *Wil.* 876); the sentence of Alfenius Senecio, then subprefect of the *classis praetoria Misensensis*, belonging to the beginning of the 3rd century, formerly existing at Naples (*C.I.L.* x. 3334); and some others of the 4th and 5th centuries, not requiring a specific mention here. Quite a collection of epistles of high Roman functionaries is found in the celebrated inscription of Thorigny (Mommsen, *Épistoles des hauts fonctionnaires de l'empire romain*, p. 235 sq.). The letter of a provincial functionary, a priest of Gallia Narbonensis, to the *fabri subaedani* of Narbonne, of the year 149, may also be mentioned (*Henz.* 7215; *Wil.* 696 a). To these must be added the *tabulae alimentariae*, relating to the well-known provision made by Trajan for the relief of distress among his subjects, such as that of the Ligures Baebiani (*C.I.L.* ix. 1455; *Wil.* 2844) and that of Veleia near Parma (*Wil.* 2845); while evidence of similar institutions is furnished by inscriptions at Tarracina, at Sicca in Africa, and at Hispalis in Spain (*Wil.* 2846-2848; *C.I.L.* ii. 1174). At the close of this long list of official documents may be mentioned the *bellus* of the *praecurator operum publicorum a columna divi Marci* of the year 193 (*C.I.L.* vi. 1585; *Orel.* 39; *Wil.* 2840) and the *interlocutions* of the *praefecti vigilionum* on a lawsuit of the *Fulones* of Rome, of A. D. 244, inscribed on an altar of Hercules (*C.I.L.* vi. 266; *Wil.* 100). These documents form a most instructive class of instruments.

5. Many documents, as may be supposed, were connected with religious worship, public and private. The oldest *lex templi*, which continued in force until a comparatively late period, was the regulation given by Servius Tullius to the temple of the Aventine, after the conclusion of the federal pact with the Latini, noticed above. Mention is made of this ancient law as still in force in two later documents of a similar character, viz. the dedication of an altar to Augustus by the plebs of Narbo in southern France, of A. D. 764, but existing only, at Narbonne, in a copy, made perhaps in the 2nd century (*C.I.L.* xii. 4333; *Orel.* 2489; *Wil.* 104), and that of an altar of Jupiter, dedicated at Salonae in Dalmatia in A. D. 137, still existing in part at Padua (*C.I.L.* iii. 1933; *Orel.* 2490; *Wil.* 163). Another *lex templi* still existing is that of a temple of Jupiter Liber at Furfio, a civitas of southern Italy, of the year 606 (88 B. C.), but copied in vernacular language, from an older original (*C.I.L.* i. 603; *Orel.* 2488; *Wil.* 105; compare Jordan in *Hermes*, vol. vii., 1872, pp. 201 sq.). The lists of objects belonging to some sanctuaries or to the ornaments of statues are curious, such as those of the *Diana Nemorensis* at Nemi (*Henz.* *Hermes*, vol. vi., 1871, pp. 8 sq.), and of a statue of Isis in Spain (*Hübner.* *Hermes*, vol. i., 1866, pp. 345 sq.; compare *C.I.L.* ii. 2060, 3386, *Orel.* 2510, *Wil.* 210), and two *synopses* from a temple at Cirra in Africa (*Wil.* 2736, 2737). The *sortes* given by divinities may also be mentioned (see *C.I.L.* i. 267 *Wil.* 2822). The *sortes* also, though in a secular character, belonged to a monument of the highest historical importance, viz. the *Index rerum a se restarum*, incised on bronze slabs, copies of which Augustus ordered to be placed, in Latin and Greek,

where required, in the numerous Augustae erected to himself in company with the Dea Roma. This is known as the *Monumentum Aeneanum*, because it is at Angora in Asia Minor that the best preserved copy of it, in Greek and Latin, exists; but fragments remain of other copies from other localities (see *C.I.L.* iii. 779 sq., and the special editions of Mommsen, Berlin, 1865, and Bergk, Göttingen, 1873). Among the inscriptions relating to sacred buildings, which may be reckoned the numerous fragments of the calendars, or *fasti anni Juliani*, found at Rome and other places, which have been arranged and fully explained by Mommsen (*C.I.L.* i., 2nd ed., part ii.; compare for those found in Rome, *C.I.L.* vi. 2294-2306). Local, provincial or municipal *coledentaria* have likewise been found (as the *feriale Cumanum*, *C.I.L.* i. part ii. p. 229, and the *Capuanum*, *C.I.L.* x. 3792). Many other large monumental inscriptions bear some relation, more or less strict, to sacred or public buildings. Along with the official calendar exhibited on the walls of the residence of the *pontifex maximus*, the list of the eponymous magistrates, inscribed by the order of Augustus on large marble slabs, was publicly shown—the *fasti consulares*, the reconstruction and illustration of which formed the life-work of Borghesi. These have been collected, down to the death of Augustus, by Henzen, and compared with the additional written testimonies, by Mommsen, in the *Corpus* (vol. i., 2nd ed., part ii.), along with the *acta triumphorum* and other minor fragments of *fasti* found in various Italian communities, while the *fasti sacerdotum publicorum populari Romani*, together with the *tabulae feriarum Latinarum*, are given in the volume devoted exclusively to the monuments of Rome (vol. vi. 441 sq.; compare *Fasti Romani*, Berlin, 1875, pp. 137-138, and *Orel.* 95-105, iii. 74, 205 sq.). Documents of the same kind, as, for example, the *album ordinis Thamugadensis* from Africa (*C.I.L.* viii. 2403, 17903), and a considerable mass of military lists (*litterulae*, of which those belonging to the garrison of the metropolis are brought together in *C.I.L.* vi. 651 sq.), are given on many dedicatory and honorary monuments, chiefly from Lambaesis in Africa (*C.I.L.* viii.). As those documents, though having only a partial claim to be ranked with the sacred ones, derive, like many other dedicatory monuments, their origin and form from the class, so also the protocols (*acta*), which, as important downwards, have been preserved, on account of the increase of all important *collegia magistratuum*, now survive only from one of the largest and most distinguished *collegia sacerdotum*, in the *acta collegii fratrum Arvalium*, to which Marini first drew the attention of epigraphists; they form one of the most important masses of epigraphic monuments preserved to us in the Latin language (see *C.I.L.* vi. 459 sq., *Ephem. epigr.* ii. 211 sq., and Henzen's *Acta fratrum Arvalium*, Berlin, 1874).

6. Another species of instruments is formed by private documents. These may be incidentally preserved (indeed, for instance, into sepulchral and honorary inscriptions), in the latter period, infrequently in monumental form, as the testaments, given partly or in full, mentioned above (viz. that of Dasumius and the Gaul, *C.I.L.* vi. 10229, *Wil.* 314, 315, and some *capita testamentorum* or *codicilli*, as that of M. Meconius Leo found at Poetelia—*C.I.L.* x. 113, 114; *Orel.* 3677, 3678; *Wil.* 696), and the donations, such as those of T. Flavius Synthropus (*C.I.L.* vi. 10239; *Wil.* 313), of T. Flavius Artemidorus (*Wil.* 316), of Stata Irene and Julia Monime (*C.I.L.* vi. 10231, 10247; *Wil.* 311, 318). Of a peculiar description is the *pactum fiduciae*, found in Spain, engraved on a bronze tablet, and belonging in all probability to the 1st century (*C.I.L.* ii. 5042), which seems to be a formularly. Other documents relating to private affairs exist in their original form, written on *tabellae ceratae*. Those found together in a mining district of Dacia have been arranged and explained by Mommsen and Zangemeister (*C.I.L.* iii. 291 sq., with facsimiles); those found at Pompeii in 1875, containing receipts of the banker L. Caecilius Jucundus, have been published in *C.I.L.* iv. suppl.). These documents are written in cursive letters; and so mostly, too, are some other curious private monuments, belonging partly to the sacred inscriptions—the *defixiones* (cf. *Tac. Ann.* ii. 69), imprecations directed against persons suspected of theft or other offences, who, according to a very ancient superstition, were in this way believed to be delivered to punishment through the god to whom the *defixio* was directed. The numerous Greek and Latin (and even Oscan) examples of this usage have been brought together by Audoulet, *Defixionum tabellae quotquot innotuerunt tam in Graecis Orientis quam in totius Occidentis partibus proter Atticos* (Paris, 1904); compare *C.I.L.* i. 818-820, *C.I.L.* vii. 149). Only a few of them are incised on stone (as that to the *Dea Aiacina* from Spain, *C.I.L.* ii. 462); for the most part they are written in cursive letters, or in very debased capitals, on small bronze or lead tablets (see *C.I.L.* i. 818, 819; *Henz.* 6114, 6115; *Wil.* 2747, 2748). To be incised in the tombs of the "defixi," or deposited in the sanctuaries of some divinity.

7. Many of the private documents just alluded to have not a monumental character similar to that of the other inscriptions in the wider sense of the word, as they are written on materials not very durable, such as wood and lead—in the majority of cases, in cursive characters; but, nevertheless, they cannot be classed as literary documents, as they are usually the records of important events, some documents, public and private, which necessarily lack the strict monumental character, but still are to be reckoned among inscriptions. These are the inscriptions painted or scratched (*graphiti*) on

the walls of the buildings of ancient towns, like Pompeii, where, as was to be expected, most of them have been preserved, those from other ancient cities buried by the eruptions of Vesuvius and from Rome being very small in number. All the various classes of these inscriptions—public and private advertisements, citations for the municipal elections, and private scribbles of the most diverse (and sometimes most indecent) character, one partly collected by Chr. Wordsworth (*Inscriptiones Pompeianae*, &c., London, 1837, 1846)—are now arranged by Zangemeister in the *Corpus*, vol. iv, with supplement (some specimens in Wil. 1957-84), whence their peculiar palaeographic and epigraphic rules may be learned. And, lastly, as related to some of these advertisements, though widely differing from them in age and character, may be mentioned the so-called *diptycha consularia*, monuments, in the first instance, of the still very respectable skill in this branch of sculpture to be found at this late period. They are carved-ivory tablets, in the form of *pugillaria*, and seem to have been invitations to the solemnities connected with the accession of high magistrates, especially to the spectacles of the circus and amphitheatre; for they contain, along with representations of such spectacles, the names, and often the portraits, of high functionaries, mostly of the 5th and 6th centuries. Since Gori's well-known work on this class of monuments (*Thesaurus veterum diptychorum*, &c., 3 vols., Florence, 1759) no comprehensive collection of them has been published, but a full list is given by H. de Villefosse in the *Gazette Archéologique* of 1884; as specimens see *C.I.L.* ii. 2699, and v. 8120, 1-9.

**BIBLIOGRAPHY.**—As a "Textbook" of Roman epigraphy R. Cagnat, *Cours d'épigraphie latine* (3rd ed., Paris, 1898, with supplement, 1904) can be heartily recommended. But students must be warned against Zell's *Handbuch der römischen Epigraphik* (12 vols., Heidelberg, 1850-1852), an unsatisfactory work which is open to serious criticism. J. C. Egbert's *Introduction to the Study of Latin Inscriptions* (1896) is designed for American and English students. For Christian inscriptions Le Blant's *Manuel d'épigraphie chrétienne d'après les marbres de la Gaule* (Paris, 1869) may well be consulted with advantage. (E.Hü.; W. M. L.)

**INSECT**, the anglicized form of the Late Lat. *insectum*, used by Pliny in his *Natural History* as the equivalent of the Gr. *ἔρπον*. Aristotle had included in one class "Entoma" the six-legged arthropods which form the modern zoological class of the Hexapoda or Insecta, besides the Arachnida, the centipedes and the millipedes. The word was introduced to English readers in a translation (1601) of Pliny's *Natural History* by Philemon Holland, who defined "insects" as "little vermine or small creatures which have (as it were) a cut or division between their heads and bodies, as pismires, flies, grasshoppers, under which are comprehended earthworms, caterpillars, &c." Few zoological terms have been more loosely used both by scientific and popular writers. The definition just quoted might include all animals belonging to the groups of the Arthropoda and Annelida, and U. Aldrovandi in *De animalibus insectis* (1602) almost contemporaneously distinguished between "terrestrial insects," including woodlice, earthworms and slugs, and "aquatic insects," comprising annelids and starfishes. Perhaps the widest meaning ever attached to the word was that of R.A.F. de Réaumur, who "would willingly refer to the class of insects all animals whose form would not allow them to be placed in the class of ordinary quadrupeds, in that of birds, or in that of fishes. The size of an animal should not suffice to exclude it from the number of insects. . . . A crocodile would be a terrible insect; I should have no difficulty, however, in giving it that name. All reptiles belong to the class of insects, for the same reasons that earthworms belong to it."

The class Insecta of Linnaeus (1758) was coextensive with the Arthropoda of modern zoologists. The general practice for many years past among naturalists has been to restrict the terms "Insecta" and "insect" to the class of Arthropods with three pairs of legs in the adult condition: bees, flies, moths, bugs, grasshoppers, springtails are "insects," but not spiders, centipedes nor crabs, far less earthworms, and still less slugs, starfishes or coral polyps.

For a general account of the structure, development and relationships of insects, see ARTHROPODA and HEXAPODA, while details of the form, habits and classification of insects will be found in articles on the various orders or groups of orders (APTERA, COLEOPTERA, DIPTERA, HEMiptERA, HYMENOPTERA, LEPIDOPTERA, NEUROPTERA, ORTHOPTERA, THYSANOPTERA, and in special articles on the more familiar divisions (ANT, BEE, DRAGON-FLY, FARRING, &c.). The history of the study of insects is sketched under ENTOMOLOGY. (G. H. C.)

**INSECTIVORA**, an order of non-volant placental mammals of small size, with a dentition adapted to an insect-diet. In nearly all cases these creatures are nocturnal, and the majority are terrestrial, many burrowing in the ground, although a few are arboreal and others aquatic. They have plantigrade or partially plantigrade feet, that is to say, they apply the whole or the greater portion of the soles to the ground when walking; and there are generally five toes, each terminating in a claw, and the first never being opposable to the others in either the fore or hind limb. A full series of differentiated teeth, including temporary or deciduous milk-molars, is developed, and the cheek-teeth have distinct roots and are crowned with sharp cusps, which in some instances are three in number and arranged in a triangle. Very frequently the number of the teeth is the typical four-tooth, arranged as  $i. \frac{3}{3}, c. 1, p. \frac{1}{1}, m. \frac{3}{3}$ , but occasionally there is a fourth pair of molars, while the incisors may be reduced to two pairs above and one below, and the canine is frequently like an incisor or a premolar. The skull is of a primitive type, often with vacuities on the palate, as in marsupials, with a small brain-chamber, and the tympanic bone generally ring-like instead of forming a bladder-shaped bulla; except in the African *Potamogale*, clavicles, or collar-bones, are always present; the humerus generally has a perforation on the inner side of its lower extremity; and a centrale bone is usually present in the carpus. In the brain the smooth hemispheres are so short as to leave the cerebellum and sometimes even the corpora quadrigemina exposed. The uterus is two-horned; the placenta, so far as known, is deciduate and discoidal; the testes are abdominal or inguinal; and the teats usually numerous. The body in several instances is covered with sharp spines in place of hair.

The great majority of the Insectivora are nocturnal in their habits, and their whole structure indicates an extremely low grade of organisation, fully as low as that of marsupials. It is noteworthy that the dentition in several of the groups approximates to that of the extinct mammals of the Jurassic epoch (see MARSUPIALIA), and exhibits more or less distinctly the primitive tribitubercular type. Although the past history of the group is very imperfectly known, it seems probable that the Insectivora are nearly related to the original primitive mammalian stock. Indeed, it has been stated that were it not for the apparently advanced type of placenta, they might easily be regarded as the little modified descendants of the ancestors of most other mammals. Probably they are in some way related to the creodont carnivores (see CREODONTA), but if, as has been suggested, the latter are akin to the primitive ungulates, the connexion would seem to be less close than has been sometimes supposed.

Representatives of this order are found throughout the temperate and tropical parts of both hemispheres, with the exception of South America (where only a few shrews have effected an entrance from the north) and Australia, and exhibit much variety both in organization and in habit. The greater number are cursorial, but some (*Talpa*, *Chrysochloris*, *Myzomela*) are burrowing, others (*Limnogale*, *Potamogale*, *Nectogale*, *Oryzogale*) aquatic, and some (*Tupaia*idæ) arboreal. To the great majority the term insectivorous is applicable, although *Potamogale* is said to feed on fish, and the moles live chiefly on worms. Notwithstanding the nature of their food, much variety prevails in the form and number of the teeth, and while in many cases the division into incisors, canines, premolars and molars may be readily traced, in others, forming the great majority of the species, such as the shrews, this is difficult.

In most cases the brain-cavity is of small relative capacity, and in no instance is the brain-case elevated to any considerable extent above the face-line. The facial part of the skull is generally much produced, and the premaxillary and nasal bones well developed; but the cheek, or zygomatic arch, is usually slender or deficient, the latter being the case in most of the species, and post-orbital processes of the frontals are found only in the *Tupaia*idæ and *Macroscelididae*. The number of dorsal vertebrae varies from 13 in *Tupaia* to 10 in *Centetes*. of lumbar from 3 in *Chrysochloris* to 6 in *Talpa* and *Sorex*, and of caudal from

the rudimentary vertebrae of *Centetes* to the 40 or more well-developed ones of *Microgale*.

The breast-bone, or sternum, is variable, but generally narrow, bilobate in front and divided into segments. The shoulder-girdle presents extreme adaptive modifications in the mole, in relation to the use of the fore-limbs in burrowing; but in the golden moles the fore-arm and fore-foot alone become specially modified. In *Macroscelides* the bones of the fore-arm are united at their lower ends, but in all other Insectivora the radius and ulna are distinct. The fore-foot has generally five digits; but in *Rhynchocyon* and in one species of *Oryzorictes* the first toe is absent, and in the moles it is extremely modified. The femur has, in most species, a prominent ridge below the greater trochanter presenting the characters of a third trochanter. In *Tupaia*, *Centetes*, *Hemicentetes*, *Ericulus* and *Solenodon* the tibia and fibula are distinct, but in most other genera united. The hind-foot consists usually of five digits (rarely four by reduction of the first), and in some, as in the leaping species (*Macroscelides*, *Rhynchocyon*), the tarsal bones are elongated. The form of the pelvis, and especially of the symphysis pubis, varies within certain limits, so that while in the *Tupaioidea* and *Macroscelidoidea* there is a long symphysis, in the *Erinaceidae*, *Centetidae* and *Potamogalidae* it is short, and in the *Soricidae*, *Talpidae* and *Chrysochloridae* there is none.

Owing to the similarity in the character of the food, the truly insectivorous species, forming more than nine-tenths of the order, present little variety in the structure of the digestive organs. The stomach is a simple, thin-walled sac; sometimes as in *Centetes*, with the pyloric and oesophageal openings close together; the intestinal canal has much the same calibre throughout, and varies from three (in the shrews) to twelve times (in the hedgehogs) the length of the head and body. In the arboreal *Tupaia* and the allied *Macroscelidoidea*, which probably feed on vegetable substances as well as insects most of the species possess a caecum. The liver is deeply divided into lobes, the right and left lateral being cut off by deep fissures; both the caudate and Spiegelian lobes are generally well developed, and the gall-bladder, usually large and globular, is placed on the middle of the posterior surface of the right central lobe.

All the members of the order appear to be highly prolific, the number of young varying from two to eight in the hedgehog, and from twelve to twenty-one in the tenrec. The position of the milk-glands and the number of teats vary greatly. In *Solenodon* there is a single pair of post-inguinal teats, but in most species these organs range from the thorax to the abdomen, varying from two pairs in *Gymnura* to twelve in the tenrec. In the golden moles the thoracic and inguinal teats are lodged in deep cut-shaped depressions.

Scent-glands exist in many species. In most shrews they occur on the sides of the body at a short distance behind the axilla, and their exudation is probably protective, as few carnivorous animals will eat their dead bodies. In both species of *Gymnura* and in *Potamogale* large pouches are situated on each side of the rectum, and discharge their secretions by ducts, opening in the first-named genus in front of and in the latter within the margin of the vent. In the tenrec similarly situated glands discharge by pores opening at the bottom of deep pits.

The skin is thin, but in many species lined with well-developed muscles, which are probably more developed in hedgehogs than in any other mammals. In this family and in the tenrec most of the species are protected by spines implanted in the skin-muscle, or panniculus carnosus.

The Insectivora may be divided into two groups, according to the degree of development of the union between the two halves of the pelvis. The first group is characterized by the full development of this union, both pubis and ischium entering into the symphysis. The tympanum remains as a ring within an auditory bulla; the orbit is either surrounded by bone, or separated from the hinder part of the skull by a post-orbital process of the frontal; the upper molars have broad S-cusped crowns with a W-shaped pattern; and the intestine is generally furnished with a caecum. The first family of this group is the *Tupaioidea*, represented by the tree-shrews, or tupaia of the Indo-Malay countries, characterized by the complete bony ring round the

eye-socket, the freedom of the fibula from the tibia in the hind-limb, and the absence of any marked elongation of the tarsus. The dental formula is  $i. \frac{3}{1}, c. \frac{1}{1}, p. \frac{1}{1}, m. \frac{5}{3}$ , total 38. In appearance and habits tree-shrews are extremely like squirrels, although they differ, of course, in *loto* as regards their dentition. A large number of species are included as the typical genus *Tupaia*, which ranges from north-eastern India to the great Malay Islands. In these animals the tail has a fringe of long hairs on opposite sides throughout its length. In the pen-tailed tree-shrew (*Ptilocercus lowii*, fig. 1, the only representative of its genus, and a native of Sumatra, Borneo and the Malay Peninsula, the fringes of long hair are confined to the terminal third of the tail. There are also differences in the skulls of the two genera. A third genus, *Urogale*, represented by *U. cyrenandra* of the mountains of Mindanao, in the Philippines, and *U. everetti*, of Borneo, has been established for the round-tailed tupaia, in which the tail is uniformly short-haired, and the second upper incisor and the lower canines are unusually large, the third lower incisor being proportionately small, and also erect, while the second upper incisor resembles a canine. (See TREE-SHREW.)

In Africa the tupaia are apparently represented by the jumping-shrews, or elephant-shrews (so called from their elongated muzzles), constituting the family *Macroscelidoidea*. From the *Tupaioidea* the members of this family are readily distinguished by the fact that the socket of the eye, in place of having a complete bony ring, is separated from the hinder part of the skull merely by a post-orbital process of



FIG. 1.—Pen-tailed Tree-Shrew (*Ptilocercus lowii*).

the frontal bone, and also by the more or less marked elongation of the tarsus or lower portion of the hind-limb; another feature being the union of the lower ends of the tibia and fibula. As indicated by one of their names, the members of the group leap after the fashion of gerbils, or jerboas, and hence walk much more on their toes than the majority of the order. In the typical genus *Macroscelides*, which ranges all over Africa and has numerous specific representatives, the dental formula is  $i. \frac{3}{1}, c. \frac{1}{1}, p. \frac{1}{1}, m. \frac{2}{2}$  or  $\frac{3}{3}$ , total 40 or 42; while there are five toes to each foot, and the lower ends of the radius and ulna are united. In *Potamodromus* (fig. 2) of East Africa, there are only four front-toes, and the hairs on the lower part of the tail form stiff bristles, with swollen tips; the dental formula being the same as that of those species of *Macroscelides* as have only two lower molars. A further reduction of the number of the digits takes place in the long-nosed jumping-shrews of the genus *Rhynchocyon*, which are larger animals with a much longer snout, only four toes to each foot, and a dental formula of  $i. \frac{1}{0}$  or  $\frac{3}{3}, c. \frac{1}{1}, p. \frac{1}{1}, m. \frac{5}{2}$ , total 36 or 34.

Some of the species, all of which are East African, differ from the members of the typical genus by the deep rufous brown instead of olive-grey colour of their coat. (See JUMPING-SHREW.)

In the second group, which includes all the other members of the order, the pelvic symphysis is either lacking or formed merely by the epiphyses of the pubes; the orbit and temporal region of the skull are confluent; and, except in the *Talpidae* and *Chrysochloridae*, the tympanum is ring-like, the tympanic cavity being formed by the alisphenoid and basisphenoid bones. The upper molars are triconodont, being either of the typical or a modified

form of what is known as the tritubercular sectorial type. There is no caecum.

The first representatives of this group are the moles, or *Talpidae*, in which the lower ends of the tibia and fibula are united (fig. 3, *Moles*).

*Moles.* The bladder-like bulla, the zygomatic, or cheek-arch, although slender, is complete, there is no pelvic symphysis, the upper molars are five-cusped, and the first upper incisor is simple, and the lower vertical. In habits the majority of the family are burrowing, but a few are aquatic; and all feed on animal substances. The distribution is limited to the temperate regions of Europe, Asia and North America.

Throughout the family the eyes are minute, and in some species are covered with skin; the ears are short and hidden in the fur; and the fore-limbs are generally more or less modified for digging.

The true moles of the genus *Talpa* are the typical representatives of the first subfamily, or *Talpininae*, in which the clavicle (fig. 3, *cl.*) and humerus (*h.*) are very short and broad, while there is an additional sickle-like bone (*fb.*) on the inner side of the fore-foot. In *Talpa* itself the first upper incisor is but little larger than the second, the fore-foot is very broad, and the dental formula is  $i. \frac{2}{2}, c. \frac{1}{1}$  or  $o' \frac{1}{1}$  or  $o'' \frac{1}{1}, m. \frac{3}{3}$ . There are about a dozen species, all confined to



FIG. 2.—Peter's Jumping-Shrew (*Petromodromus tetradactylus*).

the Old World. The variation in the dental formula of some of the best known of these is as follows:—

- $i. \frac{2}{2}, c. \frac{1}{1}, p. \frac{1}{1}, m. \frac{2}{2} \times 2$  (*T. wogura, robusta*).  
 $i. \frac{2}{2}, c. \frac{1}{1}, p. \frac{1}{1}, m. \frac{3}{3} \times 2$  (*T. europaea, caeca, romana, longirostris, micrura*).  
 $i. \frac{2}{2}, c. \frac{1}{1}, p. \frac{1}{1}, m. \frac{2}{2} \times 2$  (*T. leucura, leptura*).  
 $i. \frac{2}{2}, c. \frac{1}{1}, p. \frac{1}{1}, m. \frac{2}{2} \times 2$  (*T. moschata*).

Except in *T. europaea*, the eyes are covered by a membrane. In *T. micrura* the short tail is concealed by the fur. *T. europaea* extends from England to Japan.

*T. caeca* and *T. romana* are found south of the Alps, the remaining species are all Asiatic, two only—*T. micrura* and *T. leucura*—occurring south of the Himalaya.

The genus may be split up into subgenera corresponding with the above table; these subdivisions being sometimes accorded full generic rank. For instance the Japanese *T. wogura* and the Siberian *T. robusta* are often referred to under the ill-sounding titles of *Mogera wogura* and *M. robusta*.

Referring more fully to the European species, it may be mentioned that the mole exhibits in its organization perfect adaptation to its mode of life. In the structure of the skeleton striking departures from the typical mammalian forms are noticeable. The first sternal bone is so much produced as to extend forward as far as a vertical line from the second cervical vertebra, carrying with it the very short almost quadrate clavicles, which are articulated with it the very short extremity and externally with the humeri, being also connected ligamentously with the scapula. The fore-limbs are thus brought opposite the sides of the neck, and from this position a threefold advantage is derived:—in the first place, as this is the narrowest part of the body, they add little to the width, which, if increased, would lessen the power of movement in a confined space; secondly this position allows of a longer fore-limb than would otherwise be

possible, and so increases its lever power; and, thirdly, although the entire limb is relatively short, its anterior position enables the animal, when burrowing, to thrust the claws so far forward as to be in a line with the end of the muzzle, the importance of which is evident. Posteriorly, we find the hind-limbs removed out of the way by approximation of the hip-joints to the centre line of the body.

This is effected by inward curvature of the innominate bones at the acetabulum to such an extent that they almost meet in the centre, while the pubic bones are widely separated behind. The shortness of the fore-limb is due to the humerus, which, like the clavicle, is so reduced in length as to present the appearance of a flattened X-shaped bone, with prominent ridges and deep depressions for the attachments of powerful muscles. Its upper extremity presents two rounded prominences; the smaller, the true head of the bone, articulates as usual with the scapula; the larger, which is the external tuberosity rounded off, forms a separate joint with the end of the clavicle. This double articulation gives the rigidity necessary to support the great lateral pressure sustained by the fore-limb in excavating. The bones of the fore-leg are normal, but those of the fore-foot are flattened and laterally expanded.

The great width of the fore-foot is also partly due to the presence of a peculiar bone on the inner side of the palm and articulating with the wrist.

The muscles acting on these modified limbs are homologous with those of cursorial insectivora, differing only in their relative development. The tendon of the biceps traverses a long bony tunnel, formed by the expansion of the *sc.* margin of the bicipital groove for the insertion of the pectoralis major muscle; the anterior division of the latter muscle is unconnected with the sternum, extending across as a band between the humeri, and co-ordinating the motions of the fore-limb. The teres major and latissimus dorsi muscles are of immense size, inserted into the prominent ridge below the pectoral attachment, and are the principal agents in the excavating action of the limb. The cervical muscles connecting the slender scapulae, and through them the fore-limbs, with the centre line of the neck and with the occiput are large, and the ligamentum nuchae between them is ossified. The latter condition appears to be due to the prolongation forwards of the sternum, preventing flexion of the head downwards; and accordingly, the normal office of the ligament being lost, it ossifies,

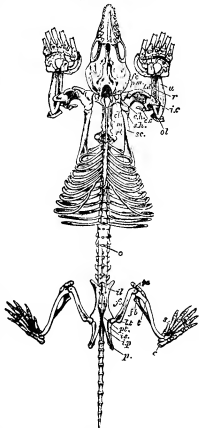

FIG. 3.—Skeleton of Mole (*Talpa europaea*) (lower jaw removed to show base of skull).

- ca.* Calcaneum.  
*cl.* Clavicular articulation of the humerus.  
*cl.* Clavicle.  
*e.c.* External condyle of humerus.  
*f.* Femur.  
*fb.* Fibula.  
*fb.* Falciform bone (radial sesamoid).  
*h.* Humerus.  
*i.c.* Internal condyle of humerus.  
*il.* Left iliac bone.  
*i.p.* Ramus of the ilium and pubis.  
*isch.* Ischium.  
*l.d.* Ridge of insertion of latissimus dorsi muscle.  
*l.t.* Lesser trochanter.  
*m.* Manubrium sterni.  
*o.* Fourth hypapophysial sesamoid ossicle.  
*olecr.* Olecranon.  
*pb.* Pubic bone widely separated from that of the opposite side.  
*pa.* Patella.  
*p.m.* Ridge for insertion of pectoralis major muscle.  
*p.e.* Pectineal eminence.  
*r.* Radius.  
*rb.* First rib.  
*s.* Plantar sesamoid ossicle corresponding to the radial sesamoid (os falciform) in the manus.  
*sc.* Scapula.  
*sc.h.* Scapular articulation of the humerus.  
*tb.* Tibia.  
*una.* Ulna.



and affords a fixed point for the origins of the superficial cervical muscles.

The skull is long, with slender zygomatic arches; the nasal bones are strong and early become united, and in front of them the nostrils are continued forwards in tubes formed of thick cartilage, the septum between which becomes partially or wholly ossified beneath. There are 7 cervical, 13 dorsal, 6 lumbar, 6 sacral and 10-12 caudal vertebrae; of the dorsal and lumbar there may be one more or there less. The sacral vertebrae are united by their expanded and compressed spinous processes, and all the others, with the exception of the cervical, are closely and solidly articulated together, so as to support the powerful propulsive and fossorial actions of the limbs. The upper incisors are simple chisel-edged teeth; the canine is long and two-rooted; then follow three subequal conical premolars, and a fourth, much larger, and like a canine; these are succeeded by three molars with W-shaped cusps. In the lower jaw the three incisors on each side are slightly smaller, and slant more forwards; close behind them is a tooth which, though like them, must, from its position in front of the upper canine, be considered as the canine; behind it, separated by an interval, is a large double-rooted conical tooth, the first premolar; the three following premolars are like the corresponding teeth above, but smaller, and are succeeded, as above, by the three molars. See MOLE.

In the other members of the *Talpinae*, which are North American, the first upper incisor is much taller than the second. They include the curious star-nosed mole (*Condylura cristata*), which has the typical series of 44 teeth and a series of fleshy appendages round the extremity of the snout; the species known as *Scapanus townsendi*



FIG. 4.—Russian Desman (*Myogale moschata*).

and *Parasclops americanus*, each representing a genus by itself, and characterized by the absence of nasal appendages and the presence of only two pairs of lower incisors; and, finally, *Scalops aquaticus*, in which the dentition is further reduced by the loss of the lower canine, the total number of teeth thus being forty.

Forming a transition to the subfamily *Myogalinae*, in which the clavicle and humerus are typically of normal form, and there is no sickle-shaped bone in the fore-foot, is the Chinese mole (*Scaptonyx piscicauda*), characterized by having the clavicle and humerus of the mole-type tooth, but the foot like that of the under-mentioned *Urotrichus*. The relative proportions of the first and second upper incisors are also as in *Talpa*, but there are only two pairs of lower incisors.

Among the more typical *Myogalinae*, mention may be made of *Dymecodon pilirostris*, from Japan, representing a genus by itself; nearly allied to which are the shrew-moles, as represented by the small and long-tailed *Urotrichus* of Japan, with incisors  $\frac{1}{2}$  and premolars  $\frac{1}{2}$ , and *U. (Neurotrichus) gibbsi* of North America, in which the premolars are  $\frac{1}{2}$ . A still more interesting form is the Tibetan *Urotrichus soricipes*, a non-burrowing species, with the external appearance of a shrew combined with the skull of a mole, the feet being much narrower than in *Urotrichus*, and the dental formula  $\frac{1}{2}, \frac{1}{2}, \frac{1}{2}, \frac{1}{2}, \frac{1}{2}, \frac{1}{2}$ .

The typical representatives of the subfamily are the two European desmans, *Myogale moschata* and *M. pyrenica*, which are aquatic in habits and have the feet webbed and the full series of 44 teeth. The former is by far the largest member of the whole family, its total length being about 16 in. Its long proboscis-like snout projects far

beyond the margin of the upper lip; the toes are webbed as far as the bases of the claws; and the long scaly tail is laterally flattened forming a powerful instrument of propulsion when swimming. This species inhabits the banks of streams and lakes in south-east Russia, where its food consists of various aquatic insects. *M. pyrenica*, living in a similar manner in the Pyrenees, is much smaller, has a cylindrical tail and a relatively long snout.

The Shrew-mole, or, shortly, shrews (*Soricidae*), are closely related to the *Talpidae*, with which they are connected by means of some of the subfamily *Myogalinae*. They are, however, distinguished by the ring-like tympanic, the incompleteness of the zygomatic arch, the tubercular-sectorial type of upper molar, the two-cusped first upper incisor, and the forward direction of the corresponding lower tooth. As a rule they are terrestrial, but a few are aquatic.

The dentition (fig. 5) is characteristic, and affords one of the chief means of classifying this exceedingly difficult group of mammals. There are no lower canines, and always six functional teeth on each side of the lower jaw, but in some rare instances an additional rudimentary tooth is squeezed in between two of the others. The first pair of teeth in each jaw differ from the rest; in the upper jaw they are hooked and have a more or less pronounced basal cusp; in the lower jaw they are long and project horizontally forwards, sometimes with an upward curve at the tip. Behind the first upper incisor comes a variable number of small teeth, of which, when all are developed, the first two are incisors, the third the canine, and the next two premolars; behind these, again, are four larger teeth, of the upper jaw is the canine; which the front one is the last premolar, while the other three are behind which are the three molars. Thus we have in the upper jaw five teeth; in the lower jaw six is typical genus *Sorex* (fig. 5) the dental second incisor, and  $p$  the formula  $\frac{1}{2}, \frac{1}{2}, c, \frac{1}{2}, p, \frac{1}{2}, m, \frac{1}{2}$ , total single premolar.

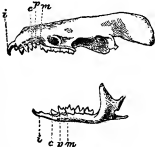

FIG. 5.—Skull and Dentition of a Shrew-mouse (*Sorex-voerapacki*);  $i$ , first incisors;  $c$  in the upper jaw is the canine; and  $p$  and  $m$  the three premolars, while the other three are behind which are the three molars; in the lower jaw  $c$  is typical genus *Sorex* (fig. 5) the dental second incisor, and  $p$  the formula  $\frac{1}{2}, \frac{1}{2}, c, \frac{1}{2}, p, \frac{1}{2}, m, \frac{1}{2}$ , total single premolar.

32, or twenty upper and twelve lower teeth. The lower formula, as already stated, is constant, but the number of the upper series varies from the above maximum of twenty to a minimum of fourteen in *Diplomesodon* and *Anurosorex*, in which the formula is  $\frac{1}{2}, c, \frac{1}{2}, p, \frac{1}{2}, m, \frac{1}{2}$ . From the relation of the fourth upper tooth to the premaxillo-maxillary suture it has been supposed that shrews, like many polyprotodont marsupials, have four pairs of upper incisors; but this is improbable, and the formula is accordingly here taken to follow the ordinary placental type.

Shrews may be divided into two sections, according as to whether the teeth are tipped with brownish or reddish or are wholly white, the former group constituting the *Soricinae* and the latter the *Crociturinae*.

In the red-tipped group is the typical genus *Sorex*, which ranges over Europe and Asia north of the Himalaya Mountains to North America. There are twenty upper teeth with the formula given above, the ears are well developed, the tail is long and evenly haired, and the aperture of the generative organs in at least one of the sexes is distinct from the vent. The common shrew-mouse (*Sorex araneus*) has a distribution co-extensive with that of the genus in the Old World, and the North American *S. richardsoni* can scarcely be regarded as more than a local race. A local species, such as *Sorex hydrodomus* of Alaska and *S. palustris* of the United States, have fringes of long hairs on the feet, and are aquatic in habit. The latter has been made the type of the genus *Neosorex*, but such a distinction, according to Dr J. E. Dobson, is unnecessary. The same authority likewise rejects the separation of the North American *S. bendirei* as *Atophysax*, remarking that this species is an inhabitant of marshy land, and appears to present many characters intermediate between *S. palustris* and the terrestrial species of the genus, differing from the former in the absence of well-defined fringes to the digits, but agreeing with it closely in dentition, in the large size of the infra-orbital foramen, and in the remarkable shortness of the angular process of the lower jaw. In India and Burma the place of *Sorex* is taken by *Soriculus*, in which the upper teeth are generally 18, although rarely 20, and the generative organs have an opening in common with the vent after the fashion of the monotreme mammals. The latter feature occurs in the North American *Blarina*, which is characterized by the truncation of the upper part of the ear and the short tail, the number of upper teeth being 20 or 18. Another American genus, *Notiosorex*, in which the ear is well developed and the tail medium, has only 18 upper teeth. From all the rest of the red-toothed group, the water-shrew, *Neomys* (or *Crossopus*) *jodieni*, of Europe and northern Asia, differs by the fringe of long hairs on the lower surface of the tail; the number of upper teeth being 18.

In the white-toothed, or crocidurine, group, the small African genus *Myosorex*, which has either 18 or 20 upper teeth, includes long-tailed and large-eared species in which the aperture of the generative

organs and the vent, although close together, are yet distinct. In the musk-shrews (*Crocidura*), on the other hand, which are common to Europe, Asia and Africa, the reproductive organs and the alimentary canal discharge into a common cloaca, the long tail is sparsely covered with long and short hairs, there are anal glands secreting a strong musky fluid, and the number of upper teeth is 16 or 18. *Diploesodon pulchellus* of the Kirghiz steppes, has, on the other hand, only 14 upper teeth, and is further characterized by the moderately long tail and the hairy soles of the hind-feet. Another genus is represented by the Tibetan *Aurosorex squamipes*, which has the same dental formula, but a mole-like form, rudimentary tail and scaly hind-soles. Lastly, we have two Asiatic mountain aquatic species, *Chimarrögale himalayaca* of the Himalayas and *Nectogale elegans* of Tibet, which have fringed tails like the European water-shrew, and 16 upper teeth, the former characterized by the small but perfect external ears, and the latter (fig. 6) by the absence of the ears and presence of adhesive disks on the feet.

It will be seen that the red- and the white-toothed series have parallel representative forms, which may indicate that the division of the family into the two groups is one based rather on convenience than on essential differences. See SHREW.

From the shrews, the hedgehogs and gymnuras, or rat-shrews, collectively forming the family *Erinaceidae*, differ structurally by the broader ring made by the tympanic, the complete zygomatic arch, the five-cusped broad upper molars, and the presence of a short

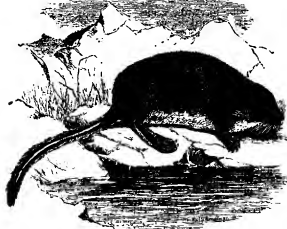

FIG. 6.—The Tibetan Water-shrew (*Nectogale elegans*).

pubic symphysis. At the present day they are an exclusively Old World group.

The typical group, or *Erinaceinae*, is represented only by the hedgehogs, with the one genus *Erinaceus*, easily recognized by their spiny coats, and further characterized by the rudimentary tail, the presence of vacuities in the palate, and the broad pelvis. Hedgehogs (*Erinaceus*) have the dental formula  $i, \frac{1}{1}, c, \frac{1}{1}, p, \frac{1}{1}, m, \frac{1}{1}$ , and are represented by over a score of species, distributed throughout Europe, Africa and the greater part of Asia, but unknown in Madagascar, Ceylon, Burma, Siam, the Malay countries, and, of course, Australia. All the species resemble one another in the armour of spines covering the upper surface and sides of the body; and all possess the power of rolling themselves up into the form of a ball protected on all sides by these spines, the skin of the back being brought downwards and inwards over the head and tail so as to include the limbs by the action of special muscles.

Curiously enough the European hedgehog (*E. europæus*) is the most aberrant species, differing from all the rest in the peculiarly-shaped and single-rooted third upper incisor and first premolar (fig. 7, A), and in its very coarse harsh fur. The dentition of the long-eared Indian *E. grayi* (fig. 7, B) may, on the other hand, be considered characteristic of all the other species, the only important differences being found in the variable size and position of the second upper premolar, which is very small, external and deciduous in the Indian *E. micropus* and *E. pictus*. The former species, limited to South India, is further distinguished by the absence of the jugal bone. Of African species, *E. adenatus*, with long frontal spines, is probably the commonest, and *E. albiventris* has been made the type of a separate genus on account of the total absence of the first front-toe. See HEDGEHOG.

The members of the second subfamily, *Gymnurinae*, are more or less rat-like animals, confined to the Malay countries, and easily distinguished from the hedgehogs by the absence of spines among the fur and the well-developed tail. They also lack

vacuities in the palate, and have a long and narrow pelvis. The typical representative of the family is the greater rat-shrew, or greater gymnura (*Gymnura rafflesii*) a creature which may be com-

pared to a giant shrew, and whose colour is partly black and partly white, although a uniformly pale-coloured race. (*G. r. alba*) inhabits Borneo. In common with the next genus, it has the full series of 44 teeth; and its range extends from Tenasserim and the Malay Peninsula to Sumatra and Borneo, the island individuals being stated to be considerably larger than those from the mainland. In this species the length of the tail is about three-fourths that of the head and body; but in the lesser rat-shrew (*Hylomys sullius*), ranging

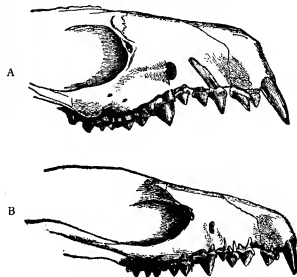

FIG. 7.—Fore-part of Skulls of Common Hedgehog (*Erinaceus europæus*), A, and Gray's Hedgehog (*E. grayi*), B, much enlarged.

from Burma and the Malay Peninsula to Java and Sumatra, the former dimension is only about one-sixth of the latter. In the Philippines the group is represented by *Podogymnura truei*, distinguished from the other genera by the great elongation of the hind-foot, the tail being likewise long. There are only three pairs of pre-molars in each jaw.

In the remaining families of the Insectivora the tibia and fibula may be either separated or united at the lower end; there is no descent of the testes, except in *Solenodon*; a short symphysis is formed by the junction of the pubic epiphyses; and the upper molars are generally small, and triangular, with three cusps arranged in a V. The first family, *Potamogalidae*, is represented by the otter-like *Potamogale velox* of the rivers of West Africa (fig. 8), distinguished from all other

Insectivorous Otter.



FIG. 8.—The Insectivorous Otter (*Potamogale velox*).

members of the order by the absence of clavicles. The tibia and fibula are united inferiorly, the skull has a ring-like tympanic, no zygomatic arch, and the upper molars are of the tuberculo-sectorial type, with broader crowns than in the following families. The dental formula is  $i, \frac{1}{1}, c, \frac{1}{1}, p, \frac{1}{1}, m, \frac{1}{1}$ , total 40. This animal inhabits the banks of streams in west equatorial Africa, and its whole structure indicates an aquatic life. It is nearly 2 ft. in length, the tail measuring about half. The long cylindrical body is continued uninterruptedly into the thick laterally compressed tail, the legs are very short, and the toes are not webbed, progression through the water depending wholly on the action of the powerful tail, while the limbs are folded inwards and backwards. The muzzle is broad and flat and the nostrils are protected by valves. The fur is dark brown

above, the extremities of the hairs on the back being of a metallic violet hue by reflected light, beneath whitish.

In the remaining groups the upper molars form narrow V's of the true tribitubercular type. The family, *Centetidae*, represented by the

**Tenrec.** tenrec and a number of allied animals from Madagascar, is specially characterized by the ring-like tympanic, and the absence of a zygomatic arch and of any constriction of the skull behind the orbits, and the presence of teats on the breast as well as the abdomen. In the more typical members of the family the tibia and fibula are separate, and, as in hedgehogs, spines are mingled with the fur. The true or great tenrec (*Centetes caudatus*), alone representing the typical genus, has the dental formula  $i. \frac{3}{3} \text{ or } \frac{2}{3}, c. \frac{1}{1}, p. \frac{4}{4}, m. \frac{3}{3} \text{ or } \frac{4}{4}$ , total 38, 40, 42 or 44. The fourth lower molar, when developed, does not appear till late in life. Of the long and sharp canines, the tips of the lower pair are received into pits in the upper jaw (fig. 9). The creature grows to a length of about a foot. The



FIG. 9.—Skull of the Tenrec (*Centetes caudatus*), somewhat reduced.

young have strong white spines arranged in longitudinal lines along the back, but these are lost in the adult which has only a crest of long rigid hairs on the nape of the neck. The lesser tenrecs, *Hemicentetes semispinosus* and *H. nigriceps*, are distinguished by the persistence of the third upper incisor and the form of the skull. The two species are much smaller than the great tenrec, and spines are retained in the adult on the body. The hedgehog-tenrec, *Ericulus setosus*, has the whole upper surface, and even the short tail, densely covered with close-set spines. The facial bones are much shorter than in the preceding genera, and the first upper incisors are elongated; while there are only two pairs of incisors in each jaw. Judging from the slight development of the cutaneous muscles compared with those of the hedgehog, it would seem that these creatures cannot roll themselves completely into balls in hedgehog-fashion. A second species of this genus, *Ericulus (Echinops) teljairi*, has two, in place of three, pairs of molars, thus reducing the total number of teeth to 32. Moreover, the zygomatic arches of the skull are reduced to mere threads. Here should perhaps be placed *Geogale aurita*, a small long-tailed Malagasy insectivore, with 34 teeth, and no spines; the tibia and fibula being separate. It has been classed in the *Potamogalidae*, but from its habitat such a reference is improbable.



FIG. 10.—Skull of the Lesser Tenrec (*Hemicentetes spinosus*).

The absence of spines may entitle it to separation from the *Centetinae*, so that it should perhaps be regarded as representing a subfamily, *Geogalinae*, by itself.

The absence of spines coupled with the union of the tibia and fibula form the leading characteristics of the subfamily *Oryzorictinae*, typified by the rice-tenrecs *Oryzorictes*, of which there are several species. These creatures, which excavate burrows in the rice-fields of Madagascar, are somewhat mole-like in appearance, but have tails of considerable length. In the typical *O. hova* the fore-feet are five-toed, but in *O. tetradactylus* the number of front digits is reduced to four. The long-tailed tenrecs (*Microgale*) are represented by fully half-a-dozen species with tails of great length; that appendage in the typical *M. longicaudata* being more than double the length of the head and body, and containing no fewer than forty-seven vertebrae. The teeth are generally similar to those of *Centetes*, but are not spaced in front; their number being  $i. \frac{2}{2}, c. \frac{1}{1}, p. \frac{2}{2}, m. \frac{2}{2}$ , total 40, or

the same as in *Oryzorictes*. Finally, *Limnogale mergulus*, a creature about the size of a black rat, has webbed toes and a laterally compressed tail, evidently adapted for swimming. See TENREC.

All the foregoing are natives of Madagascar. It has been suggested however, that two remarkable West Indian insectivores, namely *Solenodon cubanus* of Cuba (fig. 11) and *S. paradoxus* of Hayti, should be regarded as representing merely a sub-family of *Centetidae*. It is true that the main features distinguishing these strange creatures from the Malagasy representatives of that family are the constriction of the skull behind the

**Solenodon.**



FIG. 11.—*Solenodon cubanus*.

orbits, the descent of the testes into the perineum, and the post-lingual position of the teats, and that none of these are of very great importance. But the geographical positions of the two groups are so widely sundered that it seems preferable to await further evidence before definitely assigning the two to a single family; and the family *Solenodontidae* may accordingly be retained for the West Indian animals. Solenodons, which look like huge long-nosed, parti-coloured rats, have the tibia and fibula separate, and the same dental formula as *Microgale*. Each of the two species (which differ in colour and the quality of the fur) has a long cylindrical snout, an elongated naked tail, feet formed for running, and the body clothed with long, coarse fur. The position of the teats on the buttocks is unique among Insectivora. The first upper incisors are much enlarged, and like the other incisors, canines and premolars, closely resemble the corresponding teeth of *Myogale*; the second lower incisors are much larger than the upper ones, and hollowed out on the inner side.

The last family, *Chrysochloridae*, is represented by the golden moles of South and East Africa, which differ from the *Centetidae* and *Solenodontidae* by the development of a bulla to the tympanic, and the presence of a zygomatic arch to the skull; the tibia and fibula being separate, and the symphysis of the pelvis formed merely by ligament. The skull is not constricted across the orbits. The teats, which are placed both on the

**Golden Mole.**

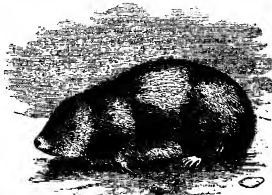

FIG. 12.—A Golden Mole (*Chrysochloris obtusirostris*) reduced.

breast and in the groin, are situated in shallow depressions. The ears are buried in the fur, and the eyes concealed beneath the skin; the feet are four-toed and provided with powerful claws for burrowing

in the fashion of the mole, but it is interesting to note that the skeleton is modified for the same purpose in a manner quite different from that obtaining in the latter animal. These animals derive their name from the metallic iridescence of the fur of most of the species. In the more typical species the dental formula is the same as in *Micregale*, that is to say, there are 40 teeth. In other species, which it has been proposed to separate as *Amblysomus*, there are, however, only 36 to 38 teeth, as in the last of the moles. The group is evidently nearly related to the *Cenetidæ*—most nearly perhaps to the *Oryzorictinæ*.

#### Fossil Insectivora.

Some years ago Dr F. Ameghino, of Buenos Aires, described from the Tertiary formation of Santa Cruz, in Patagonia, the remains of an insectivore under the name of *Necrolestes*. The occurrence of a member of the Insectivora in these beds is remarkable, since this group is represented at the present day in South America only by a shrew or two which have wandered from the north. Dr Ameghino expressed his belief that the extinct Patagonian insectivore was nearly related to the golden moles, and although this opinion appears to have been withdrawn, Professor W. B. Scott states that he is convinced of the close affinity existing between *Necrolestes* and *Chrysochloris*. Although this view may not be accepted, it must be remembered that it represents the opinion of a palaeontologist who has had better opportunities than most of his fellow-workers of forming a trustworthy judgment. So convinced is Dr Scott of the closeness of the relationship between *Necrolestes* and the golden moles that he is expressing probably the former existence of a direct land-connection between Africa and South America. There is no reason, he says, to suppose that the track of migration could have been by way of Europe and North America, for no trace of the group has been found anywhere north of the equator. This supposed connexion between Africa and South America in Tertiary times has often been suggested, and is supported by many independent lines of evidence; and the presumed affinity between the two mammals here referred to adds to the weight of such evidence.

The discovery of the Oligocene Tertiary deposits of Dakota of the remains of a species of hedgehog is a fact of great interest, for the hedgehog-tribe (*Erinacidae*) is at the present day an exclusively Old World group. The discovery of the fossil American species, which has been made the type of a new genus under the name of *Protherix*, serves to strengthen the view that the northern countries of the Western and Eastern hemispheres form a single zoological region; and that formerly there was comparatively free communication between them in the neighbourhood of Bering Sea, under climatic conditions which permitted of temperate forms passing from one continent to the other. As might have been expected, remains of hedgehog-like mammals have been obtained in the Tertiary deposits of Europe. Among these, *Palaeosericanus*, from the Upper Oligocene of France, seems scarcely separable from the existing genus. *Necrogymnurus* (*Neurogymnurus*) from the Lower Oligocene, of the same country, appears to be allied to *Hylomys*, which is itself the most generalised of the family, so that the extinct genus, of which *Calcolotherium* is a synonym, may represent the ancestral type of the *Erinacidae*. The genus *Galerix*, or *Lanthanotherium*, of the Oligocene, which has the typical series of 44 teeth, a bony ring round the orbit, and conjoint tibia and fibula, has been regarded as representing the *Talpidae* and *Macroscelididae*, but is more probably referable to the *Erinacidae*, being apparently akin to *Gymnura*. The moles are represented in the French Oligocene by *Amphidactylus* and in the Miocene by *Talpa*, while in the North American early Tertiary we have the primitive *Talpa*. Shrews are also known from the Lower Oligocene upwards both in the eastern and western hemispheres. Of the Lower Tertiary *Adapisorex*, with the typical set of 22 teeth, *Adapisoriculus* and *Orthospidotherium*, all from France, the affinities are quite uncertain. The American Oligocene *Leptictis*, with *i*, 2, *c*, 1, *p*, 4, *m*, 3 in the upper jaw, and *i*, 2, *c*, 1, *p*, 4, *m*, 3 may be insectivorous mammals, with affinities to the *Carnivora*. It is, indeed, probable that not only is there a relationship between the *Creodonts* and the Insectivora, but also one between the latter and the *Marsupialia*, so that the marked similarity between the cheek-teeth of the insectivorous *Chrysochloris* and the *Marsupial Notacris* may be due to genealogy. That the bats and the flying-lemur are descendants of the Insectivora cannot be doubted.

**BIBLIOGRAPHY.**—G. E. Dobson, "Monograph of the Insectivora" (London, 1883-1890); W. Leche, "Zur Morphologie des Zahn-systems der Insectivoren," *Anatom. Anzeiger* (iii. 1 and 514, 1897); C. J. Forsyth-Major, "Diagnoses of New Mammals from Madagascar," *Ann. Mag. Nat. Hist. ser. 6*, vol. xviii, pp. 318 and 461 (1896); A. A. Mead, "Descriptions of New Mammals from the Philippine Islands," *Proc. U.S. Museum* (xviii. 425, 1905).

**INSECTORIOUS PLANTS.** Insectivorous or, as they are sometimes more correctly termed, carnivorous plants are, like the parasites, the climbers, or the succulents, a physiological assemblage belonging to a number of distinct natural orders. They agree in the extraordinary habit of adding to the supplies of nitrogenous material afforded them in common with other

plants by the soil and atmosphere, by the capture and consumption of insects and other small animals. The curious and varied mechanical arrangements by which these supplies of animal food are obtained and utilized are described under the headings of the more important plants.

The best known and most important order of insectivorous plants—*Droseraceae*—includes six genera: *Byblis*, *Roridula*, *Drosera*, *Droserophyllum*, *Aldrovanda* and *Dionaea*, of which the last three are monotypic, i.e. include only one species. The *Sarraceniaceae* contain the genera *Sarracenia*, *Darlingtonia*, *Heliophora*, while the true pitcher plants or *Nepentheaceae* consist of the single large genus *Nepenthes*. These three orders are closely allied and form the series *Sarraceniaceae* of the free-petalled section (*Choripetalae*) of Dicotyledons. The curious pitcher-plant, *Cephalotus follicularis*, comprises a separate natural order *Cephalotaceae*, closely allied to the *Saxifragaceae*. Finally the genera *Pinguicula*, *Utricularia*, *Genlisea* and *Polypompholix* belong to the gamopetalous order *Lentibulariaceae*.

While the large genus *Drosera* has an all but world-wide distribution, its congeners are restricted to well-defined and usually comparatively small areas. Thus *Droserophyllum* occurs only in Portugal and Morocco, *Byblis* in tropical Australia, and, although *Aldrovanda* is found in Queensland, in Bengal and in Europe, a wide distribution explained by its aquatic habit, *Dionaea* is restricted to a few localities in North and South Carolina. *Cephalotus* occurs only near Albany in Western Australia, *Heliophora* on the Roraima Mountains in Venezuela, *Darlingtonia* on the Sierra Nevada of California, and these three genera too are as yet monotypic; of *Sarracenia*, however, there are seven known species scattered over the eastern states of North America. The forty species of *Nepenthes* are mostly natives of the hotter parts of the Indian Archipelago, but a few range into Ceylon, Bengal, Cochin China, and some even occur in tropical Australia on the one hand, and in the Seychelles and Madagascar on the other. *Pinguicula* is abundant in the north temperate zone, and ranges down the Andes as far as Patagonia; the 250 species of *Utricularia* are mostly aquatic, and some are found in all save polar regions; their unimportant congeners, *Genlisea* and *Polypompholix*, occur in tropical America and south-western Australia respectively. It is remarkable that all the insectivorous plants agree in inhabiting damp heaths, bogs, marshes and similar situations where water is abundant, but where they are not brought into contact with the plentiful supply of inorganic nitrogenous food as are the roots of terrestrial plants.

**INSAIN**, a town of British India, in the Hanthawaddy district of Burma, 10 m. N.W. of Rangoon; pop. (1901) 5350. It is an important railway centre, containing the principal workshops of the Burma railway company, also a government engineering school, a reformatory school and the largest gaol in the province.

**INSOMNIA**, or deprivation of sleep (Lat. *somnus*), a common and troublesome feature of most illnesses, both acute and chronic. It may be due to pain, fever or cerebral excitement, as in *delirium tremens*, or to organic changes in the brain. The treatment, when failure to sleep occurs in connexion with a definite illness, is part of the treatment of that illness. But there is a form of sleeplessness not occurring during illness to which the term "insomnia" is commonly and conveniently applied. It must not be confounded with occasional wakefulness caused by some minor discomfort, such as indigestion, nor with the "bad nights" of the valetudinarian. Real insomnia consists in the prolonged inability to obtain sleep sufficient in quantity and quality for the maintenance of health. It is a condition of modern urban life, and may be regarded as a malady in itself. It is a potent factor in causing those nervous breakdowns ascribed to "overwork." It may occur as a sequel to some exhausting illness, notably influenza, which affects the nervous system long after convalescence. But it very often occurs without any such cause. Professional and business men are the most frequent sufferers. Insomnia is comparatively rare among the poor, who do little or no brain work. It may be brought on by some exceptional strain, by long-continued worry, or by sheer overwork. The broad pathology is simple enough. It has been demonstrated by exact observations that in sleep the blood leaves the brain automatically. The function is rhythmic, like all the vital functions, and the mechanism by which it is carried out is no doubt the vaso-motor system, which controls

the contraction and dilation of the blood-vessels. In sleep the vessels in the brain automatically contract, but when the brain is working actively a plentiful supply of blood is required, and the vessels are dilated. If the activity is carried to great excess the vessels become engorged, the mechanism does not act and sleep is banished. In insomnia this condition has become fixed.

When a breakdown has happened or is pending the only treatment is complete rest, combined, if possible, with change of air and scene; but if the mischief has gone far it will take very long to repair, and may never be repaired at all. In no matter of health is the importance of "taking it early" more pronounced. Delay is the worst economy. A few days' holiday at the commencement of trouble may save months or years of enforced idleness. Sea-air sometimes acts like a charm. But if it is impossible to give up work and leave worry behind, even for a short time, sleep should be carefully wooed by every possible means. In the first place, plenty of time should be devoted to it, and no chance should be missed. That is to say, the night should not be curtailed at either end, and if sleepiness approaches in the daytime, as it often does, it should be encouraged. It is better to lie still at night and try to sleep than to give way to restlessness, and a few minutes snatched in the daytime, when somnolence offers the opportunity, has a restorative effect out of all proportion to the time occupied. Then all accidental causes of disturbance should be avoided. Lights and sounds should be excluded, comfort studied and digestion attended to. Fresh air is a great help. As much time should be spent out of doors as possible, and exercise, even to the point of fatigue, may be found helpful. But this requires watching: in some cases bodily exhaustion aggravates the malady. A little food (e.g. a glass of hot milk) immediately before going to bed is useful in inducing sleep, and persons who are apt to wake in the night and lie awake for hours may obtain relief by the same means. Hypnotic drugs, which have greatly multiplied of late years, should only be taken under medical advice. The real end to aim at is the restoration of the natural function, and the substitution of artificial sleep, which differs in character and effect; tends rather to prevent than to promote that end. It is often possible to induce sleep by rhythmic breathing.

**INSPIRATION** (Lat. *inspirare*, breathe upon or into), strictly the act of drawing physical breath into the lungs as opposed to "expiration." Metaphorically the term is used generally of analogous mental phenomena; thus we speak of a sudden spontaneous idea as an "inspiration." The term is specially used in theology for the condition of being directly under divine influence, as the equivalent of the Greek *θεοπνευστία* (the adjective *θεοπνευστος* is used of the Holy Scriptures in 2 Timothy iii. 16). Similar in meaning is *ἐκθουσιασμός*, enthusiasm (from *ἐκθουσιάζω* from *ἔθεος*). Possession by the divine spirit (*πνεῦμα*) was regarded as necessarily accompanied by intense stimulation of the emotions. The possibility of a human being becoming the habitation and organ of a divinity is generally assumed in the lower religions. In the popular religion of China some of the priests, the *Wu*, claim to be able to take up into their body a god or a spirit, and thereby to give oracles. In wild frenzy they rush about half naked with hair hanging loose, wounding themselves with swords, knives, daggers, and uttering all kinds of sounds, which are then interpreted by people who claim to be able to understand such divine speech. The Maoris at the initiation of the young men into the tribal mysteries sing a song, called "breath," to the mystic wind by which they believe their god makes his presence known. An Australian woman claimed to have heard the descent of the god as a rushing wind. In some savage tribes blood is drunk to induce the frenzy of inspiration; music and dancing are widely employed for the same purpose. Dionysus, the god of wine in Greece, was also the god of inspiration; and in their orgies the worshippers believed themselves to enter into real union with the deity. In Delphi the Pythia, the priestess who delivered the oracles, was intoxicated by the vapour which rose from a well, through a small hole in the ground. As the oracles were often enigmatical, they were interpreted by a *prophet*. In Rome the inspiration of Numa

was derived from the nymph Egeria; and great value was attached to the books of the Cumaean Sibyl. In Arabia the *kahin* (priest) was recognized as the channel of divine communication. Inspiration may mean only possession by the deity, or it may mean further that the person so possessed becomes the channel through which the deity reveals his word and will. (See J. A. Macculloch's *Comparative Theology*, chap. xv., 1902).

Prophecy in the Old Testament in its beginnings is similar to the phenomenon in other religions. Saul and his servant came to Samuel, the man of God, the seer, with a gift in their hands to inquire their way (1 Sam. ix. 8). The companies of prophets who went about the country in Samuel's time were enthusiasts for Yahweh and for Israel. When Saul found himself among them he was possessed by the same spirit (1 Sam. x. 10, 11.) The prophesying in which he took part probably included violent movements of the body, inarticulate cries, a state of ecstasy or even frenzy. The phrase "holy spirit" in Acts, as applied to the Apostolic Church, probably indicates a similar state of religious exaltation; it was accompanied by speaking with tongues, inarticulate utterances, which needed interpretation (1 Corinthians xiv. 27). In every religious revival, when the emotions are deeply stirred, similar phenomena are met with. Such a movement was Montanism in the 3rd century. At the Reformation, while Luther was at the Wartburg, fanaticism broke out, and spread from Wittenberg; prophets went about declaring the revelations which they had received. The Evangelical Revival in the 18th century also had its abnormal religious features. The Revival in Scotland in 1860 was marked by one curious feature—the Gospel dance—when in their excitement men and women got up and spun round and round till they were exhausted. Spontaneous praise and prayer marked the revival in Wales in 1905-1906.

*Prophecy*, as represented by the writings of the prophets, arose out of this state of religious exaltation, but left behind many of its features. Yahweh was believed to guide and guard the history of His chosen people Israel; He controlled the action of the nations that came in contact with His people, so that, using them as His instruments, He might accomplish His purpose. The function of the prophets was to interpret the course of history so as to communicate God's Word and will in judgment or in mercy. They were divinely endowed for this function by their inspiration. While these prophets seem to have continued in the exercise of all their normal faculties, which were stimulated and not suppressed, yet they do claim a distinctive divine activity in their consciousness, and distinguish with confidence their own thoughts from the revealed word. That abnormal psychic states, such as visions and voices, were sometimes experienced is not improbable; but the usual prophetic state seems to have been one of withdrawal of attention from the outer world, absorption of interest in the inner life, devout communion and intercession with God, and the divine response in a moral or a spiritual intuition rather than an intellectual ratiocination. Possession by the Spirit in its external manifestations is ascribed to Gideon, Jephthah, Samson, Saul, Elijah; but even when the same language is used of the later prophets, it is probably such an inward state as has just been described which is to be assumed. A feature inseparable from this later phase of prophecy is *prediction*. For the warning or the encouragement of the people the prophet as Jehovah's messenger declares what He is about to do. Thus the fall of Samaria in 722 B.C., the deliverance of Jerusalem in 701, the overthrow of the kingdom of Judah in 586, the return from exile in 537 were all heralded by prophecy. This prediction was no shrewd political conjecture, but an application to existing conditions of the permanent laws of God's government. The abnormal phenomena of inspiration, the presence and operation of the Holy Spirit, in the Apostolic Church, have already been noticed. While Paul does not deny nor depreciate these charisms, as tongues, miracles, &c., he represents as the more excellent way the Christian life in faith, hope and love (1 Cor. xii. 31). The New Testament represents the Christian life as an inspired life. It is living communion with Christ, and therefore constant possession of the Holy Spirit.

Every Christian in the measure in which he has become a new creature in Christ is a prophet, because he knows by the enlightening of God's Spirit "what is the good and acceptable and perfect will of God" (Romans xii. 2). An occasional state of divine possession in the other religions becomes in the prophets of Israel a permanent endowment for a few select agents of God's revelation; but when that revelation is consummated in Christ, inspiration becomes the universal privilege of all believers.

While there is much superstition in the view of inspiration found in many religions, and much imposture in the claims to the possession of it, yet it would be illogical to conclude that this feature of religion is altogether human error and not at all divine truth. Man's knowledge of God is conditional, and therefore limited by his knowledge of the world and himself, and has accordingly the same imperfection. The reality of a divine communion and communication with man is not to be denied because its nature has been imperfectly apprehended. We must estimate the worth of inspiration by the higher and not the lower stages, by the vision of an Isaiah or the consecration of a Paul; but at the same time we must be prepared to recognize its lowly beginnings.

In dealing with the inspiration of the Bible, to which the use of the term has in the Christian Church been largely restricted, it is important to remember that inspiration is primarily personal; and that it assumes varied forms and allows varying degrees.

Other religions besides Christianity possess their sacred scriptures. The value attached to the Sibylline writings in Rome has already been mentioned. In Greece, Homer and Hesiod were esteemed as authoritative exponents of the mythology; a distinction was made between the poet's own words and the divine element, and what was offensive to reason, conscience or taste was explained allegorically. Hinduism distinguishes two classes of sacred writings, the *S'rutis* (hearing), which were believed to have been heard by inspired men from a divine source, and were endowed with supernatural powers, and the *Smritis* (recollection) derived from tradition. While the poets of the Rig-Veda, the oldest of the holy writings, do not claim inspiration, it is ascribed to them in the highest degree. Some of the Hindu sects—Vaishnavist and Saivist—regard some of the later writings, as also divine revelation. In Zoroastrianism, the books of the *Zend-Avesta* were conceived by later generations at least as having been eternally formed by Ormuzd, and revealed at the creation to his prophet Zoroaster, who, however, guarded the communication carefully in his mind until a very much later date in the world's history. Ormuzd drove Ahriman back to hell by reciting one of the holy hymns. Buddhism has its *Tripitaka* (three baskets), and the reading, reciting and copying of the sacred scriptures is one of the surest means of acquiring merit. But as it ignores the gods, and places Buddha far above them, it does not claim divine inspiration for its writings. Buddha himself enlightens, but every man must save himself by walking in the true way which has been shown to him. Confucianism has its literature of absolute authority on manners, morals, rites and politics, but its claim does not rest on inspiration. These writings are revered as preserving the beliefs and customs of former ages, which are believed to have been more familiar than the present with the Way of Heaven. For the *Koran* very extravagant claims are made by orthodox Islam. Although Mahomet at first feared that his call to be a prophet was a deception of evil spirits, and wished to take his own life, yet afterwards he uttered his decisions on most trivial matters as divine oracles. God preserves the original text of the *Koran* in Heaven, and blots out what He wills and leaves what He wills. By the angel Gabriel God communicated this book word for word to the prophet, so that the *Koran* is a faithful copy of the heavenly book. The angels in heaven read the *Koran*. While the orthodox theology asserted the eternity of the *Koran*, the Mo'tazilite school denied this for the reason that the spoken sounds and the written signs in which alone a revelation could be given must have come to be in time. As Islam was not altogether independent of Christianity and Judaism, this doctrine of the *Koran* was probably intended

as a reply to the claims of Jews and Christians for their holy writings.

The Pentateuch was accepted as authoritative law by the Jewish Church in 444 B.C. About two centuries later the Prophets (including the histories as well as the prophetic writings proper) were also acknowledged as sacred scriptures, although of inferior authority to the Law. In the century before the Christian era the Writings, including Psalms and Proverbs, were included in the Canon. Palestinian and Hellenistic Judaism disagreed about the recognition of the books now known as the Apocrypha. The writers of the New Testament use the Old Testament as holy scriptures, as an authoritative declaration of the mind and will of God; but the inaccuracy of many of the quotations, together with the use of the Greek translation as well as the original Hebrew, forbid our ascribing to them any theory of verbal inspiration. By the middle of the 2nd century the four Gospels were probably accepted as trustworthy records of the life of Jesus. The Epistles were accepted as authoritative in virtue of apostolic authorship. By the end of the 3rd century the use and approval of the churches had established the present canon.

The doctrine of the inspiration of these writings in the Jewish and Christian Church now claims attention. Inspiration is first of all ascribed to persons to account for abnormal states, or exceptional powers and gifts; in this doctrine it is transferred to writings, and its effects in securing for these inerrancy, authority, &c., are discussed with little regard for the psychic state of the writers.

The New Testament affirms the inspiration of the Old Testament. Jesus introduced a quotation from the 110th Psalm with the words "David himself by the Holy Spirit said" (Mark xii. 36), and in appealing to the law against tradition He used the phrase "God said" (Matt. xv. 4). The author of the first Gospel describes a prediction as that "which was spoken by the Lord through the prophet" (Matt. i. 22), and so Peter refers to "the scripture which the Holy Spirit spake before by the mouth of David" (Acts i. 16). For Paul as for Peter the utterances of the Old Testament are "the oracles of God" (Romans iii. 2; 1 Peter iv. 11). The final appeal is to what is written. God spoke in the prophets (Romans ix. 25; Hebrews i. 1). The use of *θεβρεωτοτος* in regard to the Scriptures in 2 Timothy iii. 16 has already been noted. The Spirit of Christ is said to have been in the prophets (1 Peter i. 11); and it is affirmed that "no prophecy ever came by the will of man; but men spake from God, being moved by the Holy Spirit" (2 Peter i. 21). The constant use of the Old Testament in the New confirms this doctrine of inspiration. Contemporary Jewish thought was in agreement with this view of the Old Testament. Philo describes Moses as "that purest mind which received at once the gift of legislation and of prophecy with divinely inspired wisdom" (*De congr. erud.* c. 24). Josephus again and again expresses his deep reverence for the holy Scriptures, and his belief that the authors wrote under the influence of the Spirit of God. According to Weber the doctrine of the Talmud is that "the holy scripture came to be through the inspiration of the Holy Spirit, and has its origin in God Himself, who speaks in it." But the nature of this inspiration must be more closely defined, and hence have arisen a number of theories of inspiration.

The first theory is that of *mechanical dictation*, or *verbal inspiration*. The writers of the books of the Bible were God's pens rather than His penmen; every word was given them by God. Their faculties were suppressed that God alone might be active in them. This conception is found in Plato, "God has given the art of divination, not to the wisdom, but to the foolishness of man. No man, when in his wits, attains prophetic truth and inspiration; but when he receives the inspired word, either his intelligence is entranced in sleep, or he is demented by some distemper or possession" (*Timaeus*, 71). Philo declares that "the understanding that dwells in us is ousted on the arrival of the Divine Spirit, but is restored to its own dwelling when that Spirit departs, for it is unlawful that mortal dwell with immortal" (*Quis ror. div. haeres.* c. 53). Athenagoras adopted this view

in regard to the prophets. "While entranced and deprived of their natural powers of reason by the influence of the Divine Spirit, they uttered that which was wrought in them, the spirit using them as its instrument, as a flute player might blow a flute." Other figures used are these; the inspired writer was the lyre, and the Holy Spirit the plectrum, or the writer was the vase, and the Holy Spirit filled it. The extravagances of Montanism threw some discredit on this conception, and we find Miltiades writing a treatise with the title *That the Prophet ought not to speak in Ecstasy*. But Gregory the Great called the writers of Scripture the *calami* of the Holy Spirit. After the Reformation the Protestant Scholastics revived this view. Gerhard, Calovius and Quenstedt agree in ascribing to the Scriptures absolute infallibility in all matters, and describe the writers as "amanuenses of God, or Christ," "hands of the Spirit," "clerks," "secretaries," "manus et Spiritus sive." The *Formula consensus Helvetica* probably reaches the extreme statement, when it declares that the Old Testament was "tum quod consonans, tum quod vocalia, sive puncta ipsa, sive punctorum saltem potestatem, et tum quoad res, tum quoad verba *debeverunt*." Seeing that the vowel-point system was introduced by Jewish scribes centuries after the books were written, this statement shows how recklessly they may override fact. Of this theory, which has now few advocates, it is sufficient to say that it ignores all the data the Bible itself offers. On the one hand it is impossible to maintain the inerrancy of the Bible in matters of science, philosophy, history, and even in doctrine and morals there is progress; on the other hand the personal characteristics, the historical circumstances, the individual differences of the writers are so reproduced in the writings that the action of the human factor must be frankly and fully recognized as well as the divine activity.

The second theory is that of *dynamic influence or degrees of inspiration*. While the Spirit controls and directs, the human personality is not entirely suppressed. Even Philo recognized that all portions of Scripture were not equally inspired, and assigned to Moses the highest degree of inspiration. The Jewish rabbis placed the Law, the Prophets and the Writings on a descending scale of inspiration. "The schoolmen followed them, and some distinguished four degrees of influence: *superintendence*, which saved from positive error; *elevation*, which imparted loftiness to the thought; *direction*, which prompted the writer what to insert and what to omit; and *suggestion*, which inspired both thoughts and words" (M. Dods, *The Bible, its Origin and Nature*, p. 118, 1905). The co-operation of the divine and the human factors is recognized in Augustine's saying about the authors: "Inspiratus a Deo, sed tamen homo." It is interesting to note that Plutarch had to account for the same human peculiarities and imperfections in the Pythian responses as the Christian apologist in the Bible, and he offers a similar explanation. "If she were obliged to write down, and not to utter the responses, we should not, I suppose, believe the handwriting to be the god's, and find fault with it, because it is inferior in point of calligraphy to the imperial rescripts; for neither is the old woman's voice, nor her diction, nor her metre the god's; but it is the god alone who presents the visions to this woman, and kindles light in her soul regarding the future; for this is the inspiration" (*op. cit.* p. 119). While degrees of inspiration must be recognized, the distinction must be made objectively, and not subjectively. We may say that where the revelation is the clearest, there inspiration is the fullest, that nearness to the perfect fulfilment in Christ of God's progressive purpose determines the degree of inspiration; but we cannot formulate any elaborate theory of the operation of the Spirit from the standpoint of the psychic states of the writers. While subjectively we cannot separate the divine and the human spirit in the process, so objectively we cannot distinguish the divine substance and the human form in the product of inspiration. This theory neither helps us to explain the origin of the writings nor guides us in estimating the contents.

The third theory, which is a modification of the second, is that of *essential inspiration*, which distinguishes *matters of*

*doctrine and conduct* as closely related to God's purpose in the Scriptures from the remaining contents of the Scripture, and claims for the Bible only such inspiration as was necessary to secure accuracy in regard to these. The theology and the morality of the Bible are inspired, but not its history, science, philosophy. This distinction is already anticipated in Thomas Aquinas' theory of two kinds of inspiration, "the *direct*, which is to be found where doctrinal and moral truths are directly taught, and the *indirect*, which appears in historical passages, whence the doctrinal and moral can only be indirectly evolved by the use of allegorical interpretation." This view has the support of such names as Erasmus, Hugo Grotius, Richard Baxter, W. Paley and J. J. I. von Döllinger. It is to be observed that it lays emphasis on the necessity of correct views about doctrine and conduct; and this is an intellectualist standpoint which is not in accord either with the character or the influence of the Bible. Further, it does not explain how the same human mind can by divine inspiration obtain infallible knowledge in some matters, and yet be left prone to err in others. Again it does not take account of the fact that the teaching of the Old Testament as regards belief and morals is progressive; and that the imperfections of the earlier stages of the development are corrected in the later. That it is an advance on the other theories must be acknowledged, as from this standpoint errors in history or science are: no difficulties to the believer in the Bible as so inspired. It is necessary here to add that this emphasis on the infallibility of the knowledge of doctrine and morals communicated by the Scriptures had as its legitimate inference in the patristic and medieval period the claim that the Church alone was the infallible interpreter of the Scriptures.

The fourth theory—that of the Reformers (though not of their successors, the Protestant scholastics)—might be called that of *vital inspiration*, as its emphasis is on religious and moral life rather than on knowledge. While giving to the Scriptures supreme authority in all matters of faith and doctrine, the Reformers laid stress on the use of the Bible for edification; it was for them primarily a means of grace for awakening and nourishing the new life in the hearts of God's people. By the enlightening work of the Spirit of God the World of God is discovered in the Scriptures: it is the *testimonium Spiritus Sancti* in the soul of the Christian that makes the Bible the power and wisdom of God unto salvation. By thus laying stress on this redemptive purpose of the divine revelation, the Reformers were delivered from the bondage of the letter of Scripture, and could face questions of date and authorship of the writings frankly and boldly. Hence a pioneer of the higher criticism in Great Britain, W. Robertson Smith, was able to appeal to this Reformation doctrine. "If I am asked why I receive Scripture as the Word of God, and as the only perfect rule of faith and life, I answer with all the fathers of the Protestant Church, 'Because the Bible is the only record of the redeeming love of God, because in the Bible alone I find God drawing near to man in Christ Jesus, and declaring to us in Him His will for our salvation. And this record I know to be true by the witness of His Spirit in my heart, whereby I am assured that none other but God Himself is able to speak such words to my soul'" (in Denney's *Studies in Theology*, p. 205). The Reformers' application of this theory to the Bible was necessarily conditioned by the knowledge of their age; but it is a theory wide enough to leave room for our growing modern knowledge of the Bible.

Briefly stated, these are the conclusions which our modern knowledge allows. (1) Inspiration, or the presence and influence of the Divine Spirit in the soul of man, cannot be limited to the writers of the Scriptures; but, comparing the Bible with the other sacred literature of the world, its religious and moral superiority cannot be denied, and we may, therefore, claim for it as a whole a fuller inspiration. (2) As different writings in the Bible have more or less important functions in the progressive divine revelation, we may distinguish degrees of inspiration. (3) This inspiration is primarily personal, an inward enlightening and quickening, both religious and moral, of the writer, finding an expression conditioned by his individual characteristics in

his writing. (4) The purpose of inspiration is practical; the inspired men are used of God to give guidance in belief and duty by declaring the word and will of God as bearing on human life. (5) As revelation is progressive, inspiration does not exclude defects in doctrine and practice in the earlier stages and their correction in the later stages of development. (6) As the progressive revelation culminates in Christ, so He possesses fullest inspiration; and it varies in others according to the closeness of their contact, and intimacy of their communion with Him. (7) As the primary function of Christ is redemptive, so the inspiration of the Bible is directed to make men "wise unto salvation." (8) It is the presence and influence in the souls of men of the same Spirit of God as inspired the Scriptures which makes the Bible effective as a means of grace; and only those who yield themselves to the Spirit of God have the witness in themselves that the Bible conveys to them the truth and the grace of God.

In addition to the books mentioned, see: A. B. Bruce, *The Chief End of Revelation* (1881); C. A. Briggs, *The Bible, the Church, and the Reason* (1892); W. N. Clarke, *The Use of the Scriptures in Theology* (1906); H. E. Ryle, *The Canon of the Old Testament* (1892); B. F. Westcott, *A General Survey of the History of the Canon of the New Testament* (7th ed., 1896); W. Sanday, *Inspiration* (3rd ed., 1896); A. B. Davidson, article "Prophecy" in *Hastings's Bible Dictionary*, iv.; A. E. Garvie, "Revelation" in *Hastings's Bible Dictionary* (extra volume). (A. E. G. \*)

**INSTALLATION**, the action of installing or formally placing some one in occupation of an office or place. The med. Lat. *installare* meant literally "to place in a seat or stall" (*stallum*), and the word, as now, was particularly used of the ceremonial induction of an ecclesiastic, such as a canon or prebendary, to his stall in his cathedral choir. Similarly knights of an order of chivalry are ceremonially led to their stalls in the chapel of their order. The term is transferred to any formal establishment in office or position. From a French use of *installer* and *installation*, the word is frequently applied in a transferred sense to the fixing in position and making ready for use of a mechanical, particularly electrical, apparatus or plant.

**INSTALMENT** (for earlier *stallment* or *estallment*, from Fr. *estaler*, to fix, arrange; the change is probably due to the influence of the verb "install"), the payment of a sum of money at stated intervals and in fixed portions instead of in a lump sum; hence the sums of money as they fall due at the periods agreed upon. For the system of purchase by deferred payments or instalments see HIRE-PURCHASE AGREEMENT.

**INSTERBURG**, a town in the kingdom of Prussia, situated at the point where the Angerapp and Inster join to form the Pregel, 57 m. E. of Königsberg by the railway to Eydtkuhnen, and at the junction of lines to Memel and Allenstein. Pop. (1900) 27,787. It has four Evangelical churches, of which the town church is celebrated for its fine wood carvings, a Roman Catholic church, a synagogue, several schools and a park. Besides flax-spinning and iron-founding, Insterburg has manufactures of machinery, shoes, cement, leather and beer, along with a considerable trade in cereals, vegetables, flax, linseed and wood, while horse-breeding is extensively carried on in the neighbourhood. Close to the town lies the demesne of Georgenburg, with an old castle which formerly belonged to the Teutonic order. Insterburg, the "burg" on the Inster, was founded in the 14th century by the knights of the Teutonic order. Having passed to the margraves of Brandenburg, the village which had sprung up round the castle received civic privileges in 1583. During the next century it made rapid advances in prosperity, partly owing to the settlement in it of several Scottish trading families. In 1679 it was besieged by the Swedes; in 1690 it suffered severely from a fire; and in 1710-1711 from pestilence.

See Töws, *Urkunden zur Geschichte des Hauptorts Insterburg* (Inst., 1895-1897, 3 parts); and *Kurze Chronik der Stadt Insterburg* (Königsberg, 1883).

**INSTINCT**. It is in the first place desirable to distinguish between the word "instinct" (Lat. *instinctus*, from *instinguere*, to incite, impel) as employed in general literature and the term

"instinct" as used in scientific discourse. The significance of the former is somewhat elastic, and is in large measure determined by the context. Thus in social relationships we speak of "instinctive" liking or distrust; we are told that the Greeks had "instinctive" appreciation of art; we hear of an instinct of reverence or "instinctive" beliefs. We understand what is meant and neither desire nor demand a strict definition. But in any scientific discussion the term instinct must be used within narrower limits, and hence it is necessary that the term should be defined. There are difficulties, however, in framing a satisfactory definition. That given by G. J. Romanes in the 9th edition of the *Encyclopaedia Britannica* runs as follows: "Instinct is a generic term comprising all those faculties of mind which lead to the conscious performance of actions that are adaptive in character but pursued without necessary knowledge of the relation between the means employed and the ends attained." This has been criticized both from the biological and from the psychological standpoint. From the biological point of view the reference of certain modes of behaviour, termed instinctive, to faculties of mind for which "instinct" is the generic term is scarcely satisfactory; from the psychological point of view the phrase "without necessary knowledge of the relation between the means employed and the end attained" is ambiguous. (See INTELLIGENCE OF ANIMALS.) In recent scientific literature the term is more frequently used in its adjectival than in its substantive form; and the term "instinctive" is generally applied to certain hereditary modes of behaviour. Investigation thus becomes more objective, and this is a distinct advantage from the biological point of view. It is indeed sometimes urged that instinctive modes of behaviour should be so defined as to entirely exclude any reference to their psychological concomitants in consciousness, which are, it is said, entirely inferential. But as a matter of fact no small part of the interest and value of investigations in this field of inquiry lies in the relationships which may thereby be established between biological and psychological interpretations. Fully realizing, therefore, the difficulty of finding and applying a criterion of the presence or absence of consciousness, it is none the less desirable, in the interests of psychology, to state that truly instinctive acts (as defined) are accompanied by consciousness. This marks them off from such reflex acts as are unconsciously performed, and from the tropisms of plants and other lowly organisms. There remains, however, the difficulty of finding any satisfactory criterion of the presence of consciousness. We seem forced to accept a practical criterion for purposes of interpretation rather than one which can be theoretically defended against all adverse criticism. We have reason to believe that some organisms profit by experience and show that they do so by the modification of their behaviour in accordance with circumstances. Such modification is said to be individually acquired. To profit by individual experience is thus the only criterion we possess of the existence of the conscious experience itself. But if hereditary behaviour is unaccompanied by consciousness, it can in no wise contribute to experience, and can afford no data by which the organism can profit. Hence, for purposes of psychological interpretation it seems necessary to assume that instinctive behaviour, including the stimulation by which it is initiated and conditioned, affords that naive awareness which forms an integral part of what may be termed the primordial tissue of experience.

We are now in a position to give an expanded definition of instinctive behaviour as comprising those complex groups of co-ordinated acts which, though they contribute to experience, are, on their first occurrence, not determined by individual experience; which are adaptive and tend to the well-being of the individual and the preservation of the race; which are due to the co-operation of external and internal stimuli; which are similarly performed by all members of the same more or less restricted group of animals; but which are subject to variation, and to subsequent modification under the guidance of individual experience.

Conscious concomitant.



If a brief definition of instinct, from the purely biological point of view be required, that given in the *Dictionary of Philosophy and Psychology* may be accepted: "An inherited reaction of the sensori-motor type, relatively complex and markedly adaptive in character, and common to a group of individuals." Instinctive behaviour thus depends solely on how the nervous system has been built through heredity; while intelligent behaviour depends also on those characters of the nervous system which have been acquired under the modifying influence of individual relation to the environment.

Such definitions, however, are not universally accepted. Wasmann, for example, divides instinctive actions under two groups: (1) those which immediately spring from the inherited dispositions; (2) those which indeed proceed from the same inherited dispositions but through the medium of sense experience. The first group, which he regards as instinctive in the strict acceptance of the term, seem exactly to correspond to those which fall under the definition given above. The second group, which he regards as instinctive in the wider acceptance of the term, nearly, if not quite, correspond to those above spoken of as intelligent—though he regards this term as falsely applied (see INTELLIGENCE OF ANIMALS). By using the term instinctive in both its strict and its wider significance, Wasmann includes under it the whole range of animal behaviour.

It will be seen that from the biological standpoint there fall under the stricter definition those hereditary modes of behaviour which are analogous to hereditary forms of structure; and that a sharp line of distinction is drawn between the behaviour which is thus rendered definite through heredity, and the behaviour the distinguishing characteristics of which are acquired in the course of individual life. What in popular usage are spoken of as the instincts of animals, for example, the hunting of prey by foxes and wolves, or the procedure of ants in their nests, are generally joint products of hereditary and acquired factors. Wasmann's comprehensive definition so far accords with popular usage. But it tends to minimize the importance of the distinction of that which is prior to individual experience and that which results therefrom. It is the business of scientific interpretation to disentangle the factors which contribute to the joint-products. It is indeed by no means easy to distinguish between what is dependent on individual experience, and what is not. Only the careful observation of organisms throughout the earlier phases of their life-history can the closely related factors be distinguished with any approach to scientific accuracy. By the patient study of the behaviour of precocious young birds, such as chicks, pheasants, ducklings and moorhens, it can be readily ascertained that such modes of activity as running, swimming, diving, preening the down, scratching the ground, pecking at small objects, with the characteristic attitudes expressive of fear and anger, are so far instinctive as to be definite on their first occurrence—they do not require to be learnt. No doubt they are subsequently guided to higher excellence and effectiveness with the experience gained in their oft-repeated performance. Indeed it may be said that only on the occasion of their initial performance are they purely instinctive; all subsequent performance being in some degree modified by the experience afforded by previous behaviour of like nature and the results it affords. It should be remembered that such comparatively simple activities, though there is little about them to arrest popular attention, are just the raw material out of which the normal active life of such organisms is elaborated, and that for scientific treatment they are therefore not less important than those more conspicuous performances which seem at first sight to call for special treatment, or even to demand a supplementary explanation. The instincts of nest-building, incubation and the rearing of young, though they occur later in life than those concerned in locomotion and the obtaining of food, are none the less founded on a hereditary basis, and in some respects are less rather than more liable to modification by the experience gained by the carrying out of hereditarily definite modes of procedure. Here the instinctive factor probably predominates over that which is experiential.

But in the "homing" of pigeons there is little question that the experiential factor predominates. The habit results mainly from the modification of the higher nerve-centres through individual and intelligent use. In the migration of birds we are still uncertain as to the exact nature and proportional value of the instinctive and intelligent factors. The impulse to migrate, that is to say, the calling forth of specific activities by climatal or other presentations, appears to be instinctive; whether the direction of migration is in like manner instinctive is a matter of uncertainty; and, if it be instinctive, the nature of the stimuli and the manner in which they are hereditarily linked with responsive acts is unexplained. To say that it is due to hereditary experience is generally regarded as inadmissible. For modern interpretation hereditary modes of behaviour afford experience; in no other sense can it be said that experience is inherited.

A good example of the methods of recent investigation is to be found in Dr G. W. and Mrs Peckham's minute observations on the habits and instincts of the solitary wasps. They enumerate the following primary types of instinctive behaviour: the manner of attacking and capturing a particular kind of prey which alone affords the requisite presentation to sense; the manner of conveying the prey to the nest; the general style and locality of the nest; the method and order of procedure in stocking the nest with food for the unseen young. It is noteworthy, however, that although the manner in which the prey is stung (for example) is on the whole similar in the case of the members of any given species—that is to say, all the wasps of the species behave in very much the same manner—yet there are minor variations in detail. This outcome of prolonged and careful observation is of importance. It affords a point of departure for the interpretation of the genesis of existing instincts. Furthermore, the observations on American wasps render it probable that the earlier accounts of the instinctive behaviour of such wasps are exaggerated. Romanes thought that the manner of stinging and paralysing their prey might be justly deemed the most remarkable instinct in the world. Spiders, caterpillars and grasshoppers are, he said, stung in their chief nerve-centres, in consequence of which the victims are not killed outright, but rendered motionless and continue to live in this paralysed condition for several weeks, being thus available as food for the larvae when these are hatched. Of course, he adds, the extraordinary fact which stands to be explained is that of the precise anatomical, not to say the physiological, knowledge which appears to be displayed by the insect in stinging only the nerve-centres of its prey. But the Peckhams' careful observations and experiments show that, with the American wasps, the victims stored in the nests are quite as often dead as alive; that those which are only paralysed live for a varying number of days, some more, some less; that wasp larvae thrive just as well on dead victims, sometimes dried up, sometimes undergoing decomposition, as on living and paralysed prey; that the nerve-centres are not stung with the supposed uniformity; and that in some cases paralysis, in others death, follows when the victims are stung in parts far removed from any nerve-centre. It would seem then that by the stinging of insects or spiders their powers of resistance are overcome and their escape prevented; that some are killed outright and some paralysed is merely an incidental result.

Granted that instinctive modes of behaviour are hereditary and definite within the limits of congenital variation, the question of their manner of genesis is narrowed to a clear issue.

Do they originate through the natural selection of those variations which are the more adaptive; or do they originate through the inheritance of those acquired modifications which are impressed on the nervous system in the course of individual and intelligent use? Romanes, taking up the inquiry where Darwin left it, came to the conclusion that some instinctive modes of behaviour which he termed "primary" are due to the operation of natural selection alone; that others, which he termed "secondary," and of which he could give few examples, were due to the inheritance of acquired modifications from which, in the phrase of G. H. Lewes, the intelligence had

*Definitio-*

*Examples from Insect life.*

*Examples from bird life.*

*Mode of origin.*

lapsed; while others, which he termed "blended," were partly due to natural selection and partly resulted from the inheritance of acquired habit. There has been a prolonged controversy between the school of interpretation, commonly spoken of as Lamarckian, which advocates a belief in the inheritance of acquired characters, and the school, with Weismann as their leader, which questions the evidence for, or the probability of, such inheritance. The trend of modern opinion appears to be in the direction of the Weismannian interpretation. And it must be regarded as questionable, if not improbable, that instinctive modes of behaviour are in any degree directly due to the inheritance of habits intelligently acquired. That intelligent habits may secure the survival of those organisms whose germ-plasm bears the seeds of favourable congenital variations is not improbable. But in that case intelligent procedure only contributes to the survival and not to the origin of hereditary variations.

To test the hypothesis that natural selection is an essential condition to the genesis of instinctive behaviour it should be the aim of investigation to find crucial cases. This is, however, no easy task. We ought to be able to adduce cases in which, where the incidence of natural selection is excluded, acquired habits do not become instinctive.

But it is difficult to do so. It seems, however, that in young chicks drinking from still water is a habit acquired through imitation of the acts of the hen-mother. The presentation of such water to sight does not evoke the appropriate instinctive response, while the presentation of water taken into the bill does at once evoke a characteristic response. Now it would seem that in the former case, since the hen "teaches" all her chicks to peck at the water, she shields them from the incidence of natural selection. But though the hen can lead her young to peck at the water, she cannot "teach" them how to perform the complex movements of mouth, throat and head required for actual drinking. In this matter they are not shielded from the incidence of natural selection. Thus it would seem that, where natural selection is excluded, the habit has not become congenitally linked with a visual stimulus; but where natural selection is in operation, the response has been thus linked with the stimulus of water in the bill.

If this interpretation be correct we have here an example of the manner in which imitation plays an important part in the formation of habits which though oft-repeated are not transmitted as hereditary instincts. But the imitative act is itself instinctive. The characteristic feature of the imitative act, at the instinctive level, is that the presentation to sight or hearing calls forth a mode of behaviour of like nature to, or producing like results to, that which affords the stimulus. The nature of instinctive imitation needs working out in further detail. But it is probable that what we speak of as the imitative tendency is, in any given species, the expression of a considerable number of particular responses each of which is congenitally linked with a particular presentation or stimulus. The group of instincts which we class as imitative (and they afford only the foundations on which intelligent imitation is based) are of biological value chiefly, if not solely, in those species which form larger or smaller communities.

The study of instinct in the genetic treatment of evolutionary science a study in heredity. The favouring bionomic conditions are those of a relatively constant environment under which relatively stereotyped responses are advantageous. If the environment be complex, there is a corresponding complexity in instinctive behaviour. But adjustment to a complex environment may be reached in two ways; by instinctive adaptation through initially stereotyped behaviour; or by plastic accommodation by acquired modifications. The tendency of the evolution of intelligence is towards the disintegration of the stereotyped modes of response and the dissolution of instinct. Natural selection which, under a uniform and constant environment, leads to the survival of relatively fixed and definite modes of response, under an environment presenting a wider range of varying possibilities leads to the survival of plastic accommodation through intelligence. This

plasticity is, however, itself hereditary. All intelligent procedure implies the inherited capacity of profiting by experience. Instinctive in the popular sense, it does not fall within the narrower definition of the term; it is more conveniently described as innate. It is important to grasp clearly the distinction thus drawn. A duckling only a few hours old if placed in water swims with orderly strokes. The stimulus of water on the breast may be regarded as a sensory presentation which is followed by a definite and adaptive application of behaviour. But this specific application is dependent upon a prolonged racial preparation of the organism to respond in this particular way. Such response is instinctive. It is wholly due, as such, to racial preparation. Compare the case of a boy who learns to ride a bicycle. This is not wholly due, as such, to racial preparation, but is also partly due to individual preparation. The boy no doubt inherits a capacity for riding a bicycle, otherwise he could never do so. But he has to learn to ride none the less. Individual experience is a condition which without the innate capacity cannot take effect. Instinct involves inherited adaptation; intelligence, an inherited power, embodied in the higher nerve-centres, of accommodation to varying circumstances.

See C. Lloyd Morgan, *Habit and Instinct* (1896), and *Animal Behaviour* (1900); G. J. Romans, *Mental Evolution in Animals* (1883), and *Natural History of Instinct* (1886); Lord Avebury, *On the Instincts of Animals* (1889); Marshall, *Instinct and Reason* (1898); Mills, *Nature of Animal Intelligence* (1898); St George Mivart, *Nature and Thought* (1882), and *Origin of Human Reason* (1899); E. Wasmann, *Zur Entwicklung der Instinle* (1897), *Instinct und Intelligenz im Tierreich* (1899, Eng. trans. 1903); G. and C. Peckham, *Instincts and Habits of Solitary Wasps* (1898); see also the bibliography (section "Instinct and Impulse" in Baldwin's *Diet. of Philosophy and Psychology*. (C. L. M.)

**INSTITUTE** (from Lat. *instituere*, to establish or set up), something established, an institution, particularly any society established for an artistic, educational, scientific or social purpose. The word seems to have been first applied in English to such institutions for the advancement of science or art as were modelled on the great French society, the *Institut National* (see ACADEMIES). It is thus the name of such societies as the Royal Institute of British Architects, the Imperial Institute and the like. It is extended to similar organizations, particularly to educational, on a smaller or local scale, such as Mechanics' or Workmen's Institutes, and is sometimes applied to charitable foundations. In the United States the word is, in a particular sense, applied to periodic classes giving instruction in the principles of education to the teachers of elementary and district schools. The term "institute" is often used to translate the Lat. *institutio*, in the sense of a treatise on the elements of any subject, and particularly of law or jurisprudence; thus the compilation of the principles of Roman law, made by order of the emperor Justinian, is known as *Justinian's Institutes*, and hence Coke's treatise on English law, of which the first part is better known as *Coke upon Littleton*, is called *The Institute*. The same title is borne by Calvin's work on the elements of the Christian doctrine. In Scots law "institute" is the person named in a settlement or testament to whom an estate is first limited; those who follow, failing him, are termed "substitutes."

**INSTITUTIONAL CHURCH**, the name generally applied both in the British Isles and in America to a type of church which supplements its ordinary work by identifying itself in various ways with the secular interests of those whom it seeks to influence. The idea of such extension of function grew out of the recognition of the fact that the normal activities of church work entirely failed to retain the interest of a large class of the population to whom the ritual formality of ordinary services was unacceptable. Various attempts were made to overcome this deficiency, e.g. by modifying the form of service or of some services, by the addition to the ordinary services of more or less informal meetings (e.g. the Pleasant Sunday Afternoon services), by specially excusing persons from wearing the normal church-going attire in holiday resorts, and by holding services out of doors. The principle underlying all these changes is systematized in the Institutional Church which, in addition to its main building for

Crucial observations.

Imitation.

Relation to heredity.

specifically religious services, provides other rooms or buildings which during the week are open for the use of members and friends. Lectures, concerts, debates and social gatherings are organized; there are reading rooms, gymnasiums and other recreations rooms; various clubs (cycling, cricket, football) are formed. The organization of the whole is subdivided into special departments managed by committees. By these various means many persons are attracted into the atmosphere of the church's work who could not be induced to attend the formal services.

This expansion of normal church work may be traced back in England to at least as early as 1840, but the full development of the Institutional Church belongs only to the latter years of the 19th century. The chief example in England is Whitefield's Central Mission in Tottenham Court Road, London, a church which, in addition to an elaborate organization on the lines above described, has an official journal. In the United States the movement may be said to date from about 1880. The name "Institutional" was first applied to Berkeley Temple, Boston, by Dr William Jewett Tucker, then president of Dartmouth College. The obvious criticism that this epithet emphasizes the administrative and secular side to the exclusion of the spiritual led to the tentative adoption of other titles, e.g. the "Open Church," the "Free Church," the former of which is the more commonly used. In 1804 was formed the "Open and Institutional Church League" at New York, which held a number of conventions and served as a headquarters for the numerous separate churches. In connexion with this league was formed the "National Federation of Churches and Christian Workers," which held a convention in 1905.

See C. Silvester Horne, *The Institutional Church* (London, 1906); G. W. Mead, *Modern Methods in Church Work* (New York, 1897); R. A. Woods, *English Social Movements* (New York, 1891).

**INSTRUMENT** (Lat. *instrumentum*, from *instruere*, to build up, furnish, arrange, prepare), that which can be used as a means to an end, hence a mechanical contrivance, implement or tool; the word is more particularly applied to the implements of applied science, in mathematics, surgery, surveying, &c., while those of the handicrafts are generally known as "tools." A specific use of the term is for the various contrivances used to produce musical sounds, "musical instruments."

In law an "instrument" is any formal or written document by which expression is given to a legal act or agreement. This is a classical use of the Lat. *instrumentum*, a document, record. The term may be used in a wide sense, as a mere writing, meant only to form a record, or in a particular sense with reference to certain statutes. For example, the Stamp Act 1801 defines an instrument as an expression including every written document; for the purposes of the Forgery Act 1861 a post-office telegram accepting a wager has been defined as an instrument. In expressions such as "deed, will, or other written instrument" the word means any written document under which a right or liability, legal or equitable, exists.

**INSTRUMENTATION.** "Instrumentation" is the best term that can be found for that aspect of musical art which is concerned with timbre. The narrower term "orchestration" is applied to the instrumentation of orchestral music. Since the most obvious differences of timbre are in those of various instruments, the art which blends and contrasts timbre is most easily discussed as the treatment of instruments; but we must use this term with philosophic breadth and allow it to include voices. Instrumentation is in all standard text-books treated as a technical subject, from the point of view of practical students desirous of writing for the modern orchestra. And as there is no branch of art in which mechanical improvements, and the consequent change in the nature of technical difficulties, bear so directly upon the possibilities and methods of external effect, it follows that an exclusive preponderance of this view is not without serious disadvantage from the standpoint of general musical culture. There is probably no other branch of art in which orthodox tradition is so entirely divorced from the historical sense, and the history, when studied at all, so little illuminated by the permanent artistic significance of its subjects. When improvements, in the

structure of an instrument remove from the modern composer's memory an entire category of limitations which in classical music determined the very character of the instrument, the temptation is easy to regard the improvement as a kind of access of wisdom, in comparison with which not only the older form of the instrument, but the part that it plays in classical music, is crude and archaic. But we should do better justice to improvements in an instrument if we really understood how far they give it, not merely new resources, but a new nature. And, moreover, those composers who have done most to realize this new nature (as Wagner has done for the brass instruments) have also retained, to an extent unsuspected by their imitators, the definite character which the instrument had in its earlier form.

As it is with mechanical improvements, so is it to a still greater degree with changes in the function of timbre in art. Throughout the 19th century so fatal was the hold obtained on the popular mind by the technical expert's view of instrumentation, that it was impossible to hear the works of Handel and Bach without "additional accompaniments" conceived in terms of art as irrelevant to those of 18th-century polyphony as the terms of Turnerian landscape are irrelevant to the decoration of the outside walls of a cathedral. There is some reason to hope that the day of these misconceptions is passed; although there is also some reason to fear that on other grounds the present era may be known to posterity as an era of instrumentation comparable, in its gorgeous chaos of experiment and its lack of consistent ideas of harmony and form, only to the monodic period at the beginning of the 17th century, in which no one had ears for anything but experiments in harmonic colour. We do not propose to concern ourselves here with those technical subjects which are the chief concern of standard treatises on instrumentation. Our task is simply to furnish the general reader with an account of the types of instrumentation prevalent at various musical periods, and their relation to other branches of the art.

*The Vocal Style of the 16th Century.*—In the 16th century instrumentation was, in its normal modern sense, non-existent; but in a special sense it was at an unsurpassable stage of perfection, namely, in the treatment of pure vocal harmony. In every mature period of art it will be found that, however much the technical rules may be collected in one special category, every artistic category has a perfect interaction with all the others; and this is nowhere more perfectly shown than when the art is in its simplest possible form of maturity. Practically every law of harmony in 16th-century music may be equally well regarded as a law of vocal effect. Discords must not be taken unprepared, because a singer can only find his note by a mental judgment, and in attacking a discord he has to find a note of which the harmonic meaning is at variance with that of other notes sung at the same time. Melody must not make more than one wide skip in the same direction, because by so doing it would cause an awkward change of vocal register. Two parts must not move in consecutive octaves or fifths, because by so doing they unaccountably reinforce each other by an amount by which they impoverish the rest of the harmony. Thus we justify, on grounds of instrumentation, laws usually known as laws of harmony and counterpoint. Apart from such considerations, 16th-century vocal harmony shows in the hands of its greatest masters an inexhaustible variety of refinements of vocal colour. A volume might be written on Orlando di Lasso's art of so crossing the voices as to render possible successions of chords which, on a keyed instrument where such crossing cannot be expressed, would be a horrible series of consecutive fifths; the beauty of the device consisting in the extreme simplicity of the chords, combined with the novelty due to the fact that these chords cannot be produced by any ordinary means without incorrectness.

*Decorative Instrumentation.*—In the 17th century the use of instruments became a necessity; but there were at first no organized ideas for their treatment except those which were grounded on their use as supporting and imitating the voice.

The early 17th-century attempts at their independent use and characterization are historically interesting, but artistically almost barbarous. Sometimes they achieve rare beauty by accident. Heinrich Schütz's *Lamentatio Davidi* is written for a bass voice accompanied by four trombones and organ. The trombone parts are on exactly the same material as the voice, which in fact forms with them a five-part fugue-texture. The effect is magnificent, and admirably suited to the dignity of the trombone. Moreover, the opening theme is formed of slow arpeggios; and the more modern harmonic elements, though technically chromatic, consist, from the modern point of view, rather in swift changes between nearly related keys than in chromatic blurring of the main key. All this, especially in a writer like Schütz, who is saturated with every progressive tendency of the time, seems to point to a deep sense of the appropriate style of trombone writing. Yet, so insensible is Schütz to the euphony of his own work, that he proposes, as an alternative for the first and second trombones, two violins an octave higher, the other parts remaining unaltered! Imagination boggles at the violence of this effect.

The chief work done in instrumentation in the 17th century is undoubtedly that of the Italian writers for the violin, who developed the technique of that instrument until it proved not only more resourceful but more artistically organized than that of the solo voice, which by the time of Handel had become little better than an acrobatic monstrosity. In the art of Bach and Handel, instrumentation, as distinguished from choral writing, has attained a definite artistic coherence. Choral writing itself has become different from what it was in the 16th century. The free use of discords and of wider intervals, together with the influence of the florid elements of solo-singing, enlarged the bounds of choral expression almost beyond recognition, while they crowded into very narrow quarters the subtleties of 16th-century music. These, however, by no means disappeared; and such devices as the crossing of parts in the second Kyrie of Bach's *B Minor Mass* (bars 7, 8, 14, 15, 22, 23, 50) abundantly show that in the hands of the great masters artistic truths are not things which a change of date can make false.

But the treatment of instruments in Bach and Handel has a radical difference from that of the art which was soon to succeed it. It has precisely the same limitation as the treatment of form and emotion; it cannot change as the work proceeds. Its contrasts are like those of an architectural scheme, not those of a landscape or a drama. It admits of the loveliest combinations of timbre, and it can alternate them in considerable variety. Modern composers have often produced their most characteristic orchestral effects with fewer contrasting elements than Bach uses in his *Træuer-Ode*, in the pastoral symphony in his *Christmas Overture*, in the first chorus of the cantata *Liebster Gott, wenn werd' ich sterben*, and in many other cases; but the modern instrumental effects are as far outside Bach's scope as a long passage of preparation on the dominant leading to the return of a first subject is beyond the scope of a gigue in a suite. Bach's conception of the function of an instrument is that it holds a regular part in a polyphonic scheme; and his blending of tones is like the blending of colours in a purely decorative design.

Those instruments of which the tones and compass are most suitable for polyphonic melody are for the most part high in pitch; a circumstance which, in conjunction with the practice (initiated by the monodists and ratified by science and common sense) of reckoning chords upwards from the bass, leads to the conclusion that the instruments which hold the main threads in the design shall be supported where necessary by a simple harmonic filling-out on some keyed instrument capable of forming an unobtrusive background. The chords necessary in this part, which with its supporting bass is called the *continuo*, were indicated by figures; and the evanescent and delicate tones of the harpsichord lent themselves admirably to this purpose where solo voices and instruments were concerned. For the support of the chorus the more powerful organ was necessary. It is in the attempt to supply the place of this *continuo* (or figured bass) by definite orchestral parts that modern per-

formances, until the most recent times, have shown so radical an incapacity to grasp the nature of 18th-century instrumentation. The whole point of this filling-out is that, the polyphonic design of the main instruments being complete in itself, there is no room for any such additional inner parts as can attract attention. In the interest of euphony some harmonious sound is needed to bridge the great gap which almost always exists between the bass and the upper instruments, but this filling out must be of the softest and most atmospheric kind. Bach himself is known to have executed it in a very polyphonic style, and this for the excellent reason that plain chords would have contrasted so strongly with the real instrumental parts that they could not fail to attract attention even in the softest tones of the harpsichord or the organ, while light polyphony in these tones would elude the ear and at the same time perfectly bridge over the gap in the harmony. There seems no good reason why in modern performances the pianoforte should not be used for the purpose; if only accompanists can be trained to acquire the necessary delicacy of touch, and can be made to understand that, if they cannot extemporize the necessary polyphony, and so have to play something definitely written for them, it is not a mass of interesting detail which they are to bring to the public ear. A lamentable instance of the prevalent confusion of thought on this point is shown by the vocal scores of the Bach cantatas corresponding to the edition of the *Bach Gesellschaft* (which must not be held responsible for them). In these Bach's polyphonic designs are often obliterated beneath a mass of editorial counterpoint (even where Bach has carefully written the words "*alato solo*," i.e. "no filling out"). The same comments apply to the attempts sometimes made to fill out the bare places in 18th-century clavier music. There is no doubt that such filling out was often done on a second harpsichord with stops of a very light tone; but, if it cannot be done on the modern pianoforte in a touch so light as to avoid confusion between it and the notes actually written as essential to the design, it certainly ought not to be done at all. The greater richness of tone of the modern pianoforte is a better compensation for any bareness that may be imputed to pure two-part or three-part writing than a filling out which deprives the listener of the power to follow the essential lines of the music. The same holds good, though in a lesser degree, of the resources of the harpsichord in respect of octave-strings. To sacrifice phrasing, and distinctness in real part-writing, to a crude imitation of the richness produced mechanically on the harpsichord by drawing 4-ft. and 8-ft. registers, is artistically suicidal. The genius of the modern pianoforte is to produce richness by depth and variety of tone; and players who cannot find scope for such genius in the real part-writing of the 18th century will not get any nearer to the 18th-century spirit by sacrificing the essentials of its art to an attempt to imitate its mechanical resources by a modern *tour de force*.

*Symphonic Instrumentation.*—The difference between decorative and symphonic instrumentation is admirably shown by Gluck. In the famous dedicatory letter of his *Alceste* he mentions among other conceptions on which his reform of opera was to be based, that the co-operation of the instruments ought to be regulated in proportion to the interest and the passion, a doctrine of which the true significance lies in its connexion with other conditions of opera which are incompatible with the polyphonic treatment of instruments as threads in a decorative scheme. The date of this famous letter was 1767; but after *Alceste* Gluck was still able to use material from earlier work; and the overture to *Armide* is adapted from that of *Telemacco*, written in the year of Bach's death (1750).

To write an account of symphonic instrumentation in any detail would be like attempting a history of emotional expression; and all that we can do here is to point out that the problem which was, so to speak, shelved by the polyphonic device of the *continuo*, was for a long time solved only by methods which, in any hands but those of the greatest masters, were very in-artistic conventions. In the new art the concentration of attention upon *form*, as a more important source of dramatic interest and climax than *texture*, resulted in a neglect of polyphony which

seriously damaged even Gluck's work, and which always had the grave inconvenience that while the new methods of blending and contrasting instruments stimulated an increase in the variety, if not in the size of orchestras, there was at the same time extreme difficulty in finding occupation for the members of the lower middle class of the orchestra in ordinary passages. On the other hand, it is significant how everything in the development of new instruments seems to suggest, and be suggested by, the new methods of expression. The invention of the damper-pedal in the pianoforte epitomizes the difference between polyphony and symphonic art, for it is the earliest device by which sounds are produced and prolonged in a way contrary to the spirit of "real" part-writing. It is possible to conceive of any number of notes struck and sustained by the fingers as consisting of so many quasi-vocal parts; but when a series of single sounds is played and each sound continues to vibrate by means of a pedal which prevents the dampers from falling on the strings, then we are conscious that the sounds have been produced as from one part, and that they nevertheless combine to form a chord; and this is as remote from the spirit of polyphonic part-writing as modern English is from classical Greek.

The pianoforte trios of Haydn are perhaps the only works of first-rate artistic importance in which there is no doubt that the earlier stages of the new art do not admit of sufficient polyphony to give the instruments fair play. Haydn finds the pianoforte so completely capable of expressing his meaning that he is at a loss to find independent material for any accompanying instruments; and the violoncello in his trios has, except perhaps in four passages in the whole collection of thirty-three works, not a note to play that is not already in the bass of the pianoforte; while the melodies of the violin are, more often than not, doubled in the treble. Yet there is a certain difference between this and the work of a poor artist whose designs are threadbare. It would be impossible to add a note to Haydn's trio; the only question is how to account for the superfluity of much of the string parts and how to make the trios effective in performance. It is sometimes suggested that the 'cello part is best omitted and these works played as violin sonatas. But experiment shows that in this condition much of the violin part sounds incomplete; and the truth appears to be that Haydn is thinking, like any modern composer, of the opposition of two solid bodies of tone—the pianoforte and the stringed instruments. And it will be found that the method of performance which most nearly justifies the instrumental effect of these otherwise beautiful works is that in which the pianoforte player regards himself as frequently doubling the stringed instruments, and not vice versa. He should therefore in all such passages play extremely lightly, so as to give the violin and 'cello the function of drawing the main outline. In the time of Bath such writing was beautifully suited to enliven the dry glitter of the harpsichord, and Bach's duets for clavier and violin seem to have been sometimes played as trios with a violoncello playing from the clavier bass. But this was ineffective with the pianoforte, and is only explicable in Haydn as a survival. His trios were, indeed, published under the title of "pianoforte sonatas with accompaniment of violin and violoncello"; but this in no way militates against the above remarks as to their proper method of performance nowadays, when we take into consideration the greater strength of tone of the modern pianoforte, especially in the bass, and the fact that in no case could a violinist consent to play as an accompaniment such melodies as that at the beginning of the G major trio known as No. 1.

For Mozart there never was any such *embarras de richesse* in any combination of instruments. His music is highly polyphonic, and modern in its instrumental treatment throughout. It was lucky for the development of instrumentation (as in all branches of music during the change from polyphonic to formal design) that whenever the texture is not polyphonic the natural place for melody is on the surface: in other words, when the accompaniment is simple the tune is generally on the top. Haydn, when he was not tempted by the resources of an instrument so complete in itself as the pianoforte, soon learnt to write

artistically perfect string quartets in which the first violin, though overwhelmingly the most important part, is nevertheless in perfect balance with the other members of the scheme, inasmuch as they contribute exactly what their pitch and the little polyphonic elaboration admissible by the style will enable them to give. In the treatment of the orchestra volumes might be written about Haydn's and Mozart's sense of fitness, as shown in Haydn's experiments and Mozart's settled methods. Where they consent to any practical custom from practical necessity they also consent because it is artistically right for them, and if it had not been artistically right they would have soon swept it away. For example, it has often been said that the extent to which their orchestral viola parts double the basses is due, partly to bad traditions of Italian opera, and partly to the fact that viola players were, more often than not, simply persons who had failed to play the violin. This was in many cases true, and it is equally true that Mozart and Haydn often had no scruple in following the customs of very bad composers. But, when we look at the many passages in which the violas double the basses, we shall do well to consider whether there is room in the harmonic scheme for the violas to do anything else, and whether the effect would not be thin without them. As music becomes more polyphonic the inner parts of the orchestra become more and more emancipated. Already Mozart divides his violas into two parts quite as often as he makes them play with the basses. In Beethoven's orchestration there is almost always room for an independent viola part. There is not room for one together with an independent violoncello part; the wonderful use of muted solo violoncellos in the slow movement of the *Pastoral Symphony* being a special effect, like the earlier instance in Haydn's 12th *Salomon Symphony*. Otherwise, when Beethoven has anything special for the violoncellos to say, he invariably softens and deepens their singularly incisive cantabile tones by doubling them with the violas. In the orchestras of his day this was perhaps the only safe proceeding for players unaccustomed to such responsibilities, and that may have been one of Beethoven's reasons for it. But it is equally certain that the pure violoncello tone in large masses belongs to a distinctly different region of orchestral effect. Haydn's numerous examples of independent violoncello melodies are almost all either marked *solo* or written for such small orchestras that they would be played as solos.

Similar principles apply in infinite detail to the treatment of wind instruments, and we must never lose sight of them in speculating as to the reasons why the genius of Beethoven was able to carry instrumentation into worlds of which Haydn and Mozart never dreamt, or why, having gone so far, it left anything unexplored. A subject so vast and so incapable of classification cannot be discussed here, but its aesthetic principles may be illustrated by the extreme case of the trumpets and horns, which in classical times had no scale except that of the natural harmonic series. This could be fixed, within certain limits, at whatever pitch suited the composition; but on the horn it could be only very partially filled out by notes of a muffled quality produced by inserting the hand into the bell of the instrument, a device impossible on the trumpet. These instruments thus produced, in Haydn's and Beethoven's times, a very remarkable but closely limited series of effects, which, as Sir George Macfarren pointed out in the article "Music" in the 9th edition of the *Encyclopædia Britannica*, gave them a peculiar character and function in strongly asserting the main notes of the key. An instance of this characteristic function, specially remarkable because the composer has taken exceptional measures for it, is Beethoven's overture to *Fidelio*. It is in E major, while Beethoven chooses to use trumpets in C. The only note which these can play in E major is the tonic, to which they are accordingly confined until the replacement of the second subject. This is unexpectedly placed in C major, the remotest key reached in the overture, and one that had already appeared in an impressive passage in the introduction which foreshadows the reference in the first act to the hero in his dungeon ("Der kaum mehr lebt und wie ein Schatten schwebt"). In this key the trumpets blaze out with an effect which entirely depends upon their

restricted part hitherto. On a sufficient acquaintance with the work this would probably have revealed the essential nature of the instrument to a hearer unacquainted with technicalities, and revealed it rather as a characteristic than as a limitation. A still more remarkable instance will be found in the third statement of the theme of the finale of the 9th symphony. When the trumpets take it up they make a remarkable change at its 11th bar, for no other reason than that one of the notes, though perfectly within their scale, and, indeed, already produced by them in the very same bar, is so harmonized as to suggest the freedom of an instrument with a complete scale. This passage shows that if Beethoven had had the modern trumpet at his disposal, while he would no doubt freely have used its resources, he would nevertheless have maintained its character as an instrument founded on the natural scale, and would have agreed with Brahms that the nobility and purity of its tone depends upon its faithful adherence, at least within symphonic limits, to types of melody suggestive of that scale.

This brings us to the latest radical change effected in instrumentation, the change from symphonic to dramatic principles. It will be convenient to take one supreme composer as the artist who has dealt so consistently with the essentials of the new style that he may be conveniently regarded as its creator. Even with this limitation the subject is too vast for us to enter into details.

**Dramatic Instrumentation.**—There is hardly one of Wagner's orchestral innovations which is not inseparably connected with his adaptation of music to the requirements of drama; and modern conductors, in treating Wagner's orchestration, as the normal standard by which all previous and contemporary music must be judged, are doing their best to found a tradition which in another fifty years will be exploded as thoroughly as the tradition of symphonic additional accompaniments is now exploded in the performances of Bach and Handel. The main difference between symphonic and modern dramatic orchestration depends on this: that in a symphony any important incident will probably be heard again within five minutes, in every circumstance of formal symmetry and preparation that can attract the attention. This being so, it is absurd in a symphony to use only such orchestral colours as would be fit for dramatic moments which are not likely to recur for an hour or two, if they recur at all. Such a passage as bars 5 to 8 in the first movement of Beethoven's 8th symphony is as unintelligible from the point of view of Wagnerian opera as the opening of the *Rheingold* is unintelligible from the point of view of symphony. But both are quite right. The modern Wagnerian conductor is apt to complain that Beethoven, in his four-bar phrase, drowns a melody which lies in the weakest register of the clarinet by a crowd of superfluous notes in oboes, horns and flutes. The complainer entirely overlooks the fact that this is the kind of music in which such a phrase will certainly be heard again before we have time to forget it; and as a matter of fact the strings promptly repeat it *fortissimo* in a position which nothing can overpower. A crowd of instruments that seemed at first to overwhelm it in sympathetic comments is perfectly dramatic and appropriate on the symphonic scale. On the operatic scale established by Wagner such detail is simply lost. Far greater polyphonic detail of another kind is no doubt possible, but it requires far longer time for its expression. It cannot change so rapidly. It engages the ear more exclusively, and therefore it needs an accuracy and an elaboration of paraphernalia quite irrelevant to symphonic art. The accuracy and the paraphernalia are equally exemplified in all Wagner's additions and alterations of the classical orchestral scheme, for these all consist in completing the families of instruments so that each timbre can be presented pure in complete harmony. But the greatness of Wagner is shown in the fact that with all the effect his additions have in revolutionizing the resources of orchestration, he never regards his novelties as substitutes for the natural principles of instrumental effect. His brass instruments have lost nothing of their ancient nobility. In his gigantic designs it inevitably happens that instrumental

resources are strained to their utmost, and there is, perhaps, hardly anything which the makers and players of instruments can be trained to do which is too remote to be demanded by some extreme dramatic necessity in Wagner's scheme. But it is always some such extreme necessity that demands it, and never an appetite too jaded for natural resources. The crucial example of this is what Richard Strauss has ingeniously called the "al fresco" treatment of instruments in large orchestral masses (Berlioz-Strauss, *Instrumentationslehre*, edition Peters). Experience shows that in the modern orchestra there is safety in numbers, and that passages may with impunity be written for thirty-two violins which no single player can execute clearly. Whether this justifies Wagner's successors and imitators in showing a constant preference for passages of which not even the general outline is practicable; whether it justifies a state of things in which the normal compass of every instrument in an advanced 20th-century score would appear to be about a fifth higher than any player of that instrument will admit; whether it proves that it is artistically desirable that when there are eight horns in the orchestra their material should be indistinguishable from pianoforte writing, and that, in short, the part of every instrument should look exactly like the part of every other—such questions are for posterity to decide. At present we can only be certain that the criterion according to which Brahms, being a symphonic writer, has no mastery of orchestration whatever, is not a criterion compatible with any sense of symphonic style. It is therefore not a criterion which can do justice to the principles of Wagner's non-symphonic art, for its appreciation thereof is inevitably one-sided. Least of all can it conduce to the formation of sound critical standards for the new instrumentation which is now in process of development for the future forms of instrumental music. These, we cannot doubt, will be as profoundly influenced by Wagner as the sonata style was influenced by Gluck.

Finally it must be remembered that musical euphony and emotional effect are inseparable from considerations of harmony and polyphony. Timbre itself is, as Helmholtz shows, a kind of harmony felt but not heard. Not even the imagination and skill of Berlioz could galvanize into permanent artistic life an instrumentation based exclusively upon instruments, however suggestive his wonderful orchestral effects may have been to contemporary and later artists, who realize that artistic effects must proceed from artistic causes.

**Chamber-music.**—The instrumentation of solo combinations is one of the largest and most detailed subjects in the art of music. Something has been said above as to its earlier aspects in the time of Haydn. Before that time it was based exclusively on the use of the harpsichord either as a means of supporting the other instruments or as also contributing principal parts to the combination. Thus there were no string-quartets before Haydn—at least none that can be distinguished from symphonies for string-band.

Richard Strauss, in his edition of Berlioz's works on *Instrumentation*, paradoxically characterizes the classical orchestral style as that which was derived from chamber-music. Now it is true that in Haydn's early days orchestras were small and generally private; and that the styles of orchestral and chamber-music were not distinct; but surely nothing is clearer than that the whole history of the rise of classical chamber-music lies in its rapid differentiation from the coarse-grained orchestral style with which it began. Orchestral wind-parts have been discovered belonging to Haydn's string-quartet Op. 1, No. 5; his quartet in D minor, Op. 9, No. 4, is already in a style which not even the most casual listener could mistake for anything orchestral. On this differentiation of styles rests the whole aesthetics of chamber-music; but the subject is very subtle, and there is much, as for example in Schubert's quartets and his C major quintet, that is inspired by orchestral ideas without in the least vitiating the chamber-music style; though, judged by its appearance on paper, it seems as unorthodox as the notoriously orchestral beginnings of Mendelssohn's quartet in D and quintet in B♭. The beginning of Mendelssohn's F minor quartet is,

again, a case usually, but perhaps wrongly, condemned for its orchestral appearance on paper. Such matters cannot be decided off-hand by the mere fact that *tremolos* are characteristic of orchestras: the question is whether in individual cases they have not a special character when played by single players. Where this is so there need be no confusion of style; but the danger of such confusion is great, and with the rise of modern dramatic instrumentation it may be doubted whether there are any standards of criticism in current use for chamber-music of other than the sonata style. The development of pianoforte technique since Beethoven has been in some ways even more revolutionizing than that of the brass instruments; and pianoforte instrumentation, both in solo and in chamber-music, is a study for a lifetime.

#### Orchestral Schemes Typical of Different Periods.

1. 16th Century.—We, with our stereotyped modern notions of the grouping of voices, may get some idea of the freedom of the 16th-century composers' imagination by noting that the four-part movements for semi-chorus or solo voices in Palestrina's Masses present us with no fewer than seventeen different combinations of voices, and that of these the familiar group of soprano, alto, tenor and bass is not the most common, though it is invariable as that used for entire four-part Masses. In three-part movements Palestrina presents us with twelve combinations of voices. In his five-part Masses and single movements we find eight combinations, and his six-part Masses and single movements show eleven. And when he writes in eight parts for a double chorus the two groups are seldom identical.

2. 18th Century.—17th-century instrumentation may be neglected here as having begun in chaos and ended in the schemes of the 18th-century decorative instrumentation. The following is Bach's fullest orchestra: the string-band, consisting (as at the present day) of violins in two parts, violas, violoncellos, doubled (where the contrary is not indicated) by double basses; the wind instruments (generally one to each part, as the string-band was never large)—2 flutes, 2 or 3 oboes, or oboe *d'amore* (a lower-pitched and gentler type), *taille* or oboe *da caccia* (some kind of alto oboe corresponding to the cor anglais), bassoon, generally doubling the string basses, 2 horns, with parts needing much greater practice in high notes than is customary to-day, 3 (occasionally 4) trumpets, of which at least the first 2 were played by players especially trained to produce the much higher notes than are compatible with the power to produce the lower notes (the high players were called *Clarin-Bläser*; and the others *Principal-Bläser*); a pair of kettle-drums, tuned to the tonic and dominant of the piece.

Handel's orchestra is less detailed. He does not seem to have found any English trumpeters capable of playing as high parts as those of the German *Clarin-Bläser*, and his plan seems generally to get as many oboes and bassoons as could be procured to double the top and bottom of his string-band. But his definite orchestral effects in certain places (e.g. "He led them forth like sheep," in *Israel in Egypt*, and the music of the *Witch of Endor*, and the appearance of Samuel's spirit in *Sam*) are as modern as Gluck's.

3. Symphonic Orchestration.—Mozart's full symphonic scheme requires the string-band, 1 flute (rarely 2), 2 oboes, 2 clarinets (when-ever he could obtain them, he being the first composer who really appreciated them, instead of regarding them either as cheap substitutes for the *clarino* or high trumpet of Bach, or, like Gluck and, with rare and late exceptions, Haydn, as merely adding to the force of *tutti* passages). Further, 2 horns, 2 bassoons, 2 trumpets and a pair of kettle-drums.

Mozart imports from church music 3 trombones for special passages in his operas.

Beethoven almost always has 2 flutes, and invariably 2 clarinets. In his 5th symphony he introduced 3 trombones and extended both the upper and lower extremes of the wind-band by a piccolo and a double bassoon. "Turkish music," i.e. the big drum, cymbals and triangle, was used by Haydn in his *Military Symphony*; and Mozart in his *Entführung*, for reasons of "local colour"; it appears as an extreme means of climax in the finale of Beethoven's 9th symphony.

4. Wagner's Orchestras *Tristan* and *Isolde*.—(Families of instruments are connected by a brace.)

Strings: as usual, but subject to minutely complex grouping.

3 flutes (3rd to play piccolo when required).

2 oboes.

1 cor anglais.

3 bassoons.

2 clarinets.

1 bass clarinet.

4 horns. (The mechanical innovations by which horns and trumpets acquired a complete scale have revolutionized the nature of those instruments; and Wagner's orchestration more than that of any other composer, has profited by this. Yet, in the preface to the score Wagner speaks very strongly of the loss of the original character of the horns in the hands of

ordinary players; and goes so far as to say that, if experience had not shown that they could be trained to play *nearly* as smoothly as the classical players, he would have renounced all the advantages of the new mechanism.)

3 trumpets.

3 trombones.

1 tuba.

2 or, for safety in tuning, 3 kettle-drums.

Triangle and cymbals.

1 harp (multiplied *quant. suf.*).

In *Der Ring des Nibelungen* Wagner specifies the proportions of the string-band as 16 first and 16 second violins, 12 violas, 12 violoncellos, 8 double basses. The rest of the orchestra consists of—

Piccolo and 3 flutes.

3 oboes and cor anglais, or 4th oboe.

3 bassoons, or 2 and contra-fagotto.

3 clarinets and 1 bass clarinet.

8 horns, 4 of whom are also required to play 4 specially constructed tenor and bass tubas.

1 ordinary (double-bass) tuba.

3 trumpets.

1 bass trumpet. (A project of Wagner's which instrument-makers found impracticable, so that Wagner had to content himself with a kind of valve trombone shaped like a trumpet.)

3 trombones and 1 double-bass trombone.

2 pairs of kettle-drums.

Triangle.

Cymbals.

Big drum.

Gong.

6 harps.

5. Chamber-music.—Bach's and his contemporaries' combinations with the harpsichord show the natural fondness, in his day, for instruments of a tone too gentle for prominent use in large rooms, or indeed for survival in modern times. Thus there was quite as much important solo music for the flute as for the violin; and almost more music for the viola da gamba than for the violoncello. A frequent combination was flute, violin and harpsichord (very probably with a violoncello doubling the bass), and in more than one case the violin was partly tuned lower to soften its tone.

Classical and modern chamber-music in the sonata style consists mainly of string-quartets for 2 violins, viola and violoncello; string-trios (rare, because very difficult to write sonorously); pianoforte-trios (pianoforte, violin and violoncello); pianoforte-quartets (pianoforte with string-trio); pianoforte-quintets (pianoforte with string-quartet); string-quintets (with 2 violas, very rarely with 2 violoncellos), and (in two important cases by Brahms) string-sexets. Larger combinations, being semi-orchestral, especially where the double-bass and wind instruments are used, lend themselves to a somewhat lighter style; thus Beethoven's septet and Schubert's octet are both in the nature of a very large serenade.

Wind instruments produce very special effects in chamber-music, and need an exceedingly adroit technique on the part of the composer. Magnificent examples are Mozart's trio for pianoforte, clarinet and viola, his quintet for pianoforte, oboe, clarinet, horn and bassoon (imitated by Beethoven), his quintet for clarinet and strings, Brahms's clarinet-quintet for the same combination, and his trio for pianoforte, violin and horn. (D. F. T.)

**INSTRUMENT OF GOVERNMENT**, the name given to the decree, or written constitution, under which Oliver Cromwell as "lord protector of the commonwealth" governed England, Scotland and Ireland from December 1653 to May 1657.

The Long Parliament was expelled in April 1653 and the council of state dissolved; the Little, or Nominated, parliament which followed ended its existence by abdication; and Cromwell, officially lord general of the army, with a new council of state, remained the only recognized authority in the country. It was in these circumstances that the Instrument of Government, drawn up by some officers in the army, prominent among whom was John Lambert, was brought forward. The document appears to have been under consideration since the middle of October 1653, but Ludlow says it was "in a clandestine manner carried on and huddled up by two or three persons," a remark probably very near the truth. The nominated parliament abdicated on the 12th of December 1653, and after certain emendations the Instrument was accepted by Cromwell on the 16th. Consisting of forty-two articles, the Instrument placed the legislative power in the hands of "one person, and the people assembled in parliament"; the executive power was left to the lord protector, whose office was to be elective and not hereditary, and a council of state numbering from thirteen to twenty-one members. The councillors were appointed for life;

fiten were named in the Instrument itself; and Cromwell and the council were empowered to add six. To fill vacancies parliament must name six persons, of whom the council would select two, the choice between these two being left to the protector. A parliament was to meet on the 3rd of September 1654, and until that date the protector with the consent of the council could make ordinances which would have the force of laws. After the meeting of parliament, however, he had no power of legislation, nor had he any veto upon its acts, the utmost he could do being to delay new legislation for twenty days. A new parliament must be called "once in every third year," elaborate arrangements being made to prevent any failure in this respect, and for five months it could not be dissolved save with its own consent. The parliament, composed of a single chamber, was to consist of 460 members—400 for England and Wales, and 30 each for Scotland and Ireland—and the representative system was entirely remodelled, growing towns sending members for the first time, and many small boroughs being disfranchised. A large majority of the English members, 265 out of 400, were to be elected by the counties, where voters must possess land or personal property of the value of £200, while in the boroughs the franchise remained unaltered. In Scotland and Ireland the arrangement of the representation was left to the protector and the council. Roman Catholics and all concerned in the Irish rebellion were permanently disfranchised and declared incapable of sitting in parliament, and those who had taken part in the war against the parliament were condemned to a similar disability during the first four parliaments. The protector was empowered to raise a revenue of £200,000 in addition to a sum sufficient to maintain the navy and an army of 30,000 men, and religious liberty was granted "provided this liberty be not extended to Popery or Prelacy." The chief officers of state were to be chosen with the consent of parliament, and a parliament must be summoned at once in case of war. The practical effect of the Instrument was to entrust the government of the three countries to the parliament for five months out of every three years, and to the protector and the council for the remainder of the time. Although the Instrument bristled with possibilities of difference between parliament and protector, "it is impossible," as Gardiner says, "not to be struck with the ability of its framers."

Having issued many ordinances and governed in accordance with the terms of the Instrument, Cromwell duly met parliament on the 3rd of September, and on the following day he urged the members to give it the force of a parliamentary enactment. Many representatives objected to the provision placing the supreme power in the hands of a single person and of parliament, a discussion which was futile, as clause XII of the Instrument declared that "the persons elected shall not have power to alter the government as it is hereby settled in one single person and a parliament." The proceedings were soon stopped by Cromwell, who on the 12th of September explained that there was a difference between "fundamentals" which they might not, and "circumstantial" which they might, alter. He concluded by stating that they would be excluded unless they subscribed a recognition to be true to the protector and the commonwealth, and to respect the terms of clause XII. Over three hundred members took the required step; but they proceeded to alter the Instrument in other ways, and over the question of the control of the army they were soon in sharp conflict with the protector. At length, on the 22nd of January 1655, Cromwell, counting twenty weeks as five months, dissolved parliament.

Regarding the Instrument as still in force the protector sought for a time to rule in accordance with its provisions; but new difficulties and growing discontent forced him to govern in a more arbitrary fashion. However, in July 1656 he issued writs for a second parliament which met in the following September. Many members, men of advanced views, were excluded by the council of state, acting on the strength of clause XVII, which declared that those elected must be "persons of known integrity, fearing God, and of good conversation." The remainder discussed the question of the future government of the country,

and in May 1657 Cromwell assented to the Humble Petition and Advice, which supplanted the Instrument of Government. Gardiner says the Instrument was "the first of hundreds of written constitutions which have since spread over the world, of which the American is the most conspicuous example, in which a barrier is set up against the entire predominance of any one set of official persons, by attributing strictly limited functions to each."

The text of the Instrument is printed in S. R. Gardiner's *Constitutional Documents of the Puritan Revolution* (Oxford, 1899). See also S. R. Gardiner, *History of the Commonwealth and Protectorate*, vols. ii. and iii. (London, 1897-1901); L. von Ranke, *Englische Geschichte* (1859-1868); and T. Carlyle, *Cromwell's Letters and Speeches* (London, 1897-1901). (A. W. H. \*)

**INSUBRES** (*Ἰσσυβρες, Ἰνσουβροι*), a Celtic people of upper Italy, the most powerful in Gallia Transpadana, inhabiting the country between the Adda, the Ticinus and the Alps. According to Livy (v. 34) they appear to have been a branch of the Aedui in Gallia Transalpina, though others assume that they were Umbrians, a view to some extent supported by the form *Is-ombr-es*. Livy states that Bellovesus and his Gauls, having crossed the Alps and defeated the Etruscans near the Ticinus, found themselves in the territory of the Insubres (also the name of a *pagus* of the Aedui). Here they built a city and called it Mediolanum (Milan), after the name of a village in their home in Gallia Transalpina. The name Insubres thus appears applied to the inhabitants (1) of the Aeduan *pagus*, (2) of the territory in Gallia Transpadana occupied by Bellovesus, (3) to the founders of Mediolanum. From 222 to 195 B.C. the Insubres were frequently at war with the Romans. In 222 they were defeated at Clastidium by M. Claudius Marcellus, who gained the *spolia opima* by slaying with his own hand their king Viridomarus (Viridomarus), and in 194 they were finally subdued by L. Valerius Flaccus.

See H. Nissen, *Italische Landeskunde* (1902) ii. 179; A. Holder, *Altitalische Sprachschatzk., ii.* (1904).

**INSURANCE**, a term meaning generally "making oneself safe against" something, but specially used in connexion with making financial provision against certain risks in the business of life. The terms Assurance and Insurance are in ordinary usage synonymous, but in the profession "assurance" is confined to the "life" business, and "insurance" to fire, marine and other miscellaneous risks. Assurance was the earlier term, and was used of all forms of insurance indiscriminately till the end of the 16th century. Insurance—in its earlier form, "insurance"—was first applied to fire risks (see note s.v. "Insurance" in the *New English Dictionary*).

#### I. GENERAL HISTORY

During the latter half of the 19th century the practice of insurance extended with unprecedented rapidity, partly in novel forms. While its several branches, such as life insurance, casualty insurance and others, have each had an independent and characteristic development, all these together form an institution peculiar to the modern world, the origin and growth of which attest a remarkable change in men's ideas and habits of thought.

The simplest and most general conception of insurance is a provision made by a group of persons, each singly in danger of some loss, the incidence of which cannot be foreseen, that when such loss shall occur to any of them it shall be distributed over the whole group. Its essential elements, therefore, are foresight and co-operation; the former the special distinction of civilized man, the latter the means of social progress. But foresight is possible only in the degree in which the consequences of conduct are assured, i.e. it depends on an ascertained regularity in the forces of nature and the order of society. To the savage, life is a lottery. In hunting, rapine and war, all his interests are put at hazard. The hopes and fears of the gambler dominate his impulses. As nature is studied and subdued, and as society is developed, the element of chance is slowly eliminated from life. In a progressive society, education, science, invention, the arts of production, with regular government and civil order,



steadily work together to narrow the realm of chance and extend that of foresight. But there remain certain events which may disturb all anticipations, and in spite of any man's best wisdom and effort may deprive him of the fruits of his labour. These are mainly of two classes: (1) damage to property by the great forces of nature, such as lightning and hail, by the perils of the sea and by fire; (2) premature death. A useful life has an economical value. But no skill can make certain its continuance to its normal close. In the reasonable expectation that it will last until a competence is gained or the family ceases to be dependent, young men marry; but some will die too soon, and in the aggregate multitudes are left destitute. Both classes of loss are alike, in that they fall on individuals in the mass who are not known beforehand nor selected by any traceable law. But the sufferers are ruined, while the same pecuniary loss, if distributed over the whole number, would be little felt. Wherever the sense of community has existed this has been discerned, and some effort made to act upon it. Thus in feudal Europe it was customary for the houses of vassals to be restored after fire at the cost of the estate. In England in the 17th century the government practised a method of relief after accidental fires. When such a loss was proved to the king in council, the chancellor sent a king's brief to churches, sheriffs and justices, asking contributions, and trustees for the sufferers administered the funds collected. But under the last two Stuarts gross frauds resulted, and the system fell into disrepute and disuse. At best, the voluntary relief provided by charity after losses are incurred is but sporadic and irregular. Insurance begins when the liability to loss is recognized as common, and provision is made beforehand to meet it from a common fund. The efficient organization of communities or groups for this purpose is an essentially modern achievement of social science. But the history of the conception in its formative stages is extremely obscure.

Its first appearance in business life is often sought in the marine loans of the ancient Greeks, fully described by Demosthenes. Money was advanced on a ship or cargo, to be repaid with large interest if the voyage prosper, but not repaid at all if the ship be lost, the rate of interest being made high enough to pay not only for the use of the capital, but for the risk of losing it. Loans of this character have ever since been common in maritime lands, under the name of bottomry and *respondentia* bonds. (See below, *Marine Insurance*.) But the direct insurance of sea-risks for a premium paid independently of loans began, as far as is known, in Belgium about A.D. 1300. During the next century the risks of insurance for the usual voyages between London and European ports were carefully considered, and customary rates became established. In his address in opening Elizabeth's first parliament in 1559, Sir Nicholas Bacon said, "Doth not the wise merchant in every adventure of danger give part to have the rest assured?" In 1601 parliament created a commission to decide disputes under contracts for marine insurance, and the preamble of the act (43 Eliz. ch. 12) expresses the best thought of the British mind in that day upon the subject. Thus the business of marine insurance was intelligently and wisely practised three centuries ago. But the underwriters were private persons, acting independently, so that the insured lacked the benefit of large aggregations of capital to make his contract safe; while the insurer, who took one or a few risks, was without the security of large averages and might be crushed by an exceptional loss. A partial remedy was gradually reached in London. Men who had capital to employ in this hazardous business used to meet at fixed hours when shipowners and merchants could negotiate with them. The higgling of the open market, in view of all the circumstances of each risk—as the character and condition of the ship, its crew and cargo, the length and route of the voyage, the season, the current rate of interest and profits—determined the rate of premium; and when this obtained general assent, the written agreement was signed by each underwriter for that part of the risk which he assumed. Towards the end of the 17th century these meetings were held in Lloyd's coffee-house, and their simple practice gradually

grew into the complete and complicated system of marine insurance now general. The underwriters together evolved rules and improved methods, but continued for generations to insure severally, without corporate powers or common responsibility, so that the name Lloyd's became throughout the commercial world the symbol of marine insurance. More recently the name has been adopted in the United States by associations of private or individual underwriters as distinguished from insurance corporations.

Although the underwriters at Lloyd's often considered and assumed other than marine risks, and made contracts some of which were merely wagers on public or private events, there is no record of insurances by them against fire on land. But fire insurance, it is vaguely known, had previously been practised, in a crude form, in several European cities. In 1635, and again in 1638, citizens of London petitioned Charles I. for a patent of monopoly to insure houses at the rate of one shilling yearly for each £20 of rent, the association to repair or rebuild those burned, to maintain a perpetual fire-watch in the streets, and to pay £200 yearly towards rebuilding St Paul's cathedral until finished. The attorney-general approved the project, but in the disorders of the kingdom it was forgotten. The Great Fire of 1666 revived interest in the subject, and led to practical measures. In May 1680 a private fire office was opened "at the back side of the Royal Exchange" to insure houses in London, by assuming the risk of loss to a fixed amount for a fixed premium, namely, 2½% of the yearly rent for brick houses and 5% for frame houses, the rent being always assumed to be one-tenth of the value of the fee. The estimates of the promoters are interesting. In the fourteen years since the Great Fire 750 houses had been burned in London, with an average loss of £200. A fund of £40,000 subscribed as guaranty was to be increased by £20,000 for every 10,000 houses insured, and the interest of the fund alone therefore might be expected to meet all losses and leave a surplus. Thus the security was perfect and the promise of profit great. Meagre as was the basis of facts for the calculations, and crude as was the statistical method employed, the insurance offered met a general want and the business grew rapidly. Within a year a strong demand was heard that the city of London should itself insure the houses of its citizens, and the common council voted to do so at lower rates than the fire office. But the courts put a speedy end to this movement, holding that the charter conferred on the city no power to transact such business. Thus the socialistic theory that insurance is properly a branch of government is almost as old as the business itself, though it has never found favour or been practically tested on a large scale in Great Britain or America.

The next notable step in the evolution of modern methods was the organization of mutual insurance associations. In 1684 the Friendly Society was organized. Each member paid a small entrance fee for expenses, made a cash deposit as a reserve for emergencies, to be returned at the end of his term, and agreed to meet equitable assessments for current losses. Payments were computed on the assumption that one house in 200 is burned every fifteen years. The rivalry between the proprietary and the mutual systems began at once, and has continued till now. In 1686 "the Fire Office at the back side of the Royal Exchange" petitioned for a patent of the fire insurance policy and a monopoly of its issue for thirty-one years. The Friendly Society opposed the grant. The most eminent lawyers for both were heard by the king in council, and on the 30th of January 1687 King James II. decided the case. No charter was granted; but the Fire Office might continue its business, having a monopoly for one year. Thereafter the Friendly Society might for three months sell policies, but must then suspend for three months, and so on for alternate quarters. But the Fire Office must pay the ordinance service for its work in extinguishing fires, the amount to be fixed for each fire by the king. This was the first appearance of the plan, so widely prevalent in after years, of imposing on insurance companies the support of fire departments; that is, of taxing the prudent who insure to protect the reckless who do not.

After 1688 the atmosphere of England was freer, and underwriting was soon practised without special licence. In 1704 the societies began to insure household goods and stocks in trade, and the insurance of personal property rapidly became as important as that of buildings. In 1706 the Sun Fire Office was founded, and began to issue policies on both real and personal property in all parts of England. Other associations arose in quick succession of which the Union Fire Office, dating from 1714, and the Westminster from 1717, still survive. Before 1720 both fire and marine insurance had become general in all great centres of trade. But life insurance was as yet hardly conceived. Sporadic evidences that it was needed, and that men were feeling after it, occur in very early records. It was a medieval custom to advance to a mariner goods or money, to be restored with large additions, but only in case of safe return; or to contract, for a sum in hand, to ransom him if captured by pirates, or to pay a fixed amount to his family if he were lost. To evade the usury laws life annuities were often sold at a low rate, redeemable for a stipulated sum. Life estates were sold upon some guess at their probable duration; and leases, especially of church lands, were made for one, two or three lives on rude and conventional estimates of the time they would run. Thus there was a commercial and social pressure for some intelligent method of valuing life contingencies. But the direct insurance of life, as a means of reducing the element of chance in human affairs, was hardly thought of. Indeed, such contracts were commonly regarded as mere forms of gambling, and were prohibited in France as against good morals.

The earliest known policy of life insurance was made in the Royal Exchange, London, on the 18th of June 1583, for £383, 6s. 8d. For twelve months, on the life of William Gibbons. Sixteen underwriters signed it, each severally for his own share, and the premium was 8%. The age of the insured is not referred to, nor was it then considered, except when far advanced, in fixing the premium. Gibbons died on the 20th of May 1584. The underwriters refused to pay, alleging that twelve months, in law, are twelve times twenty-eight days, and that Gibbons had survived the term. The court, of course, enforced payment. A few instances of similar contracts are found, mostly in judicial records, during the 17th century; but every such transaction was justly regarded as a mere wager, at least on the part of the insurer. It could not be otherwise until the principles of probability and the uniformity of large averages were understood and trusted. A few great thinkers were groping for principles which were profoundly to modify the practical reasoning of after-generations. But their work first obtained wide recognition upon the publication of the *Ars Conjectandi*, the posthumous treatise of Jacques Bernoulli, in 1713. Meanwhile the social need for insurance continued to express itself in empirical efforts, which at least helped to make clearer the problems to be solved. Thus in 1609 "The Society of Assurance for Widows and Orphans" was founded in London, a crude form of what is now called an assessment company. Each of 2000 healthy men under fifty-five years of age was to pay 5s. as entrance fee, 1s. quarterly for expenses, and 5s. at the death of another member; and at his own death his estate should receive £500, less 3%. On default in any payment his interest was forfeited. The society lasted about eleven years, and the accounts of its eighth year are preserved, showing the payment of £5200 upon twenty-four claims. The economic significance of this society lies in its distinct recognition of the principle of association for the distribution of losses. Together with the Friendly Society, it shows that this principle had now been so widely grasped by business men that, when embodied in a practical venture, it found substantial support.

The conception of a corporation as an artificial person to hold property and support obligations uninterrupted by the death of individuals was found in Roman law and custom. Its first use in modern business enterprise was perhaps the Bank of St George in Genoa, about A.D. 1200, a joint-stock company with transferable shares, whose owners were liable only to the amount

of their shares. In England the crown, being the chief and type of corporations sole, was the source of chartered rights, and from about 1600 the principle steadily gained recognition, the advantages of incorporation being attested by the successes of the great trading companies. Experience showed that the corporate form was the obvious remedy for the chief difficulties in the practice of insurance. Single risks were but speculative wagers; a great number must be taken together to obtain a trustworthy average. A larger capital than an average private fortune was demanded as a guaranty, and this capital must not be exposed to the dangers of trade, but set aside for the special purpose. Individual underwriters may die or fail; only a permanent institution can be trusted in long contracts. Several projects were devised on this basis. Early in the 18th century, indeed, the English government refused a charter for marine insurance, declaring that corporate insurance was an untried and needless experiment, while private underwriting was satisfactory and sufficient. But in 1720, when two sets of promoters offered £300,000 each for a charter, exclusive of other associations though not of individuals, to insure marine risks, parliament chartered the Royal Exchange and the London Assurance Company with a monopoly to this extent. The business disappointed its projectors at first, and the government accepted half the price rather than revoke the grant. In 1721 the companies extended their operations to fire insurance throughout England.

Thus the principle of insurance had now become a distinct part of the common stock of thought in enlightened nations, and gradually, by association with successive new ideas, plans, and methods, was developed into a business or trade, which before the middle of the 18th century already formed an essential element of the social scheme. Most of the modern forms of insurance against the elements were known, and at least crudely practised. But there was no scientific basis for the business. Premiums were fixed, not by computation from known facts or reasonable assumptions, but by guess and the higgling of the market. Only the competition of capital checked the extortionate demands of underwriters. The first important steps towards a scientific valuation of hazards were taken in dealing with the class of risks hitherto so much neglected, those which depend upon human mortality. Marine and fire insurance had their origin in the pressure of need. The practice began before a theory existed. But life insurance had its origin in the scientific study of the facts of human mortality. Both marine and fire insurance became general before there was any intelligent study of the risks by statistical or mathematical methods, nor can it be said that much progress has since been made towards establishing a scientific basis for the valuation of risks in these classes. But life insurance may be said to have been impossible until the theory of probabilities had become a recognized part of the common stock of ideas.

The value of insurance as an institution cannot be measured by figures. No direct balance-sheet of profit and loss can exhibit its utility. The insurance contract produces no wealth. It represents only expenditure. If a thousand men insure themselves against any contingency, then, whether or not the dreaded event occurs to any, they will in the aggregate be poorer, as the direct result, by the exact cost of the machinery for effecting it. The distribution of property is changed, its sum is not increased. But the results in the social economy, the substitution of reasonable foresight and confidence for apprehension and the sense of hazard, the large elimination of chance from business and conduct, have a supreme value. The direct contribution of insurance to civilization is made, not in visible wealth, but in the intangible and immeasurable forces of character on which civilization itself is founded. It is pre-eminently a modern institution. Some two centuries ago it had begun to influence centres of trade, but the mass of civilized men had no conception of its meaning. Its general application and popular acceptance began within the first half of the 19th century, and its commercial and social importance have multiplied a hundred-fold within living memory. It has done more than all gifts of impulsive charity to foster a sense of human brotherhood and of

common interests. It has done more than all repressive legislation to destroy the gambling spirit. It is impossible to conceive of our civilization in its full vigour and progressive power without this principle which unites the fundamental law of practical economy, that he best serves humanity who best serves himself, with the golden rule of religion, "Bear ye one another's burdens."

## II. CASUALTY AND MISCELLANEOUS INSURANCE

Before proceeding with an account of the standard institutions of fire and life insurance, it is proper to glance at the modern vast extension of casualty insurance, and to notice certain novel applications of the insurance principle to other special classes of events. The novelty of these enterprises, however, is not in the general idea underlying each of them. In almost every instance in which insurance has been extended, so as successfully to cover new kinds of risks, it will be found that the suggestion is nearly as old as the practice of life insurance. Many more kinds of insurance than are even now found useful were attempted more than a century ago. But no statistical basis then existed for determining the probability of loss from various casualties, nor had the methods of canvassing, accounting, proving and checking losses, reached the perfection now recognized as necessary for efficiency and safety. The various branches of business which, in distinction from the great standard institutions of life, fire and marine insurance, are commonly treated as miscellaneous insurance, differ widely in their subjects and methods. The most general of them, and that most widely known, is insurance against personal injury by accidents of every kind. Much has already been done by the companies in collecting and analysing facts, so as to determine the average risk of injury and disablement among different classes of men. But there is as yet no such union of effort among them to combine their resources for such purposes as among the life companies, nor does the subject admit of treatment so exact as that of human mortality. Hence it is impossible to speak of a theory of accident insurance in a scientific sense; and in its practice premiums and necessary reserves are determined by the trained business judgment of individual managers rather than by the calculations of actuaries from statistical collections of facts.

The insurance of railway travellers against injury upon trains was the first form of accident insurance which proved widely acceptable. This is still practised as a special business by several companies, tickets, entitling the purchaser or his family to a fixed compensation in case of his injury or death, being offered for sale with the railway tickets. But the development of insurance against personal injuries, which is most characteristic of the times, is the wholesale insurance of the employer against liability to the employed for accidental injuries sustained in his service. This was first undertaken on a large scale by the "Employers' Liability Assurance Corporation of London," founded for the purpose in 1880, immediately after the passage of the Employers' Liability Act by parliament, which made employers of labour liable for injuries sustained in their service to an extent unknown to the common law. The Workmen's Compensation Act 1906 greatly extended the classes of employers liable for accidents to their servants, and the number of companies devoting themselves to accidents and workmen's compensation has greatly increased, while practically every fire insurance office has taken up the business. The policies are issued to employers of labour, agreeing to indemnify them for any loss to which they may be subjected, at common law or by statute, in consequence of bodily injuries suffered by any employee while engaged in their service. In some cases the insurance company undertakes the investigation and settlement of each claim within the limits prescribed by the policy, and conducts any litigation which may result. The adjustment of damages can be made with more economy and skill by the companies than is usually possible for the employer, and the danger of fraudulent claims is largely reduced by methods experience has taught them. The price charged for such insurance is either a small percentage of the aggregate wages paid during the term, or a standard rate for each particular class of employment,

or (in the case of large employers of labour) an "all-round" rate designed to cover every class of employee.

The most common form of accident insurance, however, is still represented by the policy which promises the assured a fixed sum in case of death by accident, and a weekly compensation during disability from such a cause. Many policies also specify a sum to be paid for the loss or permanent damage of a member, as an eye, a hand or foot. Another extension of the personal accident policy is the addition of some form of health insurance, especially the grant of a weekly sum to the insured during incapacity for work caused by certain named diseases. Besides the ordinary joint stock companies which carry on this class of business with fixed premiums, many associations organize for insurance against personal injury by accident, relying upon the assessment of members to pay claims as they mature. Many of these are local and ephemeral; but a number of them, formed by men engaged in common pursuits, for mutual protection, have attained importance. Such are especially some of the commercial travellers' and the railway employees' accident associations, and a few connected with the Masonic or similar beneficiary orders.

Another large class of casualty insurances applies to various forms of damage to property. The branch which seems most to have attracted promoters is the insurance of plate glass against fracture, which is carried on by a number of companies in Great Britain, and is the only instance of one of special skill and vigilance, extending far beyond the contract for indemnity. The company, in fact, employs inspectors of the highest scientific qualifications, who assume constant supervision of the machinery, and require its structure and conduct to be freed from elements of danger. It is prevention rather than compensation that is sought, and the outlay made by the companies is mainly for inspection and control, not for losses. It is usual to promise in a policy upon a steam boiler some compensation also for any personal injury which may result from an explosion.

There are several companies in the United Kingdom and in America which make the insurance against damage by the explosion of steam boilers a special feature of their work, but by far the greater part of the business is transacted by one company in each country. The service rendered is one of special skill and vigilance, extending far beyond the contract for indemnity. The company, in fact, employs inspectors of the highest scientific qualifications, who assume constant supervision of the machinery, and require its structure and conduct to be freed from elements of danger. It is prevention rather than compensation that is sought, and the outlay made by the companies is mainly for inspection and control, not for losses. It is usual to promise in a policy upon a steam boiler some compensation also for any personal injury which may result from an explosion.

There are some companies in England having insurance against burglary for their principal purpose, while several of the British and American accident companies issue policies of this kind. It is somewhat of an experiment, and the risks taken are for moderate sums, at premiums determined in each case by an estimate of the danger founded on a study of all the circumstances. There is no information published concerning this branch of insurance in other countries, but the aggregate premiums paid are not at present very large. It is believed by many that there is an important future for burglary insurance, in connexion with improved methods of protection, by safes, automatic alarms and constant inspection, for dwelling-houses, shops and offices, which are often unoccupied.

Insurance against damage to growing crops by hail is practised in several parts of Europe and America, commonly by small local associations on the mutual plan or as an incident to the business of fire insurance. No statistics can be obtained of these operations. The same is true of the insurance against the ravages of tornadoes, and against sickness and accident in domestic animals.

A wholly distinct business, commonly classed as a branch of insurance, has now grown to great importance, that of guaranteeing the fulfilment of contracts and of indemnifying employers against defalcations in their service. The bond of a corporation of large capital is widely taking the place which personal surety has filled in connexion with undertakings on contract, and with offices and occupations of trust, both in public and in private life. Fidelity insurance is carried on by a few of the general casualty companies, but as the practice of it extends it becomes more and more the work of special institutions organized for this purpose alone. In the United States there are many corporations of excellent standing, with aggregate paid-up capital of more than \$15,000,000 and surplus funds of nearly \$10,000,000 more, and collecting in premiums about \$4,000,000 annually upon bonds and guarantees amounting to more than \$1,250,000,000. The business practically only started at the close of the 19th century. It has had similar if not equal development in Great Britain and in several other countries, but it is only in the United States that the statistics of it are officially collected.

The insurance of titles to real property is also becoming widely extended. This business, however, has indemnity for losses as but an incidental purpose. The principal aim is to furnish a final and responsible assurance that the title is free of all claims and encumbrances of the United States, or to elaborate and expensive collection of records, covering the sources of title for cities or large districts; all of them employ expert ability of a high order; and when they approve a title as perfect, the purchaser or lender of

money may receive, with the approval, a guaranty against loss in accepting it, which private examiners or counsel cannot give. Titles are insured also in other countries, but the business has nowhere else attained such importance, nor do the institutions transacting it make full and separate statements of their accounts. Other minor forms of insurance are against bad debts, bonds and securities in transit, earthquakes, failure of issue, loss on investment, leasehold redemption, non-renewal of licences, loss of or damage to luggage in transit, damage to pictures, loss of profits through fire, imperfect sanitation, birth of twins, &c.

### III. FIRE INSURANCE

The growth of the business of fire insurance since 1880 or thereabouts has been commensurate with the increase of wealth and of commercial activity in the foremost nations, while the practice of it has also become general in countries in which it was formerly little known. The statistics of the subject have in recent years become far more full and more accessible than formerly; partly because many governments require detailed reports of resources, receipts and expenditures from all companies permitted to establish agencies within their jurisdiction, and periodically publish summaries of the returns; but also largely because the companies seek the widest publicity as their best means of advertising. It is to be regretted that there is as yet no uniformity of method in these returns; while some of the most important elements of the subject are not sufficiently illustrated for the student in the published statistics. Many companies of the United Kingdom transact business throughout a great part of the world, and there is no means of determining how much of their receipts or their losses must be referred to Great Britain. Further, they fail to give classified amounts at risk, so that it is impossible to estimate with any confidence the total sum for which any kind of property, such as dwellings, factories, household goods, stocks of merchandise or wares in transit, is insured. The returns of the London Fire Brigade, however, which is in part maintained by regular contributions from the fire underwriters at the rate of £35 for each £1,000,000 of risks assumed by them within the metropolitan district, continue to exhibit a regular growth. The aggregate amount insured in the metropolis was reported as follows:—

In 1882 . . . . .	£696,715,141
1886 . . . . .	741,109,316
1890 . . . . .	806,131,285
1895 . . . . .	858,899,409
1900 . . . . .	963,291,097
1905 . . . . .	1,034,819,587

It appears probable that the rate of increase here shown is not greater than the actual growth of insurable property during the same period, so that it may be reasonably supposed that the custom of protecting all exposed property by insurance was already general in London many years ago. But the transactions of the British fire offices have grown much more rapidly, and indicate that, outside of the metropolitan district, the practice of insurance has extended greatly. The returns show that there is a tendency to concentrate the business in the control of large capital and experience, for practically all the premiums received and losses paid were shared by thirty-one companies, although there are at the same time a greater number of corporations of foreign countries with agencies for fire insurance in the United Kingdom; but many of these do but a nominal amount of business, and twenty-three of them are exclusively or chiefly engaged in re-insurance. This tendency has been a marked feature in the later history of fire insurance everywhere. The companies which are now in the field are the survivors of tenfold as many projected enterprises which have failed. The records of about two thousand organizations for the purpose, in America alone, which have undertaken the work and disappeared within fifty years, show the dangers to which inadequate skill and capital are exposed. But a small proportion of these failures were the direct result of sweeping disasters, though about seventy of them followed the memorable fires in Chicago and Boston in 1871 and 1872. Many more, nearly one-half of the whole, have followed a short career, in which the helplessness of inexperience to compete with long training and complete organization was

demonstrated. Many hundreds of these projects were mere speculations or even frauds from the beginning; and the better education of the community at large in the principles and methods of insurance has been the chief agent in checking such enterprises, aided by the stringent legislation of several countries and of the United States in America and by the criticism of the press.

The difficulty of establishing a new joint-stock fire insurance company is far greater in the present highly perfected state of the business than formerly, and constantly increases. The reports of the state insurance departments in America show that less than one-eighth of the premiums are now collected by companies founded since 1880; and, except in districts remote from the principal financial centres, or mutual associations for special classes of hazards, new companies are not often formed. In Great Britain a considerable number of new corporations are registered every year, with fire insurance among their professed objects, but almost always in connexion with some forms of casualty insurance, which appear to be practically the purpose in view. The reports of the fire business in the United Kingdom for recent years, as collected in *Bourne's Manual*, show that less than one-fourteenth of it is done by companies organized since 1870. Though new companies have been registered, usually several every year, the number actually transacting successful business has not increased since 1880. Of the various British companies now recognized, the twelve smallest together collect but 1% of the premiums received by one of the largest, and the tendency to concentrate the business seems progressive. These facts are explained by the necessity of a vast basis of average and of a large capital for security, and still more by the increasing demand for a thoroughly trained and organized body of agents, able to protect their companies from fraud and imposition, and at the same time to compete for public patronage.

The *Mutual* principle has a strong attraction for many insurers and projectors. When a large number of pieces of property, so distributed that a single fire cannot destroy a considerable proportion of the whole, are yet owned **Mutual system.** and controlled by persons who can fully trust one another, both for financial responsibility and for good faith, there may be no need of a large capital in hand, nor of much of the costly machinery required for general competition. A contract for the assessment on all the property of losses as they occur, at rates fixed by the estimated exposure, may form a safe basis for an association. The fixed payments may be limited to necessary expenses, with a moderate reserve for emergencies, all excess of collections to be returned to the insured. This simple conception of an insurance association, with such modifications as experience indicates, has been accepted for a time as ideal in almost every civilized community, and attempts are continually made to realize it, but in the vast majority of instances with complete failure as the result. Like every other product of human skill, insurance is, for the most part, best supplied to the market by those who make it their calling to produce it for gain. But while the mutual plan has proved poorly adapted to the general service of the commercial world, in some communities, and especially among the owners of certain classes of property, it has achieved great and apparently permanent success. This is particularly true of manufacturing districts, in which numbers of mills and factories are exposed to peculiar danger of fire by the nature of their own operations. The best safeguard they can have is by employing great skill in the construction, arrangement and conduct of their works. A group of such properties, associated for the prevention of loss, is naturally stimulated to highest efficiency when the whole group undertakes to bear all losses which are not prevented, and thus every member has a strong interest in making the protection complete. It is in associations of this character that the mutual plan of fire insurance has rendered its greatest services. The mutual plan has been widely adopted also in local associations for the insurance of dwellings and farm improvements, where the individual risks are small, and where technical classification and special safeguards against fraud are not considered necessary, often with the result of affording satisfactory protection at low rates. But the ratio of this part of the business to that conducted by joint-stock companies diminishes from year to year, even in the agricultural and rural districts of the United States. According to the reports of the insurance departments of the states, as summarized in the

Spectator Company's Year-Book, more than half of the cash premiums of mutual insurance companies are collected in the two manufacturing states of Massachusetts and Rhode Island.

It is, after all, only within a very limited field that the mutual principle can be adopted. The essential principle of fire insurance is the distribution of loss. It does not aim, directly at least, at the prevention and only in a secondary way even at the minimizing of loss; but what it seeks to accomplish is that such losses shall not fall exclusively, and possibly with overwhelming effect, on the owner of the property destroyed, but shall be borne in easy proportions by a large number of persons who are all alike exposed to the risk of a similar catastrophe. To work out the equitable solution of such a problem an amount of technical skill and extended experience is required which few bodies or communities possess. Certainly, experience in Great Britain has shown that the one system of fire insurance which has contributed most to the public benefit is that which is conducted by joint-stock companies, offering to the insured the guarantee of their capital and other funds, and looking to make a profit by the business. In France, Belgium, Holland, Russia and Norway, also, the joint-stock plan is almost exclusively employed.

Such an opinion must be qualified by observing that, under the fostering influence of the national and municipal governments, the mutual plan has reached an important development in Austria-Hungary, Germany, Switzerland and Sweden. In all these countries, indeed, corporate enterprise on a large scale, in every branch of business, is of comparatively late growth, and mutual fire insurance was a familiar practice long before joint-stock companies entered upon this field of activity. The tendency in the large cities and commercial centres is to throw new insurances into the business corporations, while the time-honoured mutual associations retain their standard character and customary clientele. But in these countries the mutual plan has an established place in the confidence of the rural population, who are generally strongly prejudiced against moneyed corporations. This is especially true of the cantons in Switzerland and certain districts in Austria-Hungary, where fire insurance is administered by the local governments in connexion with a minute police supervision of the construction of buildings and of other conditions of the risk. From the published returns of the various companies and the authorities as collected for the *Post Magazine Almanack* (1909), it would appear that of all the fire insurance premiums paid in Switzerland nearly 54% is collected by the mutual associations and the cantonal authorities; while in Italy 37%, in Germany 27%, in Sweden 27% and in the Austro-Hungarian monarchy 20% go to mutual companies.

The earliest plan of insurance which was successful as a business was that practised at Lloyd's Coffee-house (see *LOYD'S*) in London, and there applied almost exclusively to marine risks. Although the association known as Lloyd's has been for generations a strong financial institution, with very modern safeguard, and since 1871 has been a chartered corporation with large funds, yet its name has become accepted as the symbol of the primitive practice of combined underwriting by individuals, each upon his own credit, for a share of the risk and without common liability.

A few associations on this general principle were known to exist in America, and to issue fire policies on a small scale, before 1892, but chiefly for mutual insurance. In that year, in a general revision of the insurance law of New York, such associations already in existence were expressly exempted from all its provisions. Speculators at once discerned an opportunity. If a company by omitting to take corporate form could carry on the business free from all restrictions and burden of state supervision, it would compete at great advantage with the insurance corporations. While the new law was in prospect there was time to take action; and upon its passage there suddenly appeared a multitude of "organizations" claiming the exemption as Lloyd's, or associations of individual underwriters, and offering fire policies at rates materially lower than those of the joint-stock companies. Each of these was represented and managed by an attorney for the subscribers, supposed to have power to bind them severally to the amount of their subscriptions. The standard policy prescribed by law in New York was issued, with a clause making the liability several only, and fixing the amount. The Lloyd's entered the market with the zeal and prestige of a new idea and a great name, and they grew rapidly in number and in business, but made no profits. Extending their agency into other states, they occasioned much litigation concerning their legal existence and rights and some rash and inharmonious legislation. But several attempts to establish similar Lloyd's in other places failed. Experience soon showed that it was impossible to enforce claims in the courts, when the liability

was distributed among many, without excessive expense and delay, even when all the subscribers were solvent, while a few good names, however useful in canvassing, were no guarantee of the responsibility of unknown associates. In 1896 the executive and legal authorities of New York assumed a hostile attitude towards speculative schemes of this class, and indictments were found against a number of promoters for falsely antedating constituent agreements. The bubble burst suddenly, and within three years more than one hundred of the Lloyd's disappeared. A few reinsured their risks or were merged in permanent companies, but the mass of them proved to have no substance. Four or five only of the best Lloyd's continue to issue fire policies within a narrow and special circle, but as a group they no longer compete for general business.

The rate of premium varies with the supposed risk, but certain descriptions of property are specially and more elaborately rated. This has been done to a considerable extent by common agreement amongst the offices, and the arrangements are known as the "tariff system," which requires here a few words of explanation.

We may suppose the question to arise, What ought to be paid for insuring a cotton-mill, or a flax or woollen mill, or a weaving factory, or a wharf or warehouse in some large city? The experience of any one office scarcely affords adequate data, and a rate based on the combined experience of many offices has a greater chance of being at once safe and fair. The problem, indeed, is a more complicated one than what has been already said would indicate. The property to be insured may consist of several distinct buildings and the contents of them: one building may be devoted to operations involving in a high degree the risk of fire; in another the processes carried on may be more simple and safe; a third may be used only for the storage of materials having little tendency to burn. Fairly to measure these various hazards it has been found necessary that the experience and skill at the command of many companies shall be combined, and that the rates shall be the result of consultation and a common understanding.

Now it is clear that no office will contribute its skill and experience to such a common stock if the effect is to be that other offices may avail themselves of the information in order to undersell it. Consultation about rates and a common understanding necessarily involve a reciprocal obligation to charge not less than the rates thus agreed on; in other words, a tariff of rates is developed to which each office binds itself to adhere. The system tends to restrain and moderate the competition for business which inevitably and to some extent properly exists among the companies, and its value to them is manifest. But it is also of service to the insuring public. At first sight it might seem that free competition would suit the public best, and that a combination among the offices must tend to keep up rates, and to secure for the companies excessive profits, but a little consideration will show that this is a mistake.

It is an unquestionable truth, though one often lost sight of, that all losses by fire must ultimately be borne by the public. The insurance companies are the machinery for distributing these losses, nothing more. If the losses fell on them, their funds, large as they are, would speedily be exhausted, and the service which they render to the public would come to an end. To those who require insurance against loss by fire it must be a manifest advantage that they should have many sound and prosperous offices ready to accept their business, and no less able than desirous to earn or to retain the public favour by fair and liberal conduct. A necessary condition of this state of things is that the rates of premium paid for insurance should be remunerative to the offices, and the main object of the tariff system is to secure such remunerative rates.

This it endeavours to do by two methods—by an agreement as to what rates are to be charged, and by affixing such a penalty to dangerous constructions, substances and processes as to induce, if possible, a lessening of the danger. In other words, and reversing the order, it seeks to diminish the risk of fire, and to secure adequate payment for what risk remains. On the supposition that the offices are correct in their estimate or risks, the effect, and indeed the intention, of their rule is not so much to put money into their own coffers as to lessen the danger, and

to save themselves in the first instance, and the owners of property ultimately, from the consequences of preventible fires.

These rules, as will readily be seen, must have powerful influences on trade and manufactures. Many individual warehouses and mills are, with their contents, insured for very large sums, £10,000, £20,000, £50,000, £100,000 and more. An additional charge of 5s. or 10s. % in respect of a supposed increase of risk may mean a payment by the owner of several hundred pounds a year, and may operate as a complete veto on some arrangement or some machine which it might otherwise be desirable to resort to. The occurrence of a few severe fires in one town, followed by an increase of insurance rates, may have, and indeed has had, the effect of driving some branch of trade to another locality, the seat of greater caution or better fortune. It is therefore obviously desirable that so important an influence should be exercised, not precariously or capriciously, but according to the combined wisdom and experience of those associations which may be supposed to understand the subject best, and which obtain their experience in the way that makes it perhaps of most value, by paying for it.

It is equally for the public benefit that rates of insurance should be fixed on some common scale. Suppose the system of unrestricted competition to be tried, the first effect will be a general and great reduction in rates. But it may be said, "So much the better for the insured; if the offices can afford this reduction of rate, it will only be a fair result of competition; if they cannot afford it, they will be the losers, but the public will gain; will the effect not be simply to reduce the rates of the paying point and no further?" This would be all very well if the paying point could be absolutely ascertained or determined in any way beforehand, but the rate comes first and the losses come afterwards. In other businesses prices are based on some certainty as to the cost of production, but in selling fire insurance the cost is not known till after it has been sold. In a free competition it is the sanguine man's views which regulate the market price, and the rates therefore cease to be remunerative. The consequences are that some offices disappear altogether, others take fright in time to avoid ruin, though not to escape serious loss, persons who might establish new offices are manifestly deterred, so the business gets the character of being a highly speculative and hazardous one, requiring extravagant profits to induce men to carry it on at all, and the public have to bear the cost. Unrestricted competition therefore is not for their advantage.

The combination for uniform rates has another beneficial effect; it serves to distribute the burden of losses fairly. If it is a just thing that cotton-spinners should bear all the losses that arise in cotton-mills, and not leave them to be borne by the owners of private dwelling-houses, or vice versa, it is still better that the loss by each class of risks should be borne by the same class. But, while the rate of any one office, taken by itself, furnishes a very imperfect criterion, each contributes its quota of knowledge and experience to the common stock, and the public get the benefit both of broad and trustworthy data and of that peculiar and intimate acquaintance with each different class of property or process which the conductors of one company or another are sure to possess.

No conventional or excessive rates can, however, be maintained for any length of time. Some member of the union is sure to perceive that popularity and profit may be gained by introducing a lower rate, if a lower rate is manifestly sufficient, or a new company starts into existence to remedy the grievance. It is to be remembered, too, that the directors and shareholders who control the offices are likewise insurers, quick to raise the question of how far the rates they have to pay as individuals are justified by the risks run; and if it cannot be shown that these rates are a true measure of the risk, offices are soon constrained by a sense of justice or by self-interest or by pressure from without to mitigate them. In short, the association is a union bound together by necessity and tempered by competition.

Adequately to measure the risk of loss by fire demands not merely reference to an extended experience but a watchful regard to current changes. While the profits of fire insurance business fluctuate considerably from year to year, and seem even to follow cycles of elevation and depression, the tendency on the whole appears to be towards a growth of risk, although excessive competition among offices prevents the rates from rising in proportion.

The *Tariff* system has steadily developed in minuteness of classification and in adaptation to wider experience, as well as to the changes in the character of many classes of risks by improvements in building and by the introduction of new kinds of goods and machinery. The estimates of risk and the determination of premiums are largely governed by individual opinion and by competition, no amount of experience furnishing a statistical basis on which trustworthy predictions of average loss can be made. Hence it is only by constant co-operation among insuring institutions in the exchange and combination of their observations that justice can be done to them and to the public. The proper extent of this co-operation is easily attained where the business is free

from all restrictions except those of the common law, as in Great Britain, and the competition of capital for profits is keen enough to keep the rates within reasonable limits. But in countries in which the government regulates the business in a more paternal spirit, and meddles with all its details for the avowed purpose of securing the safest and best public service, many difficulties arise. This is increasingly the case in several of the nations of Europe, notably in Austria, Switzerland and Germany.

But it is in the several states of the United States that the government supervision of insurance has most interfered with and modified the natural development of the business. In recent years, beginning with 1885, sixteen of these states have enacted legislation, dictated by the growing jealousy of corporate powers and privileges, forbidding fire insurance companies or their agents to combine in any form for the determination of rates. Companies have often been indicted, fined and deprived of authority to issue policies because of membership in associations for the purely scientific purpose of ascertaining their average experience. The courts have frequently narrowed in their interpretations the sweeping intent of such laws, but have generally sustained them as within the power of the legislature, and at the present time there is an overwhelming public sentiment in large sections of the country arrayed against every semblance of union or consultation among the companies upon the basis of their business. In several instances all the important insurance companies have withdrawn their agencies at once from particular states, and the business community has been sorely distressed for want of their protection. But the popular prejudice has not yielded to its demand, and the companies have never been able to maintain their own position with unanimity, the temptation to secure a vast business upon any terms being always too strong for some of them to resist. This form of legislation has beyond dispute increased the cost of insurance to the people, while it has embarrassed and disturbed the regular work of the companies.

Another pernicious tendency of popular legislation in the United States is found in the *Valued Policy Laws*, the first of which was adopted by Wisconsin in 1874, providing that when any insured building is wholly destroyed by fire the amount of the policy shall be conclusively taken as the amount of the loss. This principle, with various modifications and extensions, has become law in some twenty states of the Union, though in many of them its enactment has been vigorously resisted by the executive government; several governors have vetoed such bills, while most of the supervising officers have had the intelligence to disapprove them. The provision is regarded by all insurance authorities as highly dangerous, inviting over-insurance and incendiarism, and there is no doubt that it has this tendency in many instances. But the statistics available, while showing that in general the rate of loss has increased where such laws are in force, do not demonstrate any such wide and ruinous stimulation of fraudulent practices as has been apprehended by thoughtful critics. The actual result is commonly to throw upon the insurer the responsibility for providing in advance against over-insurance by minute surveys and, in special cases, for continual watchfulness against depreciation. Like all other interference of government with private contract, however, it has a marked effect in increasing the difficulty and expense of business transactions.

The direction in which fire insurance as a social institution calls most pressing for improvement is the extension of the principle of co-insurance. The importance of this *Need of co-insurance* can only be understood by remembering that the aggregate losses of the community by fire are chiefly made up of innumerable small fires and not of sweeping conflagrations. The experience of every company, confirms the general truth, that the number of fires in which a building is totally destroyed, or in which the loss amounts to the greater part of the property exposed under the same risk, is comparatively very small. It may be asserted with confidence that, in the grand aggregate of the business, much more than three-fourths of the loss occurs in fires in which less than one-tenth of the insurable value at risk is destroyed. The practical result is obvious. If fires destroy a million of dollars' worth in property insured for its full value, and a million's worth more in property insured for one-tenth of its value, the insurers will pay \$1,000,000 upon the first group and more than \$750,000 upon the second. But if all the insurance is taken at the same rate the insurers will have received premiums ten times as great on the former group as upon the latter. This rough illustration shows that in an equitable adjustment of rates the amount insured as compared with the value exposed is a prime element, and that premiums might justly form a scale, highest on the smallest fractions of

value, and diminishing rapidly as the percentage of insurance increases. Such a scale is, however, impracticable for many reasons, apart from the endless complications which, even if it could be constructed, it would introduce into the classification of risks. Any scientific plan of insurance, therefore, must provide another method for maintaining the proportion between amounts of premiums paid and the share in its benefits obtained for them. This is the purpose of what are generally called *average or co-insurance clauses*. The principle is, that when a proper rate for a class of risks is found, then the insured may protect at that rate any percentage of such a risk, and in case of fire shall be indemnified for the same percentage of his loss. When once clearly grasped, this principle largely simplifies and rectifies the business. It is in universal use in marine insurance under the name of "average," and is there recognized as indispensable. It is embodied in all fire policies in France, Germany and several other countries of Europe, and in 1826 was made compulsory in Great Britain by law in all "floating policies," those, that is, which cover stocks of goods distributed in several places and in fluctuating amounts. But it has not yet become general in Great Britain or America, although every writer of authority on the subject, and every practical underwriter of large experience, approves it. Systematic attempts have been made since about 1802 to extend its application in the United States with much success, but they have been met by strong opposition, which shows a widespread misunderstanding of its true bearing.

The co-insurance clause, indeed, which has been generally approved by the American associations of underwriters, and applied in the great commercial cities, is less sweeping than the parallel agreements used in France and Germany. The latter regard the insured owner as self-insurer for the entire value at risk not covered by the policy, and grant indemnity only for that fraction of the loss which the amount insured bears to the whole amount exposed. The American clause is less logical, commonly providing that: "If at the time of fire the whole amount of insurance on the property covered by this policy shall be less than 80% of the actual cash value thereof, this company shall . . . be liable only for such portion of such loss or damage as the amount insured by this policy shall bear to the said 80% of the actual cash value of such property." But this limitation of the basis of co-insurance average to 80% of the total value is in perfect harmony with the conservative policy which seeks in all cases to prevent over-insurance. The most serious danger to which the entire system is open is that a fire may promise profit to the insured. To avoid this, it is a small enough margin to exclude from protection by the policy one-fifth of the estimated value, and to require the owner to assume that proportion of the risk. It is therefore reasonable not to require in any case a larger share than four-fifths to be covered, and not to press the co-insurance principle so far as to offer a differential advantage to those who insure above this limit. Thus, for practical purposes, and in the general mass of businesses, the 80% clause may be accepted as approximately the best application of the principle. It makes possible substantial equity in distributing the cost, while it does not interfere with proper safeguards against over-insurance. The cordial support of the mercantile community in the great cities, and of the most intelligent state officers, has been given to it.

A popular outcry has, however, arisen against all forms of co-insurance, on the superficial and mistaken assumption that in every case the principal sum named in the policy measures the amount of loss paid for the premium; and that any limitation upon it must be a wrong to the insured, for the emolument of the insurance corporation. No less than ten states have passed laws prohibiting the clause within their jurisdiction, though Maine in 1895, after a trial of two years, repealed the prohibition. The law of Tennessee, a typical form, is as follows: "Insurance companies shall pay their policyholders the full amount of loss sustained upon property insured by them, provided said amount of loss does not exceed the amount of insurance expressed in the policy, and all stipulations in such policies to the contrary are and shall be null and void" (except in case of insurance upon cotton in bales). In several states the use of the co-insurance clause is made a penal offence. It is an interesting fact, however, that while this principle, whenever it has been generally applied, has led not only to a fairer equalization of premium rates, but, on the whole, to a marked reduction of them, the laws in question have deprived the people adopting them of the resulting benefit. In the year 1899 the average premium rate upon all fire risks written in the states in which co-insurance was wholly or partly prohibited was something more than \$1.20 per \$1000, while in the rest of the country, where the clause was permitted and to a large extent used, the rate was but 66 cents per \$1000. The marked difference, which tends to increase, is a perpetual object-lesson which must in the end appeal strongly to the popular intelligence.

The varying attitude of several civilized governments towards the institution of insurance has found significant expression in their tax laws. In Great Britain a stamp duty of 6d. was imposed in 1694 upon "every piece of vellum or parchment or sheet of paper upon which any policy of insurance should be engrossed or written," and was doubled in 1698. It was further increased (reaching 3s. 10d. per policy in 1713) and varied by many subsequent acts, under some of which the percentage duty on fire insurance was also made payable by stamps upon policies. But in 1865 the stamp tax was finally reduced to the nominal sum of 1d. upon each policy. A far heavier burden, however, was imposed upon insurers by the measure of Lord North in 1782, charging all fire insurances in force with an annual duty of 1s. 6d. for every £100 insured. In 1815 the general rate was made 3s. per £100, but was collected once for all upon the policy when issued; and it so remained until reductions began in 1864. The duty was wholly abolished in 1866. The revenue from this source reached its highest point in 1863, when it was £1,714,622, presumably representing insurances effected in that year to the amount of £1,143,081,333. There are no data for determining the amount of premium receipts or of losses realized on the same volume of insurance; but the tax was recognized by economists as well as by all parties to the policy contracts as an excessive burden. In many instances it more than doubled the cost of insurance. Its effect in discouraging the prudent custom of insuring against fire was very serious, and after its abolition this custom extended so rapidly that it soon became, and continues, practically universal in Great Britain. Upon the continent of Europe fire insurance is generally taxed quite heavily; most so in France, where the direct duties on the premiums, together with the registry and stamp taxes paid by the companies, have been estimated to add one-fourth, or perhaps one-third, to the cost of insurance.

In the United States the companies are taxed, each by the state in which it is domiciled, upon their real estate, and often upon their capital, surplus or profits, and are required in other states to pay fees to the insurance departments, and commonly an excise of from 1 to 2½% of their premiums. An elaborate table is prepared each year by a committee of the National Board of Fire Underwriters, showing the aggregate amount of taxes paid by the companies operating in New York in comparison with their receipts and profits. The statement received and published by the board in 1900 contained the following:—

	For the Year 1899.	For Twelve Years 1888-1899.
Premiums (fire and marine) . . . . .	\$134,450,639	\$1,425,920,631
Losses paid (fire and marine) . . . . .	91,031,677	856,978,494
Expenses . . . . .	52,849,129	517,667,238
Increase of liability (un-earned premiums, &c.) . . . . .	8,998,526	59,104,388
Net loss in the last year . . . . .	18,428,693	
Net profit in twelve years . . . . .		7,820,489
Amount of taxes paid . . . . .	4,495,332	35,984,081
Taxes were of premiums . . . . .	3.34%	2.52%
Taxes were of premiums, less losses . . . . .	10.35%	6.32%

In qualification of this statement, it may be said that the reported expenses appear to include taxes, and that the additions charged to liability are to some extent theoretical and flexible. It also appears from the state reports that upon the entire capital and net surplus of \$191,000,000 employed in the business in the United States by 316 joint-stock companies, dividends to the amount of \$8,000,000, or 4.2%, were paid in 1899 to shareholders. Nevertheless it is true that competition among the companies, together with unfriendly legislation, has reduced the profit upon their aggregate capital near the vanishing point, and that the taxes, the average rate of which increased 50% within the period 1891-1899, are heavier in many states than can be justified by public policy or by the analogy of other corporate interests. The true principle, doubtless, is that while the capital employed

in insurance for gain ought to contribute to the state the same share of its profits as other capital, yet the premiums, agencies, policies and entire machinery representing only losses, and providing for their distribution, should be exempted, as far as the necessities of the public treasury permit.

One aspect of the taxation of fire insurance is of especial interest, namely, the very general disposition of legislatures and municipal authorities to impose upon the underwriters the cost of fire departments. The systematic prevention and extinguishment of fires are everywhere assumed to be proper work for the community at large. But the first license granted by the crown to issue insurance policies in London in 1687 was conditioned upon regular contributions by the authorities to support the king's gunners as a fire brigade, and in the public mind the privilege of insuring the prudent has ever since been vaguely associated with the duty of guarding the property of the whole community. The voluntary support of fire patrols by the companies in London, New York and other cities has done much to promote this view; and a substantial part of the taxes paid upon fire policies in the United States is levied for the support of fire departments, for the pay and pensions of firemen and for similar purposes. The tendency to increase such taxes, under the pretext that the protection afforded is for the special benefit of the companies, is strong in some of the states; though it would be equally rational to compel life insurance companies to maintain general hospitals for the sick.

The most complete statistics of the fire insurance business collected in any country are those of the *United States* to the National Board of Fire Underwriters at each annual meeting. The following summary of part of the information submitted by the committee on statistics, 10th May 1900, giving the amount of fire risks insured in the United States, premiums received for them, and losses paid upon them, by all joint-stock fire insurance companies for the year 1899 will serve as an example:—

*Fire Insurance in the United States. Joint-Stock Companies.*

Companies.	Fire Risks assumed.	Fire Premiums received.	Fire Losses paid.	Premiums per \$100 of Risk.	Loss per \$100 of Risk.	Loss per \$100 of Premiums.
	\$	\$	\$	\$	\$	\$
American . . . . . 218	12,251,299,499	93,577,169	59,119,018	.7638	.4826	.6318
Foreign . . . . . 35	6,087,570,275	42,958,472	29,865,014	.7057	.4906	.6975
All . . . . . 253	18,338,869,774	136,535,641	88,984,032	.7445	.4852	.6517

These returns do not include mutual companies. The compilers of the *Insurance Year-Book*, however, obtain from the several state departments of insurance the reports of all companies made to them of the business done within each state; and from these it appears that in 1899, for example, 160 mutual companies assumed fire risks to the amount of \$1,119,772,848. Many small local associations have made no returns, but their operations are too limited to materially affect the aggregate. It is noteworthy that while mutual companies transact less than 6% of the business of the whole country, yet in the state of Rhode Island, a densely peopled manufacturing community, they have more than 78%, and in Massachusetts nearly 24%; and that, while less than one-ninth of the insured property of the United States is situated in these two states, they contain nearly two-thirds of that which is insured by mutual associations.

The fire insurance business of foreign companies in the United States was comparatively small until 1870. Four strong British corporations were then in the field, and their transactions amounted to less than 9% of the entire joint-stock business. But their success attracted others in rapid succession, especially from Great Britain and from Germany, and in 1880, 10 foreign companies assumed 23.7% of all the risks reported to the National Board; in 1889, 23 such companies took 30.3%; and in 1899, 35 such companies took 33.2%. The distribution of the business among them is not given by the board tables, but can be gathered from the reports of the American branches to the insurance departments of the states, which are summarized in the Spector Company's Year-Books. The total net payments of the British and colonial fire insurance companies in connexion with the disastrous fire in San Francisco in 1906 amounted

to over ten million pounds, and the prompt settlement of all claims strengthened considerably their position in the United States.

In the *United Kingdom* the statistics of fire insurance are less accessible and less complete, no official records being made of the local distribution of the property insured, while the published accounts of the companies are not sufficiently uniform and detailed to make a trustworthy summary of the entire business possible. Much of it is done by foreign companies, of whose British business we have no separate statement. A statement of the revenue accounts of the various British companies insuring against fire will be found in the annual *Insurance Blue Book and Guide*.

In the *Dominion of Canada* the insurance companies make detailed reports to the government bureau, and the statistics of the business are full and accurate. The following table shows the aggregate business of five companies in the Dominion in 1869 and 1907:—

Companies.	Net Cash Premiums received.	Amount of Policies taken.	Amount at Risk in 1869.	Amount at Risk in 1907.	Losses paid.
	\$	\$	\$	\$	\$
Canadian Companies.	54,849,706	5,663,696,931	59,340,016	412,019,532	36,073,543
British Companies	159,372,986	14,745,342,255	115,222,000	937,240,828	15,203,259
American Companies.	32,449,482	2,801,078,045	13,796,890	265,401,198	20,129,339
All Companies . . . . .	246,672,174	23,210,117,231	188,359,809	1,614,561,558	161,406,125

Upon the *continent of Europe* the fire insurance business is conducted partly by local companies in each country and partly by the great international offices of Great Britain and Germany. The local associations in Austria, Germany and Switzerland are of three classes—public assurance organizations connected with local governments, private mutual companies and joint-stock companies. It is impossible to obtain balance-sheets of all, nor is any information available concerning the local distribution of the risks, or the whole amount of property insured.

The capital employed by stock corporations in this business in each country, and the aggregate premium receipts and payments for losses in the last year of which a report is available will be found in the annual *Post Magazine Almanack*.

While most of the fire insurance business in the *Australian colonies* is in the hands of British companies, local institutions for the purpose have had a considerable development on the same general lines as in Great Britain and with similar freedom from interference by the governments. But no accounts of the receipts and losses are available, most of the companies conducting a marine or life insurance business, or both, under the same general management.

Beyond the limits of the great commercial nations, no satisfactory information is accessible concerning the practice of fire insurance. Even in Spain and Portugal there is far less intelligent interest in the subject than in neighbouring countries, and the agencies of foreign companies transact much of the business in the large towns. Six Portuguese companies have maintained themselves for many years, a few of them for nearly a century, and have established agencies in the Spanish islands and in Madeira. For other nations than those mentioned, the only systematic effort to collect the facts is made by the compilers of the *Year-Book*, and the results are extremely meagre. The great British and German corporations are zealous in extending their transactions to the commercial ports everywhere, and local companies are often formed in the British colonies. In addition to those in Canada and Australia some companies in South Africa have become financially important. Small native companies have been successful in establishing their credit in Japan, Brazil, the Argentine Republic, Chile and Peru. A considerable business is done in insuring the property of foreign residents in the Levant, on the coasts of Asia, in South Africa and the Pacific Islands, but mostly by European companies, and as an incident to the more general practice of marine insurance. There are several successful fire companies among the Dutch in Java. The small business in Mexico appears to be wholly in the hands of foreign companies.



## IV. LIFE INSURANCE

Guesses at the probable length of life for the purpose of valuing or commuting life-estates, leases or annuities were made even by the ancients, and crude estimates of the number of years' purchase such interests are worth occur in Roman law and in many medieval writings. In 1540 the English parliament enacted that an estate for a single life should be valued as a lease of seven years, one for two lives as a lease of fourteen years, and for three lives as a lease of twenty-one years. More than a century later *The Cambridge Tables for renewing of Leases and purchasing Liens*, a standard work in England, with the certificate of Sir Isaac Newton to its accuracy, proposed, as a remedy for the inequity of this fanciful rule, to make the increase for each additional life less by one year, so that, valuing a single life at ten years, two lives shall be reckoned as nineteen years and three lives as twenty-seven years. No distinction of ages was recognized, and the results, tabulated to decimal parts of months, are worthless. Thus the foremost minds of the world had as yet no apprehension of a true method of reasoning on the subject. The first clear insight into the character of the problem appears in *Natural and Political Observations on the Bills of Mortality*, published in 1661 under the name of John Graunt, a haberdasher and train-band captain of London. Graunt recognized the principle of uniformity in large groups of vital and social facts, and actually prepared, from the mortality registers of London, what he calls a "Table showing of one hundred quick conceptions, how many die within six years, how many the next decade, and so for every decade till 76." This was the earliest crude suggestion of a table of mortality, and Graunt's interest in the inquiry was scientific, without definite practical purpose. But a little later the sale of annuities was pressed upon governments as a method of discounting future revenues. In 1671 John de Witt, grand pensionary of Holland, reported to the states general a plan for such sales upon a scientific method, the insight and skill of which, had he possessed proper statistical data, would have anticipated results only reached by later generations. The report, however, was buried in the Dutch archives and forgotten for nearly two centuries. It was unknown in England when, in 1692, the government undertook the sale of annuities. A loan of £1,000,000 was offered, each £100 paid in to purchase a life annuity of £14, without distinction of age. A table accompanied the offer, purporting to show how many of 10,000 persons now living, old and young taken together at random, are likely to die in each year from one to ninety-nine. The purchasers, though without clear understanding of the principle, were instinctively shrewd enough to select healthy young lives for annuitants, and the nation paid enormously for the error. This speculation of the public treasury led the eminent mathematician and astronomer, Dr Edmund Halley, to examine the subject. In 1693 he presented to the Royal Society a study of "The degrees of mortality of mankind." The parish registers of England took no note of age at death, and Halley, perceiving that the average duration of life in large groups of persons can only be determined when ages at death are known, sought in vain a statistical basis for such an inquiry in his own and in many other countries. But it happened that the city of Breslau in Silesia had kept such records, and he succeeded in obtaining the registers for five years, 1687-1691, including 6193 births and 5869 deaths. No census of the city having been taken, Halley made the best estimate he could of the population, and computed how many of a thousand children taken at the age of one year will die in each succeeding year. Arranging the results in three parallel columns, showing in successive lines the age, the number living at that age, and the number of deaths during the year, he formed the first mortality table. The arrangement was itself a discovery, exhibiting at a glance the essential data for valuing life-risks, and suggesting solutions for problems which had puzzled the ablest students. This general form of the mortality table remains in use as the natural and best for such collections of facts. The method of using such

a table in calculating the values of life contingencies was also discovered by Dr Halley. He showed that where a payment is to be made at a future date, if a named person be then alive, its present value is the sum which compounded at interest during the interval will amount to that payment multiplied by the fraction representing the probability that the person will survive. These two elements, compound interest and the probability of life or death, are the foundations of the theory of life contingencies.

From Halley's time the progress of the theory has been in three directions: first, in accumulating facts from which averages are deduced, and analysing the data so as to eliminate disturbing influences, that is, in constructing trustworthy tables of mortality; secondly, in extending the inferences from such tables, and multiplying their applications to needs of practical life; and thirdly, in facilitating the calculations which these applications require. But while Halley thus firmly and lastingly drew, in outline, the theory of life contingencies, the numerical results attained by him were grossly imperfect. Forced by the lack of data to assume that the population was stationary, and to rely on a rude estimate of its numbers, he well knew that his conclusions were but provisional. Yet they were far in advance of the general mind of his time. As late as 1694, and even in 1703, parliament substantially re-enacted the old law for valuing leases at seven years for each life. The meagre Breslau Table long remained the only serious attempt to utilize actual observations of mortality for scientific purposes. In 1746 A. de Parcieux (1703-1768), a mathematician of Paris, published an *Essai sur les probabilités de la durée de la vie humaine*, in which he presented mortality tables formed by himself, one from the records of certain Tontine associations, and five others from those of several religious orders in Paris. The Tontine experience table was a much closer approximation to the true course of mortality, as shown by later investigations, than any of its predecessors, and indeed now appears, despite the crude manner in which the materials were treated, to have been more accurate and more trustworthy than the Northampton or even the Carlisle Table of much later date. The essay of de Parcieux was an important source of information to advanced students in France and Germany, but attracted no general or popular interest, nor was it followed up by progressive researches of the same character in continental Europe, while it remained almost unnoticed in England.

Throughout the 18th century the customary treatment of life annuities was as chaotic and fanciful as before, though some writers of eminence, most notably Dr Thomas Simpson of London (1752), treated the theory of the subject with great intelligence, and in 1753 James Dodson of London (great-grandfather of Augustus de Morgan) projected a life insurance company in which the premiums should be accommodated justly to the ages of the insured. But life insurance as a business really began with the Equitable Society of London, founded in 1762. The associates petitioned for a charter, but the law officers of the crown refused it, saying that the scheme depended for success on the truth of certain tables of life and death, "Whereby the Chance of Mortality is attempted to be reduced to a certain standard. This is a mere speculation, never tried in practice." The society was organized as a voluntary association, and began business in 1765. Its premiums were computed from the Breslau Table, with some corrections from the London Bills of Mortality, and were far higher than any now in use. But the managers, in face of actual business, needed more light. Dr Richard Price, a student of the new science of life contingencies, was consulted, and soon devised tests of the society's experience and measures of the financial results, which are in principle those still practised. He also aspired to construct a more accurate table of mortality, and discovered data in certain parish registers of Northampton which promised to represent the average of life in England. From these he formed in 1780 the Northampton Table of Mortality, and computed a new and largely reduced scale of premiums for the society. The historical importance of the Northampton Table lies in the profound impression it made on the general mass of intelligent persons.

Halley's  
Table.

Northampton  
Table.

Although mortality had long been recognized by special inquirers as a promising theme for statistical inquiry, its actual treatment, except in the narrow school founded by Johann Süssmilch in Germany (1746), and in the isolated and almost prophetic work of de Parcieux in France, had been speculative and vague. Demivre handled it with mathematical acuteness, but framed his scale of mortality (about 1750) on a hypothesis of his own, not on known facts. Out of each group of eighty-six deaths, according to this scale, one dies on the average each year till all are gone; so that  $x$  being the present age, the probability of death within a year is always  $1/(86-x)$ . This conjecture, which, during middle life, served as a rough approximation to the truth, almost as well as some of the early tables of repute, long found remarkable acceptance among men of science. Dr Price's researches first brought to general apprehension the conviction that a large basis of observed facts is the only source of real knowledge. The government of the day felt the influence of the movement. In 1786 Pitt, then chancellor of the exchequer, consulted Dr Price on plans for the conversion of debt, and in 1789 the government first showed knowledge that in granting annuities ages must be distinguished, and that the prospective life at ninety and that at twenty-five are not to be estimated as equal. About 1808 a conversion of 3% into annuities was planned. The Northampton Table was adopted, and Morgan computed rates from it which were used for twenty years. It proved to represent a mortality far in excess of the average, and in 1821 John Finlaison, being made actuary to the debt commissioners, protested against the rates in use. But not until 1828, when the treasury had lost two millions of pounds by selling annuities too cheap, was the law repealed. Finlaison then constructed a new and less wasteful scale for conversions, but singular results followed. At the age of ninety, for instance, £100 would purchase an annuity of £62. Combinations were formed to purchase annuities on the lives of old people selected for their vigour; 675 of these were taken, with a further loss of at least a million to the treasury. The Northampton Table, in fact, like the earlier Breslau Table, was formed without a census, and upon the false assumption that the population was stationary. Dr Price's estimate, founded on the recorded baptisms, was much too low, many of the people being of a sect which rejected infant baptism. His table represents an average life of twenty-four years, whilst subsequent inquiries indicate a true average of about thirty years at that time in the same parishes. The actual mortality in the Equitable Society proved to be less by one-third than that anticipated by the table. The error had consequences of vast moment. The immediate and dazzling prosperity of the societies founding rates on this supposed scientific basis excited the public imagination, stimulated the business exceedingly, and led to many extravagant projects, followed by fluctuations and failures which impaired its healthy growth and usefulness.

In spite of gross defects, the Northampton Table remained for a century by far the most important table of mortality,

**Recent actuarial progress.**

employed as the basis of calculation by leading companies in Great Britain, and adopted by the courts as practically a part of the common law. Parliament, followed by some state legislatures and many courts in America, even made it the authorized standard for valuing annuity charges and reversionary interests. But in life insurance practice it is now wholly antiquated. Like its most famous successor, the Carlisle Table of Joshua Milne, it rested upon observations of the population of a town. How far this limited and peculiar group represented the nation was still doubtful; no less so how far the rate of mortality among applicants for insurance, accepted by the offices, would correspond with that of the urban citizens or of the whole body. As soon as the companies had sufficient records of their own experience the work began of striving to construct, for business use, tables which should truly express it. This branch of research has ever since been prosecuted with all the resources they could command of industry, practical judgment and mathematical skill; and the successive achievements in it may be accepted as in general

the sum and measure of the progress of actuarial science. Now the recognition of an ascertainable uniformity in human mortality has become part of the general stock of thought. But actuarial science, which originated in Great Britain, was long the peculiar and almost exclusive possession of British students, and even till now has been practised most fruitfully in its first home, mainly by the actuaries of life insurance institutions, but with important contributions from other inquirers, especially those in the service of the registrar-general. The most complete storehouse of technical and practical learning on the general theory and on all its applications to life insurance practice is found in the successive volumes of the *Journal of the Institute of Actuaries*. The tables published by the Institute in 1872, founded on the experience to 1863 of twenty companies (see ANNUITY), still remain the most authoritative expression of the mortality of insured lives, and have largely replaced all earlier standards in the valuations of the British companies, more than three-fourths of which, in their latest returns to the Board of Trade, compute their reinsurance reserves by the  $H^m$ - and  $H^{m+1}$  tables. But for several years a committee of the Institute and of the Scottish Faculty of Actuaries has been engaged in collecting and arranging for investigation the far vaster experience which has now accumulated in the hands of sixty companies, including the records of more than a million policies. The large basis of facts thus obtained will be treated with special reference to different classes of risks, and will throw much light on difficult questions of selection, which have hitherto been treated speculatively, or at least without the conclusive evidence of large averages, and are still more or less in controversy. Some of these will require more detailed notice hereafter.

It is only since the middle of the 19th century that actuarial science has rapidly advanced in other countries, chiefly under the stimulus of the extending practice of life insurance. Both in America and in the continent of Europe the small businesses transacted by the pioneer companies was largely conducted on empirical and conjectural methods from year to year, English custom being consulted as a guide in fixing premiums. The Gotha Bank, the first institution to insure lives upon business principles in Germany, adopted at its foundation in 1827 a mortality table formed by Charles Babbage upon the basis of the Northampton Table, corrected from cursory notes upon the early experience of the Equitable Society, which had been given by its actuary to a general meeting of its members in 1800. The French companies, and several in Germany of later origin than the Gotha, took as their standard the so-called Table de Parcieux, previously described; and this table, with modifications dictated by experience, continued until very recently in general use in France. The Seventeen Companies' Table of 1843 was adopted by the Insurance Commissioners of Massachusetts, who in 1859 introduced the methods of state supervision of insurance now generally practised in the United States. This table, though long superseded in the esteem of actuaries in their ordinary work, is still the standard for official valuations in most states of the union, a fact which has given it undue prominence. The so-called American Table, derived in 1868 from the limited experience of the largest American company during its earliest years, was the first important work of the kind done in America. In view of the narrow basis of facts, it has stood the test of time singularly well, and it is now in wider use than any other for computing the premiums of American companies. Its most marked difference from the standard British tables for insured lives is that it indicates a decidedly lower rate of mortality throughout the period of mature manhood, between the ages of thirty-five and seventy-five, though with a higher rate at the extremes of life; and this peculiarity is also found in American tables deduced from more recent and far larger experience.

Actuarial science has been widely cultivated in the United States of late years, the numbers and zeal of its professional students having kept pace with the extraordinary growth of life insurance. The aggressive activity of the companies has brought the principles of the business home to the popular mind as in no other country; and a large number of periodicals are devoted entirely to the subject. These tendencies have been strengthened by the system of supervision practised by the states, which has also greatly influenced public opinion, directing attention in an extraordinary degree to certain special and technical features, to the neglect of more comprehensive and more useful criticism. In the official work of the state departments the actuary's province appears substantially to begin and end with the valuation of liabilities upon the net premium basis, which is applied with increasing strictness as the sole and final standard of solvency, and the determination by it of the "legal surplus" of each company. But a considerable number of professional actuaries have prosecuted their studies in a scientific spirit, and most of these since 1880 have been associated in the Actuarial

Society of America, which has established a high standard of professional competence in its examinations and transactions. The question how far the rate of mortality among insured lives in America is fairly represented by tables drawn from British experience has attracted much inquiry; and many companies have made important contributions to it from their own records, in several instances in the finished form of carefully graduated tables, each with an individual character, but all with some features which distinguish them as a group. By far the most comprehensive effort to establish a standard table for America is that of a committee of actuaries, for which, in 1881, L. W. Meech published the classified experience of thirty offices to the end of 1874, including most of the large companies in the United States, and embracing more than a million policies. The observations collected in this work have furnished materials for many important investigations, but the finished tables have rarely been applied in practice, being drawn from an aggregation of largely incongruous experiences, the influence of each of which upon the general average is indeterminate.

The business of life insurance upon the continent of Europe has given an extraordinary stimulus to actuarial studies. Before 1883 the German companies computed their premiums and reserves by antiquated life tables. The most approved of these, as illustrating the duration of German life, was that prepared by Brune of Berlin in 1837 from the records for seventy years of an annuity society for widows, which practised careful medical selection of the husbands and least exact mortality registers. In 1883 was published an admirable table founded on the combined experience of twenty-three German companies, which has superseded all other standards for ordinary valuations within the German empire. The French companies generally continued to rely on the tables of de Parcieux, with modifications of their most glaring defects, until a still later date. In 1898 a committee of French actuaries published a new set of tables drawn from the experience of four of the principal offices in France, and these are now accepted as the best basis for life insurance practice by similar companies there. Schools of actuarial science have been opened in both Germany and France, and the professional actuaries of these countries, and of Austria and Belgium, have formed associations for the promotion of their pursuits. Sessions of delegates from the several institutes and societies of actuaries throughout the world meet triennially in general congress in the various capitals. Such sessions do much to broaden and harmonize the scope and aims of the profession.

Elaborate efforts have been made by several governments to employ the machinery of census bureaux for determining the

general rate of mortality, and it has

been the worthy ambition of able actuaries to devise trustworthy methods of utilizing the census returns for this purpose. The British Statistical Office under Dr William Farr and his successors, and, later, the Swiss Federal Bureau of Statistics have accomplished the best work in this direction, and the series of "English Life Tables," founded on successive decennial censuses, interpreted by the registered deaths during the intervals,

are the most useful data now available for the average value of civilized life. But all such general tables are as yet but tentative and provisional. The imperfections of mortuary registries and of census returns are great, and corrections are largely conjectural. Until more complete methods of collecting the facts are practised, the experience of life insurance companies promises to furnish the only mortality tables having claim to authority. It is already becoming evident that the general rate of mortality, and in particular the rate at each age of life, not only differs widely in different communities, but undergoes important changes in successive generations. A multitude of forces are at work in civilized society which must influence the

average duration of life, such as the extension and concentration of many industries, the vast growth of cities, the progress of medical and hygienic science, the increase of wealth, comfort and luxury, the changes in the frequency and destructiveness of war. It is plausibly maintained, on the one hand, that these and other causes have already added some years to the average lifetime of civilized man; and, on the other hand, that their combined effect has been to lessen the sharpness of the struggle for existence, to rescue the weaklings from destruction and enable them to multiply, and so to weaken society at large. The final decision of the question will be found in the gradual modifications of the true table of mortality through successive epochs.

For the purposes of life insurance the future of mortality tables looks to less ambitious problems. The business calls for exact equity in determining the value of all life contingencies, and therefore for the most precise forecast attainable of the dates at which the amounts assured must be paid. Some idea of the historical progress of this inquiry may be gathered from the accompanying table, which epitomizes the general characteristics of a number of typical tables of mortality, showing at ages which are multiples of five years the annual death-rate indicated by each of them. The comparison will be found interesting in many ways, most strikingly, perhaps, as suggesting what is confirmed by a detailed examination of the facts, that insured life on the average in Great Britain is decidedly inferior to that in the United States, but superior to that upon the continent of Europe, and especially in Germany. From a careful investigation of the published experience, Dr McClintock concludes: "It is an ascertained fact that after the first five years of insurance the probability of death," in Great Britain, "is fully one-fifth greater at any given age than the corresponding probability shown by American experience"; while "the average value of assured life in Germany is as much inferior to that shown in the *H.M.* experience as that in America has been found to be superior."<sup>1</sup>

Table showing the number of Persons who will die in a year out of 100,000 who have attained the given Age, according to several Tables of Mortality.

Age.	Northampton.	Carlisle.	Seventeen Offices.	Institute of Actuaries.	Institute of Actuaries.	American Experience.	Thirty American Offices.	Twenty-three German Offices.	Four French Offices.
	1780.	1815.	1843.	<i>H.M.</i> 1869.	<i>H.M.</i> 1869.	1868.	1881.	1883.	1895.
10	916	449	676	490	400	749	648	..	364
15	922	619	694	287	325	763	659	..	515
20	1,403	706	729	633	833	780	676	919	690
25	1,575	731	777	663	1,050	806	703	854	628
30	1,710	1,010	842	772	920	843	748	882	698
35	1,870	1,026	929	877	1,000	895	821	999	807
40	2,090	1,300	1,036	1,031	1,132	979	936	1,176	975
45	2,401	1,221	1,121	1,219	1,204	1,116	1,120	1,437	1,230
50	2,835	1,342	1,194	1,595	1,712	1,378	1,417	1,814	1,638
55	3,350	1,792	1,566	2,103	2,219	1,857	1,893	2,506	2,258
60	4,023	3,349	3,034	2,968	3,064	2,660	2,653	3,535	3,213
65	4,902	4,109	4,408	4,343	4,461	4,013	3,864	4,943	4,675
70	6,493	5,164	6,493	6,219	6,284	6,199	5,778	7,276	6,897
75	9,615	9,552	9,556	9,816	9,949	9,537	8,779	10,647	10,241
80	13,433	12,172	14,404	14,465	14,577	14,447	13,407	15,516	15,119
85	22,043	17,528	20,509	20,988	21,010	33,555	20,363	22,261	22,332
90	26,087	26,056	32,373	27,945	28,244	45,455	32,815	32,356	32,225

No final explanation has been given, and there is no proof that the average life in America is longer than in England or Germany. Dr McClintock inclines to believe that one potent cause of the great difference in the insured experience is that, while European offices have generally awaited applications, which are commonly prompted by some sense of need for insurance, the custom of American companies is actively to solicit business through agents. On the average, lives which are only induced by persuasion to insure are better than those which voluntarily apply. That this suggestion points

Problems of selection.

<sup>1</sup> On the Effects of Selection, by Emory McClintock (New York, 1892), p. 94.

on a real and perhaps an important differentiating influence upon groups of risks is not doubted, but the measure of its effects has not yet been determined. The question is one of many which yearly assume more prominence, and which, as a class, are conventionally termed problems of selection. Assuming that the general rate of mortality is precisely known, any deviation from it occurring in a special group of insured lives, as the result of some influence peculiar to that group, is called the effect of selection. If insurance were offered on equal terms to all, the feeble and dying would apply in disproportionate numbers, and the mortality would be excessive. To avoid this danger careful medical examinations are required, excluding risks which appear to be impaired; and this selection by the insurer uniformly reduces the mortality below the general average during the earliest years of insurance. During these years large numbers of the insured withdraw, either from inability or from indisposition to pay their premiums, but the motive to do so is weakest with lives which have become impaired. The average vitality is lowered by the loss on the whole of a superior class, and the average mortality of those who persist rises. The extent of this influence varies widely with the proportionate number of lapses and the motives which induce them, increasing in a startling degree when lapses multiply in a discredited company, and remaining small, or even at times doubtful, under very favourable conditions; so that the ascertainment of its amount in different circumstances, and for different groups of the insured, is a problem of extreme complication. Its importance is increased by two tendencies which have grown stronger in the practice of recent years: first, to permit at all times the withdrawal by any policy-holder of a substantial part of the technical or average reserve upon his assurance, a privilege which legislation and public opinion in the United States have extorted from the companies; and, secondly, the extensive introduction, under competition for public favour, of forms of policies which grant the option, at fixed dates in the future, between withdrawing the entire "accumulations," or technical reserve and surplus, and continuing the insurance. It is well known that at the maturity of these options the motive is strong for impaired lives to remain insured, and that the cash withdrawals are so largely of superior lives that the subsequent rate of mortality is much increased. Other problems in selection arise from varieties in the forms of policies. It is commonly recognized that there are general and marked differences between the mortality experienced upon assurances issued at low and those at high premium rates. Policies for short terms, on which the computed net rates are the lowest, have been found so unprofitable to the insurers that they are rarely granted, and only with a very heavy loading of the tabular value. Upon those insured for life, with annual premiums, there is a large and constant excess of death losses above the endowment assurances, while groups of policies with tontine or cumulative features or reserved bonuses, available only after surviving a term of years, uniformly experience a low mortality.

It is also to be remarked that it is found in general that the average amount of policies matured by death is higher than the average of all policies in force; and some actuaries incline to believe that tables of pecuniary loss might, for practical use, take the place of tables of mortality, since the actual claims are in units of money, not of lives. The vast field of inquiry opened to actuaries by these and many more special questions of selection promises to engross more and more of their attention and labour. The technical methods of reducing and treating the data of mortality have been brought to a high degree of perfection, but the necessity for a better classification of the data themselves, with reference to special groups of lives or policies, differentiated by social or local circumstances, by business methods, by forms of contract, by race or personal characteristics, must assume ever greater prominence. It is conceivable that, at some period hereafter, the practical reliance of the offices will be more upon tables to be computed for such special groups, from select experience, than upon those drawn from vast aggregates without discriminating among their somewhat incongruous divisions.

The mortality tables in common use, however, have been proved by a vast experience to furnish a safe and fairly equitable basis for the business of assuring lives. Assuming that the table shows how many of a large group now assured may be expected to end in each succeeding year, the present value of the claims upon them depends exclusively upon the rate of interest at which funds will accumulate. Exact foresight of this rate being impossible, the insurer must assume a rate which can with certainty be realized. The difficult problem of determining the limits of safety in this assumption attracts the more attention now, because of the recent persistent decline in the average productiveness of invested capital. The actuary is forced to observe that the interest factor in his calculations is much less definitely fixed by known facts than the mortality factor. The longer a contract has to run, the greater the effect of the difference in rate. The value of a payment to be made in thirty years is greater by above one-half with interest taken at 3% than at 4½%, and one to be made in thirty-six years is more than twice as great. Hence the most careful study of the forces determining for long periods the average rate of interest is fundamental in life insurance. The tendency of opinion is to hold that a progressive lowering of interest rates must result from the accumulation of wealth. In support of this belief it is pointed out that from 1872 nearly to the present time there has been a general and somewhat uniform decline in the yield of invested capital, as represented by government stocks, mortgage loans, savings bank deposits and discounts in all commercial nations. The movement has been disguised by wide fluctuations, temporary or local, but has been on the whole world-wide and continuous, when great masses of capital, such as the investments of life companies, are kept in view. The fall has been greatest, too, in countries where rates were formerly highest, suggesting that as the great financial markets of the world become more intimately connected the normal rate of interest assumes a more cosmopolitan character, with an increasing tendency to equality among them. These considerations have had an important influence upon the computations of life insurance companies. In Great Britain, and commonly in continental Europe, the leading offices from the first assumed lower rates of interest than those in America, usually 3½ or 3%; and the reductions in their estimates have as yet been moderate, only thirty-one out of seventy-four British offices having lowered the interest basis in their valuations reported to the Board of Trade.

These returns show that of these companies only twenty-three now compute reserves upon a rate as high as 3½%, while forty-four assume 3% and seven a still lower rate. But in America, when the business first became important 6% was a more frequent rate of investment than 5%, and the laws of New York and of many other states countenanced the confident expectation of a permanent yield of at least 4½%. The rate of 4% adopted by the principal companies, and by the law of Massachusetts from 1861, was regarded as highly conservative. But as early as 1882 one important company began to reserve upon new business at 3%, and since 1895 there has been a gradual change by the leading offices to 3½%, and in a few instances to 3%, as the basis of premiums and of reserves upon new policies. Serious efforts have been made to induce legislation which will gradually establish one of these rates as a test of technical solvency.

There are not wanting, however, indications that the protracted decline in rates of interest in the world's markets may have been checked, and even that a reverse movement has begun. Rates of discount everywhere, interest on government loans except in America, and on mortgage loans in Europe, have on the whole advanced, the minimum average rates having been reached, after twenty-five years of gradual reduction, in 1897. These facts are entirely consistent with the conclusions suggested by the history of the subject. No uniform or secular tendency to reduction in the average rate of interest, which is the index of the average productiveness of capital, not of its amount, can be found to have prevailed. Fluctuations in the average rate are found, quite independent of the local and temporary fluctuations, which are often extreme; and these long tidal waves of change have at times, for generations together, risen and fallen with some approach to periodicity. The prevailing rate has been a little

lower on the average in the 19th century than in the 18th, but was lower through the middle decades of the 18th century than through those of the 19th. On the whole, it seems clear that the accumulation of wealth in itself has no necessary tendency to diminish the productiveness of capital; that this productiveness, on the general average, has not materially varied in many generations; but that the promise and expectation of productiveness which prompt the demand for its use depend upon the activity of enterprise, growing out of the prevailing spirit of hope; upon the rapidity with which new inventions are made, industries extended, and floating or loanable capital expended in permanent works. These conditions are subject to fluctuations extending through considerable periods, so that for a number of years the rate may be higher, and then for a similar series of years lower than the normal rate, determined by average productiveness, but always tending to return to this normal rate, as the tide-swept surface of the ocean to its normal level.

While the excess of the average yield of capital in America, above that of the older nations, is diminished as the facilities of transfer and exchange increase, there is no reason to conclude that it will disappear for generations to come. It seems, therefore, that the general assumption of 3% for the valuation of British offices, and that of 3½% which is becoming the accepted standard for the companies of the United States, should command unquestioned confidence.

The business of life insurance being founded on well-ascertained natural laws, and on principles of finance which in their broad aspect are of the simplest description, there exists no necessity for frequent close scrutiny of the affairs of an insurance office, in so far as the maintenance of a mere standard of solvency is concerned. We have seen that the premiums charged for insurances are based on certain assumptions in regard to (1) the rate of mortality to be experienced, (2) the rate of interest to be earned by the office on its funds, and (3) the proportion of the premiums to be absorbed in expenses and in providing against unforeseen contingencies. If these assumptions are reasonably safe, an insurance office proceeding upon them may be confidently regarded as solvent so long as there is no conspicuously unfavourable deviation from what has been anticipated and provided for, and so long as the funds are not impaired by imprudent investments or otherwise. The ascertainment and division of profits, however, require that the affairs should be looked into periodically; but the fluctuations to which the surplus funds are liable within limited periods of time are generally regarded as furnishing a sufficient reason why such investigations should not take place too frequently. Accordingly in most offices the division of profits takes place only at stated intervals of years—usually five or seven years—when a complete survey is taken of the whole engagements present and future, and of the funds available to meet these. The mode in which the liability of an office under its current policies is estimated requires explanation.

All statistical observations on the duration of human life point to the conclusion that, after the period of extreme youth is past, the death-rate among any given body of persons increases gradually with advancing age. If, therefore, insurance premiums were annually adjusted according to the chances of death corresponding to the current age of the insured, their amount would be at first smaller, but ultimately larger, than the uniform annual payment required to insure a given sum whenever death may occur. This is illustrated by the following figures, calculated from the HM mortality table at 3% interest. In column 2 is the uniform annual premium at age thirty for a whole-term insurance of £100. In column 3 are shown the premiums which would be required at the successive ages stated in column 1 to insure £100 in the event of death taking place within a year. Column 4 shows the differences between the figures in column 2 and those in column 3.

From this table it appears that if a number of persons effect, at the age of thirty, whole-term insurances on their lives by annual premiums which are to remain of uniform amount during the subsistence of the insurances, each of them pays for the first year £1-130 more than is required for the risk of that year. The

second year the premiums are each £1-111 in excess of that year's risk. The third year the excess is only £1-093, and so it diminishes from year to year. By the time the individuals who survive have reached the age of fifty-four, their uniform annual premiums are

Age, 30+n.	P <sub>30</sub> .	A <sub>30+n</sub> .	P <sub>30</sub> - A <sub>30+n</sub> .
(1)	(2)	(3)	(4)
30	£1-880	£750	+£1-130
31	1-880	769	+ 1-111
32	1-880	787	+ 1-093
..	..	..	..
..	..	..	..
..	..	..	..
53	1-880	1-806	+ .074
54	1-880	1-916	- .036
55	1-880	2-042	- .162
..	..	..	..
..	..	..	..
95	1-880	61-848	-59-968
96	1-880	79-265	-77-385
97	1-880	97-087	-95-207

no longer sufficient for the risk of the following year; and this annual deficiency goes on increasing until at the extreme age in the table it amounts to £95-207, the difference between the uniform annual premium (£1-880) and the present value (£97-087) of £100 certain to be paid at the end of a year. Now, since the uniform annual premiums are just sufficient to provide for the ultimate payment of the sums insured, it is obvious that the deficiencies of later years must be made up by the excess of the earlier payments; and, in order that the insurance office may be in a position to meet its engagements, these surplus payments must be kept in hand and accumulated at interest until they are required for the purpose indicated. It is, in effect, the accumulated excess here spoken of which constitutes the measure of the company's liability under its policies, or the sum which it ought to have in hand to be able to meet its engagements. In the individual case this sum is usually called the "reserve value" of a policy.

In another view the reserve value of a policy is the difference between the present value of the engagement undertaken by the office and the present value of the premiums to be paid in future by the insured. This view may be regarded as the counterpart of the other. For practical purposes it is to be preferred as it is independent of the variations of past experience, and requires only that a rate of mortality and a rate of interest be assumed for the future.

According to it, the reserve value ( $V_x$ ) of a policy for the sum of 1, effected at age  $x$ , and which has been in force for  $n$  years—the  $(n+1)$ th premium being just due and unpaid—may be expressed thus, in symbols with which we have already become familiar.

$$V_x = A_{x+n} - P_x(1+a_{x+n}) \quad (1)$$

If we substitute for  $A_{x+n}$  its equivalent  $P_{x+n}(1+a_{x+n})$  this expression becomes

$$V_x = (P_{x+n} - P_x)(1+a_{x+n}) \quad (2)$$

whence we see that the sum to be reserved under a policy after any number of years arises from the difference between the premium actually payable and the premium which would be required to assure the life afresh at the increased age attained. By substituting for

$P_{x+n}$  and  $P_x$  their equivalents  $\frac{1}{1+a_{x+n}} - (1-v)$  and  $\frac{1}{1+a_x} - (1-v)$ , we obtain another useful form of the expression,

$$V_x = 1 - \frac{1+a_{x+n}}{1+a_x} \quad (3)$$

$$= \frac{a_x - a_{x+n}}{1+a_x} \quad (4)$$

The preceding formulæ indicate clearly the nature of the calculations by which an insurance office is able to ascertain the amount of funds which ought to be kept in hand to provide for the liabilities to the assured. In cases other than whole-term insurances by uniform annual premiums, the formulæ are subject to appropriate modifications. When there are bonus additions to the sums insured, the value of these must be added, so that by the foregoing formula (1), for

Net  
liability.

example, the value of a policy for 1 with bonus additions B is  $(1+B)P_{x:n} - P(1+a_{x:n})$ . But the general principles of calculation are the same in all cases. The present value of the whole sums undertaken to be paid by the office is ascertained on the one hand, and on the other hand the present value of the premiums to be received in future from the insured. The difference between these (due provision being made for expenses and contingencies, as afterwards explained) represents the "net liability" of the office. Otherwise the net liability is arrived at by calculating separately the value of each policy by an adaptation of one or other of the above formulae. In either case, an adjustment of the annuity-values is made, in order to adapt these to the actual conditions of a valuation, when the next premiums on the various policies are not actually due, but are to become due at various intervals throughout the succeeding year.

So far in regard to the provision for payment of the sums contained in the policies, with their additions. We now come to the provision for future expenses, and for contingencies not embraced in the ordinary calculations. In what is called the "net-premium" method of valuation, this provision is made by throwing off the whole "loading" in estimating the value of the premiums to be received. That is to say, the premiums valued, in order to be set off against the value of the sums engaged to be paid by the office, are not the whole premiums actually receivable, but the net or pure premiums derived from the table employed in the valuation. The practical effect of this is that the amount brought out as the net liability of the office is sufficient, together with the net-premium portion of its future receipts from policyholders, to meet the sums assured under its policies as they mature, thus leaving free the remaining portion—the margin or loading—of each year's premium income to meet expenses and to provide a demand. When the margin thus left proves more than sufficient for those purposes, as under ordinary circumstances it always ought to do, the excess falls year by year into the surplus funds of the office, to be dealt with as profit at the next periodical investigation.

There appears to be a decided preference among insurance companies for the net-premium method as that which on the whole is best suited for valuing the liabilities of an office transacting a profitable business at a moderate rate of expense, and making investigations with a view to ascertaining the amount of surplus divided among its constituents. In certain circumstances it may be advisable to depart from a strict application of the characteristic feature of that method, but it must always be borne in mind that any encroachment made upon the "margin" in valuing the premiums is, so far, an anticipation of future profits. Any such encroachment is indeed inadmissible, unless the margin is at least more than sufficient to provide for future expenses, and in any case care must be taken to guard against what are called "negative values." These arise when the valuation of the future premiums is greater than the valuation of the sums engaged to be paid by the office, or when in the expression  $(P_{x:n} - P)(1+a_{x:n})$  the value of  $P$  is increased so as to be greater than that of  $P_{x:n}$ . It is evident that any valuation which includes "negative values" must be misleading, as policies are thereby treated as assets instead of liabilities, and such fictitious assets may at any time be cut off by the assured electing to drop their policies.

In recognition of the fact that a large proportion of the first year's premiums is in most offices absorbed by the expense of obtaining new business, it has been proposed by some actuaries to treat the first premium in each case as applicable entirely to the risk and expenses of the first year. At a period of valuation the policies are to be dealt with as if effected a year after their actual date, and at the increased age then attained.

Another modification of the net-premium method has been advocated for valuing policies entitled to bonus additions. It consists in estimating the value of future bonuses (at an assumed rate) in addition to that of the sum assured and existing bonuses, and valuing on the other hand so much of the office premiums as would have been required to provide the sum assured and bonuses at the time of effecting the insurance. This tends to secure, to some extent, the maintenance of a tolerably steady rate of bonus.

An essentially different method is employed by some offices, and is not without the support of actuaries whose judgment is entitled to every respect. It has been called the "hypothetical method." By it the office premiums are made the basis of valuation. Hypothetical annuity-values, smaller than those which would be employed in the net-premium method, are deduced from the office premiums by means of the relation  $P' = \frac{1}{1+i} - (1+i)$ , and the policies are valued according to the formula

$$V_x = (P'_{x:n} - P')(1+a'_{x:n}),$$

where  $P'_x$  and  $P'_{x+n}$  are the office premiums at ages  $x$  and  $x+n$  respectively, and  $a'_{x:n}$  is the hypothetical annuity-value at the latter age. Mr Sprague has shown (*Ass. Mag.* xi. 90) that the policy-values obtained by this method will be greater or less than, or equal to, those of the net-premium method according as the "loading" is a constant percentage of the net premium or an equal addition to it at all ages, or of an intermediate character, its elements being so adjusted as to balance each other.

When the net-premium method is employed, it is important that the office premiums be not altogether left out of view, otherwise an imperfect idea will be formed as to the results of the valuation. Suppose two offices, in circumstances as nearly as possible similar, estimate their liabilities by the net-premium method upon the same data, but office A charges premiums which contain a margin of 20% above the net premiums, and office B charges premiums with a margin of 30%. Then, in so far as regards their net liabilities (always supposing the sum set aside in each case to be that required by the valuation), the reserves of those offices will be of equal strength, and if nothing further were taken into account they might be supposed to stand in the same financial position. But it is obvious that office B, which has a margin of income 50% greater than that of office A, is so much better able to bear any unusual strain in addition to the ordinary expenditure, and is likely to realize a larger surplus on its transactions. Hence it appears that in order to obtain an adequate view of the financial position of any office it is necessary to consider, not only the basis upon which its reserves are calculated, but also the proportion of "loading" or "margin" contained in its premiums, and set aside for future expenses and profits.

Valuations may be made on different data as to mortality and interest, and the resulting net liability will be greater or less according to the nature of these. Under any given table of mortality a valuation at a low rate of interest will produce a larger net liability—will require a higher reserve to be made by the office against its future engagements to the insured—than a valuation at a higher rate. The effect of different assumptions in regard to the rates of mortality cannot be expressed in similar terms. A table of mortality showing a high death-rate, and requiring consequently large assurance premiums, does not necessarily produce large reserve values. The contrary, indeed, may be the case, as with the Northampton Table, which requires larger premiums than the more modern tables, but gives on the whole smaller reserve values. The amount of the net liability depends, not on the absolute magnitude of the rates of mortality indicated by the table, but on the ratio in which these increase from age to age.

If the values deduced by the net-premium method from any two tables be compared, it will be seen that

$$V_x >, =, \text{ or } < V_x$$

according as

$$1 - \frac{1+a'_{x:n}}{1+i} >, =, \text{ or } < 1 - \frac{1+a_{x:n}}{1+i}$$

$$\text{i.e. as } \frac{1+a'_{x:n}}{1+i} >, =, \text{ or } < \frac{1+a_{x:n}}{1+i} \quad \dots (1),$$

$$\text{or as } \frac{1+a'_x}{1+i} >, =, \text{ or } < \frac{1+a_{x:n}}{1+i} \quad \dots (2);$$

where the accented symbols throughout refer to one table and the unaccented symbols to the other.

We have thus the means of ascertaining whether the policy-values of any table will be greater or less than, or equal to, those of another, either (1) by calculating for each table separately the ratios of the annuity-values at successive ages, and comparing the results, or (2) by calculating at successive ages the ratios of the annuity-values of one table to those of another, and observing whether these ratios decrease or increase with advancing age or remain stationary throughout. The above relations will subsist whatever may be the differences in the data employed, and whether or not the annuity-values by the different tables are calculated at the same rate of interest. When the same rate of interest is employed, any divergence in the ratios of the annuity-values will of necessity be due to differences in the rates of mortality.

A prevailing fallacy in the popular mind, which has grown out of the practice of net valuations, is the inference that the average technical reserve represents the value of the individual policy. Each risk is properly assumed at its probable or average value at the time. But from that moment its circumstances are constantly changing in directions then unforeseen, and the expectation that such changes will occur is the motive for insuring. To treat them singly as unchanged in value at any later time is as illogical as

Effects of different data.

Fallacy of single-policy reserve.

it would be after some have matured. The actual value of any one risk borne by a company is indeterminate. It may become a claim to-morrow, or not for a generation to come. In the former case the company must now hold funds to pay in full; in the latter, the future premiums will perhaps more than suffice, so that no present reserve is needed. An entire reserve for the whole body of risks is essential, and its amount is definite, upon the reasonable assumption that the general average remains undisturbed by individual changes. A distinct reserve for a single policy is inconceivable. To recognize it is to deny the first principle of insurance. The average amount by which the reserve of a company must be increased, because of the existence of policies of a given class, is to the actuary an important fact, and is commonly accepted as his best guide in the distribution of surplus. But a popular theory has seized upon the assignment of this average sum to each policy, in the technical shorthand of the actuary, and holds that it is in each case the special property of the owner of that policy. The practical consequences are serious when, as often, many of the insured cease to pay premiums, and each demands the amount of the supposed individual reserve. His right to claim it is countenanced by a widespread public opinion, which has inspired statutes in Massachusetts and some other states, requiring companies to redeem all policies lapsing after the first two or three years of insurance at a price founded on the technical reserve. Yet, in by far the majority of instances, the lapse of policies is of itself a loss to the company. It is deprived of business secured at much expense before it has derived any of the advantage expected from the accession. It is compelled to pay numbers of its profitable contributors for ceasing to contribute. The burden falls in a mutual company upon the insured who fulfil their contracts. Such laws favour those who withdraw after few payments at the cost of those who maintain their insurance to the end, or for many years. The American companies formerly yielded to the pressure of a mistaken public sentiment, and competed for favour by promising excessive values in case of surrender. Similar conditions exist in Switzerland, Austria, and other countries in which the business is minutely regulated by government bureaux. But in Great Britain the companies are largely free from such influences, while an open market exists for policies which have a commercial value, with results on the whole more satisfactory to all parties interested than any rule of compulsory purchase which could be enforced on the companies.

A special form of life insurance, which has wonderfully developed, is the family insurance of the labouring people by the so-called industrial companies. Until recently this class of people had no satisfactory share in the benefits

#### Industrial Insurance.

of insurance, although the friendly societies in Great Britain, and many forms of beneficial associations in the United States, were attempts, often in part successful, to provide for special wants, mainly for maintenance of the sick and for the costs of burial. Most of them, however, lacked a scientific basis and an efficient and permanent organization, while thousands of them were grossly mismanaged. In Germany an elaborate scheme of compulsory insurance for labourers was established by a law of the empire in 1883, and extended in subsequent years; and similar legislation has been enacted in several other countries, most thoroughly in Switzerland and Austria. The ultimate value of this great social experiment cannot

be ascertained. As a result of investigation into the affairs of various American insurance companies in 1905 by a committee appointed by the state legislature of New York, a new law regulating life insurance down to the minutest details was passed in 1906 (ch. 326). The surrender value of a policy is to be the amount of insurance which the reserve, computed on the 4½ mortality table, standing to its credit, will purchase as a single premium. Other important features of the legislation are that no New York company may hold a contingency reserve beyond a fixed proportion of the net value of its policies; the limiting of types of policies permitted, the defining of the nature of investments permitted, and provisions for state supervision, valuation, and annual division of profits.

yet be determined. That it relieves much want and does a great service in preventing pauperism is not disputed; but that it also undermines the independent spirit of the people, and that it imposes a burden upon the national industry, which not only hampers it in the world's competition, but reacts with special injury upon the class it aims to benefit, are criticisms not satisfactorily answered. No scheme of government insurance, certainly, is adapted to a people impatient of paternalism in its rulers and thoroughly habituated to voluntary association for all common interests. The solution of the great problem, how to apply the insurance principle to the most pressing needs for protection of the class supported by the wages of labour, is now sought in Great Britain and America mainly in the universal offer to them of industrial insurance. The Prudential Assurance Company of London was the pioneer in this work, beginning it experimentally in 1848, but gradually adapting its methods to the new field, until a generation later they showed themselves so efficient that an extraordinary growth resulted, and has continued without interruption. This company and others upon a similar plan insure whole households together for burial expenses in case of death, and a small provision for dependants or for old age, charging as premiums small fractions of a day's wages, which must be collected weekly. The great difficulties encountered were the cost of small and frequent collections, and the high rate of mortality, which is from 40 to 90% more than that in the experience of the older companies. This high death-rate is due not so much to the fact that life is shorter in the labouring class as to the lack of efficient medical selection, which would be too costly. The premiums, at best, must be made higher than in offices insuring for annual payments, but the demand for insurance extended as rapidly as the system could be explained, and the Prudential is said to have now in force some 12,000,000 policies, with an average premium of twopence a week, secured by an accumulated insurance fund of £17,000,000. It has superseded a host of petty assessment societies of various classes without scientific basis or business responsibility, which deluded and disappointed the poor. The British government in 1864 undertook to administer a plan for the insurance of working men, but in thirty years accomplished less than the work of one private company in a year. In addition to the many insurance companies which transact industrial business in the United Kingdom, a large number of friendly societies have adopted similar plans.

The system of industrial insurance was introduced into the United States in 1876. Its growth, though much more rapid than in Great Britain, was at first slow compared with that of later years. The following table, condensed from the *Insurance Year-Book for 1900*, is an interesting exhibit of the character as well as of the extent of this form of insurance among working men:—

*Industrial Insurance in the United States.*

Year.	No. of Cos.	Insurance written.	Policies in force 31st December.	Insurance in force 31st December.	Premiums received.	Losses paid.
1876	1	\$400,000	2,500	\$248,342	\$14,495	\$1,958
1880	3	34,212,131	228,357	19,590,780	1,155,360	430,631
1884	3	89,150,302	1,076,422	108,451,099	4,486,512	1,499,432
1888	7	161,260,335	2,788,000	302,033,066	11,939,540	4,162,745
1892	11	276,893,923	5,118,997	582,710,309	24,352,900	8,847,322
1896	11	360,852,458	7,375,688	886,484,869	49,058,791	13,420,336
1899	16	519,789,085	10,048,623	1,292,805,402	56,159,889	17,023,485

It is remarkable that the average weekly premium in the United States appears to be about 10 cents, or two and a half times as high as in Great Britain. The average policy is also proportionally larger, and the progressive increase in its amount deserves notice. At the rate at which the practice of insurance is extending among working men, it would require but few years for it to become as universal in these countries as any paternal government has aimed to make it by compulsion.

There are various sources from which a surplus of funds may arise in an insurance company: (1) from the rate of interest actually earned being higher than that anticipated in the calculations; (2) from the death-rate among the insured

being lower than that provided for by the mortality tables; (3) from the expenses and contingent outlay being less than the "loading" provided to meet them; and (4) from miscellaneous sources, such as profitable investments, the cancellation of policies, &c.

Supposing a valuation to have been made on sound data and by a proper method, and to have resulted in showing that the funds in hand exceed the liabilities, the surplus thus ascertained may be regarded as *profit*, and either its amount may be withdrawn from the assets of the office or the liabilities may be increased in a corresponding degree.

Various methods are employed by insurance companies in distributing their surplus funds among the insured. In some offices the share or "bonus" falling to each policyholder is paid to him in cash; in others it is applied in providing a reversionary sum which is added to the amount assured by the policy; in others it goes to reduce the annual contributions payable by the policyholder. A method of more recent introduction is to apply the earlier bonuses on a policy to limit the term for which premiums may be payable, thus relieving the policyholder of his annual payments after a certain period. Another method is to apply the bonuses towards making the sum insured payable in the lifetime of the policyholder. The plan of reversionary bonus additions is most common, and when it is followed the option is usually given of exchanging the bonuses for their value in cash or of having them applied in the reduction of premiums.

Not only are there different modes of applying surplus, but the basis on which it is divided among the insured also varies in different offices. In some the reversionary bonus is calculated as an equal percentage per annum of the sum insured, reckoning back either to the commencement of the policy in every case, or (more commonly) to the preceding division of profits. In others the rate is calculated, not only on the original sums insured, but also on previous bonus additions. In others the ratio of distribution is applied to the cash surplus, and the share allotted to each policy is dealt with in one or other of the ways above indicated. The following are some of the ratios employed by different offices in the allocation of profits: (1) in proportion to the amount of premiums paid (with or without accumulated interest) since the last preceding valuation; (2) in proportion to the accumulated "loading" of the premiums so paid; (3) in proportion to the reserve values of the policies; (4) in proportion to the difference between the accumulated premiums and the reserve value of the policy in each case.

Some offices have a special system of dealing with surplus, reserving it for those policyholders who survive the ordinary "expectation of life," or whose premiums paid, with accumulated interest, amount to the sums insured by their policies. This system is usually connected with specially low rates of premium.

In the United States the so-called "contribution plan" has been accepted in theory by many companies, though carried out with many variations in detail by different actuaries. The principle is, that since each of the insured is charged in his premium a safe margin above all probable outlays, when the necessary amount under each head becomes determinate the several excesses should be returned to him. It is therefore sought to calculate what each member would have been charged for net premium and loading had the mortality, rate of interest, and expenses been precisely known beforehand, and to credit him with the balance of his payments. As a corollary of the theory of net valuations, which regards every life insured as an average life until its end, and assumes the rigid accuracy and equity of all the formulas employed to represent business facts, it is consistent and complete. But many minds find it more curious than practical, and prefer to seek equity in faithfulness to contract rights rather than in adjustments which they deem too refined, if not fanciful. The plan has met with little favour in England, where surplus is more commonly distributed on general business principles. Enormous bonuses were saved by the British offices out of the excessive premiums at first collected, and by the American companies during the epoch of high interest rates. But the use of more accurate tables, the decline in interest, and the increased expenses of later years, have vastly reduced the apparent profits. Former methods of distributing surplus, when ascertained, have largely given way in America to novel and more complex plans. The Tontine idea, historically familiar, was for many years imitated by some offices in their insurance contracts. All premiums above

outlay, in a company or a class of policies, were accumulated, only stipulated amounts being paid on death claims meanwhile maturing, with no compensation to its members withdrawing, until the end of a fixed term, when the whole fund was apportioned to the survivors. Large returns were sometimes made, but many who could not maintain their policies were dissatisfied. "Semi-tontines" followed, partly meeting the difficulty by pooling only the surplus, and allowing some return in case of withdrawal. But these cruder forms of contract are now largely superseded by various "reserve-dividend," "accumulation," "bond," and "investment" policies, with options at stated periods between cash withdrawals and continued insurance, the simple inducement to provide against death being more or less merged in that of making a profitable investment of capital.

In those branches of insurance where the contract is one of indemnity against loss, the risk remaining the same from year to year—and where the consent of both parties, insurer and insured, is required at each periodical renewal—no question of allowance in respect of past payments can arise when one party or the other determines to drop the contract. It is quite recognized that the premiums are simply an equivalent for the risk undertaken during the period to which they apply, with a certain margin for expenses and for profit to the insurer, and that therefore a favourable issue of the particular contract supplies no argument for a return of any part of the sums paid. In life insurance, however, we have shown that the premiums contain a third element, namely, the portion that is set aside and accumulated to meet the risk of the insurance when the premium payable is no longer sufficient of itself for that purpose.

When a policyholder withdraws from his contract with a life insurance office, the provision made for the future in respect of his particular insurance is no longer required, and out of it a surrender value may be allowed him for giving up his right to the policy. If there were no reasons to the contrary, the office might hand over the whole of this provision, which is in fact the reserve value of the policy. No more could be given without encroaching upon the provision necessary for the remaining policies. But the policyholder in withdrawing is exercising a power which circumstances give to him only and not to the other party in the contract. The office is bound by the policy so long as the premiums are duly paid and the other conditions of insurance are not infringed. It has no opportunity of reviewing its position and withdrawing from the bargain should that appear likely to be a losing one. The policyholder, however, is free to continue or to drop the insurance as he pleases, and it may fairly be presumed that he will take whichever course will best serve his own interest. The tendency obviously is that policies on deteriorated and unhealthy lives are kept in force, while those on lives having good prospects of longevity are more readily given up. Again, the retiring policyholder, by withdrawing his annual contribution, not only diminishes the fund from which expenses are met, but lessens the area over which these are spread, and so increases the burden for those who remain. Considerations like these point to the conclusion that, in fairness to the remaining constituents of the office, the surrender value to be allowed for a policy which is to be given up should be less than the reserve value. The common practice is to allow a proportion only of the reserve value. Some offices have adopted the plan of allowing a specified proportion of the amount of premiums paid. This plan is not depended on any ground of principle, but is followed for its simplicity and as a concession to a popular demand for fixed surrender values.

Another mode of securing to retiring policyholders the benefit of the reserve values of their insurances is that known as the *non-forfeiture system*. This system was first introduced in America, whence it found its way to the United Kingdom, where it was gradually adopted by a large proportion of the insurance companies. In its original form it was known as the "ten years non-forfeiture plan." The policies were effected by premiums payable during ten years only, the rates being of course correspondingly high. If during those ten years the policyholder wished to discontinue his payments, he was entitled to a free "paid-up policy" for as many tenths parts of the original sum insured as he had paid premiums.

**Division of surplus.**

**Bonuses.**

**Surrender values.**

**Non-forfeiture system.**



The system, once introduced, was gradually extended first to insurances effected by premiums payable during longer fixed periods, and ultimately, by some offices, to insurances bearing annual premiums during the whole of life. The methods of fixing the amount of paid-up policy in the last-mentioned class of cases vary in different offices, but the principle underlying them all is that of applying the reserve value to the purchase of a new insurance of reduced amount.

An office, in entering on a contract of life insurance, does so in the faith that all circumstances material to be known in order to a proper estimate of the risk have been disclosed. These circumstances are beyond its own knowledge, and as the office for the most part (except as regards the result of the medical examination, which may reveal features of the case unknown to the proposer himself) is dependent on the information furnished by the party seeking to effect the insurance, it is proper that the latter be made responsible for the correctness of such information. Accordingly it is made a stipulation, preliminary to the issue of every policy, that all the required information bearing upon the risk shall have been truly and fairly stated, and that in case of any misrepresentation, or any concealment of material facts, the insurance shall be forfeited. In practice, however, this forfeiture is rarely insisted on unless there has been an evident intention to deceive. Other systems and conditions of life insurance policies may be shortly noticed.

The usual division of policies is into "non-participating" and "participating." Non-participating policies are contracts for the payment on death of a certain fixed sum in consideration of a given premium, and these amounts are not affected by the profit made by the company. Participating policies entitle the holders to a share in the profits of the company. These profits are applied in various ways, as described above. A policy may be a whole life one, that is, the policyholder may pay a periodical premium throughout life, or it may be a limited payment one (the holder paying a premium for a limited number of years), or an endowment policy, under which the insurer receives the amount he has insured for at a given age, say fifty-five or sixty; or if death occur previously, the sum is paid to his representatives. There are also endowment policies for children, under which parents or others receive a specified sum on a child attaining a given age, the premiums being returnable if the child dies before the specified age.

*As to Payment of Premiums.*—A certain period of grace is allowed, most commonly thirty days, after each premium falls due. If payment is not made within that time, the presumption is that the policyholder intends to drop the contract, and the risk of the office comes to an end. It may, however, be revived on certain conditions, usually the production of evidence of health and payment of a fine in addition to the premium. An impression used to prevail among the public that the offices were interested in encouraging the forfeiture of policies. If any such impression was ever shared by the offices themselves it must have long since passed away, every reasonable effort being now made to their part, not only to secure insurances but to retain them, and to adjust all the facilities that can be extended to policyholders with that object.

*As to Foreign Travel and Residence, and as to Hazardous Occupations.*—When Babbage wrote his *Comparative View of Assurance Institutions* in 1826, voyaging abroad was scarcely permitted under a British life policy. The Elbe and the Garonne, Texel and Havre, Texel and Brest, the Elbe and Brest were the limits prescribed by most of the English offices. Even at a much later period the extra premiums charged for leave to travel or reside abroad were very heavy. But improved means of conveyance—in some places better sanitary appliances, and habits of living more suited to the climatic conditions—and, more than all perhaps, the knowledge that has been gained by experience as to the extent of the extra risks involved and the relative salubrity of foreign climates—have enabled the offices to modify their terms very considerably. The limits of free residence and travel have been greatly widened, and where extra premiums are still required these are, as a rule, much lower than formerly. The assured are now commonly permitted to reside anywhere within such limits as north of 35° N. lat. (except in Asia) or south of 30° S. lat., and to travel to and from any places within those limits, without extra premium.

Military men (when on active service) and seafaring men are usually charged extra rates, as are also persons following specially dangerous or unhealthy occupations at home.

*As to Suicide.*—The policies of most companies used to contain a proviso that the insurance shall be void in case the person whose life is insured dies by his own hand, but it is now seldom inserted. Some offices, acting on a sound principle, limit its operation to a fixed period, the extent of which varies in different offices from six months to seven years from the date of issue of the policy.

The practice of rendering policies *indisputable* and free from restriction as to foreign travel or residence, after a certain period, has tended greatly to simplify the contract between the office and the insured. A declaration of indisputability covers any inaccuracies in the original documents on which a policy was granted, unless these inaccuracies amount to fraud, which the law will not condone under any circumstances.

A remarkable difference in the development of life insurance between Great Britain and the United States is, that among the British companies only one-third of the insurances in force is in purely mutual institutions, while in America the proportion exceeds four-fifths. In both countries there are also "mixed" companies, in which policyholders receive a fixed percentage of the realized surplus, often from three-fourths to nine-tenths of the whole, but the control and management are in the hands of shareholders. These form the great majority of the proprietary offices in the United Kingdom, and the profits of the business have been large. The amount of capital paid in by shareholders of forty-one joint-stock companies was £5,931,000, but the capital authorized and subscribed was much more, and the subscriptions have often been paid, wholly or in part, by credits from surplus. The shares of these companies, at market prices, represent a value of at least £50,000,000, but the dividends upon these shares are drawn largely from other business, many of the largest and most prosperous corporations conducting also fire insurance, and some of them marine or casualty insurance.

No branch of social statistics has been more diligently studied than life insurance, and several governments publish classified accounts of corporations insuring lives within their jurisdiction. But the reports are not uniform in method and in periods covered, and aggregates derived from them must be used with reserve. By the Life Assurance Companies Act 1870, and amendments made in later years, each company issuing policies in the United Kingdom must deposit with the Board of Trade every year its revenue account and balance-sheet for the preceding year, and must at fixed intervals cause an investigation of its financial condition to be made by an actuary, and furnish the public through the Board of Trade with the detailed results, in forms prescribed by the act. Thus these returns are the highest authority for the conditions and operations of the offices, which often supplement or anticipate them by voluntary publications. In the United States the laws exact still more minute and much prompter reports to the insurance departments of the states; and every annual statement is required to show the results of an actuarial investigation. All these facts are collected, classified and compared by statisticians for several standard annuals in both countries, especially the *Post Magazine Almanac*, *Bourne's Directory and Manual* and the *Insurance Blue Book* in London, and *The Insurance Year-Book of the Spectator Company* in New York.

The reports of the insurance department of New York cover more companies than those of any other state. The institutions not included in them are about thirty-five in number, mostly small and local. The New York reports represent very nearly 95% of the entire business of the United States. While the amount of life assurance done by British and other foreign offices in the United States is insignificant, fourteen companies of the United States have agencies in Canada (ten for new business), and four transact business in Europe and in other parts of the world. The home business of the American companies is in the aggregate about 87% of the whole.

In the principal countries of continental Europe life insurance is offered by the chief financial institutions of Great Britain and the United States, and their policies are in force probably to the aggregate amount of £140,000,000. The domestic companies have been stimulated to increased activity by the aggressive canvassing of the foreign agencies, and the business in recent years has grown rapidly, until now the total sum insured upon lives on the continent of Europe is little less than a milliard of pounds sterling. Much information about life insurance in the different countries of Europe will be found in Ehrenzweig's *Assicurazionijahrbuch* (Vienna).

(C. T. L.; T. A. I.)

## V. BRITISH POST OFFICE INSURANCE

In 1864 Mr Gladstone, then chancellor of the exchequer, advocated the extension of life insurance amongst persons of small means, and, encouraged by the remarkable success of the

Post Office Savings Bank, then recently established, proposed that the services of the postmaster-general should be enlisted in the promotion of insurance. The result was the passing of the Government Annuities Act 1864. This act authorized the commissioners for the reduction of the national debt, for the first time, to insure a life without granting an annuity upon it, and enabled the postmaster-general to act as the agent of the commissioners in the issue of life policies and the grant of annuities. The limits of insurance were fixed at £20 and £100, and of annuities at £4 and £50; and the purchase of deferred annuities or old-age pay, by monthly, or even more frequent instalments, was sanctioned. The work was eagerly accepted by Lord Stanley of Alderley, the postmaster-general of the day, and the machinery for putting the act in action was elaborated by Frank Ives Scudamore of the Post Office and Sir Alexander Spearman of the National Debt office. The business was commenced on the 17th of April 1865. By the end of the year 560 policies of insurance had been issued, and 94 immediate and 54 deferred annuities granted. In the first twelve months these figures had increased to 800 policies and 230 annuities. The opportunity thus given of insuring through the Post Office with government security was not, however, embraced with the warmth which had been anticipated. In 1882, when Mr Henry Fawcett, then in office, examined the subject, he found that the average number of policies of insurance granted annually during the seventeen years which had elapsed was under 400—less, in fact, than during the first twelve months of the system. The purchase of annuities had increased slightly, but the business was transacted chiefly in immediate annuities, and hardly indicated any progress in provision for old age by means of early savings. Mr Fawcett procured a Select Committee of the House of Commons on the subject. Before this committee Mr James Cardin, then assistant receiver and accountant-general of the Post Office, propounded a scheme for combining the annuity and insurance business of the Post Office with that of the savings bank. The Committee recommended the adoption of this scheme, together with some enlargement of range and some relaxation of conditions. The recommendations of the Committee were embodied in the Government Annuities Act 1882, which came into operation on the 3rd of June 1884, and which forms the basis of the present system.

Any person between 14 and 65 can now insure through the medium of the Post Office Savings Bank for any amount from £5 to £100; and the life of a young person between 8 and 14 can be insured for £5. Through the same channel can be purchased annuities, immediate or deferred, from £1 to £100, on the life of any person from 5 years old upwards. Old-age policies, that is, policies securing payment of a specific sum either at the expiration of a fixed period (varying from 10 to 40 years), or upon the attainment of a certain age, or sooner in case of death, can also be obtained. Policies for a fixed period can only be purchased by a single payment, but in all other cases the purchase can be effected by payment either of a lump sum or of annual instalments. Further, all purchases are effected through the Post Office Savings Bank. As soon as a contract is completed, the purchaser is required to pay the first instalment to his account in the bank, or, if he has no account already, to open an account for the purpose. This and all further instalments are then transferred by the postmaster-general, as they become due, to the credit of the National Debt Commissioners; all the purchaser has to do is to keep his banking account in funds; he can pay his savings into the bank when and as he pleases. So, also, when old-age pay, secured either by a deferred annuity or an endowment policy, becomes due, it is paid to the account of the purchaser; and, if it does not raise the sum standing to his credit to exceed the statutory limits, it can remain there earning interest, and he draws out in such amounts as may be convenient from time to time. The purchaser has also the advantage of the ubiquity of the Post Office Savings Bank. He can make his deposits, and can draw out his old-age pay when it becomes due, at any one of the 13,000 odd post offices where savings bank business is transacted. He can even, if his savings are made from day to day, use the penny stamp slips introduced by Mr Fawcett, affixing a stamp whenever he has a penny to spare, and paying in the slip when it is worth a shilling. In short, every advantage open to the ordinary depositor in the Savings Bank is placed at the service of the working man or woman who wishes to secure old-age pay, or to have a small sum to aid those who may suffer accidentally from his or her death. Even the reluctance of many persons to submit themselves to medical examination is tenderly regarded. A policy for any sum up to £25 may, if the information

afforded is satisfactory, be obtained without a doctor's certificate, on condition that, if death happens during the first year, only the premium paid is returned, and if during the second year, only half the sum insured is paid. As regards old-age pay, a purchaser can, by adopting a slightly higher scale of payment, secure the return of his purchase money if at any time before the annuity falls in he repents of his bargain. Further, employers of labour and friendly societies can, on behalf of their workmen or members, make all the payments necessary to buy an insurance or annuity, and recoup themselves out of wages or members' contributions.

The act of 1882 directed that the tables upon which annuities and policies of insurance are granted should be revised from time to time; and in February 1896 new tables reducing the rates of annual premiums, and giving greater facilities for old-age insurance, were issued. The rates are now but very slightly (less than 3%) higher than the average rates of the larger insurance offices. But the expense of small insurance business must necessarily be above the average, and it is fairer to compare the Post Office rates with those of the office which stands pre-eminent in the insurance of the working classes. Such a comparison shows that up to the age of 40 a life insurance can be effected with the Post Office at a cheaper rate than with the Prudential Insurance Company; between 40 and 60 the advantage is slightly on the side of the company.

In 1885, the first complete year after Mr Fawcett's improvement took effect, 103 deferred annuities and 457 insurance policies were granted; in 1905, 158 deferred annuities and 741 policies. The increase of business, measured in percentages, is no doubt appreciable, but the figures themselves are so small as to make such a comparison trivial. If we compare the two periods, before and after Mr Fawcett's reforms, we find that between the 17th of April 1865 and the 2nd of June 1882 (the first complete year after the act of insurance coming into operation) £557,625 were issued, and between the latter date and the end of 1905, 16,577 policies, amounting to £875,496. For the whole period the figures are 23,641 policies for £1,433,121. During the same time 3144 contracts for old-age pay, amounting in all to £64,378, were made. When we contrast with this sum total the fact that in 1905 alone 1,435,329 new accounts were opened in the Post Office Savings Bank, and more than £42,000,000 deposited in the bank in the course of the year, it becomes apparent that, while the Savings Bank has reached the mass of the population, insurance against old age and death through the Post Office has remained a minority.

In 1894 Mr C. D. Lang, the Controller of the Post Office Savings Bank, and Mr Cardin, giving evidence before the Commission on Old-Age Pensions, ascribed the small insurance and annuity business of the Post Office to the want of a personal canvass. They pointed out that there had been some temporary increase in insurance, through an appeal to the Post Office employes themselves, and they suggested that something might be done if the masters of the elementary schools could be induced to interest themselves in recommending to their scholars and the parents of their scholars the advantages offered by the Post Office. It was also pointed out that the friendly societies might, if they were so disposed, act as intermediaries between their members and the Post Office, and thereby, as it were, reinsure their risks with the government; but it was added that all overtures of this nature to the societies had failed, apparently from the fear—quite groundless—of introducing government control of the societies' affairs. There may, indeed, be another reason for the failure of the deferred annuity system. The insurance of old-age pay is not popular even amongst the members of friendly societies, or even in Germany, where it has been given to the workmen largely at the expense of other people. Insurance against death and accidents appeals to the young working man; but old age is too far off to be an object of solicitude, especially since the grant of old-age pensions by the state has made the future secure from destitution at least. However, if at any time opinion changes, the Post Office stands ready to make foresight or philanthropy easy. Though no great results have been achieved, a machinery has been established which works with perfect smoothness, and which may some day be of service to the nation.

## VI. MARINE INSURANCE

Marine insurance long antedates the kindred businesses of fire and life insurance. Villani, a 14th-century Florentine historian, speaks of marine insurance as having *History*, originated in Lombardy in 1182. This proves, at least, that in his day it was no novelty. It is mentioned in a Pisan ordinance of 1318, and in Venetian public documents of the early years of the 15th century. The earliest form of policy known is that given in the Florentine statute of 1523. It is uncertain whether insurance was introduced into England directly from Italy or by way of Flanders. The earliest policies issued in England which have yet been discovered are in Italian, but the subscriptions are in English ("Santa Maria di Venetia," Cadix to London, 1547, "Santa Maria de Porto Salvo," Hampton to Messina, 1548).

The earliest known policies in English are one of 1555 on the "Santa Cruz" <sup>1</sup> from any port of the Isles of India of Calicut into Lisbon, and one of 1557 on the "Ele" from Velis Maliga to Antwerp. The authority for this statement is Mr R. G. Marsden, who edited for the Selden Society the records of the Admiralty Court; neither earlier had been found at the Record Office down to May 1907. In the "Santa Cruz" policy there is no detailed statement of perils insured against, or of risks undertaken by the underwriter; the whole obligation of the underwriter to the assured is embodied in the following words: "We will that this assurance shall be so strong and good as the most ample writings of assurers, which is used to be maid in the stretre of London, or in the burse of Andwerp, or in any other forme that shulde have more force." This reference to Antwerp usage is 67 years before the date of C. Malynes' statement that all Antwerp policies contained a clause providing that they should in all things be the same as policies made in Lombard Street of London. The wording of the English policies written in Italian is very much simpler than the Florentine form of 1523, from which it almost seems that the wording used in England followed an earlier Italian form. But even the Italian policies in the two "Santa Marias" mention the uses and customs of "questa strada Lombarda di Londra" as the standard of the assurance they afford. The next most ancient policy we possess is dated 1613; it covers goods on the "Tiger" from London to "Zante, Petrasse and Saphalonia." The "Tiger" policy is interesting in another connexion. It recalls Shakespeare's *Macbeth*, l. iii. 7 (written about 1605):—

"Her husband's to Aleppo gone, master of the 'Tiger'."

Clark & Wright's note (in the "Clarendon Press" series edition) cites Sir Kenelm Digby's journal of 1628 mentioning "the 'Tyger' of London going for Scanderone" (Alexandretta). Hakluyt (*Voyages*) gives letters and journals of a voyage of the "Tyger of London" to Tipolis in 1583. Shakespeare again mentions a ship called the "Tiger" in *Twelfth Night*, V. iii. 63:—

"And this is he that did die the 'Tiger' board."

The policy by the "Tiger" is much more ample than any of those already mentioned; it details the perils insured against in words closely resembling the Florentine form of 1523, and differing only slightly from the form adopted by Lloyd's at a general meeting held in 1799, and afterwards incorporated in the Sea Insurance Stamp Act of 1755, which is the stem form of all modern British and American marine insurance policies.

While the form of the insurance policy was thus developing, there was a singular absence of legislation (and, as far as we can yet trace, of litigation) on the subject. Till 1601 differences seem to have been generally settled by arbitration. This accounts for the poverty of the British Admiralty records in matters of marine insurance. In 1601 a special tribunal was established by statute for summary trial of disputes arising on insurance policies; but, owing mainly to the opposition of the common-law judges, the new court languished, and by 1720 it had fallen into utter disuse. J. A. Park states that not more than sixty insurance cases were reported between 1603 and 1756. Consequently, when Lord Mansfield came to the court of king's bench in the latter year, he found a clear field. He practically created the insurance law of England. He made use of all the continental ordinances and codes extant in his day, taking his legal principles largely from them; the customs of trade he learnt from mercantile specialists. The subsequent legislation referred solely to the prohibiting of certain insurances (wager policies, &c.), the naming in the policy of parties interested therein, and the stamp duty levied on marine insurances. In 1804 Lord Herschell introduced his Marine Insurance Bill, which endeavoured "to reproduce as exactly as possible the existing law relating to marine insurance." After Lord Herschell's death, Lord Chancellor Halsbury took up the bill, introducing it in the House of Lords in 1899 and again in 1900; he appointed a committee on which underwriters, shipowners and average adjusters were represented, and, presiding himself, went through the bill with them clause by clause. The bill was then passed by the Lords, but was always blocked in the House of Commons till 1906, when it was taken up by Lord Chancellor Loreburn in conjunction with Lord Halsbury. After some amendment and modification it was finally passed by both Houses and became law on the 1st of January 1907 (6 Ed. VII., c. 41).<sup>1</sup> In America a less happy fate has attended the insurance code, forming part of the proposed civil code of New York, completed and published in 1865, of which a very slightly altered version was adopted in California and has been in effect there since the 1st of January 1873. On the continent of Europe legislation at first took the form of local ordinances of commercial cities, such as Barcelona (1434-1484), Florence (1523), Bruges (1538), Middelburg (1600), Rotterdam (1604-1655). In the third quarter of the 16th century, Ronson produced a handy guide to marine insurance, *Le Guidon de la mer*; and in 1656

Etienne Cleirac published there his *Us et coutumes de la mer*. This was followed in 1681 by the *Ordonnance de la marine*, which, through Lord Mansfield, had a great effect on English case law. In 1807 France produced the *Code de commerce*, on the model of which nearly every European nation has issued a similar code. Probably the "best considered" (Wilkes, J.) of these, and the most adequate as regards marine insurance, is that of the German empire; but Hamburg and Bremen still preserve many of their local conditions by special contract in their policies. In fact it is doubtful whether the German Code could have been produced without the previous elaboration of the Conditions of Hamburg and of Bremen. The Hamburg Conditions of 1817, revised 1867, constitute an admirable compendium of marine insurance as practised in that city.

Marine insurance being peculiarly an international business, being a factor in 95% of the operations of overseas trade, it is natural that those engaged in this business or making use of marine insurance in their business should experience the difficulty and hardship arising from the differences between the marine insurance law of different states, and should attempt to find a remedy. Such an attempt was made at the Buffalo conference of the International Law Association in 1899 to prepare a body of rules dealing with those parts of marine insurance on which the laws of maritime countries differ. This undertaking was of the same nature as the earlier efforts of the same association which resulted in the formulation of the York-Antwerp rules of general average. There are four important subjects on which great divergence prevails: (a) Constructive total loss; (b) Deductions from costs of repairs, new from old; (c) Effect of unseaworthiness and negligence; (d) Double insurance.

(a) Constructive total loss results, according to the law of France, Italy, Spain, Belgium, Holland, in case of injury or deterioration if the thing insured amounting to not less than three-quarters of its value in German law a ship is considered to be "unworthy of repair" when the cost of the repair, without deductions new for old, would amount to over three-fourths of the ship's former value (no similar provision seems to exist in Germany for goods); in the law of America a damage over 50% of the value of the vessel when repaired is a constructive total loss of the vessel, in case of the policy containing no express provision to the contrary. None of these varying systems appears to be so equitable to all concerned as the British rule, which was for this reason suggested to the Buffalo conference for international adoption. As regards the time when the constructive total loss should be applied, it was suggested to reject the British rule, prescribing that it shall be the time of commencing action against underwriters, and to adopt the continental and American rule referring to the facts as they existed at the time of abandonment. Then, as respects the effect of a valid abandonment on the rights in the property insured, the conference proposed to adopt the British and American rule of making the abandonment refer back to the time of the loss, as against the continental European system of making the transfer operative only from the date of the notice of abandonment. Finally, as to the freight of a properly-abandoned ship it was proposed to follow for international purposes the American rule of dividing the freight of the voyage between shipowner and underwriter in the proportion of the distances run before the disaster and to be run thereafter, rejecting the British rule of complete transfer to the underwriter and the various continental rules of proportional division between shipowner and underwriter.

(b) It was proposed to adopt the deductions set forth in the York-Antwerp rules as being suitable for international adoption in marine insurance contracts.

(c) As regards unseaworthiness and its effect on insurances on ships and goods, it was proposed in the case of ships to reduce materiality to the extent that the insured should be required by English and American law; to diminish the requirement from the absolute attainment of seaworthiness to the mere exercise of all reasonable care to make the vessel seaworthy. Even this attenuation did not appear sufficient, as it was proposed to degrade the performance of the already minimized warranty from being a condition of the insurance, and its non-performance from invalidating the policy. As to goods, they were proposed to be exempted from any warranty of seaworthiness of ship. Concerning negligence, it was proposed to hold the underwriter liable (subject to the new seaworthiness warranty) for any loss caused proximately by a peril insured against, although the loss was not caused by the negligence of the insured, or his servants or agents, or by the wilful act of his servants or agents, or the inherent nature or unsoundness of the article insured.

(d) In case of double or multiple insurance, the conference proposed to adopt the British rule of making all the policies effectual, independently of the order in which they were effected, and of making all the underwriters entitled to contributions *inter se*. As regards the premium, it was proposed that no premium should be returnable, where the risk has attached.

With the exception of those embodying the two suggestions named under (d), all the resolutions proposed were accepted by the combined underwriters will voluntarily consent to the practical annihilation of the seaworthiness warranty, and no less improbable that American and continental assured will voluntarily accept the stricter rule of constructive total loss embodied in English law, when their national

<sup>1</sup> An important addition to the marine insurance law of the United Kingdom was made by the Marine Insurance (Gambling Policies) Act 1909, which made void policies taken out by persons uninterested in ships or cargo, who only gain by the loss of the vessel. Such policies are known as "policies proof of interest" (P.P.I.).

law enforces on the underwriter terms more favourable to the assured. The fewness of the international insurance markets of the world diminishes the need for uniform international regulations in this matter. The matter may be one for adjustment by variation in the rate of premium, but this is not certain.

The Glasgow conference of 1901 adopted the rules, after excepting time policies from the scope of the rule respecting seaworthiness. The rules are known as the Glasgow Marine Insurance Rules. The writer knows of no instance in which they have been adopted in practice.

Returning to marine insurance in the United Kingdom, it is to be observed that the passing of the Marine Insurance Act of 1906 sharply marks an important change in the nature of the law of the subject. Till then it was based almost entirely on common law, only a few disconnected points having been dealt with by statute. The reported cases were thus of great importance, and being about 2000 in number (*teste* Sir M. D. Chalmers) were not easy to master. No doubt many of them referred to commercial conditions no longer prevalent; still they could not be entirely ignored. But the original introducer of the bill described it as an endeavour "to reproduce as exactly as possible the existing law relating to marine insurance," and as by being made law the language of the act has become authoritative, insured and insurers have now no call to go behind the wording of the act in any matter with which it deals. It thus appears that the case law of the subject existing before the 1st of January 1907 may be left aside, unless, perhaps, for use as affording examples of the way in which the provisions of the act work.

A contract of marine insurance is a contract of indemnity whereby the insurer undertakes to indemnify the insured, in the manner and to the extent agreed, against marine

#### Definitio.

losses, *i.e.* the losses incident to marine adventure. The contract may by its express terms or by usage be extended to cover risks on inland waters or land risks incidental to any sea voyage. There is a "maritime adventure," where any ship, goods or other movables are exposed to maritime perils, such property being termed "insurable property"; also where the earning of any freight, hire or other pecuniary profit or benefit, or the security for any loan or expenditure, is endangered by the exposure of insurable property to maritime perils; and where any liability to a third party may be incurred by the person interested in or responsible for insurable property by reason of its exposure to maritime perils. By "maritime perils" are meant the perils consequent on or incidental to the navigation of the sea, *i.e.* perils of the seas, fire, war perils, pirates, rovers, thieves, captures, seizures and restraints, and detentions of princes and peoples, jettisons, barratry, and any other perils, either of the like kind or which may be designated by the policy.

The contract being one of indemnity against maritime perils, it is evident that no one can derive benefit from it who has not some interest exposed to these perils. Consequently while, subject to the provisions of the act, every lawful marine adventure may be insured, all contracts of marine insurance are void when (1) the assured has no insurable interest, and has entered into the contract without expectation of acquiring such interest; (2) when the policy is a "wager" policy, being made "interest or no interest," "without further proof of interest than the policy itself," "without benefit of salvage to the insurer," or subject to any similar terms. But if there is no possibility of salvage a policy "without benefit of salvage to the insurer" is legally valid. Wager policies are illegal only in the sense of being void to all legal purposes. They cannot be sued upon, hence they are known as "honorary" policies. They are of frequent use, generally for the protection of interests which, though real, are not easily defined, or are of pecuniary value hard to determine. But they are ignored by the courts. The essential of insurable interest is the pecuniary advantage seen at the time of insurance as arising to the assured from the safety or due arrival of the adventure, or the pecuniary disadvantage similarly arising from its loss or deterioration. But such interest may lapse before arrival or destruction of the venture, and with the interest lapses the right of the assured to recover from the underwriter. Without interest at the time of the loss there is no right to recover from the underwriter. Subject to the assured simply transfer his interest to another, *eg.* by sale, he can assign his policy to the party who acquires his interest—unless, of course, the policy contains terms expressly prohibiting assignment. The customary form of assignment is endorsement of the policy either in blank or to a specified party. Within the limits already named, interests are insurable whether complete or partial, defeasible or contingent; similarly loans on bottomry or respondentia, advance freight not repayable in case of loss, charges of insurance, also shipmaster's, officers' and seamen's wages.

The owner of insurable property may insure its full value even though some third party have agreed or become liable to indemnify him in case of loss: a mortgagee has the same right of

insuring to full value; while a mortgagee may insure only up to the sum due or to become due to him under the mortgage, unless the mortgagee is insuring for the benefit of the mortgagor as well as for himself, in which case, even though he insure in his own name only, he may insure up to the full value. A consignee may insure in his own name the total amount of his interest and that of others for whose benefit he insures. Where no special contract is made between insured and underwriter, the insurable value of certain matters of insurance is ascertained as follows:—*Ship*—Her value at the commencement of the risk, including outfit, provisions, stores, advances of wages, and any other outlays expended to make the ship fit for the voyage or period of navigation covered, plus cost of insurance upon the whole. In the case of a steamship, the word "ship" includes machinery, boilers, coals and engine stores. In the case of a vessel engaged in a special trade, the word "ship" includes the ordinary fittings necessary for that trade. *Freight* (whether paid in advance or not)—The gross amount of freight at the risk of the assured, plus cost of insurance. *Goods*—The prime cost, plus expenses of and incidental to shipping and cost of insurance. *Other interests*—The amount at the insured's risk when the policy attaches, plus cost of insurance.

To be admissible in evidence a contract of marine insurance must be embodied in a document called a policy, which must specify the name of the assured (or of his agent in the effecting of the policy), the objects insured, and the risk insured against, the voyage or time (or both) covered, the sum insured, the name of the assurers. The signature of the assurer is necessary; it is found at the end of the policy, and the assurer is often on this account called the *underwriter*. The objects insured must be designated with reasonable certainty, regard being had to customary usage. The undertaking to insure is usually expressed by saying that the insured or his agent "doth make assurance and cause himself to be insured." The risks are either the whole body of maritime perils detailed above, or any one or set of these, or any other named peril against which the assured desires protection. There is no restriction by law of the length of voyage that may be insured, but time policies are, subject to the Finance Act 1901, invalid if made for more than one year; a voyage and a period of time may be covered on one policy. Policies are classed as "time" or "voyage" policies. It is not necessary to state in the policy the value of the objects insured, but generally the value is given; policies are therefore classed as "valued" or "unvalued," the latter being often called "open" policies. The values of objects insured under open or unvalued policies are the insurable values given above. As it frequently happens that merchants desire to have all their shipments of whatever nature covered, by whatever vessel they may come, they require insurance in general terms; such a policy is termed a "floating" policy. It states the limits of voyage and value covered by the underwriter, and the class of ships to be employed. The particulars of each shipment are declared as the shipments occur, and in the order of despatch or shipment, the declarations being usually endorsed on the policy. All shipments within the terms of the policy must be declared at their honest value, or in accordance with the special provisions of the policy, if any. An omission or erroneous declaration may be corrected even after loss or arrival, provided it was made in good faith.

The consideration paid by the insured to the underwriter in return for the protection granted by the latter is called the *premium*. Until payment be made or tendered the policy is not ordinarily insurable, *i.e.* unless otherwise agreed. When the insured effects insurance with an underwriter through a broker, then, unless otherwise agreed, the broker is liable for the premium to the underwriter, who is, however, directly responsible to the assured for losses or liabilities falling on the policy and for returnable premium. But the broker has a lien on the policy for the premium and for his brokerage, and in case he has had dealings as a principal with the insured, he has a lien on the policy for any balance due to himself in insurance transactions, unless he should have known that in these transactions the insured was merely an agent. Some policy forms state definitely that the premium has been paid; when such a form is used and no fraud is proved, this receipt is binding between assured and underwriter, but not between broker and underwriter. If an insurance is effected at a premium "to be arranged," and no

arrangement is made, then a reasonable premium is payable. The same holds where additional premiums have to be charged at a rate to be arranged and no arrangement is made.

It is evident that in nearly all the particulars of any adventure insured by an underwriter he is entirely dependent upon the insured for correct information. It is therefore the law that an insurance contract can be avoided and broken by either of the parties to it if the utmost good faith (*uberrima fides*) be not observed by the other. The obligation of perfect good faith is thus made reciprocal. Bad faith may show itself either in concealment or in misrepresentation. It is therefore made essential to the stability of any insurance contract that the insured must disclose before conclusion of the contract every material circumstance known by him, failing which the underwriter may avoid the contract. The insured is deemed to know every circumstance which in the ordinary course of business ought to be known by him. Every circumstance is deemed material which would influence the underwriter in his decision as to acceptance of the risk or the fixing of the rate of premium. Consequently the insured is not bound, unless specially asked by the underwriter, to disclose the favourable features of the risk offered, or matters known or presumably known by the underwriter (matters which are of common knowledge, and such as an underwriter ought in his usual business to be aware of), or matters respecting which the underwriter waives or declines information, or which any express or implied warranty renders superfluous. An agent effecting an insurance must, in addition to his principal's material knowledge, disclose everything material known to himself, or that he should know in the ordinary conduct of his business. Every representation of material fact made to an underwriter before conclusion of a contract by the insured or his agent must be true, and the underwriter may avoid the contract. Every representation is material which would influence the underwriter in his decision as to acceptance of the risk or to fixing the rate of premium. A representation of fact is regarded as true if it be substantially correct; literal correctness is not essential. A representation of expectation or belief is true if it is made in good faith. A representation may be withdrawn or corrected before the contract is concluded. The contract is deemed to be concluded when the underwriter accepts the risk, whether the policy be then issued or not.

It frequently happens that before a vessel has completed the venture on which she is engaged arrangements have already been made for her future employment. Where a vessel is insured on time, this is of no moment as respects her insurance. It has likewise been decided that where any insurable object is covered by a voyage policy "from" or "at and from" a named place, the policy is not rendered invalid by her not being at that place when the insurance is concluded; but, on the other hand, there is an implied condition that she will begin the venture within a reasonable time, and that if she fails in this the underwriter may avoid the contract. If the delay springs from circumstances known to the underwriter at the time of conclusion of the contract, or if the underwriter then acquiesces in it, the implied condition is nullified. If the insured abandons the venture insured, the contract expires; e.g. if, before the risk commences, the vessel's destination is changed to one not covered by the policy. Where the policy specifies a place of departure, and the ship does not sail from that place, the risk does not attach. If, however, the vessel actually starts from her intended port of departure, and commences the venture, and thereafter it is decided to change her destination, this decision constitutes a *change of voyage*. In default of provision to the contrary, the underwriter may elect to avoid his insurance from the time of that decision, although the ship be still in the course she would have followed in her originally intended venture.

Should a ship depart from the proper course of the voyage she starts upon, and for which she is insured, such departure, when made without lawful excuse or justification, is termed *deviation*. From the moment it occurs, even though she subsequently return to her proper course without loss or injury, the underwriter may avoid his contract; but the mere intention to deviate is immaterial. Deviation occurs (1) when in a policy a course is definitely specified and the vessel departs from it; (2) when, in absence of such definite specification in the policy, the vessel departs from the course usually and customarily followed in the voyage insured. If a policy provides for several named ports of discharge, the vessel may, without committing deviation, omit to proceed to one or more; but whether she goes to all or to some she must, in absence of express or sufficient cause for the contrary, take them in the order in which they appear in the policy, if not there is a deviation. If the policy provides for "ports of discharge" in a given district, then (in absence of usage or sufficient cause to the contrary) unless the vessel proceeds to them

in their geographical order she makes a deviation. Similarly, in the case of a voyage policy, the want of reasonable despatch throughout, unless lawful excuse or justification exists, entitles the underwriter to avoid the contract from the time that the delay becomes unreasonable. As excuses for deviation or delay on the voyage contemplated by the policy, the following are regarded as valid: authorization by licence or other provision in the policy, *force majeure*, compliance with express or implied conditions of the policy (e.g. warranties, see below), reasonable steps taken for the safety of the ship or other objects insured, saving life, helping a ship in such distress that life may be in danger, or obtaining medical or surgical aid for some person on board. If barratry is insured against, delay arising from barratrous conduct of master or crew does not avoid the policy. A deviation ceases to be excusable unless the ship resumes her proper course and proceeds on her voyage with reasonable promptitude after the cause of the excusable deviation or delay ceases to be effective.

In every contract of insurance there are certain conditions precedent to the liability of the underwriter and incumbent on the insured, which must be fully and literally complied with, whether material to the risk or not. These conditions are known in insurance as *warranties*. The name is unfortunate, as in every other branch of the law of contract it bears another meaning; still it is convenient, and its insurance signification is now firmly established. Failure on the part of the insured to fulfil a warranty *literally* entitles the underwriter to avoid his contract as from the moment of breach,<sup>1</sup> but it does not limit his obligation up to that moment. Breach of warranty is not nullified by subsequent remedy of the breach, consequently loss occurring after breach of warranty is not at the charge of the underwriter, even although before the loss the insured has again complied with the warranty. But breach of warranty may be waived by the insurer. Breach of warranty is excused in two cases only: (a) when by change of circumstances the warranty ceases to be applicable to the contract, (b) when by subsequent legislation the warranty becomes unlawful.

Warranties are of two classes: (1) express (2) implied. Express warranties must be written or printed on the policy, or contained in some document expressly referred to in the policy and so regarded as incorporated in the contract. No special form of words is essential to the validity of a warranty if the intention to warrant can be inferred. Express warranties may refer to anything which the parties to the contract choose, e.g. the nationality of the vessel, her sailing on a named day, proceeding under convoy, being excluded from certain voyages or trades or the carriage of certain cargoes, being "well" or "in good safety" on a named day (in which case the warranty is fulfilled if she be safe at any time of that day). As regards nationality, if no express warranty be given there is no undertaking on the part of the insured that the vessel is of any particular nationality or that she will not change it while the risk lasts. The warranty of *neutrality* in case of insurance of ship or goods means that at the beginning of the risk the property concerned is actually neutral, and that as far as the insured can control the matter it shall so continue during the whole course of the risk. It is also an implied condition of the ship being warranted neutral that to the utmost of the insured's power she must carry the papers necessary to establish her neutrality, must not falsify or suppress these papers, or use simulated papers; if this condition is broken the insurer can avoid the contract. Therefore in an express warranty there are always to be taken in their commercial sense, within that sense they are to be strictly and literally taken. An "express" warranty does not exclude an "implied" warranty (see below) unless it be inconsistent therewith.

In addition to these expressed conditions, there are also certain essential factors or conditions inherent in each and every contract of marine insurance without exception; these are *implied* warranties, which are presumed from the very fact of the making of the insurance. They are (a) completion of the prescribed venture without deviation, (b) *legality* of the venture (*viz.* that the adventure insured is a lawful one, and that, so far as the insured can control it, it shall be carried on in a lawful manner), (c) *seaworthiness* of the ship. In a voyage policy it is an implied warranty that at the commencement of the voyage the ship shall be seaworthy for the particular venture insured. If the risk commences when the ship is in port, then she must in addition be reasonably fit to stand the ordinary dangers of the port. If the voyage insured is one in which different degrees of peril are to be encountered, or for which the ship needs different kinds of outfit at different stages, then she must be seaworthy for each stage at

<sup>1</sup> Lord Mansfield expressed it: "The warranty in a contract of insurance is a condition or a contingency, and unless that be performed there is no contract" (*Hibbert v. Pigou, apud Marshall*, 3rd ed., p. 375).

its commencement, and the warranty will be fulfilled if she is at the beginning of each stage seaworthy for that stage. The warranty of seaworthiness is held to be fulfilled when the ship is reasonably fit in every respect to meet the ordinary marine dangers of the venture insured; that is to say, the mere loss of a vessel by perils of the sea is not a proof of unseaworthiness in the sense of this warranty. The only ship policies not subject to the warranty of seaworthiness are policies on time (the reason being that there is nothing to prevent a time policy lapsing and a new one commencing when the vessel is at sea beyond her owner's control as to seaworthiness); but where the insured knowingly sends a ship to sea in an unfit state and a loss is attributable to that unseaworthiness, the underwriter is not liable for such loss. It is not implied in a policy on goods or movables that these goods, &c., are seaworthy, but it is implied that at the beginning of the voyage the carrying vessel is not only seaworthy as a ship but reasonably fit to carry the goods to the destination named in the policy.

When the main points of the preceding particulars of the contract of insurance are summarized it may be said that the transaction is (1) a contract of indemnity reduced to written or printed words, (2) made in good faith, (3) referring to a defined proportion or amount, (4) of a genuine interest in a named object, (5) being against contingencies definitely expressed, to which that object is actually exposed, and (6) in return for a fixed and determined consideration.

It may happen by accident or by design that an insurance object has been covered twice or more times, and that in consequence the sum of the insurance effected exceeds the value in the policy or the insurable value, if an unvalued policy has been employed. This occurrence involves a new set of relations between the insured and his various underwriters; the underwriters themselves are brought into relation to one another. As regards the insured, he may, in the absence of agreement to the contrary, claim payment from whomsoever of the underwriters he may select, but he is not entitled to receive in all more than his proper indemnity. Each underwriter, whether his policy be valued or unvalued, is entitled to receive credit for his proper proportion of the sum obtained by the insured under any other policy. If the insured does obtain any sum in excess of indemnity, he is regarded as holding it in trust for his whole body of underwriters. It thus appears that in case of multiple insurance each underwriter is bound, as between himself and the other underwriters, to contribute to the loss rateably in proportion to the amount of his liability under the policy; and if any one pays more than his proper share, he is entitled to sue the rest for contribution. Should the insured get any of his premium back? It would not be equitable to enforce a return from any underwriter who has at any time stood alone so as to be liable to the full extent of his policy; but if overlapping policies were accidentally effected all at the same time, the case is rather different. This leads to the general question of *return of premium*. Such return may be claimed under the terms of the policy, in which case the claim for return is simply the carrying out of the agreement between the parties; it may refer to the whole or to a part of the interest insured. But there are other circumstances in which returns can legally be claimed. For instance, it may turn out that interest insured by a particular vessel and for a particular voyage is never shipped in that vessel for that voyage; the underwriter has in this case run no risk, and therefore the consideration for which he received the premium totally fails, and the premium is properly returnable to the intending insured, unless there has been fraud or illegality on the part of the insured. Similarly, in the case of part of the interest insured on a policy, if that part is distinguishable in the policy or by custom of trade. But the interest might have made the voyage in the vessel, and the intending insured might yet remain without insurable interest. In this case, in absence of fraud or illegality, and if the policy is not merely a gaming or wagering contract, the insured is entitled to return of his premium. Similarly, in the absence of fraud or illegality, if the underwriter legally voids his policy from the beginning of the risk; as he runs no risk, he receives no premium. The only cases, except those of fraud and illegality, in which the underwriter can retain his premium without running risk, are those of risks underwritten "lost or not lost," and

arrived safely without the underwriter's knowledge, in which the underwriter takes his chance as to the condition and situation of the ship when he assumes the risk. But this is practically a case of agreement that there shall be no return.

When the insured has overinsured on an unvalued policy, a proportionate part of the premium is returnable. But where double insurance has been knowingly effected by the insured or any earlier policy has at any time borne the entire risk or a claim has been paid on a policy in respect of its full value, no premium is returnable.

The policy issued by the underwriter to the insured makes mention of certain perils against which the insurance is granted, and unless the policy otherwise provides, the underwriter is liable for any loss proximately caused by any of these perils, but is not liable for any loss not proximately caused by a peril insured against. He is not responsible for any loss due to the wilful misconduct of the insured but, unless the policy otherwise provides, he is liable for any loss proximately caused by a peril insured against even though it would not have happened but for the misconduct or negligence of master or crew. Nor is he responsible for any loss caused by delay, although the delay be caused by a peril insured against; nor for ordinary wear and tear, ordinary leakage or breakage, inherent vice or character of objects insured, loss from rats or vermin, or injury to machinery not proximately caused by sea-perils.

Losses are divided into "total" and "partial." A "total" loss may be (1) actual, or (2) constructive; and an insurance against total loss covers the insured against both, unless a different intention appears from the terms of the policy. It is an **Total loss.** "actual" total loss when the object insured is destroyed or damaged so as to cease to be of the denomination of goods to which it belonged when insured, or when the insured is irrevocably deprived of the property insured. In the case of an actual total loss no notice of abandonment need be given. In the case of a missing ship after the lapse of a reasonable time without news, an "actual" total loss may be presumed. There is a "constructive" total loss when the interest insured has been abandoned on account of what appears inevitable actual total loss, or because the cost of preventing such loss would exceed the value after such expenditure. *E.g.* if ship or merchandise is in such a position that recovery is unlikely or the cost of recovery would exceed the value recovered, there is constructive total loss; likewise in the case of a damaged ship, if the cost of repair would exceed the repaired value of the ship. (In making the estimate of cost of repairs no deduction is to be made for the share of them payable in general average by other interests, but account is to be taken of the cost of later salvage operations and of the ship's proportion of any later general average.) Similarly for damaged goods, there is constructive total loss if the cost of repair and of forwarding to destination exceeds the arrived value. The insured may either treat constructive total loss as a partial loss or as an actual total loss, in which latter case he abandons his insured interest to the underwriter. If he decides to abandon he must give notice of abandonment, else he will recover only for a partial loss. This notice may be wholly or partly written or oral, and in any terms if only they indicate the intention to transfer unconditionally all interest to the underwriter. The refusal of abandonment by the underwriter does not prejudice the assured's rights. Abandonment may either be expressly accepted by the underwriter or may be implied from his conduct, but his mere silence does not imply acceptance. When notice is accepted, abandonment is irrevocable. Notice may be waived by the underwriter. Notice is unnecessary where, when the news reaches the insured, there would be no benefit to the underwriter if notice were given to him. On valid abandonment the underwriter adopts the interest of the insured in the subject insured, or what remains of it, and all incidental proprietary rights, *e.g.* in the case of a ship he is entitled to any freight in the course of being earned and which is earned by her subsequent to the accident causing the loss, less the expenses incurred after the accident; and if the cargo is on owner's account, the underwriter is entitled to reasonable freight from the place of casualty to destination.

Any loss other than a total loss, as defined and described above, is a "partial" loss. As such are classed general average, salvage charges, particular average, particular charges. General average is really an outlying branch of the law of contribution (see *AVERAGE AND CONTRIBUTION*); its connexion with insurance is merely secondary, arising out of the underwriter's contract to pay losses generally and this special liability in accordance with definite provisions of the policy. Any extraordinary sacrifice or expenditure voluntarily and reasonably made in a moment of peril in order to preserve all the property in the venture, is a general average act. **General average.** And the loss arising therefrom is a general average loss. **The party**

**Abandonment.**

**Partial loss.**

**General average.**

on whom it falls is entitled to a rateable contribution from the others. These rateable contributions are repayable by the respective underwriters subject to the special provisions of their policies, unless the sacrifice or expenditure was made to avert a peril not covered by the policies, when there is no liability. The party originally incurring a general average sacrifice may recover from his underwriter the whole loss without regard to his right to contribute to the other parties concerned in the venture. When ship, freight and cargo, or any two of them, belong to one person, the underwriter's liability is determined as if these interests were each owned by separate persons.

**Salvage charges.** "Salvage charges" are the charges recoverable under maritime law by a salvor independently of contract: if incurred in averting perils insured against, and if not otherwise provided in the policy, they are recovered as a loss from these perils. The cost of similar services of the insured or his agents or hired employees are recovered as a general average loss when the cost fulfils the character of general average expenditure, or in all other cases as "particular charges." Thus all expenses

**Particular average.** by or on behalf of the insured to save or preserve the interest insured are either general average, salvage charges or particular charges. Particular charges are not included in "particular average," which may now be defined as a partial loss of the subject insured, caused by a peril insured against, and not being a general average loss.

The nature of the liability for loss of the underwriter having been determined, it remains to fix its extent, or in other words the amount of each of the policy value, or (in case of an unvalued policy) the proportion of the loss which his subscription bears in the case of a valued policy to the insured value, and in the case of an unvalued policy to the insurable value.

**Measure of indemnity.** In the case of a total loss, the measure of indemnity is the sum fixed by the policy if valued, or the insurable value of the object insured if the policy is unvalued. When the insured fails in an action for total loss, he is not precluded from recovering a partial loss if the policy insures him against partial loss. In the case of damage to a ship not amounting to a total loss the insured is, subject to the terms of his policy, entitled to recover the reasonable cost of repairs less customary deductions, but not exceeding for any one casualty the sum insured. If the repairs are only partial he is in addition entitled to an allowance for unrepaired damage, but the aggregate must not exceed the cost of complete repairs, less customary deductions. If the damaged ship has neither been repaired nor sold during the risk, the insured is entitled to reasonable depreciation but not exceeding the reasonable cost of repairs, less customary deductions. As regards freight, the underwriter's liability for partial loss is, subject to the terms of the policy, the proportion of the policy value, or (in case of an unvalued policy) of the insurable value, which the freight loss bears to the whole freight at risk of the insured under the policy. When there is liability under a policy for total loss of part of the goods insured its amount is determined as follows: on an unvalued policy, it is the insurable value of the portion lost, ascertained as in case of total loss; on a valued policy, it is the proportion of the sum insured which the insurable value of the portion lost bears to that of the whole. Subject to any express provision of the policy, when goods are delivered at destination damaged throughout or in part, the liability is for the same proportion of the sum insured (or, in an unvalued policy, of the insurable value) that the difference between gross sound and gross damaged values at destination bears to the gross sound value there. Gross sound value means the wholesale price including freight, landing charges and duty; gross damaged value means the actual price obtained at a sale when all charges on sale are paid by the sellers. In case of goods customarily sold in bond, the bonded price is taken to be the gross value. When different kinds of property are insured under a single valuation, that valuation is apportioned over them in the proportion of their respective values to the total value of the unvalued policy, but when the prime cost cannot be ascertained the division is made over the net arrived sound values of the different kinds of property. The liability for general average contribution and salvage charges is, for anything insured for its full contributing value, the full amount of the contribution; but in case of insurance not attaining the full contributing value there is a reduction in proportion to the under insurance; and where a particular average is payable on the contributing goods, its amount must be deducted from the insured value when the underwriter's liability is being ascertained. On policies covering liabilities to third parties, the measure of indemnity, subject to the condition of the policy, is the amount paid or payable to the third party. When property is insured "free of particular average" (f.p.a.), then unless the policy is apportionable, as above, there is no liability for loss of part with exception of loss of part occasioned by a general average sacrifice, but there is liability for total loss of an apportionable part. The underwriter on f.p.a. terms is liable for salvage charges, particular charges and charges incurred under the "sue and labour" clause of the policy, but not for a total loss insured against, unless otherwise provided in the policy, when goods are insured f.p.a. under a certain named percentage, a general average loss cannot be added to a particular average loss to make up the specified percentage; nor may particular charges nor the expenses of ascertaining and proving the loss; in fact only the actual loss suffered by the object insured may be taken into account. The engagement evidenced by

the "sue and labour" clause of a policy is regarded as supplementary to the contract of insurance, and the expenses incurred under it are recoverable from the underwriter, even if he has paid a total loss or has insured the goods f.p.a. with or without any franchise being specified. General average losses and contributions are not "sue and labour" expenses, nor are salvage charges, as defined above. The expense of averting a loss not covered by the policy cannot be recovered under the "sue and labour" clause. The Marine Insurance Act specially declares that "It is the duty of the insured and his agents, in all cases, to take such measures as may be reasonable for the purpose of averting or minimizing a loss."

Unless otherwise provided, and subject to the provisions of the law, the underwriter is liable for successive losses, even though their aggregate amount exceeds the sum insured. But where, under one policy, an unrepaid or uncompensated partial loss is followed by a total loss, the insured can only recover the total loss. These provisions do not affect the underwriter's liability under the "sue and labour" clause, for, as explained above, the "sue and labour" clause is a contract supplementary to the insurance contract contained in the policy.

The payment of a total loss of the whole or of an apportionable portion of the object insured entitles the underwriter to take over the insured's interest in all that remains of the **Subrogation.** same, the underwriter becoming subrogated to all the rights and remedies of the insured in and regarding the interest in question, as from the time of his becoming the occasioning the loss. The payment of a partial loss gives the underwriter a similar subrogation but only in so far as the insured has been indemnified in accordance with law by such payment for the loss.

In case of double (or multiple) insurance each underwriter is bound to contribute, as between himself and the other underwriters, rateably to loss in proportion to the amount for which his policy makes him liable; for any excess of this amount he may maintain action against the co-insurers and may obtain the same remedy as a surety who has paid more than his proportion of a debt.

Where the object is insured for less than the insurable value, as defined above, the insured is deemed to be his own underwriter for the balance.

Recent extensions of marine insurance in England have mostly been in the direction of giving to shipowners protection against liabilities to third parties. The first addition was the **Liabilities.** running down clause (r.d.c.) by which underwriters take the burden of a proposition, usually by charterparty, if the damage inflicted on other vessels by collision for which the insured vessel is held to blame. The rapid increase in the use and size of steamships was accompanied by an equally rapid increase in the frequency of collisions at sea, tending to make the shipowner desirous of insuring himself against the balance of his collision liability, and against whatever other liabilities to third parties might be imposed upon him. There was a hesitation on the part of underwriters to meet these wants and the result is that in Great Britain most liability insurances are effected in mutual insurance societies. The insurance of such liabilities is perhaps simpler in Great Britain than in other countries, as the amount for which a shipowner can be liable is limited by law, although, of course, none but English tribunals are bound by that law. A new and extensive set of liabilities has been thrown on shipowners by the Workmen's Compensation Act of 1906; the liabilities in this case vary with the wages of the workmen concerned. Another interesting class of insurances has received much attention, namely, those against the risks of capture, seizure and detention by a hostile power, and the risks of piracy, and the difficulties connected with such risks probably lie more in determining the legal position of the owners of the property, and the obligations under which they lie, than in settling those of their underwriters. Such questions concern *blockade, contraband, domicile, nationality, neutrality, &c.*

The usual procedure in the offer and acceptance of a risk is as follows: The intending insured (principal or broker) offers the risk by showing to the underwriter a brief description of the nature in question, called in Great Britain a slip, in America an application. The underwriter signifies his acceptance of the whole or a part of the value exposed to perils by signing or initialling the slip, putting down the amount for which he accepts liability. Or he may sign and issue to the insured (principal or broker) a similar document made out in his own office, called a covering note or insurance note. These documents are simply first sketches of the contract, *mémoires pour servir*, so imperfect that they can be explained only in conjunction with the contract in its completed form (the policy). In America it is not at all rare for insurances to be effected through applications alone without any policy existing. In Great Britain the existence of a policy is essential, slips and covering notes being merely provisional agreements, binding in honour only, to issue policies on certain terms and conditions on receipt of the necessary information. One reason for insisting on a policy being issued for every risk is that a means of raising revenue by stamp taxes is thus created. In Great

Britain the stamp duties under the Stamp Act 1891 are as follows:—

Where the premium does not exceed $\frac{1}{4}$ % of the amount insured	1d.
Where the premium exceeds $\frac{1}{4}$ % of amount insured:—	
(a) On any voyage, per £100 or per any fractional part of £100	1d.
(b) For any time not exceeding six months, per £100, &c., as above	3d.
(c) For any time exceeding six months, and not exceeding twelve months, per £100, &c., as above	6d.

In consequence of this regulation, no time policy can be issued for a period exceeding twelve months. Policies or certificates of insurance coming from abroad are subject to the same duties, which should be paid within ten days after receipt in the United Kingdom. The shortness of the time allowed for stamping often prevents payment of the tax. These stamp regulations are very troublesome and produce only comparatively insignificant revenue. On small premium insurances the tax is so excessive that it drives business out of the country. A uniform tax per policy has been several times suggested, but these proposals have not yet been accepted by the Treasury.

The documents required to establish a claim for total loss are: (1) Protest of master. (2) Set of bills of lading (endorsed if necessary, so as to be available to the underwriter). (3) Policy or certificate of insurance (endorsed if necessary). (4) In the United States: Statement of loss in detail. In the United States certified copies of Nos. (1), (2), and (3) are taken; but as none of these copy-documents can transfer possession to the underwriter, there is necessary for that purpose another document, viz. (5) Bill of sale and abandonment with subrogation to underwriter—that is, an assignment of all interest to the underwriter. In the absence of the full set of bills of lading, a similar document should be taken in Great Britain, especially in all cases in which salvage operations are likely to be undertaken. Such a document handed to a salvage association or a manager of salvage (whether acting for shipowner or for underwriter) settles the ownership of salvaged goods, and ensures that any claim for salvage expenses will be sent directly to the underwriter. This is from the insured's point of view desirable, and it greatly simplifies the management of salvage cases. As a claim for total loss cannot extend beyond the full amount insured in the policy, it follows that the documents required to substantiate such a claim must be supplied to the underwriter free of charge.

For the substantiation of a claim for particular average the following documents are required: (1) Protest of master or log-book. (2) Set of bills of lading (cargo claims). (3) Policy or certificate of insurance (endorsed if necessary). (4) Certified statements in detail of actual cash value at destination of goods in damaged state, all charges paid. Certified statements in detail of sound value at destination of goods on same day, all charges paid. Original vouchers of costs of repair of ship, all discounts, rebates, allowances and returns deducted. (5) In the United States, subrogation to underwriters of damaged goods.

**AUTHORITIES.**—E. K. Allen, *Stamp Duties on Sea Insurances* (2nd ed., London, 1903); Th. Andersen, *Seversicherung* (Hamburg, 1888); Joseph Arnould, *Treatise on the Law of Marine Insurance and Average* (2 vols., 2nd edition, London, 1857); eighth edition by de Hart and Simey (London, 1909); Laurence R. Bailly, *Perils of the Seas* (London, 1860); William Barber, *Principles of the Law of Insurance* (San Francisco, 1887); W. G. Black, *Digest of Decisions in Scottish Shipping Cases, 1805-1890* (Edinburgh, 1891); Sir M. D. Chalmers and Douglas Owen, *Marine Insurance Act 1906* (London, 1906); Alfred de Courcy, *Commentaire des polices françaises d'assurances maritimes* (2nd edition, Paris, 1888); E. L. de Hart and R. L. Simey, *The Marine Insurance Act 1906* (London, 1907); R. R. Douglas, *Index to Maritime Law Decisions* (London, 1888); John Duer, *Law and Practice of Marine Insurance* (2 vols., New York, 1845, 1846); William Gow, *Marine Insurance* (3rd corrected edition, London, 1909); Victor Jacobs, *Etude sur les assurances maritimes et les avaries* (Brussels, 1885); Richard Lowndes, *Practical Treatise on the Law of Marine Insurance* (2nd edition, London, 1885); *Law of General Average, English and Foreign* (4th edition, London, 1888); Charles M'Arthur, *Contract of Marine Insurance* (2nd edition, London, 1890); D. MacLachlan, *Arnould on the Law of Marine Insurance* (2 vols., 6th edition, London, 1887); Reginald G. Marsden, *Admiralty Cases, 1645 to 1860* (London, 1868); *Law of Collisions at Sea* (5th edition, London, 1904); Douglas Owen, *Marine Insurance Notes and Clauses* (3rd edition, 1890); Theophilus Parsons, *Law of Marine Insurance and General Average* (2 vols., Boston, 1868); G. G. Phillimore, "Marine Insurance" in *Encyclopaedia of the Laws of England*, vol. viii. (London, 1907); Willard Phillips, *Treatise on the Law of Insurance* (2 vols., 5th edition, New York, 1867); C. R. Tyser, *Law relating to Losses under a Policy of Marine Insurance* (London, 1894); Rudolph Ulrich, *Grosse Haererei* (2nd ed., 3 vols., Berlin, 1903, 1905, 1906); G. Denis Weil, *Des assurances maritimes et des avaries* (Paris, 1870) (W. Go.)

**INTAGLIO** (an Ital. word, from *intagliare*, to incise, cut into), a form of engraving or carving, in which the pattern or design is sunk below the surface of the material thus treated, opposed to "cameo" or "relievo"—carving or engraving where the design is raised. Intaglio is thus applied to incised gems, as cameo (*q.v.*) to gems cut in relief (see GEM).

**INTELLECT** (Lat. *intellectus*, from *intelligere*, to understand), the general term for the mind in reference to its capacity for knowing or understanding. It is very vaguely used in common language. A man is described as "intellectual" generally because he is occupied with theory and principles rather than with practice, often with the further implication that his theories are concerned mainly with abstract matters: he is aloof from the world, and especially is a man of training and culture who cares little for the ordinary pleasures of sense. "Intellect" is thus distinguished from "intelligence" by the field of its operations, "intelligence" being used in the practical sphere for readiness to grasp a situation. (The employment of the word as a synonym for "news" is mere journalese; such phrases as "Intelligence Department" in connexion with newspapers and public offices are more justifiable.) In philosophy the "intellect" is contrasted with the senses and the will; it sifts and combines sense-given data, which otherwise would be only momentary, lasting practically only as long as the stimuli continued to operate. It thus includes the cognitive processes, and is the source of all real knowledge. Various attempts have been made to narrow the use of the term, *e.g.* to the higher regions of knowledge entirely above the region of sense (so Kant), or to conceptual processes; but no agreement has been reached. "Intellection" (*i.e.* the process as opposed to the capacity) has similarly been narrowed (*e.g.* by Professor James Ward) to the sphere of concepts; other writers, however, give it a much wider meaning. "Intellectualism" is a term given to any system which emphasizes the cognitive function; thus aesthetic intellectualism is that view of aesthetics which subordinates the sensual gratification or the delight in purely formal beauty to what may be called the ideal content.

**INTELLIGENCE IN ANIMALS.** Professor G. J. Romanes, in his work on *Animal Intelligence* (1881), used the term "intelligence" as synonymous with "reason," and defined it as follows: "Reason or intelligence is the faculty which is concerned in the intentional adaptation of means to ends. It therefore implies the conscious knowledge of the relation between means employed and ends attained, and may be exercised in adaptation to circumstances novel alike to the experience of the individual and that of the species." There is here some ambiguity as to the exact psychological significance of the words "intentional adaptation" and of the phrase "conscious knowledge of the relation between the means employed and the ends attained." A chick a day or two old learns to leave untouched nauseous caterpillars, and Romanes would certainly have regarded this as a case of intelligent profiting by experience; but how far there is intentional adaptation and whether the chick has conscious knowledge of the relation of means to ends, is doubtful, and, to say the least of it, open to discussion. John George Mivart, the acute dialectical opponent of Romanes, denied that animals are capable of the exercise of reason or intelligence. He urged that according to traditional views reason should denote and include all intellectual perception, whether it be direct and intuitive or indirect and inferential (*sensu stricto*), and contended that under neither head are to be included the sensuous perceptions and merely practical inferences of animals. Wasmann, who argues on similar grounds, regards such behaviour as that of the chicken as instinctive in the wider sense (see INSTINCT) and not intelligent; man alone, he contends, is intelligent, that is to say has the power of perceiving the relations of concepts to each other, and of drawing conclusions therefrom. It is clear that the discussion largely turns on the definition of terms; but more than this lies behind it. Both Mivart and Wasmann are emphatic in their assertions that instinctive modes of behaviour in the wider sense or the sensuous

<sup>1</sup> For a discussion of human intelligence, see PSYCHOLOGY.



perceptions and practical inferences of animals differ fundamentally in kind from the rational or intelligent conduct of human folk, and that by no conceivable process of evolution could the one pass upwards into the other.

Wasmann regards the inclusion of those activities which result from sense-experience under the term "intelligence" as pseudo-psychological. To modern psychologists of standing we must therefore turn. Under the heading "Intellect or Intelligence," in the *Dictionary of Philosophy and Psychology*, G. F. Stout and J. Mark Baldwin say: "There is a tendency to apply the term intellect more especially to the capacity for conceptual thinking. This does not hold in the same degree of the connected word intelligence. We speak freely of 'animal intelligence,' but the phrase 'animal intellect' is unusual. However, the restriction of the term to 'conceptual process is by no means so fixed and definite as to justify us in including it in the definition." With respect to the word intelligence again: "There is a tendency to restrict the term to conceptual thinking. Ward does so definitely and consistently. Croom-Robertson, on the other hand, gives the word the widest possible application, making it cover all forms of cognitive process. On the whole, if the term is to be employed at all, Robertson's usage appears preferable, as corresponding better to the generality of the words intellect and intelligence." It does not seem to be pseudo-psychological, therefore, to apply the term intelligence to the capacity, unquestionably possessed by animals, of profiting by sensory experience. The present writer has suggested that the term may be conveniently restricted to the capacity of guiding behaviour through perceptual process, reserving the terms intellect and reason for the so-called faculties which involve conceptual process. There are, however, advantages, as Stout and Baldwin contend, in employing the word in a somewhat wide and general sense. It is probably best for strictly psychological purposes to define somewhat strictly perceptual and conceptual (or ideational) process and to leave to intelligence the comparative freedom of a word to be used in general literature and therein defined by its context. It may be helpful, however, to place in tabular form the different uses above indicated:—

<i>Perceptual Process.</i>	<i>Conceptual Process.</i>
1. Instinct (wider sense).	Intelligence (e.g. Wasmann).
2. Sense-perception	Intelligence (e.g. Mivart).
3. Intelligence	(e.g. Stout and Baldwin).
4. Intelligence.	Intellect and Reason (e.g. Lloyd Morgan).

From this table it may be seen at a glance that, with such divergence of usage, the application of the word "intelligent" to any given case of animal behaviour has in itself little psychological significance. If the psychological status of the animal is to be seriously discussed, the question to be answered is this: Are the observed activities explainable in terms of perceptual process only, or do they demand also a supplementary exercise of conceptual process? Granting that they are intelligent in the broad acceptance of the word, are they only perceptually intelligent or also conceptually intelligent?

It would require more space than is at our command to make the distinction which is drawn by those who use these terms clear and distinct; but enough may perhaps be said to enable the general reader to grasp the salient points.

It will be convenient to take a concrete case. A chick in the performance of its truly instinctive activities pecks at all sorts of small objects. In doing so it gains a certain amount of initial experience. Very soon it may be observed that some grubs and caterpillars are seized with avidity whenever occasion offers; while others are after a few trials let alone. Broadly speaking, we have here intelligent selection and rejection. Psychologically interpreted what is believed to take place is somewhat as follows. Each grub or caterpillar affords a visual impression or sensation. This as such is just a presentation to sight and nothing more. But in virtue of previous experience it suggests what was formerly presented to consciousness in

that experience. It has meaning. An impression which carries meaning begotten of previous experience is raised to the level of a percept; and behaviour which is influenced and guided by such percepts, that is to say by impressions and the meaning for behaviour they suggest, is the outcome of perceptual process. If a dog learns to open a gate by lifting the latch, this may be due to perceptual process. Through previous experience the sight of the latch may suggest meaning for practical behaviour. His action may be simply due to the fact that the visual presentation has been directly associated with the appropriate bodily activities, and now by suggestion reinstates like activities; he may not, though on the other hand he may, exercise conceptual thought. Let us suppose that the chick which selects certain caterpillars and rejects others does form concepts. What does this imply from the standpoint of psychology? Stout and Baldwin define conception as the "cognition of a universal as distinguished from the particulars which it unifies. The universal apprehended in this way is called a concept." If then the chick apprehends the universal "good-for-eating" as exemplified in the particular maggot, and the maggot as a concrete case of the abstract and universal "good-for-eating," it has a capacity for conceptual thought. "There is one point in our definition," say Stout and Baldwin, "which requires to be specially emphasized. Conception is the cognition of a universal as distinguished from the particulars which it unifies. The words 'as distinguished from' are of essential importance. The mere presence of a universal element in cognition does not constitute a concept. Otherwise all cognition would be conceptual. The simplest perception includes a universal. . . . The universal must be apprehended in antithesis to the particulars which it unifies." The general, or in technical phraseology, the universal characteristic "good-for-eating" is present in all that the chick practically finds to be edible; but the chick may just eat the nice caterpillars without thinking for a moment of edibility.

Few would dream of contending that the chick a few days old is capable of conceptual thought. Naïve perceptual process pretty obviously suffices for an explanation of the behaviour of the little bird. But so too, it may be said, does it suffice for the explanation of much of the practical behaviour of men. If a great number of the actions of animals are only perceptually intelligent, so too are a great number of the actions of men and women. This is unquestionably the case; and it serves to bring out the distinction in value which may be assigned to the percept and the concept respectively. The value of the percept is for simple direct practical behaviour; the value of the concept is for the elaboration of systematic knowledge. Any given impression may have meaning for behaviour in a given situation which is like that which has previously developed in a certain manner; but it may also have significance for the interpretation of such situations in a conceptual scheme of thought. The sight of the sage-blossom may have meaning for the bee which has sucked the sweets contained in such flowers; the sight of the bee in this situation may have significance for scientific interpretation as an example of the fertilization of flowers by insects. The bee may be only perceptually intelligent; the man who observes its action may or may not be conceptually intelligent.

A good deal of human behaviour may be interpreted in terms of perceptual intelligence, and a far larger proportion of animal behaviour may be so interpreted. But some human conduct cannot be explained save as the outcome of conceptual intelligence. The question is, whether any carefully observed and well-authenticated cases of animal procedure are inexplicable in the absence of conceptual thought, and if so what concepts are necessarily involved? It is now conceded that the mere collection of anecdotes which result from casual as opposed to systematic observation can afford no satisfactory basis for an answer to this question. A solution can only be obtained by well-planned observations conducted by those who have an adequate psychological training. Even under these conditions a criterion of the presence or absence of conceptual factors is

*Psychological definition.*

*Conceptual process.*

*Their value.*

needed; and such a criterion is not easy to formulate or to apply.

If we institute inquiries with a view to ascertaining how the conceptual factor originates, it appears to be the result of analysis and abstraction, and to be reached by a process of comparison which becomes intentional and deliberate. If, for example, in educational procedure, we seek to assist children in forming concepts of colour, shape and material, we place before them a number of objects, some round, some square, some triangular; some red, some yellow, some blue; some made of paper, some of wood, some of flannel. Any given object is both red and square and made of flannel, blue and round and made of wood, and so on. We teach the child to group the objects, to put all the blues, yellows and reds together irrespective of shape or material; then all the rounds, squares and triangles together; then all which are made of like material. We thus help the children to grasp that though shape, colour and material are combined in each object, yet for the immediate purpose in hand one matters and the others do not matter. That which does matter is abstracted from the rest. The child has to analyse his experience and fix his attention on some given factor therein. He has to compare the objects intentionally, that is, for a definite end. He reaches, for example, the concept "blue" and realizes that the word may be applied to a number of particular objects differing in other respects, and that each is an example of what he understands by the word blue. Whether he could reach the concept without words is a question on which opinions differ.

Locke held that animals are incapable of the abstraction which is implied in such procedure. Dr Stout considers that observation of their behaviour shows little if any evidence of intentional comparison. And it is open to discussion whether they are able to analyse the situations opened up by their perceptual behaviour. The matter cannot be fully considered here. It must suffice if enough has been said to show the nature of the distinction between perceptual and conceptual process.

An example may, however, be given of the kind of observation which, since it was carefully planned and carried out, is of evidential value. Dr Alexander Hill's fox terrier was "taught" to open the side door of a large box by lifting a projecting latch. When the door swung open he was never allowed to find anything in the box, but was given a piece of biscuit from the hand. Then a warm chop-bone was put inside the box, which was placed in a courtyard so that the dog would pass it when no one was near, though he could be watched from the window. Details of the terrier's behaviour are given by Dr Hill in *Nature* (lxvii. 558, April 1903). The net result was that the dog failed to apply-at once his quite familiar experience of lifting the latch in the usual way. Here two situations were presented; first the box with people around and a piece of biscuit to be obtained from one of them by lifting the latch; secondly the box with no one near and a redolent chop-bone inside. To us it is obvious enough that the lifted latch is the key to the development of both situations; we analyse them so as to get the essential factor which matters. The dog apparently did not do so. He seemingly was incapable of this modest amount of analysis and abstraction.

We can now see more clearly what was meant by saying that Romanes' phrase (that intelligence "implies a conscious knowledge of the relation between means employed and ends attained") is ambiguous. The dog which lifts the latch of a gate and goes out when the gate swings open undoubtedly employs means to reach an end; he need not analytically think the means as conducive to the end and the end as reached by the means; he need not conceive this relationship as exemplified in a number of particular cases; he need not cognize the universal as distinguished from the particulars. Perceptual experience, therefore, does not imply what Romanes states if his words are interpreted in terms of conception; it does, however, imply that the relation-

ship is contained within the unanalysed whole of experience and is a factor contributing to an acquired mode of behaviour.

Opinions differ as to how far, if at all, animals show what we are bound to interpret as the rudiments of conceptual thinking. It is perhaps best to regard the question as still *sub judice*. The evolutionist school, but not without exception, incline to the view that we find in animals the beginnings of conceptual experience; some are, however, of opinion that, in the absence of language, conceptual analysis is well-nigh impossible, and in any case cannot be carried far. To an evolutionist the assertion that conceptual intelligence could not conceivably have had a natural genesis from perceptual experience, appears to be made on grounds other than scientific. Few if any psychologists contend, on strictly psychological grounds, for a distinction of kind such as Mivart and Wasmann postulate. Conscious experience is indeed *sui generis* and is distinct in kind from the energy with which the physicist or the physiologist has to deal; but within conscious experience from its earliest manifestation to its latest development scientific psychology only recognizes differences of mode.

In individual development the earliest manifestation of experience is the conscious accompaniment or concomitant of that type of organic behaviour which includes all reflex and instinctive acts. This affords the primordial tissue of experience, including a conscious awareness of the stimulating presentations which initiate organic behaviour and the kinaesthetic presentations which accompany it. Thus arises an awareness of the development of the instinctive situation. Perceptual intelligence depends upon associative re-presentation—the earlier phases of a presented situation calling up a revival of the whole previous experience before its later phases are again actually presented. Through the process of inhibition, to the clearer understanding of which physiology is daily contributing fresh data, the actual development through behaviour of the later phases of the situation is checked, and an acquired modification of the behaviour results. The whole range of perceptual intelligence in animals illustrates the manner in which accommodation to varied circumstances is reached. On these foundations in varied experience conceptual intelligence is developed. The early stages of its development, whether in the child, in whom it unquestionably occurs, or in the higher animals, in which it is not improbably incipient, are difficult to determine on the basis of observation of its expression in behaviour or conduct. But the distinguishing features of conceptual as contrasted with perceptual intelligence are the comparison of situations with a view to their analysis, the disentangling of factors which are of importance for some purpose of interpretation or of conduct, and the attitude of mind which is expressed by saying that the particular case is an example of what experience has shown to be, in technical phrase, universal, and is realized as such. Under the comprehensive phrase, intelligence in animals, this may or may not be included.

For literature, see under INSTINCT.

(C. L. M.)

**INTENDANT** (from Lat. *intendens*, pres. part. of *intendere*, to apply the mind to, to watch over; cf. "superintendent"), the name used in early times in France to designate a functionary invested by the king with an important and durable commission.<sup>1</sup> As early as the 14th century the title of *intendentes* or *superintendentes financierum* was given to the commissaries appointed by the king to levy the *aides*, or temporary subsidies. In the 16th century Francis I. created the *intendants des finances*, permanent functionaries who formed the central and superior

<sup>1</sup> In Germany the title *Intendant* is applied to the head of public institutions, more particularly to the high officials in charge of court theatres, royal gardens, palaces and the like. The director of certain civic theatres is now also sometimes styled Intendant. The title *Generallintendant* implies the same official duties, but higher rank. In the German army the *Intendantur* corresponds to the British Quartermaster-General's and financial departments of the War Office, the French *intendance militaire*. Subordinate to these are the *intendances* (*Intendanturen*). Subordinate to these are the heads of which are in Germany called *Korpsintendanten*, and in France *intendants-généraux*, *intendants militaires*, &c. (see ARMY, § 58).

Develop-  
ment of  
concept.

Are  
animals  
conceptually  
in-  
telligent?

Stages of  
develop-  
ment.

Ambiguity  
of phrase  
"con-  
scious  
knowledge  
of means."

administration in financial matters. They took the place of the *général des finances* and the "treasurers of France," who became provincial functionaries in the various *généralités*. The *intendants des finances* existed until the end of the *ancien régime*; they were at first under the authority of the *surlintendant*, and subsequently under that of the *contrôleur général des finances*. The *intendants des provinces* date from the last thirty years of the 16th century. They were commissaries sent by the king with wide powers to restore order in the provinces after the civil wars. Their functions were at first extraordinary and temporary, but a few were retained as permanent state officials, and in course of time they came to be fairly generally distributed over the whole kingdom. The existing territorial divisions were not disturbed, each *intendant* being placed over a *généralité*, save in some cases where slight modifications were necessary for administrative purposes. In their functions, however, there is another element worthy of notice. In the 13th and 14th centuries the monarchy had organized a species of inspection (*chevauchée*) over the provincial functionaries, which was performed by the *maîtres des requêtes*, and this the reform ordinances of the 16th century sought to revive. This inspectorate passed to the *intendant*, who became the resident local inspector and supervisor of all the other functionaries in his district; its connexion with the old *chevauchée* is plainly shown by the fact that the *intendants* were almost invariably selected from the *maîtres des requêtes*. The early *intendants* had naturally been largely concerned with the troops; eventually special military *intendants* (the only ones that exist in modern French law) were created, but the *intendants des provinces* retained certain military duties, notably those relating to the housing of the troops.

The early *intendants* were called indifferently *intendants de justice* or *intendants de finances*, their full official title being *intendants de justice, police et finances, et commissaires, départés dans les généralités du royaume pour l'exécution des ordres de Sa Majesté*. This title shows the wide range of their duties, the word "police" in this connexion connoting general administration. Not being officers of the king, but merely commissaries, they could always be recalled, and their powers were fixed by the commission they received from the king. As their functions became pre-eminently administrative the laws of the 17th and 18th centuries referred many questions to their decision, and, in this respect, their powers were determined by law. They became the direct general representatives of the king in each *généralité*, with authority over the other officials, whom they were empowered to censure, suspend or sometimes even replace. They were in constant touch with the king's council, with which they were connected by their original rights as *maîtres des requêtes*. In the first half of the 17th century they encountered some opposition from the governors of provinces, who had formerly been the direct political representatives of the crown, and also from the parliaments, which traditionally intervened in the administration, especially by means of *arrêts de règlement* (decisions, from which there was no appeal, regulating questions of procedure, civil law or custom). The *intendants*, however, were energetically supported, and so complete was their triumph that in the 18th century governors of provinces could not enter upon their duties without formal *lettres de résidence*.

The *intendants* had wide powers in the drawing by lot of the militia and in the royal *corvées* for the making and repair of the high roads, and were largely concerned with the administration of the *taille*, in which they effected useful reforms. They were the sole administrators of the principal direct and indirect imposts created in the second half of the 17th century and in the 18th century, and had full powers to settle disputes arising out of these taxes. Owing to the vast size of the districts allotted to the *intendants* (there were no more than thirty-two *intendants* in 1788), they often felt the need of assistants. As commissaries of the king, they could delegate their powers to *sub-délégués*, who were, however, not royal officials, but merely mandataries of the *intendant*. Decisions of the *intendant* could be carried to the king's council, and those of the *sub-délégué* to the *intendant*.

See Gabriel Hanotaux, *Origines de l'institution des intendants des provinces* (1884); D'Arbois de Jubainville, *L'Administration des intendants d'après les archives de l'Aube* (1880); P. Ardaschew, *Provincialnaia administratsiya vo Frantsii ve poslednyoe porou starago porjadka: provincialniy Intendanty* (St Petersburg, 1900-1906). (J. P. E.)

**INTENT** (from Lat. *intendere*, to stretch out, extend, particularly in the phrase *intendere animum*, to turn one's mind to, purpose), in law, the purpose or object with which an act is done. The question of intent is important with reference both to civil and criminal responsibility. Briefly, it may be said that in criminal law the constituent element of an offence is the *mens rea* or the guilty intent. The commission of an act without the intent is not, as a general rule, sufficient to constitute a crime, nor, on the other hand, does the existence of a guilty intent without commission of the act amount to the legal conception of a crime (see CRIMINAL LAW). In the case of civil wrongs, in general, the opposite holds good. A wrongful act done to the person or property of another carries with it legal liability, irrespective of the motive with which the act was done (see TORT). In reference to the construction of contracts, wills and other documents, the question of intention is material as showing the sense and meaning of the words used, and what they were intended to effect.

**INTERAMNA LIRENAS**, an ancient town of Italy in the Volscian territory near the modern Pignataro Interamna, 5 m. S.E. of Aquinum; the additional name distinguishes it from Interamna Praetuttianorum (mod. Teramo) and Interamna Nahartium (mod. Terni). It was founded by the Romans as a Latin colony in 312 B.C. as a military base in the war against Samnium, no fewer than 4000 colonists being sent thither. It was among the Latin colonies which in 209 B.C. refused to supply further contingents or money for the Hannibalic war. It became a *municipium* with the other Latin colonies, but we hear no more of it—mainly, no doubt, because it lay off the Via Latina. Livy's description of it as on the Via Latina is not strictly accurate, and cannot be used as an indication that the former course of the Via Latina was through Interamna. The city lay on a hill on the N. bank of the Liris, between two of its tributaries, thus lacking natural defences on the N. side alone. Many inscriptions have been found, and there are considerable remains of antiquity. One inscription bears the date A.D. 408, and the site was occupied in the middle ages by a castle called Terame or Termine. (T. AS.)

**INTERCALARY** (from Lat. *intercalare*, to proclaim, *calare*, the insertion of a day in the calendar), a term applied to a month, day or days inserted between other months or days in order to adjust the reckoning of time, based on the revolution of the earth round the sun, the day, and of the moon round the earth, the lunar month, to the revolution of the earth round the sun, the solar year (see CALENDAR). From the meaning of something inserted or placed between, intercalary is used for something which interrupts a series, or comes between two types. In botany, the term is used of growth which is not apical but somewhere between the apex and base of an organ, such as the growth in length of an Iris leaf, or of the internode of a grass-stalk.

**INTERCOLUMNIATION**, in architecture, the distance between the columns of a peristyle, generally referred to in terms of the lower diameter of the column. They are thus set forth by Vitruvius (iii. 2): (a) Pycnostyle, equal to  $1\frac{1}{2}$  diameters; (b) Systyle, 2 diameters; (c) Eustyle,  $2\frac{1}{2}$  diameters (which was the proportion preferred by him); (d) Diastyle, 3 diameters; and (e) Araeostyle or wide spaced, 4 diameters, a span only possible when the architrave was in wood. Vitruvius's definition would seem to apply only to examples with which he was acquainted in Rome, or to Greek temples described by authors he had studied. In the earlier Doric temples the intercolumniation is sometimes less than one diameter, and it increases gradually as the style developed; thus in the Parthenon it is  $1\frac{1}{2}$ , in the Temple of Diana Propylaea at Eleusis,  $1\frac{1}{2}$ ; and in the portico at Delos,  $2\frac{1}{2}$ . The intercolumniations of the columns of the Ionic Order are greater, averaging 2 diameters, but then the relative proportion of height to diameter in the column has to be taken into account, as also the width of the peristyle. Thus

in the temple of Apollo Branchidae, where the columns are slender and over 10 diameters in height, the intercolumniation is 1½, notwithstanding its late date, and in the Temple of Apollo Smintheus in Asia Minor, in which the peristyle is pseudo-dipteral, or double width, the intercolumniation is just over 1½. Temples of the Corinthian Order follow the proportions of those of the Ionic Order.

**INTERDICT** (Lat. *interdictum*, from *interdicere*, to forbid by decree, lit., interpose by speech), in its full technical sense as an ecclesiastical term, a sentence by a competent ecclesiastical authority forbidding all celebration of public worship, the administration of some sacraments (baptism, confirmation and penance are permitted) and ecclesiastical burial. From general interdicts, however, are excepted the feast days of Christmas, Easter, Whitsunday, the Assumption and Corpus Christi. An interdict may be either local, personal or mixed, according as it applies to a locality, to a particular person or class of persons, or to a particular locality as long as it shall be the residence of a particular person or class of persons. Local interdicts again may be either general or particular; in the latter instance they refer only to particular buildings set apart for religious services. An interdict is a measure which seeks to punish a population or a religious body (e.g. a chapter) for the fault of some only of its members, who cannot be reached separately. It is a penalty directed against society rather than against individuals. In 869 Hincmar of Laon laid his entire diocese under an interdict, a proceeding for which he was severely censured by Hincmar of Reims. In the *Chronicle* of Ademar of Limoges (*ad ann.* 994) it is stated that Bishop Alduin introduced there "a new plan for punishing the wickedness of his people; he ordered the churches and monasteries to cease from divine worship and the people to abstain from divine praise, and this he called excommunication" (see Gieseler, *Kirchengesch.* iii. 342, where also the text is given of a proposal to a similar effect made by Odolric, abbot of St Martial, at the council of Limoges in 1031). It was not until the 11th century that the use of the interdict obtained a recognized place among the means of discipline at the disposal of the Roman hierarchy, which used it, without great success, to bring back the secular authorities to obedience. Important historical instances of the use of the interdict occur in the cases of Scotland under Pope Alexander III. in 1181, of France under Innocent III. in 1200, and of England under the same pope in 1209. So far as the interdict is "personal," that is to say, applied to a particular individual, it may be regarded as a kind of partial excommunication; for instance, a bishop may, for certain faults, be interdicted from entering the church (*ab ingressu ecclesiae*), that is, without being excommunicated, he must not celebrate or assist at the celebration of divine offices. Interdicts cease at the expiration of the term, or by removal (*relaxatio*). General and local interdicts are no longer in use.

See the canonists in tit. 39 lib. v., *De sententia excommuni.*, &c.; L. Ferraris, *Prompia bibliotheca canonica*, &c., s.v. "Interdictum."

*Interdict*, in Scots law, is an order of court pronounced on cause shown for stopping any proceedings complained of as illegal or wrongful. It may be resorted to as a remedy against all encroachments either on property or possession. For the analogous English practice see INJUNCTION.

**INTERDICTION**, in Scots law, a process of restraint applied to prodigals and others who, "from weakness, facility or profusion, are liable to imposition." It is either voluntary or judicial. Voluntary interdiction is effected by the prodigal himself, who executes a bond obliging himself to do no deed which may affect his estate without the assent of certain persons called the "interdictors." This may be removed by the court of session, by the joint act of the interdictors and the interdicted, and by the number of interdictors being reduced below the number constituting a quorum. Judicial interdiction is imposed by order of the court, either moved by an interested party or acting in the exercise of its *nobile officium*, and can only be removed by a similar order. Deeds done by the interdicted person, so far as they affect or purport to affect his heritable estate, are reducible, unless they have been done with the

consent of the interdictors. Interdiction has no effect, however, on movable prope ty.

**INTERESSE TERMINI** (Lat. for "interest in a term"), in law, an executory interest, being the right of entry which the grant of a lease confers upon a lessee. Actual entry on the lands by the lessor converts the right into an estate. If the lease, however, has been created by a bargain and sale or by any other conveyance under the Statute of Uses, which does not require an entry, the term vests in the lessee at once. An *interesse termini* gives a cause of action against any person through whose action entry by the lessee or delivery of possession to him may have been prevented. An *interesse termini* is a right *in rem*, alienable at common law, and transmissible to the executors of the lessee.

**INTEREST**, etymologically a state or condition of being concerned in or having a share in anything, hence a legal or other claim to or share in property, benefits or advantages. Further developments of meaning are found in the application of the word to the benefits, advantages, matters of importance, &c., in which "interest" or concern can be felt, and to the feeling of concern so excited; hence also the word is used of the persons who have a concern in some common "interest," e.g. the trading or commercial interest, and of the personal or other influence due to a connexion with specific "interests." The word is derived from the Latin *interesse* (literally "to be between"), to make a difference, to concern, be of importance. The form which the word takes in English is a substantival use of the 3rd person singular of the present indicative of the Latin verb, and is due to a similar use in French of the older *interest*, modern *intérêt*. The earlier English word was *interest*, which survived till the end of the 17th century; the earliest example of "interest" in the *New English Dictionary* is from the *Rolls of Parliament* of 1450.

These meanings of "interest" are plainly derived from the ordinary uses of the Latin *interesse*. The origin of the application of the word to the compensation paid for the use of money or for the forbearance of a debt, with which, as far as present English law is concerned, this article deals, forms part of the history of USURY and MONEY-LENDING (q.v.). By Roman law, where one party to a contract made default, the other could enforce, over and above the fulfilment of the agreement, compensation based on the difference (*id quod interest*) to the creditor's position caused by the default of the debtor, which was technically known as *mora*, delay. This difference could be reckoned according as actual loss had accrued, and also on a calculation of the profit that might have been made had performance been carried out. Now this developed the canonist doctrine of *damnum emergens* and *lucrum cessans* respectively, which played a considerable part in the breaking down of the ecclesiastical prohibition of the taking of usury. The medieval lawyers used the phrase *damna et interesse* (in French *dommages et intérêts*) for such compensation by way of damages for the non-fulfilment of a contract, and for damages and indemnity generally. Thus *interesse* and *intérêt* came to be particularly applied to the charge for the use of money disguised by a legal fiction under the form of an indemnity for the failure to perform a contract.

At English common law an agreement to pay interest is not implied unless in the case of negotiable instruments, when it is supported by mercantile usage. As a general rule therefore debts certain, payable at a specified time, do not carry interest from that time unless there has been an express agreement that they should do so. But when it has been the constant practice of a trade or business to charge interest, or where as between the parties interest has been always charged and paid, a contract to pay interest is implied. It is now provided by the Civil Procedure Act 1833 that, "upon all debts or sums certain payable at a certain time or otherwise, the jury on the trial of any issue or in any inquiry of damages may if they shall think fit allow interest to the creditor at a rate not exceeding the current rate of interest, from the time when such debts or sums certain were payable, if such debts or sums be payable by virtue of some written instrument at a certain time; or if payable

otherwise, then from the time when demand of payment shall have been made in writing, so as such demand shall give notice to the debtor that interest will be claimed from the date of such demand until the term of payment; provided that interest shall be payable in all cases in which it is now payable by law." Compound interest requires to be supported by positive proof that it was agreed to by the parties; an established practice to account in this manner will be evidence of such an agreement. When interest is awarded by a court it is generally at the rate of 4%; under special circumstances 5% has been allowed.

**INTERFERENCE OF LIGHT.** § 1. This term<sup>3</sup> and the ideas underlying it were introduced into optics by Thomas Young. His Bakerian lecture on "The Theory of Light and Colours" (*Phil. Trans.*, 1801) formulated the following hypotheses and propositions, and thereby laid the foundations of the wave theory:—

*Hypotheses.*

- (i.) A luminiferous aether pervades the universe, rare and elastic in a high degree.
- (ii.) Undulations are excited in this aether whenever a body becomes luminous.
- (iii.) The sensation of different colours depends on the different frequency of vibrations excited by the light in the retina.
- (iv.) All material bodies have an attraction for the aetherial medium, by means of which it is accumulated in their substance, and for a small distance around them, in a state of greater density but not of greater elasticity.

*Propositions.*

- (i.) All impulses are propagated in a homogeneous elastic medium with an equivoque velocity.
- (ii.) An undulation conceived to originate from the vibration of a single particle must expand through a homogeneous medium in a spherical form, but with different quantities of motion in different parts.
- (iii.) A portion of a spherical undulation, admitted through an aperture into a quiescent medium, will proceed to be further propagated rectilinearly in concentric surfaces, terminated laterally by weak and irregular portions of newly diverging undulations.
- (iv.) When an undulation arrives at a surface which is the limit of mediums of different densities, a partial reflection takes place, proportionate in force to the difference of the densities.
- (v.) When an undulation is transmitted through a surface terminating different mediums, it proceeds in such a direction that the sines of the angles of incidence and refraction are in the constant ratio of the velocity of propagation in the two mediums.
- (vi.) When an undulation falls on the surface of a rarer medium, so obliquely that it cannot be regularly refracted, it is totally reflected at an angle equal to that of its incidence.
- (vii.) If equidistant undulations be supposed to pass through a medium, of which the parts are susceptible of permanent vibrations somewhat slower than the undulations, their velocity will be somewhat lessened by this vibratory tendency; and, in the same medium, the more, as the undulations are more frequent.
- (viii.) When two undulations, from different origins, coincide either perfectly or very nearly in direction, their joint effect is a combination of the motions belonging to each.
- (ix.) Radiant light consists in undulations of the luminiferous aether.

In the *Philosophical Transactions* for 1802, Young refers to his discovery of "a simple and general law." The law is that "wherever two portions of the same light arrive at the eye by different routes, either exactly or very nearly in the same direction, the light becomes most intense where the difference of the routes is a multiple of a certain length, and least intense in the intermediate state of the interfering portions; and this length is different for light of different colours."

This appears to be the first use of the word *interfering* or *interference* as applied to light. When two portions of light by their co-operation cause darkness, there is certainly "interference" in the popular sense; but from a mechanical or mathematical point of view, the superposition contemplated in proposition viii. would more naturally be regarded as taking place without interference. Young applied his principle to the explanation of colours of striated surfaces (gratings), to the colours of thin plates, and to an experiment which we shall discuss later.

The word "interference," as formed, on the false analogy of such words as "difference," from "to interfere," which originally was applied to a horse striking (*Lat. ferire*) one foot or leg against

in the improved form given to it by Fresnel, where a screen is illuminated simultaneously by light proceeding from two similar sources. As a preliminary to these explanations we require an analytical expression for waves of simple type, and an examination of the effects of compounding them.

§ 2. *Plane Waves of Simple Type.*—Whatever may be the character of the medium and of its vibration, the analytical expression for an infinite train of plane waves is

$$A \cos \left\{ \frac{2\pi}{\lambda} (Vt - x) + a \right\} \quad (1),$$

in which  $\lambda$  represents the wave-length, and  $V$  the corresponding velocity of propagation. The coefficient  $A$  is called the amplitude, and its nature depends upon the medium and may here be left an open question. The phase of the wave at a given time and place is represented by  $a$ . The expression retains the same value whatever integral number of wave-lengths be added to or subtracted from  $x$ . It is also periodic with respect to  $t$ , and the period is

$$\tau = \lambda/V \quad (2).$$

In experimenting upon sound we are able to determine independently  $\tau$ ,  $\lambda$ , and  $V$ ; but on account of its smallness the periodic time of luminous vibrations eludes altogether our means of observation, and is only known indirectly from  $\lambda$  and  $V$  by means of (2).

There is nothing arbitrary in the use of a circular function to represent the waves. As a general rule this is the only kind of wave which can be propagated without a change of form; and, even in the exceptional cases where the velocity is independent of wave-length, no generality is really lost by this procedure, because in accordance with Fourier's theorem any kind of periodic wave may be regarded as compounded of a series of such as (1), with wave-lengths in harmonic progression.

A well-known characteristic of waves of type (1) is that any number of trains of various amplitudes and phases, but of the same wave-length, are equivalent to a single train of the same type. Thus

$$\begin{aligned} \Sigma A \cos \left\{ \frac{2\pi}{\lambda} (Vt - x) + a \right\} &= \Sigma A \cos a \cdot \cos \frac{2\pi}{\lambda} (Vt - x) - \Sigma A \sin a \cdot \sin \frac{2\pi}{\lambda} (Vt - x) \\ &= P \cos \left\{ \frac{2\pi}{\lambda} (Vt - x) + \phi \right\} \end{aligned} \quad (3),$$

$$\text{where } P^2 = (\Sigma A \cos a)^2 + (\Sigma A \sin a)^2 \quad (4),$$

$$\tan \phi = \frac{\Sigma (A \sin a)}{\Sigma (A \cos a)} \quad (5).$$

An important particular case is that of two component trains only.

$$\begin{aligned} A \cos \left\{ \frac{2\pi}{\lambda} (Vt - x) + a \right\} + A' \cos \left\{ \frac{2\pi}{\lambda} (Vt - x) + a' \right\} \\ = P \cos \left\{ \frac{2\pi}{\lambda} (Vt - x) + \phi \right\}, \end{aligned}$$

$$\text{where } P^2 = A^2 + A'^2 + 2AA' \cos (a - a') \quad (6).$$

The composition of vibrations of the same period is precisely analogous, as was pointed out by Fresnel, to the composition of forces, or indeed of any other two-dimensional vector quantities. The magnitude of the force corresponds to the amplitude of the vibration, and the inclination of the force corresponds to the phase. A group of forces, of equal intensity, represented by lines drawn from the centre to the angular points of a regular polygon, constitute a system in equilibrium. Consequently, a system of vibrations of equal amplitude and of phases symmetrically distributed round the period has a zero resultant.

According to the phase-relation, determined by  $(a - a')$ , the amplitude of the resultant may vary from  $(A - A')$  to  $(A + A')$ . If  $A$  and  $A'$  are equal, the minimum resultant is zero, showing that two equal trains of waves may neutralize one another. This happens when the phases are opposite, or differ by half a (complete) period, and the effect is that described by Young as "interference."

§ 3. *Intensity.*—The intensity of light of given wave-length must depend upon the amplitude, but the precise nature of the relation is not at once apparent. We are not able to appreciate by simple inspection the relative intensities of two unequal lights; and, when we say, for example, that one candle is twice as bright as another, we mean that two of the latter burning independently would give us the same light as one of the former. This may be regarded as the definition; and then experiment may be appealed to to prove that the intensity of light from a given source varies inversely as the square of the distance. But our conviction of the truth of the law is perhaps founded quite as much upon the idea that something not liable to loss is radiated outwards, and is distributed in succession over the surfaces of spheres concentric with the source, whose areas are as the squares of the radii. The something can only be energy; and thus we are led to regard the rate at which energy is propagated across a given area parallel to the waves as the measure of intensity; and this is proportional, not to the first power, but to the square of the amplitude.

§ 4. *Resultant of a Large Number of Vibrations of Arbitrary Phase.*—We have seen that the resultant of two vibrations of equal amplitude

is wholly dependent upon their phase-relation, and it is of interest to inquire what we are to expect from the composition of a large number ( $n$ ) of equal vibrations of amplitude unity, and of arbitrary phases. The intensity of the resultant will of course depend upon the precise manner in which the phases are distributed, and may vary from  $n^2$  to zero. But is there a definite intensity which becomes more and more probable as  $n$  is increased without limit?

The nature of the question here raised is well illustrated by the special case in which the possible phases are restricted to two opposite phases. We may then conveniently discard the idea of phase, and regard the amplitudes as at random positive or negative. If all the signs are the same, the intensity is  $n^2$ ; if, on the other hand, there are as many positive as negative, the result is zero. But, although the intensity may range from 0 to  $n^2$ , the smaller values are much more probable than the greater.

The simplest part of the problem relates to what is called in the theory of probabilities the "expectation" of intensity, that is, the mean intensity to be expected after a great number of trials, in each of which the phases are taken at random. The chance that all the vibrations are positive is  $2^{-n}$ , and thus the expectation of intensity corresponding to this contingency is  $2^{-n} \cdot n^2$ . In like manner the expectation corresponding to the number of possible vibrations being  $(n-1)$  is

$$2^{-n} \cdot n \cdot (n-2)^2,$$

and so on. The whole expectation of intensity is thus

$$\frac{1}{2^n} \left\{ 1 \cdot n^2 + n(n-2)^2 + \frac{n(n-1)}{1.2} (n-4)^2 + \dots + \frac{n(n-1)(n-2)}{1.2.3} (n-6)^2 + \dots \right\} \quad (1).$$

Now the sum of the  $(n+1)$  terms of this series is simply  $n$ , as may be proved by comparison of coefficients of  $x^n$  in the equivalent forms

$$(e^x + e^{-x})^n = 2^n (1 + \frac{1}{2} x^2 + \dots)^n \\ = e^{nx} + n e^{(n-2)x} + \frac{n(n-1)}{1.2} e^{(n-4)x} + \dots$$

The expectation of intensity is therefore  $n$ , and this whether  $n$  be great or small.

The same conclusion holds good when the phases are unrestricted. From (1), § 2, if  $A=1$ ,

$$P^2 = n + 2\sum \cos(a_2 - a_1) \quad (2),$$

where under the sign of summation are to be included the cosines of the  $n(n-1)$  differences of phase. When the phases are arbitrary, this sum is as likely to be positive as negative, and thus the mean value of  $P^2$  is  $n$ .

The reader must be on his guard here against a fallacy which has misled some high authorities. We have not proved that when  $n$  is large there is any tendency for a single combination to give the intensity equal to  $n$ , but the quite different proposition that in a large number of trials, in each of which the phases are rearranged arbitrarily, the mean intensity will tend more and more to the value  $n$ . It is true that even in a single combination there is no reason why any of the cosines in (2) should be positive rather than negative, and from this we may infer that when  $n$  is increased the sum of the terms tends to vanish in comparison with the number of terms. But, the number of terms being of the order  $n^2$ , we can infer nothing as to the value of the sum of the series in comparison with  $n$ .

Indeed it is not true that the intensity in a single combination approximates to  $n$ , when  $n$  is large. It can be proved (*Phil. Mag.*, 1880, 10, p. 73; 1899, 47, p. 246) that the probability of a resultant intermediate in amplitude between  $r$  and  $r+dr$  is

$$\frac{2}{\pi} e^{-r^2/n} r dr \quad (3).$$

The probability of an amplitude less than  $r$  is thus

$$\frac{2}{\pi} \int_0^r e^{-r'^2/n} r' dr' = 1 - e^{-r^2/n} \quad (4).$$

or, which is the same thing, the probability of an amplitude greater than  $r$  is

$$e^{-r^2/n} \quad (5).$$

The accompanying table gives the probabilities of intensities less than the fractions of  $n$  named in the first column. For example, the probability of intensity less than  $n$  is .6321.

.05	.0488	.80	.5506
.10	.0952	1.00	.6321
.20	.1813	1.50	.7768
.40	.3296	2.00	.8647
.60	.4512	3.00	.9502

It will be seen that, however great  $n$  may be, there is a fair chance of considerable relative fluctuations of intensity in consecutive combinations.

The mean intensity, expressed by

$$\frac{2}{\pi} \int_0^\infty e^{-r^2/n} r^2 dr,$$

is, as we have already seen, equal to  $n$ .

It is with this mean intensity only that we are concerned in ordinary photometry. A source of light, such as a candle or even a soda flame, may be regarded as composed of a very large number of luminous centres disposed throughout a very sensible space; and, even though it be true that the intensity at a particular point of a screen illuminated by it and at a particular moment of time is a matter of chance, further processes of averaging must be gone through before anything is arrived at of which our senses could ordinarily take cognizance. In the smallest interval of time during which the eye could be impressed, there would be opportunity for any number of rearrangements of phase, due either to motions of the particles or to irregularities in their modes of vibration. And even if we supposed that each luminous centre was fixed, and emitted perfectly regular vibrations, the rapidity of composition and consequent intensity would vary markedly from point to point of the screen, and in ordinary cases the mean illumination over the smallest appreciable area would correspond to a thorough averaging of the phase-relationships. In this way the idea of the intensity of a luminous source, independently of any questions of phase, is seen to be justified, and we may properly say that two candles are twice as bright as one.

§ 5. *Interference Fringes.*—In Fresnel's fundamental experiment light from a point O (fig. 1) falls upon an isosceles prism of glass BCD, with the angle at C very little less than two right

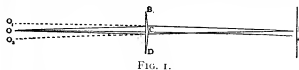

FIG. 1.

angles. The source of light may be a pin-hole through which sunlight enters a dark room, or, more conveniently, the image of the sun formed by a lens of short focus (1 or 2 in.). For actual experiment when, as usually happens, it is desirable to economize light, the point may be replaced by a line of light perpendicular to the plane of the diagram, obtained either from a linear source, such as the filament of an incandescent electric lamp, or by admitting light through a narrow vertical slit.

If homogeneous light be used, the light which passes through the prism will consist of two parts, diverging as if from points  $O_1$  and  $O_2$ , symmetrically situated on opposite sides of the line OC. Suppose a sheet of paper to be placed at A with its plane perpendicular to the line OCA, and let us consider what illumination will be produced at different parts of this paper. As  $O_1$  and  $O_2$  are images of O, crests of waves must be supposed to start from them simultaneously. Hence they will arrive simultaneously at A, which is equidistant from them, and there they will reinforce one another. Thus there will be a bright band on the paper parallel to the edges of the prism. If  $P_1$  be chosen so that the difference between  $P_1O_1$  and  $P_1O_2$  is half a wave-length (i.e. half the distance between two successive crests), the two streams of light will constantly meet in such relative conditions as to destroy one another. Hence there will be a line of darkness on the paper, through  $P_1$ , parallel to the edges of the prism. At  $P_2$ , where  $O_2P_2$  exceeds  $O_1P_2$  by a whole wave-length, we have another bright band; and at  $P_3$ , where  $O_2P_3$  exceeds  $O_1P_3$  by a wave-length and a half, another dark band; and so on. Hence, as everything is symmetrical about the bright band through A, the screen will be illuminated by a series of bright and dark bands, gradually shading into one another. If the paper screen be moved parallel to itself to the right, the locus of all the successive positions of any one band will be (by the nature of the curve) obviously an hyperbola whose foci are  $O_1$  and  $O_2$ . Thus the interval between any two bands will increase in a more rapid ratio than does the distance of the screen from the source of light. But the intensity of the bright bands diminishes rapidly as the screen moves farther off; so that, in order to measure their distance from A, it is better to substitute the eye (furnished with a convex lens) for the screen. If we thus measure the distance AP<sub>1</sub> between A and the nearest bright band, measure also AO, and calculate (from the known material and form of the prism, and the distance CO) the distance  $CO_1$ , it is obvious that we can deduce from them the lengths of  $O_1P_1$  and  $O_2P_1$ . Their difference is the length of a wave of the homogeneous light experimented with. Though this is not the method actually employed for the purpose (as it admits of little precision), it has been thus fully explained here because it shows in a very simple way the possibility of measuring a wave-length.

The difference between  $O_1P_1$  and  $O_2P_1$  becomes greater as AP<sub>1</sub> is greater. Thus it is clear that the bands are more widely separated the longer the wave-length of the homogeneous light employed. Hence

when we use white light, and thus have systems of bands of every visible wave-length superposed, the band  $A$  will be red at its edges, the next bright bands will be blue at their inner edges and red at their outer edges. But, after a few bands are passed, the bright bands due to one kind of light will gradually fill up the dark bands due to another; so that, while we may count hundreds of successive bright and dark bars when homogeneous light is used, with white light the bars become gradually less and less defined as they are farther from  $\lambda$ , and finally merge into an almost uniform white illumination of the screen.

If  $D$  be the distance from  $O$  to  $A$ , and  $P$  be a point on the screen in the neighbourhood of  $A$ , then approximately

$$O_1P - O_2P = \sqrt{D^2 + (u + \frac{1}{2}\lambda)^2} - \sqrt{D^2 + (u - \frac{1}{2}\lambda)^2} = u\lambda/D,$$

where  $O_1O_2 = b$ ,  $AP = u$ .

Thus, if  $\lambda$  be the wave-length, the places where the phases are accordant are given by

$$u = n\lambda D/b \quad (1),$$

$n$  being an integer.

If the light were really homogeneous, the successive fringes would be similar to one another and unlimited in number; moreover there would be no place that could be picked out by inspection as the centre of the system. In practice  $\lambda$  varies, and (as we have seen) the only place of complete accord for all kinds of light is at  $A$ , where  $u=0$ . Theoretically, there is no place of complete discordance for all kinds of light, and consequently no complete blackness. In consequence, however, of the fact that the range of sensitiveness of the eye is limited to less than an "octave," the centre of the first dark band (on either side) is sensibly black, even when white light is employed; but it should be carefully remarked that the existence of even one band is due to selection, and that the formation of several visible bands is favoured by the capability of the retina to make chromatic distinctions within the visible range.

The number of perceptible bands increases *pari passu* with the approach of the light to homogeneity. For this purpose there are two methods that may be used.

We may employ light, such as that from the soda flame, which possesses *ab initio* a rather high degree of homogeneity. If the range of wave-lengths included be  $\pm \frac{1}{2}\lambda$ , a corresponding number of interference fringes may be made visible. The above was the number obtained by A. H. L. Fizeau. Using vacuum tubes containing, for example, mercury or cadmium vapour, A. A. Michelson has been able to go much farther. The narrowness of the bright line of light seen in the spectroscope, and the possibility of a large number of Fresnel's bands, depend upon precisely the same conditions; the one is in truth as much an interference phenomenon as the other.

In the second method the original light may be highly composite, and homogeneity is brought about with the aid of a spectroscope. The analogy with the first method is closest if we use the spectroscope to give us a line of homogeneous light in simple substitution for the artificial flame. Or, following J. B. L. Foucault and Fresnel, we may allow the white light to pass, and subsequently analyse the mixture transmitted by a narrow slit in the screen upon which the interference bands are thrown. In the latter case we observe a channelled spectrum, with maxima of brightness corresponding to the wave-lengths  $b\lambda/(nD)$ . In either case the number of bands observable is limited solely by the resolving power of the spectroscope, and proves nothing with respect to the regularity, or otherwise, of the vibrations of the original light.

In lieu of the biprism, reflectors may be invoked to double the original source of light. In one arrangement two reflected images are employed, obtained from two reflecting surfaces nearly parallel and in the same plane. Glass, preferably blackened behind, may be used, provided the incidence be made sufficiently oblique. In another arrangement, due to H. Lloyd, interference takes place between light proceeding directly from the original source, and from one reflected image. Lloyd's experiment deserves to be better known, as it may be performed with great facility and without special apparatus. Sunlight is admitted horizontally into a darkened room through a slit situated in a window-shutter, and, at a distance of 15 to 20 ft., is received at nearly grazing incidence upon a vertical  $s^2$ ab of plate glass. The length of the slab in the direction of the light should not be less than 2 or 3 in., and for some special observations may advantageously be much increased. The bands are observed on a plane through the hinder vertical edge of the slab by means of a hand-magnifying glass of from 1 to 2 in. focus. The obliquity of the reflector is, of course, to be adjusted according to the fineness of the bands required.

From the manner of their formation it might appear that under no circumstances could more than half the system be visible. But according to Sir G. B. Airy's principle (see below) the bands

may be displaced if examined through a prism. In practice all that is necessary is to hold the magnifier somewhat excentrically. The bands may then be observed gradually to detach themselves from the mirror, until at last the complete system is seen, as in Fresnel's form of the experiment.

The fringes now under discussion are those which arise from the superposition of two simple and equal trains of waves whose directions are not quite parallel. If the two directions of propagation are inclined on opposite sides of the axis of  $x$  at small angles  $\alpha$ , the expressions for two components of equal amplitude are

$$\cos \frac{2\pi}{\lambda} [Vt - x \cos \alpha - y \sin \alpha],$$

and

$$\cos \frac{2\pi}{\lambda} [Vt - x \cos \alpha + y \sin \alpha],$$

so that the resultant is expressed by

$$2 \cos \frac{2\pi y \sin \alpha}{\lambda} \cos \frac{2\pi}{\lambda} [Vt - x \cos \alpha],$$

from which it appears that the vibrations advance parallel to the axis of  $x$ , unchanged in type, and with a uniform velocity  $V \cos \alpha$ . Considered as depending on  $y$ , the vibration is a maximum when  $y \sin \alpha$  is equal to  $0, \lambda, 2\lambda, 3\lambda$ , &c., corresponding to the centres of the bright bands, while for intermediate values  $\frac{1}{2}\lambda, \frac{3}{2}\lambda$ , &c., there is no vibration.

From (1) we see that the linear width  $\Lambda$  of the bands, reckoned from bright to bright or dark to dark, is

$$\Lambda = \lambda D/b \quad (2).$$

The degree of homogeneity necessary for the approximate perfection of the  $n^{\text{th}}$  Fresnel's band may be found at once from (1) and (2). For if  $\delta u$  be the change in  $u$  corresponding to the change  $\delta \lambda$ , then

$$\delta u/\lambda = n\delta\lambda/\lambda \quad (3).$$

Now clearly  $\delta u$  must be a small fraction of  $\Lambda$ , so that  $\delta\lambda/\lambda$  may be many times smaller than  $1/n$ , if the darkest places are to be sensibly black. But the phenomenon will be tolerably well marked if the proportional range of wave-length do not exceed  $1/2n$ , provided that is, that the distribution of illumination over this range be not concentrated towards the extreme parts.

So far we have supposed the sources at  $O_1, O_2$  to be mathematically small. In practice, the source is an elongated slit, whose direction requires to be carefully adjusted to parallelism with the reflecting surface or surfaces. By this means an important advantage is gained in respect of brightness without loss of definition, as the various parts of the aperture give rise to coincident systems of bands.

The question of the admissible width of the slit requires consideration. We will suppose that the light issuing from various parts of the aperture is without permanent phase-relations, as when the slit is backed immediately by a flame, or by an incandescent filament. Regular interference can then only take place between light coming from corresponding parts of the two images, and a distinction must be drawn between the two ways in which the images may be situated relatively to one another. In Fresnel's experiment, whether carried out with the mirrors or with the biprism, the corresponding parts of the images are on the same side; that is, the right of one corresponds to the right of the other, and the left of the one to the left of the other. On the other hand, in Lloyd's arrangement the reflected image is reversed relatively to the original source; the two outer edges corresponding, as also the two inner. Thus in the first arrangement the bands due to various parts of the slit differ merely by a lateral shift, and the condition of distinctness is simply that the projection of the width of the slit be a small fraction of the width of the bands. From this it follows as a corollary that the limiting width is independent of the order of the bands under examination. It is otherwise in Lloyd's method. In this case the centres of the systems of bands are the same, whatever part of the slit is supposed to be operative, and it is the distance apart of the images ( $b$ ) that varies. The bands corresponding to the various parts of the slit are thus upon different scales, and the resulting confusion must increase with the order of the bands. From (1) the corresponding changes in  $u$  and  $b$  are given by

$$\delta u/\lambda = -n\lambda D \delta b/b^2;$$

so that

$$\delta u/\lambda = -n \delta b/b \quad (4).$$

If  $\delta b$  represents twice the width of the slit, (4) gives a measure of the resulting confusion in the bands. The important point is that the slit must be made narrower as  $n$  increases if the bands are to retain the same degree of distinctness.

§ 6. *Achromatic Interference Bands.*—We have already seen that in the ordinary arrangement, where the source is of white light entering through a narrow slit, the heterogeneity of the light forbids the visibility of more than a few bands. The scale

of the various band-systems is proportional to  $\lambda$ . But this condition of things, as we recognize from (2) (see § 5), depends upon the constancy of  $b$ , *i.e.* upon the supposition that the various kinds of light all come from the same place. Now there is no reason why such a limitation need be imposed. If we regard  $b$  as variable, we see that we have only to take  $b$  proportional to  $\lambda$ , in order to render the band-interval  $\Delta$  independent of colour. In such a case the system of bands is *achromatic*, and the heterogeneity of the light is no obstacle to the formation of visible bands of high order.

These requirements are very easily met by the use of Lloyd's mirrors, and of a diffraction grating (see DIFFRACTIONS) with which to form a spectrum. White light enters the dark room through a slit in the window-shutter, and falls in succession upon a grating and an achromatic lens, so as to form a real diffraction spectrum, or rather a series of such, in the focal plane. The central image and all the lateral coloured images except one are intercepted by a screen. The spectrum which is allowed to pass is the proximate source of light in the interference experiment, and since the deviation of any colour from the central white image is proportional to  $\lambda$ , it is only necessary to arrange the mirror so that its plane passes through the white image in order to realize the conditions for the formation of achromatic bands.

When a suitable grating is at hand, the experiment in this form succeeds very well. If we are satisfied with a less perfect fulfilment of the achromatic conditions, the diffraction spectrum may be replaced by a prismatic one, so arranged that  $d(\lambda/b) = 0$  for the most luminous rays. The bands are then achromatic in the sense that the ordinary telescope is so. In this case there is no objection to a merely virtual spectrum, and the experiment may be very simply executed with Lloyd's mirror and a prism of (say)  $20^\circ$  held just in front of it.

The number of black and white bands shown by the prism is not so great as might be expected. The lack of contrast that soon supervenes can only be due to imperfect superposition of the various component systems. That the fact is so is at once proved by observing according to the method of Fizeau; for the spectrum from a slit at a very moderate distance out is seen to be traversed by bands. If the adjustment has been properly made, a certain region in the yellow-green is uninterrupted, while the closeness of the bands increases towards the other end of the spectrum. So far as regards the red and blue rays, the original bands may be considered to be already obliterated, but so far as regards the central rays, to be still fairly defined. Under these circumstances it is remarkable that so little colour should be apparent on direct inspection of the bands. It would seem that the eye is but little sensitive to colours thus presented, perhaps on account of its own want of achromatism.

§ 7. *Airy's Theory of the White Centre.*—If a system of Fresnel's bands be examined through a prism, the central white band undergoes an abnormal displacement, which has been supposed to be inconsistent with theory. The explanation has been shown by Airy (*Phil. Mag.*, 1833, 2, p. 161) to depend upon the peculiar manner in which the white band is in general formed.

"Any one of the kinds of homogeneous light composing the incident heterogeneous light will produce a series of bright and dark bars, unlimited in number as far as the mixture of light from the two pencils extends, and undistinguishable in quality. The consideration, therefore, of homogeneous light will never enable us to determine which is the point that the eye immediately turns to as the centre of the fringes. What then is the physical circumstance that determines the centre of the fringes?"

"The answer is very easy. For different colours the bars have different breadths. If then the bars of all colours coincide at one part of the mixture of light, they will not coincide at any other part; but at equal distances on both sides from that place of coincidence they will be equally far from a state of coincidence. If then we can find where the bars of all colours coincide, that point is the centre of the fringes."

"It appears then that the centre of the fringes is *not* necessarily the point where the two pencils of light have described equal paths, but is determined by considerations of a perfectly different kind. . . . The distinction is important in this and in other experiments."

The effect in question depends upon the dispersive power of the prism. If  $v$  be the linear shifting due to the prism of the originally central band,  $v$  must be regarded as a function of  $\lambda$ . Measured from the original centre, the position of the  $n^{\text{th}}$  bar is now

$$v + n\lambda D/b.$$

The coincidence of the various bright bands occurs when this quantity is as independent as possible of  $\lambda$ , that is, when  $n$  is the nearest integer to

$$n = -\frac{b}{\lambda} \frac{dv}{d\lambda} \quad (1);$$

The apparent displacement of the white band is thus not simply, but

$$v - \Delta v/d\lambda \quad (2).$$

The signs of  $dv$  and  $d\lambda$  being opposite, the abnormal displacement is in addition to the normal effect of the prism. But, since  $dv/d\lambda$ , or  $d\lambda/d\lambda$ , is not constant, the achromatism of the white band is less perfect than when no prism is used.

If a grating were substituted for the prism,  $v$  would vary as  $\lambda$ , and (2) would vanish, so that in all orders of spectra the white band would be seen undisturbed.

In optical experiments two trains of waves can interfere only when they have the same origin in the same source. Otherwise, as it is usually put, there can be no permanent phase-relation, and therefore no regular interference. It should be understood, however, that this is only because trains of optical waves are never absolutely homogeneous. A really homogeneous train could maintain a permanent phase-relation with another such train, and it may be added, would of necessity be polarized in its character. The peculiarities of polarized light with respect to interference are treated under POLARIZATION OF LIGHT.

In a classical experiment interference-bands were employed to examine whether light moved faster or slower in glass than in air. For this purpose a very thin piece of glass may be interposed in the path of one of the interfering rays, and the resulting displacement of the bands is such as to indicate that the light passing through the glass is *retarded*. In a better form of the experiment two pieces of parallel glass cut from the same plate are interposed between the prism and the screen, so that the rays from  $O_1$  (fig. 1) pass through one part and those from  $O_2$  through the other. So long as these pieces are parallel, no shifting takes place, but if one be slightly turned, the bands are at once displaced. In the absence of dispersion the retardation due to the plate would be independent of  $\lambda$ , and therefore completely compensated at the point determined by  $\lambda = DR/b$ ; but when there is dispersion it is accompanied by a fictitious displacement of the fringes on the principle explained by Airy, as was shown by Stokes.

Before quitting this subject it is proper to remark that Fresnel's bands are more influenced by diffraction than their discoverer supposed. On this account the fringes are often unequally broad and undergo fluctuations of brightness. A more precise calculation has been given by H. F. Weber and by H. Struve, but the matter is too complicated to be further considered here. The observations of Struve appear to agree well with the corrected theory.

§ 8. *Colours of Thin Plates.*—These colours, familiarly known as those of the soap-bubble, are seen under a variety of conditions and were studied with some success by Robert Hooke after the name of "fantastical colours" (*Micrographia*, 1664). The inquiry was resumed by Sir Isaac Newton with his accustomed power ("Discourse on Light and Colours," 1675, *Opticks*, book ii.), and by him most of the laws regulating these phenomena were discovered. Newton experimented especially with thin plates of air enclosed by slightly curved glasses, and the coloured rings so exhibited are usually called after him "Newton's rings."

The colours are manifested in the greatest purity when the reflecting surfaces are limited to those which bound the thin film. This is the case of the soap-bubble. When, as is in other respects more convenient, two glass plates enclosing a film of air are substituted, the light under examination is liable to be contaminated by that reflected from the outer surfaces. A remedy may be found in the use of wedge-shaped glasses so applied that the outer surfaces, though parallel to one another, are inclined to the inner operating surfaces. By suitable optical arrangements the two portions of light, which are undesired, may then be separated.

In his first essay upon this subject Thomas Young was able to trace the formation of these colours as due to the interference of light reflected from the two surfaces of the plate; or, as it would be preferable to say, to the superposition of the two reflected vibrations giving resultants of variable magnitude according to the phase-relation. A difficulty here presents itself which might have proved insurmountable to a less acute inquirer. The luminous vibration reflected at the second surface travels a distance increased by twice the thickness of the plate, and it might naturally be supposed that the relative retardation would be measured by this quantity. If this were so, the two vibrations reflected from the surfaces of an infinitely thin plate would be in accordance, and the intensity of the resultant a maximum. The facts were notoriously the reverse. At the place of contact of Newton's glasses, or at the thinnest part of a soap-film just before it bursts, the colour is black and not white as the explanation seems to require. Young saw that the reconciliation lies in the circumstance that the two reflections occur under different conditions, one, for example, as the light passes from air to water, and the second as it passes from water to air. According to mechanical principles the second reflection involves a change of sign, equivalent to a gain or loss of half an undulation. When a



series of waves constituting any particular coloured light is reflected from an infinitely thin plate, the two partial reflections are in absolute discordance and, if of equal intensity, must give an superposition complete darkness. With the aid of this principle the sequence of colours in Newton's rings is explained in much the same way as that of interference fringes (above, § 5).

The complete theory of the colours of thin plates requires us to take account not merely of the two reflections already mentioned

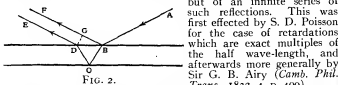

FIG. 2.

In fig. 2, ABF is the ray, perpendicular to the wave-front, reflected at the upper surface, ABCDE the ray transmitted at B, reflected at C and transmitted at D; and these are accompanied by other rays reflected internally 3, 5, &c., times. The first step is to calculate the retardation  $\delta$  between the first and second waves, so far as it depends on the distances travelled in the plate (of index  $\mu$ ) and in air.

If the angle ABF =  $2a$ , angle BCD =  $2a'$  and the thickness of plate =  $t$ , we have

$$\delta = \mu(BC + CD) - BG \\ = 2\mu BC - 2BC \sin a \sin a' = 2\mu BC(1 - \sin^2 a') \\ = 2\mu t \cos a \quad (1).$$

In (1)  $a'$  is the angle of refraction, and we see that, contrary to what might at first have been expected, the retardation is least when the obliquity is greatest, and reaches a maximum when the obliquity is zero or the incidence normal. If we represent all the vibrations by complex quantities, from which finally the imaginary parts are rejected, the retardation  $\delta$  may be expressed by the introduction of the factor  $e^{i\delta}$ , where  $i = \sqrt{-1}$ , and  $\kappa = 2\pi/\lambda$ .

At each reflection or refraction the amplitude of the incident wave must be supposed to be altered by a certain factor which allows room for the reversal postulated by Young. When the light proceeds from the surrounding medium to the plate, the factor for reflection will be supposed to be  $b$ , and for refraction  $c$ ; the corresponding quantities when the progress is from the plate to the surrounding medium will be denoted by  $e, f$ . Denoting the incident vibration by unity, we have then for the first component of the reflected wave  $b$ , for the second  $cefbe^{i\delta}$ , for the third  $cfefc^2be^{2i\delta}$ , and so on. Adding these together, and summing the geometric series, we find

$$b + \frac{cfefc^2be^{i\delta}}{1 - e^{2i\delta}} \quad (2).$$

In like manner for the wave transmitted through the plate we get

$$\frac{cf}{1 - e^{2i\delta}} \quad (3).$$

The quantities  $b, c, e, f$  are not independent. The simplest way to find the relations between them is to trace the consequences of supposing  $\delta = 0$  in (2) and (3). This may be regarded as a development from Young's point of view. A plate of vanishing thickness is ultimately no obstacle at all. In the nature of things a surface cannot reflect. Hence with a plate of vanishing thickness there must be a vanishing reflection and a total transmission, and accordingly

$$b + e = 0, \quad cf = 1 - e^2 \quad (4),$$

the first of which embodies Arago's law of the equality of reflections, as well as the famous "loss of half an undulation." Using these we find for the reflected vibration,

$$-\frac{e(1 - e^{2i\delta})}{1 - e^{2i\delta} - e^{i\delta}} \quad (5),$$

and for the transmitted vibration

$$\frac{1 - e^2}{1 - e^{2i\delta} - e^{i\delta}} \quad (6).$$

The intensities of the reflected and transmitted lights are the squares of the moduli of these expressions. Thus

$$\text{Intensity of reflected light} = e^2 \frac{(1 - \cos \delta)^2 + \sin^2 \delta}{(1 - e^2 \cos \delta)^2 + e^2 \sin^2 \delta} \\ = \frac{4e^2 \sin^2(\frac{1}{2}\delta)}{1 - 2e^2 \cos \delta + e^4} \quad (7);$$

$$\text{Intensity of transmitted light} = \frac{(1 - e^2)^2}{1 - 2e^2 \cos \delta + e^4} \quad (8),$$

the sum of the two expressions being unity.

According to (7), not only does the reflected light vanish completely when  $\delta = 0$ , but also whenever  $\frac{1}{2}\delta = n\pi$ ,  $n$  being an integer, that is, whenever  $\delta = 2n\lambda$ . When the first and third mediums are

the same, as we have here supposed, the central spot in the system of Newton's ring is black, even though the original light contain a mixture of all wave-lengths. If the light reflected from a plate of any thickness be examined with a spectroscope of sufficient resolving power, the spectrum will be traversed by dark bands, of which the centre corresponds to those wave-lengths which the plate is incompetent to reflect. It is obvious that there is no limit to the fineness of the bands which may be thus impressed upon a spectrum, whatever may be the character of the original mixed light.

The relations between the factors  $b, c, e, f$  have been proved, independently of the theory of thin plates, in a general manner by Stokes, who called to his aid the general mechanical principle of reversibility. If the motions constituting the reflected and refracted rays to which an incident ray gives rise be supposed to be reversed, they will reconstitute a reversed incident ray. This gives one relation; and another is obtained from the consideration that there is no ray in the second medium, such as would be generated by the operation alone of either the reversed reflected or refracted rays. Space does not allow of the reproduction of the argument at length, but a few words may perhaps give the reader an idea of how the conclusions are arrived at. The incident ray (IA) (fig. 3) being 1, the reflected (AR) and refracted (AF) rays are denoted by  $b$  and  $c$ . When  $b$  is reversed, it gives rise to a reflected ray  $b' = a$ , and a refracted ray  $bc$  along AG (say). When  $c$  is reversed, it gives rise to  $c'$  along AI, and  $ce$  along AG. Hence  $bc + ce = 0$ ,  $b^2 + c^2 = 1$ , which agree with (4). It is here assumed that there is no change of phase in the act of reflection or refraction, except such as can be represented by a change of sign.



FIG. 3.

When the third medium differs from the first, the theory of thin plates is more complicated, and need not here be discussed. One particular case, however, may be mentioned. When a thin transparent film is backed by a perfect reflector, no colours should be visible, all the light being ultimately reflected, whatever the wave-length may be. The experiment may be tried with a thin layer of gelatin on a polished silver plate. In other cases where a different result is observed, the inference is that either the metal does not reflect perfectly, or else that the material of which the film is composed is not sufficiently transparent. Some apparent exceptions to the above rule, exhibited by thin films of collodion resting upon silver surfaces, have been described by R. W. Wood (*Physical Optics*, p. 443), who attributes the very curious effects observed to *frilling* of the collodion film.

For study of the colours of thin plates there are no more interesting subjects than the soap-film. For projection the films may be stretched across vertical rings of iron wire coated with paraffin. In their undisturbed condition they thin from the top, and the colours are disposed in horizontal bands. If, as suggested by Brewster, a jet of wind issuing from a small nozzle and supplied from a well-regulated bellows be added to impinge obliquely, parts of the film are set in rotation, and displays of colours may be exhibited to a large audience, astonishing by their brilliance and by the rapidity with which they change. Permanent films, analogous to soap-films, are best obtained by Glew's method. A few drops of celluloid varnish are poured upon the surface of water contained in a large dish. After evaporation of the solvent, the films may be picked up upon rings of iron wire.

As a variant upon Newton's rings, interesting effects may be obtained by the partial etching of the surfaces of picked pieces of plate-glass. A surface is coated in parallel stripes with paraffin wax and treated with dilute hydrofluoric acid for such a time (found by preliminary trials) as is required to eat away the exposed portions to a depth of one quarter of the mean wave-length of light. Two such prepared surfaces pressed in the crossed position into suitable contact exhibit a chess-board pattern. Where two uncorroded, or where two corroded, parts overlap, the colours are nearly the same; but where a corroded and an uncorroded surface meet, a strongly contrasted colour is revealed. This combination lends itself to projection and the pattern seen upon the screen very beautiful if proper precautions are taken to eliminate the white light reflected from the first and fourth surfaces of the plates (see *Nature*, 1901, 64, 385).

The theory and observation alike show that the transmitted colours of a thin plate, e.g. a soap film or a layer of air, are very inferior to those reflected. Specimens of ancient glass, which have undergone superficial decomposition, on the other hand, sometimes show transmitted colours of remarkable brilliancy. The probable explanation, suggested by Brewster, is that we have here to deal not merely with one, but with a series of thin plates of very different thicknesses. It is evident that with such a series the transmitted colours would be much purer, and the reflected much brighter, than usual. If the thicknesses are strictly equal, certain wave-lengths must still be absolutely missing in the reflected light; while on the other hand a constancy of the interval between the plates will in general lead to a special preponderance of light of some other wave-length for which the component parts as they ultimately emerge are in agreement as to phase.

On the same principle are doubtless to be explained the colours of fiery opals, and, more remarkable still, the iridescence of certain

crystals of potassium chlorate. Stokes showed that the reflected light is often in a high degree monochromatic, and that it is connected with the existence of twin planes. A closer discussion appears to show that the twin planes must be repeated in a periodic manner (*Phil. Mag.*, 1888, 26, 241, 256; also see R. W. Wood, *Phil. Mag.*, 1906).

A beautiful example of a similar effect is presented by G. Lippman's coloured photographs. In this case the periodic structure is actually the product of the action of light. The plate is exposed to stationary waves, resulting from the incidence of light upon a reflecting surface (see PHOTOGRAPHY).

All that can be expected from a physical theory is the determination of the composition of the light reflected from or transmitted by a thin plate in terms of the composition of the incident light. The further question of the chromatic character of the mixtures thus obtained belongs rather to physiological optics, and cannot be answered without a complete knowledge of the chromatic relations of the spectral colours themselves. Experiments upon this subject have been made by various observers, and especially by J. Clerk Maxwell (*Phil. Trans.*, 1860), who has exhibited his results on a colour diagram as used by Newton. A calculation of the colours of thin plates, based upon Maxwell's data, and accompanied by a drawing showing the curve representative of the entire series up to the fifth order, has been given by Rayleigh (*Edin. Trans.*, 1887). The colours of Newton's scale are met with also in the light transmitted by a somewhat thin plate of doubly-refracting material, such as mica, the plane of analysis being perpendicular to that of primitive polarization.

The same series of colours occur also in other optical experiments, e.g., at the centre of the illuminated area when light issuing from a point passes through a small round aperture in an otherwise opaque screen.

The colours of which we have been speaking are those formed at nearly perpendicular incidence, so that the retardation (reckoned as a distance), viz.  $2\mu \cos \alpha'$ , as sensibly independent of  $\lambda$ . This state of things may be greatly departed from when the thin plate is rarer than its surroundings, and the incidence is such that  $\alpha'$  is nearly equal to  $90^\circ$ , for then, in consequence of the powerful dispersion,  $\cos \alpha'$  may vary greatly as we pass from one colour to another. Under these circumstances the series of colours entirely alters its character, and the bands (corresponding to a graduated thickness) may even lose their coloration, becoming sensibly black and white through many alternations (Newton's *Opticks*, bk. ii.; Fox-Talbot, *Phil. Mag.*, 1836, 9, p. 401). The general explanation of this remarkable phenomenon is given by Brewster.

Let us suppose that plane waves of white light travelling in glass are incident at angle  $\alpha$  upon a plate of air, which is bounded again on the other side by glass. If  $\mu$  be the index of the glass,  $\alpha'$  the angle of refraction, then  $\sin \alpha' = \mu \sin \alpha$ , and the retardation, expressed by the equivalent distance in air, is

$$2t \sec \alpha' - \mu. 2t \tan \alpha' \sin \alpha = 2t \cos \alpha';$$

and the retardation in phase is  $2t \cos \alpha' / \lambda$ ,  $\lambda$  being as usual the wave-length in air.

The first thing to be noticed is that, when  $\alpha$  approaches the critical angle,  $\cos \alpha'$  becomes as small as we please, and that consequently the retardation corresponding to a given thickness is very much less than at perpendicular incidence. Hence the glass surfaces need not be so close as usual.

A second feature is the increased brilliancy of the light. According to (7) the intensity of the reflected light when at a maximum ( $\sin \frac{1}{2}\alpha = 1$ ) is  $4e^2/(1+e^2)^2$ . At perpendicular incidence  $e$  is about  $\frac{1}{2}$ , and the intensity is somewhat small; but, as  $\cos \alpha'$  approaches zero,  $e$  approaches unity, and the brilliancy is much increased.

But the peculiarity which most demands attention is the lessened influence of a variation in  $\lambda$  upon the phase-retardation. A diminution of  $\lambda$  of itself increases the retardation of phase, but, since waves of shorter wave-length are more refrangible, this effect may be more or less perfectly compensated by the greater obliquity, and consequent diminution in the value of  $\cos \alpha'$ . We will investigate the conditions under which the retardation of phase is stationary in spite of a variation of  $\lambda$ .

In order that  $\lambda^{-1} \cos \alpha'$  may be stationary, we must have

$$\lambda \sin \alpha' d\alpha' + \cos \alpha' d\lambda = 0,$$

where ( $\alpha$  being constant)

$$\cos \alpha' d\alpha' = \sin \alpha' d\mu.$$

Thus

$$\cot \alpha' d\alpha' = -\frac{\lambda d\mu}{\mu d\lambda} \quad (9),$$

giving  $\alpha'$  when the relation between  $\mu$  and  $\lambda$  is known.

According to A. L. Cauchy's formula, which represents the facts very well throughout most of the visible spectrum,

$$\mu = A + B\lambda^{-2} \quad (10),$$

so that

$$\cot \alpha' = \frac{2B}{\lambda^2} = \frac{2(\mu - A)}{\mu} \quad (11).$$

If we take, as for Chance's "extra-dense flint,"  $B = -984 \times 10^{-10}$ , and us for the soda lines,  $\mu = 1.65$ ,  $\lambda = 5.89 \times 10^{-7}$ , we get

$$\alpha' = 79^\circ 30'.$$

At this angle of refraction, and with this kind of glass, the retardation of phase is accordingly nearly independent of wave-length, and therefore the bands formed, as the thickness varies, are approximately achromatic. Perfect achromatism would be possible only under a law of dispersion

$$\mu^2 = A' - B'\lambda^2.$$

If the source of light be distant and very small, the black bands are wonderfully fine and numerous. The experiment is best made (after Newton) with a right-angled prism, whose hypotenusal surface may be brought into approximate contact with a plate of black glass. The bands should be observed with a convex lens, of about 8 in. focus. If the eye be at twice this distance from the prism, and the lens be held midway between, the advantages are combined of a large field and of maximum distinctness.

If Newton's rings are examined through a prism, some very remarkable phenomena are exhibited, described in his twenty-fourth observation (*Opticks*; see also *Place, Pogg. Ann.*, 1861, 114, 504). "When the two object-glasses are laid upon one another, so as to make the rings of the colours appear, though with my naked eye I could not discern above eight or nine of those rings, yet by viewing them through a prism I could see a far greater multitude, inasmuch that I could number more than forty. . . . And I believe that the experiment may be improved to the discovery of far greater numbers. . . . But it was on but one side of these rings, namely, that towards which the refraction was made, which by the refraction was rendered distinct, and the other side became more confused than when viewed with the naked eye. . . ."

"I have sometimes so laid one object-glass upon the other that to the naked eye they have all over seemed uniformly white, without the least appearance of any of the coloured rings; and yet by viewing them through a prism great multitudes of those rings have discovered themselves.

Newton was evidently much struck with these "so odd circumstances"; and he explains the occurrence of the rings at unusual thicknesses as due to the dispersing power of the prism. The blue system being more refracted than the red, it is possible under certain conditions that the  $n^{\text{th}}$  blue ring may be so much displaced relatively to the corresponding red ring as *at one part of the circumference* to compensate for the different diameters. A white stripe may thus be formed in a situation where without the prism the mixture of colours would be complete, so far as could be judged by the eye.

The simplest case that can be considered is when the "thin plate" is bounded by plane surfaces inclined to one another at a small angle. By drawing back the prism (whose edge is parallel to the intersection of the above-mentioned planes) it will always be possible so to adjust the effective dispersing power as to bring the  $n^{\text{th}}$  blue to coincidence for any two assigned colours, and therefore approximately for the entire spectrum. The formation of the achromatic band, or rather central black band, depends indeed upon the same principles as the fictitious shifting of the centre of a system of Fresnel's bands when viewed through a prism.

But neither Newton nor, as will appear, any of his successors has explained why the bands should be more numerous than usual, and under certain conditions sensibly achromatic for a large number of alternations. It is evident that, in the particular case of the wedge-shaped plate above specified, such a result would not occur. The width of the bands for any colour would be proportional to  $\lambda$ , as well after the displacement by the prism as before; and the succession of colours formed in white light and the number of perceptible bands would be much as usual.

The peculiarities to be explained appears to depend upon the curvature of the surfaces bounding the plate. For simplicity suppose that the lower surface is plane ( $y=0$ ), and that the approximate equation of the upper surface is  $y = a + bx^2$ ,  $a$  being thus the least distance between the plates. The black of the  $n^{\text{th}}$  order for wave-length  $\lambda$  occurs when

$$\frac{1}{2}\lambda n = a + bx^2 \quad (12);$$

and thus the width ( $\delta x$ ) at this place of the band is given by

$$\frac{1}{2}\lambda = 2bx\delta x \quad (13);$$

or

$$\delta x = \frac{\lambda}{2bx} = \frac{\lambda}{4\sqrt{b} \cdot \sqrt{\frac{1}{2}\lambda n - a}} \quad (14).$$

If the glasses be in contact, as is usually supposed in the theory of Newton's rings,  $a=0$ , and  $\delta x \propto \lambda^{-1/2}$ , or the width of the band of the  $n^{\text{th}}$  order varies as the square root of the wave-length, instead of as the first power. Even in this case the overlapping and subsequent obliteration of the bands is greatly retarded by the use of the prism, but the full development of the phenomenon requires that  $a$  should be finite. Let us inquire what is the condition in order that the width of the band of the  $n^{\text{th}}$  order may be stationary, as  $\lambda$  varies. By (14) it is necessary that the variation of  $\lambda/(\frac{1}{2}\lambda n - a)$  should vanish. Hence  $a = \frac{1}{2}\lambda n$ , so that the interval between the surfaces at the place where the  $n^{\text{th}}$  band is formed should be half due to curvature and half to imperfect contact at the place of closest approach. If this condition be satisfied, the achromatism of the  $n^{\text{th}}$  band, effected by the prism, carries with it the achromatism of a large number of neighbouring bands, and thus gives rise to the remarkable effects described by Newton. Further developments

are given by Lord Rayleigh in a paper "On Achromatic Interference Bands" (*Phil. Mag.*, 1889, 28, pp. 77, 189); see also E. Mascart, *Traité d'optique*.

In Newton's rings the variable element is the thickness of the plate, to which the retardation is directly proportional, and in the ideal case the angle of incidence is constant. To observe them the eye is focused upon the thin plate itself, and if the plate is very thin no particular precautions are necessary. As the plate thickens and the order of interference increases, there is more and more demand for homogeneity in the light, and we may have recourse to a sodium-flame or a helium vacuum tube. At the same time the disturbing influence of obliquity increases. Unless the aperture of the eye is reduced, the rays reaching it from even the same point of the plate are differently affected, and complications ensue tending to impair the distinctness of the bands. To obviate this disturbance it is best to work at incidences as nearly as possible perpendicular.

The bands seen when light from a soda flame falls upon nearly parallel surfaces are often employed as a test of flatness. Two flat

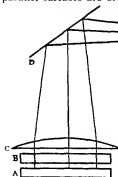

FIG. 4.

surfaces can be made to fit, and then the bands are few and broad, if not entirely absent; and, however the surfaces may be presented to one another, the bands should be straight, parallel and equidistant. If this condition be violated, one or other of the surfaces deviates from flatness. In fig. 4, A and B represent the glasses to be tested, and C is a lens of 2 or 3 ft. focal length. Rays diverging from a soda flame at E are rendered parallel by the lens, and after reflection from the surfaces are recombined by the lens at E.

To make an observation, the coincidence of the radiant point and its image must be somewhat disturbed, the one being displaced to a position a little beyond, and the other to a position a little in front of the diagram. The eye, protected from the flame by a suitable screen, is placed at the image, and being focused upon AB, sees the field traversed by bands. The reflector D is introduced as a matter of convenience to make the line of vision horizontal.

These bands may be photographed. The lens of the camera takes the place of the eye, and should be as close to the flame as possible. With suitable plates, sensitized by cyanin, the exposure required may vary from ten minutes to an hour. To get the best results, the hinder surface of A should be blackened, and the front surface of B should be thrown out of action by the superposition of a wedge-shaped plate of glass, the intervening space being filled with oil of turpentine or other fluid having nearly the same refraction as glass. Moreover, the light should be purified from blue rays by a trough containing solution of bichromate of potash. With these precautions the dark parts of the bands are very black, and the exposure may be prolonged much beyond what would otherwise be admissible.

By this method it is easy to compare one flat with another, and thus, if the first be known to be free from error, to determine the errors of the second. But how are we to obtain and verify a standard? The plan usually followed is to bring three surfaces into comparison. The fact that two surfaces can be made to fit another in all azimuths proves that they are spherical and of equal curvatures, but one convex and the other concave, the case of perfect flatness not being excluded. If A and B fit one another, and also A and C, it follows that B and C must be similar. Hence, if A and C also fit one another, all three surfaces must be flat. By an extension of this process the errors of three surfaces which are not flat can be found from a consideration of the interference bands which they present when combined in three pairs.

The free surface of undisturbed water is almost ideally flat, and, as Lord Rayleigh (*Nature*, 1893, 48, 212) has shown, there is no great difficulty in using it as a standard of comparison. Following the same idea we may construct a parallel plate by superposing a layer of water upon mercury. If desired, the superior reflecting power of the mercury may be compensated by the addition of colouring matter to the water.

*Haidinger's Rings dependent on Obliquity.*—It is remarkable that the well-known theoretical investigation, undertaken with the view of explaining Newton's rings, applies more directly to a different system of rings discovered at a later date.

The results embodied in equations (1) to (8) have application in the first instance to plates whose surfaces are absolutely parallel, though doubtless they may be employed with fair accuracy when the thickness varies but slowly.

We have now to consider  $\delta$  constant and  $a'$  variable in (1). If  $a'$  be small,

$$\delta = 2\mu(1 - \frac{1}{2}a'^2) = 2\mu t - \mu a'^2 \quad (15);$$

and since the differences of  $\delta$  are proportional to  $a'^2$ , the law of formation is the same as for Newton's rings, where  $a'$  is constant and  $t$  proportional to the square of the distance from the point of contact. In order to see these rings distinctly the eye must be focused, not upon the plate, but for infinitely distant objects.

The earliest observation of rings dependent upon obliquity appears to have been made by W. von Haidinger (*Pogg. Ann.*, 1849, 77, p. 219; 1855, 96, p. 453), who employed sodium light reflected from a plate of mica (e.g. 0.2 mm. thick). The transmitted rays are the easier to see in their completeness, though they are necessarily somewhat faint. For this purpose it is sufficient to look through the mica, held close to the eye and perpendicular to the line of vision, at a sheet of white paper or card illuminated by a sodium flame. Although Haidinger omitted to consider the double refraction of the mica and gave formulae not quite correct for even singly refracting plates, he fully appreciated the distinctive character of the rings, contrasting *Berührungsringe und Plattenringe*. The latter may appropriately be named after him. Their tardy discovery may be attributed to the technical difficulty of obtaining sufficiently parallel plates, unless it be by the use of mica or by the device of pouring water upon mercury. Haidinger's rings were rediscovered by O. R. Lummer (*Wied. Ann.*, 1884, 23, p. 49), who pointed out the advantages they offer in the examination of plates intended to be parallel.

The illumination depends upon the intensity of the monochromatic source of light, and upon the reflecting power of the surfaces. If R be the intensity of the reflected light we have from (7)

$$\frac{R}{1} = 1 + \frac{\sin^2(\frac{e^2}{2\delta})}{4e^2 \sin^2(\frac{1}{2}\delta)}$$

from which we see that if  $e=1$  absolutely,  $R=1-R=1$  for all values of  $\delta$ . If  $e=1$  very nearly,  $R=1$  nearly for all values of  $\delta$  for which  $\sin^2(\frac{1}{2}\delta)$  is not very small. In the light reflected from an extended source, the ground will be of full brightness corresponding to the source, but it will be traversed by narrow dark lines. By transmitted light the ground, corresponding to general values of the obliquity, will be dark, but will be interrupted by narrow bright rings, whose position is determined by  $\sin(\frac{1}{2}\delta)=0$ . In permitting for certain directions a complete transmission in spite of a high reflecting power ( $e$ ) of the surfaces, the plate acts the part of a resonator.

There is no transparent material for which, unless at high obliquity,  $e$  approaches unity. In C. Fabry and A. Pérot's apparatus the reflections at nearly perpendicular incidence are enhanced by lightly silvering the surfaces. In this way the advantage of narrowing the bright rings is attained in great measure without too heavy a sacrifice of light. The plate in the optical sense is one of air, and is bounded by plates of glass whose inner silvered surfaces are accurately flat and parallel. The outer surfaces need only ordinary flatness, and it is best that they be not quite parallel to the inner ones. The arrangement constitutes a *spectroscope*, inasmuch as it allows the structure of a complex spectrum line to be directly observed. If, for example, we look at a sodium flame, we see in general two distinct systems of narrow bright circles corresponding to the two D-lines. With particular values of the thickness of the plate of air the two systems may coincide so as to be seen as a single system, but a slight alteration of thickness will cause a separation.

It will be seen that in this apparatus the optical parts are themselves of extreme simplicity; but they require accuracy of construction and adjustment, and the demand in these respects is the more severe the further the ideal is pursued of narrowing the rings by increase of reflecting power. Two forms of mounting are employed. In one instrument, called the *interferometer*, the distance between the surfaces—the thickness of the plate—is adjustable over a wide range. In its complete development this instrument is elaborate and costly. The actual measurements of wave-lengths by Fabry and Pérot were for the most part effected by another form of instrument called an *etalon* or interference-gauge. The thickness of the optical plate is here fixed; the glasses are held up to metal knobs, acting as distance-pieces, by adjustable springs, and the final adjustment to parallelism is effected by regulating the pressure exerted by these springs. The distance between the surfaces may be 5 or 10 mm.

The theory of the comparison of wave-lengths by means of this apparatus is very simple, and it may be well to give it, following closely the statement of Fabry and Pérot (*Ann. chim. phys.*, 1902, 25, p. 110). Consider first the cadmium radiation  $\lambda$  treated as a standard. It gives a system of rings. Let  $P$  be the ordinal number of one of these rings, for example the first counting from the centre. This integer is supposed known. The order of interference at the centre will be  $p=P+e$ . We have to determine this number  $e$ , lying ordinarily between 0 and 1. The diameter of the ring under

consideration increases with  $\epsilon$ ; so that a measure of the diameter allows us to determine the latter. Let  $t$  be the thickness of the plate of air. The order of interference at the centre is  $\rho = 2t/\lambda$ . This corresponds to normal passage. At an obliquity  $i$  the order of interference is  $\rho \cos i$ . Thus if  $x$  be the angular diameter of the ring P,  $\rho \cos \frac{1}{2}x = P$ ; or since  $x$  is small,

$$\rho = P(1 + \frac{1}{4}x^2).$$

In like manner, from observations upon another radiation  $\lambda'$  to be compared with  $\lambda$ , we have

$$\rho' = P'(1 + \frac{1}{4}x'^2);$$

whence if  $t$  be treated as an absolute constant,

$$\frac{\lambda'}{\lambda} = \frac{P'}{P} \left(1 + \frac{x'^2}{8} - \frac{x^2}{8}\right) \quad (16).$$

The ratio  $\lambda/\lambda'$  is thus determined as a function of the angular diameters  $x, x'$  and of the integers P, P'. If P, P' say for the cadmium red line, is known, an approximate value of  $\lambda/\lambda'$  will usually suffice to determine what integral value must be assigned to P', and thence by (16) to allow of the calculation of the corrected ratio  $\lambda/\lambda'$ .

In order to find P we may employ a modified form of (16), viz.,

$$\frac{P'}{P} = \frac{\lambda}{\lambda'} \left(1 + \frac{x'^2}{8} - \frac{x^2}{8}\right) \quad (17),$$

using spectrum lines, such as the cadmium red and the cadmium green, for which the relative wave-lengths are already known with accuracy from A. A. Michelson's work. To test a proposed integral value of P (cadmium red), we calculate P' (cadmium green) from (17), using the observed values of  $x, x'$ . If the result deviates from an integer by more than a small amount (depending upon the accuracy of the observations), the proposed value of P is to be rejected. In this way by a process of exclusion the true value is ultimately arrived at (Rayleigh, *Phil. Mag.*, 1906, 685). It appears that by Fabry and Pérot's method comparisons of wave-lengths may be made accurate to about one-millionth part; but it is necessary to take account of the circumstance that the effective thickness  $t$  of the plate is not exactly the same for various wave-lengths as assumed in (16).

§ 9. *Newton's Diffusion Rings.*—In the fourth part of the second book of his *Opticks* Newton investigates another series of rings, usually (though not very appropriately) known as the colours of thick plates. The fundamental experiment is as follows. At the centre of curvature of a concave looking-glass, quicksilver behind, is placed an opaque card, perforated by a small hole through which sunlight is admitted. The main body of the light returns through the aperture; but a series of concentric rings are seen upon the card, the formation of which was proved by Newton to require the co-operation of the two surfaces of the mirror. Thus the diameters of the rings depend upon the thickness of the glass, and none are formed when the glass is replaced by a metallic speculum. The brilliancy of the rings depends upon imperfect polish of the anterior surface of the glass, and may be augmented by a coat of diluted milk, a device used by Michel Ferdinand, duc de Chaulnes. The rings may also be well observed without a screen in the manner recommended by Stokes. For this purpose all that is required is to place a small flame at the centre of curvature of the prepared glass, so as to coincide with its image. The rings are then seen surrounding the flame and occupying a definite position in space.

The explanation of the rings, suggested by Young, and developed by Herschel, refers them to interference between one portion of light scattered or diffracted by a particle of dust, and then regularly refracted and reflected, and another portion first regularly refracted and reflected and then diffracted at emergence by the same particle. It has been shown by Stokes (*Camb. Trans.*, 1851, 9, p. 147) that no regular interference is to be expected between portions of light diffracted by different particles of dust.

In the memoir of Stokes will be found a very complete discussion of the whole subject, and to this the reader must be referred who desires a fuller knowledge. Our limits will not allow us to do more than touch upon one or two points. The condition of fixity of the rings when observed in air, and of distinctness when a screen is used, is that the systems due to all parts of the diffusing surface should coincide; and it is fulfilled only when, as in Newton's experiments, the source and screen are in the plane passing through the centre of curvature of the glass.

As the simplest for actual calculation, we will consider a little further the case where the glass is plane and parallel, of thickness  $t$  and index  $\mu$ , and is supplemented by a lens at whose focus the source of light is placed. This lens acts both as collimator and as

object-glass, so that the combination of lens and plane mirror replaces the concave mirror of Newton's experiment. The retardation is calculated in the same way as for thin plates. In fig. 5 the diffracting particle is situated at B, and we have to find the relative retardation of the two rays which emerge finally at inclination  $\theta$ . The one diffracted at emergence following the path ABDBE, and the other diffracted at entrance and following the path ABFGH. The retardation of the former from B to I is  $2\mu t + BI$ , and of the latter from B to the equivalent place G is  $2\mu BF$ . Now  $FB = t \sec \theta'$ ,  $\theta'$  being the angle of refraction;  $BI = 2t \tan \theta' \sin \theta$ ; so that the relative retardation F is given by

$$R = 2\mu t \{1 - \mu^{-1} \tan \theta' \sin \theta - \sec \theta'\} = 2\mu t (1 - \cos \theta').$$

If  $\theta, \theta'$  be small, we may take

$$R = 2t\theta^2/\mu \quad (1).$$

as sufficiently approximate.

The condition of distinctness is here satisfied, since R is the same for every ray emergent parallel to a given one. The rays of one parallel system are collected by the lens to a focus at a definite point in the neighbourhood of the original source.

The formula (1) was discussed by Herschel, and shown to agree with Newton's measures. The law of formation of the rings follows immediately from the expression for the retardation, the radius of the ring of  $n^{\text{th}}$  order being proportional to  $n$  and to the square root of the wave-length.

§ 10. *Interferometer.*—In many cases it is necessary that the two rays ultimately brought to interference should be sufficiently separated over a part of their course to undergo a different treatment; for example, it may be desired to pass them through different gases.

A simple modification of Young's original experiment suffices to solve this problem. Light proceeding from a slit at A (fig. 6) perpendicular to the plane of the paper, falls upon a collimating lens B whose objecture is limited by two parallel and rather narrow slits of equal width. The parallel rays CE, DF (shown broken in the figure) transmitted by these slits are brought to a focus at G by the lens EF where they form an image of the original slit A. This image is examined with an eye-piece of high magnifying power. The interference bands at G undergo displacement if the rays CE, DF are subjected to a relative retardation. Consider what happens at the point G, which is the geometrical image of A. If all is symmetrical so that the paths CE, DF are equal, there is brightness. But if, for example, CE be subjected to a relative retardation of half a wave-length, the brightness is replaced by darkness, and the bands are shifted through half a band-interval.

An apparatus of this kind has been found suitable for determining the refractivity of gases, especially of gases available only in small quantities (*Proc. Roy. Soc.*, 1896, 59, p. 198; 1898, 64, p. 95).

There is great advantage in replacing the ordinary eye-piece by a simple cylindrical magnifier formed of a glass rod 4 mm. in diameter. Under these conditions a paraffin lamp sufficed to illuminate the slit at A, and allowed the refractivities of gases to be compared to about one-thousandth part.

If the object be to merely see the bands in full development the lenses of the above apparatus may be dispensed with. A metal or pasteboard tube 10 in. long carries at one end a single slit (analogous to A) and at the other a double slit (analogous to C, D). This double slit, which requires to be very fine, may be made by scraping two parallel lines with a knife on a piece of silver glass. The tube is pointed to a bright light, and the eye, held close behind the double slit, is focused upon the far slit.

§ 11. *Other Refractometers.*—In another form of refractometer, employed by J. C. Jamin, the separations are effected by reflections at the surfaces of thick plates. Two thick glass mirrors, exactly the same in all respects, are arranged as in fig. 7. The first of the two interfering rays is that which is reflected at the first surface of the first reflector and at the second surface of the second reflector. The second ray undergoes reflection at the second surface of the first reflector and at the first surface of the second reflector. Upon

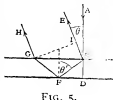

FIG. 5.

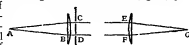

FIG. 6.

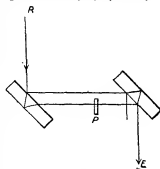

FIG. 7.

the supposition that the plates are parallel and equally thick, the paths pursued by these two rays are equal. P represents a thin plate of glass interposed in the path of one ray, by which the bands are shifted.

In Jamin's apparatus the two rays which produce interference are separated by a distance proportional to the thickness of the mirrors, and since there is a practical limit to this thickness, it is not possible to separate the two rays very far. In A. A. Michelson's interferometer there is no such restriction. The light starts from source S (fig. 8) and separates at the rear of plate A, part of it being reflected to the plane mirror C, returning exactly, on its path through A, to O, where it may be observed by a telescope or received upon a screen. The other part of the ray goes through the glass plate A, passes through B, and is reflected by the plane mirror D, returns on its path to the starting point A, where it is reflected so as nearly to coincide with the first ray. The plane parallel glass B is introduced to compensate for the extra thickness of glass which the first ray has traversed in passing twice through the plate A. Without it the two paths would not be optically identical, because the first would contain more glass than the second. Some light is reflected from the front surface of the plate A, but its effect may be rendered insignificant by covering the rear surface of A with a coating of silver of such thickness that about equal portions of the incident light are reflected and transmitted. The plane parallel plates A and B are worked originally in one piece, which is afterwards cut in two. The two pieces are placed parallel to one another, thus ensuring exact equality in the two optical paths AC and AD\* (see Michelson, *Light Waves and their Uses*, Chicago, 1903).

The adjustments of this apparatus are very delicate. Of the fully silvered mirrors C, D, the latter must be accurately parallel to the image of the former. For many purposes one of the mirrors, C, must be capable of movement parallel to itself, usually requiring the use of very truly constructed ways. An escape from this difficulty may be found in the employment of a layer of mercury, standing on copper, the surface of which automatically assumes the horizontal position.

Michelson's apparatus, employed to view an extended field of homogeneous light, exhibits Haidinger's rings, and if all is in good order the dark parts are sensibly black. As the order of interference increases, greater and greater demand is made upon the homogeneity of the light. Thus, if the illumination be from a sodium flame, the rings are at first distinct, but as the difference of path increases the duplicity of the bright sodium line begins to produce complications. After 500 rings, the bright parts of one system coincide with the dark parts of the other (Fizeau), and if the two systems were equally bright all trace of rings would disappear. A little later the rings would again manifest themselves and after 1000 have gone by, would be nearly or quite as distinct as at first. And these alternations of distinctness and indistinctness would persist until the point was reached at which even a single sodium line was insufficiently homogeneous. Conversely, the changes of visibility of the rings as the difference of path increases give evidence as to the duplicity of the line. In this way Michelson obtained important information as to the constitution of the approximately homogeneous lines obtained from electrical discharge through attenuated metallic vapours, especially valuable in the vacuum tube containing cadmium. The red line proved itself to be single and narrow in a high degree, and the green line was not far behind.

But although in Michelson's hands the apparatus has done excellent spectroscopic work, it is not without its weak points. A good deal of labour is required to interpret the visibility curves, and in some cases the indications are actually ambiguous. For instance, it is usually impossible to tell on which side of the principal component a feeble companion lies. It would seem that for spectroscopic purposes this apparatus must yield to that of Fabry and Pérot, in which multiple reflections are utilized; this is a spectroscopic in the literal sense, inasmuch as the constitution of a spectrum line is seen by simple inspection. (R.)

**INTERIM**, originally a Latin word for "in the meantime." The word was hence applied to certain edicts and decrees passed by the emperor and the diets during the reformation in Germany with the object of temporarily settling a controversy. These "interims" regulated points of religious and ecclesiastical difference until they could be decided by a general council. The best example of such a *modus vivendi* is the Augsburg Interim of 1548, drawn up by Michael Halding, Julius von Plug and John Agricola (a medievalist, an Erasmusian, and a conservative Lutheran) at the bidding of Charles V., and accepted by the diet. It was an ambiguous document, teaching from the

Roman Catholic side transubstantiation, the seven sacraments, adoration of the Virgin and saints, and papal headship, and from the Protestant, justification by faith, marriage of priests, the use of the cup by the laity. Maurice of Saxony was permitted to vary the interim for his dominions, and his edition was called the Leipzig Interim. An earlier interim was that of Regensburg, 1541.

**INTERLACED ARCHES**, the term for a scheme of decoration employed in Romanesque and Gothic architecture, where arches are thrown from alternate piers, interlacing or intersecting one another. In the former case, the first arch mould is carried alternately over and under the second, in the latter the mouldings actually intersect and stop one another. An example of the former exists in St Peter's in the East, Oxford, and of the latter in St Joseph's chapel, Glastonbury, and in the cathedral of Bristol.

**INTERLAKEN**, a Swiss town (1864 ft.) in the canton of Berne, situated on the flat plain (Bödeli) between the lakes of Brienz (E.) and of Thun (W.), and connected by steamer, as well as by railway (17½ m.) with the town of Thun. It is built on the left bank of the Aar, and grew up around the religious house of Austin Canons, founded about 1130 and suppressed in 1528. In the surviving buildings of the convent religious services (Anglican, Scottish Presbyterian and French Protestant) are now held, while the more modern castle is occupied by offices of the Cantonal Government. The fine and well-shaded avenue called the *Höheweg* runs through the main portion of the town, and is lined on the north side by a succession of huge hotels and the large Kursaal. Interlaken is much frequented in summer, partly because of the glorious view of the Jungfrau (13,669 ft.) which it commands to the south, and partly because it is the best starting-point for many excursions, as to Schynige Platte, Lauterbrunnen and Grindelwald. The lines serving these places all start from the eastern railway station (that from Thun reaches the western or main railway station), whence steamers depart for the Giessbach Falls, Brienz and Meiringen, on the way to Lucerne or to the Grimsel Pass. In 1900 the population of Interlaken was 2062 (mainly Protestant and German-speaking). Opposite Interlaken, and on the right bank of the Aar is Unterseen (in 1900, 2607 inhabitants), which was built in 1280 by Berthold von Eschenbach.

See *Fontes rerum Bernensium* (original documents up to 1366) (8 vols., Berne, 1883-1903); *Die Regesten des Klosters zu Interlaken* (Coire, 1849); E. Tatarinoff, *Die Entwicklung der Probstei Interlaken im XIII. Jahrhundert* (Schaffhausen, 1892). (W. A. B. C.)

**INTERLOPER**, one who interferes in affairs in which he has no concern. This word, with the verbal form "to interlope," first appears at the end of the 16th and beginning of the 17th century in connexion with the interference of unauthorized persons in the trading monopoly of the Russia Company and later of the East India Company. The *New English Dictionary* quotes from H. Lane (1590), *Hakluyt's Voyages*, "From those parts the Muscovites were furnished out of Dutchland by enterlopers with all arts and artificers and had few or none by us," and also from the *Minutes of the Court of the East India Company*, 22nd of February 1615, "to examine all suspected persones that intend interloping into the East Indies or Muscovy." Edward Phillips (*New World of Words*, 1658) defines interlopers at common law as those "that without legal authority intercept the trade of a company, as it were Interleapers." The word appears to be of English origin, for the Dutch *enterlooper*, smuggler, often given as the source, was taken from English, as was the French *interlope*. The word is a compound of *inter*, between, and *lope*, a dialectal variant of "leap." A common word for a vagrant, or "straggler," as it is defined, was till 1580 "landloper," and the combination of "straggler" and "interloper" is found in *Horsey's Travels* (Hakluyt Soc.), 1603-1627, "all interlopers and stragling Englismene lvyng in that country."

**INTERNATIONAL, THE**. The International Working Men's Association, commonly called "The International," was formed at London in 1864. It was a society of working men of all nations, somewhat like a cosmopolitan trades union, but

hearing a still closer resemblance to an international social science association for discussing and furthering the rights of labour. The occasion of its formation was the visit of some French workmen to the London Exhibition of 1862. In the course of their visit the labour question was discussed, and a desire for the further interchange of ideas expressed. Nothing decisive was done till 1864, when a great public meeting of working men of all nations was held at St Martin's Hall, London, and a provisional committee was appointed to draft the constitution of the new association.

The first four congresses of the International, held at Geneva (September 1866), Lausanne (1867), Brussels (1868), and Basel (1869), marked the rapid development of the association. It gained its first triumph in the effectual support of the bronze-workers at Paris during their lock-out in 1867; and it repeatedly aided the English unionists by preventing the importation of cheap labour from the continent. It soon spread as far east as Poland and Hungary, and it had affiliated societies with journals devoted to its cause in every country of western Europe.

It was supposed to be concerned in all the revolutionary movements and agitations of Europe, gaining notoriety as the rallying point of social overthrow and ruin. Its prestige, however, was always based more on the vast possibilities of the cause it represented than on its actual power. Its organization was loose, its financial resources insignificant; the continental unionists joined it more in the hope of borrowing than of contributing support. At the successive congresses its socialistic tendencies became more and more pronounced; it declared its opposition to private property not only in railways but in mines and the soil, holding that these should revert to the community. Even the principle of inheritance was saved only by a narrow majority. In 1869 M. Bakunin, the Russian socialist or nihilist, with his party joined the association, and at once asserted his character as the "apostle of universal destruction."

The relation of the association to the communal rising at Paris in the spring of 1871 has been the subject of much dispute. It is now agreed that the International as such had no part either in originating or conducting it; some of its French members joined it, but only on their individual responsibility. Its complicity after the event is equally clear. After the fall of the commune the general council of London, Karl Marx included, issued a long and trenchant manifesto, approving its action and extolling the "glorious vanquished." From this point the decline and fall of the association is to be dated. The English unionists, intent on more practical concerns at home, never took a deep interest in its proceedings; the German socialists were hindered by law from corporate action; America was too remote. But it found its worst enemies amongst its own friends; the views of Marx and his school were too moderate for the universally subversive principles of M. Bakunin and the radical Swiss federation of the Jura. It came to a rupture at the congress of 1872, held at the Hague, when Bakunin, being outvoted and "excommunicated" by the Marx party, formed a rival International, which found its chief support in Spain and Italy. Wearied of its European contentions and desirous to form a basis of operation in America, the Marx International now transferred the seat of its general council to New York; but it survived just long enough to hold another congress at Geneva in 1874, and then quietly expired.

The party of destruction styling themselves "autonomists" had a bloodier history. The programme of this party was to overturn all existing institutions, with the view to reconstructing them on some vague communal basis such as had been tried at Paris in 1871. It endeavoured to realize this in the great communal risings in southern Spain in 1873, when its adherents set up their peculiar form of government at Barcelona, Seville, Cadiz and Cartagena—at the last-mentioned place also seizing part of the ironclad fleet of Spain. As at Paris, they failed in leadership and organization, and were suppressed, though not without difficulty, by the national troops. The "autonomists" lingered on till 1870. The collapse was complete of an association

which once extended from Hungary to San Francisco, and alarmed the minds of men with visions of universal ruin.

See Villetard, *Histoire de l'Internationale* (Paris, 1871); Testut, *L'Internationale* (Paris, 1871); Onslow Yorke, *Secret History of the International* (London, 1871); J. Rae, *Contemporary Socialism*; also the articles MARX and SOCIALISM.

**INTERNATIONAL LAW**, the general term for the law governing the relations and intercourse of states with one another. The parties in its application are states (see STATE) and not nations, so that the word "international" does NOT accurately limit the scope of the subject. Nor do authors always confine themselves to its proper limitation. Thus the rules relating to nationality and naturalization, extradition, patents, trade marks, &c., which affect states on the one side and foreign persons on the other, are generally included among the subject-matter of International Law. There is a special branch of International Law known as Private International Law (see INTERNATIONAL LAW, PRIVATE) which deals exclusively with the relations of persons belonging to different states, in which states as such are not parties.

The term "international" was first used by Bentham. His explanation of the new term was as follows:—

"The word *international*, it must be acknowledged, is a new one; though, it is hoped, sufficiently analogous and intelligible. It is calculated to express, in a more significant way, the branch of law which goes commonly under the name of 'law of nations,' an appellation so uncharacteristic that, were it not for the force of custom, it would seem rather to refer to internal jurisprudence. The chancellor d'Aguesseau has already made, I find, a similar remark; he says that what is commonly called *droit des gens* ought rather to be termed *droit entre les gens*. There remain then the mutual transactions between sovereigns as such, for the subject of that branch of jurisprudence which may be properly and exclusively termed international."<sup>1</sup>

There has been much controversy as to the aptness of the use of the word "law" in this connexion. "International law," said the 3rd marquis of Salisbury in a speech on the establishment of a Court of International Arbitration, "has no existence in the sense in which the term 'law' is usually understood. It depends generally upon the prejudices of writers of text-books. It can be enforced by no tribunal, and therefore to apply to it the phrase 'law' is to some extent misleading."<sup>2</sup> This has been more or less the view not only of most British statesmen but also of many practical English jurists. It found one of its most emphatic exponents in Lord Chief-Justice Coleridge. "Strictly speaking," he observed in his judgment on the Franconia case,<sup>3</sup> "international law is an inexact expression, and it is apt to mislead, if its inexactness is not kept in mind. Law implies a lawgiver and a tribunal capable of enforcing it and coercing its transgressors, but there is no common lawgiver to sovereign states, and no tribunal has the power to bind them by decrees or coerce them if they transgress. The law of nations is that collection of usages which civilized states have agreed to observe in their dealings with one another. What these usages are, whether a particular one has or has not been agreed to, must be matter of evidence. Treaties and acts of states are but evidence of the agreement of nations, and do not, in England at least, *per se* bind the tribunals. Neither certainly does a consensus of jurists, but it is evidence of the agreement of nations on international points, and on such points, when they arise, the English courts give effect as part of English law to such agreement."

In opposition to this view may be cited the more recent one expressed by Lord Russell of Killowen, who challenged Lord Coleridge's view as "based on too narrow a definition of law," a definition which relies too much on force as the governing idea."<sup>4</sup> "If," he added, "the development of law is historically considered it will be found to exclude that body of customary law which in early stages of society precedes law. As government becomes more frankly democratic, laws bear less and less the character of commands imposed by a coercive authority, and acquire more and more the character of customary law founded

<sup>1</sup> Introduction to the *Principles of Morals and Legislation* (Clarendon Press edition of 1879).

<sup>2</sup> *The Times*, July 26, 1887.

<sup>3</sup> *R. v. Keyn*, 2, Ex.D. 63.

on consent. . . . I claim that the aggregate of the rules to which nations have agreed to conform in their conduct towards one another are properly to be designated International Law."<sup>1</sup> This recalls Blackstone's definition: "The law of nations is a system of rules, deducible by natural reason, and established by universal consent among the civilized inhabitants of the world, in order to decide all disputes, to regulate all ceremonies and civilities, and to ensure the observance of justice and good faith in that intercourse which must frequently occur between two or more independent states, and the individuals belonging to each."<sup>2</sup> The current English narrower view owes its origin chiefly to the influence of John Austin, and the current broader one to that of Sir Henry Maine.<sup>3</sup> The increasing popularity of references to international arbitration (see ARBITRATION, INTERNATIONAL), the adoption of a large number of special treaties making such references compulsory in certain cases, the establishment of and increasing recourse to the court for the decision of difficulties between states created by The Hague "Convention for the pacific settlement of disputes between States" of 1899 (see PEACE), the adoption of fixed rules of law in the international conventions in 1899, 1907 and 1909 dealing with many of the most controversial questions of international usage, have so transformed the subject that if, as Lord Colridge said, law implies a lawgiver and a tribunal capable of enforcing it, these conditions are now at any rate partly fulfilled. We shall see below to what extent it may be necessary to regard power of enforcement against transgressors as requisite to give international law the character of law properly so-called.

**Sanctions.**—The subject of the enforcement of International Law, or its "sanctions," has given rise to much controversy. The word "sanction" is derived from the Lat. *sanctio*, which in turn is derived from *sancire*, to consecrate. In its original sense *sanctio* means consecration. From this followed the sense of religious obligation. Thus *sancire legem* is used by Roman writers as meaning that observance was made obligatory, but without reference to the idea of there being a remedy or penalty for non-observance. With the development of an organized judicial system the religious or moral obligation was displaced by the growth of remedial procedure. Cicero observes of some legal restrictions, *hoc non sancitur lege civili* (this is not consecrated by the civil law, i.e. with penalties). A collateral sense of the word grew up which meant ratification, as where Cicero speaks of *sancire acta Caesaris* or of *sancire foedus*.

Bentham, who worked out the theory of legal sanctions as applied to modern law, describes them as equivalent to pleasures and pains derived from four different sources. These are physical, political, moral and religious. The first three belong to experience in the present life, the fourth to that in the present life or hereafter.<sup>4</sup>

Austin's analysis of this vague subdivision led him to a more precise determination of the relationship of sanctions to law, viz. that a law properly so-called is a command and its sanction is the power to enforce obedience to it. Stated briefly, any other kind of law according to Austin is not positive law but merely called so by analogy. Applying this test to International Law he concludes that the law obtaining between nations is not positive law; for every positive law is set by a given sovereign to a person or persons in a state of subjection to its author. The law obtaining between nations is only law set by general opinion,

with duties which are only enforced by moral sanction; by fear on the part of nations, or by fear on the part of a sovereign, of provoking general hostility, and incurring its probable evils, in case they should violate maxims generally respected.<sup>5</sup>

Sir H. Maine's somewhat indirect answer to Austin may now be taken as the view held at least by British theoretical writers. "Austin," he said, "has shown, though not without some straining of language, that the sanction is found everywhere, in positive law, civil and criminal. This is, in fact, the great feat which he performed, but some of his disciples seem to me to draw the inference from his language that men always obey rules from fear of punishment. As a matter of fact this is quite untrue, for the largest number of rules which men obey are obeyed unconsciously, from a mere habit of mind. Men do sometimes obey rules for fear of the punishment which will be inflicted if they are violated, but, compared with the mass of men in each community, this class is but small; probably it is substantially confined to what are called the criminal classes, and for one man who refrains from stealing or murdering because he fears the penalty there must be hundreds of thousands who refrain without a thought on the subject."<sup>6</sup>

The view, however, that a law is not devoid of binding character because there is no authority to enforce its observance hardly requires justification at the present day. The fact that any well-established international usage is observed, and that states invariably endeavour to answer any reproach of departing from such usage by explanations showing that the incriminated act is justified by recognized rules of International Law, is evidence of its binding character. As the late Professor Rivier, one of the leading authorities on Roman Law, as well as an international jurist of eminence, has expressed it: "The law of nations is positive law because states wish it to be so. They recognize its compulsory character and proclaim it. As they are their own legislators and make their common laws by express or tacit consent, they attest explicitly and implicitly their conviction that its principles are binding upon them, as judicial principles, as law. Innumerable public acts, affirmations, declarations and conventions are there to prove it. On the other hand, never in any published official act of the present age, verbal or written, has a state dared to declare that it did not consider itself bound by the law of nations and its principles."<sup>7</sup> States, as Professor Rivier says, have again and again solemnly declared their determination to abide by the principles of International Law. Witness the Declaration of Aix-la-Chapelle of November 15, 1818, in which the representatives of five powers, Austria, France, Great Britain, Russia and Prussia, solemnly stated that "the sovereigns in forming this august union have regarded as its fundamental basis their unchangeable resolution never to depart, either amongst themselves or in their relations with other states, from the strictest observance of the principles of the law of nations, principles which, in their application to a permanent state of peace, can alone effectively guarantee the independence of each government and the stability of the general association." In the negotiations for the Treaty of London concerning the Black Sea (March 13, 1871), at which seven powers were represented, Austria-Hungary, France, Germany, Great Britain, Italy, Russia and Turkey, a resolution on the sanctity of treaties was annexed to the first protocol, stating that the plenipotentiaries recognized that it is an essential principle of the law of nations that "no power can liberate itself

<sup>1</sup> Address at Saratoga Springs, N.Y., 1896 (*Law Quarterly Review*, October 1896).

<sup>2</sup> *Commentaries on the Law of England*, 4th ed., iv. 66.

<sup>3</sup> Austin's view, as set out in the *Province of Jurisprudence Determined*, is that laws proper, or properly so-called, are commands; laws which are not commands are laws improper or improperly so-called. A command implies a definite superior in a position to enforce the command. Where there is no superior to impose obedience there is no law. Rules which "are imposed among nations or sovereigns by opinions current among nations are usually styled the law of nations or international law. Now, a law set or imposed by public opinion is a law improperly so-called" (p. 147). For Sir H. Maine's views see below.

<sup>4</sup> Introduction to the *Principles of Morals and Legislation* (Oxford, 1879), pp. 24 et seq.

<sup>5</sup> *Province of Jurisprudence Determined* (1861), p. 177; Austin explains his view more fully at p. 127.

<sup>6</sup> *International Law*, p. 50.

<sup>7</sup> *Droit des gens* (1896), i. 22. Compare Savigny: "A community of judicial conscience can be formed among nations like that which positive law creates in the bosom of one people. The foundations of that intellectual community are constituted partly by a community of race, partly and especially by a community of religious convictions. Such is the basis of the law of nations which exists principally among European Christian states, but which was not known to the peoples of antiquity. We are entitled to look upon this law as a positive law, although it is an incomplete judicial formation" (eine unvollendete Rechtsbildung), *System des heutigen römischen Rechts* (1840), i. § 11.

from the engagements of a treaty, nor modify the stipulations thereof, unless with the consent of the contracting powers by means of an amicable arrangement." Even in 1908, when Austria-Hungary proceeded to the annexation of Bosnia-Herzegovina without obtaining the prior assent of the high contracting powers, who under the treaty of Berlin of 1878 had granted her temporary occupation of the annexed provinces, the protests of the powers concerned were answered by Austria-Hungary declaring that she had done nothing contrary to the law of nations or affecting the sanctity of treaties, because the powers had given their tacit consent to the practical transformation of her temporary into a permanent occupation.

The public opinion of the civilized world, in fact, plays in an ever-increasing degree the part of a sanctioning authority. With the growth of international intercourse and international interdependence the danger of isolation or of discredit or even of "boycotting" becomes a matter of increasing importance in the conduct of states. The national press and periodical literature, with exceptions no doubt, are among the chief factors in the development of this public opinion, but it is by no means dependent upon them. Personal intercourse among citizens of the same country, and between statesmen, politicians and citizens of different countries has a still greater effect in the creation of the mental attitude of nations towards each other. This exposes any departure from recognized usage or any disregard for international obligations to such reprobation throughout the whole world, that, far from taking advantage of the absence of any coercive method of enforcing obedience to the principles of international law, states compete with each other in asserting their strict fidelity to such principles. And now successive diplomatic conferences have codified many of the chief branches of international usage, thus diminishing the possible cases in which states can take advantage of the uncertainty of the law and, by quibbling over its interpretation, escape from its obligations.

**Sources and Foundations.**—It is usual, following Wheaton's classification,<sup>1</sup> to enumerate the sources of International Law in the following groups: text-writers of authority as witnesses of usage; treaties of peace, alliance and commerce; ordinances of particular states, prescribing rules for the conduct of their commissioned cruisers and prize tribunals; adjudications of international tribunals; written opinions of official jurists given confidentially to their own government; history of wars, negotiations, treaties and other transactions relating to the public intercourse of nations. It is in these different classes of opinions and precedents that writers have been in the habit of searching for those arguments and analogies on which have been built up the system and principles called International Law.

Wheaton, it is seen, regarded text-writers as witnesses of the usage of nations. He explains his meaning as follows: "Without wishing to exaggerate the importance of these writers, or to substitute in any case their authority for the principles of reason, it may be affirmed that they are generally impartial in their judgment. They are witnesses of the sentiments and usages of civilized nations, and the weight of their testimony increases every time that their authority is invoked by statesmen, and every year that passes without the rules laid down in their works being impugned by the avowal of contrary principles." This distinguished writer's quasi-explanation of the sources of International Law is extremely vague. He masses together cause and effect, private and public opinions, usage and exceptions. Professor Oppenheim has endeavoured to give a more scientific explanation of the growth and development of International Law, and objects to calling sources of International Law what are mere factors influencing its growth:—

"... Custom and treaties," he observes, "are the two exclusive sources of the Law of Nations. When writers on International Law frequently enumerate other sources besides custom and treaties

they confound the term 'source' with that of 'cause'<sup>2</sup> by calling sources of International Law such factors as influence the gradual growth of new rules of International Law without, however, being the historical facts out of which these rules receive their legal force. Important factors of this kind are: Opinions of famous writers on International Law, decisions of prize courts, arbitral awards, instructions issued by the different states for the guidance of their diplomatic and other organs, state papers concerning foreign politics, certain municipal laws, decisions of municipal courts. All these and other factors may influence the growth of International Law either by creating usages which gradually turn into custom, or by inducing the members of the Family of Nations to conclude such treaties as stipulate legal rules for future international conduct.

"A factor of the special kind which also influences the growth of International Law is the so-called comity (*Comitas gentium, Convencione et courtoisie internationale, Staatsgenossin*). In their intercourse with one another states do observe not only legally binding rules and such rules as have the character of usages, but also rules of politeness, convenience and goodwill. Such rules of international conduct are no rules of law, but of comity. The Comity of Nations is certainly not a source of International Law, as it is distinctly the contrast to the Law of Nations. But there can be no doubt that many a rule which formerly was a rule of International Comity only is nowadays a rule of International Law. And it is certainly to be expected that this development will go on in future also, and that thereby many a rule of present International Comity will in future become one of International Law."<sup>3</sup>

We prefer to regard International Law as deriving the rules composing it from practically the same sources as domestic law, and to attribute to text-writers more or less the same value in its development as in that of the private law of nations. The same primary rules of conduct are appealed to between states as between individuals, and precedents play exactly the same part wherever human actions are concerned. In both cases what has been done before commends itself when the responsibility of taking steps pledging the future is concerned. Statesmen on whom great responsibility impends, on whom the conduct of momentous negotiations has devolved, and who will have to render an account of their work to the sovereign or nation they represent, preserve an argument in their own favour in departing as little as possible from any course taken in previous similar circumstances. Precedents, moreover, are arguments for acceptance by their adversaries or counter-negotiators. In fact, in diplomacy even more than in matters of domestic government precedents play a dominant part in the growth of usage. These precedents are often in themselves originally local usages, such as grew up in the intercourse of the Italian communities. Italy, in fact, served as a laboratory for early diplomatists and writers. It was in the intercourse of these active and ambitious states that **Italian influence.** grew up the very notion of a foreign diplomacy and the necessity of rules of conduct in this miniature Europe, with its perpetual antagonisms and jealousies, its balance of power, its idea of a state distinct from a nation and of a community of

<sup>1</sup> "It seems to me," says Professor L. Oppenheim, "that most writers confound the conception of 'source,' with that of 'cause,' and through this mistake come to a standpoint from which certain factors which influence the growth of International Law appear as sources of rules of the Law of Nations. This mistake can be avoided by going back to the meaning of the term 'source' in general. Source means a spring or well, and has to be defined as the rising from the ground of a stream of water; and, wanting to know whence it comes, we follow the stream upwards until we come to the spot where it rises naturally from the ground. On that spot, we say, is the source of the stream of water. We know very well that this source is not the cause of the existence of the stream of water. 'Source' signifies only the natural rising of water from a certain spot of the ground, whatever natural causes there may be for that rising. If we apply the conception of source in this meaning to the term 'source of law' the confusion of source with cause cannot arise. Just as we see streams of water running over the surface of the earth, so we see, as it were, streams of rules running over the area of law. And if we want to know whence these rules come, we have to follow these streams upwards until we come to their beginning. Where we find that such rules rise into existence there is the source of them. Of course, rules of law do not rise from a spot on the ground as water does; they rise from facts in the historical development of a community. Thus a good many rules of law rise every year from the Acts of Parliament. Source of Law is therefore the name for an historical fact out of which rules of conduct rise into existence and legal force" (*International Law*, London, 1905, sec. 15.).

<sup>2</sup> *International Law* (London, 1905) sec. 19.

<sup>3</sup> *Elements* (London, 1885), pp. 22 et seq.



states elbowing each other in their daily contact. It was there that grew up the institution of passports, the distinction between armed forces and civilians, international comity, and in fact the very notion that states have an interest in the observance of law and order among them. In the same way the active commercial intercourse in the Mediterranean led, in the common interest, to the development of rules of the sea in time of peace, and later to others in time of war.

In the north of Europe, again, out of the active commercial intercourse among the Baltic and North Sea communities grew rules of the sea in the same common interest. It was the Thirty Years' War, with its revolting cruelty, which brought out the contrast between the more humane practice of war as an art in Italy and the mere bludgeonry which prevailed in the brutal struggle which disgraced the first half of the 17th century. The brutality of the struggle turned thinkers' attention to the need of formulating rules for the protection in time of war of non-combatants and the innocent subjects of absolute sovereigns, the treatment of the sick and wounded, the prohibition of wanton pillage and the other horrors which shocked the awakening conscience of northern Europe. It was the starting-point of the age of text-books.

The first effective work, the one which was the first to influence sovereigns and statesmen, was Grotius's *De jure belli ac pacis* (Paris, 1625), which practically exhausted the theoretical arguments in favour of the new subject. Nobody has in fact since brought to light any new conception of the foundations of international law. An exhaustive and masterly treatise having been published, no further subsequent treatise was necessary to show what all men were beginning to feel. He sublimated the feelings of his age, and having arrived at the pure substance, the work of proving the need of his subject was disposed of for all time. Pufendorf (1632-1697), who, in the sequence of effective text-writers, succeeded Grotius, endeavoured to base international law on an ethical basis accepted by all peoples without necessity for a common creed or standard of morals, but it is doubtful, whatever may have been the extent to which he stimulated the study of jurisprudence, whether he did much in advancing the practical development of the law of nations. His book *De jure naturae et gentium* (1672), as its name indicates, based international law on what he called the law of nature, a subject which has much exercised the minds of jurists searching for an ethical basis for existing law.

The scientific mind of Leibnitz (1646-1716) revolted against this theoretical and doctrinaire tendency of Pufendorf and other writers, who were following with feeble tread in the giant footsteps of Grotius. He saw that the practice of nations was taking a course dictated by the current moral standards of civilized society, and that the philosophizing of the text-book writers was leading them away from that actual practice which they should use as data for their conclusions. Natural science, moreover, had taught him the risk of theorizing on imperfect data, and while writing a history of Brunswick it occurred to him that treaties and diplomatic documents generally were the substances and tests of the publicist's laboratory. His *codex juris gentium diplomaticus* (1693-1700) gave a more precise direction to speculations on the subject.

The next great writer of authority united all the qualities of a practical lawyer and jurist. This was Bynkershoek (1673-1743). He was the first writer on international law who dealt with public maritime law as a matter demanding special treatment and involving a set of principles not called into action in territorial warfare. A magistrate administering the law in a great commercial country, whose interests were, on or across the high seas rather than within the narrow European limits of Holland, Bynkershoek, like Leibnitz, searched for his data in the actual practice of nations in their intercourse with one another. He applied his clear legally trained mind to deriving principles from practice instead of endeavouring to build up a practice on abstract principles. It was he who first generalized the different isolated usages

which had grown up at different spots in northern Europe in the interest of maritime defence, and evolved from practice the principle that dominion seawards was limited to the extent to which it was possible to enforce it (cannon-shot range), a principle which not only created the legal institution of territorial waters, but has since been imported into other branches of International Law, and has indirectly influenced the suppression of fictitious blockades and more recently of fictitious occupations of territory.

A contemporary of Bynkershoek was Christian de Wolff (1679-1754), a philosopher, mathematician, theologian, lawyer and disciple of Leibnitz. Wolff's great work on the *Institutions of the Law of Nature and Nations* is a learned and accurate treatise drawn from all the well-known sources of knowledge, and, just as Grotius based his demonstrations on the then imperfect knowledge of public events of his time, Wolff based his on the more accurate sources of information which had grown up under the influence of Leibnitz, and created a connected system out of the scattered fragments available. But his book was written in Latin at a period when scholarship had declined, and its influence was only felt after Vattel (1714-1767) wrote his *Droit des gens, ou principes de la loi naturelle appliquées à la conduite et aux affaires des nations et des souverains* (1758). His book had all the charm, although Vattel was a Neuchâtelais, of the French writers of his time, and he it was who popularized the study of International Law. His book was based chiefly on the work of Wolff, but in it he gave what was best amongst his predecessors without attempting to add anything original of his own. It became the handbook of statesmen and jurists, and has never ceased to be quoted by them down to the present day.

But the opinions of jurists in International Law can have little more than the value of criticism and co-ordination. They have seldom served to make law, though they have the weight of all statements made by those who have made a special study of any branch of law, as to what they had gathered to be the existing practice at the time when they wrote, or as to the trend which they showed that practice might be taking. Great lawyers and writers like those we have mentioned, and such as Lord Mansfield, Sir William Scott, Chief-Justice Marshall and others, have done the work of classifying facts, deducing conclusions from them and connecting rules with psychological and ethical motives, and have thus sent a current of higher intelligence through the subject which has raised it to its present methodical form. Still International Law remained a wide field for controversy. Authors were agreed on general principles, but when these general principles were applied in practice, the shortcomings of unwritten usage often caused as much difficulty as that which the appeal to principles was intended to overcome.

What may be called the first enactment of rules of International Law was the Declaration of Paris of 1856, but the great work of codification, or rather of reducing into writing the rules which had been floating as an unwritten law in the conscience of Europe, was undertaken by the Hague Conferences, which may be said to be and to have created an entirely new factor in the domain of International Law. Two of the conventions adopted in 1899 completed work which had already been commenced long before, viz. those on the usages of war and on the adaptation of the Geneva Convention to naval war. The third established methods for the pacific settlement of international difficulties, including the formation of the Hague Court of Arbitration. Recourse to the latter was purely optional, but the other two conventions have been absorbed into the national law of the ratifying countries, and thus have also the domestic sanction states give to their own laws. The work of the Conference of 1907 was of a much wider and more exhaustive character than that of 1899. It comprised, besides revised conventions on the matters dealt with in 1899, new Conventions on the following subjects: Opening of hostilities; Position in naval war of enemy's merchant ships at beginning of hostilities; Conversion of merchant vessels into warships; Rights and duties of neutral states in naval war; The laying of automatic submarine contact mines; The

Thirty  
Years'  
War.

C. de  
Wolff.

Vattel.

Pufen-  
dorf.

Leibnitz.

Hague and  
London  
Conferences.

Bynker-  
hoek.

bombardment of undefended places by naval forces; Treatment of fishing vessels, postal correspondence and capture generally in maritime war; and Recovery by force of contract debts. It also adopted a convention for the creation of an International Prize Court of Appeal, which led to the calling of a fresh Conference on Prize Law. This conference sat in London from December 4, 1908, to February 26, 1909, and was confined to representatives of the following countries: Great Britain, France, Germany, United States of America, Italy, Austria-Hungary, Russia, Japan, Holland and Spain. It adopted a series of rules on naval warfare relating to Blockade in time of war; Contraband of war; Unneutral service; Destruction of neutral prizes; Transfer to neutral flag; Enemy character; Convoy; and Resistance to search and Compensation.

The revolution effected in the relations of states by the Hague and London Conferences, however, is not confined to the reduction into writing of more or less vague usages nor to the elaboration of details which no usage can possibly determine. Until a machinery was provided for the reform of the law it was futile to speculate on the advantages or disadvantages of any rule admitted by the majority of civilized nations. The territorial waters 3 m. limit, for instance, had its origin in the distance seawards of cannon-range in a past period. Its almost universal recognition only came long after the range of coast-guns had far exceeded this distance. This superannuated law has now no legal basis at all except the so-called "common consent of nations," a boon no doubt which outweighs any consideration of absolute fitness still unrecognized, but of which the learned Barbeyrac truly said,<sup>1</sup> "Ce commun consentement des peuples que l'on suppose avoir force de loi est une chose qu'on ne prouvera jamais." The institution of the Hague Conferences has now provided a method of obtaining the consent of nations, not only to existing rules, but to their reform and to the introduction of new rules. It is now an understanding among the states of the world, that these conferences shall be held periodically. It is, of course, possible for one great state to hold aloof and thus wreck the chances of universal agreement, but even then we have the power of the majority as against that of the minority. A case actually arose in a recent war between non-signatories of the declaration of Paris of 1856. Neither the United States nor Spain was a party to that declaration, yet neither ventured to disregard it.

The chief source of International Law will, therefore, in all probability for the future be that "Parliament of mankind," the Hague Conferences. The Hague Court and its adjunct in time of war, the proposed International Prize Court of Appeal, will form the Judicature applying and construing the enactments of the Conferences acting as a sort of international Legislature.

**Fundamental Principles.**—Underlying the details of both the new International Legislature and the new International

Judicature are certain principles which may some day have to be officially defined. These principles have necessarily fluctuated with the standard of morals of each period. With the contemporary development of the public conscience, they are undergoing changes and a betterment which it is not desirable to check by yet nailing them up as immutable articles of faith. Till quite recently it was usual to speak of the common standard of right conduct prevailing throughout the Christian world, a standard to which respectable statesmen tried to adjust their direction of the affairs of state. The admission of Japan into the councils of the great powers has introduced a non-Christian element whose standard of conduct was not identical with nor based upon Christian morals. Turkey, though admitted in 1856 to European Councils, remained rather the occasion of their deliberations than a deliberating party. Her new position as a constitutional state, with a code of morals at any rate in some essentials distinct from that of Christian peoples, will add a further new non-Christian element into the moral foundations of international conduct. The influence of western Europe, however, in both Japan and Turkey, has hitherto in all external development been paramount. Japan,

after examining all the existing systems, has even adopted the best she found in Western morals, and in her schools inculcates Christian ethics as a subject *per se* without reference to divine revelation or authority. Turkey too has the advantage of possessing a code of morals which produces so high a standard of right conduct in private life that very little in the way of moral lessons will have to be learned by the Ottomans from Western civilization. As regards practice, it is unreasonable to expect that the high estimate of the moral standard of west European civilization, which is cherished by those who profess its principles, should be accepted by other peoples with unqualified assent. Are not the nations of western Europe still vaguely influenced by the instincts of their conquering ancestors, and by the traditions of—

" . . . the good old rule,  
The simple plan,

That they should take who have the power  
And they should keep who can " ?

There is nothing essentially different between many recent wars and military enterprises undertaken by Western nations against heathen peoples, and wars and conquering enterprises undertaken by the Northmen of a thousand years ago. In his *Northern Antiquities* Mallet<sup>2</sup> describes the primitive feeling of the Northmen in the following passages:—

" The rules of justice, far from checking their prejudices, had been themselves warped and adapted to their bias. It is no exaggeration to say that all the Teutonic nations entertained opinions on this subject quite opposite to the theory of our times. They looked upon war as a real act of justice, and esteemed it an incontestable title over the weak, a visible mark that God had intended to subject them to the strong. They had no doubt but the intentions of this divinity had been to establish the same dependence among men which there is among animals, and setting out from the principle of the inequality of men, as our modern civilians do, from that of their equality, they inferred thence that the weak had no right to what they could not defend. This maxim which formed the basis of the law of Nations among the ancient inhabitants of Europe being dictated by their most darling passion, we cannot wonder that they should so steadily act up to it in practice. And which after all is worst, to act and think as they did, or, like the moderns, with better principles, to act as ill? As to the ancient nations, we attribute nothing to them here but what is justified to them by a thousand facts. They adopted the above maxim in all its rigour and gave the name of Divine Judgment not only to the Judiciary Combat, but to conflicts and battles of all sorts: victory being in their opinion the only certain mark by which Providence enables us to distinguish those which it has appointed to command others."

The very notion of the "right of conquest," and that the victorious are entitled to an indemnity without reference to any question of right and wrong or of justice and injustice, shows that there are principles in actual practice which lie outside and have no analogy in the principles of private law. In the partition of Africa native states have been treated as non-existent except as local bodies. They have been annexed to European states without reference to their will or consent. Treaties have indeed been made with them, but they have rather been regarded as evidence of prior occupation than as involving any question of native right. The test in the distinction between civilized and uncivilized states which is regarded as warranting exclusion from enjoyment of the right to consideration as independent states, and admission to the community of the civilized world, is in practice the possession of a regular government sufficient to ensure to Europeans who settle among them safety of life and property. Every country, in principle, possessing such a government has *prima facie* the rank of a state and is entitled to treatment as a civilized community. Treaties made with it for the purpose of extra-territorial jurisdiction are intended merely to take into account a difference of judicial institutions but are not supposed to detract otherwise from the possession of such equality and independence. This principle has no analogy in private morals, and has been, slight as it is, more honoured in the breach than the observance. If indifference to native right has provoked reaction, it has been on the part rather of philanthropists than of statesmen. Their movement for the protection of African aborigines has, however,

What is a  
civilized  
state?

<sup>1</sup> Note 8 to Grotius, L., ii. c. iii. § 3.

<sup>2</sup> Bishop Percy's translation (1847), p. 138.

resulted in at least one great international charter for the prevention of the further degradation of African aborigines, viz. the General Act of Brussels of 1885. A vigorous outcry has also been raised against the methods of the government of the Congo State. But the agitation ought not to be confined to this part of Central Africa. Other governments are also in fault. In fact, the contact of the European with Central Africa has, throughout, with few exceptions, been one of barbarous practice quite inconsistent with the principles which Christian missionaries have been sent to teach the African native.

In the case of European enterprise in Asia, the "good old rule" has had still less justification. The action taken for the repression of the Boxer movement in China, like previous European incursions, had no essential characteristic distinguishing it from the expeditions of the Northmen described by Mallet in the above-quoted passage. The Japanese took part in the "Boxer" expedition, and the example of respect for native right and of orderly self-restraint they set has been universally acknowledged. But the lesson is one of greater significance than one of comparative ethics. The rise of the power of Japan and her obvious determination to constitute herself the champion of the races of eastern Asia has widened the scope of International Law, and we may now regard China as henceforth under the protection of the same principles as European states.

The three chief principles of inter-state intercourse, those, in fact, on which International Law is based are:—

1. Recognition of each other's existence and integrity as states.
2. Recognition of each other's independence.
3. Recognition of equality, one with another, of all independent states.

As regards the first of these principles see STATE. From the principle of independence it follows that every state has a right to change its form of government and to enjoy the free exercise of its internal energies. This is subject only to the limitation that in the exercise of this right other states or their subjects shall not be molested or otherwise suffer. The equality of all independent states entitles them to respect by other states of all the forms of ceremonial and to the same treatment by others, where their interests are identical, whether they are strong or weak. This principle has often been violated, but it is, nevertheless, acknowledged wherever possible, as in diplomatic conferences relating to all matters of an economic, hygienic, industrial or social character. Even at the Conference of Algieras, though the powers immediately concerned from a political point of view were only Great Britain, France, Germany and Spain, the following were also represented as having economic interests in Morocco, Austria-Hungary, Italy, Russia, Belgium, Holland, Portugal and Sweden.

Ships on the high sea being regarded as detached portions of the national territory, there is also the derived principle of the freedom of the high sea, of the independence and equality upon it of the ships of all nations, subject only to due respect being paid to the independence and equality of all others and to such conventional restrictions as states may impose upon themselves (see TERRITORIAL WATERS). This principle is re-enunciated in the preamble to the Convention of 1907 on the laying of automatic submarine contact mines (see PEACE CONFERENCES).

The Hague Conventions are based on these principles, to which there is a tendency to add another, viz. the right to arbitration in certain cases. This principle is set out more or less tentatively, it is true, but it is being completed by separate treaties of compulsory arbitration in connexion with the cases referred to. It is enunciated in the following article of the Convention of 1907 for the pacific settlement of International disputes:—

"In questions of a legal nature, and especially in the interpretation or application of International Conventions, arbitration is recognized by the contracting powers as the most effective, and, at the same time, the most equitable means of arranging disputes which

diplomacy has failed to settle. Consequently, it is desirable that, in disputes regarding the above-mentioned questions, the contracting powers should, if need be, have recourse to arbitration, in so far as circumstances permit" (Art. 28).

The principle of arbitration has also been adopted in reference to the recovery of contract debts under the following article of the "Convention respecting the limitation of the employment of force for the recovery of contract debts":—

"The contracting powers agree not to have recourse to armed force for the recovery of contract debts claimed from the government of one country by the government of another country as being due to its subjects or citizens. This undertaking is, however, not applicable when the debtor state refuses or neglects to reply to an offer of arbitration, or, after accepting the offer, renders the settlement of the *Compromis* impossible, or, after the arbitration, fails to comply with the award" (Art. 1).

The codification of International Law itself, begun at the Hague and London Conferences, is an admission of the binding character of the primary principles set out above.

One of the chief tendencies of contemporary reform is also to restrict the effect of fictions and reduce rights to the limits of their practical application. Between two alternatives, the one to assert rights which cannot possibly be maintained by force such as claims to dominion over portions of the high sea (see HIGH SEA, TERRITORIAL WATERS), "paper blockades" (see BLOCKADE and fictitious occupations of territory (see OCCUPATION), and the other to require actual physical assertion, a medium course is growing up, viz. that of recognizing potential assertion, that is assertion limited to physical possibilities.<sup>1</sup> With the aid of the Institute of International Law, the International Law Association and other reforming agencies (see PEACE), expert opinion in these matters is becoming homogeneous throughout the civilized world, and the ground is being prepared for a clearer understanding of these fundamental principles by the statesmen and state officials who have to apply them in practice.

**BIBLIOGRAPHY.**—The following are works on international law, diplomacy and treaty relations from the beginning of the 19th century to 1907. Many of the older authors have been omitted to permit the inclusion of more recent writers.

Alcorta, *Tratado de derecho internacional* (Buenos Aires, 1878); D. Anzilotti, *Teoria generale della responsabilit  del Stato nel diritto internazionale* (Florence, 1902); Arendt, *Le Droit public et la neutralit  de la Belgique* (Brussels, 1845); Nagao Ariga, *La Guerre russo-japonaise, au point de vue continental et le droit international* (Paris, 1908); *La Guerre sino-japonaise au point de vue du droit international* (Paris, 1896); Sir Sherston Baker, *First Steps in International Law* (London, 1899); Barbois, *Jurisprudence du conseil des prises pendant la guerre franco-allemande (1871)*; Sir T. Barclay, *Problems of International Practice and Diplomacy* (London, 1907); T. Baty, *International Law* (London, 1909); Bello, *Principios de derecho internacional*, 2nd ed. by Silva (Madrid, 1884); Norman Bentwich, *The Law of Private Property in War with a Chapter on Conquest* (London, 1907); Bergbohm, *Staats-Vertr ge und-Gesetze als Quellen des V lkerrechts* (Leipzig, 1877); T. M. Bernard, *Four Lectures on Subjects connected with Diplomacy* (London, 1868); Bluntschli, *Das moderne V lkerrecht der civilisirten Staaten als Rechtsbuch dargestellt* (N rdlingen, 1868), trans. into French by Lardy (*Le Droit international codifi *) (Paris, 2nd ed. 1874); *Die Bedeutung und die Fortschritte des modernen V lkerrechts* (2nd ed., Berlin, 1873); De Boeck, *Le Droit de la propri t  ennemie priv e sous pavillon ennemi* (Paris, 1882); Henri Bonfils, *Manuel de droit international public* (1894, 4th ed., by Fauchille, 1904); Percy Bordwell, *The Law of War between Belligerents—a History and Commentary* (Chicago, 1908); Bornemann, *Foerlesninger over den positive folkeret* (Copenhagen, 1866); Brusa, *Del moderno diritto internazionale pubblico* (Florence, 1876); De Burgh, *Elements of Maritime International Law* (London, 1868); Aug. von Bulmerincq, *Praxis, Theorie und Codification des V lkerrechts* (Leipzig, 1874); *Das V lkerrecht* (1887); Montagu Burrows, *History of the Foreign Policy of Great Britain* (London, 1807); Charles Henry Butler, *The Treaty-making Power of the United States* (2 vols., New York, 1902); Carlos Calvo, *Le Droit international consid r  dans ses origines et ses rapports avec les progr s de la civilisation* (2 vols., Paris, 1862); *De respect de la propri t  priv e dans la guerre maritime* (Paris, 1866); Carnazza-Amari, *Trattato di diritto internazionale de pace* (2 vols., 1867–1875); Pitt Cobbett, *Cases and Opinions on International Law and various points of English Law connected therewith* (London, 1st ed. 1885,

<sup>1</sup> We have seen this in the progress made in the three instances given above at the Congress of Paris (1856), the Conference of Berlin (1878) and the Hague Conference of 1907.



Paris, 1901, *Le Droit romain, le droit des gens et le collège des docteurs en droit civil* (Brussels, 1910); Marquis de Olivart, *Trattato y notas de derecho internacional publico* (2 vols., 1887, 4th ed., 1903); Luigi Olivi, *Di alcune odierne tendenze del diritto internazionale* (Venice, 1907); Onecimo, *Discurso sobre la historia del derecho internacional* (Buenos Aires, 1872); Oppenheim, *System des Völkerrechts* (Frankfurt, 1845); L. Oppenheim, *International Law*, vol. i, "Peace," vol. ii, "War and Neutrality" (London, 1905-1906); *International Decisions for Discussion in Consular Jurisdiction and Consular Solutions* are not given; *Gerechtigkeit und Gesetze* (Basel, 1895); Ortolan, *Règles internationales et diplomatique de la mer* (4th ed., Paris, 1864); Paiva, *Elementos de direito das gentes* (Coimbra, 1864); Pando, *Elementos de derecho internacional* (Madrid, 1843, 2nd ed., 1852); Pardessus, *Us. et coutumes de mer* (Paris, 1847); Paroldo, *Saggio di codificazione del diritto internazionale* (Turin, 1851); Perels, *Das internationale Seerecht der Gegenwart* (Berlin, 1882-1903; transl. Arendt, *Manuel de droit maritime international* (Paris, 1884)); Perez-Gomar, *Cursos de derecho de gentes* (Montevideo, 1864-1866); Perille, *Elementi di diritto internazionale nel secolo XIX.* (Naples 1877). *Trattato di diritto internazionale* (1881); Sir R. Phillimore, *Commentaries upon International Law* (4 vols., 3rd ed., London, 1879-1886); Coleman Phillipson, *Effect of War on Contracts* (London, 1909); *Studies in International Law* (London, 1908); Robert Piédélévière, *Précis de droit international public* (2 vols., 1891-1895); Pierantoni, *Storia del diritto internazionale nel secolo XIX.* (Naples, 1877). *Trattato di diritto internazionale* (1881-1887); Sir F. T. Pigott, *Nationality, including Naturalization and English Law on the High Seas and beyond the Realm* (2 vols., London, 1907); *Extraterritoriality, Jurisdiction in Consular Jurisdiction and Consular Cases in Oriental Countries* (Hongkong and London, 1907); Pillet, *Recherches sur les droits fondamentaux des états dans l'ordre des rapports internationaux* (Paris, 1899); Pinheiro-Ferreira, *Droit public interne et externe* (Paris, 1830); Sir Frederick Pollock, "The Monroe Doctrine" (Nineteenth Century, 1902); Polson, *Principles of the Law of Nations* (London, 1848); J. N. Pomeroy, *International Law in Time of Peace*, ed. by Theo. D. Woolsey (New York, 1886); Pradier-Fodéré, *La Question de l'Alabama et le droit des gens* (Paris, 1872), *Traité de droit international public européen et américain* (Paris, 1887-1897); *Principes de Droit International et de Consular Völkerrechts* (Berlin, 1873); Carman F. Randolph, *The Law and Policy of Annexation with special reference to the Philippines together with Observations on the Status of Cuba* (London, New York and Bombay, 1901); "Notes on the Foreign Policy of the United States suggested by the War with Spain" (New York, 1898, pamphlet); W. F. Reddaway, *The Monroe Doctrine* (Cambridge, 1898); Reddie, *Inquiries in International Law* (London, 1842); *Maritime International Law* (Edinburgh, 1844-1845); Emil Reich, *Foundations of Modern Europe* (London, 1904); Renault, *Introduction à l'étude du droit international public y compris le droit des gens et le droit public international* (Madrid, 1849); A. Rivier, *Principes du droit des gens* (2 vols., Paris, 1896); Saalfeld, *Grundriss eines Systems des europäischen Völkerrechts* (Göttingen, 1809); C. Salomon, *L'Occupation des territoires sans maître, étude de droit international* (Paris, 1889); Sanchez, *Elementos de derecho internacional publico* (Madrid, 1866); Eugene Schuyler, *American Diplomacy and Furtherance of Commerce* (New York, 1886); James Brown Scott, *Cases on International Law* (Boston, 1902); *The Hague Peace Conference of 1899 and 1907* (2 vols., Baltimore, 1909); K. F. Seijas, *El Derecho internacional historico-publico y privado* (6 vols., Ginebra, 1884); Senier, *Law of Nations* (5, London, 1865); Sheldon Amos, *Lectures on International Law* (London, 1874); Sierra, *Lecciones de derecho marítimo internacional* (Mexico, 1854); F. E. Smith, *International Law* (London, 1900, "Temple Primmers" series); *International Law as interpreted during the Russo-Japanese War* (in collaboration with N. W. Sibley; London, 2nd ed., 1907); Stephen, *International Law and International Relations* (London, 1884); Ellery C. Stowell, *Consular Cases and Opinions from the Decisions of the English and American Courts and the Opinions of the Attorneys-General* (Washington, D. C., 1900); Sakuyé Takahashi, *Cases on International Law during the China-Japanese War* (Cambridge, 1900); *International Law applied to the Russo-Japanese War with the Decisions of the Japanese Prize Courts* (London, 1908); H. L. Strisower, "Die Donaufrage" *Zeitschrift für das privat- und öffentliche Recht der Gegenwart* (Vienna, 1884); Hanns Taylor, *Traité on International Public Law* (Chicago, 1901); Tetens, *Droits réciproques des puissances belligérentes et des puissances neutres sur mer. Principes du droit de guerre en général* (Copenhagen, 1805); Tétot, *Répertoire des traités de paix, de commerce, d'alliance, etc., conventions et autres actes conclus entre toutes les puissances depuis le commencement de ce siècle jusqu'à ce jour* (Partie chronologique 1866, partie alphabétique, 1873, supplément, 1895); Alberto Torres, *Vers la paix. Etudes sur l'établissement de la paix générale et sur l'organisation de l'ordre international* (Rio de Janeiro, 1909); Heinrich Triepel, *Völkerrecht und Landesrecht* (Leipzig, 1899); Sir Travers Twiss, *The Law of Nations considered as Independent Communities* (2 vols., 2nd ed., London, 1875-1892); von Ullmann, *Völkerrecht* (1895; 2nd ed., 1908); Verraes, *Les Lois de la guerre et la neutralité* (Brussels, 1906); T. A. Walker, *The Science of International Law* (London, 1893); *Manual of International Law* (London, 1895); *History of the Law of Nations* (London, 1899); John Westlake, *Chapters on the*

*Principles of International Law* (Cambridge, 1894); *International Law*, vol. i, "Peace" (Cambridge, 1904), vol. ii, "War" (1907); Francis Wharton, *Digest of the International Law of the United States, taken from documents issued by Presidents and Secretaries of State, from decisions of Federal Courts and Opinions of Attorneys-General* (Washington, 1886, 3 vols., official); *The Revolutionary Diplomatic Correspondence of the United States* (6 vols., Washington, 1889, official); F. Wheaton, *History of the Law of Nations in Europe and America from the earliest times to the Treaty of Washington, 1822* (New York, 1845); *Elements of International Law* (1st ed., 1836; edit. Lawrence, 1855; edit. Dana, 1866; edit. Boyd, London, 1880; edit. Abdy, Cambridge, 1888; 3rd Eng. ed. by Sir Sherston Baker, 1893; 4th Eng. ed. by Atlay, 1904); Wildman, *Institutes of International Law* (London, 1849); Theodore D. Woolsey, *Introduction to the Study of International Law* (6th ed., New York, 1891); Spencer Walpole, *Foreign Relations* ("English Citizen" series, London, 1882); André Weiss, "Crimes et délits politiques dans les rapports de l'Autriche et de la Russie" (*Journal de droit international privé*, Paris, 1883). (T. DA.)

**INTERNATIONAL LAW (PRIVATE).** There is in every territory the law of the land, or territorial law, by which the courts decide all cases that include no circumstances connected with any foreign territory. Often, however, such a circumstance suggests the question whether justice does not require that the law of some other territory shall be applied. Thus the Gretna Green marriages, by which English minors escaped the necessity of bans or the consent of parents or guardians, suggested the question, which was answered in the affirmative, whether even in England their validity ought not to be tried by the law of Scotland, where they were celebrated. Often, again, the question is suggested whether justice does not require that the courts of law should allow some effect to foreign legal proceedings, such as a judgment obtained or litigation pending abroad. Such questions as these are answered by private international law, which, since both laws and legal proceedings are emanations of public authority, may be defined as the department of legal science which is concerned with the effect to be given in the courts of law of any territory to the public authority of another territory. The extradition of criminals is also an effect given to foreign public authority, but rather by the government which surrenders the criminal (see EXTRADITION) than by the courts of law, whose only function is to check the surrender so far as the domestic legislation allows them to do so. If private international law were defined as the effect to be given by any mode in one territory to the public authority of another, extradition would be included in it, as is often done; but since the principles governing extradition have little to do with those applicable to the other cases, it seems best to treat it as a separate department of law, as is generally done in England.

*Comity of Nations.*—In the 17th century the Dutch jurists Paul and John Voet and Huber brought forward a view which has since been largely adopted in England and the United States, namely, that the effect given by courts of law to foreign public authority is only due to the comity of nations, but for which every possible question before them would have to be decided by the law of the land. Comity, in that phrase, may only be intended to express the truth that foreign public authority has no inherent effect, without denying that the effect which domestic public authority allows to it is dictated by justice. But the limitations implied in the popular meaning of comity have sometimes been made the ground for deciding questions of private international law in the manner supposed to be most for the interest of litigants belonging to the territory; the phrase is consequently reprobated by most European continental writers, and had better be dropped. The justice on which private international law is founded acknowledges no interest but the general one of intercourse between persons sharing a common civilization in different countries. This interest, as manifesting itself in the domain of law, it seeks to satisfy, and it is therefore a true legal justice, rightly classed under *law, droit, recht, diritto, derecho* and other corresponding terms.

Of the two words which, together with *law*, make up the title of our subject, *private* is justified by the fact that its application is between litigants in courts of law, and not between governments except so far as they may be such litigants. *International* (although *interterritorial* would be better) is justified by the

facts that public authority, which may be internationally foreign, has to be considered, and that governments display a great interest in the question by concluding treaties about it, and occasionally even by suspending diplomatic relations when a court of one country has applied to the subjects of another a rule which the government of the latter deems unjust. But those who think that the primary division of law should be into public and private, and not into international (or interterritorial) and territorial, object to the order in which the three words of the name are usually placed, and call the subject "international private law."

*Conflict of Laws.*—This is another name for our subject, and indeed an older one than "private international law," besides being still much used. But although laws may differ, they cannot properly be said to conflict, unless each can lay a just claim to application in the same circumstances. Now this does not happen. The justice which points out that in certain cases effect ought to be given in one territory to the laws or legal proceedings of another really traces the limits of laws and legal proceedings in space; and the tracing of limits is rather the prevention of conflict than its solution. Savigny has well pointed out that our subject is analogous to the determination of the limits of laws in time, which has to be made when the just application of a new enactment is to be distinguished from the *ex post facto* application which cannot justly be allowed it. The truth which is aimed at in the phrase "conflict of laws" is that the main problem of our subject is the selection of a law for each given case; but different laws are candidates for selection, not from anything in them as laws, but from differing opinions about the justice of the case. From this selection, again, will be seen the contrast between private international law and attempts at the assimilation of the laws of different countries. To a great extent such assimilation is desirable, especially in mercantile law, but it must always be limited by different views of social order and differences in national habits of thought and action. So far as it is realized, private international law comes to an end with the occasion for selection.

*Territory.*—This word, as entering into the definition of private international law, does not imply a separate state, whether sovereign or semi-sovereign; it includes every geographical area having a separate legal system, England and Scotland, as well as France or Germany. The case of the Gretna Green marriages illustrates the necessity of rules of private international law between all such, as well as between areas internationally foreign to one another; and indeed the rules are so applied, and in the language of our subject, the area of every separate legal system is foreign to every other such area. Only where a rule contemplates a person as attached more or less permanently to a particular territory, the tie which so attaches him to it may be either nationality or domicile if the territory is a separate state, as France; but it can only be domicile if the territory is combined with others in one state. Nothing but domicile can distinguish British subjects as belonging to England, Scotland or Jamaica, or citizens of the United States as belonging to New York or Pennsylvania.

Legal rules must have relation to the physical and mental characters, and the consequent habits of action, of the populations for which they are intended; they would not satisfy legal justice if they endangered social order as understood and desired by those populations, or if they failed to give due effect to the expectations of parties. This must be true for the rules of private international law as well as for those of any territorial law, and it leads us to ask whether the differences which preclude the universal identity of the latter must not also preclude the existence of the former. The answer is: (1) That where circumstances connected with different territories are concerned, wise rules for the selection of a law will generally give better effect to the expectations of the parties than an exclusive adherence to the territorial law of the court; (2) That the circumstances in which a foreign law is held to apply are exceptional as compared with those in which the domestic law applies, and naturally occur oftener among the persons and in the affairs having most

of a cosmopolitan character, so that the moral shock of applying to them a law founded on a foreign social order is greatly attenuated; (3) That throughout Christendom (to which Japan has now been added for legal purposes) there does exist, though not an identity, yet a considerable similarity in views of social order and prevalent habits of thought and action. Within the same geographical limits there also exists another requisite for the working of a system of private international law, namely, a mutual confidence between countries in the enlightenment and purity of their respective judicatures, to whose proceedings the respect enjoined by the rules of our subject is to be mutually given.

Even within the geographical limits just mentioned there are certain differences on points of social order, especially on marriage or divorce, which have hitherto prevented a complete agreement being attained in the rules of private international law. But no attempt has ever been made to establish any system of the kind as between Christian communities and Mahomedan or other polygamous ones, or between countries enjoying a Christian standard of civilization and those, of which China may be taken as an example, which, whether polygamous or not, do not inspire the necessary confidence in their judicatures. In Turkey and other Eastern countries (in which designation Japan is no longer included for purposes of law) Christians are placed by treaty under the jurisdiction in civil matters of their respective consuls. When in the courts of Christian countries Eastern persons or circumstances connected with Eastern laws have to be dealt with, the peculiar institutions of those countries are not enforced; and while in other respects the judges may be assisted by some of the rules of private international law, especially such as have for their object to carry into effect the reasonable intentions of parties, yet those rules are not applied as parts of an authoritative system.

Rules for the selection of the territorial law to be applied in the different classes of cases, or for the recognition of foreign legal proceedings, have sometimes been made the subject of international treaties, and have often been enacted by territorial legislatures. England possesses a few such enactments, as in the Bills of Exchange Act 1882, and many other countries possess them to a much larger extent in their codes. Where such enactments exist, or where treaty stipulations have been entered into, and the territorial law makes such stipulations binding on the judges, the courts of law must obey and apply them as they must obey and apply any other part of the law of the land. If, as in England, judicial precedents are held to be binding, so that the law of the land consists in part of judge-made law, a similar result is produced; an English court must follow English precedents on the application of foreign law or the refusal to apply it, to the same extent to which it would be bound to follow them on any other point. So far as our matter remains open for a judge, he has, to assist him towards a just decision, the treaties, written laws and judicial precedents of other countries as examples, and a vast literature which has grown up in all Christian countries. That this apparatus is far from having furnished concordant results is due, not only to the divergences on points of social order referred to, but also to the different bases of the legal systems with which the respective governments and writers have been familiar. The legal systems of different countries have been founded on Roman law, feudal law, English common law and still other bases. The arguments of lawyers are affected by the prepossessions thence arising, and they have consequently failed to arrive by their unaided efforts at so much agreement on the rules of private international law as would have been compatible with the conditions and modes of life and action surrounding them. But the general acceptance of a complete body of rules on private international law is a goal which for other countries than England is well within sight by the road of international treaties concluded under the joint direction of professional and non-professional minds.

The most remarkable steps taken in or towards the conclusion of such treaties are those initiated, to its high credit, by the

government of the Netherlands. That government first moved in the matter in 1874, and has succeeded in assembling at the Hague the official representatives of nearly all European powers in conferences held in 1893, 1894, 1900 and 1904. At these conferences rules on many branches of private international law were agreed on for submission to the respective governments, which has led to conventions, one of the 14th of November 1896, three of the 12th of June 1902, and four of the 19th of July 1905, regulating the selection of the laws for determining the validity of marriage and of contracts made on the occasion of marriage, their effects on property and on the status of the wife and children, divorce and judicial separation, the guardianship of minors and of interdicted persons, the validity of testamentary dispositions and the rules of intestate succession, and many points of judicial procedure. These conventions may be found at length in the *Revue de droit international et de législation comparée*, t. 28, pp. 574-579; 2<sup>e</sup> série, t. 4, pp. 485-500; and 2<sup>e</sup> série, t. 7, pp. 646-678. A draft relating to bankruptcy was also prepared at the conference of 1904, but was intended to serve, not as a general convention, but as the base of separate conventions to be concluded between particular states. The extent to which the continent has become united with regard to private international law appears from the fact that France, Germany, Italy, the Netherlands, Portugal, Rumania and Sweden are parties to all the conventions—that Luxemburg, Russia and Spain are parties to those relating to judicial procedure—and that all the ten except Russia, but with the addition of Austria, Belgium and Switzerland, are parties to those on the validity of marriage, divorce and judicial separation, and the guardianship of minors; while all remain open to adhesion by other powers. It is much to be regretted that the British government has declined all invitations to take part in this great international work. The fact must in part be ascribed to the hindrance which the difference between the English common law and the Roman law places, even for lawyers, in the way of joint action with the continent, and in part to the necessity that the rules laid down in any convention should be enacted for the United Kingdom by parliament, the leaders of which belonging to either party take no interest in any such matters.

Next in importance among combined official efforts should be mentioned the congress of seven South American states at Montevideo in 1888-1889, which on many branches of private international law drew up rules intended for adoption by treaty on that continent.

*Nationality: Domicile.*—Coming now to the particular rules of private international law which are received in England, or have been most widely received elsewhere, the most obvious cases which present themselves for admitting foreign circumstances to influence the decision of a judge are those in which rights are so connected with the person of an individual that the justice of deciding on them by a law having relation to his person speaks almost for itself. Hence arises the notion of a personal law, which must be that either of the person's political nationality or of his domicile, these being the only circumstances that for the time being are fixed for the individual, irrespectively of the spot where he may happen to be, and of the transaction in which he may happen to engage. We have seen in the article on DOMICILE what is the legal meaning of that term, how its existence is ascertained, that in and long after the middle ages it was the usual criterion of the personal law, and that in modern times political nationality has largely replaced it as such criterion on the continent of Europe. Thus as well by the conventions mentioned as by the codes of many states—France, Italy and Germany among the number—the capacity and status of persons is now governed by the law of their political nationality. In Latin America the criterion of the personal law is still generally held to be domicile, which is among the reasons why the South American states prefer to pursue the codification of private international law independently of European conferences and conventions.

The English courts were slow to recognize a personal law at all and as late as Lord Eldon's time they held that the com-

petency of a person to contract depended on the law of the place where the contract was made. Their decisions have since come into line with the continental decisions so far as to make capacity and status depend on a personal law, but not so far as to make nationality its criterion. Hence in England, and in a minority of European continental countries, of which Denmark is an example, the capacity of a party to enter into a contract, whether it be disputed on the ground of his age, or, in the case of the contract of marriage, on the ground of his consanguinity or affinity with the other party, will be decided by the law of his domicile. Guardians, curators and committees of foreign minors or lunatics, deriving their authority from the law or jurisdiction of the latter's domicile or nationality, can sue and give receipts for their personal property. A court will not decree the divorce of persons not domiciled within its jurisdiction, and it will recognize foreign divorces if, and only if, they have been decreed by a jurisdiction to which the parties were subject by domicile or nationality. And the legitimation of a child by the subsequent marriage of its parents will be held to depend on the law of its father's domicile or nationality. But the reference to the place of contract, carried to North America with the rest of the English jurisprudence of that date, still maintains in the courts of the United States a struggle with the doctrine of personal law as governing capacity and status.

Here must be noticed a difficulty which arises about the application of any foreign law to the capacity for contracting. It will be understood by the German provision intended to meet it, namely, that "if a foreigner enters in Germany into a transaction for which he is incapable or has only a restricted capacity, he is to be treated for that transaction as being so far capable as he would be by the German legislation. This, however, does not apply to transactions with regard to rights of family or of succession, or to those disposing of foreign immovable property" (Art. 7 of the statute enacting the code). In a spirit similar to that which dictated the German enactment, the French courts have not generally allowed a Frenchman to suffer from the incapacity, by his personal law, of a foreigner who contracts in France, when the foreigner would have been capable by French law, and the Frenchman was in good faith and without great imprudence ignorant of his incapacity. Lately a disposition has been shown to limit this protection of nationals to the case in which the foreigner has been guilty of fraud. English courts usually hold themselves to be more stringently bound by rules, whether those enacted by parliament or those adopted for themselves; and if they should continue to profess the doctrine that capacity depends on the law of the domicile, it is not probable that they will deem themselves entitled to make exceptions for the protection of persons contracting in England with foreigners not enjoying such capacity. The point furnishes an illustration of the fact that to deal satisfactorily with so complex a subject as private international law requires the assistance of the legislature, which again cannot be given with full utility unless uniform provisions, to be enacted in different countries, are settled by international convention.

Another ground for the application of a personal law is furnished by the cases in which masses of property and rights have to be dealt with collectively, by reason of their being grouped around persons. The principal instances of that kind are when it is necessary to determine the validity and operation of a marriage settlement or contract, or the effect of marriage on the property of the husband and wife in the absence of any express settlement or contract, and when property passes on death, either by a will or by intestate succession.

These matters, at least when the property concerned is movable, are generally referred to the personal law of the husband at the time of the marriage, or to that of the deceased respectively; but about them, besides the question between domicile and nationality, there arises the question whether immovable property is to be included in the mass governed by the personal law, or is to follow the territorial law of its own situation (*lex situs*). Here we touch the distinction between *real* and *personal* statutes which arose in the middle ages, when the local legislation of the free cities was contrasted, under the name of statutes, with the general Roman law. That distinction did not bear the same character at all times, but

in the 16th century, under d'Argentré, it acquired its most developed form, absorbing all laws into one or other of the two classes, and giving a vast extension to the real class, for which was claimed exclusive application to immovables situate in the territory of the law. In accordance with this system, the highly feudal character of which was very sympathetic to English jurisprudence, English practice has refused to include English immovables in the mass to be dealt with as a unit on marriage or death. But it refers the validity and operation of a marriage settlement, at least as to movables, and the effect of marriage, in the absence of express contract, on the movable property of the husband and wife, to the law of the husband's domicile at the time of the marriage, called the matrimonial domicile. And with regard to the succession to movables on death, it adopts the principle of massing them irrespectively of their situation, so far as is permitted by the peculiar system under which the property in movables situate in England does not pass directly to the legatees or next of kin, but to the executors or administrators, who are charged with the duty of paying the debts of the deceased and distributing the beneficial surplus. The validity of a test of movables, or otherwise with respect of form (about which more hereafter), and the rights, whether under a will or under an intestacy, in the beneficial surplus arising from them, are determined in England by the law of the testator's last domicile. On the points glanced at in this paragraph the decisions in the United States generally agree with those in England, only allowing the pecuniary relations of a married couple, in the absence of express contract, to be varied by a change of domicile, notwithstanding that such change is in the husband's exclusive power, instead of maintaining them as fixed by the matrimonial domicile. On the continent of Europe variations of a marriage after marriage are scarcely to be found; but as between the nationality and the domicile of the husband or of the deceased, and on the question whether the mass to be governed either by nationality or domicile, on marriage or on death, includes immovables situate under a different law, the division of opinion, legislation and practice is considerable and intricate.

*Lex situs, lex loci actus, lex loci contractus, lex fori.*—The law of the territory in which they are situate (*lex situs*) is generally applied to the property in particular things, whether movable or immovable, so far as they are not included in any mass grouped round a person; in England, therefore, always to immovables. In drawing up documents and conducting ceremonies public functionaries must necessarily follow the law from which they derive their authority, whereas the law of the place where any public document is entered into, or any public ceremony performed (*lex loci actus*), is the only one that can be followed in its external form. This maxim applies to the forms of notarial acts, and to that of marriage celebrated with the official concurrence of clergymen, registrars and so forth. And since documents and ceremonies entered into without official concurrence are rarer on the continent of Europe than in England, the inevitableness of the form of the *lex actus*, when such concurrence is had, has generally led to that form being also held sufficient whenever the affair comes to be inquired into later. Nor in England has the sufficiency of the form of the *lex loci actus* for the celebration of marriage ever been doubted, but a will made by a notarial act in accordance with that law was not admitted. Disregarding the distinction between external form and internal validity and operation, a will of English land could not take effect unless made in English form (that is, since the Wills Act of 1837, with two witnesses), and a will of personal estate could not be admitted in England to probate unless made in the form of the law of the testator's last domicile. But now, by Lord Kingsdown's Act, passed in 1861, there are given for wills of personal property made by British subjects, besides the form of their last domicile, three alternative forms, namely, the form of the place of making the will, that of the testator's domicile at the time when it was made, and that of the part of the British dominions where he had his domicile of origin—only the first of the three, however, being offered when the will is made in the United Kingdom; and no will is to be revoked or invalidated by a change of the testator's domicile after making it.

The law of the place of contract *lex loci contractus*, is distinguished into that of the place where the contract is entered into, *lex loci contractus celebrati*, and that of the place where it is to be performed, which, from the particular case in which the performance consists only in a payment, is called *lex loci solutionis*. To the first of these is generally referred the formal validity of a contract, so far as entered into without the intervention of a functionary, and therefore not covered by the principle of the *lex loci actus*, and so far also as the performance is not tied to any particular place. For

example, the form for contracting marriage, whether with official intervention as in England, or by private and even oral contract as in Scotland, depends, both as to necessity and as to sufficiency, on the law of the place of contracting it. But as to the internal validity, interpretation and operation of a contract, there has been and still remains much difference of opinion between the laws of the place of contracting and of that of stipulated performance; the former being supported, among other grounds, on some texts of Roman law which Savigny has shown to have been misunderstood, while the latter agrees much oftener with the intention of the parties. The English decisions do not adhere closely to either of those laws, but while repeating much of the traditional language about the *lex loci contractus*, they aim at doing substantial justice by referring a contract to that place with which its matter has the closest connexion, or which the intention of the parties points out.

In matters of legal procedure every court follows its own practice exclusively (*lex fori*), as, for instance, whether the remedy on a contract shall be damages or specific performance, and whether a judgment may be executed against the person or only against the property of a party. A point much disputed under this head is whether the time of limitation of actions shall, as held in the United Kingdom, be decided by the *lex fori*, as an incident to the procedure, or by the *lex loci contractus* in one of its varieties, as an essential modality of the obligation.

*Renvoi.*—We will now suppose that the rules of private international law, as practised in any country (A), refer a case arising in its courts to the law of another country (B), as being that of the domicile or nationality of a person, and that those rules as practised in (B) in turn refer (*renvoi*) the same case to the law of (A), as being that of the nationality or domicile or perhaps of the *locus actus*: what are the courts of (A) to decide? This question, which involves nothing less than that of the meaning in which the reference to a law is to be understood in our subject, has during recent years excited great discussion both among the jurists and in the courts of all nations. It is answered by the English courts to the effect that (B) by its reference back (*renvoi*) has disclaimed the control of the case, which must therefore be decided without regard to (B)'s particular laws. See *In re Trufort*, 36 Ch. D. 600, and *In re Johnson*, 1903, 1 Ch. 821. This principle practically gives efficacy to the *renvoi*, and coincides with the express provisions both of the above-mentioned convention of the 12th of June 1902, Art. 1, as to the right of contracting marriage, and of the statute enacting the German code, Art. 27, as to capacity generally. The English law agrees in opinion, and is supported by a numerical preponderance of the judicial precedents in France and Belgium; but it must be admitted that a numerical preponderance of the jurists who have declared themselves hold that the courts of (A) ought to apply the particular laws of (B).

*Public Order.*—It must not be supposed that the law of the land, the proper territorial law of the court which has to deal with a case in which foreign circumstances arise, always gives way to the foreign law pointed out by the general maxims which even that particular court accepts. All rules for the application of foreign laws are subject to an exception commonly called that of public order, i.e. where such application would interfere with essential principles of morality or policy received in the territory. This reservation is usually made in general terms where legislation on private international law is attempted, as in Article 6 of the Code Napoleon, and preliminary Article 12 of the Italian code; but the courts have to administer it, as they have also in England and other countries where it rests only on judicial practice, and the greater or less extent given to it is one of the causes of the uncertainty and want of uniformity in our subject. One example often quoted is the refusal of the courts in all Christian countries to give effect to polygamous marriage, but this case goes deeper still, for none of the countries in which polygamous marriage exists is allowed to enter at all into the communion of private international law. All, so far as Great Britain has settled legal relations with them, are among those in which British subjects live under consular protection and jurisdiction, or (in Egypt) under that of the Mixed Courts. A better instance is afforded by the refusal of courts, normally within the pale of European legal communion, to recognize divorce as dissolving a marriage, notwithstanding that it has been decreed under the personal law. As another instance,



there can be little doubt that an incapacity to marry imposed by the personal law in virtue of religious vows or orders would be disregarded by the English courts in the case of a person marrying in England. Again, it is established in England that damages cannot be recovered for a tort unless the act complained of was a wrong both by the law of the country where it was done and by the law of England; and Article 12 of the statute enacting the German code is in accordance with that doctrine. Now the law of the country where the act is done would naturally give the standard for measuring its legal consequences, and it seems to be due to the connexion which laws qualifying acts as wrongs have with public order that respect for that law is tempered by respect for the law of the countries in which it is invoked; but Article 8 of the Belgian code refers the liability for torts to the former law without any restriction.

**Foreign Judgments.**—In the rules which have passed before us in the foregoing general review it is easy to perceive a leading motive—that of securing, so far as public order allows, the certainty and stability both of personal and of business relations in the international or interterritorial intercourse which has always accompanied civilization, but is now especially frequent and extensive. It has been attempted to erect this motive into a guiding principle of law, laying down that rights once accrued in any territory, or sometimes, it is said, by virtue of any territorial law, are to be recognized and enforced, subject to the requirements of public order, in any other territory in which they may be invoked before a court of justice. From this, which may be called the principle of the acceptance of foreign rights, it is claimed that the rules of private international law are to be deduced, and that by their consonance with it any such rules are to be tested when proposed. The difficulties of the subject, however, do not admit of being unlocked by so simple a key. They meet us again when we inquire in what territory, or by virtue of what territorial law, a particular alleged right has accrued. Persons belonging by domicile or nationality to A enter in B into a contract to be performed in C; where and by virtue of what law does either acquire a right against the other? Is it to be in or by the law of their homes, where they are normally, though not always necessarily, to be sued? Or of the country where they contract, which for various purposes, as those of police, but not for all purposes, has the control of them when they contract? Or of the country where their contract is to be performed, under a similar control by which, perhaps extending to the very acts of performance, they or their agents may be brought by the operation of their contract? Evidently we cannot apply the principle to guide us in our choice of a law till the very problem which that choice presents has first been solved. There is, however, one case in which the principle of the acceptance of foreign rights leads to a conclusion, namely, where the right has been declared by the judgment of a competent court, which may have been given in an ordinary case, presenting no question of private international law, but in which, if such a question arose, it has been solved by choosing the law and basing the judgment on it. The rule in England and in many other countries as to foreign judgments is that the judgments of competent courts in other territories (foreign in the sense of civil law, whether politically foreign or not) are to be enforced without reopening the merits of the questions disposed of by them. In some countries, however, a foreign judgment is examinable on its merits before being enforced. This was formerly the unquestioned rule in France, though the practice there seems to be now turning the other way. In the system adopted in England everything turns on the competence. For judgments *in rem*, declaring or disposing of the property in a thing, the test of competence is that the thing, whether movable or immovable, was within the territory of the court. Judgments which declare the status of a person, as with regard to marriage or majority, are competent if the person was subject to the jurisdiction by nationality or domicile. The property or the status is treated as being what has been so declared or decreed. For judgments *in personam*, decreeing the payment of a certain sum, the test of competence for the present purpose is again that the person

against whom it was pronounced was subject to the jurisdiction by nationality or domicile; the judgment may then be sued on as giving of itself a good title to the sum decreed by it to be paid. For domestic purposes the competence may exist on quite other grounds. By its own territorial law a court may be authorized to entertain a suit *in personam* because the plaintiff possesses its nationality, as by Article 14 of the code Napoleon, or because the contract sued on was made or was to be performed in the territory, and so forth. But judgments based on these grounds will not be enforceable outside the territory. Here we touch the root principles of our subject. The distinction between domestic and international grounds of competence can only be explained by the history of law, and we come in sight of the fact that the rules of private international law rest finally on conventions which could not have existed if the civilization of different countries had not so much that was common in its origin and in the course which it has followed, but which suit the life of those countries just because that life is itself another outcome of those common antecedents.

**AUTHORITIES.**—The best authority on the history of private international law to the end of the 18th century is Lainé, *Introduction au droit international privé* (2 vols., Paris, 1888). For modern progress the most copious materials are to be found in the *Revue de droit international et de législation comparée* (Brussels, from 1869); the *Journal du droit international privé et de la jurisprudence comparée* (Paris, from 1874); and the *Annuaire de l'Institut de droit international* (Paris, from 1877). The most comprehensive general treatise is that of von Bar, of which the 2d edition appeared at Göttingen in 1889, and has been translated: *The Theory and Practice of Private International Law*, by L. v. Bar, 2d ed., translated, by Gillespie (Edinburgh, 1892). Other works, many of great merit, are numerous in all languages; but in this, as in every department of law, the first place for England and the United States must be given to the different Law Reports, since in those countries it is not in the study but on the bench that the highest legal intellect is usually displayed, and the judgments delivered are often essays on the points involved. The following works, however, among others, treat the subject from the English or United States point of view: Story, *Commentaries on the Conflict of Laws, Foreign and Domestic*, 8th ed., by Bigelow (Boston, 1883); Wharton, *A Treatise on the Conflict of Laws or Private International Law* (2d ed., Philadelphia, 1881); J. Westlake, *A Treatise on Private International Law, with Principal Reference to its Practice in England* (4th ed., London, 1905); Foote, *A Concise Treatise on Private International Jurisprudence, based on the Decisions in the English Courts* (3rd ed., London, 1904); A. V. Dicey, *A Digest of the Law of England with Reference to the Conflict of Laws* (2nd ed., London, 1908); Beale, *A Selection of Cases on the Conflict of Laws, with Notes and Summary* (Cambridge, Mass., 1900-1903); Bate, *Notes on the Doctrine of Renvoi* (1904). (Jno. W.)

**INTERPELLATION** (from Lat. *interpellare*, to interrupt), a term meaning, in general, an interruption, more particularly used of a method of procedure adopted in some of the legislative chambers of continental Europe, especially those of France and Italy, and somewhat similar to that of a motion to adjourn the House in the British parliament. It was originally confined to the asking of a question, after due notice, on some affair of state. It is now, however, the chief means by which the policy or action of the ministry of the day is challenged. An interpellation can be brought on without the consent of the minister to be attacked; it is usually made the subject of a general debate, and generally ends with a vote of confidence or want of confidence in the ministry. The right of permitting or vetoing an interpellation rests with the chamber. In France a tendency has been growing among deputies to use the interpellation as a method of attack on or accusation against individual colleagues.

**INTERPLEADER**, in English law, the form of action by which a person who is sued at law by two or more parties claiming adversely to each other for the recovery of money or goods wherein he has no interest, obtains relief by procuring the rival claimants to try their rights between or among themselves only. Originally the only relief available to the possessor against such adverse claims was by means of a bill of interpleader in equity. The Interpleader Act 1833 enabled the defendant in such cases, on application to the court, to have the original action stayed and converted into a trial between the two claimants. The Common Law Procedure Act of 1860 further extended the power of the

common law courts in interpleader; and the Judicature Act 1875 enacted that the practice and procedure under these two statutes should apply to all divisions of the High Court of Justice. The Judicature Act also extended the remedy of interpleader to a debtor or other person liable in respect of a debt alleged to be assigned, when the assignment was disputed. In 1833 the acts of 1831 and 1860 were embodied in the form of rules by the *Rules of the Supreme Courts* (1883), O. lvii. by reference to which all questions of interpleader in the High Court of Justice are now determined. The acts themselves were repealed by the Statute Law Revision Act of the same year. Interpleader is the equivalent of multipoleading in Scots law.

**INTERPOLATION** (from Lat. *interpolare*, to alter, or insert something fresh, connected with *polire*, a polish), in mathematics, the process of obtaining intermediate terms of a series of which particular terms only are given. The cubes, for instance, shown in the second column of the accompanying table, may

Number.	Cube of Number.
0	0
1	1
2	8
3	27
4	64
5	125
6	216
.	.
.	.
.	.

be regarded as terms of a series, and the cube of a fractional number, not exceeding the last number in the first column, may be found by interpolation. The process of obtaining the cube of a number exceeding the last number in the first column would be *extrapolation*; the formulæ which apply to interpolation apply in theory to extrapolation, but in practice special precautions as to accuracy are necessary. The present article deals only with interpolation.

The term is usually limited to those cases in which there are two quantities,  $x$  and  $u$ , which are so related that when  $x$  has any arbitrary value, lying perhaps between certain limits, the value of  $u$  is determinate. There is a given series of associated values of  $u$  and of  $x$ , and interpolation consists in determining the value of  $u$  for any arbitrary value of  $x$ , or the value of  $x$  for any arbitrary value of  $u$ , lying between two of the values in the series. Either of the two quantities may be regarded as a function of the other; it is convenient to treat one,  $x$ , as the "independent variable," the other,  $u$ , being treated as the "dependent variable," i.e. as a function of  $x$ . If, as is usually the case, the successive values of one of the quantities proceed by a constant increment, this quantity is to be regarded as the independent variable. The two series of values may be tabulated, those of  $x$  being placed in a column (or row), and those of  $u$  in a parallel column (or row);  $u$  is then said to be *tabulated in terms of*  $x$ . The independent variable  $x$  is called the *argument*, and the dependent variable  $u$  is called the *entry*. Interpolation, in the ordinary sense, consists in determining the value of  $u$  for a value of  $x$  intermediate between two values appearing in the table. This may be described as *direct interpolation*, to distinguish it from *inverse interpolation*, which consists in determining the value of  $x$  for a value of  $u$  intermediate between two in the table. The methods employed can be extended to cases in which the value of  $u$  depends on the values of two or more independent quantities  $x, y, \dots$

In the ordinary case we may regard the values of  $x$  as measured along a straight line OX from a fixed point O, so that to any value of  $x$  there corresponds a point on the line. If we represent the corresponding value of  $u$  by an ordinate drawn from the line, the extremities of all such ordinates will lie on a curve which will be the graph of  $u$  with regard to  $x$ . Interpolation therefore consists in determining the length of the ordinate of a curve occupying a particular position, when the lengths of ordinates occupying certain specified positions are known. If  $u$  is a function of two variables,  $x$  and  $y$ , we may similarly represent it by the ordinate of a surface, the position of the ordinate being determined by the values of  $x$  and of  $y$  jointly.

The series or tables to which interpolation has to be applied may for convenience be regarded as falling into two main groups. The first group comprises mathematical tables, i.e. tables of mathematical functions; in the case of such a table the value of the function  $u$  for each tabulated value of  $x$  is calculated to a known degree of accuracy, and the degree of accuracy of an interpolated value of  $u$  can be estimated. The second group comprises tables of values which are found experimentally, e.g. values of a physical quantity or of a statistical ratio; these values are usually subject to certain "errors" of observation or of random selection (see **PROBABILITY**). The methods of interpolation are usually the same in the two groups of cases, but special considerations have to be taken into account in the second group. The line of demarcation of the two groups is not absolutely fixed; the tables used by actuaries, for instance, which are of great importance in practical life, are based on statistical observations, but the tables formed directly from the observations have been "smoothed" so as to obtain series which correspond in form to the series of values of mathematical functions.

It must be assumed, at any rate in the case of a mathematical function, that the "entry"  $u$  varies continuously with the "argument"  $x$ , i.e. that there are no sudden breaks, changes of direction, &c., in the curve which is the graph of  $u$ .

Various methods of interpolation are described below. The simplest is that which uses the *principle of proportional parts*; and mathematical tables are usually arranged so as to enable this method to be employed. Where this is not possible, the methods are based either on the use of Taylor's Theorem, which gives a formula involving differential coefficients (see **INFINITESIMAL CALCULUS**), or on the properties of finite differences (see **DIFFERENCES, CALCULUS OF**). Taylor's Theorem can only be applied directly to a known mathematical function; but it can be applied indirectly, by means of finite differences, in various cases where the form of the function expressing  $u$  in terms of  $x$  is unknown; and even where the form of this function is known it is sometimes more convenient to determine the differential coefficients by means of the differences than to calculate them directly from their mathematical expressions. Finally, there are cases where we cannot even employ finite-difference formulæ directly. In these cases we must adopt some special method; e.g. we may instead of  $u$  tabulate some function of  $u$ , such as its logarithm, which is found to be amenable to ordinary processes, then determine the value of this function corresponding to the particular value of  $x$ , and thence determine the corresponding value of  $u$  itself.

In considering methods of interpolation, it will be assumed, unless the contrary is stated, that the values of  $x$  proceed by a constant increment, which will be denoted by  $h$ .

In order to see what method is to be employed, it is usually necessary to arrange the given series of values of  $u$  in the form of a table, as explained above, and then to take the successive differences of  $u$ . The differences of the successive values of  $u$  are called its *first differences*; these form a new series, the first differences of which are the *second differences* of  $u$ ; and so on. The systems of notation of the differences are explained briefly below. For the fuller discussion, reference should be made to **DIFFERENCES, CALCULUS OF**.

## I. INTERPOLATION FROM MATHEMATICAL TABLES

### A. Direct Interpolation.

1. *Interpolation by First Differences.*—The simplest cases are those in which the first difference in  $u$  is constant, or nearly so. For example:—

Example 1.—( $u = \log_{10} x$ ).

$x$ .	$u$ .	1st Diff.
4·341	·6375898	+
4·342	·6376898	1000
4·343	·6377898	1000
4·344	·6378898	1000
4·345	·6379898	1000

Example 2.—( $u = \log_{10} x$ ).

$x$ .	$u$ .	1st Diff.
7·40	·86923	+
7·41	·86982	59
7·42	·87040	58
7·43	·87099	59
7·44	·87157	58

In Example 1 the first difference of  $u$  corresponding to a difference of  $h = .001$  in  $x$  is  $.0001000$ ; but, since we are working throughout to seven places of decimals, it is more convenient to write it 1000. This system of ignoring the decimal point in dealing with differences will be adopted throughout this article. To find  $u$  for an intermediate value of  $x$  we assume the principle of proportional parts, i.e. we assume that the difference in  $u$  is proportional to the difference in  $x$ . Thus for  $x = 4·342045$  the difference in  $u$  is  $.045$  of  $1000 = .045$ , so that  $u$  is  $.6376898 + .0000945 = .6377843$ . For  $x = 4·34204482$  the difference in  $u$  would be  $.04482$ , so that the value of  $u$  would apparently be  $.6376898 + .00004482 = .63778462$ . This, however, would be incorrect. It must be remembered that the values of  $u$  are only given "correct to seven places of decimals," i.e. each

tabulated value differs from the corresponding true value by a *tabular error* which may have any value up to  $\pm \frac{1}{2}$  of .0000001; and we cannot therefore by interpolation obtain a result which is correct to nine places. If the interpolated value of  $u$  has to be used in calculations for which it is important that this value should be as accurate as possible, it may be convenient to retain it temporarily in the form  $.637784298 + 944 \cdot 82 = .6377842 \cdot 82$  or  $.6376898 + 944 \cdot 82 = .637784298$ ; but we must ultimately return to the seven-place arrangement and write it as  $.6377843$ . The result of interpolation by first difference is thus usually subject to two inaccuracies, the first being the tabular error of  $u$  itself, and the second being due to the necessity of adjusting the final figure of the added (proportional) difference. If the tabulated values are correct to seven places of decimals, the interpolated value, with the final figure adjusted, will be within .000001 of its true value.

In Example 2 the differences do not at first sight appear to run regularly, but this is only due to the fact that the final figure in each value of  $u$  represents, as explained in the last paragraph, an approximation to the true value. The general principle on which we proceed is the same; but we use the actual difference corresponding to the interval in which the value of  $x$  lies. Thus for  $x = 7.41373$  we should have  $u = .86982 + (.373 \text{ of } .58) = .87004$ ; this result being correct within .00001.

2. *Interpolation by Second Differences.*—If the consecutive first differences of  $u$  are not approximately equal, we must take account of the next order of differences. For example:—

Example 3.—( $u = \log .ax$ ).

$x$ .	$u$ .	1st Diff.	2nd Diff.
6.0	.77815		
6.1	.78533	+718	
6.2	.79239	+706	-12
6.3	.79934	+695	-11
6.4	.80618	+684	-11
6.5	.81291	+673	

In such a case the *advancing-difference* formula is generally used. The notation is as follows. The series of values of  $x$  and of  $u$  are respectively  $x_0, x_1, x_2, \dots$  and  $u_0, u_1, u_2, \dots$ ; and the successive differences of  $u$  are denoted by  $\Delta u, \Delta^2 u, \dots$ . Thus  $\Delta u_0$  denotes  $u_1 - u_0$ , and  $\Delta^2 u_0$  denotes  $\Delta u_1 - \Delta u_0 = u_2 - 2u_1 + u_0$ . The value of  $z$  for which  $u$  is sought is supposed to lie between  $x_0$  and  $x_1$ . If we write it equal to  $x_0 + \theta(x_1 - x_0) = x_0 + \theta h$ , so that  $\theta$  lies between 0 and 1, we may denote it by  $x_\theta$ , and the corresponding value of  $u$  by  $u_\theta$ . We have then

$$u_\theta = u_0 + \theta \Delta u_0 - \frac{\theta(1-\theta)}{2!} \Delta^2 u_0 + \frac{\theta(1-\theta)(2-\theta)}{3!} \Delta^3 u_0 - \dots \quad (1).$$

Tables of the values of the coefficients of  $\Delta^2 u_0$  and  $\Delta^3 u_0$  to three places of decimals for various values of  $\theta$  from 0 to 1 are given in the ordinary collections of mathematical tables; but the formula is not really convenient if we have to go beyond  $\Delta^3 u_0$ , or if  $\Delta^4 u_0$  itself contains more than two significant figures.

To apply the formula to Example 3 for  $x = 6.277$ , we have  $\theta = .77$ , so that  $u_\theta = .79239 + (.77 \text{ of } .695) - (.089 \text{ of } -.11) = .79239 + .53515 + 0.08 = .79775$ .

Here, as elsewhere, we use two extra figures in the intermediate calculations, for the purpose of adjusting the final figure in the ultimate result.

3. *Taylor's Theorem.*—Where differences beyond the second are involved, Taylor's Theorem is useful. This theorem (see INFINITESIMAL CALCULUS) gives the formula

$$u_\theta = u_0 + c_1 \theta + c_2 \frac{\theta^2}{2!} + c_3 \frac{\theta^3}{3!} + \dots \quad (2),$$

where,  $c_1, c_2, c_3, \dots$  are the values for  $x = x_0$  of the first, second, third, ... differential coefficients of  $u$  with regard to  $x$ . The values of  $c_1, c_2, \dots$  can occasionally be calculated from the analytical expressions for the differential coefficients of  $u$ ; but more generally they have to be calculated from the tabulated differences. For this purpose *central-difference* formulæ are the best. If we write

$$\left. \begin{aligned} \mu \delta u_0 &= \frac{1}{2}(\Delta u_0 + \Delta u_{-1}) \\ \delta^2 u_0 &= \Delta^2 u_{-1} \\ \mu^2 \delta^2 u_0 &= \frac{1}{2}(\Delta^2 u_{-1} + \Delta^2 u_{-2}) \\ &\& \dots \end{aligned} \right\} \quad (3),$$

so that, if (as in §§ 1 and 2) each difference is placed opposite the space between the two quantities of which it is the difference, the expressions  $\delta^2 u_0, \delta^4 u_0, \dots$  denote the differences of even order in a horizontal line with  $u_0$  and  $\mu \delta u_0, \mu^2 \delta^2 u_0, \dots$  denote the means of the differences of odd order immediately below and above this

line, then (see DIFFERENCES, CALCULUS OF) the values of  $c_1, c_2, \dots$  are given by

$$\left. \begin{aligned} c_1 &= \mu \delta u_0 = \frac{1}{2} \delta^2 u_0 + \frac{1}{24} \delta^4 u_0 - \frac{1}{720} \delta^6 u_0 + \dots \\ c_2 &= \delta^2 u_0 - \frac{1}{24} \delta^4 u_0 + \frac{1}{720} \delta^6 u_0 - \frac{1}{4200} \delta^8 u_0 + \dots \\ c_3 &= \mu^2 \delta^2 u_0 = \frac{1}{2} \delta^2 u_0 + \frac{1}{24} \delta^4 u_0 - \dots \\ c_4 &= \delta^4 u_0 - \frac{1}{24} \delta^6 u_0 + \frac{1}{720} \delta^8 u_0 - \dots \\ c_5 &= \mu^3 \delta^3 u_0 = \frac{3}{8} \delta^3 u_0 + \dots \\ c_6 &= \delta^6 u_0 - \frac{1}{24} \delta^8 u_0 + \dots \\ &\vdots \end{aligned} \right\} \quad (4).$$

If a calculating machine is used, the formula (2) is most conveniently written

$$\left. \begin{aligned} u_\theta &= u_0 + P \cdot \theta \\ P_1 &= c_1 + \frac{1}{2} P \cdot \theta \\ P_2 &= c_2 + \frac{1}{2} P \cdot \theta \\ &\vdots \end{aligned} \right\} \quad (5).$$

Using  $\theta$  as the multiplier in each case, the successive expressions  $\dots, P_1, P_2, P_3, u_\theta$  are easily calculated.

As an example, take  $u = \tan x$  to five places of decimals, the values of  $x$  proceeding by a difference of  $1^\circ$ . It will be found that the following is part of the table:—

Example 4.—( $u = \tan x$ ).

$x$ .	$u$ .	1st Diff.	2nd Diff.	3rd Diff.	4th Diff.
65°	2.14451	+	+	+	+
			732		16
66°	2.24604	10153	828	96	19
67°	2.35585	10981	943	115	18

To find  $u$  for  $x = 66^\circ 23'$ , we have  $\theta = .23/60 = .383333$ . The following shows the full working; in actual practice it would be abbreviated. The operations commence on the right-hand side. It will be noticed that two extra figures are retained throughout.

$$\begin{array}{r} u_0 = 2.24604 \\ \mu \delta u_0 = +105679 \\ \delta^2 u_0 = \pm 8.89 \\ \mu^2 \delta^2 u_0 = +105302 \\ \delta^3 u_0 = \pm 8.89 \\ \mu^3 \delta^3 u_0 = +105302 \\ \delta^4 u_0 = \pm 1920 \end{array} \quad \begin{array}{l} P_1 = +10710 \\ P_2 = +84013 \\ P_3 = +10722 \end{array} \quad \begin{array}{l} \delta u_\theta = +1920 \\ \delta^2 u_\theta = +105302 \\ \delta^3 u_\theta = +105302 \\ \delta^4 u_\theta = +1920 \end{array} \quad \begin{array}{l} 4 = +1920 \\ 4 = +1920 \\ 4 = +1920 \\ 4 = +1920 \end{array}$$

The value 2.287067, obtained by retaining the extra figures, is correct within .7 of .00001 (§ 8), so that 2.28710 is correct within .00001.

In applying this method to mathematical tables, it is desirable, on account of the tabular error, that the differences taken into account in (4) should end with a difference of even order. If, e.g. we use  $\mu \delta^2 u_0$  in calculating  $c_1$  and  $c_2$ , we ought also to use  $\delta^2 u_0$  for calculating  $c_3$  and  $c_4$ , even though the term due to  $\delta^4 u_0$  would be negligible if  $\delta^2 u_0$  were known exactly.

4. *Geometrical and Algebraical Interpolation.*—In applying the principle of proportional parts, in such a case as that of Example 1, we in effect treat the graph of  $u$  as a straight line. We see that the extremities of a number of consecutive ordinates lie approximately in a straight line; i.e. that, if the values are correct within  $\pm \mu$ , a straight line passes through points which are within a corresponding distance of the actual extremities of the ordinates; and we assume that this is true for intermediate ordinates. Algebraically we treat  $u$  as being of the form  $A + Bx$ , where  $A$  and  $B$  are constants determined by the values of  $u$  at the extremities of the interval through which we interpolate. In using first and second differences we treat  $u$  as being of the form  $A + Bx + Cx^2$ ; i.e. we pass a parabola (with axis vertical) through the extremities of three consecutive ordinates, and consider that this is the graph of  $u$ , to the degree of accuracy given by the data. Similarly in using differences of a higher order we replace the graph by a curve whose equation is of the form  $u = A + Bx + Cx^2 + Dx^3 + \dots$ . The various forms that interpolation-formulae take are due to the various principles on which ordinates are selected for determining the values of  $A, B, C, \dots$

B. Inverse Interpolation.

5. To find the value of  $x$  when  $u$  is given, i.e. to find the value of  $\theta$  when  $u_\theta$  is given, we use the same formula as for direct interpolation, but proceed (if differences beyond the first are involved) by successive approximation. Taylor's Theorem, for instance, gives

$$\begin{aligned} \theta &= (u_\theta - u_0) \div (c_1 + c_2 \frac{\theta}{2!} + \dots) \\ &= (u_\theta - u_0) \div P_1 \end{aligned} \quad (6),$$

We first find an approximate value for  $\theta$ ; then calculate  $P_1$ , and find by (6) a more accurate value of  $\theta$ ; then, if necessary, recalculate  $P_1$ , and thence  $\theta$ , and so on.

## II. CONSTRUCTION OF TABLES BY SUBDIVISION OF INTERVALS

6. When the values of  $u$  have been tabulated for values of  $x$  proceeding by a difference  $h$ , it is often desirable to deduce a table in which the differences of  $x$  are  $h/n$ , where  $n$  is an integer.

If  $n$  is even it may be advisable to form an intermediate table in which the intervals are  $\frac{1}{2}h$ . For this purpose we have

$$u_{\frac{1}{2}} = \frac{1}{2}(U_0 + U_1) \quad (7).$$

where

$$U = u - \frac{1}{2}\delta^2 u + \frac{1}{8}\delta^4 u - \frac{1}{16}\delta^6 u + \dots \\ = u - \frac{1}{8}[\delta^2 u - \frac{1}{4}\delta^4 u - \frac{1}{8}\delta^6 u + \dots] \quad (8).$$

The following is an example; the data are the values of  $\tan x$  at five places of decimals, the interval in  $x$  being  $1^\circ$ . The differences of odd order are omitted for convenience of printing.

Example 5.

$x$ .	$u \equiv \tan x$ .	$\delta^2 u$ .	$\delta^4 u$ .	$\delta^6 u$ .	$U$ .	$u = \text{mean of values of } U$ .	$x$ .
$73^\circ$	3.27085	+ 239	+ 100	+	3.26794 95	3.27594	$73\frac{1}{2}^\circ$
$74^\circ$	3.48741	2808	132	23	3.48392 98	3.60588	$74\frac{1}{2}^\circ$
$75^\circ$	3.73205	3409	187	18	3.72783 17	3.86671	$75\frac{1}{2}^\circ$
$76^\circ$	4.01078	4197	260	51	4.00559 22	4.16530	$76\frac{1}{2}^\circ$
$77^\circ$	4.33148	5245	384	64	4.32501 07		

If a new table is formed from these values, the intervals being  $\frac{1}{2}^\circ$ , it will be found that differences beyond the fourth are negligible.

To subdivide  $h$  into smaller intervals than  $\frac{1}{2}h$ , various methods may be used. One is to calculate the sets of quantities which in the new table will be the successive differences, corresponding to  $u_0, u_1, \dots$ , and to find the intermediate terms by successive additions. A better method is to use a formula due to J. D. Everett. If we write  $\phi = 1 - \theta$ , Everett's formula is, in its most symmetrical form,

$$u_\theta = \theta u_1 + \frac{(\theta+1)\theta(\theta-1)}{3!}\delta^3 u_1 + \frac{(\theta+2)(\theta+1)\theta(\theta-1)(\theta-2)}{5!}\delta^5 u_1 + \dots \\ + \phi u_0 + \frac{(\phi+1)\phi(\phi-1)}{3!}\delta^3 u_0 + \frac{(\phi+2)(\phi+1)\phi(\phi-1)(\phi-2)}{5!}\delta^5 u_0 + \dots \quad (9).$$

For actual calculations a less symmetrical form may be used. Denoting

$$\frac{(\theta+1)\theta(\theta-1)}{3!}\delta^3 u_1 + \frac{(\theta+2)(\theta+1)\theta(\theta-1)(\theta-2)}{5!}\delta^5 u_1 + \dots \quad (10)$$

by  $\phi V_1$ , we have, for interpolation between  $u_0$  and  $u_1$ ,

$$u_\theta = u_0 + \theta \Delta u_0 + \phi V_1 + 1 - \phi V_0 \quad (11),$$

the successive values of  $\theta$  being  $1/n, 2/n, \dots, (n-1)/n$ . For interpolation between  $u_1$  and  $u_2$  we have, with the same succession of values of  $\theta$ ,

$$u_{1+\theta} = u_1 + \theta V_1, \quad V_2 + 1 - \phi V_1 \quad (12).$$

The values of  $1 - \phi V_1$  in (12) are exactly the same as those of  $\phi V_1$  in (11), but in the reverse order. The process is therefore that (i.) we find the successive values of  $u_0 + \theta \Delta u_0$ , &c., i.e. we construct a table, with the required intervals of  $x$ , as if we had only to take first differences into account; (ii.) we construct, in a parallel column, a table giving the values of  $\phi V_1$ , &c.; (iii.) we repeat these latter values, placing the set belonging to each interval  $h$  in the interval next following it, and writing the values in the reverse order; and (iv.) by adding horizontally we get the final values for the new table.

As an example, take the values of  $\tan x$  by intervals of  $1'$  in  $x$ , as found above (Ex. 5). The first diagram below is a portion of this table, with the differences, and the second shows the calculation of the terms of (11) so as to get a table in which the intervals are  $0.1$  of  $1^\circ$ . The last column but one in the second diagram is introduced for convenience of calculation.

Example 6.

$x$ .	$u = \tan x$ .	$\delta u$ .	$\delta^2 u$ .	$\delta^3 u$ .	$\delta^4 u$ .
		+	+	+	+
$74^\circ 0'$	3.48741	11147	700	62	8
$74^\circ 5'$	3.60588	11847	770	70	9
		12617	79		

$x$	$u_0 + \theta \Delta u_0$ .	$\phi V_1$ .	$1 - \phi V_0$ .	$\phi V_1 + 1 - \phi V_0$ .	$u$ .
$73^\circ 6'$	.	-22 35	.	.	.
$73^\circ 7'$	.	-39 11	.	.	.
$73^\circ 8'$	.	-44 71	.	.	.
$73^\circ 9'$	.	-33 54	.	.	.
$74^\circ 0'$	3.48741 00				3.48741
$74^\circ 1'$	3.51110 40	-24 58	-33 54	-58 12	3.51052
$74^\circ 2'$	3.53479 80	-43 02	-44 71	-87 73	3.53392
$74^\circ 3'$	3.55849 20	-49 18	-39 11	-88 29	3.55761
$74^\circ 4'$	3.58218 60	-36 89	-22 35	-59 24	3.58159
$74^\circ 5'$	3.60588 00				3.60588

The following are the values of the coefficients of  $u_1, \delta^2 u_1, \delta^4 u_1$ , and  $\delta^6 u_1$  in (9) for certain values of  $n$ . For calculating the four terms in (9) in the case of  $n = 5$  it should be noticed that the third term is twice the first, the fourth is the mean of the first and the third, and the second is the mean of the third and the fourth. In table 3, and in the last column of table 2, the coefficients are corrected in the last figure.

TABLE 1.— $n = 5$ .

CO. $u$ .	CO. $\delta^2 u$ .	CO. $\delta^4 u$ .	CO. $\delta^6 u$ .
+	—	+	—
+	-02	-006336	-00135168 = $1/740$ approx.
-2	-056	-010752	-00226304 = $1/442$ "
-6	-064	-008648	-00239616 = $1/417$ "
-8	-048	-008064	-00160512 = $1/623$ "

TABLE 2.— $n = 10$ .

CO. $u$ .	CO. $\delta^2 u$ .	CO. $\delta^4 u$ .	CO. $\delta^6 u$ .
+	—	+	—
-1	-0165	-00329175	-000704591
-2	-0320	-00633600	-001351680
-3	-0455	-00889325	-001887064
-4	-0560	-01075200	-002263040
-5	-0625	-01171875	-002441406
-6	-0640	-01164800	-002396160
-7	-0595	-01044225	-002115799
-8	-0480	-00806400	-001605120
-9	-0285	-00454575	-000886421

TABLE 3.— $n = 12$ .

CO. $u$ .	CO. $\delta^2 u$ .	CO. $\delta^4 u$ .	CO. $\delta^6 u$ .
+	—	+	—
1/12	-013792438	-002753699	-000580623
2/12	-027006173	-005363726	-001145822
3/12	-039602500	-007690430	-001630505
4/12	-049382716	-009602195	-002032211
5/12	-057388117	-010979453	-002307357
6/12	-062500000	-011718750	-002441406
7/12	-064139660	-011736667	-002419911
8/12	-061728395	-010973937	-002235432
9/12	-054687500	-009399414	-001888275
10/12	-042438272	-007014103	-001389048
11/12	-024402006	-003855178	-000748981

## III. GENERAL OBSERVATIONS

7. Derivation of Formulae.—The advancing-difference formula (1) may be written, in the symbolical notation of finite differences,

$$u_\theta = (1 + \Delta)^n u_0 = E^n u_0 \quad (13);$$

and it is an extension of the theorem that if  $n$  is a positive integer

$$u_n = u_0 + n \Delta u_0 + \frac{n(n-1)}{2!} \Delta^2 u_0 + \dots \quad (14),$$

the series being continued until the terms vanish. The formula (14) is identically true; the formula (13) or (1) is only formally true, but its applicability to concrete cases is due to the fact that the series in (1), when taken for a definite number of terms, differs from the true value of  $u_\theta$  by a "remainder" which in most cases is very small when this definite number of terms is properly chosen.

Everett's formula (9), and the central-difference formula obtained by substituting from (4) in (2), are modifications of a standard formula

$$u_\theta = u_0 + \theta \delta u_0 + \frac{\theta(\theta-1)}{2!} \delta^2 u_0 + \frac{(\theta+1)\theta(\theta-1)}{3!} \delta^3 u_1 + \dots \\ + \frac{(\theta+1)\theta(\theta-1)(\theta-2)}{4!} \delta^4 u_0 + \dots \quad (15).$$

which may similarly be regarded as an extension of the theorem that, if  $n$  is a positive integer,

$$u_n = u_0 + n\delta u_1 + \frac{n(n-1)}{2!}\delta^2 u_2 + \frac{(n+1)n(n-1)}{3!}\delta^3 u_3 + \dots \quad (16).$$

There are other central-difference formulae besides those mentioned above; the general symbolical expression is

$$u_\theta = (\cosh \theta h D + \sinh \theta h D) u_0 \quad (17),$$

where

$$\cosh \frac{1}{2} h D = \mu, \quad \sinh \frac{1}{2} h D = \frac{1}{2} \delta \quad (18).$$

8. *Comparative Accuracy.*—Central-difference formulae are usually more accurate than advancing-difference formulae, whether we consider the inaccuracy due to omission of the "remainder" mentioned in the last paragraph or the error due to the approximate character of the tabulated values. The latter is the more important. If each tabulated value of  $u$  is within  $\pm \frac{1}{2} \rho$  of the corresponding true value, and if the differences used in the formulae are the tabular differences, i.e. the actual successive differences of the tabulated values of  $u$ , then the ratio of the limit of error of  $u_\theta$ , as calculated from the first  $r$  terms of the series in (1), to  $\frac{1}{2} \rho$  is the sum of the first  $r$  terms of the series

$$1 + \theta + \theta(1-\theta) + \theta(1-\theta)(2-\theta) + \theta^2 \theta(1-\theta)(2-\theta)(3-\theta) + \frac{\theta^3 \theta(1-\theta)(2-\theta)(3-\theta)(4-\theta)}{2!} + \frac{\theta^4 \theta(1-\theta)(2-\theta)(3-\theta)(4-\theta)(5-\theta)}{3!} + \dots,$$

while the corresponding ratio for the use of differences up to  $\delta^p u_0$  inclusive in (4) or to  $\delta^p u_1$  and  $\delta^p u_2$  in (9) (i.e. in effect, up to  $\delta^{p+1} u_1$ ) is the sum of the first  $p+1$  terms of the series

$$1 + \frac{\theta(1-\theta)}{1} + \frac{(1+\theta)\theta(1-\theta)(2-\theta)}{(2!)^2} + \frac{(2+\theta)(1+\theta)\theta(1-\theta)(2-\theta)(3-\theta)}{(3!)^2} + \dots$$

it being supposed in each case that  $\theta$  lies between 0 and 1. The following table gives a comparison of the respective limits of error; the lines I. and II. give the errors due to the advancing-difference and the central-difference formulae, and the coefficient  $\rho$  is omitted throughout.

TABLE 4.

		Error due to use of Differences up to and including						
		1st.	2nd.	3rd.	4th.	5th.	6th.	7th.
.5	I.	.500	.625	.813	1.086	1.497	2.132	3.147
	II.	.500	.625	.625	.696	.696	.745	.745
.2	I.	.500	.580	.724	.960	1.343	1.976	3.042
	II.	.500	.580	.580	.624	.624	.653	.653
.4	I.	.500	.620	.812	1.104	1.553	2.265	3.422
	II.	.500	.620	.620	.688	.688	.734	.734
.6	I.	.500	.620	.788	1.024	1.366	1.886	2.700
	II.	.500	.620	.620	.688	.688	.734	.734
.8	I.	.500	.580	.676	.800	.969	1.213	1.824
	II.	.500	.580	.580	.624	.624	.653	.653

In some cases the differences tabulated are not the tabular differences, but the corrected differences; i.e. each difference, like each value of  $u$ , is correct within  $\pm \frac{1}{2} \rho$ . It does not follow that these differences should be used for interpolation. Whatever formula is employed, the first difference should always be the tabular first difference, not the corrected first difference; and, further, if a central-difference formula is used, each difference of odd order should be the tabular difference of the corrected differences of the next lower order. (This last result is indirectly achieved if Everett's formula is used.) With these precautions (i.) the central-difference formula is slightly improved by using corrected instead of tabular differences, and (ii.) the advancing-difference formula is greatly improved, being better than the central-difference formula with tabular differences, but still not so good as the latter with corrected differences. For  $\theta = .5$ , for instance, supposing we have to go to fifth differences, the limits  $\pm 1.497$  and  $\pm .696$ , as given above, become  $\pm .627$  and  $\pm .575$  respectively.

9. *Completion of Table of Differences.*—If no values of  $u$  outside the range within which we have to interpolate are given, the series of differences will be incomplete at both ends. It may be continued in each direction by treating as constant the extreme difference of the highest order involved; and central-difference formulae can then be employed uniformly throughout the whole range.

Suppose, for instance, that the values of  $\tan x$  in § 6 extended

only from  $x=60^\circ$  to  $x=80^\circ$ , we could then complete the table of differences by making the entries shown in italics below.

Example 7.

$x$ .	$u = \tan x$ .	$\delta u$ .	$\delta^2 u$ .	$\delta^3 u$ .	$\delta^4 u$ .	$\delta^5 u$ .	$\delta^6 u$ .
		+	+	+	+	+	+
$60^\circ$	1.73205	<i>0775</i>	425	34	0	0	0
$61^\circ$	1.80405	7200	468	43	9	0	0
$62^\circ$	1.88073	7668	520	52	9	0	0
$63^\circ$	1.96261	8188	581	61	10	0	0
$64^\circ$	2.05030	8769	652	71	9	0	0
.	.	.	.	.	.	.	.
.	.	.	.	.	.	.	.
.	.	.	.	.	.	.	.
$75^\circ$	3.73205	27873	3409	788	187	73	18
$76^\circ$	4.01078	32070	4197	1048	260	124	51
$77^\circ$	4.33148	37315	5245	1432	384	188	64
$78^\circ$	4.70463	43992	6677	1976	572	252	64
$79^\circ$	5.14455	52673	8681	2828	824	316	64
$80^\circ$	5.67128	<i>64182</i>	<i>11509</i>	<i>3968</i>	<i>1140</i>	<i>380</i>	<i>64</i>

For interpolating between  $x=60^\circ$  and  $x=61^\circ$  we should obtain the same result by applying Everett's formula to this table as by using the advancing-difference formula; and similarly at the other end for the receding differences.

Interpolation by Substituted Tabulation.

10. The relation of  $u$  to  $x$  may be such that the successive differences of  $u$  increase rapidly, so that interpolation-formulae cannot be employed directly. Other methods have then to be used. The best method is to replace  $x$  by some expression  $v$  which is a function of  $u$  such that (i.) the value of  $v$  or of  $x$  can be determined for any given value of  $u$  or of  $v$ , and (ii.) when  $v$  is tabulated in terms of  $x$  the differences decrease rapidly. We can then calculate  $v$ , and thence  $u$ , for any intermediate value of  $x$ .

If, for instance, we require  $\tan x$  for a value of  $x$  which is nearly  $90^\circ$ , it will be found that the table of tangents is not suitable for interpolation. We can, however, convert it into a table of cotangents to about the same number of significant figures; from this we can easily calculate  $\cot x$ , and thence  $\tan x$ .

11. This method is specially suitable for statistical data, where the successive values of  $u$  represent the area of a figure of frequency up to successive ordinates. We have first to determine, by inspection, a curve which bears a general similarity to the unknown curve of frequency, and whose area and abscissa are so related that either can be readily calculated with the other is known. This may be called the *auxiliary curve*. Denoting by  $\xi$  the abscissa of this curve which corresponds to area  $u$ , we find the value of  $\xi$  corresponding to each of the given values of  $u$ . Then, tabulating  $\xi$  in terms of  $x$ , we have a table in which, if the auxiliary curve has been well chosen, differences of  $\xi$  after the first or second are negligible. We can therefore find  $\xi$ , and thence  $u$ , for any intermediate value of  $x$ .

Extensions.

12. *Construction of Formulae.*—Any difference of  $u$  of the  $r$ th order involves  $r+1$  consecutive values of  $u$ , and it might be expressed by the suffixes which indicate these values. Thus we might write the table of differences

$x$ .	$u$ .	1st Dif.	2nd Dif.	3rd Dif.	4th Dif.
.	.	.	.	.	.
.	.	.	.	.	.
.	.	.	.	.	.
.	.	(-1, 0)	.	.	.
$x_0$	$u_0$	(0, 1)	(-1, 0, 1)	(-2, -1, 0, 1)	(-2, -1, 0, 1, 2)
$x_1$	$u_1$	(1, 2)	(0, 1, 2)	(-1, 0, 1, 2)	(-1, 0, 1, 2, 3)
$x_2$	$u_2$	(2, 3)	(1, 2, 3)	(0, 1, 2, 3, 4)	(0, 1, 2, 3, 4)
.	.	.	.	.	.
.	.	.	.	.	.
.	.	.	.	.	.
.	.	.	.	.	.

The formulae (1) and (15) might then be written

$$u = u_0 + \frac{x-x_0}{h}(0, 1) + \frac{x-x_0}{h} \cdot \frac{x-x_0}{2h} (0, 1, 2) + \frac{x-x_0}{h} \cdot \frac{x-x_0}{2h} \cdot \frac{x-x_0}{3h} (0, 1, 2, 3) + \dots (19),$$

$$u = u_0 + \frac{x-x_0}{h}(0, 1) + \frac{x-x_0}{h} \cdot \frac{x-x_0}{2h} (-1, 0, 1) + \frac{x-x_0}{h} \cdot \frac{x-x_0}{2h} \cdot \frac{x-x_0}{3h} (-1, 0, 1, 2) + \dots (20).$$

The general principle on which these formulae are constructed, and which may be used to construct other formulae, is that (i.) we start with any tabulated value of  $u$ , (ii.) we pass to the successive differences by steps, each of which may be either downwards or upwards, and (iii.) the new suffix which is introduced at each step determines the new factor (involving  $x$ ) for use in the next term. For any particular value of  $x$ , however, all formulae which end with the same difference of the  $r$ th order give the same result, provided tabular differences are used. If, for instance, we go only to first differences, we have

$$u_0 + \frac{x-x_0}{h}(0, 1) = u_1 + \frac{x-x_1}{h}(0, 1)$$

identically.

13. *Ordinates not Equidistant.*—When the successive ordinates in the graph of  $u$  are not equidistant, i.e. when the differences of successive values of  $x$  are not equal, the above principle still applies, provided the differences are adjusted in a particular way. Let the values of  $x$  for which  $u$  is tabulated be  $x = x_0 + ah$ ,  $b = x_0 + \beta h$ ,  $c = x_0 + \gamma h$ , . . . Then the table becomes

x.	u.	Adjusted Differences.		
		1st Diff.	2nd Diff.	&c.
.	.	.	.	.
.	.	.	.	.
.	.	.	.	.
$a = x_n$	$u_n$	( $\alpha, \beta$ )	( $\alpha, \beta, \gamma$ )	
$b = x_\beta$	$u_\beta$	( $\beta, \gamma$ )		
$c = x_\gamma$	$u_\gamma$			
.	.	.	.	.
.	.	.	.	.

In this table, however, ( $\alpha, \beta$ ) does not mean  $u_\beta - u_\alpha$ , but ( $u_\beta - u_\alpha$ )  $\div$  ( $\beta - \alpha$ ); ( $\alpha, \beta, \gamma$ ) means  $\{(\beta, \gamma) - (\alpha, \beta)\} \div (\gamma - \alpha)$ ; and, generally any quantity ( $\eta, \dots, \phi$ ) in the column headed "rth diff." is obtained by dividing the difference of the adjoining quantities in the preceding column by  $(\phi - \eta) / r$ . If the table is formed in this way, we may apply the principle of § 12 so as to obtain formulae such as

$$u = u_a + \frac{x-a}{h} \cdot (\alpha, \beta) + \frac{x-a}{h} \cdot \frac{x-a}{2h} \cdot (\alpha, \beta, \gamma) + \dots (21),$$

$$u = u_\gamma + \frac{x-c}{h} \cdot (\beta, \gamma) + \frac{x-c}{h} \cdot \frac{x-b}{2h} \cdot (\alpha, \beta, \gamma) + \dots (22).$$

The following example illustrates the method,  $h$  being taken to be 1°:

Example 8.

x.	u = sin x.	1st Diff. (adjusted).	2nd Diff. (adjusted).	3rd Diff. (adjusted).
		+	-	-
20°	.3420201	162932 50	1125 00	48 75
22°	.3746066	161245 00	1222 50	48 30
23°	.3907311	158800 00	1303 00	47 49
26°	.4383711	156194 00	1445 47	46 00
27°	.4539905	151857 60	1583 48	
32°	.5299193	145523 67		
35°	.5735764			

To find  $u$  for  $x = 31^\circ$ , we use the values for 26°, 27°, 32° and 35°, and obtain

$$u = .4383711 + \frac{5}{1} (156194 00) + \frac{5}{1} \cdot \frac{1}{2} (-1445 47) + \frac{5}{1} \cdot \frac{4}{2} \cdot \frac{1}{3} (-46 00) = .5150380,$$

which is only wrong in the last figure.

If the values of  $u$  occurring in (21) or (22) are  $u_a, u_\beta, u_\gamma, \dots, u_n$ , corresponding to values  $a, b, c, \dots, l$  of  $x$ , the formula may be more symmetrically written

$$u = \frac{(x-b)(x-c) \dots (x-l)}{(a-b)(a-c) \dots (a-l)} u_a + \frac{(x-a)(x-c) \dots (x-l)}{(b-a)(b-c) \dots (b-l)} u_\beta + \dots + \frac{(x-a)(x-b)(x-c) \dots (x-l)}{(l-a)(l-b)(l-c) \dots l} u_n \quad (23).$$

This is known as *Lagrange's formula*, and it is said to be due to Euler. It is not convenient for practical use, since it does not show how many terms have to be taken in any particular case.

14. *Interpolation from Tables of Double Entry.*—When  $u$  is a function of  $x$  and  $y$ , and is tabulated in terms of  $x$  and  $y$  jointly, its calculation for a pair of values not given in the table may be effected either directly or by first forming a table of values of  $u$  in terms of  $y$  for the particular value of  $x$  and then determining  $u$  from this table for the particular value of  $y$ . For direct interpolation, consider that  $\Delta$  represents differencing by changing  $x$  into  $x+1$ , and  $\Delta'$  differencing by changing  $y$  into  $y+1$ . Then the formula is

$$u_{x,y} = (1+\Delta)^x (1+\Delta')^y u_{0,0};$$

and the right-hand side can be developed in whatever form is most convenient for the particular case.

REFERENCES.—For general formulae, with particular applications, see the *Text-book of the Institute of Actuaries*, part ii. (1st ed. 1887, 2nd ed. 1902), p. 434; H. L. Rice, *Theory and Practice of Interpolation* (1899). Some historical references are given by C. W. Merrifield, "On Quadratures and Interpolation," *Brit. Assoc. Report* (1880), p. 321; see also *Encycl. der math. Wiss.* vol. i. pt. 2, pp. 800-819. For J. D. Everett's formula, see *Quar. Jour. Pure and Applied Maths.*, No. 128 (1901), and *Jour. Inst. Actuaries*, vol. xxxv. (1901), p. 452. As to relative accuracy of different formulae, see *Proc. Lon. Math. Soc.* (2) vol. iv. p. 320. Examples of interpolation by means of auxiliary curves will be found in *Jour. Royal Stat. Soc.* vol. lxiii. pp. 433, 637. See also DIFFERENCES, CALCULUS OF. (W. F. SH.)

**INTERPRETATION** (from Lat. *interpretari*, to expound, explain, *interpret*, an agent, go-between, interpreter; *inter*, between, and the root *pret-*, possibly connected with that seen either in Greek  $\phi\rho\acute{\alpha}\gamma\epsilon\upsilon\omega$ , to speak, or  $\pi\rho\acute{\alpha}\tau\epsilon\upsilon\omega$ , to do), in general, the action of explaining, or rendering the sense of an obscure form of words or an unknown tongue into a language comprehended by the person addressed. In legal use the word "interpretation" is employed in the sense of ascertaining the meaning of the language of a document, as well as its relation to facts. It is also applied to acts of parliament, as pointing out the sense in which particular words used therein are to be understood. The interpretation of documents and statutes is subject to definite legal rules, the more important of which will be found in the articles CONTRACT, STATUTE, WILL, &c.

**INTERREGNUM** (Lat. *inter*, between, and *regnum*, reign), strictly a period during which the normal constituted authority is in abeyance, and government is carried on by a temporary authority specially appointed. Though originally and specifically confined to the sphere of sovereign authority, the term is commonly used by analogy in other connexions for any suspension of authority, during which affairs are carried on by specially appointed persons. The term originated in Rome during the regular period when an *interrex* was appointed (traditionally by the senate) to carry on the government between the death of one king and the election of his successor (see *ROME: History, ad init.*). It was subsequently used in Republican times of an officer appointed to hold the *comitia* for the election of the consuls when for some reason the retiring consuls had not done so. In the regular period when the senate, instead of appointing a king, decided to appoint *interreges*, it divided itself into ten decuries from each of which one senator was selected. Each of these ten acted as king for five days, and if, at the end of fifty days, no king had been elected, the rotation was renewed. It was their duty to nominate a king, whose appointment was then ratified or refused by the *curiae*. Under the Republic similarly *interreges* acted for five days each. When the first consuls were elected (according to Dionysius iv. 84 and Livy i. 60), Spurius Lucretius held the *comitia* as *interrex*, and from that time down to the Second Punic War such officers were from time to time appointed. Thereafterward there is no record of the office till 82 B.C., when the senate appointed an *interrex* to hold the *comitia* which made

Sulla dictator (Appian, *Bell. civ. i.* 98). In 55, 53 and 52 *interreges* are again found, the last-mentioned being on the occasion when Pompey was elected sole consul.

The most noteworthy use of the term "Interregnum" in post-classical times is that of the Great Interregnum in German history between the death of Conrad IV. (1254) and the election of Rudolf of Habsburg (1273). See GERMANY: *History*.

**INTERSTATE COMMERCE.** The phrase "interstate commerce," as used in the United States, denotes commerce between the citizens of different states of the Union. The words "interstate" and "intrastate" are not found in the constitution nor, until comparatively recently, in decisions of the courts or in legislative acts (probably being first used officially in 1887 in the Interstate Commerce Act). The constitution of 1789 uses the phrase "commerce among the states," and the first official decision interpreting the phrase says that "it may very properly be restricted to that commerce which concerns more states than one" (Chief Justice Marshall in *Gibbons v. Ogden*, 9 *Wheaton* 104). Commerce among the states is thus distinguished from "commerce which is completely internal, which is carried on between man and man in a state, or between parts of the same state, and which does not extend to or affect other states." It was declared (*Lehigh* case, 145 *U.S.* 102) that commerce between two persons in the same state is not interstate even when there is a temporary deviation to the soil of another state; but later (*Hanley* case, 187 *U.S.* 617, distinguishing the *Lehigh* case) it was declared that as to transportation, such commerce is interstate. The courts have interpreted commerce to denote not merely a mutual selling or traffic, but as "a term of the largest import," including intercourse for the purposes of trade in any and all its forms (*Gibbons v. Ogden*, 9 *Wheaton* 104, and *Wilton v. Missouri*, 91 *U.S.* 280). Thus have been included not only the actions of trading, navigation, transportation, and communication, but also the instruments and agents employed, including even telegraph messages and, in the extremest cases, lottery tickets.<sup>1</sup>

The decision of the question where federal control of interstate traffic ends and state control begins has been one of great practical difficulty. In general it has been held that whenever a commodity begins to move as an article of trade from one state to another, commerce in that commodity between the states has begun. Mere intention to ship goods does not make them subjects of interstate commerce, but they must actually be put in motion or committed to the carrier for that purpose (*Coe v. Errol*, 116 *U.S.* 517). As a practical guide in deciding when state control should be resumed, the court as early as 1827 (*Brown v. Maryland*) laid down the "original package rule," that the taxing power of the state should begin when the original package in which the goods had been imported into the state had been broken up or sold. The injustice of allowing goods to be held thus for long periods escaping local taxation, led to a modification of the rule in 1868 (*Woodruff v. Parkham*, 8 *Wall* 123), and such goods after reaching their destination

<sup>1</sup> The lottery tickets were included only by a divided court (*Lottery Cases*, 188 *U.S.* 321) four judges emphatically dissenting. The moral issue doubtless influenced a decision so difficult to reconcile with other opinions of the court, which otherwise had held regularly that commerce involves the physical movement of persons or things and does not include the contractual relations between citizens incidental to commercial intercourse. Not all things incidental to commerce are included in it, and it has been held that the following are not included: bills of exchange (in 1850, *Nathan v. Louisiana*, 8 *How* 73), trade marks (in 1879, *Trade Mark Cases*, 100 *U.S.* 82), insurance (in 1869, *Paul v. Virginia*, 8 *Wall* 168), and manufacturing (in 1895, *U.S. v. Knight Co.*, 156 *U.S.* 1). In the last-named case, which concerned a combination of sugar refineries controlling a large proportion of the product of the country, it was said that commerce succeeds manufacture and is not a part of it. The relation of the manufacturer to interstate and foreign commerce being thus only incidental and indirect, the business is subject to state control. By a series of decisions the transportation of persons has been decided to be commerce. (In 1848, *Passenger Cases*, 7 *How* 283. In 1867, *Crandall v. Nevada*, 6 *Wall* 35. In 1875, *Henderson v. the Mayor of New York*, 92 *U.S.* 259, &c.).

may be taxed as property in common with other property in the state.<sup>2</sup>

*Reason for Federal Control of Interstate Commerce.*—Immediately after the close of the War of American Independence in 1783 appeared the separatist tendencies and local jealousies usual in a confederation. The Congress of the Confederation had no power to levy tariff duties or to regulate commerce between the states, and the separate states freely and recklessly exercised their rights in this matter. Though commerce at that time was comparatively unimportant, the results of this restrictive policy were most unfortunate. The Annapolis Convention of 1786 was called by the Virginia legislature to take into consideration the trade of the United States and to consider how far a uniform system in their commercial relations might be necessary to the common interests and their permanent harmony. This conference resulted in the call of the Philadelphia Convention of 1787, which framed the present Constitution. Chief Justice Marshall, in one of the early cases on this subject (*Brown v. Maryland*, 12 *Wheaton* 419, in 1827), said in words often since quoted: "It may be doubted whether any of the evils proceeding from the feebleness of the federal government contributed more to that great revolution which introduced the present system than the deep and general conviction that commerce ought to be regulated by Congress."

Every year has increased the importance of the congressional power of regulating commerce. At the time of the adoption of the Constitution, each neighbourhood supplied nearly all its needs by its own industry, but improving means of transportation and communication have multiplied the commercial ties between the citizens of the various states. This change went on slowly until 1830, more rapidly between 1830 and 1860, and at an ever-hastening pace after the Civil War. Until 1824 no case involving directly the consideration of this power reached the United States Supreme Court. From 1824 to 1840 the Supreme Court decided an average of one-third of a case a year; from 1841 to 1860, an average of three-fourths of a case; from 1861 to 1870, an average of one case; from 1871 to 1880, an average of nearly six cases; from 1881 to 1890, an average of more than seven cases; and from 1891 to 1900, an average of more than ten cases. The decisions have not been entirely uniform, and there were some decisions too contradictory to be explained by any ingenuity. The Supreme Court itself has said (*Fargo v. Michigan*, 121 *U.S.* 230) that "it may be admitted that the court has not always employed the same language, and that all of the judges of the court who have written opinions for it may not have meant precisely the same thing." Though in the period just preceding the Civil War the doctrine of states' rights tended to weaken somewhat the federal power, the broad outlines of the interpretation by Chief Justice Marshall laid down in 1824 in *Gibbons v. Ogden* remain to-day almost undimmed.

*Interstate Commerce in the Federal Constitution.*—Freedom of trade, without discrimination, between the citizens of all the states was in the main ensured by one brief sentence, usually called the "commerce clause" of the federal constitution:—"The Congress shall have power . . . to regulate commerce with foreign nations, and among the several states, and with the Indian tribes" (Art. 1, sec. 8, clause 3). Hardly less important is the power "to make all laws which shall be necessary and proper for carrying into execution the foregoing powers, and all other powers vested by this Constitution in the government of the United States, or in any department or officer thereof" (Art. 1, sec. 8, clause 18). To the same end of freedom of commerce, Congress is limited in that "no tax or duty shall be laid on articles exported from any state," and "no preference shall be given by any regulation of commerce or revenue to the

<sup>2</sup> The question arose with reference to the police power of the state in those states prohibiting the liquor traffic, and in 1889 it was held (*Leisy v. Hardin*) that, in the absence of legislation by Congress, the right to sell goods taken into a state was unrestricted. This made it impossible for a state to exclude the importation of liquors to be sold within its territory, but this difficulty was remedied by the Wilson Original Package Bill of 1890, which made liquor subject to the police powers of the state to which it was carried.

ports of one state over those of another; nor shall vessels bound to or from one state be obliged to enter, clear, or pay duties in another" (Art. I, sec. 9, clauses 5 and 6). Directly and by implication, Congress was granted a number of other powers over commerce, in that it may coin money, establish uniform laws of bankruptcy, establish post-offices and post roads, regulate weights and measures, exercise admiralty jurisdiction (now interpreted to extend to all public waterways accessible to the traffic of more than one state), grant patents and copyrights, and use the power of taxation to protect, repress or even destroy the agencies of commerce (e.g. state bank notes). But these powers can be exercised only in ways which favour and make free the intercourse among all parts of the nation.

Even if the commerce clause had been omitted from the Constitution, a large part of its object would have been attained by certain prohibitions upon the states as follows: "The citizens of each state shall be entitled to all privileges and immunities of citizens in the several states" (Art. 4, sec. 2). "No state shall, without the consent of the Congress, lay any impost or duties on imports or exports, except what may be absolutely necessary for executing its inspection laws; and the net produce of all duties and impost, laid by any state on imports or exports, shall be for the use of the treasury of the United States, and all such laws shall be subject to the revision and control of the Congress" (Art. I, sec. 10, clause 2). "No state shall, without the consent of Congress, lay any duty of tonnage" (Art. I, sec. 10, clause 3). Thus by threefold measures of precaution was ensured domestic freedom of trade from every point in the land to its farthest frontiers.

*Negative Working of the Commerce Provisions.*—For nearly a hundred years these provisions were important only in their negative effects of preventing the states from granting special privileges to their citizens or taxing unequally the citizens of other states. The decision in 1824 of *Gibbons v. Ogden* stopped the attempt of the state of New York to grant the monopoly of steamboat traffic on the waters of that state. Had the clear and unequivocal opinion in that case been different, local ingenuity doubtless would have devised a multitude of discriminations. "The power to tax involves the power to destroy," and ever since the decision of *McCulloch v. Maryland* in 1810 it has been held that no agencies created by the federal government, such as banks or legal tender notes, are subject to state taxation, and the rule has also been laid down repeatedly by the Supreme Court (for the first time in 1886) that no burden can be laid upon the act of taking goods into or out of the state, of soliciting sales, or of delivering goods even though the tax is without discrimination as between the state's own citizens and others; that is, interstate commerce "cannot be taxed at all" (*Robbins v. Shelby County Taxing District*, 120 U.S. 489).<sup>1</sup>

<sup>1</sup> However, a very important distinction is drawn between taxing the commerce and taxing property employed in commerce. With the increase of interstate commerce, the states have been hard pushed to find sources of revenue adequate to their increasing needs. The courts, therefore, have sought to draw a line between taxes on the privilege of carrying on interstate commerce and taxes on the property employed in carrying on such commerce as a part of the general body of property in the state. Thus it has been held in the case of *State Freight Tax* (1872, 15 Wall. 232) that a state could not lay a tax on freight transported from one state to another, and yet the same year the court held in *State Tax on Gross Receipts* (15 Wall. 284) that a tax was valid when laid upon the receipts of railways organized under the laws of the state, as upon a fund which had become incorporated with the general mass of property. This latter decision was by a divided court (three of the nine judges dissenting), but it has since been frequently confirmed. The tax on gross receipts of all railway companies doing business in the state has been supported when levied in proportion to the mileage within as compared with the total within and without the state (*Erie Ry. v. Pa.*, 21 Wall. 492). This so-called "unit rule," as applied either to gross receipts or to the entire value of an interstate railway, has been upheld in a number of decisions. The method of taxation by gross receipts, however, has not tended to increase of late, but the unit rule, as applied to *ad valorem* taxes on property, is more and more being applied. Every case involving the distinction between a tax on commerce and a tax on property employed in commerce presents its own difficulties, yet a practical way is thus found to prevent discriminating action by the several states, while leaving to them adequate sources of revenue.

Federal control of interstate commerce has been interpreted by the courts to be exclusive of any control by the states. This is not self-evident in the clause, "Congress shall have power to regulate commerce among the several states." Over some other subjects the power of the federal and state governments is concurrent, the state being able to act until Congress enacts some conflicting legislation. Although the early decisions suggested that the power of Congress was exclusive, yet for nearly a century no positive decision was rendered and no positive action was taken by Congress. Between 1870 and 1886 the states made great progress in the regulation of railways on the assumption that until Congress had acted the states were free to act. The question was put beyond doubt in a series of decisions establishing the principle that the non-action of Congress indicates its will that commerce shall be free and untrammelled and that the states cannot interfere either through their police power or their taxing power.<sup>2</sup>

*Positive Federal Regulation.*—Though the regulation of interstate commerce up to the Civil War was mainly negative, some positive actions of the federal government had indirect effects on commerce, as, for example, the coinage of money, the establishment of post-offices, the charter of the first and second United States banks, and the charter of the Pacific Railroad. The power to do these things was conferred by the Constitution in some cases directly, in other cases by implication in that any means appropriate to lawful ends might be employed (as in case of charter of the United States Bank, *McCulloch v. Maryland*). From 1850 to 1862 the federal government had made numerous land grants in aid of railways, but always to the states, not directly to the corporations, and it had never until 1862 granted a charter to a railway, canal, turnpike or transportation company. In 1866 Congress passed an act authorizing railway companies whose roads were operated by steam to carry passengers, freight, &c., "on their way from any state to another state and to receive compensation therefor and to connect with roads of other states so as to form continuous lines for the transportation of the same to the place of destination."<sup>3</sup> This act, so vague and general in its terms, had very little effect, though it has been the occasion of considerable litigation to determine its influence upon existing police laws of the states. In 1884 Congress established the Bureau of Animal Industry for preventing the exportation of diseased cattle and for the extirpation of disease among domestic animals. This had little significance at the time for interstate commerce, its purpose being to meet the objections of foreign countries to the importation of American meat. In 1887 was passed the Interstate Commerce Act, providing a national commission to supervise interstate railways. In 1888 was passed an Arbitration Act, replaced in 1898 by an act which provides that in case of disputes between common carriers subject to the Interstate Commerce Act and their employees, conciliation shall be tried, and, in case this should fail, indicates the methods that may be used for the voluntary submission of the dispute to a board of arbitration.

<sup>2</sup> 1873, *State Freight Tax*, 15 Wall. 232; 1887, *Robbins v. Shelby County Taxing District*, 120 U.S. 489; *Wabash R. Co. v. City of Illinois*, 118 U.S. 557. The last-named case arose out of the attempts of the state of Illinois to prevent discrimination between two shippers, both being its own citizens and within its own borders, one of whom was being charged more than the other for a shorter shipment on the same line and in the same direction, from a point outside the state. The court, applying the established definition of interstate commerce with verbal formality of logic, decided that the state could do nothing, for even in such a case all regulation of interstate commerce, from the beginning to the end of a shipment, was confined to Congress exclusively. Thus a clause whose clear purpose was to prevent one state from burdening unequally the citizens of other states was successfully invoked by a private corporation to forbid the state securing equality of treatment for its own citizens as regards such parts of its payments as lay within its own borders. Most railway traffic was by this decision declared to be subject to legislation by Congress but Congress had not acted. The impossibility of this situation was so evident that the Interstate Commerce Act, long under discussion, became a law a few months later.

<sup>3</sup> This was probably aimed at the discriminating between New York and Philadelphia (see speech of Charles Sumner on the railroad usurpation of New Jersey in U.S. Senate, February 14, 1865).



In 1890 was passed the Sherman Anti-Trust Act, making illegal every contract and combination in restraint of trade or commerce among the several states or with foreign nations. In 1893 a Safety Appliance Act, the administration of which was put into the hands of the Interstate Commerce Commission, promoted the safety of employees and travellers, and required the roads engaged in interstate commerce to equip their cars and locomotives with automatic couplers and brakes. In 1895 was prohibited the interstate carriage of condemned carcasses of animals, and of lottery tickets (see above reference to the interpretation of the Lottery Act), in 1897 of obscene literature, and in 1900 of game killed in violation of state laws. In 1901 carriers engaged in interstate commerce were required to make full reports of all accidents to the Interstate Commerce Commission. In 1902 was prohibited the interstate carriage of dairy products falsely labelled or branded as to the state or territory in which produced, and in 1903 the Secretary of Agriculture was empowered to establish rules concerning importation and transportation of live stock. In 1903 the Bureau of Corporations was established with power to investigate the conduct of corporations engaged in interstate and foreign commerce, excepting common carriers subject to the Interstate Commerce Act. In 1903 the Interstate Commerce Act was amended by the Elkins Act, making much more difficult the granting of rebates. In 1905 the President was authorized to grant medals of honour to persons who by their daring save life or prevent accident on railways. In 1906 the Interstate Commerce Act was amended in important particulars (specified below). In 1906 were passed pure food laws, greatly enlarging the duties of the Department of Agriculture in reference to inspection of foods prepared for interstate commerce.

*The Interstate Commerce Act.*—The period of positive action by Congress in the regulating of interstate commerce practically begins, therefore, with the enactment of the Interstate Commerce Act of February 1887, the outcome of fully seventeen years of agitation and discussion. The law was modelled in large part upon English acts. It applied to common carriers wholly by railway, and partly by railway and partly by water when both are used under a common arrangement for continuous shipment; forbade unjust discrimination and undue and unreasonable preference; made it unlawful to charge more for a shorter than for a longer distance over the same line in the same direction, the shorter being included within the longer distance (though a carrier might be freed by the Commission from the working of this provision); and forbade pooling and division of earnings. The administration of the law was entrusted to a Commission of five members, appointed by the President. From this act much was expected, but eighteen years of its operation gave as net results little more than a greater uniformity of railway accounting and much better understanding by the public of the nature of the railway problem. Discrimination and secret rebates continued. The anti-pooling clause (pretty generally recognized by the well-informed to be a mistake) prevented open but not secret agreements between carriers, and probably hastened the movement toward consolidation. The long and short haul clause was made meaningless by the judicial interpretation that any competition, even that of other carriers subject to the act, justified the railway in charging more for a shorter than for a longer haul. The effectiveness of the Commission was destroyed by the judicial decision that it had no power to fix rates for the future. Until 1897, the Commission, when it adjudged a rate unreasonable, usually declared what rate was reasonable, and directed the carrier to reduce the rate by a given date to the designated maximum. Of 135 orders made in decisions rendered in the first ten years of the Commission, 68 prescribed a maximum rate for the future. In 1897 it was finally decided in the *Cincinnati Freight Bureau Case* (167 U.S. 479) that Congress had not conferred upon the Commission the power to prescribe any rate for the future. The court said that Congress might fix the rate itself or authorize a sub-tribunal to do so, but that Congress had not yet given that authority.

The need of further legislation had been felt from the beginning by many, and after 1903 the agitation became very active. The position taken by President Roosevelt in his message to Congress in 1904 made the amendment of the Interstate Commerce Act the principal political issue before Congress in the sessions of 1905 and of 1906. After the most remarkable senatorial debates heard at Washington in years, followed with close interest by the country, a number of amendments became law on the 20th of June 1906. The act was strengthened to a degree hardly expected by the most earnest advocates of revision. A number of minor changes made in the light of experience were: increasing the number of commissioners to seven and their pay to \$10,000; facilitating procedure and the taking of evidence; requiring thirty days notice of a change of rates; requiring appeal from the Commission's decision to be taken within thirty days; empowering the Commission to establish joint rates and to order switches to be built. The following are generally thought to be still more important changes: (1) Including within the application of the act pipe lines (particularly for oil), express and sleeping car companies, and all the facilities and services in connexion with goods transported; (2) giving publicity to railway business by empowering the Commission to prescribe all forms of accounts and to examine the books at all times, and by forbidding any other accounts or memoranda to be kept by the companies; and (3) empowering the Commission to prescribe reasonable maximum rates to take effect within not less than thirty days and to continue not over two years unless set aside by the courts.

*The Anti-Trust Act of 1890.*—The growth of large corporations with some degree of monopoly power, the so-called trusts, had called forth in a number of the states anti-trust laws before 1890. When it became evident that the states were not succeeding in dealing with the problem, public sentiment found expression in the Sherman Anti-Trust Act, approved on the 2nd of July 1890. This act declared illegal and criminal, punishable by fine or imprisonment or both, every contract in restraint of trade or commerce among the several states or with foreign nations. The statute thus changed the common law wherein such contracts were merely unenforceable but not criminal. This act was at first construed by the Supreme Court as applying to any contract in restraint of interstate commerce, whether reasonable or unreasonable (*Trans-Missouri Freight Association*, 166 U.S. 337), but later, in 1905 (*Stock Yards case*, 25 *Supreme Court Reporter* 276) it was held that the act did not apply to agreements for the better conduct of business which incidentally affected interstate commerce. The act has been interpreted to apply to transportation (*Freight Association case*, 166 U.S. 290, and *Northern Securities case*), with results felt even by some of the advocates of railway regulation to be unfortunate. It applies to unlawful combinations of manufacturers to divide the territory and regulate the prices (*Addyston Pipe Trust Case*, 175 U.S. 211). In the *Sugar Trust case* (1895 U.S. v. *Knight Co.* 156 U.S.) it was declared that the statute did not apply to a manufacturing company which had acquired nearly complete control of the manufacture of refined sugar by means of the purchase of stock of other refining companies.

The Attorney-General submitted to the Senate, in June 1906, a statement of the results of all suits instituted by the Department of Justice under the anti-trust law, the Interstate Commerce Act and the Elkins Act, in the period from 1887 to June 1906 inclusive. Thirty-six suits were still pending; of the 250 which had been disposed of in some manner 186 ended in dismissal, non-prosecution or acquittal, and 64 were successful in securing in whole or in large part the object of the suit (in 30 cases conviction, in 34 cases the granting of a petition or an injunction, &c.). In addition to these results of federal efforts to regulate industry must be counted the cases in which carriers conciled

<sup>1</sup> In the *Northern Securities case*, Justice Brewer, who had concurred in the opinion in the *Trans-Missouri Freight Association case*, took occasion to say that while he still believed the former case had been correctly decided, he thought that the reasons given for the judgment were in some respects faulty, and that the ruling should have been that the contracts there considered were unreasonable restraints and as such were forbidden by the act.

with the orders of the Interstate Commerce Commission without suit; but even then the total by 1906 was somewhat meagre.

The establishment of the Bureau of Corporations in 1903, and the considerable extension of the powers of inspection of the Department of Agriculture are recent changes of which the results cannot yet be fairly judged. The aim of the Bureau of Corporations is to ensure publicity in the management of corporations engaged in interstate and foreign commerce. The first commissioner, Mr James R. Garfield, showed much activity in pursuing the purposes of the act, and published informing reports upon the beef trust (1905) and upon the Standard Oil Company (1906). But the effect and possible extension of federal interference became from this time burning political questions of far-reaching importance of too recent a date to be dealt with historically in this article.

See also the *Annual Reports of the Interstate Commerce Commission* since 1887, and decisions; Prentice and Egan, *The Commerce Clause of the Federal Constitution* (Chicago, 1898); *Reports of the Commissioner of Corporations on the Beef Industry* (1905), on the *Transportation of Petroleum* (1906); W. Z. Ripley (ed.), *Trusts, Pools and Corporations* (1905), containing leading cases and analyses of the voluminous "trust" literature; F. N. Judson, *The Law of Interstate Commerce and its Federal Regulation* (Chicago, 1905); Beale and Wyman, *Railroad Rate Regulation* (Boston, 1906); Frank Hendrick, *The Power to Regulate Corporations and Commerce* (New York, 1906), favouring less of new legislation. (F. A. F.)

**INTERVAL**, a space left between the component parts of a continuous series, a pause in continuous action, a period of time intervening between two other points of time or chronological sequence of events. The Lat. *intervallum*, from which the English word has come through the French, originally meant a space between the palisades on a rampart (*vallum*), or between the rampart and the tents of the legionaries. In medical language "interval" is used of the intervening periods between attacks or paroxysms of a disease, particularly of the periods of a rational or normal condition of mind sometimes experienced by an insane person, a "lucid interval"; this phrase frequently occurs in legal documents from the 13th to the 15th centuries, *non compos mentis sed gaudet lucidis intervallis*. In music "interval" expresses the distance in pitch between two or more musical sounds (see MUSIC). Interval, or more commonly "intervale," is used, particularly in North America, as a geographical term for a low-lying tract of land along the banks of rivers, frequently overflowed by freshets, or more loosely for any low level land shut in by hills. This particular application, as also the form "intervale," is due to a confusion of the termination of the word with "vale," valley.

**INTESTACY** (Lat. *intestatus*, one who has not made a will, from *testari*, to bear witness), the condition of the property of a person who dies without making a will. Here the law of England distinguishes sharply between his real and his personal property. The devolution of the former is regulated by the rules of inheritance (*q.v.*). The destination of the latter is marked out by the Statute of Distributions. The proper conditions of a testamentary disposition of property will be found under the heading Will.

The distribution of an intestate's personal property is carried out under the authority of administrators, whose duties are generally the same as those of executors under a will. Administration was until 1857 a matter cognizable by the ecclesiastical courts, and the ordinary was in fact the administrator until the passing of an act of Edward III. for administration upon intestacy (1357). An earlier statute (Westminster 2, 1275), directed against the abuses of the system, required the ordinary, instead of applying the residue of the estate to "pious uses," to pay the debts of the intestate. The act of Edward III. went further in providing that "in case where a man dieth intestate, the ordinaries shall depuete of the next and most lawful friends of the dead person intestate to administer his goods," with power to sue for debts due to the deceased, and under obligation to pay debts due by him, and to answer to the ordinary like executors in the case of testament. Administrators remained on this footing of deputies appointed by the ordinary until the

Probate Act 1857 transferred the jurisdiction in administration of the ecclesiastical courts to the new court of probate.

The courts of law having held that by the grant of administration the authority of the ecclesiastical courts was exhausted, the administrator became entitled to the privilege, similar to that formerly enjoyed by the ordinary, of dealing as he pleased with residue of the property. The next of kin of the same degree of relationship to the deceased were thus aggrieved by the preference of the administrator, and it was to remedy this grievance that the Statute of Distributions 1670/1 was passed. It empowered the ordinary to take a bond from the administrator binding him to make a fair and complete distribution of the property among the next of kin. Such distribution is to be in the following manner: one-third to the wife of the intestate, and all the residue by equal portions to and amongst the children, and their representatives if any of such children be dead, exclusive of children who shall have any estate by the settlement of the intestate, or shall be advanced by the intestate in his lifetime by portions equal to the shares allotted to the other children under the distribution. If such advancement should be less than the share of the other children in distribution, then it shall be made equal thereto. But the "heir-at-law, notwithstanding any land that he shall have by descent or otherwise from the intestate, is to have an equal part in distribution with the rest of the children" (§ 5). By § 6, if there be no children nor any legal representatives of children, one moiety of the property is to be allotted to the wife of the intestate, the residue "to be distributed equally to any of the next of kindred of the intestate who are equal in degree and those who legally represent them." By § 7 there shall "be no representation admitted among collateral aunts by brothers' and sisters' children; and in case there be no wife, then all the said estate to be distributed equally to and among the children; and in case there be no child, then to the next of kindred in equal degree of or unto the intestate and their legal representatives as aforesaid, and in no other manner whatsoever." For the protection of creditors it is enacted that there shall be no distribution till a full year after the intestate's death, and if any debts should be discovered after distribution, the persons sharing the estate shall refund the amount of the same ratably. With reference to the above rules the following points may be observed: (1) The husband's absolute right to administer his wife's estate is not affected by the act. This was made clear by a later act of the same reign (The Statute of Frauds 1677). Administration is now granted to the representatives of the husband where he has died without taking out administration to his wife, unless it can be shown that the wife's next of kin are beneficially interested. (2) The widow, in the event of there being no children or next of kin, takes only her half. The other half goes to the crown. The widow's rights, however, have been enlarged by the Intestate Estates Act 1890. By this act where a man dies wholly intestate and without issue, his property, both real and personal, shall, if it does not exceed £500 in net value, belong to his widow absolutely. If the estate exceeds £500 net, the widow is entitled to £500 out of the estate and has a charge for that amount upon the real and personal property of the deceased. (3) The child or children take equally, two-thirds if the widow be alive, and the whole if she be dead. If some of the children be alive and some dead having issue, then such issue will take their parents' share equally among themselves. There has been some difference of opinion as to whether if all the children have predeceased their parent but have left issue, such grandchildren take as between themselves *per stirpes* as representatives of their parent or *per capita* as next of kin. Thus if A and B predecease their father but A leaves three children and B one, should the property be divided into fourths, or first into moieties and then one moiety subdivided into thirds among A's children and the other moiety be given undivided to B's child? It is now settled that the latter method of distribution is the correct one, and it is thought that this will also apply when only great-grandchildren are alive. (4) The next of kin must be ascertained according to the rules of consanguinity,

which are the same in English as in the civil law. Degree is calculated from the intestate, through the common ancestor if any, to the kindred. Thus from son to father is one degree, to grandfather two degrees, to brother two degrees, to uncle three degrees, and so on. The statute ordains distribution to be made "to the next of kindred in equal degrees *pro suo cuique jure*, according to the laws in such cases and the rules and limitations hereafter set down." Equality in degree is therefore not in all cases accompanied by equality in rights of succession. Neglecting the cases of wife and children already noticed, the father excludes all other next of kin. So would a mother, in default of a father surviving, but an act of 1685 enacted that in such a case the brothers and sisters, and children of brothers and sisters, of the intestate should share equally with the mother. In the absence of brothers or sisters and their representatives, the mother in the case supposed would take the whole. Mothers-in-law and stepmothers are not within the rules of consanguinity. As between a brother and a grandfather who are both in the second degree, preference is given to the brother; but a grandfather, being in the second degree, will exclude an uncle, who is in the third. An uncle and a nephew, both being in the third degree, take together. Brothers or sisters of the half blood take equally with brothers and sisters of the whole blood. The rule which prohibits representation after brothers' and sisters' children would, in a case where the next of kin are uncles or nephews, wholly exclude the children of a deceased uncle or nephew. Also, as between the son of a brother and the grandson of a brother, the latter would not be admitted by representation. Where a brother and the children of a deceased brother are the next of kin, they will take *per stirpes*, i.e. the brother will take one half, and the children of the other brother will take the other half between them. When the next of kin are all children of the deceased brothers or sisters, they will take equally *per capita*. Subject to these modifications, the personal property will be divided equally among the next of kin of equal degree, e.g. great-grandfathers would share with uncles or aunts, as being in the third degree. Failing next of kin, under these rules, the estate goes to the crown as *ultimus haeres*, a result which is more likely to happen in the case of illegitimate persons than in any other.

Personal or movable property takes its legal character from the domicile of the owner, and the distribution of an intestate's goods is therefore regulated by the law of the country in which the intestate was domiciled. A domiciled Scotsman, for example, dies intestate in England, leaving personal property in England; the administrator appointed by the court of probate will be bound to distribute the property according to the Scots rules of succession.

In the law of Scotland the free movable estate of the intestate is divided amongst the nearest of kin, the full blood excluding the half blood, and neither mother nor maternal relations being originally admitted. The heir of the heritable (i.e. real) property if one of the next of kin must collate with the next of kin if he wishes to share in the movables. Proximity of kin is reckoned in the same order as in the case of inheritance. The Intestate Movable Succession Act 1855 among other changes allows the issue of a predeceasing next of kin to come in the place of their parent in succession to an intestate, gives the father of an intestate dying without issue one-half of the movable property in preference to brothers and sisters, and to the mother if the father be dead a similar preference to the extent of one-third, and admits brothers and sisters uterine in the absence of brothers and sisters german or consanguinean.

In the United States the English Statute of Distribution has been taken as the basis of the law for the distribution of personal property in intestacy, and its principles have been applied to real property also. "In a majority of the states the descent of real and personal property is to the same persons and in the same proportions, and the regulation is the same in substance as the English Statute of Distribution. In Georgia the real and personal property of the intestate is considered as altogether of the same nature and upon the same footing." There are many states, however, in which the distribution differs materially from the English statute. In Illinois the distribution is the same as descent of real property. In Alabama the whole goes

to the widow if there are no children (*Phillips v. Loring*, 1907, 43 Southern Rep. 494). In many states the husband's share is in all cases like the widow's, as in Texas, New York and Washington. In Pennsylvania he takes an equal share with the children.

The statutes of each state of the American union must be consulted, as no general rules can be laid down. As to the right to the intestate's interest in community property in the states where the law of "community"—of "acquets and gains"—prevails, see INHERITANCE.

**INTESTINAL OBSTRUCTION** (*Ililus*), in surgery, a condition in which the onward passage of the faeces is prevented. It is often associated with phenomena due to strangulation of the gut, leading to gangrene, and with systemic poisoning due to the absorption of toxins, resulting from the decomposition of the retained faeces. Intestinal obstruction may be conveniently divided into acute and chronic.

*Acute Intestinal Obstruction* forms one of the most urgent of surgical emergencies. The following are its chief causes: (1) strangulation by bands or adhesions or through apertures; (2) volvulus; (3) the impaction of foreign bodies; (4) acute intussusception; (5) strangulation over a band or acute kinking of the gut; (6) the termination supervening on chronic obstruction; (7) congenital malformations of the intestines.

*Strangulation by Bands or Adhesions or through Apertures*.—These terms are applied to obstruction by constricting bands within the abdomen. These may be the result of the stretching of old inflammatory adhesions, the result of former peritonitis. These bands are commonly situated between different parts of the mesentery or between the mesentery and another organ such as the appendix. Two methods of producing strangulation exist; in the first the bowel passes under an arch or loop formed by some short constricting band and cannot return, or if the band is long it may form a noose in which the bowel is strangled (fig. 1); in the second the remains of a foetal structure (Meckel's diverticulum) becoming adherent to some other organ may ensnare the intestine in the loop. A coil of intestine may also slip into a hole in the mesentery or omentum and take place.



FIG. 1.—Diagram to show how Strangulation by a Band may take place.

forming what is known as an internal hernia. The onset of symptoms is sudden and abrupt. The patient is seized with acute abdominal pain associated with collapse. The pain is usually referred to the region of the umbilicus; this localization, however, is no guide to the situation of the lesion. Vomiting is early and persistent, generally assuming a faecal character between the second and the ninth day. There is no obvious tumour; constipation is present, the abdominal walls are flaccid at first, but if no relief is obtained become tender when peritonitis ensues. This form of obstruction is most frequent in young people, and there is usually a history of previous peritonitis. In cases not treated by operation the average duration is five to seven days, and death takes place from exhaustion or from toxæmia following peritonitis.

*Volvulus* means a torsion or twisting of the gut. There are two chief varieties: (1) in which the bowel is twisted upon its mesenteric axis (fig. 2); (2) in which it is wound round another coil of intestine.

The sigmoid flexure is the situation in which volvulus most commonly takes place, but it may occur in the caecum and small intestine. When once present, plastic peritonitis fixes the coil in position and the blood supply becomes obstructed. Volvulus is generally preceded by a history of chronic constipation. The acute symptoms start abruptly and are similar to those of internal strangulation, but the pain at first is more intermittent in type. There is usually early tenderness over the spot and constipation is absolute. Much distress is occasioned by abdominal distension from flatus, which develops with remarkable rapidity. The swelling is localized at first. Spontaneous natural cure is unknown, and without surgical interference death is inevitable.



FIG. 2.—Diagram to show how Volvulus may take place.

*Impacted Foreign Bodies*.—Gall-stones may cause obstruction when they are of the large size. These gall-stones may be lodged in the intestine may there be enlarged by subsequent accretion. Leichenstern describes such a stone with a circumference of 5 in., and Sir F. Treves removed from the intestine of an old lady a calculus, the large size of which was due to layers of magnesia, the patient having taken

carbonate of magnesia daily for many years. Gall-stones may give rise to intermittent sub-acute attacks of incomplete obstruction and finally give rise to an acute attack accompanied by severe pain and vomiting, which is constant and early becomes faecal. The abdomen is soft and flaccid and the affected coil is rarely to be felt. The symptoms vary with the situation of the obstruction and are generally more urgent the nearer to the duodenum. Foreign bodies that have been swallowed by accident or otherwise may give rise to obstruction, though extraordinary objects, as knives, coins, pipes, flints, &c. swallowed by jugglers, are known to have passed by rectum without injury. In some cases where the foreign body lodges in the intestine the caecum and duodenum are favourite situations for obstruction. In the museum of the Royal College of Surgeons is a specimen in which the duodenum is blocked by a mass of pins weighing nearly a pound. Foreign bodies may remain weeks or months in situ before giving rise to serious symptoms, the progress of the larger substances being marked by temporary obstruction. In a case quoted by Duchaussoy the obstructing mass consisted of over 700 cherry stones. The diagnosis of obstruction by foreign bodies has been much simplified since the introduction of the X-rays. Enteroliths may themselves cause obstruction. They may consist of masses of indigestible vegetable material matted together with faeces and mucus. In Scotland they are frequently found to consist of husks of coarse oatmeal (aenoliths). In thin persons large enteroliths and foreign bodies may be palpable. The symptoms are those similar to obstruction by a large gall-stone.

**Acute Intussusception** forms about 30% of all cases of intestinal obstruction, and is the most common variety found in children. More than 50% of the cases are found during the first ten years of life, and half that amount in babies under one year; the large preponderance is in males. By intussusception is meant an invagination or protrusion of a part of the intestine in the lumen of the intestine immediately below it; the lower part of the intestine may be said to have swallowed that immediately above it. The mesentery attached to the upper portion is necessarily dragged in with it. The condition may be seen by referring to the diagram (fig. 3).

The invaginated portion is termed the *intus*, and the foreign body which it enters is known as the *intussusceptum*. The chief cause of it is the constriction of the vessels in the entering mesentery and later to their possible complete obstruction that are due the late serous phenomena of intussusception, e.g. gangrene or rupture of the gut. Peritonitis also ensues, and by the formation of adhesions between the serous coats of the entering and returning parts leads to irreducibility of the intussusception. A cure occasionally ensues from spontaneous reduction of the invagination, or again permanent stenosis of the intestine may result from the adhesion of the folds, or the occurrence of gangrene may lead to perforation of the intestine with acute septic peritonitis. Occasionally when there is no perforation adherence takes place between the segments, and the gangrenous portion sloughs off and is discharged by the rectum. The cause of intussusception is said to be violent peristaltic action, however produced. Polypoid tumours or masses of worms, or masses of irritating ingesta, are said to lead to its occurrence. X. Dolore and R. Leriche contend that the primary factor is congenital mobility of the caecum. They state that in 48% of foetal caecum is mobile in half, fixation gradually giving out; while in 8% of adults it retains its mobility. They thus endeavour to account for the fact that in 300 collected cases 204 occurred in children less than ten years old. Intussusception is met with in four distinct situations: (a) the ileo-caecal, which is said to be the most frequent, constituting 44% of all cases (Treves); (b) the enteric variety, involving the small intestine; (c) the colic form; (d) the ileo-colic, the ileum being invaginated through the ileocaecal valve. Intussusception may be acute or chronic, sometimes lasting intermittently for years. The acute form is the most common. In young children an attack occurs with severe pain, at first paroxysmal but later continuous; vomiting is less early and less continuous than in strangulation by bands, and diarrhoea tenesmus, much straining and the passage of blood mucus from the anus are common. Collapse soon supervenes. Early in the case the abdomen is but little distended, and in about half the cases a distinct tumour can be felt. In some cases the invaginated gut may be felt protruding through the sphincter. Chronic intussusception occurs more frequently in adults than in children, the symptoms may resemble chronic enteritis and be so masked that the nature of the illness remains undiagnosed until an acute attack supervenes, or the patient succumbs to the diarrhoea, vomiting and haemorrhage.

**Congenital Malformations of the Intestines.**—Cases have been recorded in which the small intestine ended in a blind pouch. Imperforate anus is a fairly frequent occurrence in young infants, but attention is usually called to the condition. Partial strictures of the intestine, if the stricture be not too narrow, may pass unnoticed for years, and final complete obstruction may result from a blockage of the stricture by some foreign substance such as a plug of hard faecal matter or a fruit stone.

**Treatment of Acute Intestinal Obstruction.**—Early diagnosis and early laparotomy are essential, and it is important to operate before the patient is poisoned by the absorption of toxins from the bowel. To administer purgatives is worse than useless. Of massage and abdominal taxis Sir F. Treves says: "These are to be condemned, as they may rupture the already moribund bowel and make effective a threatened perforation. These measures are for the most part feeble excuses for avoiding or delaying the operation." The operation may be undertaken in one or two stages, and includes the opening and evacuation of the distended intestines and the search for and reduction or removal of the obstruction.

**Chronic Intestinal Obstruction.**—The causes of chronic obstruction are very numerous, and may be divided into the following groups: (1) intra-intestinal conditions, *i.e.* the impaction of foreign bodies and impaction of faeces; (2) affections of the intestinal wall such as stricture, new growths in the intestine, particularly those of a malignant type, adhesions or matting together of the intestines from peritonitis or kinking of the gut from disease of the mesenteric glands; (3) chronic intussusception; (4) compression of the bowel by a tumour or bands developing outside the intestine. Of these the commonest are malignant growths and faecal impaction.

The general symptoms of chronic obstruction are more or less alike. The patient is attacked with gradually increasing constipation, which may alternate with diarrhoea which is generally set up by the irritation of the retained faeces. In obstruction due to malignant growths the character of the motions is changed, they become scybalous, pipe-like or flattened. The abdomen becomes distended, and at intervals severe symptoms may supervene, consisting of pain and vomiting with complete constipation owing to some temporary complete obstruction. The attacks usually pass off, and relief may be obtained naturally or by the administration of a purgative, but they have a tendency to recur and in malignant disease to increase to complete obstruction. Finally a seizure may persist and take on all the characters of an acute attack, and death may supervene from exhaustion, perforation or peritonitis, unless immediately treated. When it arises from simple stricture no tumour is to be felt, but in malignant disease the tumour may be frequently palpated, unless during an acute attack when the abdomen is much distended with gas.

**Faecal Impaction** is not uncommon in adult females who have suffered from chronic constipation. The common seat of the blockage is in the colon, chiefly in the sigmoid flexure and in the rectum, but it may occur in the caecum. The accumulation may form a doughy tumour which in parts may be nodular and intensely hard. The causes are due to the state of the contents of the bowel itself, to congenital or acquired weakness and diminished expulsive power of the bowel, or to painful affections of the anus, fissures, piles and painful bladder affections. The acute symptoms are always preceded by a prolonged period of malaise; the breath is offensive and the tongue foul, and the temperature may be raised from the absorption of toxins. Faecal impaction requires the regular and repeated administration of large enemata, given through a long tube, together with the administration of calomel and belladonna. Large impacted masses in the rectum may be broken up and removed by a scoop.

**Strictures of the Intestinal Wall.**—Simple strictures are infrequent, and are dealt with by the operation of lateral anastomosis. They follow dysenteric or tuberculous ulceration or the passage of gall-stones. Strictures due to carcinoma of the intestinal wall occur usually in the old or middle-aged, and the symptoms come on insidiously. As soon as the condition is diagnosed an attempt should be made to remove the tumour if freely movable, or if this is not possible to afford relief by short-circuiting the intestine or by colotomy.

**Chronic Intussusception** has been frequently mistaken in the diagnosis for rectal polypus, cancer, tuberculous peritonitis, &c. (Treves). If diagnosed it may be reduced by inflation with air, but frequently too many adhesions are present for this to be possible, and laparotomy with excision of the mass should be undertaken; the results are said to be very encouraging.

Compression of the bowel due to a tumour or bands external to the bowel may occasionally give rise to obstruction. An exploratory operation should be undertaken for the excision of the tumour, or the separation of adhesions and release of the bowel, or if the intestines are much matted together by adhesions an intestinal anastomosis may give relief. Obstruction due to paralysis of the muscular coat of the intestine has been described (adynamic obstruction), but its existence is a subject of dispute. (H. L. H.)

**INTESTINE** (Lat. *intestinus*, internal, usually in neuter plural *intestina*, from *intus*, within), in anatomy, the lower part of the

alimentary canal; in man and mammals divided into the smaller intestine, from the pylorus to the iliocaecal valve, and the larger, reaching from the caecum and colon to the end of the rectum. The word is frequently applied to the whole of the alimentary canal in invertebrates. (See ALIMENTARY CANAL.)

**INTOXICATION** (Lat. *toxicare, intoxicare*, to smear with poison, *toxicum*, an adaptation of Gr. *τοξικόν, sc. φάρμακον*, a poison smeared on arrows; *τόξον, bow*), poisoning, or the action of poisons, whether of drugs, bacterial products, or other toxic substances, and hence the condition resulting from such poisoning, particularly the disorder of the nervous system produced by excessive drinking of alcohol (see INEBRIETY and DRUNKENNESS).

**INTRA**, a town of Piedmont, Italy, in the province of Novara, on the W. shore of Lake Maggiore, 685 ft. above sea-level, 12 m. N. of Arona by steamer. Pop. (1901) 6924. It is situated between two torrents, which afford water-power for cotton and silk mills, hat factories, foundries, &c.; these chiefly belong to Swiss proprietors, who have fine villas with beautiful gardens. The church is a large edifice of 1708-1751.

**INTRADOS** (a French term, Lat. *intra, within, Fr. dos, back*), in architecture, the under-curved surface or soffit of an arch (*q.v.*).

**INTRANSIGENT** (adopted from the Fr. *intransigent*, taken, through the Spanish *intransigente*, from the Lat. *in, not, and transigere*, to come to an understanding), one whose attitude is that of an irreconcilable. The term is used chiefly of politicians of an advanced type; those in complete antagonism to the existing form of government; but is especially applied on the continent of Europe to members of legislatures holding extreme Radical views. In this sense the word was first used in the political troubles which arose in Spain in the years 1873-1874. Intransigence implies an attitude of uncompromising disagreement with political opponents. The word is also used non-politically, in the sense of intractability and intolerance.

**INTRINSIC** (through Fr. *intrinsèque*, from Lat. *intrinsecus*, inwardly; *inter, within, secus*, following, from root of *sequi*, to follow), an adjective originally applied to something internal or inside another, but now ordinarily used to express a quality inherent in or inseparable from a person, thing or abstract conception. In anatomy the term is, however, still used of a muscle which has both its origin and insertion in the organ in which it is found.

**INTROSPECTION** (from Lat. *introspicere*, to look within), in psychology, the process of examining the operations of one's own mind with a view to discovering the laws which govern psychic processes. The introspective method has been adopted by psychologists from the earliest times, more especially by Hobbes, Locke, Berkeley, Hume, and English psychologists of the earlier school. It possesses the advantage that the individual has fuller knowledge of his own mind than that of any other person, and is able therefore to observe its action more accurately under systematic tests. On the other hand it has the obvious weakness that in the total content of the psychic state under examination there must be taken into account the consciousness that the test is in progress. This consciousness necessarily arouses the attention, and may divert it to such an extent that the test as such has little value. Such psychological problems as those connected with the emotions and their physical concomitants are especially defective in the introspective method: the fact that one is looking forward to a shock prepared in advance constitutes at once an abnormal psychic state, just as a nervous person's heart will beat faster when awaiting a doctor's diagnosis. The purely introspective method has of course always been supplemented by the comparison of similar psychic states in other persons, and in modern psycho-physiology it is of comparatively minor importance.

See **PSYCHOLOGY, ATTENTION, &c.**; a clear statement will be found in G. F. Stout's *Manual of Psychology* (1898), i. 14.

**INTUITION** (from Lat. *intuēri*, to look at), in philosophy, a term applied to immediate or direct apprehension. The truth of a theorem in geometry is demonstrated by a more or less elaborate series of arguments. This is not the case, according

to the intuitionist school of philosophy, with the apprehension of universal principles, which present themselves as necessarily true in their own right, without any sort of proof. The fact that things which are equal to the same things are equal to one another is apprehended directly or immediately without demonstration. Similarly in ethics the intuitionist school holds that the principles of right and wrong are immediately apprehended without reference to any other criterion and without any appeal to experience. Ethical intuitionism sometimes goes even farther, and holds that the conscience when faced with any particular action at once assigns to it a definite moral value. Such a view presupposes that the moral quality of an action has, as it were, concrete reality which the special faculty of conscience immediately recognizes, much in the same way as a barometer records atmospheric pressure. The intuitionist view is attacked mainly on the ground that it is false to the facts of experience, and it is maintained that many of the so-called immediate a priori judgments are in point of fact the result of forgotten processes of reasoning, and therefore a posteriori. Minor grounds of attack are found in the difficulty of discovering in certain primitive peoples any intuitive conception of right and wrong, and in the great differences which exist between moral systems in different countries and ages.

**INULIN** (C<sub>6</sub>H<sub>12</sub>O<sub>6</sub>)<sub>n</sub>, in chemistry, a starch-like carbohydrate, known also as alantyn, menyanthin, dahlin, synanthrin and sinistrin. It occurs in many plants of the large genus *Compositae*, to which the elcampane (Lat. *inula*) belongs; and forms a white tasteless powder, sparingly soluble in cold water, very soluble in hot water and insoluble in alcohol. It is not coloured blue by iodine; and it reduces ammoniacal silver and gold solutions, but not Fehling's solution. Heated with water or dilute acids, it is converted into laevulose.

**INVAR**, an alloy of nickel and steel, characterized by an extremely small coefficient of thermal expansion; it is specially useful in the construction of pendulums and of geodetic measuring apparatus, in fact, in all mechanical devices where it is an advantage to avoid temperature compensation. The name was chosen as expressing the invariability of its dimensions with heat. See **CLOCK; GEODESY.**

**INVARIABLE PLANE**, in celestial mechanics (see **ASTRONOMY**), that plane on which the sum of the moments of momentum of all the bodies which make up a system is a maximum. It derives its celebrity from the demonstration by Laplace that to whatever mutual actions all the bodies of a system may be subjected, the position of this plane remains invariable.

A conception of it may be reached in the following way. Suppose that from the centre of gravity of the solar system (instead of which we may, if we choose, take the centre of the sun), lines or radii vectors be drawn to every body of the solar system. As the planet revolves around the centre, each radius vector describes a surface of which the area swept over in a unit of time measures the areal velocity of the planet. The constant- $\nu$  of this velocity in the case of the sun and a single planet is formulated in Kepler's second law. Next pass any plane through the centre of motion and project the area just defined upon that plane. We shall thus have a projected areal velocity, the product of which by the mass of the planet is the moment of momentum of the latter. Form this product for every body or mass of matter in the system, and the sum of the moments is then invariable whatever be the direction of the plane of projection. In the case of a single body revolving around the sun this plane is that of its orbit. When all the bodies of the system are taken into account, the invariable plane is a certain mean among the planes of all the orbits.

In the case of the solar system the moment of Jupiter is so preponderant that the position of the invariable plane does not deviate much from that of the orbit of Jupiter. The influence of Saturn comes next in determining it, that of all the other planets is much smaller. The latest computation of the position of this plane is by T. J. See, whose result for the position of the invariable plane is inclination to ecliptic 1° 35' 7".74, longitude of node on ecliptic 106° 8' 46".7 (Eq. 1850).

**INVENTORY** (post-class. Lat. *inventarium*, a list or repertory, from *invenire* to find), a detailed list, schedule or enumeration in writing, of goods and chattels, credits and debts, and sometimes also of lands and tenements.

(i) In law, perhaps its earliest, and certainly its most important

use has been in connexion with the doctrine of "benefit of inventory," derived by many legal systems from the *beneficium inventarii* of Roman law, according to which an heir might enter on his ancestor's inheritance without being liable for the debts attaching to it or to the claims of legatees beyond the value—previously ascertained by "inventory"—of the estate. The benefit of inventory exists in Scots law, in France (*bénéfice d'inventaire*), in Italy, Mauritius (*Civil Code*, Art. 774), Quebec (*Civil Code*, Art. 660), St Lucia (*Civil Code*, Art. 585), Louisiana (*Civil Code*, Arts. 1025 et seq.), and under the Roman Dutch law in Ceylon. In South Africa benefit of inventory is superseded by local legislation.

(ii.) In many systems of law, the duty is imposed on executors and administrators of making an "inventory" of the estate of the testator or intestate, in order to secure the property to the persons entitled to it. In England this duty was created by statute in 1520. In modern practice an inventory is not made unless called for, but the court may order it *ex officio*, and will do so on the application of any really interested party. Similar provisions for an inventory of the estate of deceased persons are made in Scots law (Probate and Legacy Duties Act 1808 (s. 38), and Executors (Scotland) Act 1900 (s. 5), and in most of the British colonies. In Scotland, prior to the Finance Act 1804 (which imposed a tax, called "estate duty," on the principal value of all property, heritable or movable, passing on death), the stamp duty on movable property was termed "inventory duty."

In the United States, the duty of preparing an inventory is generally imposed on executors and administrators; see Kent, *Commentaries on American Law* (new ed., 1866), ii. 414, 415; and cf. Gen. Stats. of Connecticut, 1888, s. 578; New York Stats. s. 2714; New Jersey (Orphans Court, s. 58).

(iii.) An analogous duty of preparing an "inventory" is imposed in many countries on guardians and curators. In Scotland judicial factors are charged with a similar statutory duty (Act of Sederunt, Nov. 25th, 1857, under the Bankruptcy (Scotland) Act 1856) as regards the estate of insolvent debtors.

(iv.) In Scots law, the term "inventory" is also applied to a list of documents made up for any purpose, e.g. the *inventory of process* or the *inventory of documents*, in an action, and the *inventory of title-deeds* produced on a judicial sale of lands.

(v.) In England an "inventory" of the personal chattels comprised in the security is required to be annexed to a bill of sale (Bills of Sale Act 1882, s. 5). See also EXECUTORS AND ADMINISTRATORS.

**INVERARAY**, a royal and municipal burgh, the county town of Argyllshire, Scotland. Pop. (1901) 1369. It lies on the southern shore of a bay, where the river Aray enters Loch Fyne, 40 m. directly N.W. of Glasgow, and 85 m. by water. The town consists of one street running east and west, and a row of houses facing the bay. Near the church stands an obelisk in memory of the Campbells who were hanged, untried, for their share in the Argyll expedition of 1685 in connexion with the duke of Monmouth's rebellion. The ancient market-cross, 8 ft. high, supposed to have been brought from Iona in 1472, is a beautiful specimen of the Scottish sculptured stones. The chief industry is the herring fishery, the herring of Loch Fyne being celebrated. The town originally stood on the north side of the bay, clustering round the ancient baronial hold, attributed to Sir Colin Campbell of Lochow, "the Singular," who flourished at the end of the 14th century, but it was removed to its present site in the middle of the 18th century. Inveraray was erected into a burgh of barony in 1472; and Charles I., while a prisoner in Catisbrooke Castle, raised it to a royal burgh in 1648. Much has been done for it by the ducal house of Argyll, whose seat, Inveraray Castle, is about 1 m. from the town. This handsome square structure, built between 1744 and 1761 from designs by Robert Adam, consists of two storeys, with a round overtopping tower at each corner. Some fine tapestry and valuable relics were destroyed by fire in 1877, but the damage to the castle was repaired in 1880. The earls and dukes of Argyll were great planters of trees—mainly larch, spruce, silver fir and New England pines—and their estates around Inveraray are consequently among

the most luxuriantly wooded in the Highlands. Dunquoich, a finely timbered conical hill about 900 ft. high, adjoins the castle on the north and is a picturesque landmark.

**INVERCARGILL**, the chief town of Southland county, South Island, New Zealand, 130 m. by rail S.W. by W. from Dunedin. Pop. (1906) 7299. It lies on a deep estuary of the south coast named New River Harbour, which receives several streams famous for trout-fishing. It is the centre of the large grazing and farming district of Southland; and has a number of factories, including breweries, foundries, woollen mills and timber-works. The plan of the town is rectangular, with wide streets; and there is a fine open reserve. The harbour is deep and well sheltered, but the greater part of the trade passes through the neighbouring Bluff Harbour, on which is Campbelltown, 17 m. S. of Invercargill by rail. Bluff Harbour is the port of call and departure for steamers for Melbourne and Hobart. Exports are wool, preserved meat and timber. The district of Southland was surveyed in 1841, but was reported unfavourable, and settlement was delayed till 1857. Southland was a separate province between 1860 and 1870, but, failing financially as such, rejoined the parent province of Otago. Invercargill became a municipality in 1871, and there are five suburban municipalities. The town is the regular starting-point of a journey to the famous lakes Wakatipu and Te Anau, which are approached by rail.

**INVERELL**, a town of Gough county, New South Wales, Australia, on the Macintyre river, 341 m. N. of Sydney, with which it is connected by rail. Pop. (1901) 3203. It is the centre of a prosperous agricultural district producing, chiefly, wheat and maize; the vine is also largely grown and excellent wine is made. Silver, tin and diamond mines are worked near the town. Inverell became a municipality in 1872.

**INVERKEITHING**, a royal and police burgh of Fifehire, Scotland. Pop. (1901) 1676. It is situated on an inner bay of the shore of the Firth of Forth, 3½ m. S.E. of Dunfermline and 13½ m. N.W. of Edinburgh by the North British railway, via the Forth Bridge. The chief industries are tanning, shipbuilding, milling, paper-making, rope-making and brick-making. With Stirling, Dunfermline, Culross and Queensferry, Inverkeithing returns one member to parliament (the Stirling district burghs). It received its charter from David I. St Peter's, the parish church, dates from the 12th century, but having been nearly destroyed by fire was rebuilt in 1826 in the Gothic style, the ancient tower, however, being preserved. Sir Samuel Greig, the father of the Russian navy and designer of the fortifications at Cronstadt, was born at Inverkeithing in 1735. About half-way towards Dunfermline the battle of Inverkeithing or Pitreavie took place on the 20th of July 1650, when Cromwell's forces defeated the Royalists. A mile and a half to the south lies NORTH QUEENSFERRY (pop. 594), the first railway station on the north side of the Forth Bridge. A little to the west lies the bay of ST MARGARET'S HOPE, which in 1903 was acquired by the government as the site for the naval base of Rosyth, so named from the neighbouring ruined castle of ROSYTH, once the residence of Queen Margaret, wife of Malcolm Canmore. On the west side of the Forth Bridge, in the fairway, lies the rocky islet of BIMAR with a lighthouse, and immediately to the east is the island of INCHGARVIE (Gaelic, "the rough island"), which once contained a castle used as a State prison, the ruins of which were removed to make way for one of the piers of the Forth Bridge.

**INVERNESS**, a royal, municipal and police burgh, seaport and county town of Inverness-shire, Scotland. Pop. (1891) 10,303; (1901) 21,238. It lies on both banks, though principally on the right, of the Ness; and is 118 m. N. of Perth by the Highland railway. Owing to its situation at the north-eastern extremity of Glen More, the beauty of its environment and its fine buildings, it is held to be the capital of the Highlands; and throughout the summer it is the headquarters of an immense tourist traffic. The present castle, designed by William Burn (1780-1870), dates from 1835, and is a picturesque structure effectively placed on a hill by the river's side; it contains the court and county offices. Of the churches, the High or Parish

Church has a square tower surmounted with a steeple, containing one of the bells which Cromwell removed from Fortrose cathedral. On the left bank of the river stands St Andrew's Episcopal Cathedral, in the Decorated Gothic, erected in 1866 from designs by Dr Alexander Ross. Among the schools are the High School, the collegiate school, the school of science and art, and the Royal Academy, incorporated by royal charter in 1792. Other public buildings are the museum, public library, observatory, the northern infirmary, the district asylum, an imposing structure at the base of Dunain Hill (940 ft.), the Northern Counties Blind Institute, the Highland Orphanage and the Town Hall, opened in 1882. In front of the last stands the Forbes Memorial Fountain, and near it is the old town cross of 1685, at the foot of which, protected since the great fire of 1411, is the lozenge-shaped stone called Clach-na-Cudain (Stone of the Tubs), from its having served as a resting-place for women carrying water from the river. The old gaol spire, slightly twisted by the earthquake of 1816, serves as a belfry for the town clock. Half a mile to the west of the Ness is the hill of Tomnahurich (Gaelic, "The Hill of the Fairies"), upon which is one of the most beautifully-situated cemeteries in Great Britain. The open spaces in the town include Victoria park, Maggot Green and the ground where the Northern Meeting—the most important athletic gathering in Scotland—is held at the end of September. Inverness is the great distributing centre for the Highlands. Its industries, however, are not extensive, and consist mainly of tweed (tartan) manufactures, brewing, distilling, tanning, soap and candle-making; there are also nurseries, iron-foundries, saw-mills, granite works, and the shops of the Highland Railway Company. There is some shipbuilding and a considerable trade with Aberdeen, Leith, London and the east coast generally, and by means of the Caledonian Canal with Glasgow, Liverpool and Ireland. The Caledonian Canal passes within 1 m. of the town on its western side. In Muirtown Basin are wharves for the loading and unloading of vessels, and at Clachnaharry the Canal enters Beaulieu Firth. There is little anchorage in the Ness, but at Kessock on the left bank of the river-mouth, where there are piers, a breakwater and a coastguard station, there are several acres of deep water. The river at Inverness is crossed by four bridges, two of them for pedestrians only, and a railway viaduct. The town, which is governed by a provost, bailies and council, unites with Fortrose and Nairn (Inverness Burghs) in sending one member to parliament.

Inverness was one of the chief strongholds of the Picts, and in 565 was visited by Columba with the intention of converting the Pictish king Brude, who is supposed to have resided in the walled fort on Craig Phadric (550 ft.),  $\frac{1}{2}$  m. W. of the town. The castle is said to have been built by Malcolm Canmore, after he had razed to the ground the castle in which Macbeth according to tradition murdered Duncan, and which stood on a hill  $\frac{1}{2}$  m. to the north-east. William the Lion (d. 1214) granted the town four charters, by one of which it was created a royal burgh. Of the Dominican abbey founded by Alexander III. in 1233 hardly a trace remains. On his way to the battle of Harlaw in 1411 Donald of the Isles buried the town, and sixteen years later James I. held a parliament in the castle to which the northern chieftains were summoned, of whom three were executed for asserting an independent sovereignty. In 1562, during the progress undertaken to suppress Huntly's insurrection, Queen Mary was denied admittance into the castle by the governor, who belonged to the earl's faction, and whom she afterwards therefor caused to be hanged. The house in which she lived meanwhile stands in Bridge Street. Beyond the northern limits of the town Cromwell built a fort capable of accommodating 1000 men, but with the exception of a portion of the ramparts it was demolished at the Restoration. In 1715 the Jacobites occupied the royal fortress as barracks, and in 1746 they blew it up.

**INVERNESS-SHIRE**, a highland county of Scotland, bounded N. by Ross and Cromarty, the county of Moray Firths, N.E. by the shires of Nairn and Elgin, E. by Banff and Aberdeen shires, S.E. by Perthshire, S. by Argyllshire and W. by the

Atlantic. It includes the Outer Hebrides south of the northern boundary of Harris, and several of the Inner Hebrides (see **HEBRIDES**) and is the largest shire in Scotland. It occupies an area of 2,695,037 acres, or 4211 sq. m., of which more than one-third belongs to the islands. The county comprises the districts of Moidart, Arisaig and Morar in the S.W., Knoydart in the W., Lochaber in the S., Badenoch in the S.E. and the Aird in the N. Excepting comparatively small and fertile tracts in the N. on both sides of the river Ness, in several of the glens and on the shores of some of the sea lochs, the county is wild and mountainous in the extreme and characterized by beautiful and in certain respects sublime scenery. There are more than fifty mountains exceeding 3000 ft. in height, among them Ben Nevis (4406), the highest mountain in the British Isles, the extraordinary assemblage of peaks forming the Monadhliath mountains in the S.E., Ben Alder (3757) in the S., and the grand group of the Cairngorms on the confines of the shires of Aberdeen and Banff.

In the north-west the Beaulieu river (16 m. long) is formed by the confluence of the Farrar and the Glass. The Enrick (18 m.), rising in Loch-nan-Eun, takes a north-easterly direction for several miles, and then flowing due east falls into Loch Ness, just beyond Drumadrochit, close to the ruined keep of Castle Urquhart. The Ness (7 m.), a fine stream for its length, emerges from Loch Dochfour and enters the sea to the north of Inverness. The Moriston (10 m.), flows out of Loch Clunie, and pursuing a course E. by N.E. falls into Loch Ness 4 m. south of Mealfourvounie (2284 ft.) on the western shore opposite Foyers. The Lochy (9 m.), issuing from the loch of that name, runs parallel with the Caledonian Canal and enters Loch Linnhe at Fort William. The Spean (18 m.), flowing westwards from Loch Laggan, joins the Lochy as it leaves Loch Lochy. The Nevis (12 m.), rising at the back of Ben Nevis, flows round the southern base of the mountain and then running north-westwards enters Loch Linnhe at Fort William. The Leven (12 m.), draining a series of small lochs to the north-west of Rannoch, flows westward to Loch Leven, forming during its course the boundary between the shires of Inverness and Argyll. The Dulnain (28 m.), rising in the Monadhliath Mountains, flows north-eastwards and enters the Spey near Grantown, falling in its course nearly 2000 ft. The Truim (15 $\frac{1}{2}$  m.), rising close to the Perthshire frontier, flows N.N.E. into the Spey. Three great rivers spring in Inverness-shire, but finish their course in other counties. These are the Spey, which for the first 60 m. of its course belongs to the shire; the Findhorn (70 m.), rising in the Monadhliath Mountains a few miles N.W. of the source of the Dulnain; and the Nairn (38 m.), rising within a few miles of Loch Farraline. The two falls of Foyers—the upper of 40 ft., the lower of 165 ft.—are celebrated for their beauty, but their volume is affected, especially in drought, by the withdrawal of water for the works of the British Aluminium Company, which are driven by electric power derived from the river Foyers, the intake being situated above the falls. Other noted falls are Moral on the Enrick and Kilmorack on the Beaulieu.

The number of hill tarns and little lakes is very great, considerably more than 200 being named. Loch Ness, the most beautiful and best known of the larger lakes, is 22 $\frac{1}{2}$  m. long, 1 $\frac{1}{2}$  m. broad at its widest point (Urquhart Bay), has a drainage area of 696 m., and, owing to its vast depth (751 ft.), uniformity of temperature, and continual movement of its waters, never freezes. It is the largest body of fresh water in Great Britain, and forms part of the scheme of the Caledonian Canal. A few miles S.W. is Loch Oich (4 m. long), also utilized for the purposes of the Canal, which reaches its summit level (105 ft.) in this lake. To the S.W. of it is Loch Lochy (9 $\frac{1}{2}$  m.), which is also a portion of the Canal. Loch Arkaig (12 m.) lies in the country of the Camerons, Achnacrany House, the seat of Lochiel, the chief of the clan, being situated on the river Arkaig near the point where it issues from the lake. The old castle was burnt down by the duke of Cumberland, but a few ruins remain. After Culloden Prince Charles Edward found shelter in a cave in the "Black Mile," as the road between Lochs Arkaig and Lochy is called.

Loch Quoich (6 m.) lies N. by W. of Loch Arkaig, and Loch Garry (4½ m.) a few miles to the N. E.; Loch Morar (11½ m. long by 1½ broad) is only about 600 yds. from the sea, to which it drains by the river Morar, which falls over a rocky barrier, at the foot of which is a famous salmon pool. The loch is 1077 ft. deep and is thus the deepest lake in the United Kingdom. It contains several islands, on one of which Lord Lovat was captured in 1746. Loch Laggan (7 m.) and Loch Treig (5½ m.) in the south of the county are both finely situated in the midst of natural forests. The principal salt-water lochs on the Atlantic seaboard are Loch Hourn ("Hell's Lake," so named from the wild precipices rising sheer from the water), running inland for 14 m. from the Sound of Sleat and separating Glenelg from Knoydart; and Loch Nevis (14 m.), a few miles farther south.

The parallel roads of Glen Roy, a glen with a north-easterly to south-westerly trend, a few miles east of Loch Lochy, presented a problem that long exercised the minds of geologists. At heights of 1148 ft., 1067 ft. and 835 ft., there run uninterruptedly along each side of the glen terraces of a width varying from 3 to 30 ft. Local tradition ascribes them to the Ossianic heroes, and John Playfair (1748-1810) argued that they were aqueducts. The fact that they occur also in the neighbouring Glen Gloy and Glen Spean, however, disposes of an artificial origin. John MacCulloch (1773-1835) propounded the theory that they were lacustrine and not marine, and Agassiz followed him with the suggestion that the water had been held up by a barrier of glacier ice. This view is now generally accepted, and the roads may therefore be regarded as the gently sloping banks of lakes dammed up by glacier ice. Glen More-nan-Albin, or the Great Glen, is a vast "fault," or dislocation, 62 m. in length, through which Thomas Telford constructed (1804-1822) the Caledonian Canal connecting Loch Linnhe and the Moray Firth. Glen More is said to be liable to shocks of earthquake, and Loch Ness was violently agitated at the time of the great Lisbon earthquake (1755).

Among the glens renowned for beauty are Glen Urquhart and Glen Moriston to the west of Loch Ness, Glen Feshie in the east, and Glen Nevis at the southern base of Ben Nevis. Glen Garry, to the west of Loch Oich, gave its name to the well-known cap or "bonnet" worn both in the Highlands and Lowlands. In Glen Finnan, at the head of Loch Shiel, Prince Charles Edward raised his standard in 1745, an incident commemorated by a monument erected in 1815 by Alexander Macdonald of Glenaladale. The great straths or valleys are in the north and east, the chief among them being Strathfarrar, Strathglass and Strathnairn, and the heads of Strathearn and Strathspey.

*Geology.*—Almost the entire area of this county is occupied by the younger Highland schists and metamorphic rocks. East of Loch Erich and the rivers Traim and Spey as far as Airmore and between there and Duthel there are quartzites and quartzose schists; on the remaining area the various kinds of schistose and gneissose rock have hardly been worked out in detail. Granite masses occur in numerous isolated patches; the largest is on the eastern boundary and includes the flanks of Cairn Gorm, Cairn Toul, Braerlich, Carn Ban and Meall Tisnail. Other smaller ones are found at Ben Nevis, where the lower part of the mountain is granite, the upper part porphyritic felsite; between Moy and Ben Buidhe Mhor; E. of Foyers, including Whitebridge, Aberchelder and Loch Farraline; at Ben Alder. W. of Loch Erich and another between that loch and the river Pattack; at Banavie on the W. of the river Lochy; around the upper end of Loch Clunje and at several other places. The dioritic mass of Rannoch Moor just enters this county between Loch Erich and Loch Ossian.

The Old Red Sandstone extends into this county from Nairn through Culloden Moor past Inverness and down Loch Ness to a point south of Foyers; it occurs also on the south-east side of Loch Oich, and around Beaulieu, where it forms the falls of Kilmorach. These rocks consist at the base of coarse breccias and conglomerates passing upwards into chocolate-coloured sandstone and flags, with the shaly series containing limestone nodules known as the fish bed from the abundance and importance of its fossil contents; it is well exposed in the Big Burn and near Loch Ashie. At a higher horizon come more purple flags and grits. The Great Glen which traverses the county is an old line of earth fracture along which displacements have been produced during more than one geological period. Roches moutonnées, glacial striations and moraines and other evidences of the great Ice age are abundant, besides the parallel roads of Glen Roy to which allusion has already been made. The

lowest of these terraces is prolonged into Glen Spean. At numerous places on the coasts the remains of old marine terraces occur at 100 ft. and 25 ft. above the sea.

Of the small isles belonging to Inverness-shire those of Rum and Eigg are of the greatest interest. The northern part of Rum is made of Torridonian rocks, shales below and red sandstones above; altogether over 10,000 ft. are visible. These rocks have suffered thrusting and the shales are thus made in places to overlie the sandstones. A few patches of Torridonian occur in the south. Tertiary peridotites in laccolitic masses cover a large area in the south of the island and form the highest ground. These are penetrated by cucurites and gabbros, followed later by granites; and the whole has been subsequently crushed into a complex gneissose mass. Still later, dolerite sills and sheets and dikes of granophyre and quartz felsite followed in the same region. Eigg is mainly built of great basaltic lava flows with intrusions of doleritic rocks; these were succeeded by more acid intrusions, and again by a more basic series of dikes. Pitchstones occur among the later rocks. The Sgurr is capped by a thick intrusion of pitchstone. Jurassic rocks, including the Estuarine Lower Oolite sandstones, shales and limestones and Middle Oolite Oxfordian rocks are found in the north of this island; there is also a small trace of Upper Cretaceous sandstone. Cana, Sanday and Muck are almost wholly basaltic; a small patch of Jurassic occurs on the south of the last-named island. (See also SKYE.)

*Forests and Fauna.*—Deer forests occupy an enormous area, particularly in the west, in the centre, in the south and south-east and in Skye. From the number of trees found in peat bogs, the county must once have been thickly covered with wood. Strathspey is still celebrated for its forests, and the natural woods on Loch Arkaig, in Glen Garry, Glen Moriston, Strathglass and Strathfarrar, and at the head of Loch Shiel, are extensive. The forests consist chiefly of oak, Scotch fir, birch, ash, mountain-ash (rowan), holly, elm, hazel and Scots poplar, but there are also great plantations of larch, spruce, silver fir, beech and plane. Part of the ancient Caledonian forest extends for several miles near the Perthshire boundary. Red and roe deer, the Alpine and common hare, black game and ptarmigan, grouse and pheasant abound on the moors and woodlands. Foxes and wild cats occur, and otters are met with in the lakes and streams. There are also eagles, hawks and owls, while great flocks of waterfowl, particularly swans, resort to Loch Inch and other lakes in Badenoch. Many of the rivers and several of the lochs abound with salmon and trout, the salmon fisheries of the Beaulieu, Ness and Lochy yielding a substantial return.

*Climate and Agriculture.*—Rain is heavy and frequent in the mountains, but slighter towards the northern coast; the fall for the year varying from 73.17 in. at Fort William to 43.17 in. at Fort Augustus, and 26.53 in. at Inverness. The mean temperature for the year is 47.2°F., for January 38.5° and for August 58°. Although since 1852 the cultivated area has increased greatly, actually the percentage of land under crops is still small. The Aird and Beaulieu districts, some of the straths and several of the glens are fertile. Oats are the predominant crop, barley is grown (mostly for the distilleries), but the wheat acreage is trifling. Of green crops turnips do well in certain districts, artificial manures being extensively used. In those quarters where the soil is dry, potatoes are successfully raised. An immense number of the holdings are crofts averaging 5 acres or under. About 50% are between 5 acres and 50; but few are above 50. The operations of the Crofters' Commission (1886) have been beneficial in a variety of ways. Not only have rentals been reduced considerably and arrears cancelled, but the increased sense of security resulting from the granting of fair rentals, fixity of tenure and compensation for disturbance has induced tenants to reclaim waste land, to enlarge their holdings and to apply themselves more thriftily and with greater enterprise and intelligence to the development of their farms. On the large holdings the most modern methods of husbandry are followed, the farm buildings are excellent and the implements up-to-date. The hills furnish good pastures. The flocks of sheep are exceptionally heavy, the chief varieties on the uplands being Cheviots and black-faced and in some of the lower districts Leicesters and half-breeds. Of the cattle the principal breed is the Highland, the largest and best herds of which are in the Western Isles. Polled and shorthorns are also reared, and



Ayrshires are kept for dairy purposes. Great numbers of the hardy Highland ponies are raised on the hill farms, and the breed of agricultural horses was improved by the introduction of Clydesdale stallions. Where pigs are reared they appear to be kept, especially amongst the crofters, for domestic consumption.

**Industries.**—Manufactures are few. Indeed, excepting the industries carried on in Inverness, they are almost entirely confined to distilling—at Fort William, Kingussie, Carbost, Muir of Ord and some other places—brewing, woollens (especially tartans, plaids and rough tweeds), milling and (at Kirkcumbie near Inverness) artificial manures. The catering for the wants of thousands of sportsmen and tourists, however, provides employment for a large number of persons, and has led to the opening of hotels even in the remotest regions. The fisheries, on the other hand, are of great value, especially to the Hebrideans. The kelp industry has died out.

**Communications.**—Owing to its physical character communication by rail is somewhat restricted, but the Highland railway enters the shire from the south near Dalwhinnie and runs to Inverness via Aviemore and Daviot. Another portion of the same system also reaches the county town from Nairnshire. The Dingwall and Skye railway passes along the southern shore of Beaulieu Firth. In the south-west the West Highland railway (North British) enters the county 2 m. N.W. of Rannoch station and terminates at Mallig, via Fort William and Banavie, sending off at Spean Bridge a branch to Fort Augustus. There is also communication by steamer with the piers of the Caledonian Canal and with the Western Isles, and a considerable amount of shipping reaches Beaulieu and Inverness by way of Moray Firth. Coaches supplement rail and steamer at various points.

**Population and Government.**—The population was 90,121 in 1801, and 90,104 in 1901, when 43,281 persons spoke Gaelic and English, and 11,722 Gaelic only. The only considerable towns are Inverness (pop. in 1901, 23,066) and Fort William (2087). The county returns one member to parliament, but the county town, along with Forres, Fortrose and Nairn, belongs to the Inverness district group of parliamentary burghs. Inverness forms a sheriffdom with Elgin and Nairn, and there are resident sheriffs-substitute at Inverness, Fort William, Portree and Lochmaddy. The county is under school-board jurisdiction, and there are voluntary schools (mostly Roman Catholic) in several places. The secondary schools in Inverness and some in the county earn grants for higher education. The town council of Inverness subsidizes the burgh technical and art school. At Fort Augustus is a well-known collegiate institution for the education of the sons of well-to-do Roman Catholics.

**History.**—To the north of the boundary hills of the present counties of Argyll and Perth (beyond which the Romans attempted no occupation) the country was occupied by the Picts, the true Caledonians. The territory was afterwards called the province of Moray, and extended from the Spey and Loch Lochy to Caithness. These limits it retained until the 17th century, when Caithness (in 1617), Sutherland (in 1633) and Ross-shire (in 1661) were successively detached. Towards the end of the 6th century Columba undertook the conversion of the Picts, himself baptizing their king, Brude, at Inverness; but paganism died hard and tribal wars prevented progress. In the 11th century, after the death of Duncan, Scotland was divided between Macbeth and the Norwegian leader Thorfinn, who took for his share the land peopled by the northern Picts. Malcolm Canmore, avenging his father, defeated and slew Macbeth (1057), and at a later date reduced the country and annexed it to the kingdom of Scotland. In 1107, when the bishopric of Moray was founded, the influence of the Church was beginning to effect some improvement in manners. Nevertheless, a condition of insurrection supervened until the reign of David I., when colonists of noble birth were settled in various parts of the shire. After the battle of Largs (1263) the Norse yoke was thrown off. In 1303 Edward I.'s expedition to Scotland passed through the northern districts, his army laying siege to Urquhart and Beaufort castles. After the plantation the clan system gradually developed and attained in the shire

its fullest power and splendour. The Frasers occupied the Aird and the district around Beaulieu; the Chisholms the Urquhart country; the Grants the Spey; the Camerons the land to the west and south of Loch Lochy (Lochell); the Chattan—comprising several septu septu as the Macphersons, Mackintoshes, Farquharsons and Davidsons—Badenoch; the Macdonalds of the Isles Lochaber; the Clanranald Macdonalds Moidart, Knoydart, Morar, Arisaig and Glengarry; and the Macleods Skye. Unfortunately the proud and fiery chieftains were seldom quiet. The clans were constantly fighting each other, occasionally varying their warfare by rebellion against the sovereign. In many quarters the Protestant movement made no headway, the clansmen remaining steadfast to the older creed. At the era of the Covenant, Montrose conducted a vigorous campaign in the interests of the Royalists, gaining a brilliant victory at Inverlochry (1645), but the effects of his crusade were speedily neutralized by the equally masterly strategy of Cromwell. Next Episcopacy appeared to be securing a foothold, until Viscount Dundee fell at Killiecrankie, that battle being followed by a defeat of the Highlanders at Cromdale in 1690. The futile rising headed by Mar in 1715 led to a combined effort to hold the clans in check. Forts were constructed at Inverness, Kilchumin (Fort Augustus) and Kilmallie (Fort William); Wade's famous roads—exhibiting at many points notable examples of engineering—enabled the king's soldiers rapidly to scour the country, and general disarmament was required. Prince Charles Edward's attempt in 1745 had the effect of bringing most of the clans together for a while; but the clan system was broken up after his failure and escape. Heritable jurisdictions were abolished. Even the wearing of the Highland dress was proscribed. The effects of this policy were soon evident. Many of the chieftains became embarrassed, their estates were sold, and the glenfolk, impoverished but high-spirited, sought homes in Canada and the United States. As time passed and passion abated, the proposal was made to raise several Highland regiments for the British army. It was entertained with surprising favour, and among the regiments then enrolled were the 70th Cameron Highlanders. With the closing of the chapter of the Jacobite romance the shire gradually settled down to peaceful pursuits.

The county in parts is rich in antiquarian remains. Stone axes and other weapons or tools have been dug up in the peat, and prehistoric jewelry has also been found. Lake dwellings occur in Loch Lundy in Glengarry and on Loch Beaulieu, and stone circles are numerous, as at Inches, Clava, and in the valley of the Ness. Pictish towers or brochs are met with in Glenbeg (Glenelg), and duns (forts) in the Aird and to the west and south-west of Beaulieu and elsewhere. Among vitrified forts the principal are those on Craig Phadrick, Dundbhairdghall in Glen Nevis, Dun Fionn or Fingal's fort on the Beaulieu, near Kilmorack, Achterave in Glengarry and in Arisaig.

See J. Cameron Lees, *History of the County of Inverness* (Edinburgh, 1897); C. Fraser-Mackintosh, *Letters of Two Centuries* (Inverness, 1890); Alexander Mackenzie, *Histories of the Mackenzies, Camerons, &c.* (Inverness, 1874-1896); A. Stewart, *Nether Lochaber* (Edinburgh, 1883); Alexander Carmichael, "Grazing and Agrarian Customs of the Outer Hebrides" (*Crofters' Commission Report*, 1884).

**INVERSION** (Lat. *invertere*, to turn about), in chemistry, the name given to the hydrolysis of cane sugar into a mixture of glucose and fructose (invert sugar); it was chosen because the operation was attended by a change from dextro-rotation of polarized light to a laevo-rotation. In mathematics, inversion is a geometrical method, discovered jointly by Stubbs and Ingram of Dublin, and employed subsequently with conspicuous success by Lord Kelvin in his electrical researches. The notion may be explained thus: If R be a circle of centre O and radius  $r$ , and P, Q be two points on a radius such that  $OP \cdot OQ = r^2$ , then P, Q are said to be inverse points for a circle of radius  $r$ , and O is the centre of inversion. If one point, say P, traces a curve, the corresponding locus of Q is said to be the inverse of the path of P. The fundamental propositions are: (1) the inverse of a circle is a line or a circle according as the centre of inversion is on or off the circumference; (2) the angle at the

intersection of two circles or of a line and a circle is unaltered by inversion. The method obviously affords a ready means for converting theorems involving lines and circles into other propositions involving the same, but differently placed, figures; in mathematical physics it is of special value in solving geometrically electrostatic and optical problems.

**INVERURIE**, a royal, municipal and police burgh of Aberdeenshire, Scotland, situated at the confluence of the rivers Don and Ury, 16½ m. N.W. of Aberdeen by rail, on the Great North of Scotland railway. Pop. (1901) 3624. Paper-making, milling, and the making of mineral waters are the chief manufactures, but the town is an important centre of the cattle trade with London, markets being held at frequent intervals. It also contains the workshops of the Great North of Scotland railway. Inverurie belongs to the Elgin district group of parliamentary burghs. At Harlaw, about 3 m. to the N.W., was fought in 1411 the great battle between Donald, lord of the Isles, and the royal forces under the earl of Mar. Not far from the scene of this conflict stands Balquhain Castle, a seat of the Leslies, now a mere shell, which was occupied by Queen Mary in September 1562 before the fight at Corrichie between her forces, led by the earl of Moray, and those of the earl of Huntly. The granite block from which she is said to have viewed the combat is still called the Queen's Chair or the Maiden Stone. Near Bennachie (1619 ft.) are stone circles and monoliths supposed to be of Druidical origin. There is a branch line from Inverurie to Old Meldrum, 5½ m. to the N.E. by rail, a market town with a charter dating from 1672, where brewing and distilling are carried on.

**INVESTITURE** (Late Lat. *investitura*), the formal installation into an office or estate, which constituted in the middle ages one of the acts that betokened the feudal relation between suzerain and vassal. The suzerain, after receiving the vassal's homage and oath of fealty, invested him with his land or office by presenting some symbol, such as a clod, a banner, a branch, or some other object according to the custom of the fief. Otto of Freising says: "It is customary when a kingdom is delivered over to any one that a sword be given to represent it, and when a province is transferred a standard is given." As feudal customs grew more stereotyped, the sword and sceptre, emblematic respectively of service and military command and of judicial prerogatives, became the usual emblems of investiture of laymen. The word investiture (from *vestire*, to put in possession) is later than the 9th century; the thing itself was an outcome of feudal society.

It is in connexion with the Church that investiture has its greatest historical interest. The Church quite naturally shared in feudal land-holding; in addition to the tithes she possessed immense estates which had been given her by the faithful from early times, and for the defence of which she resorted to secular means. The bishops and abbots, by confiding their domains to laymen on condition of assistance with the sword in case of need, became temporal lords and suzerains with vassals to fight for them, with courts of justice, and in short with all the rights and privileges exercised by lay lords. On the other hand there were bishop-dukes, bishop-counts, &c., themselves vassals of other lords, and especially of the king, from whom they received the investiture of their temporalities. Many of the faithful founded abbeys and churches on condition that the right of patronage, that is the choice of beneficiaries, should be reserved to them and their heirs. Thus in various ways ecclesiastical benefices were gradually transformed into fiefs, and lay suzerains claimed the same rights over ecclesiastics as over other vassals from whom they received homage, and whom they invested with lands. This ecclesiastical investiture by lay princes dates at least from the time of Charlemagne. It did not seem fitting at first to confer ecclesiastical investiture by such military and worldly emblems as the sword and sceptre, nor to exact an oath of fealty. The emperor Henry I. invested bishops with a glove; Otto II. presented the pastoral staff; Conrad II., according to Wipo, went farther and required from the archbishop of Milan an oath of fealty. By the time of

Henry III. investiture with ring and crozier had become the general practice: it probably had been customary in some places since Otto II.

Investiture of ecclesiastics by laymen had certain serious effects which were bound to bring on a conflict between the temporal and spiritual authorities. In the first place the lay authorities often rendered elections uncanonical by interfering in behalf of some favourite, thereby impairing the freedom of the electors. Again, benefices were kept vacant for long periods in order to ensure to the lord as long as possible the exercise of his regalian rights. And, finally, control by temporal princes of investiture, and indirectly of election, greatly increased simony. Otto II. is charged with having practised simony in this connexion, and under Conrad II. the abuse grew prevalent. At a synod at Reims in 1049, the bishops of Nevers and Coutances affirmed that they had bought their bishoprics, and the bishop of Nantes stated that his father had been a bishop and that on his decease he himself had purchased the see. At a synod at Toulouse in 1056, Berengar of Narbonne accused the bishop of having purchased his see for 100,000 *solidi*, and of having plundered his church and sold relics and crucifixes to Spanish Jews in order to secure another 100,000 *solidi* with which to buy for his brother the bishopric of Urgel. Innumerable similar cases appear in acts of synods and in chronicles during the 11th century. Ecclesiastical investiture was further complicated by the considerable practice of concubinage. There was always the tendency for clerics in such cases to invest their sons with the temporalities of the Church; and the synod convened by Benedict VIII. at Pavia in 1013 (or 1022 according to some authorities) was mainly concerned with the issue of decrees against clerics who lived with wives or concubines and bestowed Church goods on their children. In time the Church came to perceive how closely lay investiture was bound up with simony. The sixth decree of the Lateran synod of 1059 forbade any cleric to accept Church office from a layman. In the following year this decree was reaffirmed by synods held at Vienne and Toulouse under the presidency of a legate of Nicholas II. The main investiture struggle with the empire did not take place, however, until Hildebrand became Pope Gregory VII. To Gregory it was intolerable that a layman, whether emperor, king or baron, should invest a churchman with the emblems of spiritual office; ecclesiastical investiture should come only from ecclesiastics. To the emperor Henry IV. it was highly undesirable that the advantages and revenues accruing from lay investiture should be surrendered; it was reasonable that ecclesiastics should receive investiture of temporalities from their temporal protectors and suzerains.

Although the full text of the decrees of the famous Lateran synod of 1075 has not been preserved, it is known that Gregory on that occasion denounced the marriage of the clergy, excommunicated five of Henry IV.'s councillors on the ground that they had gained church offices through simony, and forbade the emperor and all laymen to grant investiture of bishopric or inferior dignity. The pope immediately summoned Henry to appear at Rome in order to justify his private misconduct, and Henry replied by causing the partisan synod of Worms (1076) to pronounce Gregory's deposition. The pope excommunicated the emperor and stirred up civil war against him in Saxony with such success that he brought about Henry's bitter humiliation at Canossa in the following year. The papal prohibition of lay investiture was renewed at synods in 1078 and 1080, and although Gregory's death in exile (1085) prevented him from realizing his aim in the matter, his policy was steadfastly maintained by his successors. Victor III. condemned lay investiture at the synod of Benevento in 1087, and Urban II. at that of Meli in 1089. At the celebrated council of Clermont (1095), at which the first crusade was preached, Urban strengthened the former prohibitions by declaring that no one might accept any spiritual office from a layman, or take an oath of fealty to any layman. Urban's immediate successor, Paschal II., stirred up the rebellion of the emperor's son, but soon found Henry V. even more persistent in the claim of

investiture than Henry IV. had been. Several attempts at settlement failed. In February 1111 legates of Paschal II. met Henry V. at Sutri and declared that the pope was ready to surrender all the temporalities that had been bestowed on the clergy since the days of Charlemagne in return for freedom of election and the abolition of lay investiture. Henry, having agreed to the proposal, entered Rome to receive his crown. The bishops and clergy who were present at the coronation protested against this surrender, and a tumult arising, the ceremony had to be abandoned. The king then seized pope and curia and left the city. After two months of close confinement Paschal consented to an unqualified renunciation on his part of the right of investiture. In the following year, however, a Lateran council repudiated this compact as due to violence, and a synod held at Vienne with papal approval declared lay investiture to be heresy and placed Henry under the ban. The struggle was complicated throughout its course by political and other considerations; there were repeated rebellions of German nobles, constant strife between rival imperial and papal factions in the Lombard cities and at Rome, and creation of several anti-popes, of whom Guibert of Ravenna (Clement III.) and Gregory VIII. were the most important. Final settlement of the struggle was retarded, moreover, by the question of the succession to the lands of the great Countess Matilda, who had bequeathed all her property to the Holy See, Henry claiming the estates as suzerain of the fiefs and as heir of the allodial lands. The efforts of Gelasius II. to settle the strife by a general council were rendered fruitless by his death (1119).

At length in 1122 the struggle was brought to an end by the concordat of Worms, the provisions of which were incorporated in the eighth and ninth canons of the general Lateran council of 1123. The settlement was a compromise. The emperor, on the one hand, preserved feudal suzerainty over ecclesiastical benefices; but, on the other, he ceased to confer ring and crozier, and thereby not only lost the right of refusing the elect on the grounds of unworthiness, but also was deprived of an efficacious means of maintaining vacancies in ecclesiastical offices. Few efforts were made to undo the compromise. King Lothair the Saxon demanded of Innocent II. the renewal of lay investiture as reward for driving the antipope Anacletus from Rome, but the opposition of St. Bernard and the German prelates was so potent that the king dropped his demand, and Innocent in 1133 confirmed the concordat. In fact, the imperial control over the election of bishops in Germany came later to be much curtailed in practice, partly by the tacitly changed relations between the empire and its feudatories, partly by explicit concessions wrung at various times from individual emperors, such as Otto IV. in 1209 and Frederick II. in 1213; but the principles of the concordat of Worms continued theoretically to regulate the tenure of bishoprics and abbeys until the dissolution of the empire on 1806.

In France the course of the struggle was somewhat different. As in the empire, the king and the nobles, each within his own sphere of influence, claimed the right of investing with ring and crozier and of exacting homage and oaths of fealty. The struggle, however, was less bitter chiefly because France was not a united country, and it was eventually terminated without formal treaty. The king voluntarily abandoned lay investiture and the claim to homage during the pontificate of Paschal II., but continued to interfere with elections, to appropriate the revenues of vacant benefices, and to exact an oath of fealty before admitting the elect to the enjoyment of his temporalities. Most of the great feudal lords followed the king's example, but their concessions varied considerably, and in the south of France some of the bishops were still doing homage for their sees until the closing years of the 13th century; but long before then the right of investing with ring and crozier had disappeared from every part of France.

England was the scene of an investiture contest in which the chief actors were Henry I. and Anselm. The archbishop, in obedience to the decrees of Gregory VII. and Urban II., not only refused to perform homage to the king (1100), but also

refused to consecrate newly-chosen bishops who had received investiture from Henry. The dispute was bitter, but was carried on without any of the violence which characterized the conflict between papacy and empire; and it ended in a compromise which closely foreshadowed the provisions of the concordat of Worms and received the confirmation of Paschal II. in 1106. Freedom of election, somewhat similar in form to that which still exists, was formally conceded under Stephen, and confirmed by John in Magna Carta.

Many documents relating to the investiture struggle have been edited by E. Dümmler in *Monumenta Germaniae historica. Libelli de lite imperatorum et pontificum saeculis xi. et xii.* (3 vols., 1891-1897). See Ducange, *Glossarium*, s.v. "Investitura."

On investiture in the empire consult C. Mirbt, *Die Publicistik im Zeitalter Gregors VII.* (Leipzig, 1894); E. Bernheim, *Das Wormser Konkordat* (Breslau, 1906); R. Boerger, *Die Bekehrungen der deutschen geistlichen Fürsten* (Leipzig, 1901); K. E. Benz, *Die Stellung der Bischöfe von Meissen, Merseburg und Naumburg im Investiturstreit unter Heinrich IV. und Heinrich V.* (Dresden, 1899); W. Martens, *Gregor VII., sein Leben und Wirken* (2 vols., Leipzig, 1894); H. Fisher, *The Medieval Empire*, c. to (London, 1898). For France, see P. Imbart de la Tour, *Les Elections épiscopales dans l'église de France du XI<sup>e</sup> au XII<sup>e</sup> siècle* (Paris, 1891); A. Luchaire, *Histoire des institutions monarchiques de la France sous les premiers Capétiens 987-1180* (2nd ed., Paris, 1891); P. Viollet, *Histoire des institutions politiques et administratives de la France* (Paris, 1898); Ibach, *Der Kampf zwischen Papsttum und Königtum von Gregor VII. bis Calisto II.* (Frankfurt, 1884). For England, see J. F. Bohmer, *Kirche und Staat in England und in der Normandie im XI. und XII. Jahrhundert* (Leipzig, 1899); E. A. Freeman, *The Reign of William II. Rufus and the Accession of Henry I.* (London, 1882); H. W. C. Davis, *England under the Normans and Angevins* (London, 1905).

**INVOICE** (originally a plural, *Invoyes* or *Invoys*, of *Invoy*, a variant of "envoy," from the French *envoyer*, to send), a statement giving full particulars of goods sent or shipped by a trader to a customer, with the quantity, quality and prices, and the charges upon them. Consular invoices, i.e. invoices signed at the port of shipment by a consul of the country to which the goods are being consigned, are generally demanded by those countries which impose *ad valorem* duties.

**INVOLUTION** (Lat. *involvere*, to roll up), a rolling up or complication. In arithmetic, involution is the operation of raising a quantity to any power; it is the converse of evolution, which is the operation of extracting any root of a quantity (see ARITHMETIC; ALGEBRA). In geometry, an involution is a one-to-one correspondence between two ranges of points or between two pencils (see GEOMETRY; Projective). The "involute" of a curve may be regarded as the locus of the extremity of a string when it is unwrapped from the curve (see INFINITESIMAL CALCULUS).

**IO**, in Greek mythology, daughter of Inachus, the river-god of Argos and its first king. As associated with the oldest worship of Hera she is called the daughter of Peiren, who made the first image of that goddess out of a pear-tree at Tiryns; and under the name of Callithyia Io was regarded as the first priestess of Hera. Zeus fell in love with her, and, to protect her from the wrath of Hera, changed her into a white heifer (Apollodorus ii. 1; Hyginus, *Fab.* 145; Ovid, *Metam.* i. 568-733); according to Aeschylus (*Supplices*, 299) the metamorphosis was the work of Hera herself. Hera, having persuaded Zeus to give her the heifer, set Argus Panoptes to watch her. Zeus thereupon sent Hermes, who lulled Argus to sleep and cut off his head with the sword with which Perseus afterwards slew the Gorgon. In another account Argus is killed by a stone thrown by Hermes. But the wrath of Hera still pursued Io. Maddened by a gadfly sent by the goddess she wandered all over the earth, swam the strait known on this account as the Bosphorus (Ox-ford), and crossed the Ionian sea (traditionally called after her) until at last she reached Egypt, where she was restored to her original form and became the mother of Epaphus. Accounts of her wanderings (differing considerably in detail) are given in the *Supplices* and *Prometheus Vinculus* of Aeschylus. Various interpretations are given of the latter part of her story, which dates from the 7th century B.C., when intercourse was frequent between Greece and Egypt, and when much influence was

erected on Greek thought by Egyptian religion. According to the rationalistic explanation of Herodotus (l. 1) Io was an Argive princess who was carried off to Egypt by the Phoenicians. Epaphus, the son of Io, the supposed founder of Memphis, was identified with Apis. He was said to have been carried off by order of Hera to Byblos in Syria, where he was found again by Io. On returning to Egypt, Io, afterwards identified with Isis, married Telegonus and founded the royal families of Egypt, Phoenicia, Argos and Thebes. The journey to Syria in search of Epaphus was invented to explain the fact that the Phoenician goddess Astarte, who was sometimes represented as horned, was confounded with Io.

Io herself is variously interpreted. She is usually understood to be the moon in the midst of the mighty heaven, studded with stars, represented by Argus. According to others, she is the annual rising of the Nile; the personification of the Ionian race; the mist; the earth. It seems probable that she was a duplicate of Hera (Io  $\beta\omicron\lambda\eta\kappa\omega\varsigma$  is Hera  $\beta\omicron\lambda\eta\iota\varsigma$ ), or a deity in primitive times worshipped under the symbol of a cow, whose worship was superseded by that of Hera; the recollection of this early identity would account for Io being regarded as the priestess of the goddess in later times. Amongst the Romans she was sometimes identified with Anna Perenna. The legend of Io spread beyond Argos, especially in Byzantium and Euboea, where it was associated with the town of Argura. It was a favourite subject among Greek painters, and many representations of it are preserved on vases and wall paintings; Io herself appears as a horned maiden or as the heifer watched by Argus.

See R. Engelmann, *De Ione* (1868), with notes containing references to authorities, and his article in Roscher's *Lexikon der Mythologie*; J. Overbeck, *De Ione, Telluris, non Iunae, Dea* (1872); P. W. Forchhammer, *Die Wanderungen der Inachostochter Io* (1881), with map and special reference to Aeschylus's account of Io's wanderings; F. Durrbach in Daremberg and Saglio's *Dictionnaire des antiquités*; G. Mellen, *De Ias fabula* (1901); Wernicke, s.v. "Argos" in *Fauly-Wissowa's Realencyclopädie*, ii. pt. 1. (1896); J. E. Harrison in *Classical Review* (1893, p. 76); Bacchylides xviii. (xix.), with Jebb's notes.

**IODINE** (symbol I, atomic weight 126.92), a chemical element, belonging to the halogen group. Its name is derived from Gr.  $\iota\omicron\delta\alpha\iota\eta\varsigma$  (violet-coloured), in allusion to the colour of its vapour. It was discovered in 1812 by B. Courtois when investigating the products obtained from the mother-liquors prepared by lixiviating kelp or burnt seaweed, and in 1815 L. J. Gay-Lussac showed that it was an element. Iodine does not occur in nature in the uncombined condition, but is found very widely but sparingly distributed in the form of iodides and iodates, chiefly of sodium and potassium. It is also found in small quantities in sea-water, in some seaweeds, and in various mineral and medicinal springs. Deep-sea weeds as a rule contain more iodine than those which are found in the shallow waters.

Iodine is obtained either from kelp (the ashes of burnt seaweed) or from the mother-liquors obtained in the purification of Chile saltpetre. In the former case the seaweed is burnt in large heaps, care being taken that too high a temperature is not reached, for if the ash be allowed to fuse much iodine is lost by volatilization. The product obtained after burning is known either as *kelp* or *sarcoc*. Another method of obtaining kelp is to heat the seaweed in large retorts, whereby tarry and ammoniacal liquors pass over and a very porous residue of kelp remains. A later method consists in boiling the weed with sodium carbonate; the liquid is filtered and hydrochloric acid added to the filtrate, when *alginate acid* is precipitated; this is also filtered off, the filtrate neutralized by caustic soda, and the whole evaporated to dryness and carbonized, the residue obtained being known as *kelp substitute*. The kelp obtained by any of these methods is then lixiviated with water, which extracts the soluble salts, and the liquid is concentrated, when the less soluble salts, which are chiefly alkaline chlorides, sulphates and carbonates, crystallize out and are removed. Sulphuric acid is now added to the liquid, and any alkaline sulphides and sulphites present are decomposed, while iodides and bromides are converted into sulphates, and hydriodic and hydrobromic

acids are liberated and remain dissolved in the solution. The liquid is run into the iodine still and gently warmed, manganese dioxide in small quantities being added from time to time, when the iodine distils over and is collected. In the second method it is found that the mother-liquors obtained from Chile saltpetre contain small quantities of sodium iodate  $\text{NaIO}_3$ ; this liquor is mixed with the calculated quantity of sodium bisulphite in large vats, and iodine is precipitated:—



The precipitate is washed and then distilled from iron retorts. Iodine may also be prepared by the decomposition of an iodide with chlorine, or by heating a mixture of an iodide and manganese dioxide with concentrated sulphuric acid. Commercial iodine may be purified by mixing it with a little potassium iodide and then subliming the mixture; in this way any traces of bromine or chlorine are removed. J. S. Stas recommends solution of the iodine in potassium iodide and subsequent precipitation by the addition of a large excess of water, the precipitate being washed, distilled in steam, and dried *in vacuo* over solid calcium nitrate, and then over solid caustic baryta.

Iodine is a greyish-black shining solid, possessing a metallic lustre and having somewhat the appearance of graphite. Its specific gravity is 4.948 (17°/4°). It melts at 114.2° C. and boils at 184.35° C. under atmospheric pressure (W. Ramsay and S. Young). The specific heat of solid iodine is 0.0541 (H. Kopp). Its latent heat of fusion is 11.7 calories, and its latent heat of vaporization is 23.95 calories (P. A. Favre and J. T. Silbermann). The specific heat of iodine vapour at constant pressure is 0.03486, and at constant volume 0.02607. It volatilizes slowly at ordinary temperatures, but rapidly on heating. Iodine vapour on heating passes from a violet colour to a deep indigo blue; this behaviour was investigated by V. Meyer (*Ber.*, 1880, 13, p. 394), who found that the change of colour was accompanied by a change of vapour density. Thus, the density of air being taken as unity, Victor Meyer found the following values for the density of iodine vapour at different temperatures:—

t° C.	253	450	506	842	1027	1570
Density	8.89	8.84	8.73	6.08	5.75	5.67

This shows that the iodine molecule becomes less complex in structure at higher temperatures.

Iodine possesses a characteristic penetrating smell, not so pungent, however, as that of chlorine or bromine. It is only very sparingly soluble in water, but dissolves readily in solutions of the alkaline iodides and in alcohol, ether, carbon bisulphide, chloroform, and many liquid hydrocarbons. Its solutions in the alkaline iodides and in alcohol and ether are brown in colour, whilst in chloroform and carbon bisulphide the solution is violet. It appears to combine with the solvent (P. Waentig, *Zeit. phys. Chem.*, 1909, p. 513). Its chemical properties closely resemble those of chlorine and bromine; its affinity for other elements, however, is as a rule less than that of either. It will only combine with hydrogen in the presence of a catalyst, but combines with many other elements directly; for example, phosphorus melts and then inflames, antimony burns in the vapour, and mercury when heated with iodine combines with it rapidly. It is completely oxidized to iodic acid when boiled with fuming nitric acid. It is soluble in a solution of caustic potash, a dilute solution most probably containing the hypoiodite, which, however, changes slowly into iodate, the change taking place rapidly on warming. When alkali is added to aqueous iodine, followed immediately by either soda water or sodium bicarbonate, most of the original iodine is precipitated (R. L. Taylor, *Jour. Chem. Soc.*, 1897, 71, p. 725, and K. J. P. Orton, *ibid.*, p. 830). Iodine can be readily detected by the characteristic blue coloration that it immediately gives with starch paste; the colour is destroyed on heating, but returns on cooling provided the heating has not been too prolonged. Iodine in the presence of water frequently acts as an oxidizing agent; thus arsenious acid and the arsenites, on the addition of iodine solution, are converted into arsenic acid and arsenates. A dilute solution of iodine prevents the decomposition of hydrogen peroxide by

colloidal platinum (G. Bredig, *Zeit. phys. Chem.*, 1899, 31, p. 258; 1901, 37, p. 323).

Iodine finds application in organic chemistry, forming addition products with unsaturated compounds, the combination, however, being more slow than in the case of chlorine or bromine. It rarely substitutes directly, because the hydriodic acid produced reverses the reaction; this can be avoided by the presence of precipitated mercuric oxide or iodic acid, which react with the hydriodic acid as fast as it is formed, and consequently remove it from the reacting system. As a rule it is preferable to use iodine in the presence of a carrier, such as amorphous phosphorus or ferrous iodide or to use it with a solvent. It is found that most organic compounds containing the grouping  $\text{CH}_2\text{CO}-\text{C}-$  or  $\text{CH}_3\text{CH}(\text{OH})-\text{C}-$  in the presence of iodine and alkali give iodo- or chloro- $\text{CHI}_2$ .

**Hydriodic acid**, HI, is formed by the direct union of its components in the presence of a catalytic agent; for this purpose platinum black is used, and the hydrogen and iodine vapour are passed over the heated substance. On shaking up iodine with a solution of sulphuretted hydrogen in water, a solution of hydriodic acid is obtained, sulphur being at the same time precipitated. The acid cannot be prepared by the action of concentrated sulphuric acid on an iodide on account of secondary reactions taking place, which result in the formation of free iodine and sulphur dioxide. The usual method is to make a mixture of amorphous phosphorus and a large excess of iodine and then to allow water to drop slowly upon it; the reaction starts readily, and the gas obtained can be freed from any admixed iodine vapour by passing it through a tube containing some amorphous phosphorus. It is a colourless sharp-smelling gas which fumes strongly on exposure to air. It readily liquefies at  $0^\circ\text{C}$ . under a pressure of four atmospheres, the liquefied acid boiling at  $-34.14^\circ\text{C}$ . ( $730.4\text{ mm.}$ ); it can also be obtained as a solid melting at  $-50.8^\circ\text{C}$ . It is readily soluble in water, one volume of water at  $10^\circ\text{C}$ . dissolving 425 volumes of the acid. The saturated aqueous solution is colourless and fumes strongly on exposure to air; after a time it darkens in colour owing to liberation of iodine. The gas is readily decomposed by heat into its constituent elements. It is a powerful reducing agent, and is frequently employed for this purpose in organic chemistry; thus hydroxy acids are readily reduced on heating with the concentrated acid, and nitro compounds are reduced to amino compounds, &c. It is preferable to use the acid in the presence of amorphous phosphorus, for the iodine liberated during the reduction is then utilized in forming more hydriodic acid, and consequently the original amount of acid goes much further. It forms addition compounds with unsaturated compounds.

It has all the characteristics of an acid, dissolving many metals with evolution of hydrogen and formation of salts, called *iodides*. The iodides can be prepared either by direct union of iodine with a metal, from hydriodic acid and a metal, oxide, hydroxide or carbonate, or by action of iodine on some metallic hydroxides or carbonates (such as those of potassium, sodium, barium, &c.); other products, however, are formed at the same time. The iodides as a class resemble the chlorides and bromides, but are less fusible and volatile. Silver iodide, mercurous iodide, and mercuric iodide are insoluble in water; lead iodide is sparingly soluble, whilst most of the other metallic iodides are soluble. Strong heating decomposes the majority of the iodides. Nitric acid and chlorine readily decompose them, with liberation of iodine; the same effect being produced when they are heated with concentrated sulphuric acid and manganese dioxide. The soluble iodides, on the addition of silver nitrate to their nitric acid solution, give a yellow precipitate of silver iodide, which is insoluble in ammonia solution. Hydriodic acid and the iodides may be estimated by conversion into silver iodide.

Iodine combines with chlorine to form *iodine monochloride*,  $\text{ICl}$ , which may be obtained by passing dry chlorine over dry iodine until the iodine is completely liquefied, or according to K. Bunsen by boiling iodine with *aqua regia* and extracting with ether. It exists in two different crystalline forms, the more stable or  $\beta$  form melting at  $27.2^\circ\text{C}$ ., and the less stable or  $\alpha$  form melting at  $13.9^\circ\text{C}$ . It is readily decomposed by water. The  $\beta$  chloride,  $\text{ICl}_2$ , results from the action of excess of chlorine on iodine, or from iodic acid and hydrochloric acid, or by heating iodine pentoxide with phosphorus pentachloride. It crystallizes in long yellow needles and decomposes readily on heating into the monochloride and chlorine. It is readily soluble in water, but excess of water decomposes it. (See W. Storer-Baker, *Zeit. phys. Chem.*, 1889, 3, p. 102.) Iodine monochloride in glacial acetic acid solution was used by A. Michael and T. H. Norton (*Ber.*, 1876, 9, p. 1752) for the preparation of paraiodoacetanilide.

**Iodine Pentoxide**,  $\text{I}_2\text{O}_5$ , the best-known oxide, is obtained as a white crystalline solid by heating iodic acid to  $170^\circ\text{C}$ .; it is easily soluble in water, combining with the water to regenerate iodic acid; and when heated to  $300^\circ\text{C}$ . it breaks up into its constituent elements. (See M. Guichard, *Compt. rend.*, 1909, 148, p. 925.) Iodine dioxide,  $\text{IO}_2$ , obtained by Millon, and reinvestigated by M. P. Muir

(*Jour. Chem. Soc.*, 1909, 95, p. 656), is a lemon-yellow solid obtained by acting on iodic acid with sulphuric acid, oxygen being evolved. By acting with ozone on a chloroform solution of iodine, F. Fichter and F. Kohner (*Ber.*, 1909, 42, p. 4093) obtained a yellowish white oxide, of the formula  $\text{I}_2\text{O}_5$ , which they regard as an iodate of trivalent iodine, Millon's oxide being considered a basic iodate.

Although *hydroiodic acid* is not known, it is extremely probable that on adding iodine or iodine monochloride to a dilute solution of a caustic alkali, hypiodites are formed, the solution obtained having a characteristic smell of iodoform, and being of a pale yellow colour. It oxidizes arsenites, sulphites and thiosulphates immediately. The solution is readily decomposed on the addition of sodium or potassium bicarbonates, with liberation of iodine. The hypiodite disappears gradually on standing, and rapidly on warming, being converted into iodate (see R. L. Taylor, *Jour. Chem. Soc.*, 1897, 71, p. 725, and K. J. P. Orton, *ibid.*, p. 830). The peculiar nature of the action between iodine and chlorine in aqueous solution has led to the suggestion that the product is a base, i.e. iodine hydroxide. Tri-iodic hydroxide,  $\text{I}_3\text{OH}$ , is obtained by oxidizing potassium iodide with sulphuric acid and potassium permanganate (A. Skrabal and F. Buchter, *Chem. Zeit.*, 1909, 33, pp. 1184, 1193).

**Iodic Acid**,  $\text{HIO}_3$ , can be prepared by dissolving iodine pentoxide in water; by boiling iodine with fuming nitric acid,  $6\text{I} + 10\text{HNO}_3 = 6\text{HIO}_3 + 10\text{NO} + 2\text{H}_2\text{O}$ ; by decomposing barium iodate with the calculated quantity of sulphuric acid, previously diluted with water, or by suspending iodine in water and passing chlorine,  $\text{I}_2 + 5\text{Cl}_2 + 6\text{H}_2\text{O} = 2\text{HIO}_3 + 10\text{HCl}$ . It is a white crystalline solid, easily soluble in water, the solution showing a strongly acid reaction with litmus; the colour, however, is ultimately discharged by the bleaching power of the compound. It is a most powerful oxidizing agent, phosphorus being readily oxidized to phosphoric acid, arsenic to arsenic acid, silicon at  $250^\circ\text{C}$ . to silica, and hydrochloric acid to chlorine and water. It is readily reduced, with separation of iodine, by sulphur dioxide, hydriodic acid or sulphuretted hydrogen, thus:—

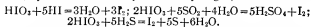

The salts, known as the *iodates*, can be prepared by the action of the acid on a base, or sometimes by the oxidation of iodine in the presence of a base. They are mostly insoluble or only very slightly soluble in water. The iodates of the alkali metals are, however, readily soluble in water (except potassium iodate). They are more easily reduced than the corresponding chlorates; an aqueous solution of hydriodic acid gives free iodine and a metallic iodide, whilst aqueous hydrochloric acid gives iodine trichloride, chlorine, water and a chloride. They are decomposed on heating, with liberation of oxygen, in some cases leaving a residue of iodine and in others a residue of oxide of the metal, with liberation of iodine as well as of oxygen.

**Periodic Acid**,  $\text{HIO}_4 \cdot 2\text{H}_2\text{O}$ , is only known in the hydrated form. It can be prepared by the action of iodine on perchloric acid, or by boiling normal silver periodate with water:  $2\text{AgIO}_4 + 4\text{H}_2\text{O} = \text{Ag}_2\text{H}_4\text{IO}_8 + \text{HIO}_4 \cdot 2\text{H}_2\text{O}$ . It is a colourless, crystalline, deliquescent solid which melts at  $135^\circ\text{C}$ ., and at  $140^\circ\text{C}$ . is completely decomposed into iodine pentoxide, water and oxygen. The periodates are a very complex class of salts, and may be divided into four classes, namely, meta-periodates derived from the acid  $\text{HIO}_4$ ; meso-periodates from  $\text{HIO}_4 \cdot \text{H}_2\text{O}$ ; para-periodates from  $\text{HIO}_4 \cdot 2\text{H}_2\text{O}$  and the diperiodates from  $2\text{HIO}_4 \cdot \text{H}_2\text{O}$  (see C. Kimmins, *Jour. Chem. Soc.*, 1887, 51, p. 356).

Iodine has extensive applications in volumetric analysis, being used more especially for the determination of copper.

The atomic weight of iodine was determined by J. S. Stas, from the analysis of pure silver iodate, and by C. Marignac from the determination of the ratios of silver to iodine, and of silver iodide to iodine; the mean value obtained for the atomic weight being 126.53. G. P. Baxter (*Jour. Amer. Chem. Soc.*, 1904, 26, p. 1577); 1905, 27, p. 876; 1909, 31, p. 201), using the method of Marignac, obtained the value 126.985 (0 = 16). P. Köthner and E. Auer (*Ber.*, 1904, 37, p. 2536; *Ann.*, 1904, 337, p. 362), who converted pure ethyl iodide into hydriodic acid and subsequently into silver iodide, which they then analysed, obtained the value 126.026 (H = 1); a discussion of this and other values gave as a mean 126.97 (0 = 16).

In medicine iodine is frequently used especially as a counter-irritant, having powerful antiseptic properties. In the form of certain salts iodine is very widely used, for internal administration in medicine and in the treatment of many conditions usually classed as surgical, such as the bone manifestations of tertiary syphilis. The most commonly used salt is the iodide of potassium; the iodides of sodium and ammonium are almost as frequently employed, and those of calcium and strontium are in occasional use. The usual doses of these salts are from five to thirty grains or more. Their pharmacological action is as obscure as their effects in certain diseased conditions are consistently brilliant and unexemplified. Our ignorance of their mode of action is cloaked by the term *deobstruent*, which implies that they possess

the power of driving out impurities from the blood and tissues. Most notably is this the case with the poisonous products of syphilis. In its tertiary stages—and also earlier—this disease yields in the most rapid and unmistakable fashion to iodides; so much so that the administration of these salts is at present the best means of determining whether, for instance, a cranial tumour be syphilitic or not. No surgeon would think of operating on such a case until iodides had been freely administered and, by failing to cure, had proved the disease to be non-syphilitic. Another instance of this deobstruent power—"alterative," it was formerly termed—is seen in the case of chronic lead poisoning. The essential part of the medicinal treatment of this condition is the administration of iodides, which are able to decompose the insoluble albuminates of lead which have become locked up in the tissues, rapidly causing their degeneration, and to cause the excretion of the poisonous metal by means of the intestine and the kidneys. The following is a list of the principal conditions in which iodides are recognized to be of definite value: metallic poisonings, as by lead and mercury, asthma, aneurism, arteriosclerosis, angina pectoris, gout, goitre, syphilis, haemophilia, Bright's disease (nephritis) and bronchitis.

Small quantities of the iodate (KIO<sub>3</sub>) are a frequent impurity in iodide of potassium, and cause the congeries of symptoms known as *iodism*. These comprise dyspepsia, skin eruption and the manifestations which are usually identified with a "cold in the head." In many cases, as in syphilis, aneurism, lead poisoning, &c., the life of the patient depends on the free and continued use of the iodide, and this is best to be accomplished by securing an absolutely pure supply of the salt. Another often successful method of preventing the onset of symptoms of poisoning is to administer small doses of ammonium carbonate with the drug, thereby neutralizing the iodic acid which is liberated in the stomach.

**IODOFORM**, CHI<sub>3</sub>, a valuable antiseptic discovered by G. S. Sérullas in 1822; in 1834 J. B. Dumas showed that it contained hydrogen. It is formed by the action of iodine and aqueous potash on ethyl alcohol, acetone, acetaldehyde and from most compounds containing the grouping CH<sub>2</sub>-CO-C-. Its formation from alcohol may be represented thus: C<sub>2</sub>H<sub>5</sub>OH + 4I<sub>2</sub> + 6KHO = CHI<sub>3</sub> + KHC<sub>2</sub>O<sub>4</sub> + 5KI + 5H<sub>2</sub>O. It crystallizes in yellow hexagonal plates, melting at 119-120° C., and is readily soluble in alcohol and ether, but is insoluble in water. It has a characteristic odour and is volatile in steam. On reduction with hydric acid, it yields methylene iodide, CHI<sub>2</sub>.

More recently, iodoform has been prepared by the electrolysis of a solution of potassium iodide in the presence of alcohol or acetone, the electrolytic cell being fitted with a diaphragm, in order to prevent the hydrogen which is formed at the same time from reducing the iodine, or from combining with the iodine to form hydroiodic acid. K. Elbs uses a solution of potassium iodide and sodium carbonate in water, which with the necessary alcohol is contained in a porous cell fitted with a lead anode, whilst the cathode compartment contains a solution of caustic soda and a nickel electrode. The electrolysis is carried out at a temperature of 70° C., and a current density of one ampère per square decimetre is used. At the end of three hours a yield of 70% of the theoretical quantity is obtained.

**IOLA**, a city and the county-seat of Allen county, Kansas, U.S.A., on the Neosho river, about 100 m. S. by W. of Kansas City. Pop. (1890) 1706; (1900) 5701, of whom 237 were foreign-born and 207 were negroes; (1905) 10,287; (1910) 9032. It is served by the Atchison, Topeka & Santa Fé, the Missouri Pacific and the Missouri, Kansas & Texas railways. It is pleasantly situated in a level valley where there is a great abundance of natural gas and some fine building stone. The city has large zinc smelters and zinc rolling-mills, a foundry, machine shops, and manufactories of cement, sulphuric acid and brick. The municipality owns and operates its waterworks, gas plant and electric-lighting plant. Iola was founded in 1859 by a company whose members were dissatisfied with the location of the county-seat at Humboldt. It became the county-seat in 1865, was chartered as a city of the third class in 1870 and became a city of the second class in 1898. The rapid growth of the city dates from the discovery of natural gas here, on Christmas Day 1893.

**IOLITE**, a mineral occasionally cut as a gem-stone, and named from the violet colour which it sometimes presents

(*cov.* "violet"; *λίθος*, "stone"). It is generally called by petrographers cordierite, a name given by R. J. Haüy in honour of the French mineralogist, P. L. Cordier, who discovered its remarkable dichroism, and suggested for it the name dichroite, still sometimes used. The difference of colour which it shows in different directions is so marked as to be well seen without the dichroscope. The typical colours are deep blue, pale blue and yellowish grey. While the crystal as a whole shows these three colours, each face is dichroic.

Iolite is a hydrous magnesium and aluminium silicate, with ferrous iron partially replacing magnesium. It crystallizes in the orthorhombic system. In hardness and specific gravity it much resembles quartz. The transparent blue or violet variety used as a gem occurs as pebbles in the gravels of Ceylon, and bears in many cases a resemblance to sapphire. The paler kinds are often called water-sapphire (*saphir d'eau* of French jewellers) and the darker kinds lynx-sapphire; the shade of colour varying with the direction in which the stone is cut. From sapphire the iolite is readily distinguished by its stronger pleochroism, its lower density (about 2.6) and its inferior hardness (about 7).

Iolite occurs in granite and in true eruptive rocks, but is most characteristically developed as a product of contact metamorphism in gneiss and altered slates. A variety occurring at the contact of clay-slate and granite on the border of the provinces of Shimotsuké and Kōdzuké in Japan has been called cerasite. It readily suffers chemical change, and gives rise to a number of alteration-products, of which pinitite is a characteristic example.

Although iolite, or cordierite, is rather widely distributed as a constituent of certain rocks, fine crystals of the mineral are of very limited occurrence. One of the best-known localities is Bodenmais, in Bavaria, where it occurs with pyrrhotite in a granite matrix. It is found also in Norway, Sweden and Finland, in Saxony and in Switzerland. Large crystals are developed in veins of granite running through gneiss at Haddam, Connecticut; and it is known at many other localities in the United States. (F. W. R.)\*

**ION**, of Chios, Greek poet, lived in the age of Pericles. At an early age he went to Athens, where he made the acquaintance of Aeschylus. He was a great admirer of Cimon and an opponent of Pericles. He subsequently met Sophocles in his native island at the time of the Samian war. From Aristophanes (*Peace*, 830 fl.) it is concluded that he died before the production of that play (421). His first tragedy was produced between 452-449 B.C.; and he was third to Euripides and Iophon in the tragic contest of 429. In a subsequent year he gained both the tragic and dithyrambic prizes, and in honour of his victory gave a jar of Chian wine to every Athenian citizen (Athenaeus p. 3). He is further credited by the scholiast on Aristophanes (*loc. cit.*) with having composed comedies, dithyrambs, epigrams, paeans, hymns, scolia, encomia and elegies; and he is the reputed author of a philosophical treatise on the mystic number three. His historical or biographical works were five in number, and included an account of the antiquities of Chios and of *ἑκτόνημα*, recollections of visitors to the island.

See C. Nieberding, *De Ioniae Chii vita* (1836, containing the fragments); F. Allgeier, *De Ione Chio* (1890), an exhaustive monograph; and Bentley, *Epistola ad Millium*.

**IONA**, or ICOLMILL, an island of the Inner Hebrides, Argyllshire, Scotland, 6½ m. S. of Staffa and 1½ m. W. of the Rose of Mull, from which it is separated by the shallow Sound of Iona. Pop. (1901) 213. It is about 3½ m. long and 1½ m. broad; its area being some 2200 acres, of which about one-third is under cultivation, oats, potatoes and barley being grown. In the rest of the island grassy hollows, yielding pasturage for a few hundred cattle and sheep and some horses, alternate with rocky elevations, which culminate on the northern coast in Duni (332 ft.), from the base of which a dazzling stretch of white shell sand, partly covered with grass, stretches to the sea. To the south-west the island is fringed with precipitous cliffs. Iona is composed entirely of ancient gneisses and schists of Lewisian age; these

include bands of quartzite, slate, marble and serpentine. The strike of the rocks is S.W.-N.E. and they are tilted to very high angles. Fronting the Sound is the village of Iona, or Buile Mor, which has two churches and a school. The inhabitants depend partly on agriculture and partly on fishing.

The original form of the name Iona was Hy, Hii or I, the Irish for Island. By Adamnan in his *Life of St Columba* it is called *Iona insula*, and the present name Iona is said to have originated in some transcriber mistaking the *u* in Iona for *n*. It also received the name of Hii-colum-kill (Icolmkill), that is, "the island of Columba of the Cell," while by the Highlanders it has been known as Innis nan Druidhneah ("the island of the Druids"). This last name seems to imply that Iona was a sacred spot before St Columba landed there in 563 and laid the foundations of his monastery. After this date it quickly developed into the most famous centre of Celtic Christianity, the mother community of numerous monastic houses, whence missionaries were despatched for the conversion of Scotland and northern England, and to which for centuries students flocked from all parts of the north. After St Columba's death the soil of the island was esteemed peculiarly sanctified by the presence of his relics, which rested here until they were removed to Ireland early in the 9th century. Pilgrims came from far and near to die in the island, in order that they might lie in its holy ground; and from all parts of northern Europe the bodies of the illustrious dead were brought here for burial. The fame and wealth of the monastery, however, sometimes attracted less welcome visitors. Several times it was plundered and burnt and the monks massacred by the heathen Norse sea-rovers. Late in the 11th century the desecrated monastery was restored by the saintly Queen Margaret, wife of Malcolm Canmore, king of Scotland; and in 1203 a new monastery and a nunnery were founded by Benedictine monks who either expelled or absorbed the Celtic community. In 838 the Western Isles, then under the rule of the kings of Man, were erected into a bishopric of which Iona was the seat. When in 1008 Magnus III., "Barefoot," king of Norway, ousted the jarls of Orkney from the isles, he united the sea of the Isles (Sudreyar, "the southern islands," Lat. *Sodrenses insulae*) with that of Man, and placed both under the jurisdiction of the archbishopric of Trondhjem. About 1507 the island again became the seat of the bishopric of the Isles; but with the victory of the Protestant party in Scotland its ancient religious glory was finally eclipsed, and in 1561 the monastic buildings were dismantled by order of the Convention of Estates. (For the political fortunes of Iona see HEBRIDES.)

The existing ancient remains include part of the cathedral church of St Mary, of the nunnery of St Mary, St Oran's chapel, and a number of tombs and crosses. The cathedral dates from the 13th century; a great portion of the walls with the tower, about 75 ft. high, are still standing. The choir and nave have been roofed, and the cathedral has in other respects been restored, the ruins having been conveyed in 1869 to a body of trustees by the eighth duke of Argyll. The remains of the conventual buildings still extant, to judge by the portion of a Norman arcade, are of earlier date than the cathedral. The small chapel of St Oran, or Odhrain, was built by Queen Margaret on the supposed site of Columba's cell, and its ruins are the oldest in Iona. Its round-arched western doorway has the characteristic Norman beak-head ornamentation. Of the nunnery only the chancel and nave of the Norman chapel remain, the last prioress, Anna (d. 1543), being buried within its walls. The cemetery, called in Gaelic *Reilig Oiran* ("the burial-place of kings"), is said to contain the remains of forty-eight Scottish, four Irish and eight Danish and Norwegian monarchs, and possesses a large number of monumental stones. At the time of the Reformation it is said to have had 360 crosses, of which most were thrown into the sea by order of the synod of Argyll. Many, however, still remain, the finest being Maclean's cross and St Martin's. Both are still almost perfect, and are richly carved with Runic inscriptions, emblematic devices and fanciful scroll work. Of Columba's monastery, which was built of wood about  $\frac{1}{2}$  m. from the present ruins, nothing remains.

**IONIA**, in ancient geography, the name given to a portion of the W. coast of Asia Minor, adjoining the Aegean Sea and bounded on the E. by Lydia. It consisted of a narrow strip of land near the coast, which together with the adjacent islands was occupied by immigrant Greeks of the Ionic race, and thus distinguished from the interior district, inhabited by the Lydians. According to the universal Greek tradition, the cities of Ionia were founded by emigrants from the other side of the Aegean (see IONIANS), and their settlement was connected with the legendary history of the Ionic race in Attica, by the statement that the colonists were led by Neleus and Androclus, sons of Codrus, the last king of Athens. In accordance with this view the "Ionic migration," as it was called by later chronologers, was dated by them one hundred and forty years after the Trojan war, or sixty years after the return of the Heraclidae into the Peloponnese. Without assigning any definite date, we may say that recent research has tended to support the popular Greek idea that Ionia received its main Greek element rather late—after the descent of the Dorians, and, therefore, after any part of the Aegean period. The only Aegean objects yet found (1010) in or near Ionia are some sherds of the very latest Minoan age at Miletus. It is not probable that all the Greek colonists were of the not numerous Ionian race. Herodotus tells us (i. 146) that they comprised settlers from many different tribes and cities of Greece (a fact indicated also by the local traditions of the cities), and that they intermarried with the native races. A striking proof of this was the fact that so late as the time of the historian distinct dialects were spoken by the inhabitants of different cities within the limits of so restricted an area. E. Curtius supposed that the population of this part of Asia was aboriginally of Ionic race and that the settlers from Greece found the country in the possession of a kindred people. The last contention is probably true; but the kinship was certainly more distant than that between two branches of one Ionian stock.

The cities called Ionian in historical times were twelve in number,—an arrangement copied as it was supposed from the constitution of the Ionian cities in Greece which had originally occupied the territory in the north of the Peloponnese subsequently held by the Achaeans. These were (from south to north)—Miletus, Myus, Priene, Ephesus, Colophon, Lebedus, Teos, Erythrae, Clazomenae and Phocaea, together with Samos and Chios. Smyrna (*q.v.*), originally an Aeolic colony, was afterwards occupied by Ionians from Colophon, and became an Ionian city,—an event which had taken place before the time of Herodotus. But at what period it was admitted as a member of the league we have no information. The cities above enumerated unquestionably formed a kind of league, of which participation in the Pan-Ionic festival was the distinguishing characteristic. This festival took place on the north slope of Mt. Mycale in a shrine called the Panionium. But like the Amphictyonic league in Greece, the Ionic was rather of a sacred than a political character; every city enjoyed absolute autonomy, and, though common interests often united them for a common political object, they never formed a real confederacy like that of the Achaeans or Boeotians. The advice of Thales of Miletus to combine in a political union was rejected.

Ionia was of small extent, not exceeding 90 geographical miles in length from N. to S., with a breadth varying from 20 to 30 m., but to this must be added the peninsula of Mimas, together with the two large islands. So intricate is the coastline that the voyage along its shores was estimated at nearly four times the direct distance. A great part of this area was, moreover, occupied by mountains. Of these the most lofty and striking were Mimas and Corycus, in the peninsula which stands out to the west, facing the island of Chios; Sipylus, to the north of Smyrna; Corax, extending to the south-west from the Gulf of Smyrna, and descending to the sea between Lebedus and Teos; and the strongly marked range of Mycale, a continuation of Messogis in the interior, which forms the bold headland of Trogillum or Mycale, opposite Samos. None of these mountains attains a height of more than 4000 ft. The district

comprised three extremely fertile valleys formed by the outflow of three rivers, among the most considerable in Asia Minor: the Hermus in the north, flowing into the Gulf of Smyrna, though at some distance from the city of that name; the Cayster, which flowed under the walls of Ephesus; and the Maeander, which in ancient times discharged its waters into the deep gulf that once bathed the walls of Miletus, but which has been gradually filled up by this river's deposits. With the advantage of a peculiarly fine climate, for which this part of Asia Minor has been famous in all ages, Ionia enjoyed the reputation in ancient times of being the most fertile of all the rich provinces of Asia Minor; and even in modern times, though very imperfectly cultivated, it produces abundance of fruit of all kinds, and the raisins and figs of Smyrna supply almost all the markets of Europe.

The colonies naturally became prosperous. Miletus especially was at an early period one of the most important commercial cities of Greece; and in its turn became the parent of numerous other colonies, which extended all around the shores of the Euxine and the Propontis from Abydus and Cyzicus to Trapezus and Panticapaeum. Phocaea was one of the first Greek cities whose mariners explored the shores of the western Mediterranean. Ephesus, though it did not send out any colonies of importance, from an early period became a flourishing city and attained to a position corresponding in some measure to that of Smyrna at the present day.

*History.*—The first event in the history of Ionia of which we have any trustworthy account is the inroad of the Cimmerii (see SCYTHIA), who ravaged a great part of Asia Minor, including Lydia, and sacked Magnesia on the Maeander, but were foiled in their attack upon Ephesus. This event may be referred to the middle of the 7th century B.C. About 700 B.C. Gyges, first Mermaid king of Lydia, invaded the territories of Smyrna and Miletus, and is said to have taken Colophon as his son Ardyds did Priene. But it was not till the reign of Croesus (560–545 B.C.) that the cities of Ionia successively fell under Lydian rule. The defeat of Croesus by Cyrus was followed by the conquest of all the Ionian cities. They became subject to the Persian monarchy with the other Greek cities of Asia. In this position they enjoyed a considerable amount of autonomy, but were for the most part subject to local despots, most of whom were creatures of the Persian king. It was at the instigation of one of these despots, Histiaeus (q.v.) of Miletus, that in about 500 B.C. the principal cities broke out in insurrection against Persia. They were at first assisted by the Athenians, with whose aid they penetrated into the interior and burnt Sardis, an event which ultimately led to the Persian invasion of Greece. But the fleet of the Ionians was defeated off the island of Lade, and the destruction of Miletus after a protracted siege was followed by the reconquest of all the Asiatic Greeks, insular as well as continental.

The victories of the Greeks during the great Persian war had the effect of enfranchising their kinsmen on the other side of the Aegean; and the battle of Mycale (479 B.C.), in which the defeat of the Persians was in great measure owing to the Ionians, secured their emancipation. They henceforth became the dependent allies of Athens (see DELIA & LEAGUES) though still retaining their autonomy, which they preserved until the peace of Antalcidas in 387 B.C., once more placed them as well as the other Greek cities in Asia under the nominal dominion of Persia. They appear, however, to have retained a considerable amount of freedom until the invasion of Asia Minor by Alexander the Great. After the battle of the Granicus most of the Ionian cities submitted to the conqueror. Miletus, which alone held out, was reduced after a long siege (334 B.C.). From this time they passed under the dominion of the successive Macedonian rulers of Asia, but continued, with the exception of Miletus (q.v.), to enjoy great prosperity both under these Greek dynasties and after they became part of the Roman province of Asia.

Ionia has laid the world under its debt not only by giving birth to a long roll of distinguished men of letters and science (see IONIAN SCHOOL OF PHILOSOPHY), but by originating the distinct school of art which prepared the way for the brilliant artistic development of Athens in the 5th century. This school flourished in the 8th, 7th and 6th centuries, and is distinguished by the fineness of workmanship and minuteness of detail with which it treated subjects, inspired always to some extent by non-Greek models. Naturalism is progressively obvious in its treatment, e.g. of the human figure, but to the end it is still subservient to convention. It has been thought that the Ionian migration from Greece carried with it some part of a population which retained the artistic traditions of the "Mycenaean"

civilization, and so caused the birth of the Ionic school; but whether this was so or not, it is certain that from the 8th century onwards we find the true spirit of Hellenic art, stimulated by commercial intercourse with eastern civilizations, working out its development chiefly in Ionia and its neighbouring isles. The great names of this school are Theodorus and Rhoecus of Samos; Bathyclus of Magnesia on the Maeander; Glaucus, Melas, Micciades, Archermus, Bupalus and Athenis of Chios. Notable works of the school still extant are the famous archaic female statues found on the Athenian Acropolis in 1855–1887, the seated statues of Branchidae, the Nike of Archermus found at Delos, and the objects in ivory and electrum found by D. G. Hogarth in the lower strata of the Artemision at Ephesus in 1904–1905 (see GREEK ART).

*BIBLIOGRAPHY.*—Beside general authorities under ASIA MINOR see especially F. Beaufort, *Ionian Antiquities* (1811); R. Chandler, &c., *Ionian Antiquities* (1766 ff.); Histories of Greek Sculpture by A. S. Murray, M. Collignon and E. A. Gardner, and special works cited under particular cities; E. Curtius, *Die Ionen vor der ionischen Wanderung* (1855); D. G. Hogarth, *Ionia and the East* (1909), with map. (E. H. B.; D. G. H.)

**IONIA**, a city and the county-seat of Ionia county, Michigan, U.S.A., on the Grand river, about 34 m. E. of Grand Rapids. Pop. (1904) 5222; (1910) 5030. It is served by the Grand Trunk and the Père Marquette railways. The greater part of the city is built on the bottom-lands of the valley within an area 2 m. in length and 1 m. in width, but some of the finest residences stand on the hills, which form an irregular semicircle behind the city, and command extensive views of the valley. Much of the building material is a brown sandstone obtained from quarries only 3 m. distant; white clay, also, is found in the vicinity. The city is a trade centre for a rich farming district, has car-shops (of the Père Marquette railway) and iron foundries, and manufactures wagons, pottery, furniture and clothing. The water-works are owned and operated by the municipality. Ionia was settled in 1835 by immigrants from German Flats, near Herkimer, New York. It was incorporated as a village in 1857, but the charter was allowed to lapse; it was again incorporated as a village in 1865, and was chartered as a city in 1873.

**IONIAN ISLANDS**, the collective name for the Greek islands of Corfu, Cephalonia, Zante, Santa Maura, Ithaca, Cythera (Cerigo) and Paxo, with their minor dependencies. These seven islands (for details of which see their separate headings) are often described also as the *Heptanesus* ("Seven Islands"), but they have no real geographical unity. The history of the name "Ionian" in this connexion is obscure, but it is probably due to ancient settlements of Ionian colonists on the coasts and islands. The political unity of the seven islands is of comparatively modern date; their independence as a separate state lasted only seven years (1800–1807). To a certain extent they have passed under the same succession of influences; they have been subjected to the same invasions, and have received accessions to their populations from the same currents of migration or conquest. But even what may be considered as common experiences have affected the individual islands in different ways; in the matter of population, for instance, Corfu has undergone much more important modifications than Ithaca.

The Ionian islands consist almost entirely of Cretaceous and Tertiary beds, but in Corfu Jurassic deposits belonging to various horizons have also been found. The oldest beds which have yet been recognized are shales and hornstones with Liassic fossils. These are overlaid conformably by a thick series of platy limestones, known as the Viglís limestone, which appears to represent the rest of the Jurassic system and also the lower part of the Cretaceous. Then follows a mass of dolomite and unbedded limestones containing *Hippurites* and evidently of Upper Cretaceous age. The Eocene beds are folded with the Cretaceous, and in many places the two formations have not yet been separately distinguished. Both occasionally assume the form of Flysch. Miocene beds are found in Corfu and Zante, and Pliocene deposits cover much of the low-lying ground.

*History.*—The beginning of Heptanesian history may be said to date from the 9th century. Leo the Philosopher (about A.D. 890) formed all or most of the islands into a distinct province under the title of the Thema of Cephallenia, and in this condition



they belonged to the Eastern empire after Italy had been divided into various states, but this political or administrative unity could not last long in the case of islands exposed by their situation to opposite currents of conquest. Robert Guiscard, having captured Corfu (1081) and Cephalonia, might have become the founder of a Norman dynasty in the islands but for his early death at Cassopo. Amid the struggles between Greek emperors and Western crusaders during the 12th century, Corfu, Cephalonia, Zante, &c., emerge from time to time; but it was not till the Latin empire was established at Constantinople in 1204 that the Venetians, who were destined to give the Ionian Islands their place in history, obtained possession of Corfu. They were afterwards robbed of the island by Leon Vetrano, a famous Genoese corsair; but he was soon defeated and put to death, and the senate, to secure their position, granted fiefs in Corfu to ten noble families in order that they might colonize it (1206). The conquest of Cephalonia and Zante followed, and we find five counts of the family of Tocco holding Cephalonia, and probably Zante as well as Santa Maura, as tributary to the republic. But the footing thus gained by the Venetians was not maintained, and through the closing part of the 13th and most of the 14th century the islands were a prey by turns to corsairs and to Greek and Neapolitan claimants. In 1386, however, the people of Corfu made voluntary submission to the Venetian republic which had now risen to be the first maritime power in the Mediterranean. In 1485 Zante was purchased from the Turks in a very depopulated condition; and in 1499 Cephalonia was captured from the same masters; but Santa Maura, though frequently occupied for a time, was not finally attached to Venice till 1684, and Cerigo was not taken till 1717.

The Venetians, who exacted heavy contributions from the islands, won the adherence of the principal native families by the bestowal of titles and appointments; the Roman Catholic Church was established, and the Italian and Greek races were largely assimilated by intermarriage; Greek ceased to be spoken except by the lower classes, which remained faithful to the Orthodox communion. On the fall of the Venetian republic in 1797 the treaty of Campo Formio, which gave Venice to Austria, annexed the Ionian Islands to France; but a Russo-Turkish force drove out the French at the close of 1798; and in the spring of 1799 Corfu capitulated. By treaty with the Porte in 1800, the emperor Paul erected the "Septinsular Republic," but anarchy and confusion followed till a secret article in the treaty of Tilsit, in 1807, declared the Islands an integral part of the French empire. They were incorporated with the province of Illyria, and in this condition they remained till the decline of the French power. The British forces, under General Oswald, took Zante, Cephalonia and Cerigo in 1809, and Santa Maura in 1810; Colonel (afterwards Sir Richard) Church (*q.v.*), reduced Paxo in 1814; and after the abdication of Napoleon, Corfu, which had been well defended by General Donzelot, was, by order of Louis XVIII., surrendered to Sir James Campbell. By the treaty of Paris (9th November 1815) the contracting powers—Great Britain, Russia, Austria and Prussia—agreed to place the "United States of the Ionian Islands" under the exclusive protection of Great Britain, and to give Austria the right of equal commercial advantage with the protecting country, a plan strongly approved by Count Capo d'Istria, the famous Corfiot noble who afterwards became president of the new republic of Greece.

The terms of the treaty of Paris were not only of indefinite import but were susceptible of contradictory interpretations. And instead of interpreting the other articles in harmony with the first, which declared the islands one "sole free and independent state," the protecting Power availed itself of every ambiguity to extend its authority.

The first lord high commissioner, Sir Thomas Maitland, who as governor of Malta had acquired the sobriquet of "King Tom," was not the man to foster the constitutional liberty of an infant state. The treaty required, with questionable wisdom, that a constitution should be established, and this was accordingly

done; but its practical value was trifling. The constitution, voted by a constituent assembly in 1817 and applied in the following year, placed the administration in the hands of a senate of six members and a legislative assembly of forty members; but the real authority was vested in the high commissioner, who was able directly to prevent anything, and indirectly to effect almost anything. Sir Thomas Maitland was not slow to exercise the control thus permitted him, though on the whole he did so for the benefit of the islands. The construction of roads, the abolition of direct taxes and of the system of farming the church lands, the securing of impartial administration of justice, and the establishment of educational institutions are among the services ascribed to his efforts. These, however, made less impression on the Heptanesians than his despotic character and the measures which he took to prevent them giving assistance in the Greek war of independence in 1821. He was succeeded in 1823 by General Sir Frederick Adam, who in the main carried out the same policy. Under his government the new fortifications of Corfu and some of the most important public works which still do honour to the English protectorate were undertaken. Lord Nugent, who became high commissioner in 1832, was followed by Sir Howard Douglas (1835-1841), who ruled with a firm, too often with a high hand; and he was met by continual intrigues, the principal exponent of the opposition being the famous Andreas Mustoxidi (d. 1861). A complete change of policy was inaugurated by Mr Mackenzie (1841-1843), and his successor Lord Seaton (1843-1849) was induced by the European disturbances of 1848 to initiate a number of important reforms. But the party which wished for union with Greece was rapidly growing in vigour and voice. Serious insurrections of the peasantry, especially in Cephalonia, had to be put down by military force, and the parliament passed a resolution in favour of immediate union with Greece. The hopes of the unionists were roused by the appointment of W. E. Gladstone as high commissioner extraordinary to investigate the condition of the islands. From his known sympathy with Greek independence, it was their expectation that he would support their pretensions. But after a tour through the principal islands Gladstone came to the conclusion that the abolition of the protectorate was not the wish of the mass of the people. For a few days in 1859 he held office as lord high commissioner, and in that capacity he proposed for the consideration of the assembly a series of reforms. These reforms were, however, declared inadmissible by the assembly; and Sir Henry Storks, who succeeded Gladstone in February 1859, began his rule by a prorogation. The contest continued between the assembly and the protectorate. The British government was slow to realize the true position of affairs: as late as May 1861 Gladstone spoke of the cession of the islands as "a crime against the safety of Europe," and Sir Henry Storks continued to report of tranquillity and contentment. The assembly of 1862 accused the high commissioner of violation of the constitution and of the treaty of Paris, and complained that England remained in ignorance of what took place in the islands.

On the abdication of King Otho of Greece in 1862 the Greek people by universal suffrage voted Prince Alfred of England to the throne, and when he declined to accept the crown England was asked to name a successor. The candidate proposed was Prince William George of Glücksburg, brother of the princess of Wales; and the British government declared to the provisional government of Greece that his selection would be followed by the long-refused cession of the Ionian Islands. After the prince's election by the national assembly in 1863 the high commissioner laid before the Ionian parliament the conditions on which the cession would be carried out. The rejection of one of those conditions—the demolition of the fortifications of Corfu—led to a new prorogation; but none the less (on March 20, 1864) the plenipotentiaries of the five great powers signed the treaty by which the protectorate was brought to a close. The neutrality which they attributed to the whole of the islands was (January 1864) confined to Corfu and Paxo. On May 31st of that year Sir Henry Storks left Corfu with

*Venetian and French rule.*

*Cession to Greece.*

*British Protectorate*

the English troops and men-of-war. King George made his entry into Corfu on the 6th of June.

Since their annexation to Greece the history of the Ionian islands has been uneventful; owing to various causes their prosperity has somewhat declined. Corfu (Corycra) with Paxos; Cephalonia; Santa Maura (Levkas) with Thiaki (Ithaca) and Zante (Zacynthos) each form separate nomarchies or departments; Cerigo (Cýthera) forms part of the nomarchy of Laconia. The islands retain the exemption from direct taxation which they enjoyed under the British protectorate; in lieu of this there is an *ad valorem* tax of 20% on exported oil and a tax of 6% on wine exported to Greek ports; these commodities are further liable to an export duty of 12% which is levied on all agricultural produce and articles of local manufacture for the maintenance and construction of roads. The excellent roads, which date from the British administration, are kept in fair repair.

See Mustoxidi, *Delle isole Corciresi* (Corfu, 1848). Lunzi, *Isoli rîs podlîasîs katastasîs rîs 'Ekrasîs* (Athens, 1856); Ansted, *The I. I.* (London 1863); Viscount Kirkwall, *Four Years in the I. I.* (London, 1864) vol. i. containing a chronological history of the British protectorate; F. Lenormant, *La Grèce et les îles ioniennes* (Paris, 1865); P. Chiotis, *Hist. des îles ioniennes* (Zante, 1815-1864); Mardo, *Saggio di una descrizione geografico-storica delle Isole* (Corfu, 1865) (mainly geographical); De Bosset, *Description des monnaies d'Ithaque et de Céphalonie* (London, 1815); Postolakas, *Karâdlogos tîn ôxalîon nomarchîôn tîn rîsôn Kîkiras, Aivalîas, &c.* (Athens, 1868); Wiebel, *Die Insel Cephalonia und die Meerwûndel von Argosoli* (Hamburg, 1873); Tsietselis, *Πρωτογενής Κεφαλονίας*, (Athens, 1876); *Omîgata thîsion to Kεφαλονίη* in the "Parnassus" i. 9-12 (Athens, 1877); Riemann, "Recherches archéologiques sur les îles ioniennes" in *Bibliothèque des Écoles françaises d'Athènes et de Rome* (Paris, 1879-1880); Gregorovius, *Corfu: eine ionische Idylle* (Leipzig 1882); J. Patsch, *Die Insel Corfu: eine geographische Monographie* (Gotha, 1887); *Die Insel Levkas* (Gotha, 1889); *Kephalonia und Ithaka* (Gotha, 1890); *Die Insel Zante* (Gotha, 1891). (J. D. B.)

**IONIANS**, the name given by the Greeks to one of the principal divisions of the Hellenic peoples. In historic times it was applied to the inhabitants of (1) Attica, where some believed the Ionians to have originated; (2) parts of Euboea; (3) the Cycladic islands, except Melos and Thera; (4) a section of the west coast of Asia Minor, from the gulf of Smyrna to that of Iasus (see IONIA); (5) colonies from any of the foregoing, notably in Thrace, Propontis and Pontus in the west, and in Egypt (Naucratis, Daphnae); some authorities have found traces of an ancient Ionian population in (6) north-eastern Peloponnese. The meaning and derivation of the name are not known. It occurs in two forms, *Ἴάῳνες* and *Ἴώνες* (compare *Χάονες* and *Χάωνες* in Epirus)—not counting the name *Ἴωνος* applied to the open sea west of Greece. In the traditional genealogy of the Hellenes, Ion, the ancestor of the Ionians, is brother of Achæus and son of Xuthus (who held Peloponnese after the dispersal of the children of Hellen). But this genealogy, though it is attributed to Hesiod, is apparently post-Homeric; and it is clear that the Ionian name had independent and varied uses and meanings in very early times. In Homer the word *Ἴάῳνες* occurs as a name of inhabitants of Attica, with the epithet *ἄλλεχίτωνες* (II. xiii. 685—"trail-vest"), describing some point of costume, and later regarded as imputing effeminacy. The Homeric *Hymn to Apollo of Delos* (7th century) describes an Ionian population in the Cyclades with a loose religious league about the Delian sanctuary.

The same word *Ἴάῳν* (*Javan*) appears in Hebrew literature of the 8th and 7th centuries, to denote one group of the "Japhetic" peoples of Asia Minor, Cyprus and perhaps Rhodes: "by these were the isles of the nations divided, in their lands, every one after his tongue, after their families, in their nations," a comprehensive expression for the island-strewn regions farther west (Gen. x. 10). In Ezek. xvii. 13, 19, *Javan* trades with Tyre in slaves, bronze-work, iron and drugs. Later allusions show that on Semitic lips *Javan* meant western traders in general. In Persian *Yavana* was the generic term for Greeks.

<sup>1</sup> *Yavan* is still a popular synonym for *Oroum*, a Greek, among the Arabs; in India *Yavana* was long the generic name for all foreigners from the north and west, a use dating probably from Alexander's day and the Græco-Bactrian monarchs.

The earliest explicit Greek account of the Ionians is given in the 5th century by Herodotus (i. 45, 56, 143-145, v. 66, vii. 94, viii. 44-46). The "children of Ion" originated in north-eastern Peloponnese; and traces of them remained in Troezen and Cynuria. Expelled by the Achæans (who seem to have entered Peloponnese about four generations before the Dorian Invasion) they invaded and dominated Attica; and about the time of the Dorian Invasion took the lead under the Attic branch of the Neleids of Pylus (Hdt. i. 147, v. 65) in the colonization of the Cyclades and of Asiatic Ionian, which in Homer is still "Carian." Many of the colonists, however, were not Ionians, but refugees from other parts of Greece, between Euboea and Aegolis (Hdt. i. 146), others looked on Attica as their first home, though the true Ionians were intruders there. The Pan-Ionian sanctuary of Poseidon on the Asiatic promontory of Mycale was regarded as perpetuating a cult from Peloponnesian Achæa, and the league of twelve cities which maintained it, as imitated from an Achæan dodecapolis, and as claiming (absurdly, according to Herodotus i. 143) 39 per cent than other Ionians.

In Herodotus's account of the first Greek intercourse with Egypt (about 664 B.C.) he describes "Ionian and Carian" adventurers and mercenaries in the Delta. Later the commoner antithesis is between Ionian and Dorian, first (probably) in the colonial regions of Asia Minor, and later more universally.

In the 5th century the name "Ionian" was already falling into discredit. Causes of this were (1) the peace-loving luxury (born of commercial wealth and contact with Oriental life) of the great Ionian cities of Asia; (2) the tameness with which they submitted first to Lydia and then to Persia, then to Athenian pretensions, then to Sparta, and finally to Persia again; (3) the decadence and downfall of Athens, which still counted as Ionian and had claimed (since Solon's time) seniority among "Ionian" states. In the later 4th century the name survives only (a) as a geographical expression for part of the coast of Asia Minor, (b) in European Greece as the name of that section of the Northern Amphictyony in which Athens and its colonies were reckoned.

The traditional history of Asiatic Ionian is generally accepted, and in its broad outlines is probably well founded. Common to all groups of Ionians in the Aegean is a dialect of Greek which has η for α (in Attic only partially) and (in Asiatic Ionian especially) κ for π in certain words. Herodotus states that there were four distinct dialects in Asiatic Ionian itself (i. 142) and the dialect of Attica differed widely from all other forms of Ionic. Earlier phases of Ionic forms are dominant in the language of Homer. Most Ionian states exhibit also traces of the fourfold tribal divisions named after the "children of Ion"; but additional tribes occur locally. (Hdt. v. 66, 69.) All reputed colonies from Attica (except Ephesus and Colophon) kept also the feast of Apaturia; and many worshipped Apollo Patrosus as the reputed father of Ion. The few observations hitherto made on the sites of Ionian cities indicate continuity of settlement and culture as far back as the latest phases of the Mycænaean (Late Minoan III.) Age and not farther, supporting thus far the traditional foundation dates.

The theory of E. Curtius (1856-1890) that the Ionians originated in Asia Minor and spread thence through the Cyclades to Euboea and Attica deserts ancient tradition on linguistic and ethnological grounds of doubtful value. Ad. Holm supports it (*Gesch. Gr.*, Berlin, 1886, i. 86), but A. von Gutschmid (*Beitr. z. Gesch. d. alten Orientalen*, Leipzig, 1856, 124 ff.) and E. Meyer (*Philologus* NF. 2, 1880, p. 268 ff.; NF. 3, 1890, p. 479 ff.) follow Herodotus with qualifications. J. B. Bury (*Eng. Hist. Rev.* xv. 228), though he regards the Ionian peoples as of European origin, thinks that they may have got their name from some part of the Asiatic coast. Ionian culture and art, though little known in their earlier phases, derive their inspiration on the one side from those of the old Aegean (Minoan) civilization, on the other from the Oriental (mainly Assyrian) models which penetrated to the coast through the Hittite civilization of Asia Minor. Egyptian influence is almost absent until the time of Psammetichus, but then becomes predominant for a while. Local and

regional peculiarities, however, disappear almost wholly in the 5th and 4th centuries, under the overpowering influence of Athens.

**AUTHORITIES.**—Besides the sections on *Ionians* in the general histories of Greece and the references given in G. Busolt, *Griechische Geschichte*, I. (2nd ed., Gotha, 1893), pp. 262, 277 ff., see E. Curtius, *Die Ionen vor der ionischen Wanderung* (Berlin, 1855), and papers in *Gott. Gel. Anz.* (1856), p. 1152 f. and (1859), p. 2021 f.; *Jahrb. f. kl. Philol.* 83 (1860), p. 449 f.; *Hermes* 25 (1860), p. 141 ff.; von Gutschmid, *Beiträge z. Gesch. d. alten Orients* (Leipzig, 1856), p. 124 ff.; E. Meyer, *Philologus* 47 (NF, 2, 1889), p. 268 ff. and 49 (NF, 3, 1890), p. 479 ff.; V. Boeckh, *Aus ionischen und aelischen Necropolen* (Cassel, 1897); H. W. Smyth, *The Ionic Dialect* (1889). P. Cauer, "De dialecto attica vetustiore quaestiones epigraphicae," in G. Curtius, *Studien z. gr. u. lat. Gramm.* 8 (1875), p. 223, 399; Karsten, *De titulorum Ionicorum dialecto* (Halle, 1882); F. Bechtel, *Die Inschriften des ion. Dialekts* (Göttingen, 1877). For the political history of the Ionian Greeks see GREECE: *Historical*, and IONIA; for the special history and characteristics of individual Ionian cities, the respective names. (J. L. M.)

**IONIAN SCHOOL OF PHILOSOPHY.** Under this name are included a number of philosophers of the 6th and 5th centuries B.C. Mainly Ionians by birth, they are united by a local tie and represent all that was best in the early Ionian intellect. It is a most interesting fact in the history of Greek thought that its birth took place not in Greece but in the colonies on the Eastern shores of the Aegean Sea. But not only geographically do these philosophers form a school; they are one in method and aim. They all sought to explain the material universe as given in sensible perception; their explanation was in terms of matter, movement, force. In this they differed from the Eleatics and the Pythagoreans who thought in the abstract, and explained knowledge and existence in metaphysical terminology. In tracing the development of their ideas, two periods may be distinguished. The earliest thinkers down to Heraclitus endeavoured to find a material substance of which all things consist; Heraclitus, by his principle of universal flux, took a new line and explained everything in terms of force, movement, dynamic energy. The former asked the question, "What is the substratum of the things we see?"; the latter, "How did the sensible world become what it is; of what nature was the motive force?"

The first name in the list of the Ionian philosophers—and, indeed, in the history of European thought—is that of Thales (q.v.). He first, so far as we know, sought to go behind the infinite multiplicity of phenomena in the hope of finding an infinite unity from which all difference has been evolved. This unity he decided is Water (*ἄρα ὕδωρ ἄριστον*). It is impossible to discover precisely what he conceived to be the relation of this unity to the plurality of phenomena. Later writers from whom we derive our knowledge of Thales attributed to him ideas which seem to have been conceived by him and fire. Thus the suggestion preserved by Stobaeus that he conceived water to be endowed with mind is discredited by the specific statement of Aristotle that the earlier physicists (*physiologi*) did not distinguish the material from the moving cause, and that before Anaxagoras one postulated creative intelligence. Again in the *De anima* (i. 5) Aristotle quotes the statement that Thales attributed to water a divine intelligence, and criticizes it as an inference from later speculations. It is probably safest to credit Thales with the bare mechanical conception of a universal material cause, leaving pantheistic ideas to a later period of thought.

The successors of Thales were Anaximander and Anaximenes, who also sought for a primal substance of things. Anaximander postulated a corporeal substance intermediate between air and fire on the one hand, and between earth and water on the other hand. This substance he called "the Infinite" (*ἄπειρον*). Unlike Thales, he was struck by the infinite variety in things; he felt that all differences are finite, that they have emerged from primal unity (first called *ἄρχη* by him) into which they must ultimately return, that the Infinite One has been, is, and always will be, the same, indeterminate but immutable. Change, growth and decay he explained on the principle of mechanical compensation (*ἰσοδυναμία γὰρ ἀπὸ τῆς αἰτίας καὶ τῆς ἀδικίας*).

Anaximenes, pupil of Anaximander, seems to have rebelled against the extreme materialism of his master. Perceiving that air is necessary to life, that the universe is surrounded by air, he was convinced that out of air all things have resulted. The process by which things grow is twofold, condensation (*πύκνωσις*) and rarefaction (*ἀραιώσεις*), or, in other words, *heat* and *cold*. From the former process result cloud, water and stone; from the latter, fire and aether. This theory is closely allied to that of Thales, but it is superior in that it specifies the processes of change. Further, it is difficult not to accept Cicero's statement that Anaximenes made air a conscious

deity; we are, at all events, justified in regarding Anaximenes as a link (perhaps an unconscious link) between crude Hylozoism (q.v.) and definitely metaphysical theories of existence.

We have seen that Thales recognized change, but attempted no explanation; that Anaximander spoke of change in two directions; that Anaximenes called these two directions by specific names. From this last, the transition to the doctrine of Heraclitus is easy. He felt that change is the essential fact of experience and pointed out that any merely physical explanation of plurality is inherently impossible. The Many is of Sense; Unity is of Thought. Being is intelligible only in terms of Becoming. That which is, is what it is in virtue of its perpetually changing relations (*πάντα ἐκ τῶν ὄντων γίνεσθαι*). By this recognition of the necessary correlation of Being and Not-being, Heraclitus is in a very real sense the father of our physical and scientific speculation, and in him the Ionian school of philosophy reached its highest point. Yet there is reason to doubt the view of Hegel and Lassalle that Heraclitus recognized the fundamental distinction of subject and object and the relations of mind and matter. Like the early Ionians he postulated a primary substance, fire, out of which all things have emerged and into which all must return. This elemental fire is in itself a divine rational process, the harmony of which constitutes the law of the universe. Human knowledge consists in the comprehension of this all-pervading harmony as embodied in the manifold of perception; the senses are "bad witnesses" in that they report mere appearances as fixed and existent in itself rather than in its relation to the One. The Many gives birth to a sort of ethical by-product whose dominant note is Harmony, the subordination of the individual to the universal reason; moral failure is proportionate to the degree in which the individual declines to recognize his personal transience in relation to the eternal Unity. From the same principle there follows the doctrine of Immortality. The individual, like the phenomena of sense, comes out of the infinite and again is merged; hence on the one hand he is never a separate entity at all, while on the other hand he exists in the infinite and must continue to exist. Moreover, the soul approaches most nearly to perfection when it is least differentiated from elemental fire; it follows that "while we live our souls are dead within us, but when we die our souls are restored to life." This doctrine is at once the assertion and the denial of the self, and furnishes a striking parallel between European thought in its earliest stages and the fundamental principles of Buddhism. Knowledge of the self is one with knowledge of the Universal Logos (Reason); such knowledge is the basis not only of conduct but of existence itself in its only real sense.

Thus far the Ionian philosophers had held the field of thought. Each succeeding thinker had more or less assumed the methods of Thales and had approached the problem of existence from the empirical side. After the time of Heraclitus, however, there sprang up a totally new philosophical movement. Parmenides and Zeno (see Eleatic School) enunciated the principle that "Nothing is born of nothing." Hence the problem becomes a dialectical a priori speculation wherein the laws of thought transcend the sense-given data of experience. It was therefore left for the later Ionians to frame an eclectic system, a synthesis of Being and Not-being, a correlation of universal mobility and absolute permanence. This examination of diametrically opposed tendencies resulted in several different theories. It will be sufficient here to deal with Anaxagoras, Diogenes of Apollonia, Archelaus and Hippo, leaving Empedocles, Leucippus and Democritus to special articles (q.v.). The latter three do not belong strictly to the Ionian school.

Anaxagoras (q.v.) elaborated a quasi-dualistic theory according to which all things have existed from the beginning. Originally they existed in infinitesimal fragments, infinite in number and devoid of arrangement. Amongst these fragments were the seeds of all things which have since emerged by the process of aggregation and segregation, wherein homogeneous fragments came together. These processes are the work of *Nous* (*νοῦς*) which governs and arranges. But this *Nous*, or Mind, is not incorporeal; it is the thinnest of all things; its action on the particle is conceived materially. It originated a rotatory movement, which arising in one point gradually extended till the whole was in motion, which motion continues and will continue indefinitely. By this motion things are gradually constructed not entirely homogeneously particles (the *homomerē*, *ὁμομορφεῖς*) but in each thing with a majority of a certain kind of particle, which is this aggregation which we describe variously as birth, death, maturity, decay, and of which the senses give inaccurate reports. His vague dualism works a very distinct advance upon the crude hylozoism of the early Ionians (see *ATOM*), and the criticisms of Plato and Aristotle show how highly his work was esteemed. The great danger is that we should credit him with more than he actually thought. His *Nous* was not a spiritual force; it was no omnipotent deity; it is not a pantheistic world-soul. But by isolating Reason from all other growths, by representing it as the motor-energy of the Cosmos, in popularizing a term which suggested personality and will, in popularizing an immortality which was the basis of Aristotelian philosophy in Greece and in Europe at large.

In Diogenes of Apollonia we find a return to Anaximenes. Diogenes (q.v.) began by insisting on the necessity of there being only one principle of things, herein contradicting the pluralism of Heraclitus. This principle is that of the universal homogeneity of nature; all

things are at bottom the same, or interaction would be impossible ( $\kappa\alpha\tau\alpha$  τὰ ἑνὸν ἀπὸ τοῦ αὐτοῦ ἐπιπροσβαίνει καὶ τὸ ἀπὸ ἑαυτοῦ. This universal substance is Air. But Diogenes went much farther than Anaximenes by attributing to air not only infinity and eternity but also intelligence. This Intelligence alone would have produced the orderly arrangement which we observe in Nature, and is the basis of human thought by the physical process of inhalation.

Another pupil of Anaxagoras was Archelaus of Miletus (q.v.). His work was mainly the combination of previous views, except that he is said to have introduced an ethical side into the Ionian philosophy. "Justice and injustice," he said, "are not natural but legal." He endeavored to overcome the dualism of Anaxagoras, and in so doing approached more nearly to the older Ionians.

The last of the Ionians whom we need mention is Hippo (q.v.), who, like Archelaus, is intellectually amongst the earlier members of the school. He thought that the source of all things was moisture ( $\rho\upsilon\theta\omicron\varsigma$ ), and is by Aristotle coupled with Thales (*Metaphysics*, A 3).

**BIBLIOGRAPHY.**—Ritter and Preller, ch. i.; Zeller's *History of Greek Philosophy*; J. Burnet, *Early Greek Philosophy* (1892); Fairbanks, *The First Philosophers of Greece* (1898); Grote, *History of Greece*, ch. viii.; Windelband, *History of Ancient Philosophy* (1899); Benn, *The Greek Philosophers* (1883) and *The Philosophy of Greece* (1898); Th. Gomperz, *Greek Thinkers* (Eng. trans. vol. i., L. Magnus, 1901).

**IOPHON**, Greek tragic poet, son of Sophocles. He gained the second prize in 428 B.C., Euripides being first, and Ion third. He must have been living in 405, the date of the production of the *Frogs* of Aristophanes, in which he is spoken of as the only good Athenian tragic poet, although it is hinted that he owed much to his father's assistance. He wrote 50 plays, of which only a few fragments remain. It is said that Iophon accused his father before the court of the phrateres of being incapable of managing his affairs, to which Sophocles replied by reading the famous chorus of the *Oedipus at Colonus* (688 fl.), with the result that he was triumphantly acquitted.

See Aristophanes, *Frogs*, 73, 78, with scholia; Cicero, *De senectute*, vii. 22; Plutarch, *Moralia*, 785 B; A. Nauck, *Tragicorum Graecorum Fragmenta* (1889); O. Wolff, *De Tophonte poeta* (Leipzig, 1843).

**I.O.U.** ("I owe you"), a written acknowledgment of a debt. It usually runs thus:

To—, I.O.U. — pounds.  
(Signed) —. Date—.

An I.O.U., if worded as above, or even if the words "for value received" are added, does not acquire a stamp, as it contains no terms of agreement. If any such words as "to be paid on such a day" are added, it requires a stamp. An I.O.U. should be addressed to the creditor by name, though its validity is not impaired by such omission. Being a distinct admission of a sum due, it is prima facie evidence of an account stated, but where it is the only item of evidence of account it may be rebutted by showing there was no debt and no demand which could be enforced by virtue of it. An I.O.U. is not negotiable.

**IOVILAE**, or JOVILAE, a latinized form of *iōvilās*, the name given by the Oscan-speaking Campanians in the 5th, 4th and 3rd centuries B.C. to an interesting class of monuments, not yet fully understood. They all bear crests or heraldic emblems proper to some family or group of families, and inscriptions directing the annual performance of certain ceremonies on fixed days. While some of them are dedicated to Jupiter (in a special capacity, which our present knowledge of Oscan is insufficient to determine), others were certainly found attached to graves.

See the articles OSCA LINGUA, CAPUA, CUMAE and MESSAPII. The text of all those yet discovered (at Capua and Cumae), with particulars of similar usages elsewhere in Italy and other historical and archaeological detail, is given by R. S. Conway in *The Italic Dialects* (Cambridge, 1897, pp. 101 ff.). A briefer but valuable discussion of the chief characteristics of the group will be found in R. von Planta's *Oskisch-umbrische Grammatik*, ii. 631 ff., and a summary description in C. D. Buck's *Oscio-Umbrian Grammar*, 247.

**IOWA**, a north central state of the United States, situated between latitudes 40° 36' and 43° 30' N. and between longitudes 86° 5' and 96° 31' W. It is bounded N. by Minnesota, E. by the Mississippi river, which separates it from Wisconsin and Illinois, S. by Missouri, and W. by the Missouri and Big Sioux rivers,

which separate it from Nebraska and South Dakota. Its total area is 56,147 sq. m., of which 561 sq. m. are water surface.

**Physical Features.**—Topographically, Iowa lies wholly in the Prairie Plains Region, part of it having been overrun by the Great Ice Sheet of the Glacial epoch. For the most part the surface is that of a prairie tableland, moderately rolling, and with a general but scarcely perceptible slope, which in the eastern two-thirds is from N.W. to S.E., and in the western third from N.E. to S.W. Elevations above the sea range from between 1200 to 1675 ft. in the N.W. to 500 ft. and less in the S.E., the highest point being in the vicinity of Spirit lake in Dickinson county, the lowest at Keokuk. In the southern half of the state the height of the crests of the divides is very uniform. The northern half is more broken and irregular; elevations, usually rounded, mingle with depressions some of which are occupied by small shallow lakes or ponds, the characteristic physical features of this region being due to glaciation. But the most marked departures from the prairie surface are in the N.E. and S.W. In the N.E. the whole of Allamakee and parts of Winneshiek, Fayette, Clayton, Delaware, Dubuque and Jackson counties form the only non-flat area of the state; in that section cliffs frequently rise almost vertically from the banks of the river to a height of from 400 to 400 ft., and from the summit of the cliff to the crest of the divide, a few miles distant, there is another ascent of 300 ft. or more terminating occasionally in knob-topped hills crowned in many instances with small cedar. Moreover, the largest streams have numerous tributaries, and nearly all alike flow circuitously through steep if not vertical cliffs or in deep craggy ravines overlooked by distant hills, among which the wagon road has wound its way with difficulty. In the W., S. from the mouth of the Big Sioux river, extends a line of mound-like bluffs usually free from rocks, but rising abruptly from the flood plain of the Missouri to a height varying from 100 to 300 ft. A broad water-parting extending from Spirit lake, on the northern border, nearly S. to within 60 m. of the southern border, and thence S.E. to Wayne county in the south central part of Iowa, divides the state into two drainage systems. That to the E., comprising about two-thirds of the whole area, is drained by tributaries of the Mississippi, of which the Des Moines, the Skunk, the Iowa with its tributary the Cedar, and the Wapsipinicon are the largest, streams of long courses and easy fall over beds frequently pebbly in the N. but muddy in the S., and through valleys broad at their sources, well drained, and gently sloping in the middle of their courses, but becoming narrower and deeper towards their mouths; that to the W. is drained by tributaries of the Missouri, mostly short streams taking their rise from numerous rivulets, flowing quite rapidly along muddy beds through much of their courses, and in the bluff belt along the Missouri having steep but grassy banks 200 ft. in height or more. (For geological details, see UNITED STATES, section *Geology*, ad fin.)

**Flora and Fauna.**—The predominant feature of the flora is the grasses of the prairie. The former forests of the state were of two general classes: on the bottom lands along the rivers grew cottonwood, willow, honey-locust, coffee trees, black ash, and elm; on the less heavily wooded uplands were oak (white, red, yellow and bur), hickory (bitternut and pignut), white and green ash, butternut, ironwood and hackberry. The growth was heavier, however, in the E. than in the W., but, it has been estimated, covered in all about one-fifth of the area of the state at the time of its first settlement by the whites. In the N.E., also, small cedar and pine are found. But everywhere now most of the merchantable timber has been cut; in 1900 it was estimated that there were altogether about 7000 sq. m. of woodland in the state. The bison and elk long ago disappeared; black bear and deer were long found in unsettled parts of the state. Ducks, geese and other water birds are common, especially during their migrations.

**Climate.**—The climate is one of great extremes of heat and cold, with a dry winter and a usually wet summer, the prevailing wind of winter being N.W., while in summer it not infrequently blows from the S.W. Both the midwinter isotherm of Montreal and the midsummer one of Washington, D.C., pass through the state. The mean annual temperature is 47.5° F.; the average range of extremes per year during the decade ending with 1900 was 136° F., while the greatest extremes recorded are from -43° F. in 1888 to 113° F. in 1901, a difference of 156° F. From 1893 to 1898 the average mean annual temperature at Cresco in Howard county, near the N.E. corner of the state, was 44.3° F., while at Keokuk in the S.E. corner it was 52.2° F., and as the isotherms cross the state, especially in the N., their tendency is to move S.W. The rainfall is also very unequal in distribution throughout the year, as also between the same periods of different years, and as between the different parts of the state. For while the mean annual precipitation is 31.42 in., 22.48 in., or 71 % of this, falling during the six months from the 1st of May to the 1st of October, or 70 % in winter, it amounts to 28 % in spring and 30 % in summer. In June and July being the two wettest months. At the same time extremes during the four most critical crop months, from the 1st of May to the 1st of September, have ranged from 6-75 in. in 1894 to 27.8 in. in 1902. Within any one year the precipitation is in general usually less in the western part of the state than in the eastern, the mean difference for all the years of record up to the close of 1903 being 2.5 in.; the western part also is marked by having a

# IOWA

Scale 1:2,000,000  
English Miles

County Seats  
County Boundaries  
Railways

WISCONSIN

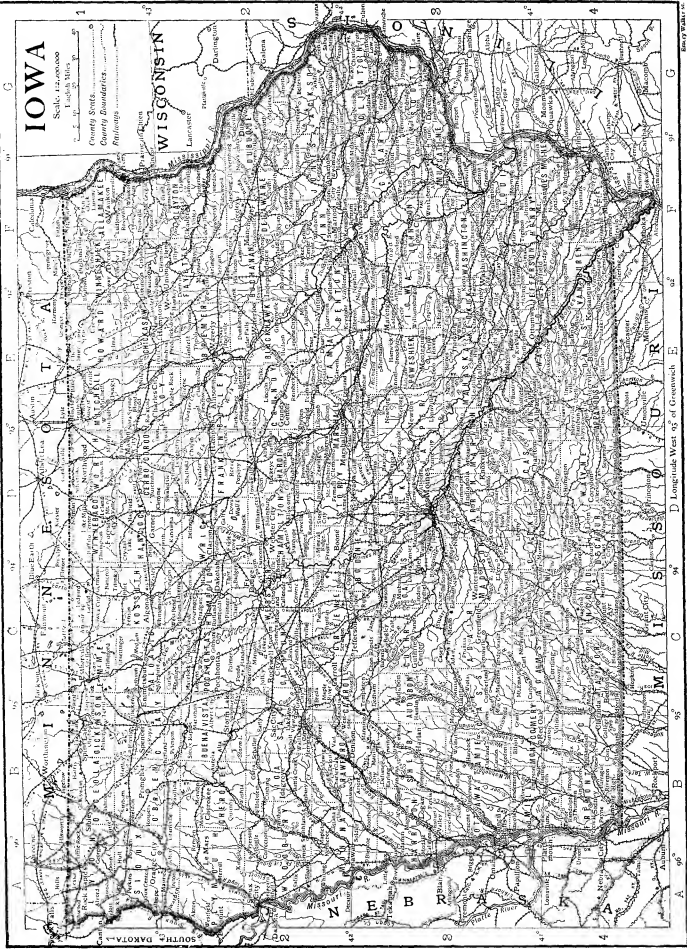

A 96° 00' 00" B 96° 00' 00" C 96° 00' 00" D Longitude West of Greenwich E 96° 00' 00" F 96° 00' 00" G 96° 00' 00"

1 2 3 4 5 6 7 8 9 10 11 12 13 14 15 16 17 18 19 20 21 22 23 24 25 26 27 28 29 30 31 32 33 34 35 36 37 38 39 40 41 42 43 44 45 46 47 48 49 50 51 52 53 54 55 56 57 58 59 60 61 62 63 64 65 66 67 68 69 70 71 72 73 74 75 76 77 78 79 80 81 82 83 84 85 86 87 88 89 90 91 92 93 94 95 96 97 98 99 100

will larger per cent of its rain in spring and summer than has the eastern. The unequal distribution throughout the state is in much larger measure due to local showers. Injury to crops from drought and hot winds has occurred about two or three times in a decade, but liability to injury of the crops from excessive rainfall and hailstorms is greater than that from a deficiency of moisture. Three notable tornadoes have swept portions of the state; the Comanche in June 1860, the Ordway in June 1882 and the Pomeroy in July 1893; but the greatest area traversed by any of these was less than one-twentieth of 1% of the total area of the state, and this kind of storm has been less destructive to human life, animals and buildings than the lightning which accompanies summer showers.

**Soil, Agriculture.**—Its depth, together with its porous nature, makes the fertile soil of Iowa capable of withstanding the extremes of wet and dry remarkably well, and it is perhaps true that, taken as a whole, no other state in the Union is so superior a soil for agriculture. Certainly no other state has so many acres of improved land, or so large a proportion—from 85 to 90%—of its land subject to cultivation. The soil is of four kinds: till or drift, alluvial, loess or bluff and geest. The dark drift, composed chiefly of clay, sand, gravel, boulders and lime, is both the soil and subsoil of the greater part (about 66%) of the state, being especially predominant in the N. and N.W. The alluvial soil, composed of what has been washed from other soils, together with decayed vegetable matter, covers about 6% of the surface of the state, and is found in the river bottoms, of greatest extent in that of the Missouri; it varies much in fertility. The loess soil, chiefly a mixture of porous clay and carbonate of lime, forms the bluffs bordering the bottom lands of the Missouri and is common in the N.E. Its fertility is not inferior to that of the better drift. Geest is found particularly in the north-eastern part of the state; it covers less than 1% of the area of the state.

The superior qualities of the soil, together with the usually warm and moist months of spring and summer, make Iowa one of the foremost states of the Union in agriculture and stock-raising, especially in the production of Indian corn, oats, hay and eggs, and in the raising of hogs, horses, dairy cows and poultry. In comparison with its other industries it stands also pre-eminently as an agricultural state; for of its 789,044 labourers in 1900, 371,604, or 47%, were engaged in agriculture, 129,006 being engaged in trade and transportation, and 124,803 in manufactures and mechanical pursuits. In 1899 the total value of the agricultural products, \$365,411,528, was greater than that of any other state. The farms of Iowa were cultivated by owners in 1900, a decrease from 76.2% in 1880; and 19.5% were cultivated by cash tenants, an increase from 4.5% in 1880. After 1880 the percentage of farms operated by share tenants slowly but steadily decreased, falling from 19.4% in 1880 to 15.4% in 1900. Between 1880 and 1900 the average number of acres to a farm slightly increased—from 133.5 acres in 1880 to 151.2 acres in 1900—instead of decreasing as in the older states of the Union; though the increase was not nearly so marked as in such states as Nevada, Montana, Wyoming and Texas. Iowa also equals Illinois in the production of Indian corn and oats, nearly 10,000,000 acres or about one-third of its improved area usually being planted with Indian corn, with a yield varying from 227,908,850 bushels in 1901 (according to state reports) to 373,275,000 (the largest in the United States, with a crop value second only to that of Illinois) in 1906. According to the Department of Agriculture in 1907 the acreage was 9,160,000 and the yield 270,220,000 bushels (considerably less than the Illinois crop); the yield of oats was 168,364,170 bushels (with the U.S. Census) in 1899, 124,738,337 bushels (U.S. Department of Agriculture) in 1890, and in 1907 the acreage and crop (greater than those of any other state) were 4,500,000 acres and 108,900,000 bushels, valued at \$41,382,000—a valuation second only to that of Illinois. In total acreage of cereals (16,920,095 in 1899) it ranked first (Twelfth Census of the United States), and in product of cereals was exceeded by Illinois only; in acreage of hay and forage (4,649,378 in 1899) as well as in the annual supply of milk (535,872,240 gallons in 1899) it was exceeded by New York only. In 1906, according to railway reports, 91,051,451 lb of butter were carried to points outside the state.

It ranked far ahead of any other state in 1908 in the number of its hogs (8,413,000, being 15% of the whole number in the United States), Illinois, the second in rank, having only about half as many. It ranked first in 1900 in the number of horses (1,392,573); in the number of poultry (about 20,000,000); in the annual egg product (99,621,000 dozen in 1899); in the total acreage of all crops (22,170,000); in the total value of agricultural products; and in the value of live stock (\$271,844,000). In 1899 it ranked fourth in the production of hark (18,059,950 bushels) and in 1907 sixth (14,178,000 bushels). The wheat crop has varied from 12,531,304 bushels in 1903, 13,683,003 bushels in 1905, 7,653,000 bushels in 1907 (according to the U.S. Department of Agriculture), to 22,769,440 bushels (Twelfth Census) in 1839. Potatoes, apples and small fruits are grown successfully. For the most part the several crops are quite evenly distributed throughout the state; but nearly all the winter wheat is grown in the S. and N.W., spring wheat largely in the N.W., barley mostly in the S. and S.W., flax-seed and prairie hay in the N.E.

**Minerals.**—The first mines to be worked in Iowa were those for lead and zinc at Dubuque and to the northward. These are little mined at present, only 110 tons of lead ore and 516 tons of zinc ore being taken from the mines in 1908. Of more promise is the gypsum deposit

extending over an area of about 50 sq. m. in the vicinity of Fort Dodge (Webster county), from which was taken in 1908 a product valued at \$565,645, having increased to that figure from \$45,819 in 1808. Limestones and sandstone are also profusely quarried; the value of the product in 1908 being \$50,945 for limestone and \$237 for sandstone. The principal mineral of Iowa, however, is bituminous coal; it ranked in 1908 eighth among the coal-producing states of the Union, its product being valued at \$11,706,402. The bed lies in the southern half of the state, extending under about two-fifths of its surface.

**Trade and Commerce.**—The manufactures of Iowa are chiefly such as have to do with the products of the farm. Meat packing is the most important, the product of this industry amounting in 1900 to \$25,595,044, and in 1905 to \$30,974,079, an increase of 17% in this time; in 1900 the state was seventh, in 1905 sixth, among the states in the value of this industry, producing in each year 3.3% of the total. Next in importance is the manufacture of dairy products, the value of which in 1900 was \$15,846,077 (an increase of 50.3% in ten years) and in 1905 was \$18,028,326; at both censuses the state ranked third in the value of cheese, butter, and condensed milk and of food preparations, which were valued at \$6,934,724 in 1905. Flour and grist-mill products ranked third both in 1900 and 1905, the value of the product for the latter year being \$12,099,493, an increase of 9.1% over the value for the earlier. Among the lesser manufactures are lumber and timber products (value in 1905, \$5,610,772), most of the raw material being floated down on rafts from Wisconsin and Minnesota. The largest centres of industry are Sioux City, Davenport, Dubuque, Des Moines, Burlington and Council Bluffs. In 1905 the gross value of the manufactured product (of establishments on the factory system) was \$160,572,313, as against \$132,870,865 in 1900, an increase of 20.8%; whereas, even including the products of smaller establishments not technically factories, the value of the product in 1850 was only \$3,551,783, and in 1880 was only \$71,045,926.

The means of transportation is afforded chiefly by the steam railways, of which the state had 9,907.44 m. in January 1900. Scarcely a farm is more than 6 or 8 m. from a railway station; and only three other states have a greater railway mileage. The great period of railway building in Iowa was during the twenties and thirties immediately following the close of the Civil War, the railway mileage being only 655 m. in 1860. The several roads are under the management of twenty-seven companies, but about 75% of the business is done by the Chicago Burlington and Quincy, the Chicago & North-Western, the Chicago Milwaukee & St Paul and the Chicago Rock Island & Pacific. Electric interurban railways are increasing in importance for freight and passenger service. In 1908 about 225 m. of such railways were in operation. Transportation facilities by water are afforded by the Mississippi river, the Des Moines river, the Des Moines Rapids of the Mississippi (which are passable for rafts and light boats at high water) have been overcome by a canal from Keokuk to Montrose constructed by the National Government. Other federal improvements undertaken are a harbour at Muscatine, a harbour of refuge below Davenport and channel improvements at Clinton.

**Population.**—The population of Iowa in 1850 was 192,214; in 1860, 674,013; in 1880, 1,624,615; in 1890, 1,911,896; in 1900, 2,231,853. The state census of 1905 showed a total population of 2,210,050, and the Federal census of 1910, of 2,224,771. Of the population in 1905, 1,264,443 (57.2%) were native whites of native parentage, 648,532 (29.3%) were native whites of foreign parentage, 289,206 (12.8%) were foreign-born and 14,832 (0.7%) were coloured, including 346 Indians. The Indians, a remnant of the Sauk and Foxes, are most unprogressive, and are settled on a reservation in Tama county in the east-central section of the state.

In 1906 it was estimated that there were 788,667 communicants of all religious denominations; of these 207,607 were Roman Catholics; 164,329 Methodists; 117,668 Lutherans; 60,081 Presbyterians; 55,948 Disciples of Christ; 44,006 Baptists; 37,001 Congregationalists; 11,681 members of the German Evangelical Synod; and 8990 Protestant Episcopalians.

The rural element of the population is large, though it is not increasing as rapidly as the urban; and no other state in the Union is so uniformly settled. There were in 1905 seven cities with a population of 25,000 or more; twenty with 8000 or more; and thirty-seven with 4000 or more. Between 1890 and 1900 the urban population increased 38.3%, while the rural increased 14.6%. The chief cities are Des Moines (pop. in 1905, 75,626), Dubuque (41,941), Davenport (39,707), Sioux City (40,952), Cedar Rapids (28,759), Council Bluffs (25,231) and Burlington (25,318).

**Government.**—There is comparatively little in the political institutions of Iowa dissimilar to those of other states of the

Union; they show in recent years a tendency toward greater centralization—in boards, however, rather than in individual officers. The constitution now in force was adopted in 1857, the constitution of 1846 having been superseded chiefly on account of its prohibition of banking corporations. The present one admits of amendment by a vote of a majority of the members of both houses of the legislature, followed by a majority vote of the electors in the state voting on the amendment; and by this process it was amended in 1868, 1880, 1884 and 1904. The present constitution also provides that the question, "Shall there be a convention to revise the constitution and amend the same?" shall be submitted to the people once every ten years (beginning with 1870), but the affirmative vote taken in accordance with this provision has hitherto been small. The suffrage now belongs to all male citizens of the United States at least twenty-one years of age who shall have resided in the state for six months, and in some one county sixty days preceding an election, except idiots and persons insane or convicted of some infamous crime. The franchise was conferred on negroes by an amendment adopted in 1868. Prior to 1904 elections were annual, but by an amendment of that year they became biennial.

The central executive and administrative authority is vested in a governor, a lieutenant-governor, an executive council, several boards and a few other officers. The governor and the lieutenant-governor was elected for a term of two years, and the qualifications for both offices require that the incumbents shall be at least thirty years of age and shall have been for two years immediately before their election residents of the state. Under the Territorial government when first organized the governor was given an extensive appointing power, as well as the right of an absolute veto on all legislation, but this speedily resulted in such friction between him and the legislature that Congress was petitioned for his removal, with the outcome that the office has since been much restricted in its appointing power, and the veto has been subjected to the ordinary United States limit, *i. e.* it may be overridden by a two-thirds vote of both houses of the legislature. Members of boards of regents or trustees of state institutions are for the most part elected by the General Assembly; railway commissioners are elected by the state electors; while in the case of the few appointments left for the governor, the recommendation or approval of the executive council, a branch of the legislature, or of some board, is usually required. He, however, is himself a member of the executive council as well as of some important boards or commissions, and it is in such capacity that he often has the greatest opportunity to exert power and influence. His salary is \$5000 per annum (with \$600 for house rent and \$800 as a member of the executive council). The executive council, composed of the governor, secretary of state, auditor of state and treasurer of state, all elected by the people for a term of two years, has extensive powers. It supervises and audits the accounts of state departments, directs the taking of the census, transfers cities from one class to another in accordance with census returns, constitutes the board for canvassing election returns, classifies railways, assesses railway and other companies, constitutes the state board of equalization for adjusting property valuations between the several counties for taxing purposes, supervises the incorporation of building and loan associations, appoints the board of examiners of mine inspectors and has many other powers. Among other state boards the more important are the board of railroad commissioners, the board of control of state institutions, the board of health, and the board of educational examiners.

The state legislature, or General Assembly, composed of a senate and a house of representatives, sits biennially at Des Moines. Senators are elected for a term of four years, one from each of fifty senatorial districts, the term of one-half expiring every two years. Senators must be at least twenty-five years of age and residents of the state for one year at the time of election. Representatives are elected for a term of two years, one from each of the ninety-nine counties, with an additional one from each

of the counties (not exceeding nine) having the largest population; the ratio of representation and the apportionment of the additional representatives from the larger counties is fixed by the General Assembly. The qualifications for representatives differ from those for electors only in that they must have been residents of the state for one year at the time of election, the disqualification of negroes for sitting in both senate and house having been removed by an amendment adopted in 1880. No bill can pass either house without the assent of a majority of all the members elected to that house; the governor is allowed three days (Sunday excepted) in which to veto a bill.

The state judiciary consists of a supreme court of six judges and a district court of fifty-three judges, from one to four in each of twenty districts. The supreme court has three sessions a year, while each district-court judge is directed to hold at least one session a year in each county of his district, and no two district-court judges may sit together on the same case. The supreme court has appellate jurisdiction in chancery cases only, but may correct errors at law in other cases. The district court has general, original and exclusive jurisdiction in all matters civil, criminal and probate not expressly conferred on an inferior court, and may hear appeals from inferior courts, boards or officers.

For purposes of administration and local government the state is divided into ninety-nine counties, each of which is itself divided into townships that are usually 36 square miles. The township may be divided into school districts and highway districts, but in these matters option has resulted in irregularity. Each county has its own administrative boards and officers; and there are two justices of the peace and two constables for every township. The board of supervisors, consisting of not more than seven members, elected for a term of three years, has the care of county property and the management of county business, including highways and bridges; it fixes the rate of county taxes within prescribed limits, and levies the taxes for state and county purposes. The officers of the township are three trustees, a clerk and an assessor. The trustees are elected for a term of three years, the clerk and assessor for two years. All taxable property of the state, that of corporations for the most part excepted, is assessed by the township assessor.

The municipal corporations are civil divisions quite independent of the county and township system. They are divided into cities of the first class, cities of the second class and towns, besides a few cities with special charters. Cities of the first class are those having a population of 15,000 or over; cities of the second class are those having a population of 5,000 but less than 15,000; all other municipal corporations, except cities with special charters, are known as incorporated towns. In all these cities and towns a mayor, council and various officers are elected, and also a police judge in cities of the first class where there is no superior court. By a law of 1907 cities with a population of 25,000 or more may adopt a commission form of government, with a mayor and four councilmen elected at large on a non-partisan ticket.

Under the laws of Iowa a wife enjoys property rights equal to those of her husband. The expenses of the family, including the education of the children, are equally alike upon the property of either or both. Otherwise, the wife may control her property as if single, and neither is liable for what are clearly the debts of the other. In case of the death of either, one-third of the property of the deceased becomes that of the survivor. A homestead cannot be conveyed or encumbered without the consent of both husband and wife, if held by a married man; and a homestead, to the value of \$500, is exempt from liability for debts postdating the purchase, unless for improvements on the property. A petition for a divorce may be presented after a residence within the state of one year immediately preceding, and a decree may be granted against the defendant if judged guilty of adultery, desertion for two years without reasonable cause, habitual drunkenness, such inhuman treatment as to endanger the life of the plaintiff, or if convicted of felony after marriage. In 1882 an amendment to the constitution was passed prohibiting the manufacture and the sale of intoxicating liquors within the state. In April 1883 the Supreme Court pronounced this amendment invalid on the ground of irregularity in recording it, whereupon the legislature provided for a like prohibition in an ordinary statute. But attempts to execute this were so unsuccessful that it has been succeeded by a law imposing what is known as the "malt tax," which requires the payment of \$600 in quarterly instalments for a licence to sell such liquors and places a lien for the whole amount on the real property in use for the business. One-half the proceeds goes to the county and one-half to the municipality or township in which the liquor is sold. The exceptional dependence of Iowa on eastern markets has given more than ordinary prominence to railway legislation, and the conflict of interests between the railways and the shippers has resulted in the past forty years various attempts being made to regulate freight rates by legal enactment. In 1888 an elective commission was established with

power to fix maximum rates, which has met with general commendation throughout the country.

The charitable, penal and reformatory institutions of the state are all under a "Board of Control of State Institutions," composed of three electors appointed by the governor and approved by two-thirds of the senators, careful provision being made also to prevent the board from becoming subject to either political party. The institutions under its charge include a Soldiers' Orphans' Home at Davenport; a Soldiers' Home at Marshalltown; a College for the Blind at Vinton; a School for the Deaf at Council Bluffs; an Institution for Feeble-minded Children at Glenwood; an Industrial School for Boys at Eldora; an Industrial School for Girls at Mitchellville; and, at Oakdale, a Sanatorium for the Treatment of Tuberculosis. The Board of Control of State Institutions has supervisory and inquisitorial powers over all county and private institutions in the state in which inmates are kept, and over homes for friendless children maintained by societies or institutions. In 1907 the General Assembly passed a law under which the indeterminate sentence was established in the state, and the governor appoints a Board of Parole of three members, of whom one must be an attorney and not more than two are to belong to the same political party.

**Education.**—The percentage of illiterates (*i. e.* those unable to read and write and those unable to write) ten years of age and over, according to the census returns of 1900, was only 2.3; of all the other states of the Union, Nebraska alone made such a good return. But many were paid, and normal schools have been opened at a time within a single county, from want of teachers. However, there are laws requiring that each school be taught at least six months in a year, and that children between the ages of seven and fourteen attend for at least twelve consecutive weeks, and for a total of sixteen weeks in every year. In 1905-1906 male teachers received on an average \$63.97 per month, women teachers, \$43.41. Although the electors of each school district have ample powers reserved to them, in actual practice matters are attended to chiefly by an elected board of directors. The county administration is in the hands of a board of education and a superintendent. The school tax was derived in 1905-1906 from interest on the state's permanent school fund—amounting to 2.3% of the total tax, and distributed in proportion to the population of school age; from a 1 to 3 mill county tax, amounting to 5.2% of the whole; and from local or district taxation, 92.5% of the entire tax. A law of the state provides for the establishment of a county high school whenever a majority of the electors of a county desire it, but in 1902 only one county (Guthrie county) had such a school. The number of public high schools in Iowa and cities, however, increased from 256 in 1893 to 845 in 1903. The state established a university at Iowa City in 1847; State Agricultural College and Model Farm in 1858 (opened Dec. Ames in 1869 as the Iowa State College of Agriculture and the Mechanic Arts), an Agricultural Experiment Station in 1887, an Engineering Experiment Station in 1904, and a normal school at Cedar Falls in 1876.

At the head of the whole system is the state superintendent of public instruction, assisted by a board of educational examiners. In 1907 the total receipts for school purposes were \$6,001,187; and the total disbursements \$5,813,541; in 1906 the receipts were \$7,126,162.12 and the disbursements \$6,950,580.27. The pupils enrolled in 1906 were 707,843. Educational institutions not supported by the state include: Iowa Wesleyan University (Methodist, opened in 1842) at Mt. Pleasant; Iowa College (Congregational, 1848) at Grinnell; Central University of Iowa (Baptist, 1853) at Pella; Cornell College (Methodist, 1857) at Mt. Vernon; Western College (United Brethren, 1856) at Toledo; Upper Iowa University (Methodist Episcopal, 1857) at Fayette; Leander Clark College (United Brethren, 1857) at Toledo; Grinnell College (Presbyterian, 1859) at Hopkinton; Luther College (Norwegian Evangelical Lutheran, 1861) at Decorah; Des Moines College (Baptist, 1865) at Des Moines; Tabor College (Congregational, 1866) at Tabor; Simpson College (Methodist, 1867) at Indianola; Wartburg College (Lutheran, 1868) at Clinton; Amity College (Non-sectarian, 1872) at College Springs; German College (Methodist Episcopal, 1873) at Mt. Pleasant; Penn College (Friends, 1873) at Oskaloosa; St. Joseph's College (Roman Catholic, 1873) at Dubuque; Parsons College (Presbyterian, 1875) at Fairfield; Coe College (Presbyterian, 1881) at Cedar Rapids; Drake University (Disciples of Christ, 1881) at Des Moines; Palmer College (Disciples of Christ, 1880) at Legend; Buena Vista College (Presbyterian, 1891) at Storm Lake; Charles City College (Methodist Episcopal, 1891) at Charles City; Morningside College (Methodist Episcopal, 1894) at Sioux City; Graceland College (Reorganized Church of Latter Day Saints, 1895) at Lamoni.

**Finance.**—The taxing system of Iowa embraces a general property tax, corporation taxes (imposed on the franchises or on either the capital stock or the net income of the corporations), and taxes on certain businesses and a collateral inheritance tax. Several important attempts have been made to effect a segregation as between state and local taxes, but for the most part without success. For the year ending June 30th, 1908, the receipts of the state from all sources were \$3,663,154.67, and the total expenditure was \$3,891,842.81. The full value of all property, according to assessment of 1904, is \$2,567,330,328. The state has no bonded debt, and

the constitution forbids it to incur debts exceeding in the aggregate a quarter of a million dollars, except for warlike purposes or for some single work to which the people give their consent by vote; the constitution also forbids any county or municipal corporation from incurring an indebtedness exceeding 5% of the value of its taxable property. When first admitted into the Union, Iowa had a strongly pronounced antipathy to banks. This was largely overcome by the year 1857, and yet the constitution of that date prohibits any legislation of primary importance relating to banks without referring the matter to a direct vote of the people. The number of banks and the amount of banking business has, nevertheless, rapidly increased.

**History.**—Iowa, as a part of the whole Mississippi Valley, was taken into the formal possession of France in 1682; in 1762 as a part of the western half of that valley it was ceded to Spain; in 1800 it was retroceded to France; in 1803 was ceded to the United States; from 1804 to 1805, as a part of the District of Louisiana, it was under the government of Indiana Territory; from 1805 to 1812 it was a part of Louisiana Territory; from 1812 to 1821 a part of Missouri Territory; from 1821 to 1834 a part of the unorganized territory of the United States; from 1834 to 1836 a part of Michigan Territory; from 1836 to 1838 a part of Wisconsin Territory. In 1838 Wisconsin Territory was divided, the western portion being named Iowa, and out of this the state with its present bounds was carved in 1846.

The name Iowa (meaning "sleepy ones") was taken from a tribe of Siouan Indians (probably of Winnebago stock), which for some time had dwelt in that part of the country and were still there when the first white men came—the Frenchmen, Marquette and Joliet, in 1673 and Hennepin in 1680. Early in the next century the Sauk and Foxes, vanquished by the French in Michigan, retreated westward, and in their turn largely supplanted the Iowas. Thither also came Julien Dubuque, a French Canadian, to trade with the new occupants. He discovered lead mines on and near the site of the city which now bears his name, in 1788 obtained an Indian grant or lease of about 21 sq. m., established there a settlement of miners and continued his mining operations, together with a trade in furs, until his death in 1810. The Indians refused permission to others to work the mines, and when intruders attempted to do so without it United States troops protected the red man's rights, especially from 1830 to 1832. But Black Hawk's war policy soon resulted in letting the white man in; for the war which he instigated was concluded in 1832 by a cession to the United States of nearly 9000 sq. m., embracing much of what is now the district of the Iowa lead and zinc mines. Without further waiting, though still in the face of the Act of Congress of 1807 prohibiting such settlements, the frontiersmen rushed in to mine and to farm, and government was established through voluntary associations. Such proceedings of these associations as related to claims to land were later recognized by the United States authorities, while such as related to the establishment of schools were tolerated for a time by the state government. Iowa, having separated from Wisconsin in 1838 on account of lack of courts for judicial relief, the question of applying for admission into the Union as a state was voted on as early as 1840, the Territory in that year having a population of 43,112; but the measure was defeated then, as it was again in 1842, by those who most wished to avoid an increase of taxes. In 1844, however, the vote was otherwise, a convention was called, a constitution framed and application for admission made. The question of boundaries, to which the question of slavery gave rise, then became the cause of delay, but the Territory became a state in 1846.

During the period in which the question of admission was under consideration, the Whigs opposed the measure, while the Democrats carried it through and remained in power until 1854; but ever since 1857 the state has been preponderantly Republican in all national campaigns; and with but two exceptions, in 1889 and 1891, when liquor and railroad legislation were the leading issues, has elected a Republican state administration. Nevertheless there has always been a strong sentiment in the state urging that corporations be held more in check, and its industries are not such as to receive a large benefit directly from tariff legislation. As a consequence there has been a tendency towards the formation of two opposing elements within the dominant party; the



more radical seeking the promotion of what since 1902 has been known as the "Iowa Idea," which in substance is to further the expansion of the trade of the United States with the rest of the world through the more extended application of tariff reciprocity, and at the same time to revise the tariff so as to prevent it from "affording a shelter to monopoly."

## GOVERNORS OF IOWA

Territorial.		
Robert Lucas . . . . .	Democrat	1838-1841
John Chambers . . . . .	Whig	1841-1845
James Clark . . . . .	Democrat	1845-1846
State.		
Ansel Briggs . . . . .	Democrat	1846-1850
Stephen Hempstead . . . . .	"	1850-1854
James Wilson Grimes . . . . .	Whig and Free-Soil	"
Democrat		
Ralph P. Lowe . . . . .	Republican	1854-1858
Samuel Jordan Kirkwood . . . . .	"	1858-1860
William Milo Stone . . . . .	"	1860-1864
Samuel Merrill . . . . .	"	1864-1868
Cyrus Clay Carpenter . . . . .	"	1868-1872
Samuel Jordan Kirkwood . . . . .	"	1872-1876
Joshua Giddings Newbold <sup>1</sup> . . . . .	"	1876-1877
John Henry Gear . . . . .	"	1877-1878
Buren Robinson Sherman . . . . .	"	1878-1882
William Larabee . . . . .	"	1882-1886
Harace Boies . . . . .	Democrat	1886-1890
Francis Darr Jackson . . . . .	Republican	1890-1894
Frank Marion Drake . . . . .	"	1894-1896
Leslie Mortier Shaw . . . . .	"	1896-1898
Albert Baird Cummins . . . . .	"	1898-1902
B. F. Carroll . . . . .	"	1902-1909

**BIBLIOGRAPHY.**—*Publications of the Iowa Geological Survey* (Des Moines, 1868); *Iowa Weather and Crop Service* (Des Moines, 1889); *U.S. Census*; F. H. Dixon, *State Railroad Control, with a History of its Development in Iowa* (New York, 1896), a detailed history of the control of Iowa railroads through the commission system; B. F. Shambaugh, *History of the Constitution of Iowa* (Des Moines, 1902); Jesse Macy, *Institutional Beginnings in a Western State* in Johns Hopkins University's *Studies in Historical and Political Science* (Baltimore, 1894); H. M. Bowman, *The Administration of Iowa, a Study in Centralization* (New York, 1903), an able presentation of the present administrative system in the light of its historical development; William Salter, *Iowa, the first Free State in the Louisiana Purchase* (Chicago, 1905); B. F. Shambaugh, *Documentary Material relating to the History of Iowa* (Iowa City, 1897), and *The Messages and Proclamations of the Governors of Iowa* (Iowa City, 1903-1904); *Annals of Iowa*, 3 series: Series 1, *The Annals of the State Historical Society of Iowa* (Iowa City and Davenport, 1863-1874); Series 2, vol. i, *The Annals of Iowa*; vol. ii, *Hove's Annals of Iowa* (Iowa City, 1882-1884); Series 3, *The Annals of Iowa*, published by the Historical Department of Iowa (Des Moines, 1893- ); *Iowa Historical Record* (Iowa City, 1885-1902); *Iowa Journal of History and Politics* (Iowa City, 1903 seq.); and G. T. Flom, *Chapters on Scandinavian Immigration to Iowa* (Iowa City, 1907).

**IOWA CITY**, a city and the county-seat of Johnson county, Iowa, U.S.A., on Iowa river, about 120 m. E. of Des Moines. Pop. (1890) 7016; (1900) 7987, of whom 1355 were foreign born; (1905) 8497; (1910) 10,091. It is served by two branches of the Chicago, Rock Island & Pacific railroad, and by the Iowa City & Cedar Rapids Interurban railway (electric), of which it is a terminus. The ground on which the city is built forms an amphitheatre surrounded for the most part by hills and bluffs. Iowa City is the seat of the state university of Iowa, of Iowa City Academy, of the library of the State Historical Society and of the state Sanatorium for the Treatment of Tuberculosis. The university, organized in 1847, and occupying the old State Capitol grounds, is an integral part of the public school system of the state, and is under the control of a board of regents, consisting of the governor, the superintendent of public instruction and eleven members, elected—one from each congressional district—by the General Assembly. The university's preparatory department was opened in 1855 and continued until 1879; the first collegiate session was in 1856-1857, but during 1858-1860 the collegiate department was closed. The institution embraces a college of liberal arts (1860), with a school of political and

social science (1900)—which offers courses in commerce, administration, modern history and practical philanthropy—and a school of education, first opened in 1907, to train secondary and college teachers and school principals and superintendents; a college of law (1868); a college of medicine (1870), including a training school for nurses (1897); a college of homeopathic medicine (1877), including a nurses' training school (1894); a college of dentistry (1882); a college of pharmacy (1885); a graduate college; a college of applied science (1903), with courses in civil, electrical, mechanical, mining, municipal and sanitary engineering and courses in chemistry; a summer school for teachers and librarians and a university extension department. Affiliated with the university is a school of music. The university's income is derived from the proceeds of invested funds and lands originally given by the United States, from permanent appropriations by the state and from the proceeds of a one-fifth mill tax to be used for buildings alone. In 1907-1908 the institution had 28 buildings (including the old State Capitol, built in 1840), a teaching and administrative force of nearly 200 members and 2315 students, of whom 1082 were in the college of liberal arts; the university library had about 65,000 volumes (25,000 were destroyed by fire in 1897), and the university law library, 14,000 volumes; and the total income of the university was about \$611,000. In 1908 the library of the State Historical Society of Iowa, housed in the Hall of the Liberal Arts of the university, numbered about 40,000 volumes. Iowa City has a considerable variety of small manufacturing establishments. In 1839 Iowa City was selected as the site for the seat of government of the newly created Territory of Iowa. The legislature met for the first time in 1841 and continued to hold its sessions here until 1857, when Des Moines, on account of its more central position, was made the capital.

**IPECACUANHA.**<sup>2</sup> The root used in medicine under this name is obtained from *Psychotria* (or *Uragoga*) *Ipecacuanha*, a small shrubby plant of the natural order Rubiaceae. It is a native of Brazil, growing in clumps or patches in moist shady forests from 8° to 22° S., and is also found in New Granada and probably in Bolivia. The drug of commerce is procured chiefly from the region lying between the towns of Cuyaba, Villa Bella, Villa Maria and Diamantina in the province of Matto Grosso, and near the German colony of Philadelphia, north of Rio Janeiro. Ipecacuanha, although in common use in Brazil, was not employed in Europe previous to 1672. In France within a few years after that date it formed the chief ingredient in a remedy for dysentery, the secret of the composition of which was purchased by the French Government for 1000 louis d'or, and made public in 1688. The botanical source of ipecacuanha was not accurately known until 1800. The root appears to be possessed of very great vitality, for in 1860 M'Nab, of the Botanical Gardens of Edinburgh, discovered that so small a portion as 1/8 of an inch of the annulated root, placed in suitable soil, would throw out a leaf-bud and develop into a fresh plant, while Lindsay, a gardener in the same establishment, proved that even the leaf-stalk is capable of producing roots and buds; hence there is but little probability of the plant being destroyed in its native habitat. The great value of the drug in dysentery, and its rapid increase in price from an average of 2s. 9d. per lb in 1850 to about 8s. 9d. per lb in 1870, led to attempts to acclimatize the plant in India, which, however, have not hitherto proved to be a commercial success, owing to the difficulty of finding suitable spots for its cultivation, and to its slowness of growth. Like other dimorphic plants, ipecacuanha ripens seeds best when cross-fertilized, and presents various forms. Two of these were described by the late Professor F. M. Balfour of Edinburgh, one distinguished by having a woody stem, firm elliptic or oval leaves, with wavy margins and few hairs, and the other by an herbaceous stem, and leaves less coriaceous in texture, more hairy and not waxy at the margins. This diversity of form is most apparent in young plants, and tends to disappear with age.

<sup>1</sup> As lieutenant-governor, Newbold serves for the unexpired portion of the term to which Kirkwood was elected; Kirkwood resigned on the 1st of February 1877, having been chosen United States senator.

<sup>2</sup> The name is the Portuguese form of the native word *i-pe-kaa-guine*, which is said to mean "road-side sick-making plant" (Skeat, *Elym. Dict.* 1898).

Ipecacuanha root occurs in pieces about 2 or 3 lines in thickness, of a greyish-brown or reddish-brown tint externally, having a ringed or annulated surface (see *r* in fig.), and exhibiting a white or greyish interior and a hard waxy centre. It has a faint rather musty odour, and a bitterish taste. It is usually mixed with more or less of the slender subterranean stem, which has a very thin bark, and is thus easily distinguished from the root. The activity of the drug resides chiefly in the cortical portion, and hence the presence of the stem diminishes its value. The variety imported from Colombia and known as Cartagena ipecacuanha differs only in its larger size and in being less conspicuously annulated. Ipecacuanha owes its properties to the presence of rather more than 1% of the alkaloid emetine, which, with the exception of traces, occurs only in the cortical

of the nasal mucous membrane, resembling a common cold in the head. It has feeble antiseptic properties. Small doses of ipecacuanha act as a stimulant to the secretions of the mouth, stomach, intestine and liver. The drug, therefore, increases appetite and aids digestion. Toxic doses cause gastro-enteritis, cardiac failure, dilatation of the blood-vessels, severe bronchitis and pulmonary inflammation closely resembling that seen in ordinary lobar pneumonia. In this respect and in its action on the skin, the drug resembles tartar emetic. Ipecacuanha is very frequently used as an expectorant in cases in which the bronchial secretion is deficient. Its diaphoretic properties are employed in the *pulvis ipecacuanhae compositus* or Dover's powder, which contains one part of ipecacuanha powder and one part of opium in ten.

Other plants to which the name of ipecacuanha has been popularly applied are American ipecacuanha (*Gillenia stipulacea*), wild ipecacuanha (*Euphorbia ipecacuanha*), bastard ipecacuanha (*Asclepias curassavica*), Guiana ipecacuanha (*Boerhaavia decumbens*), Venezuela ipecacuanha (*Sarcostemma glaucum*), and ipecacuanha des Allemands (*Vincetoxicum officinale*). All these possess emetic properties to a greater or less degree.

The term *poaya* is applied in Brazil to emetic roots of several genera belonging to the natural orders Rubiaceae, Violaceae and Polygalaceae, and hence several different roots have from time to time been sent over to England as ipecacuanha; but none of them possesses the ringed or annulated appearance of the true drug. Of these the roots of *Lonicium ipecacuanha*, *Richardsonia scabra* and *Psychotria emetica* are those which have most frequently been exported from Brazil or Colombia.

IPEK (Slav. *Petch*, Lat. *Pescium*), a town of Albania, European Turkey, in the vilayet of Kossovo and sanjak of Novibazar, 73 m. E.N.E. of Scutari, near the eastern base of the Mokra Planina, the Montenegrin frontier, and the headwaters of the Ibar and White Drin. Pop. (1905), about 15,000, principally Albanians and Serbs. A small stream bearing, like several others in the Balkan peninsula, the name of Bistritza (the bright or clear), flows through the town. On one of the neighbouring heights is situated the monastery of Ipek, founded by Archbishop Arsenius in the 13th century, and famous as the seat until 1690 of the patriarchs of the Servian church. The buildings are surrounded by thick walls, and comprise a large central church (Our Lady's), and two side chapels (the Martyrs' and St Demetrius'), each surmounted by a leaden cupola. The church dates from the 16th and 17th centuries. Among its numerous objects of interest are the white marble tombs of Arsenius and other chiefs of the Servian church, and the white marble throne on which the patriarchs were crowned. Ipek has been incorrectly identified by some writers with Doclea or Dioclea (the Duklé in Montenegro), the birthplace of Diocletian, and the capital of a small principality which was overthrown by the Bulgarians in the 11th century.

See Barth, *Reise durch das Innere der europäischen Türkei* (Berlin, 1864); A. P. Irbly and G. M. M. Mackenzie, *Travels in the Slavonic Provinces of Turkey* (1877); M. E. Durham, *Through the Lands of the Serb* (London, 1904).

IPHICRATES, Athenian general, son of a shoemaker, flourished in the earlier half of the 4th century B.C. He owes his fame as much to the improvements which he made in the accoutrements of the peltasts or light-armed mercenaries (so called from their small round shield, *πέλας*) as to his military successes. Increasing the length of their javelins and swords, substituting linen coislets for their heavy coats-of-mail, and introducing the use of a kind of light leggings, called after him "iphicratides," he increased greatly the rapidity of their movements (Diod. Sic. xv. 44). He also paid special attention to discipline, drill and manœuvres. With his peltasts Iphicrates seriously injured the allies of the Lacedaemonians in the Corinthian War, and in 392 (or 390) dealt the Spartans a heavy blow by almost annihilating a *moræ* (battalion of about 600 men) of their famous hoplites (Diod. Sic. xiv. 91; Plutarch, *Agessilaus*, 22). Following up his success, he took city after city for the Athenians; but in consequence of a quarrel with the Argives he was transferred from Corinth to the Hellespont, where he was equally successful. After the peace of Antalcidas (387) he assisted Seuthes, king of the Thracian Odrysaë, to recover his kingdom, and fought

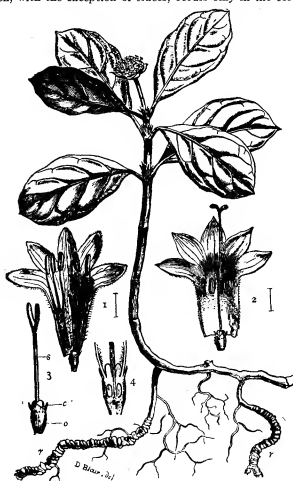

Ipecacuanha Plant (about  $\frac{1}{2}$  nat. size). 1, 2, Flowers cut open, showing short-styled (1) and long-styled (2) forms; 3, Flower after removal of corolla, showing the inferior ovary (*c*), the small toothed calyx (*cl*), and the style (*s*) with its forked stigma; 4, Ovary cut lengthwise showing the two chambers with the basally attached ovules; *r*, annulated root.

portion of the root. It is a white amorphous substance, with the formula  $C_{22}H_{39}NO_5$ . It has a bitter taste, no odour, and turns yellow when exposed to air and light. There are also present a volatile oil, starch, gum, and a glucoside, which is a modification of tannin and is known as ipecacuanhic acid. The dose of the powdered root is  $\frac{1}{2}$  to 2 grains when an expectorant action is desired, and from 15 to 30 grains when it is given as an emetic, which is one of its most valuable functions. The Pharmacopœias contain a very large number of preparations of this substance, most of which are standardized. A preparation from which the emetine has been removed, and known as "de-emeticized ipecacuanha" is also in use for cases of dysentery.

When applied to the skin, ipecacuanha powder acts as a powerful irritant, even to the extent of causing pustulation. When inhaled it causes violent sneezing and a mild inflammation

against Cotys, with whom, however, he subsequently concluded an alliance. About 378 he was sent with a force of mercenaries to assist the Persians to reconquer Egypt; but a dispute with Pharnabazus led to the failure of the expedition (Diod. Sic. xv. 29-43). On his return to Athens he commanded an expedition in 373 for the relief of Corcyra, which was besieged by the Lacedaemonians (Xenophon, *Hellenica*, vi. 2). On the peace of 371, Iphicrates returned to Thrace, and somewhat tarnished his fame by siding with his father-in-law Cotys in a war against Athens for the possession of the entire Chersonese. The Athenians, however, soon pardoned him and gave him a joint command in the Social War. He and two of his colleagues were impeached by Chares, the fourth commander, because they had refused to give battle during a violent storm. Iphicrates was acquitted but sentenced to pay a heavy fine. He afterwards remained at Athens (according to some he retired to Thrace) till his death (about 353).

There is a short sketch of his life by Cornelius Nepos; see also C. Rehdantz, *Vitae Iphicratis, Chabriae et Timothei* (1854); Bauer, *Griech. Kriegeralter*, in Müller's *Handbuch*, 4, § 49; and histories of Greece, e.g. Holm, Eng. trans., vol. iii.

**IPHIGENEIA**, or **IPHIANASSA**, in Greek legend, daughter of Agamemnon and Clytaemnestra. Agamemnon had offended Artemis, who prevented the Greek fleet from sailing for Troy, and, according to the soothsayer Calchas, could be appeased only by the sacrifice of Agamemnon's daughter. According to some accounts the sacrifice was completed, according to others Artemis carried away the maiden to be her priestess in the Tauric Chersonese (*Crimea*) and substituted for her a hind. In this new country it was her duty to sacrifice to the goddess all strangers; and as her brother Orestes came to search for her and to carry off to Attica the image of the goddess, she was about to sacrifice him, when a happy recognition took place. These legends show how closely the heroine is associated with the cult of Artemis, and with the human sacrifices which accompanied it in older times before the Hellenic spirit had modified the barbarism of this borrowed religion. Orestes and Iphigeneia fled, taking with them the image; at Delphi they met Electra, the sister of Orestes, who having heard that her brother had been sacrificed by the Tauric priestess, was about to tear out the eyes of Iphigeneia. The brother and sister returned to Mycenae; Iphigeneia deposited the image in the deme of Brauron in Attica, where she remained as priestess of Artemis Brauronia. Attica being one of the chief seats of the worship of Artemis, this explains why Iphigeneia is sometimes called a daughter of Theseus and Helen, and thereby connected with the national hero. The grave of Iphigeneia was shown at Brauron and Megara. According to other versions of the legend, when saved from sacrifice Iphigeneia was transported to the island of Leuke, where she was wedded to Achilles under the name of Orsilochia (Antoninus Liberalis 27); or she was transformed by Artemis into the goddess Hecate (Pausanias i. 43. 1). According to the Spartans, the image of Artemis was transported by Orestes and Iphigeneia to Laconia, where the goddess was worshipped as Artemis Orthia, the human sacrifices originally offered to her being abolished by Lycurgus and replaced by the flogging of youths (*diastigmatosis*, Pausan. iii. 16). At Hermione, Artemis was worshipped under the name of Iphigeneia, thus showing the heroine in the last resort to be a form of that goddess (Pausanias ii. 35. 1). Originally, Iphigeneia, the "mighty born," is probably merely an epithet of Artemis, in which the notion of a priestess of the goddess had its origin. Iphigeneia is a favourite subject in Greek literature. She is the heroine of two plays of Euripides, and of many other tragedies which have been lost (see also Pindar, *Pythia* xi. 23; Ovid, *Metam.* xii. 27). In ancient vase paintings she is frequently met with; and the picture by Timanthes representing Agamemnon hiding his face at her sacrifice was one of the famous works of antiquity (Pliny, *Nat. Hist.* xxxv. 10).

See M. Jacobson, *De fabulis ad Iphigeniam pertinentibus* (1888); R. Förster, *Iphigeneia* (1898); H. W. Stoll in Roscher's *Lexikon der Mythologie*; and P. Decharme in Daremberg and Saglio's *Dictionnaire des antiquités*.

**IPSWICH**, a town of Stanley county, Queensland, Australia, on the river Bremer, 23½ m. by rail W. by S. of Brisbane. Pop. (1901), 8637. It is the centre of a rich and populous agricultural mining and manufacturing district. Coal is worked on the banks of the river with but little labour, as it crops out on the surface. There are a woollen factory, several saw-mills, and foundries and large railway workshops at North Ipswich. The first settlement was made here in 1829; the town was incorporated in 1860.

**IPSWICH**, a municipal, county and parliamentary borough and county town of Suffolk, England, 69 m. N.E. by E. from London by the Great Eastern railway. Pop. (1901), 66,630. It stands on a gentle ascent above the left bank of the river Gipping, which here widens into the tidal estuary of the Orwell. This land-locked inlet extends 11 m. S.E. to Harwich and Felixstowe at opposite sides of its mouth, near which the wider Stour estuary unites with it. Its banks are gently undulating, well wooded and picturesque. In the lower and older portion of Ipswich, with its irregular streets, are some few antiquarian remains. Sparrow's house (1567), named from a family which occupied it for some two centuries, is well preserved and has ornate gabled fronts to two streets. Archdeacon's Place (1471) is another still earlier example. Walsey's Gateway (1528), a Tudor brick building, is the only remnant of the Cardinal's foundation to supply scholars to his great college (Cardinal's College, now Christ Church) at Oxford. The older churches are all towered flint-work structures, wholly or mainly Perpendicular in style, with the exception of St Peter's, which is principally Decorated, with a Norman font of marble. They include St Margaret's with a beautiful oak Tudor roof, elaborately painted *temp.* William and Mary; St Mary-at-Key (or Quay), with a similar roof; St Lawrence; and St Clement's. The most noteworthy modern churches are St Michael's (1880), All Saints' (1892), St John the Baptist's (1899) and St Bartholomew's (1901). The Roman Catholic church of St Pancras (1863), a late First Pointed edifice, has a richly carved rearedos and a lofty flèche. Among public buildings, the town hall (1868) is an imposing structure in Venetian style, with clock tower; forming part of a fine group including the corn exchange (1881) and post office (1880). The museum, including an art gallery, contains archaeological and ornithological collections, and a noteworthy series of Red Crag fossils. It was founded in 1847, and moved to new buildings in 1881. The East Suffolk hospital was founded in 1836. In the theatre David Garrick made his first important and regular appearance in 1741. The grammar school, dating at latest from 1477, was refounded by Queen Elizabeth in 1565, and is housed in buildings in Tudor style (1851). There are borough science, art and technical schools, with a picture gallery in the fine Tudor mansion (1549) in Christchurch Park. There are also a middle school for boys, a high school and an endowed school for girls, a scientific society, corporation library and small medical library. Of two beautiful arboretums the upper is public; part of Christchurch Park adjacent to this is owned by the corporation; there are also recreation grounds and a race-course. Industries include large engineering and agricultural implement works, railway plant works, the making of artificial manures, boots and shoes, clothing, bricks and tobacco and malting. The port has a dock of nearly 30 acres, accommodating vessels drawing 10 ft. and a large extent of quays. Imports are principally grain, timber and coal; exports agricultural machinery, railway plant, artificial manures, oil cake, &c. Ipswich is a suffragan bishopric in the diocese of Norwich. The parliamentary borough returns two members. The corporation consists of a mayor, 10 aldermen and 30 councillors. Area, 8112 acres.

A Roman villa has been discovered here. But the Saxon settlement at the head of the Orwell was doubtless the first of any importance. In 991 the town (*Gipeswic, Gipeswich*) was sacked by vikings. It owes its subsequent prosperity to its situation on a harbour admirably suited for trade with the Continent. The townsmen had acquired the privileges of burghesses by 1086 when Roger Bigot kept the borough in the

king's hands. In 1200 King John granted the burgesses their first charter, confirming their town to them to be held at fee-farm, exempting them from tolls and similar customs, and granting them a gild-merchant. These liberties were extended in 1256; Edward I. and Edward III. both resumed the borough for short periods, but the charter of 1200 was confirmed by almost every subsequent sovereign. The burgesses were definitely incorporated in 1464 and re-incorporated in 1665 under a charter which remained in force previous to its modification by the Municipal Act of 1835, except during a short period in the reign of Charles II. From 1295 onwards the town has sent two representatives to parliament. The cattle market, held on Tuesdays, and the provision market on Saturdays are the prescriptive right of the corporation. A September fair, still held in 1792, was in the hands of the corporation in the 17th century. Large ironworks were established late in the 18th century. The wool and cloth trade which flourished here in the 14th and 15th centuries was superseded by the manufacture of sailcloth, now represented by the sacking industry.

See *Victoria County History: Suffolk*; J. Wodderspoon, *Memorials of the Ancient Town of Ipswich* (ed. 1850).

**IPSWICH**, a township of Essex county, Massachusetts, U.S.A., on both sides of the Ipswich river, about 27 m. N.N.E. of Boston. Pop. 1010 (Federal census, 5777. It is served by the Boston & Maine railroad. The surface is diversified by drumlins, vales, meadows, sand-dunes and tidal marshes. Ipswich has several manufacturing industries, including hosiery. The public library was the gift of Augustine Heard. Among the residences are several built in the 17th and 18th centuries. The oldest of these, the John Whipple House, is the home of the Ipswich Historical Society (1890), which has gathered here a collection of antiques and issues publications of antiquarian interest. In the Ipswich Female Seminary, which no longer exists, Mary Lyon taught from 1828 to 1834 and here planned Mount Holyoke Seminary; Professor J. P. Cowles and his wife conducted a famous school for girls in the building for many years. Facing the South Common were the homes of Rev. Nathaniel Ward (1578-1652), principal author of the Massachusetts "Body of Liberties" (1641), the first code of laws in New England, and author of *The Simple Cocker of Aggawam in America, Willing to help mend his Native Country, lamentably tattered, both in the upper-Leather and the Sole* (1647), published under the pseudonym, "Theodore de la Guard," one of the most curious and interesting books of the colonial period; of Richard Saltonstall (1610-1694), who wrote against the life tenure of magistrates, and although himself an Assistant espoused the more liberal principles of the Deputies; and of Ezekiel Cheever (1614-1708), a famous schoolmaster, who had charge of the grammar school in 1650-1660. In the vicinity was the house of the Rev. William Hubbard (1621-1704), author of a *Narrative of the Troubles with the Indians in New England* (Boston, 1677) and a general *History of New England*, published by the Massachusetts Historical Society in 1815.

The town was founded under the name of Aggawam in 1633 by John Winthrop, jun., and twelve others, with a view to preventing the French from occupying the N. part of Massachusetts, and in the next year it was incorporated under its present name. In wealth and influence during the early colonial period it was little inferior to Boston, whose policies it not infrequently opposed. When Governor Andros and his Council in 1687 issued an order for levying a tax, a special town meeting of Ipswich promptly voted "that the s'd act doth infringe their Liberty as Free borne English subjects of His Majesty by interfering with ye statutory Laws of the Land, By which it is enacted that no taxes shall be levied on ye Subjects without consent of an assembly chosen by ye Freeholders for assessing the same," and refused to assess the tax. For this offence six leaders, headed by the Rev. John Wise, minister of the Chebacco Parish (now Essex), were prosecuted, found guilty, imprisoned for three weeks to await sentence and then disqualified for office; they were also fined from £15 to £50 each, and were required to give security for their good behaviour. In Ipswich were originally

included the present townships of Hamilton (1793) and Essex (1819).

See T. F. Waters, *Ipswich in the Massachusetts Bay Colony 1633-1700* (Ipswich, 1905), and the publications of the Ipswich Historical Society.

**IQUIQUE**, a city and port of Chile, capital of the province of Tarapacá, 820 m. N. of Valparaíso, in 20° 12' 15" S., 70° 11' 15" W. Pop. (1895), 33,031; (1900, est.), 42,440. The coast here runs due N. and S. and the city is built on a narrow level plain between the sea and bluffs, the latter rising steeply 2000 ft. to the level of the great desert plain of Tarapacá, celebrated for its rich deposits of nitrate of soda. Facing the city is the low barren island of Serrano, or Iquique, which is connected with the mainland by a stone causeway 1500 ft. long, and shelters the anchorage from southerly storms. A mole extending from the N.E. end of the island affords some further protection. The city is laid out in the rectangular plan, with broad streets and large squares. Water is brought by pipes from Pica, 50 m. distant. Iquique is a city of much commercial importance and is provided with banks, substantial business houses, newspapers, clubs, schools, railways, tramways, electric lights, telephone lines, and steamship and cable communication with the outside world. It exports iodine and immense quantities of nitrate of soda obtained from the desert region of the province. A large number of vessels are engaged in the nitrate trade, and Iquique ranks as one of the two leading ports of Chile in the aggregate value of its foreign commerce. It is connected by rail with the inland town of Tarapacá and various mining centres, and through them with the ports of Pisagua on the N., and Patillos on the S. Iquique was an insignificant Peruvian fishing settlement until 1830 when the export of nitrate began. In 1868 the town was nearly destroyed by an earthquake, in 1875 by fire, and again in 1877 by earthquakes, a fire and a tidal wave. It was occupied by the Chileans in 1879 in the war between Chile and Peru, and was ceded to Chile by the treaty of the 20th of October 1883.

**IQUITOS**, a tribe of South American Indians. It is divided into many branches, some on the river Tigre, others on the Nanay. Missionary efforts have failed and they remain savages, worshipping figures carved in the shape of birds and beasts. They brew the Indian fermented liquor *chicha* better than any of the neighbouring tribes, flavoured it with the shoots of some plant which has the effect of an opiate.

**IQUITOS**, a city and river port of Peru, and capital of the great inland department of Loreto, on the left bank of the upper Amazon near the mouth of the Rio Nanay, 87 m. below the mouth of the Ucayali and 930 m. from Puerto Bermudez. The geographical position of Iquitos is 3° 44' S., 73° W. Pop. of the city (1906, est.), 6000; of the district (1906, est.), 12,000. Iquitos stands about 348 ft. above sea-level, on the low wooded banks of the river opposite some islands of the same name, and has a warm but healthful climate (mean annual temperature, about 75° F.). The city consists of two *pueblos*, the larger of which is occupied by Indians and half-breeds, the descendants of the Iquitos tribe from whom the city takes its name. The opening of the Amazon to navigation, and the subsequent arrival of foreign ocean-going vessels at Iquitos, added immensely to the importance of the city, and made it the commercial entrepôt of eastern Peru. In 1908 three lines of ocean-going steamers were making regular voyages up the Amazon to Iquitos (about 2500 m.). The city has a large import and export trade for an immense region watered by the Marañon, Huallaga, Ucayali and other large Amazonian rivers navigated from Iquitos by lines of small boats. Iquitos was put in wireless telegraphic communication with Puerto Bermudez on the 8th of July 1908, whence a land line runs across the Andes to Lima. Besides machine shops and shipbuilding facilities, the important industries are the weaving of hats and hammocks, and the preparation of salt fish; and there is a considerable export of rubber and straw hats. Tobacco is produced in the vicinity and sent to other parts of the Montaña region. Iquitos dates officially from 1863, when it had a population of 431, though there had been a white settlement there for more than half a century.

**IRAK**, a province of Persia, situated W. of Kum and Khashan and E. of Burujird, and paying a yearly revenue of about £16,000. The province has many flourishing villages which produce much grain, but its greatest income is derived from the carpets made in many of its villages and mostly exported to Europe, the value of which is estimated at about £100,000 per annum. An important British firm is established at Sultanabad, the capital of the province, solely for this trade. Sultanabad is situated 77 m. S.W. of Kum in 34° 6' N. and 49° 42' E. at an elevation of 5925 ft. It has a population of about 8000 and post and telegraph offices. It was founded in 1808 and made a recruiting centre for some battalions of infantry which were to form part of the reorganized Persian army as recommended by the chief of the French mission, General Gardane. In consequence of its recent foundation it is still occasionally spoken of as Shahr-i-no, the "new city."

**IRAK-ARABI** ('Iraq-Arabi, "Arab Iraq"), the name employed since the Iraq conquest to designate that portion of the valley of the Tigris and Euphrates known in older literature as Babylonia. Iraq is approximately the region below the Median Wall, from Opis on the Tigris, at the mouth of Shatt-el-Adhem, to the neighbourhood of Ramadieh (Ramadiya) on the Euphrates; that is, from nearly latitude 34° to the Persian Gulf, and from the Syrian desert to the Persian mountains. It consists of two unequal portions, an extensive dry steppe with a healthy desert climate, and an unhealthy region of swamps. There is a good deal more agriculture along the Euphrates than along the Tigris, but swamps are at the same time much more extensive along the former. The borders of both streams wherever there is habitation are lined with date-palms. This is especially true of the lower part of Iraq in the Basra vilayet, where the date-palm forms dense groves bordering the banks for a distance of many days' journey. A luxuriant vegetation of water plants is to be found in the swamps, which are the haunt of numerous wild beasts—pigs, lions, different kinds of aquatic animals and birds. These swamps are inhabited by a wild race of men, dark of hue, with many negroes among them, who cultivate rice and weave straw mats. Their chiefs, with their wives and a very few retainers or members of their immediate families, live in mud castles; the tribesmen live in rude huts of reeds and mats about these castles. In the main these swamp-dwellers, who designate themselves *Ma'dan*, keep pretty free both of the Turkish government and of the semi-Bedouins of Iraq. Some of them are very lawless, especially the inhabitants of the region below the Shatt-el-Hai, between the two rivers. Here the Turkish government exercises no authority, and the tribesmen of the swamps play pirate on the merchandise passing up and down the Euphrates above Korna, where for some 80 m. the river has been allowed to form an immense swamp. Some of the Bedouin tribes also engage in marauding expeditions and terrorize certain portions of the country. Especially troublesome are the edh-Dhafir, westward of the Euphrates, opposite the mouth of the Shatt-el-Hai, and the Beni Lam (7500 tents strong) who occupy the country east of the Tigris to the south of Bagdad. Still more difficult of control is the great tribe of Shammar, who descend every year from the north, pitching their tents in the Jezireh (*i.e.* the region between the two rivers) southward of Bagdad, and terrifying the whole country during their stay. The Turkish government is, however, gradually extending its authority over all Iraq partly by force, partly by treachery. The Afech nation, Ma'dan Arabs, occupying the swamps behind Diwanieh between the Tigris and Euphrates, and the great Montefich tribes, Bedouins who claimed the whole country southward of the Afech to the Shatt-el-Hai and beyond, have since 1880 been deprived gradually of their power and a considerable part of their independence. In 1903 the Turkish government transferred the capital of the sanjak of Hillah to Diwanieh opposite the Afech swamps, and there is now a line of towns, centres of Turkish power and Turkish force, extending southward from Ana to Nasrîeh, at the mouth of the Shatt-el-Hai canal, while similar stations are being established or strengthened along the Tigris. Some important steps have also

been taken by the Turkish government to control the Euphrates floods, and to drain the swamps in some sections of the country, especially westward of the Euphrates. A dam was built at the mouth of the Hindieh canal to prevent the waters of the Euphrates from losing themselves as retroflore in the swamps westward, and to assure a continual supply of water in the main bed of the Euphrates. It is, however, frequently carried away. The ancient Assyrium Stagnum, or Bahr Nejez near the town of that name, with other swamps formed by the overflow of the Hindieh, have been drained and turned into rice plantations. At the same time large sections of Iraq have been converted into imperial domain, to the diminution of the revenues of the country but to the increase of the prosperity of the population which inhabits that domain. Something, though not very much, has thus been done to restore the land to its ancient fertility.

Ethnographically Iraq is subject to a double influence. On the one hand the connexion with Nejd, the Agel Bedouins of Arabia, continues uninterrupted, even the 'Arabi Bedouins from central Arabia having a quarter of their own in Bagdad. Many of these Arabs come to Iraq merely for a temporary residence, returning later to their homes with the earnings acquired in that comparatively rich country; but a considerable number remain permanently. Even stronger than the influence of Arabia is that of Persia. In general the inhabitants of Iraq are Shi'ites not Sunnites, and their religious connexion and allegiance is therefore toward Persia, not Turkey. Persian customs are in fashion, Persian coinage is used equally with the Turkish, and in some parts, more especially in Bagdad, there is an important Persian quarter, while Kerbela and Meshed 'Ali to the west of the Euphrates are really Persian enclaves in Turkish territory. No traces remain of that rich intellectual development which was produced in the time of the caliphs through the reciprocal action of Persian and Arabic elements. Still, the quick-wittedness of the inhabitants of Iraq makes a decided impression on the traveller passing through Asiatic Turkey. Throughout Iraq also Indian influence is visible in not a few particulars. In the hot summer months, for instance, when the natives live in those underground apartments called *serdab*, the Indian punkah is used in the houses of the rich. There are also small Indian colonies at most of the large towns and a considerable trade with India is carried on, especially in horses.

The trade of Iraq is even now not unimportant. The principal exports from Basra are dates, various grains, millet seed, rice and wool, while the imports consist chiefly of Manchester goods, lumber, petroleum, coal and household necessities. Besides this there is a considerable land commerce by caravan, of which Bagdad is the centre. The total value of the exports of Iraq according to the official figures of the Turkish government amounts to nearly £2,000,000, while the imports of every kind reach the value of about £1,800,000. If the ancient system of irrigation were restored and the land restored to cultivation, the country could support five hundred times as many inhabitants as it usually contains. Steamboats navigate the Tigris only as far as Bagdad, and that with great difficulty. In general, communication by water is carried on by means of the most primitive craft. Goods are transported in the so-called *turrodas*, moderately big high-built vessels, which also venture out into the Persian Gulf as far as Kuwait. Passengers are conveyed, especially on the Euphrates, in the *meshhuf*, a very long narrow boat, mostly pushed along the river bank with poles or towed by ropes. The Mesopotamian *kelleks*, rafts laid on goat-skin bladders, come down the Tigris as far as Bagdad. At Bagdad round boats made of plaited reeds pitched with asphalt, the so-called *kufas* (*qufas*), are used. At Basra the *bellems* are in use, boats of large size, having the appearance of being hollowed out of tree trunks and partly in fact so constructed. There are no roads, and the extensive swamps and periodic inundations which lay large sections under water render land traffic by caravan somewhat uncertain.

Iraq in general is an alluvial plain, formed by the deposits of the rivers Tigris and Euphrates, with a few scattered reaches of sand

appearing here and there. The mass of solid matter which the rivers deposit is very considerable. The maximum proportion for the Euphrates in the month of January is  $\frac{1}{10}$  and at other times  $\frac{1}{10}$ ; for the Tigris the maximum is  $\frac{1}{10}$ . In general, the northern plains of the interior have a slight but well-defined southerly inclination, with local depressions. The territory undulates in the central districts, and then sinks away into mere marshes and lakes. The clay, of a deep blue colour, abounds with marine shells, and shows a strong efflorescence of natron and sea-salt. When the soil is parched the appearance of the mirage (*serab*) is very common. As extensive inundations in spring are caused by both the rivers, especially the Tigris, great changes must have taken place in this part of the country in the course of thousands of years. It has been asserted that in former times the alluvial area at the mouth of the river increased 1 m. in the space of thirty years; and from this it has been assumed that about the 6th century B.C. the Persian Gulf must have stretched from 45 to 55 m. farther inland than at present. The rate of increase at the present time is about 72 ft. per annum. While we may be unable to determine accurately the former physical configuration of southern Babylonia it is at least certain that in Babylonian times the Euphrates and Tigris reached the sea as independent rivers, and Ritter estimates that in the time of Alexander the Great the embouchures were still separated by a great day's journey. Although they cannot now be traced, great alterations have probably taken place also in the upper portions of the rivers as well as in the country near their mouths. The names of a large number of canals occur in the old Babylonian inscriptions, as in the works of the Arabian geographers, but while some of these have been traced it has not been possible hitherto to identify the greater number of them with actually existing canals or remains of canals. To the west of the Euphrates, on the edge of the Syrian desert from Hit downward to the neighbourhood of Basra and beyond, ran the Sa'adeh, now for the most part dry, a very ancient canal, extended or enlarged at different periods. Lower down near Musabbih, the Hindieh canal, at least equal in volume to the present main stream, branches off and after traversing and irrigating an extensive territory rejoins the river at Samawa. Between the Euphrates and the Tigris, there was a large number of great canals, especially in the region northward of Babylon between that city and the northern edge of the alluvial plain, of which the most famous were the 'Isa, the Sarsar, (Shatt-en-Nil), the canal of Kutha, the Sura and the Arakhat (Shatt-en-Nil), of these only one at present carries water, namely, the Nahr 'Isa, which, leaving the Euphrates at Saklawieh (Sakh lawiwa), terminates in extensive marshes near Bagdad; but this is now no longer navigable. Southward of Babylon the Daghara canal, which leaves the Euphrates a little below Hillah and empties into the Affech marshes, and the Shatt-el-Kehr, which, leaving the canal a little above Diwanieh, makes a great curve through the interior of the Jezireh, finally losing itself in the Hosainieh (Hosainiya) marshes near the mouth of the Shatt-el-Haf, are the only navigable or partly navigable canals of the Euphrates in the Jezireh. The Tigris canals are not so numerous as those of the Euphrates and were not so famous in history, but eastward of that river the great Nahrawan channel still exists in part, while the Tigris is connected with the Euphrates by a navigable stream, the Shatt-el-Haf, which leaves the former river at Kut-el-Amara and enters the Euphrates at Nasrieh. Everywhere where the country is intersected with ancient canals, some still deep dry beds, other so silted up that they are represented only by parallel lines of hillocks. Some of these, of great antiquity, like the Shatt-en-Nil, which can be traced through its whole course from Babylon, through or past Nippur, Udnun (Bismya) Gishban (Gis-ukh), Erech and Larsa, to the Hosainieh marshes, were equally as important as the Euphrates itself; and indeed it may be said that in ancient times that stream after reaching the alluvial plain was divided into a large number of channels, partly natural partly artificial, no single one of which, but all together, constituted the Euphrates. In the course of the centuries, traces of which are met with in the restoration of these old canals, have again raised to that condition of high civilization which it enjoyed not only in antiquity but even as late as the time of the caliphs. The classical writers are unanimous in their admiration of Babylonia, and it is certain that nowhere else in the ancient world was so successfully a  $\gamma$  of canals to the exigencies of agriculture worked out so successfully as here. The most luxuriant vegetation was diffused over the whole country and three crops were obtainable in the year. In the matter of civilization indeed no country of the ancient world surpassed Babylonia. How densely peopled this country once was may be gathered from the fact that about 794 B.C., 89 fortified towns and 820 smaller places in the Chaldean region were captured during one military expedition. In the times of the caliphs there stood on the royal canal and its branches, north of Babylon, 360 villages, contributing in gold 225,000 dirhems to the state treasury besides the tax in kind. To-day the whole region from the swamps about Basra northward is dotted with ruin mounds, and at places the plain itself is strewn for miles with fragments of glass and pottery, evidence of earlier occupation, while, as stated, lines of canals of all possible sizes, from the great triple canals with four rows of parallel hillocks, down to the small canals for purposes of irrigation, intersect the country in every direction.

There seem to have been almost from the outset two centres which strove with one another for political supremacy in this region, the south and the north. In the north in the Babylonian time lay Kish, Akkad, Kutha (Tell-Ibrahim), Sippara (Abu Habba), Babylon and Borsippa (Birs-Nimrud). In the south were Eridu and Ur (Mughair)—originally on the shores of the Persian Gulf, now 125 m. inland—Erech (Warka), Larsa (Senkereh), Lagash (Tello) and Gishban (Yokha). Nearly in the centre lay Nippur and Udnun (Bismya). Besides these there were numerous other cities, some of considerable importance, which are known to us at present only by name; and there are in Irak hundreds of ruin mounds, some of them of considerable size, covering ancient Babylonian cities, the greater part of which are still unexplored and unidentified. During the period of Greek domination a Greek city, Seleucia (g.v.), which afterwards attained great prosperity, was founded by Seleucus I. in an extremely favourable situation on the right bank of the Tigris. Greek cities were founded also in the south, at the head of the Persian Gulf, and some of the ancient Babylonian cities of the interior like Lagash, Erech and Nippur, were rebuilt on the old sites. After the conquest of Babylonia by the Parthians (130 B.C.) Ctesiphon (g.v.) was built on the east bank of the Tigris opposite Seleucia, and became the winter residence of the Persian kings. Later this double city became the imperial capital of the Sassanids, and under the name Madain still continued to flourish after the Arabic conquest, to be finally superseded by the neighbouring Bagdad. That region was called in the time of the Sassanids, Suristan, a translation of the Aramaean designation Beth-Aramaya, "a country of the Syrians," for the land was mainly occupied by Aramaeans. By a notable substitution the Arabs afterwards gave the name Nabat, i.e. Nabataeans, to these Aramaean tenants, who it may be added were already found in these parts at the time of the Babylonian empire. Indeed, some small portion of this old Syrian population of Irak still remains distinguished by a special religion (see MANDAEANS), chiefly on the shores of the lower Euphrates in the neighbourhood of Suk-esh-Sheikh. Another important city of the Sassanian period was Perisabora, known in the Arabian period as Anbar, the centre also of Babylonian Judaism after the destruction of Pumbeditha in A.D. 588, situated on the east bank of the Euphrates in about the same latitude as Bagdad. During the Sassanian period flourished in the south-east the Arabic kingdom of Hira (g.v.). There was also for a time a Jewish kingdom in Babylonia, and Nehardea and Pumbeditha are mentioned as centres of Jewish religions and national life during this period.

After the Arabian conquest in the 7th century A.D., Irak entered for a time on a new period of prosperity. Several important new cities were founded, among them Kufa, Basra, Wasit on the Shatt-el-Haf, and Bagdad on the site of an old Babylonian city of the same name, which later became under the Abbasid caliphs not only the capital of Irak but for a time the metropolis of the world (see CALIPHATE). With the decay of the Abbasid power the system of irrigation began to fall into disrepair, the ancient sites were gradually deserted, and the country finally returned to a condition of semi-barbarism alternating between inundation and drought, which is its present state.

See Ritter, *Die Erdkunde von Asien*, 2nd ed., vol. vii., 10th and 11th parts (Berlin, 1843, 1844); W. F. Ainsworth, *Researches in Assyria* (London, 1838); F. R. Chesney, *Expedition for the Survey of the Rivers Euphrates and Tigris* (2 vols., London, 1850); W. K. Loftus, *Chaldea and Susiana* (1857); F. Delitzsch, *Wo lag das Paradies?* (Leipzig, 1881); W. F. Ainsworth, *The Euphrates Expedition* (1888); J. P. Peters, *Nippur* (1897); E. Sachau, *Am Euphrat und Tigris* (1900); F. Delitzsch, *Im Lande des einstigen Paradieses* (1903). Maps: Chesney (1850); Selby, Bewsher and Collingwood (1871); Kiepert, *Ruinenfelder* (1883). (A. So.; J. P. Pe.)

**IRAK-I-AJAMI** (i.e. Persian Irak), the name (now obsolete) of the important Persian province which the Arab geographers called Jebel (the mountainous region). It used to be the country bounded N. by Azerbaijan and Gilan, E. by Samnan and the central Persian desert, S. by Kerman, Fars and Arabistan,

W. by Kermanshah and Kurdistan. Its length, N.W.-S.E., was about 600 m. from the Kallán Kuh on the Kizil Uzun, the frontier of Azerbaijan, to the frontier of Kerman beyond Yezd, and its width, N.E.-S.W., about 300 m.

**IRAN**, the great plateau between the plain of the Tigris in the west and the valley of the Indus in the east, the Caspian Sea and the Turanian desert in the north, and the Persian Gulf and the Indian Ocean in the south, surrounded on all sides by high mountain ranges with a great salt desert in the centre. The modern name Iran, in middle-Persian Eran (a form preferred by many German authors) is derived from the ancient *Aryāna*, "the country of the Aryans," i.e. that part of the Aryans which we call Iranians. Eratosthenes limited the name of Ariana to the south-eastern part of Iran, and excluded Persia, Media and Bactria, and therein he is followed by Strabo (ii. 78, 130, xv. 720 ff.; Pomp. Mela i. 3; Pliny, *Nat. Hist.* vi. 113, 116, xii. 33); Pliny (*Nat. Hist.* vi. 93) confounds it with Aria, Areia, Pers. Haraiva, i.e. the district of Herat; but Strabo himself says (xv. 724) that some extended the name to the Persians, Medes, Bactrians and Sogdians, as they all spoke the same language with small dialectic variations (cf. 727 and i. 66, xi. 523).

For the ethnography and history of Iran see PERSIA. (Ed. M.)

**IRBIT**, a town of Russia, in the government of Perm, 110 m. N.E. of Ekaterinburg, and on the Irbit river. Pop. (1860) 3408, (1897) 20,064. It is famous for a great fair, held since 1643, which lasts from the 1st of February to the 1st of March (O.S.), and at which are sold (to an average annual value of over £4,000,000) cottons, woollens, flax and hemp, silks, leather, metals, metallic and other manufactured goods, furs, hides, felt, raw wool and tea.

**IRELAND, JOHN** (1761-1842), English divine and dean of Westminster, was born at Ashburton, Devonshire, on the 8th of September 1761, his father being a butcher in that town. For a short time he worked in a shoemaker's shop. Subsequently he proceeded to Oxford, and in due course took holy orders. Through the interest of the earl of Liverpool he was in 1802 appointed a prebendary of Westminster Abbey, in 1815 he was promoted to the deanery of Westminster, and from 1816 to 1835 he was also rector of Islip, Oxfordshire. In 1825 he gave £4000 for the foundation at Oxford of four "Ireland" scholarships of the value of £30 a year each, "for the promotion of classical learning and taste." He also gave £500 to Westminster school for the establishment of prizes for Latin hexameters. He died at Westminster on the 2nd of September 1842, and was buried in the abbey.

**IRELAND, JOHN** (1838- ), American Roman Catholic prelate, was born at Burnchurch, County Kilkenny, Ireland, on the 11th of September 1838. In 1849 he was taken to the United States by his parents, who settled at St Paul, Minnesota Territory. After being educated in France for the priesthood, he returned to the United States in 1861; he was ordained at St Paul and in the following year he accompanied the 5th Minnesota Volunteer Infantry south as chaplain. Subsequently he became rector of the cathedral at St Paul, and in 1870-1871 represented Bishop Thomas Langdon Grace (1814-1897) at the Vatican council at Rome. In 1875 he was appointed bishop of Nebraska, but at the urgent request of Bishop Grace the appointment was changed so that he might remain at St Paul as bishop-coadjutor with the right of succession; at the same time he was made titular bishop of Maronea. In 1884 he succeeded to the bishopric, and in 1888 he became the first archbishop of the see. His liberal views gave him a wide influence and reputation both within and without the church, and he came to be looked upon as a leader of the "American" as distinguished from the "Roman" party in the clergy. His views were, however, opposed by several leading Catholics; and several of his administrative acts, notably his plan for the partial taking over of control of the parochial schools by the local authorities (known from the town in which it was first attempted, "the Faribault plan"), were strenuously attacked. He was prominently identified with the planting of Catholic communities or colonies in the North-West, with the establishment of the Catholic University at Washington,

and with the Catholic total abstinence movement. The degree of LL.D. was conferred on him by Yale University in 1901. He published *The Church and Modern Society* (1866).

**IRELAND, WILLIAM HENRY** (1777-1835), forger of Shakespearean manuscripts, was born in London in 1777. His father, Samuel Ireland, was an engraver and author, and dealer in rare books and curios. In 1794 young Ireland, with his father, visited Stratford, where he met John Jordan, a local poet who had published a deal of gossip matter about Shakespeare and had even forged the will of the poet's father. Seeing his own father's credulous interest, Ireland conceived the idea of doing a little forgery on his own account. He copied, in ink which had all the signs of age, Shakespeare's style and handwriting, and produced leases, contracts with actors, notes, receipts, a profession of faith, and even a love letter to Anne Hathaway with an enclosed lock of hair, to the delight of his unsuspecting father, and the deception of many scholars who attested their belief in the genuineness of his finds. These he accounted for by inventing an ancestor "William Henry Irelande," to whom they had been bequeathed by Shakespeare in gratitude for rescue from drowning. At last the discovery of a whole new play named *Vortigern* was announced. Sheridan purchased it for Drury Lane Theatre, and an overflowing house assembled on the 2nd of April 1796 to sit in judgment upon it. But away from the glamour of crabbéd handwriting and yellow paper, the feeble dialogue and crude conceptions of the tragedy could not stand the test, and its one representation was greeted with shouts of laughter. Its fate prevented the composition of a series of historical plays, of which *Henry II.* had already been produced by this audacious forger. Samuel Ireland the elder had published in 1795 the *Miscellaneous Papers and Legal Instruments under the Hand and Seal of William Shakespeare; including the Tragedy of King Lear and a small fragment of Hamlet* (dated 1796). He had the fullest belief in their authenticity, but the hostile criticism of Malone and others, and the unsatisfactory account of the source of the papers, made him demand a full disclosure from his son. Harassed by the success of his own deceit, which had carried him far beyond his first intention, Ireland at last confessed his fraud, and published (1796) an *Authentic Account of the Shakespearean MSS.*, and in 1805, a more elaborate *Confession*, entirely exculpating his father and making a full admission. The elder Ireland felt the disgrace very bitterly, and it probably hastened his death, which occurred in July 1800. After the exposure Ireland was forced to abandon both his home and his profession. He wrote several novels of no value, gradually sank into penury, and died on the 17th of April 1835.

The more interesting publications on the Ireland forgeries are: *Inquiry into the authenticity of certain Papers, &c., attributed to Shakespeare*, by Edmond Malone (1796); the elder Ireland's *Vindication of his Conduct* (1796); *An Apology for the Believers in the Shakespeare Papers* (1797); and a *Supplemental Apology* (1799), both by George Chalmers; and pamphlets by Borden, Waldron, Wyatt, Webb and Oulton. *Vortigern* was republished in 1832. The elder Ireland's correspondence with regard to the forgeries is preserved in the British Museum, with numerous specimens of his son's talent. Ireland's career supplied the subject-matter of James Payn's novel *The Talk of the Town* (1885).

**IRELAND**, an island lying west of Great Britain, and forming with it the United Kingdom of Great Britain and Ireland. It extends from 51° 26' to 55° 21' N., and from 5° 25' to 10° 30' W. It is encircled by the Atlantic Ocean, and on the east is separated from Great Britain by narrow shallow seas, towards the north by the North Channel, the width of which at the narrowest part between the Mull of Cantire (Scotland) and Torr Head is only 133 m.; in the centre by the Irish Sea, 130 m. in width, and in the south by St George's Channel, which has a width of 60 m. between Dublin and Holyhead (Wales) and of 47 m. at its southern extremity. The island has the form of an irregular rhomboid, the largest diagonal of which, from Torr Head in the north-east to Mizen Head in the south-west, measures 302 m. The greatest breadth due east and west is 174 m., from Dundrum Bay to Anagh Head, county Mayo; and the average breadth is about 110 m. The total area is 32,531 sq. m.

Ireland is divided territorially into four provinces and thirty-two counties:—(a) *Ulster* (northern division): Counties Antrim, Armagh, Cavan, Donegal, Down, Fermanagh, Londonderry, Monaghan, Tyrone. (b) *Leinster* (eastern midlands and south-east): Counties Carlow, Dublin, Kildare, Kilkenny, King's County, Longford, Louth, Meath, Queen's County, Westmeath, Wexford, Wicklow. (c) *Connaught* (western midlands): Counties Galway, Leitrim, Mayo, Roscommon, Sligo. (d) *Munster* (south-western division): Counties Clare, Cork, Kerry, Limerick, Tipperary, Waterford.

*Physical Geography.*—Ireland stands on the edge of the European "continental shelf." Off the peninsula of Mullet (county Mayo) there are 100 fathoms of water within 25 m. of the coast which overlooks the Atlantic; eastward, northward and southward, in the narrow seas, this depth is never reached. The average height of the island is about 400 ft., but the distribution of height is by no means equal. The island has no spinal range or dominating mountain mass. Instead, a series of small, isolated clusters of mountains, reaching from the coast to an extreme distance of some 70 m. inland, almost surrounds a great central plain which seldom exceeds 250 ft. in elevation. A physical description of Ireland, therefore, falls naturally under three heads—the coasts, the mountain rim and the central plain.

The capital city and port of Dublin lies a little south of the central point of the eastern coast at the head of a bay which marks a sudden change in the coastal formation. Southward from Coasts. its northern horn, the rocky headland of Howth, the coast is generally steep, occasionally sheer, and the mountains of county Wicklow approach it closely. Northward (the direction first to be followed) it is low, sandy and fringed with shoals, for here is one point at which the central plain extends to the coast. This condition obtains from 53° 25' N. until at 54° N. the mountains close down again, and the narrow inlet or fjord of Carlingford Lough separates the abrupt heights of the Carlingford and Mourne Mountains. Then the low and sandy character is resumed; the fine eastward sweep of Dundrum Bay is passed, the coast turns north again, and a narrow channel gives entry to the island-studded lagoon of Strangford Lough. Reaching county Antrim, green wooded hills plunge directly into the sea; the deep Belfast Lough strikes some 10 m. inland, and these conditions obtain nearly to Fair Head, the north-eastern extremity of the island. Here the coast turns westward, changing suddenly to sheer cliffs, where the basaltic formation intrudes its strange regular columns, most finely developed in the famous Giant's Causeway.

The low land surrounding the plain-track of the Baun intervenes between this and the beginning of a coastal formation which is common to the north-western and western coasts. From the oval indentation of Lough Foyle a bluff coast trends north-westward to Malin Head, the northernmost promontory of the island. Thence over the whole southward stretch to Mizen Head in county Cork is found that physical appearance of a cliff-bound coast fretted with deep fjord-like inlets and fringed with many islands, which throughout the world is almost wholly confined to western seaboard. Mountains impinge upon the sea almost over the whole length, sometimes, as in Slieve League (county Donegal), immediately facing it with huge cliffs. Eight dominant inlets appear. Lough Foyle is divided by the Loughs of the coast, the coast of the coast of the coast of the coast. Following the coast southward, Donegal Bay is divided from Galway Bay by the hammer-like projection of county Mayo and Connemara, the square inlet of Clew Bay intervening. At Galway Bay the mountain barrier is broken, where the great central plain strikes down to the sea as it does on the east coast north of Dublin. After the stern coast of county Clare there follow the estuary of the great river Shannon, and then three large inlets striking deep into the mountains of Kerry and Cork—Dingle Bay, Kenmare river and Bantry Bay, separating the prongs of the fork-like south-western projection of the island. The whole of this coast is a low and beautiful one, and may be compared with the west coast of Scotland and even that of Norway, though it has a strong individuality distinct from either; and though for long little known to travellers, it now possesses a number of small watering-places, and is in many parts accessible by railway. The islands though numerous are not as in Scotland and Norway a dominant feature of the coast, being generally small and often mere clusters of reefs. Exceptions, however, are Tory Island and North Aran off the Donegal coast, Achill and Clare off Mayo, the South Arans guarding Galway Bay, the Blasketts and Valencia off the Kerry coast. On many of these desolate rocks, which could have afforded only the barest sustenance, there are remains of the dwelling and churches of early religious settlers who sought solitude here. The settlements on Inishmurru (Sligo), Aranmore in the South Arans, and Scattery in the Shannon estuary, had a fame as retreats of piety and learning far outside Ireland itself, and the significance of a pilgrimage to their sites is not

yet wholly forgotten among the peasantry, while the preservation of their remains has come to be a national trust.

The south coast strikes a mean between the east and the west. It is lower than the west though still bold in many places; the inlets are narrower and less deep, but more easily accessible, as appears from the commercial importance of the harbours of Cork and Waterford. Turning northward to the east of Waterford round Carnore Point, the lagoon-like harbour of Wexford is passed, and then a sweeping, almost unbroken, line continues to Dublin Bay. But this coast, though differing completely from the western, is not lacking in beauty, for, like the Mourne in county Down, the mountains of Wicklow rise close to the sea, and sometimes directly from it.

Every mountain group in Ireland forms an individual mass, isolated by complex systems of valleys in all directions. They seldom exceed 3000 ft. in height, yet generally possess a certain dignity, whether from their commanding position or their bold outline. Every variety of form is seen, from steep flat-topped table-mountains as near Loughs Neagh and Erne, to peaks such as those of the Twelve Pins or Bens of Connemara. Unlike the Scottish Highlands no part of them was capable of sheltering a whole native race in opposition to the advance of civilization, though early customs, tradition and the common use of the Erse language yet survive in some strength in the wilder parts of the west. From the coasts there is almost everywhere easy access to the interior through the mountains by valley roads; and though the plain exists unbroken only in the midlands, its ramifications among the hills are always easy to follow. Plain and lowland of an elevation below 500 ft. occupy nearly four-fifths of the total area; and if the sea were to submerge these, four distinct archipelagos would appear, a northern, eastern, western, and southern. The principal groups, with their highest points, are the Murmes (Slieve Donard, 2796 ft.) and the Wicklow mountains (Lugnaquilla, 3039) on the east; the Sperrins (Sawel, 2240) in the north; the Derryveagh group in the north-west (Errigal, 2466); the many groups or short ranges of Sligo, Mayo and Galway (reaching 1695 ft. in the Twelve Pins of Connemara); in the south-west those of Kerry and Cork, where in Carrantuoill or Carrual (3414) the famous Macgillieuddy peaks which beautify the environs of Killarney include the highest point in the island; and north-east from these, the Galtees of Tipperary (3018) and Slieve Bloom, the farthest inland of the important groups. Nearer the south coast are the Knockmealdown (2609) and Comeragh Mountains (2470) of county Waterford.

It will be realized from the foregoing description that it is impossible to draw accurate boundary lines to the great Irish plain, yet it rightly carries the epithet central because it distinctly divides the northern mountain groups from the southern. The plain is closely correlated with the bogs which are the best known physical characteristic of Ireland, but the centre of Ireland is not wholly bog-land. Rather the bogs of the plain are intersected by strips of low-lying firm ground, and the central plain consists of these green grassy spaces alternating with brown bogs, of which the best known and (with its offshoots) one of the most extensive is the Bog of Allen in the eastern midlands. But the bogs are not confined to the plain. They may be divided into black and red according to the degree of moisture and the vegetable matter which formed them. The black bogs are those of the plain and the deeper valleys, while the red, firmer and less damp, occur on the mountains. The former supply most of the peat, and some of the tree-trunks dug out of them have been found so flexible from immersion that they might be twisted into ropes. Owing to the quantity of tannin they contain, no useful miasma exhalates from the Irish bogs.

The central plain and its offshoots are drained by rivers to all the coasts, but chiefly eastward and westward, and the water-partings in its midst are sometimes impossible to define. The main rivers, however, have generally a mountain source, and according as they are fed from bogs or springs may be differentiated as black and bright streams. In this connexion the frequent use of the name Blackwater is noticeable. The principal rivers are—from the Wicklow Mountains, the Slaney, flowing S. to Wexford harbour, and the Liffey, flowing with a tortuous course N. to the coast. Owing to the quantity of tannin in the central plain and discharging into Drogheda Bay from the mountains of county Down, the Lagan, to Belfast Lough, and the Bann, draining the great Lough Neagh to the northern sea; the Foyle, a collection of streams from the mountains of Tyrone and Donegal, flowing north to Lough Foyle. On the west the rivers are generally short and torrential, excepting the Erne, which drains the two beautiful lagoons of that name in county Fermanagh, and the Shannon, the chief river of Ireland, which, rising in a mountain spring in county Cavan, follows a bow-shaped course to the south and south-west, and draws off the major part of the waters of the plain by tributaries from the east. On the south, the Blackwater intersects the mountains of Kerry and Cork flowing east and then abruptly into estuaries opening south. Lastly, rising in the Slieve Bloom or neighbouring mountains, the Suir, Nore and Barrow flow widely divergent courses to the south to unite in Waterford harbour.

Central  
plain.

Rivers.



The lakes (called loughs—pronounced *locks*) of Ireland are innumerable, and (apart from their formation) are almost all contained in two great regions. (1) The central plain by its nature abounds in loughs—dark, peat-stained pools with low shores. The principal of these lie in county Westmeath, such as Loughs Ennel, Owel and Derravaragh, famed for their trout-fishing in the May-fish season. (2) The Shannon, itself forming several large loughs, as Ellen, Ree and Derg; and the Ene, whose course lies almost wholly within Loughs Gowra, Oughter and the Loughs Erne, irregular of outline and studded with islands—separate this region from the principal lake-region of Ireland, coincident with the province of Connaught. In the north lie Loughs Melvin, close above Donegal Bay, and Gill near Sligo, Lough Gara, draining to the Shannon, and Lough Conn near Ballina (county Mayo), and in the south, the great expanses of Loughs Mask and Corrib, joined by a subterranean channel. To the west of these last, the mountains of Connemara and, to a more marked degree, the narrow plain of bog-land between them and Galway Bay, are sown with small lakes, nearly every hollow of this wild district being filled with water. Apart from these two regions the loughs of Ireland are few but noteworthy. In the south-west the lakes of Killybeg are widely famed for their exquisite scenic setting; in the north-east Lough Neagh has no such claim, but is the largest lake in the British Isles, while in the south-east there are small loughs in some of the picturesque glens of county Wicklow.

**Climate.**—The climate of Ireland is more equable than that of Great Britain as regards both temperature and rainfall. No district in Ireland has a rainfall so heavy as that of large portions of the Highlands of Scotland, or so light as that of several large districts in the east of Great Britain. In January the mean temperature scarcely falls below 40° F. in any part of Ireland, whereas over the larger part of the eastern slope of Great Britain it is some 3° lower; and in July the extremes in Ireland are 59° in the north and 62° in Kilkenny. The range from north to south of Great Britain in the same month is some 10°, but the greater extent of latitude accounts only for a part of this difference, which is mainly occasioned by the physical configuration of the surface of Ireland in its relations to the prevailing moist W.S.W. winds. Ireland presents to these winds no unbroken mountain ridge running north and south, which would result in two climates as distinct as those of the east and west of Ross-shire; but it presents instead only a series of isolated groups, with the result that it is only a few limited districts which enjoy climates approaching in dryness the climates of the whole of the eastern side of Great Britain. (O. J. R. H.).

**Geology.**—Ireland, rising from shallow seas on the margin of the submarine plateau of western Europe, records in its structure the successive changes that the continent itself has undergone. The first broad view of the country shows us a basin-shaped island consisting of a central limestone plain surrounded by mountains; but the diverse modes of origin of these mountains, and the differences in their trend, suggest at once that they represent successive epochs of disturbance. The north-west highlands of Donegal and the Ox Mountains, with their line of folding running north-east and south-west, invite comparison with the great chain of Leinster, but also with the Grampians and the backbone of Scandinavia. The ranges from Kerry to Waterford, on the other hand, truncated by the sea at either end, are clearly parts of an east and west system, the continuation of which may be looked for in South Wales and Belgium. The hills of the north-east are mainly the crests of lava-plateaux, which carry the mind towards Skye and the volcanic province of the Faeroe Islands. The two most important points of contrast between the geology of Ireland and that of England are, the great exposure of Carboniferous rocks in Ireland, Mesozoic strata being almost absent; and, secondly, the presence of volcanic rocks in place of the marine Eocene of England.

The fact that no Cambrian strata have been established by palaeontological evidence in the west of Ireland has made it equally difficult to establish any pre-Cambrian system. The great difference in character, however, between the Silurian strata at Pomeroy in county Tyrone and the adjacent metamorphic series makes it highly probable that the latter masses are truly Archaean. They form an interesting and bleak moorland between Cookstown and Omagh, extending north-eastward to Slieve Gallion in county Londonderry, and consist fundamentally of mica-schist and gneiss, affected by earth-pressures, and invaded by granite near Lough Fee. The axis along which they have been elevated runs north-east and south-west, and on either flank a series of "green rocks" appears, consisting of altered amygdaloidal andesitic lavas, intrusive dolerites, coarse gabbros and diorites, and at Beagh-beg and Creggan in central Tyrone ancient rhyolitic tuffs. Red and grey cherts, which have not so far yielded undoubted organic remains, occur in this series, and it has in consequence been compared with the Arenig rocks of southern Scotland. The granite invades this "green-rock" series at Slieve Gallion and elsewhere, but is itself pre-

Devonian. Even if the volcanic and intrusive basic rocks prove to be Ordovician (Lower Silurian), which is very doubtful, the metamorphic series of the core is clearly distinct, and appears to be "fundamental" so far as Ireland is concerned.

The other metamorphic areas of the north present even greater difficulties, owing to the absence of any overlying strata older than the Old Red Sandstone. Their rocks have been variously held to be Archean, Cambrian and Silurian, and their general trend has undoubtedly been determined by post-Silurian earth-movements. Hence it is useful to speak of them merely as "Dalradian," a convenient term invented by Sir A. Geikie for the metamorphic series of the old kingdom of Dalriada. They come out as mica-schists under the Carboniferous sandstones of northern Antrim, and disappear southward under the basaltic plateaux. The red gneisses near Torr Head probably represent intrusive granite; and this small north-eastern exposure is representative of the Dalradian series which covers so wide a field from central Londonderry to the coast of Donegal. The oldest rocks in this large area are a stratified series of mica-schists, limestones and quartzites, with numerous intrusive sheets of diorite, the whole having been metamorphosed by pressure, with frequent overfolding. Extensive subsequent metamorphism has been produced by the invasion of great masses of granite. Similar rocks come up along the Ox Mountain axis, and occupy the wild west of Mayo and Connemara. The quartzites here form bare white cones and ridges, notably in Errigal and Aghla Mt. in county Donegal, and in the group of the Twelve Bens in county Galway.

Following on these rocks of unknown but obviously high antiquity, we find fossiliferous Ordovician (Lower Silurian) strata near Killybeg, and, in the west, corresponding up to a complete Gotlandian (Upper Silurian) system. Massive conglomerates occur in these series, which are unconformable on the Dalradian rocks of Connemara. In the Wenlock beds of the west of the Dingle promontory there are contemporaneous tuffs and lavas. Here the Ludlow strata are followed by a thick series of barren beds (the Dingle Beds), which have been variously claimed as Upper Silurian and Lower Devonian. No certain representative of the Dingle Beds has been traced elsewhere throughout the south of Ireland, where the Old Red Sandstone succeeds the uplifted Silurian strata with striking regularity. However, in the north-west, the most generally folded before the Old Red Sandstone was laid down, the general trend of the folds being from south-west to north-east. The best example of these folds is the axis of Leinster, its core being occupied by granite which is now exposed continuously for 70 m., forming a moorland from Dublin to New Ross. On either flank the Silurian shales, slates and sandstones, which are very rarely fossiliferous, rise with steep dips. They are often contorted, and near the contact with the granite pass into mica-schists and quartzites. The foothills and lowlands throughout southern Wicklow and almost the whole of the south coast, and the corresponding uplands of the north-west and eastern Kildare, are thus formed of Silurian beds, in which numerous contemporaneous and also intrusive igneous rocks are intercalated, striking like the chain N.E. and S.W. In south-eastern Wexford, in northern Wicklow (from Ashford to Bray), and in the promontory of Howth on Dublin Bay, an apparently earlier series of green and red slates and quartzites forms an important feature. The quartzites, like those of the Dalradian series, weather out in cones, such as the two Sugarloaves south of Bray, or in knob-set ridges, such as the crest of Howth or Carrick Mt. in county Wicklow. In the north, fan-shaped markings known as *Malden* are best detected in this series, but they are also known from Cambrian beds in other countries; in default of other satisfactory fossils, the series of Bray and Howth has long been held to be Cambrian.

All across Ireland, from the Ballyhouna Hills on the Cork border to the southern shore of Belfast Lough, slaty and sandy Silurian beds appear in the axes of the anticlinal folds, surrounded by Old Red Sandstone scarps or Carboniferous Limestone lowlands. These Silurian axes give rise to hummocky regions, where small hills abound, with little relief except to the trend of the axis of elevation. The most important area appears north of the town of Londonderry and extends thence to the coast of Down. In Slieve Glah it reaches a height of 1057 ft. above the sea. Granite is exposed along its axis from near Newry to Slieve Croob, and again appears at Crossodney in county Cavan. These occurrences of granite, with that of Leinster, in connexion with the folding of the Silurian strata, make it highly probable that many of the granites of the Dalradian areas, which have a similar trend and which have invaded the schists so intimately as to form with them a composite gneiss, date also from a post-Silurian epoch of earth-movement. Certain western and northern Silurian conglomerates, however, which are bolder in occurrence in Silurian conglomerates derived from the Dalradian complex.

This group of N.E. and S.W. ridges and hollows, so conspicuous in the present conformation of Donegal, Sligo and Mayo, in the axis of Newry, and in the yet bolder Leinster Chain, was impressed upon the Irish region at the close of Silurian times, and is clearly a part of the "Caledonian" system of folds, which gave to Europe the guiding lines of the Scottish Highlands and of Scandinavia.

On the land-surface thus formed the Devonian lakes gathered, while the rivers poured into them enormous deposits of sand and conglomerate. A large exposure of this Old Red Sandstone stretches

# IRELAND

Scale 1:1,500,000.

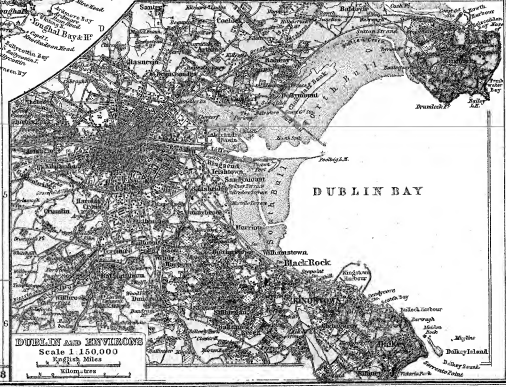
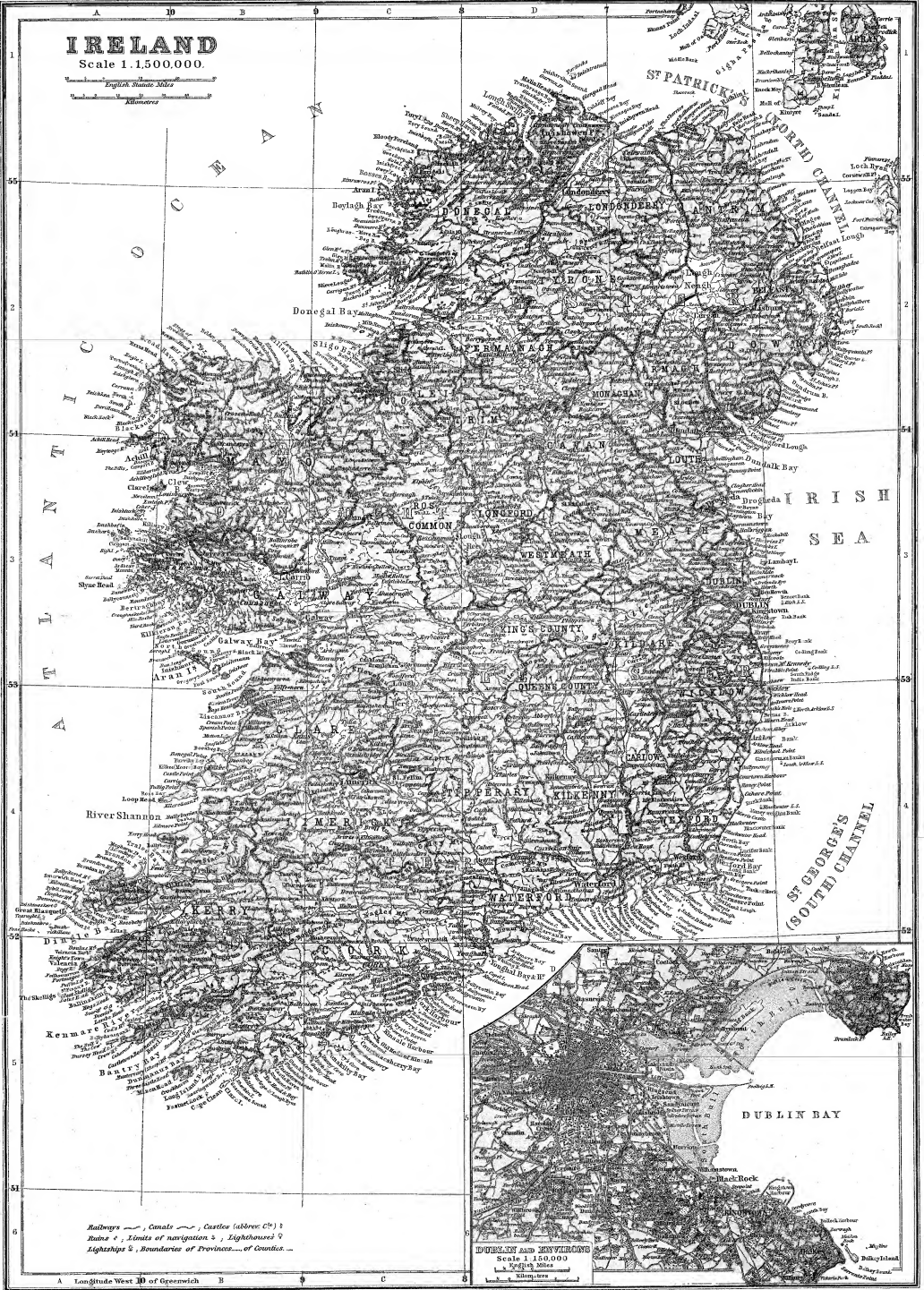

Railways —, Canals —, Castles (abbr. C<sup>o</sup>)  
 Roads +, Limits of navigation +, Lighthouses +  
 Lightships +, Boundaries of Provinces... of Counties...

DUBLIN AND VICINITY  
 Scale 1:150,000  
 1 inch = 2.5 miles  
 1 mile = 1.6 kilometers

from Enniskillen to the Silurian beds at Pomeroy, and some contemporaneous andesites are included, reminding us of the volcanic activity at the same epoch in Scotland. The numerous "felstone" dikes, often lamprophyric, occurring in the north and west of Ireland, are probably also of Devonian age. The conglomerates appear at intervals through the limestone covering of central Ireland, and usually weather out as conspicuous scarps or "hog's-backs." The Slieve Bloom Mountains are thus formed of a dome of Old Red Sandstone folded on a core of unconformable Silurian strata; while in several cases the domes are worn through, leaving rings of Old Red Sandstone hills, scarping inwards towards broad exposures of Silurian shales. The Old Red Sandstone is most fully manifest in the rocky or heather-clad ridges that run from the west of Kerry to central Waterford, rising to 3414 ft. in Carruntuohill in Macgillcuddy's Reeks, and 3015 ft. in Galtymore. In the Dingle Pro-

The Lower Carboniferous Sandstones are conspicuous in the region from Milltown near Inver Bay in southern Donegal to Ballycastle in county Antrim. In the latter place they contain workable coal-seams. The Carboniferous Limestone often contains black flint (chert), and at some horizons conglomerates occur, the pebbles being derived from the unconformable ridges of the "Caledonian" land. A thin shaly type called a "calp" is also present, a thin clay derived from the same land-surface. While the limestone has been mainly worn down to a lowland, it forms fine scarps and tablelands in county Sligo and other western regions. Subterranean rivers and water-worn caves provide a special type of scenery below the surface. Contemporaneous volcanic action is recorded by tufts and lavas south-east of Limerick and north of Philipstown. The beds above the limestone are shales and sandstones, sometimes reaching the true Coal-Measures, but rarely younger than the English Millstone Grit. They are well seen in the high ground about Lough Allen, where the Shannon rises on them, round the Castle-keomer and Killenaule coalfields, and in a broad area from the north of Clare to Killarney. Some coals occur in the Millstone Grit horizons. The Upper Coal-Measures, as a rule, have been lost by denudation, much of which occurred before Triassic times. South of the line between Galway and Dublin the coal is anthracitic, while north of this line it is bituminous. The northern coalfields are the L. Carboniferous one at Ballycastle, the high outliers of Millstone Grit and Coal-Measures round Lough Allen, and the Dunganannon and Coalisland field in county Tyrone. The last named is in part concealed by Triassic strata. The only important occurrences of coal in the south are in eastern Tipperary near Killenaule, and in the Leinster coalfield (counties Kilkenny and Carlow and Queen's County), where there is a high synclinal field, including Lower and Middle Coal-Measures, and resembling in structure the Forest of Dean area in England.

The "Hercynian" earth-movements, which so profoundly affected north-west and north-central Europe at the close of Carboniferous times, gave rise to a series of east and west folds in the Irish region. The Upper Carboniferous beds were thus lifted within easy reach of denuding forces, while the Old Red Sandstone, and the underlying "Caledonian" land-surface, were brought up from below in the cores of domes and anticlines. In the south, even the Carboniferous Limestone has been so far removed that it is found only in the floors of the synclinals. The effect of the structure of these folds on the courses of rivers in the south of Ireland is discussed in the paragraphs dealing with the geology of county Cork. The present central plain itself may be regarded as a vast shallow synclinal, including a multitude of smaller folds. The earth-wrinkles of this epoch were turned into a north-easterly direction by the pre-existing Leinster Chain, and the trend of the synclinal from Limerick to the Slieve Bloom Mountains, and that of the synclinal of Millstone Grit and Coal-Measures from Cashel through the Leinster coalfield, bear witness to the resistance of this granite mass. The Triassic beds rest on the various Carboniferous series in turn, indicating, as in England, the amount of denudation that followed on the uplift of the Hercynian land. Little encouragement can therefore be given in Ireland to the popular belief in vast hidden coalfields.

The Permian sea has left traces at Holywood on Belfast Lough and near Stewartstown in county Tyrone. Certain conglomeratic beds on which Armagh is built are also believed to be of Permian age. The Triassic sandstones and marls, with marine Rhaetic beds above, are preserved mainly round the basaltic plateaus of the north-east, and extend for some distance into county Down. An elongated outlier south of Carricknacross indicates their former presence over a much wider area. Rock-salt occurs in these beds north of Carrickfergus.

The Jurassic system is represented in Ireland by the Lower Lias alone, and it is probable that no marine beds higher than the Upper Lias were deposited during this period. From Permian times onwards, in fact, the sea lay on the west coast of the island, the sea that played so large a part in determining the geology of Europe. The Lower Lias appears at intervals under the scarp of the basaltic plateaus, and contributes, as in Dorsetshire and Devonshire, to the formation of landrips along the coast. The alteration of the fossiliferous Lias by dolerite at Portrush into a flinty rock that looked like basalt served at one time as a prop for the "Neptunist" theory of the origin of igneous rocks. Denudation, consequent on the renewed uplift of the country, affected the Jurassic beds until the middle of Cretaceous times. The sea then returned, in the north-east at any rate, and the first Cretaceous deposits indicate the nearness of a shore-line. Dark green-sands," very rich in glauconite, are followed by yellow sandstones with some flint. These two stages represent the Upper Greensand, or the sandy type of the English Gault. Further sands represent the Cenomanian. The Turonian is also sandy, but in most areas was not deposited, or has been denuded away during a local uplift that preceded Senonian times. The Senonian limestone itself, which rests in the extreme north on Trias or even on the schists, is often conglomeratic and glauconitic at the base, the pebbles being worn from the metamorphic rocks.

The term "Hercynian ocean" was used by Taylor for all the beds below the Senonian; the quarrymen know the conglomeratic Senonian as "Mulatto-stone." The Senonian chalk, or "White Limestone," is hard, with numerous bands of flint, and suffered from denudation in early Eocene times. Probably its original thickness

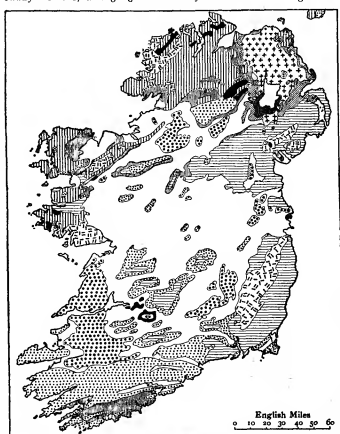

montory the conglomerates of the first period rest with striking unconformity on the Dingle Beds and Upper Silurian series. Here there may be a local break between Lower and Upper Devonian strata. The highest beds of Old Red Sandstone type pass up conformably in the south of Ireland into the Lower Carboniferous, through the "Yellow Sandstone Series" and the "Coomhola Grits" above it. The Yellow Sandstone contains *Archaeonada*, the oldest known fresh-water mollusc, and plant-remains; the Coomhola Grits are marine, and are sometimes regarded as Carboniferous, sometimes as uppermost Devonian.

In the south, the Carboniferous deposits open with the Carboniferous Slate, in the base of which the Coomhola Grits occur. Its lower part represents the Lower Carboniferous Shales and Sandstones of the central and northern areas, while its upper part corresponds with a portion of the Carboniferous Limestone. The Carboniferous Limestone, laid down in a sea which covered nearly the whole Irish area, appears in the synclinal folds at Cork city and Kenmare, and is the prevalent rock from the north side of the Knockmeadown Mountains to Enniskillen and Donegal Bay. On the east it spreads to Drogheda and Dublin, and on the west to the heart of Mayo and of Clare. Loughs Mask and Corry are thus bounded on the west by rugged Silurian and Dalradian highlands, and on the east appear as were water-filled hollows in the great limestone plain.

was not more than 150 ft., while now only from 40 to 100 ft. remain. This chalk appears to underlie nearly the whole basaltic plateaus, appearing as a fringe round them, and also in an inlier at Templepatrick. The western limit was probably found in the edge of the old continental land in Donegal. Chalk flints occur frequently in the surface-deposits of the south of Ireland, associated with rocks brought from the north during the glacial epoch, and probably also of Mesozoic origin. It is just possible, however, that here and there the Cretaceous sea that spread over Devonshire may have penetrated the Irish area.

After the Irish chalk had been worn into rolling downs, on which flint-gravels gathered, the great epoch of volcanic activity opened, which was destined to change the character of the whole north-west European area. The critical time had arrived when the sea was to be driven away eastward, while the immense ridges due to the "Alpine" movements were about to emerge as the backbones of new continental lands. Fissures after fissures, running with remarkable constancy N.W. and S.E., broke through the region now occupied by the British Isles, and basalt was pressed up along these cracks, forming thousands of dikes, from the coast of Down to the Dalriadan ridges of Donegal. One of these on the north side of Lough Erne is 15 m. long. The more deep-seated type of these rocks is seen in the olivine-gabbro mass of Carlingford Mountain; but most of the igneous region became covered with sheets of basaltic lava, which filled up the hollows of the downs, baked the gravels into a layer of red flints, and built up, pile upon pile, the great plateaus of the north. There was little or no volcanic action, and few of the volcanic vents can now be traced. After a time, a quiet interval allowed of the formation of lakes, in which red iron-ores were laid down. The plant-remains associated with these beds form the only clue to the post-Cretaceous period in which the volcanic epoch opened, and they have been placed by Mr Starkie Gardner in recent years as early Eocene. During this time of comparative rest, rhyolites were extruded locally in county Antrim; and there is very strong evidence that the granite of the Mourne Mountains, and that which cuts the Carlingford gabbro, were added at the same time to the crust. The basalt again broke out, through dikes that cut even the Mourne granite, and some of the best-known columnar masses of lava overlie the red deposits of iron-ore and mark this second basaltic epoch. The volcanic plateaus clearly at one time extended far west and south of their present limits, and the denudation of the lava-flows has allowed a large area of Mesozoic strata also to disappear.

Volcanic activity may have extended into Miocene times; but the only fossiliferous relics of Cainozoic periods later than the Eocene are the pale clays and silicified lignites on the south shore of Lough Neagh, and the shelly gravels of pre-glacial age in county Wexford. Both these deposits may be Pliocene. Probably before this period the movements of subsidence had set in which faulted the basalt plateaus, lowered them to form the basin of Lough Neagh, and broke up the continuity of the volcanic land of the North Atlantic area. As the Atlantic spread into the valleys on the west of Ireland, forming the well-known marine inlets, Europe grew, under the influence of the "Alpine" movements, upon the east; and Ireland was caught in, as it were, on the western edge of the new continent. It seems likely that it was separated from the British region shortly before the glacial epoch, and that some of the ice which then abutted on the country travelled across shallow seas. The glacial deposits profoundly modified the surface of the country, whether they resulted from the melting of the ice-sheets of the time of maximum glaciation, or from the more recent local glacial advances and retreats, and the gravels rearranged by water, occur throughout the lowlands; while the eskers or "green hills," characteristic grass-covered ridges of gravel, rise from the great plain, or run athwart valleys and over hill-sides, marking the courses of sub-glacial streams. When the superficial deposits are removed, the underlying rocks are found to be scored and smoothed by ice-action, and whole mountain-sides in the south and west have been similarly moulded during the Glacial epoch. In numerous cases, lakelets have gathered under rocky cirques behind the terminal moraines of the last surviving glaciers.

There is no doubt that at this epoch various movements of elevation and subsidence affected the north-west of Europe, and modern Ireland may have had extensions into warmer regions on the west and south, while the area now left to us was almost buried under ice. In post-glacial times, a subsidence admitted the sea into the Lagan valley and across the eastern shore in several places; but elevation, in the days of early human occupation, brought these last marine deposits to light, and raised the beaches and shore-terraces some 10 to 20 ft. at the coast. At Larne, Greystones, and in the neck between Howth and Dublin, these raised beaches remain conspicuous. To sum up, then, while the main structural features of Ireland were impressed upon her before the opening of the Mesozoic era, her present outline and superficial contours date from an epoch of climatic and geographical change which falls within the human period.

See maps and explanatory memoirs of the *Geological Survey of*

*Ireland* (Dublin); G. Wilkinson, *Practical Geology and Ancient Architecture of Ireland* (London, 1845); R. Kane, *Industrial Resources of Ireland* (2nd ed., Dublin, 1845); G. H. Kinahan, *Manual of the Geology of Ireland* (London, 1878); E. Hull, *Physical Geology and Geography of Ireland* (2nd ed., London, 1891); G. H. Kinahan, *Economic Geology of Ireland* (Dublin, 1889); A. McHenry and W. W. Watts, *Guide to the Collection of Rocks and Fossils, Geol. Survey of Ireland* (2nd ed., Dublin, 1898).

#### ECONOMICS AND ADMINISTRATION

*Population.*—Various computations are in existence of the population of Ireland prior to 1821, in which year the first government census was taken. According to Sir William Petty the number of inhabitants in 1672 was 1,320,000. About a century later the tax-collectors estimated the population at a little over 2,500,000, and in 1791 the same officials calculated that the number had risen to over 4,200,000. The census commissioners returned the population in 1821 as 6,801,827, in 1831 as 7,767,401, and in 1841 as 8,196,597. It is undoubted that a great increase of population set in towards the close of the 18th century and continued during the first 40 years or so of the 19th. This increase was due to a variety of causes—the improvement in the political condition of the country, the creation of leaseholds after the abolition of the 40s. franchise, the productiveness and easy cultivation of the potato, the high prices during the war with France, and probably not least to the natural prolificness of the Irish people. But the census returns of 1851 showed a remarkable alteration—a decrease during the previous decade of over 1,500,000—and since that date, as the following table shows, the continuous decrease in the number of its inhabitants has been the striking feature in the vital statistics of Ireland.

Decrease per cent. of Population 1841-1901.

	1841-1851.	1851-1861.	1861-1871.	1871-1881.	1881-1891.	1891-1901.
Leinster . . .	15-25	12-86	8-11	4-49	6-8	3-5
Munster . . .	22-47	18-53	7-93	4-98	11-8	8-4
Ulster . . . .	15-69	4-85	4-23	5-11	7-07	2-4
Connaught . .	28-81	9-59	7-33	3-43	12-4	9-7
Ireland . . . .	19-85	11-50	6-67	4-69	9-08	5-3

The cause of the continuous though varying decrease which these figures reveal has been emigration. This movement of population took its first great impulse from the famine of 1846 and has continued ever since. When that disaster fell upon the country it found a teeming population fiercely competing for a very narrow margin of subsistence; and so widespread and devastating were its effects that between 1847 and 1852 over 1,200,000 of the Irish people emigrated to other lands. More than 1,000,000 of these went to the United States of America, and to that country the main stream has ever since been directed. Between 1851 and 1905 4,028,589 emigrants left Ireland—2,092,154 males and 1,936,435 females, the proportion of females to males being extraordinarily high as compared with the emigration statistics of other countries. Between these years the numbers fluctuated widely—1852 showing the highest total, 190,322 souls, and 1905 the lowest, 30,676 souls. Since 1892, however, the emigrants in any one year have never exceeded 50,000, probably because the process of exhaustion has been so long in operation. As Ireland is mainly an agricultural country the loss of population has been most marked in the rural districts. The urban population, indeed, has for some years shown a tendency to increase. Thus in 1841 the rural population was returned as 7,052,923 and the urban as 1,143,674, while the corresponding figures in 1901 were respectively 3,073,846 and 1,384,020. This is further borne out by the percentages given in the above table, from which it will be seen that the greatest proportional decrease of population has occurred in the two provinces of Munster and Connaught, which may be regarded as almost purely agricultural. That the United States remained the great centre of attraction for Irish emigrants is proved by the returns for 1905, which show that nearly 80% of the whole number for the year sailed for that country. Ireland does little to swell the rising tide of

emigration that now flows from England and Scotland to British North America.

Turning now to the census figures of 1901, we find that the population had diminished as compared with 1891 by 245,975. During the decade only three counties, Dublin, Down and Antrim, showed any increase, the increase being due to the growth of certain urban areas. Of the total population of 4,458,775, 2,200,040 were males and 2,258,735 were females. The inhabitants of the rural districts (3,073,846) decreased during the decade by over 380,000; that of the urban districts, i.e. of all towns of not less than 2000 inhabitants (1,384,929) increased by over 140,000. This increase was mainly due to the growth of a few of the larger towns, notably of Belfast, the chief industrial centre of Ireland. Between 1891 and 1901 Belfast increased from 273,079 to 349,180; Dublin from 268,587 to 289,108; and Londonderry, another industrial centre in Ulster, from 33,200 to 39,873. On the other hand, towns like Cork (75,978), Waterford (26,743) and Limerick (38,085), remained almost stationary during the ten years, but the urban districts of Pembroke and of Rathmines and Rathgar, which are practically suburbs of Dublin, showed considerable increases.

From the returns of occupation in 1901, it appears that the indefinite or non-productive class accounted for about 55% of the entire population. The next largest class was the agricultural, which numbered 876,062, a decrease of about 40,000 as compared with 1891. The industrial class fell from 656,410 to 639,413, but this represented a slight increase in the percentage of the population. The professional class was 131,035, the domestic 219,418, and the commercial had risen from 83,173 in 1891 to 97,889 in 1901. The following table shows the number of births and deaths registered in Ireland during the five years 1901-1905.

	Births.	Deaths.
1901	100,976	79,119
1902	101,863	77,676
1903	101,831	77,358
1904	103,811	79,513
1905	102,832	75,071

The number of illegitimate births is always very small in proportion to the legitimate. In 1905 illegitimate births numbered 2710 or 2.6 of the whole, a percentage which has been very constant for a number of years.

**Railways.**—The first act of parliament authorizing a railway in Ireland was passed in 1831. The railway was to run from Dublin to Kingstown, a distance of about 6 m., and was opened in 1834. In 1836 the Ulster railway to connect Belfast and Armagh, and the Dublin and Drogheda railway uniting these two towns were sanctioned. In the same year commissioners were nominated by the crown to inquire (*inter alia*) as to a general system for railways in Ireland, and as to the best mode of directing the development of the means of intercourse to the channels whereby the greatest advantage might be obtained by the smallest outlay. The commissioners presented a very valuable report in 1838, but its specific recommendations were never adopted by the government, though they ultimately proved of service to the directors of private enterprises. Railway development in Ireland progressed at first very slowly and by 1845 only some 65 m. of railway were open. During the next ten years, however, there was a considerable advance, and in 1855 the Irish railways extended to almost 1000 m. The total authorized capital of all Irish railways, exclusive of light railways, at the end of 1905 was £42,881,201, and the paid-up capital, including loans and debenture stock, amounted to £37,238,888. The total gross receipts from all sources of traffic in 1905 were £4,043,368, of which £2,104,108 was derived from passenger traffic and £1,798,520 from goods traffic. The total number of passengers carried (exclusive of season and periodical ticket-holders) was 27,950,150. Under the various acts passed to facilitate the construction of light railways in backward districts some 15 lines have been built, principally in the western part of the island from Donegal to Kerry. These railways are worked by existing companies.

The following table shows the principal Irish railways, their mileage and the districts which they serve.

Name of Railway.	Mileage.	Districts Served.
Great Southern & Western	1083	The southern half of Leinster, the whole of Munster, and part of Connaught, the principal towns served being Dublin, Cork, Waterford, Limerick and Sligo.
Midland Great Western	538	The central districts of Ireland and a great part of Connaught, the principal towns served being Dublin, Athlone, Galway and Sligo.
Great Northern	533	The northern half of Leinster and a great part of Ulster, the principal towns served being Dublin, Belfast, Londonderry, Dundalk, Drogheda, Armagh and Lisburn.
Northern Counties <sup>1</sup> (now owned by the Midland Railway of England)	249	The counties of Antrim, Tyrone and Londonderry.
Dublin & South Eastern <sup>2</sup>	161	The counties of Dublin, Wicklow, Wexford and Waterford.
Donegal	106	The counties of Tyrone and Donegal.
Londonderry & Lough Swilly	99	The counties of Londonderry and Donegal.
Cork, Bandon & South Coast	95	The counties of Cork and Kerry.
Belfast & County Down	76	The county of Down.

<sup>1</sup> Formerly Belfast and Northern Counties.

<sup>2</sup> Formerly Dublin, Wicklow and Wexford.

There is no lack of cross-channel services between Ireland and Great Britain. Belfast is connected by daily sailings with Glasgow, Ardrossan, Liverpool, Feetwood, Barrow, and Hesham Harbour, Dublin with Holyhead and Liverpool, Greenore (Co. Down) with Holyhead, Larne (Co. Antrim) with Stranraer, Rosslare (Co. Wexford) with Fishguard and Kingstown (Co. Dublin) with Holyhead.

**Navigable Waterways.**—Ireland is intersected by a network of canals and waterways, which if efficiently managed and developed would prove of immense service to the country by affording a cheap means for the carriage of goods, especially agricultural produce. Two canals—the Grand and the Royal—connect Dublin with the Shannon; the former leading from the south of Dublin to Shannon Harbour and thence on the other side of that river to Ballinasloe, with numerous branches; the latter from the north side of Dublin to Cloodera on the Shannon, with a branch to Longford. The Barrow Navigation connects a branch of the Grand canal with the tidal part of the river Barrow. In Ulster the Bann navigation connects Coleraine, by means of Lough Neagh, with the Lagan navigation which serves Belfast; and the Ulster canal connects Lough Neagh with Lough Erne. The river Shannon is navigable for a distance of 143 m. in a direct course and occupies almost a central position between the east and west coasts.

**Agriculture.**—Ireland possesses as a whole a soil which is naturally fertile and easily cultivated. Strong heavy clay soils, sandy and gravelly soils, are almost entirely absent; and the mixture of soil arising from the various stratifications and from the detritus carried down to the plains has created many districts of remarkable richness. The "Golden Vein" in Munster, which stretches from Cashel in Tipperary to near Limerick; probably forms the most fertile part of the country. The banks of the rivers Shannon, Suir, Nore, Barrow and Bann are lined with long stretches of flat lands capable of producing fine crops. In the districts of the Old and New Red Sandstone, which include the greater part of Cork and portions of Kerry, Waterford, Tyrone, Fermanagh, Monaghan, Mayo and Tipperary, the soil in the hollows is generally remarkably fertile. Even in the mountainous districts which are unsuitable for tillage there is often sufficient soil to yield, with the aid of the moist atmosphere, abundant pasturage of good quality. The excessive moisture in wet seasons in however hostile to cereal crops, especially in the southern and western districts, though improved drainage has

done something to mitigate this evil, and might do a great deal more.

Irish political history has largely affected the condition of agriculture. Confiscations and settlements, prohibitive laws (such as those which ruined the woollen industry), penal enactments against the Roman Catholics, absenteeism, the creation for political purposes of 40s. freeholders, and other factors have combined to form a story which makes painful reading from whatever point of view, social or political, it be regarded. Happily, however, at the beginning of the 20th century Irish agriculture presented two new features which can be described without necessarily arousing any party question—the work of the Department of Agriculture and the spread of the principle of co-operation. Another outstanding feature has been the effect of the Land Purchase Acts in transferring the ownership of the land from the landlords to the tenants. Before dealing with these three features, some general statistics may be given bearing upon the condition of Irish agriculture.

**Number of Holdings.**—Before 1846 the number of small holdings was inordinately large. In 1841, for example, there were no less than 310,436 of between 1 and 5 acres in extent, and 252,799 of between 5 and 15 acres. This condition of affairs was due mainly to two causes—to the 40s. franchise which prevailed between 1793 and 1829, and after that date to the keen competition for land by a rapidly increasing population which had no other source of livelihood than agriculture. But the potato famine and the repeal of the Corn Laws, occurring almost simultaneously, caused an immediate and startling diminution in the number of smaller holdings. In 1851 the number between 1 and 5 acres in extent had fallen to 88,033 and the number between 5 and 15 acres had fallen to 191,854. Simultaneously the number between 15 and 30 acres had increased from 79,342 to 141,311, and the number above 30 acres from 48,625 to 149,090.

Since 1851 these tendencies have not been so marked. Thus in 1905 the number of holdings between 1 and 5 acres was 62,126, the number between 5 and 15 acres 154,560, the number between 15 and 30 acres 134,370 and the number above 30 acres 164,747. Generally speaking, however, it will be seen from the figures that since the middle of the 19th century holdings between 1 and 30 acres have decreased and holdings over 30 acres have increased. Of the total holdings under 30 acres considerably more than one-third are in Ulster, and of the holdings over 30 acres more than one-third are in Munster. The number of holdings of over 500 acres is only 1526, of which 475 are in Connaught. A considerable proportion, however, of these larger holdings, especially in Connaught, consist of more or less waste land, which at the best can only be used for raising a few sheep.

**Tillage and Pasturage.**—The fact that probably about 1,000,000 acres formerly under potatoes went out of cultivation owing to the potato disease in 1847 makes a comparison between the figures for crops in that year with present figures somewhat fallacious. Starting, however, with that year as the most important in Irish economic history in modern times, we find that between 1847 and 1905 the total area under crops—cereals, green crops, flax, meadow and clover—decreased by 582,348 acres. Up to 1861, as the area formerly under potatoes came back gradually into cultivation, the acreage under crops increased; but since that year, when the total crop area was 5,890,536 acres, there has been a steady and gradual decline, the area in 1905 having fallen to 4,656,227 acres. An analysis of the returns shows that the decline has been most marked in the acreage under cereal crops, especially wheat. In 1847 the number of acres under wheat was 743,871 and there has been a steady and practically continuous decrease ever since, the wheat acreage in 1905 being only 37,860 acres. In that year the wheat area, excluding less than 5000 acres in Connaught, was pretty equally divided between the other three provinces. Oats has always been the staple cereal crop in Ireland, but since 1847 its cultivation has declined by over 50%. In that year 2,200,870 acres were under oats and in 1905 only 1,066,906 acres. Nearly one-half of the area under oats is to be found in Ulster; Leinster and Munster are fairly equal; and Connaught has something over 100,000 acres under this crop. The area under barley and rye has also declined during the period under review by about one-half—from 345,070 acres in 1847 to 164,800 in 1905. The growing of these crops is confined almost entirely to Leinster and Munster. Taking all the cereal crops together, their cultivation during the last 60 years has gradually declined (from 3,313,579 acres in 1847 to 1,271,190 in 1905) by over 50%. The area, however, under green crops—potatoes, turnips, mangel-wurzel, beet, cabbage, &c.—shows during the same period a much less marked decline—only some 300,000 acres. There has been a very considerable decrease

since about 1861 in the acreage under potatoes. This is probably due to two causes—the emigration of the poorer classes who subsisted on that form of food, and the gradual introduction of a more varied dietary. The total area under potatoes in 1905 was 616,755 acres as compared with 1,133,504 acres in 1861. Since about 1885 the acreage under turnips has remained fairly stationary in the neighbourhood of 300,000 acres, while the cultivation of mangel-wurzel has considerably increased. Outside the recognized cereal and green crops, two others may be considered, flax and meadow and clover. The cultivation of the former is practically confined to Ulster and as compared with 20 or 30 years ago has fallen off by considerably more than 50% despite the proximity of the linen industry. The number of acres under flax in 1905 was only 46,158. The Department of Agriculture has made efforts to improve and foster its cultivation, but without any marked results as regards increasing the area sown. During the period under review the area under meadow and clover has increased by more than 50%, rising from 1,138,946 acres in 1847 to 2,294,506 in 1905. It would thus appear that a large proportion of the land which has ceased to bear cereal or green crops is now laid down in meadow and clover. The balance has become pasturage, and the total area under grass in Ireland has so largely increased that it now embraces more than one-half of the entire country. This increase of the pastoral lands, with the corresponding decrease of the cropped lands, has been the marked feature of Irish agricultural returns since 1847. It is attributable to three chief reasons, the dearth of labour owing to emigration, the greater fall in prices of produce as compared with live stock, and the natural richness of the Irish pastures. The following table shows the growth of pasturage and the shrinkage of the crop areas since 1860.

Year.	Total Area.	Cultivated Area (Crops and Grass).	Crops (other than Meadow and Clover).	Meadow and Clover.	Grass.
1860	20,284,893	15,453,773	4,375,621	1,594,518	9,483,634
1880	20,327,764	15,340,192	3,171,259	1,909,825	10,259,108
1900	20,333,744	15,222,104	2,493,017	2,165,715	10,563,372
1905	20,350,725	15,232,699	2,410,813	2,224,165	10,597,721

One more table may be given showing the proportional areas under the various kinds of crops, grass, woods and plantations, fallow, bog, waste, &c., over a series of years.

Year.	Cereal Crops.	Green Crops.	Meadow and Clover.	Grass.	Total Agricultural Land.	Woods.	Fallow.	Waste.
1851	15.2	6.7	6.1	43.0	71.0	1.5	1.0	25.7
1880	8.1	5.5	8.1	50.5	72.2	1.7	0.0	22.8
1905	6.3	5.3	11.3	52.1	75.0	1.5	0.0	23.5

**Produce and Live Stock.**—With the decrease of the area under cereal and green crops and the increase of pasturage there has naturally been a serious fall in the amount of agricultural produce and a considerable rise in the number of live stock since the middle of the 19th century. Thus in 1851 the number of cattle was returned as 2,967,461 and in 1905 as 4,645,215, the increase during the intervening period having been pretty gradual and general. Sheep in 1851 numbered 2,122,128 and in 1905 3,749,352, but the increase in this case has not been so continuous, several of the intervening years showing a considerably higher total than 1905, and for a good many years past the number of sheep has tended to decline. The number of pigs has also varied considerably from year to year, 1905 showing an increase of about 150,000 as compared with 1851.

**The Department of Agriculture.**—By an act of 1899 a Department of Agriculture and other industries and technical instruction was established in Ireland. To this department were transferred numerous powers and duties previously exercised by other authorities, including the Department of Science and Art. To assist the department the act also provided for the establishment of a council of agriculture, an agricultural board and a board of technical instruction, specifying the constitution of each of the three bodies. Certain moneys (exceeding £180,000 per annum) were placed by the act at the disposal of the department, provisions were made for their application, and it was enacted that local authorities might contribute funds. The powers and duties of the department are very wide, but under the present section its chief importance lies in its administrative work with regard to agriculture. In the annual reports of the department this work is usually treated under three heads: (1) agricultural instruction, (2) improvement of live stock, and (3) special investigations.

1. The ultimate aim of the department's policy in the matter of agricultural instruction is, as defined by itself, to place within the reach of a large number of young men and young women the means of obtaining in their own country a good technical knowledge of all subjects relating to agriculture, an object which prior to the establishment of the department was for all practical purposes unattainable. Before such a scheme could be put into operation two things had to be done. In the first place, the department had to train teachers of agricultural subjects; and secondly, it had to demonstrate to farmers all over Ireland by a system of itinerant instruction some of the advantages of such technical instruction, in order to induce them to make some sacrifice to obtain a suitable education for their sons and daughters. In order to accomplish the first of these two preliminaries, the department established a Faculty of Agriculture at the Royal College of Science in Dublin, and offered a considerable number of scholarships the competition for which becomes increasingly keen. They also reorganized the Albert Agricultural College at Glasnevin for young men who have neither the time nor the means to attend the highly specialized courses at the Royal College of Science; and the Munster Institute at Cork is now devoted to the instruction of girls in such subjects as butter-making, poultry-keeping, calf-rearing, cooking, laundry-work, sewing and gardening. In addition to these three permanent institutions, local schools and classes have been established in different parts of the country where systematic instruction in technical agriculture is given to young men. In this and in other branches of its work the department is assisted by agricultural committees appointed by the county councils. The number of itinerant instructors is governed entirely by the available supply of qualified men. The services of every available student on completing his course at the Royal College of Science are secured by some county council committee. The work of the itinerant instructors is very varied. They hold classes and carry out field demonstrations and experiments, the results of which are duly published in the department's journal. The department has also endeavoured to encourage the fruit-growing industry in Ireland by the establishment of a horticultural school at Glasnevin, by efforts to secure uniformity in the packing and grading of fruit, by the establishment of experimental fruit-preserving factories, by the planting of orchards on a large scale in a few districts, and by pioneer lectures. As the result of all these efforts there has been an enormous increase in the demand for fruit trees of all kinds.

2. The marked tendency which has been visible for so many years in Ireland for pasturage to increase at the expense of tillage makes the improvement of live-stock a matter of vital importance to all concerned in agriculture. Elaborate schemes applicable to horse-breeding, cattle-breeding and swine-breeding, have been drawn up by the department on the advice of experts, but the working of the schemes is for the most part left to the various county council committees. The benefits arising from these schemes are being more and more realized by farmers, and the department is able to report an increase in the number of pure bred cattle and horses in Ireland.

3. The special investigations carried out by the department naturally vary from year to year, but one of the duties of each instructor in agriculture is to conduct a number of field experiments, mainly on the influence of manures and seeds in the yield of crops. The results of these experiments are issued in the form of leaflets and distributed widely among farmers. One of the most interesting experiments, which may have far-reaching economic effects, has been in the cultivation of tobacco. So far it has been proved (1) that the tobacco plant can be grown successfully in Ireland, and (2) that the crop when blended with American leaf can be manufactured into a mixture suitable for smoking. But whether Irish tobacco can be made a profitable crop depends upon a good many other considerations.

*Agricultural Co-operation.*—In 1894 the efforts of a number of Irishmen drawn from all political parties were successfully directed towards the formation of the Irish Agricultural Organization Society, which has for its object the organizing of groups of farmers on co-operative principles and the provision of instruction in proper technical methods. The society had at first many difficulties to confront, but after the first two or three years of its existence its progress became more rapid, and co-operation became

beyond all question one of the most hopeful features in Irish agriculture.

Perhaps the chief success of the society was seen in the establishment of creameries, which at the end of 1905 numbered 275—123 in Ulster, 102 in Munster, 20 in Leinster and 30 in Connaught. The members numbered over 42,000 and the trade turnover for the year was £1,245,000. Agricultural societies have been established for the purchase of seed, implements, &c., on co-operative lines and of these there are 150, with a membership of some 14,000. The society was also successful in establishing a large number of credit societies, from which farmers can borrow at a low rate of interest. There are also societies for poultry-rearing, rural industries, bee-keeping, bacon-curing, &c., in connexion with the central organization. The system is rounded off by a number of trade federations for the sale and purchase of various commodities. The Department of Agriculture encourages the work of the Organization Society by an annual grant.

*Land Laws.*—The relations of landlord and tenant in Ireland have been a frequent subject of legislation (see *History below*). Under the act of 1881, down to the 31st of March 1906, the rents of 360,135 holdings, representing nearly 11,000,000 acres, had been fixed for the first statutory term of 15 years either by the land commissioners or by agreements between landlords and tenants, the aggregate reduction being over 20% as compared with the old rents. The rents of 120,515 holdings, representing over 3,500,000 acres, had been further fixed for the second statutory term, the aggregate reduction being over 19% as compared with the first term rents. Although the acts of 1870 and 1881 provided facilities for the purchase of holdings by the tenants, it was only after the passing of the Ashbourne Act in 1885 that the transfer of ownership to the occupying tenants began on an extended scale. Under this act between 1885 and 1902, when further proceedings were suspended, the number of loans issued was 25,367 (4221 in Leinster; 5204 in Munster; 12,954 in Ulster, and 2988 in Connaught) and the amount was £9,902,536. Between August 1891 and April 1906, the number of loans issued under the acts of 1891 and 1896 was 49,395 (7838 in Leinster; 7512 in Munster; 14,955 in Ulster, and 10,090 in Connaught) and the amount was £11,573,952. Under the Wyndham Act of 1903 the process was greatly extended.

The following tables give summarized particulars, for the period from the 1st of November 1903 to the 31st of March 1906, of (1) estates for which purchase agreements were lodged in cases of sale direct from landlords to tenants; (2) estates for the purchase of which the Land Commission entered into agreements under sections 6 and 8 of the act; (3) estates in which the offers of the Land Commission to purchase under sect. 7 were accepted by the land judge; and (4) estates for the purchase of which, under sections 72 and 79, originating requests were transmitted by the Congested Districts Board to the Land Commission:—

Classification.	No. of Estates.	No. of Purchasers.	Purchase Money.		
			Price.	Amount of Advances applied for.	Amount of Proposed Cash Payments.
Direct Sales . . . . .	3446	86,898	£32,811,564	£32,692,066	£119,498
Sections 6 and 8 . . . . .	54	3,567 <sup>1</sup>	1,231,014	1,226,832	4,182
Section 7 . . . . .	29	1,174 <sup>1</sup>	383,388	381,722	1,666
Sections 72 and 79 . . . . .	67	5,606 <sup>1</sup>	975,211	975,211	..
Total . . . . .	3596	97,245	£35,401,177	£35,275,811	£125,346

Classification.	No. of Estates.	No. of Purchasers.	Purchase Money.		
			Price.	Amount of Advances made.	Amount of Cash Payments.
Direct Sales 6 and 8 . . . . .	925	16,732	£8,317,063	£8,226,736	£90,327
Section 7 . . . . .	40	3,047	1,048,459	1,047,007	1,452
Sections 72 and 79 . . . . .	29	1,174	383,388	381,722	1,666
Sections 72 and 79 . . . . .	12	763	199,581	199,581	..
Total . . . . .	1006	21,716	£9,948,491	£9,855,046	£93,445

<sup>1</sup> Estimated number of purchasers on resale.

It will be seen from these two tables that though the amount of advances applied for during the period dealt with amounted to over

£35,000,000 the actual advances made were less than £10,000,000. It will be seen further that the act operated almost entirely by means of direct sales by landlords to tenants. Of the total amount advanced up to March 31, 1906, almost one-half was in respect of estates in the province of Leinster, the balance being divided pretty equally between estates in the other three provinces.

**Fisheries.**—The deep-sea and coast fisheries of Ireland form a valuable national asset, which still admits of much development and improvement despite the fact that a considerable number of acts of parliament have been passed to promote and foster the fishing industry. In 1882 the Commissioners of Public Works were given further powers to lend money to fishermen on the recommendation of the inspectors of fisheries; and under an act of 1883 the Land Commission was authorized to pay from time to time such sums, not exceeding in all £250,000, as the Commissioners of Public Works might require, for the creation of a Sea Fishery Fund, such fund to be expended—a sum of about £240,000 has been expended—on the construction and improvement of piers and harbours. Specific acts have also been passed for the establishment and development of oyster, pollan and mussel fisheries. Under the Land Purchase Act 1891, a portion of the Sea Fisheries Fund was reserved for administration by the inspectors of fisheries in non-congested districts. Under this head over £36,000 had been advanced on loan up to December 31, 1905, the greater portion of which had been repaid. In 1900 the powers and duties of the inspectors of fisheries were vested in the Department of Agriculture and Technical Instruction. Under the Marine Works Act 1902, which was intended to benefit and develop industries where the people were suffering from congestion, about £34,000 was expended upon the construction and improvement of fishery harbours in such districts.

For administrative purposes Ireland is divided into 31 deep-sea and coast fisheries and during 1905, 6190 vessels were engaged in these districts, giving employment to a total of 24,288 hands. Excluding salmon, nearly one million hundredweights of fish were taken, and including shell-fish the total money received by the fishermen exceeded £414,000. In the same year 13,436 hands were engaged in the 25 salmon fishing districts into which the country is divided. In addition to the organized industry which exists in these salmon districts, there is a good deal of ordinary rod and line fishing in the higher reaches of the larger rivers and good trout fishing is obtainable in many districts.

**Mining.**—The mineral produce of Ireland is very limited, and its mines and quarries in 1905 gave employment to only about 6000 persons. Coal-fields are found in all the provinces, but in 1905 the total output was less than 100,000 tons and its value at the mines was given as £43,000. Iron ore is worked in Co. Antrim, over 113,000 tons having been produced in 1905. Alum clay or bauxite, from which aluminium is manufactured, is found in the same county. Clays of various kinds, mainly fire and brick clay, are obtained in several places and there are quarries of marble (notably in Connemara), slate, granite, limestone and sandstone, the output of which is considerable. Silver is obtained in small quantities from lead ore in Co. Donegal, and hopes have been entertained of the re-discovery of gold in Co. Wicklow, where regular workings were established about 1796 but were destroyed during the Rebellion.

**Woolen Manufacture.**—At an early period the woolen manufactures of Ireland had won a high reputation and were exported in considerable quantities to foreign countries. Bonifazio Uberti (d. c. 1367) refers in a posthumous poem called *Dita mundi* to the "noble serge" which Ireland sent to Italy, and fine mantles of Irish frieze are mentioned in a list of goods exported from England to Pope Urban VI. In later times, the establishment of a colony from the German Palatinate at Carrick-on-Suir in the reign of James I. served to stimulate the manufacture, but in the succeeding reign the lord-deputy Strafford adopted the policy of fostering the linen trade at the expense of the woolen in order to prevent the latter from competing with English products. An act of the reign of Charles II. prohibited the export of raw wool to foreign countries from Ireland as well as England, while at the same time Ireland was practically excluded by heavy duties from the English markets,

and as the Navigation Act of 1663 did not apply to her the colonial market was also closed against Irish exports. The foreign market, however, was still open, and after the prohibition of the export of Irish cattle to England the Irish farmers turned their attention to the breeding of sheep, with such good effect that the woolen manufacture increased with great rapidity. Moreover the improved quality of the wool showed itself in the improvement of the finished article, to the great alarm of the English manufacturer. So much trade jealousy was aroused that both Houses of Parliament petitioned William III. to interfere. In accordance with his wishes the Irish parliament in 1698 placed heavy additional duties on all woolen clothing (except friezes) exported from Ireland, and in 1699 the English Parliament passed an act prohibiting the export from Ireland of all woolen goods to any country except England, to any port of England except six, and from any town in Ireland except six. The cumulative effect of these acts was practically to annihilate the woolen manufacture in Ireland and to reduce whole districts and towns, in which thousands of persons were directly or indirectly supported by the industry, to the last verge of poverty. According to Newenham's tables the annual average of new drapery exported from Ireland for the three years ending March 1702 was only 20 pieces, while the export of woolen yarn, worsted yarn and wool, which to England was free, amounted to 349,410 stones. In his essay on the Trade of Ireland, published in 1770, Arthur Dobbs estimated the medium exports of wool, worsted and woolen yarn at 227,049 stones, and he valued the export of n manufactured woolen goods at only £2353. On the other hand, the imports steadily rose. Between 1779 and 1782 the various acts which had hampered the Irish woolen trade were either repealed or modified, but after a brief period of deceptive prosperity followed by failure and distress, the expansion of the trade was limited to the partial supply of the home market. According to evidence laid before the House of Commons in 1822 one-third of the woolen cloth used in Ireland was imported from England. A return presented to Parliament in 1837 stated that the number of woolen or worsted factories in Ireland was 46, employing 1321 hands. In 1879 the number of factories was 76 and the number of hands 2022. Since then the industry has shown some tendency to increase, though the number of persons employed is still comparatively very small, some 3500 hands.

**Linen Manufacture.**—Flax was cultivated at a very early period in Ireland and was both spun into thread and manufactured into cloth. In the time of Henry VIII. the manufacture constituted one of the principal branches of Irish trade, but it did not prove a very serious rival to the woolen industry until the policy of England was directed to the discouragement of the latter. Strafford, lord-deputy in the reign of Charles I., did much to foster the linen industry. He invested a large sum of his own money in it, imported great quantities of flax seed from Holland and induced skilled workmen from France and the Netherlands to settle in Ireland. A similar policy was pursued with even more energy by his successor in office, the duke of Ormonde, at whose instigation an Irish act was passed in 1665 to encourage the growth of flax and the manufacture of linen. He also established factories and brought over families from Brabant and France to work in them. The English parliament in their desire to encourage the linen industry at the expense of the woolen, followed Ormonde's lead by passing an act inviting foreign workmen to settle in Ireland, and admitting all articles made of flax or hemp into England free of duty. In 1710, in accordance with an arrangement made between the two kingdoms, a board of trustees was appointed to whom a considerable sum was granted annually for the promotion of the linen manufacture; but the jealousy of English merchants interposed to check the industry whenever it threatened to assume proportions which might interfere with their own trade, and by an act of George II. a tax was imposed on Irish sail-cloth imported into England, which for the time practically ruined the hempen manufacture. Between 1700 and 1777 the board of trustees expended nearly £850,000 on the promotion of the linen trade,



and in addition parliamentary bounties were paid on a considerable scale. In 1727 Arthur Dobbs estimated the value of the whole manufacture at £1,000,000. In 1830 the Linen Board ceased to exist, the trade having been for some time in a very depressed condition owing to the importation of machine-made yarns from Scotland and England. A year or two later, however, machinery was introduced on a large scale on the river Bann. The experiment proved highly successful, and from this period may be dated the rise of the linen trade of Ulster, the only great industrial manufacture of which Ireland can boast. Belfast is the centre and market of the trade, but mills and factories are to be found dotted all over the eastern counties of Ulster.

In 1850 the number of spindles was 396,338 and of power looms 58; in 1905 the corresponding figures were 826,528 and 34,498. In 1850 the number of persons employed in flax mills and factories was 21,121; in 1901 the number in flax, hemp and jute textile factories was 64,802.

**Cotton Manufacture.**—This was introduced into Ireland in 1777 and under the protection of import duties and bounties increased so rapidly that in 1800 it gave employment to several thousand persons, chiefly in the neighbourhood of Belfast. The trade continued to grow for several years despite the removal of the duties; and the value of cotton goods exported from Ireland to Great Britain rose from £708 in 1814 to £347,606 in 1823. In 1822 the number of hands employed in the industry was stated to be over 17,000. The introduction of machinery, however, which led to the rise of the great cotton industry of Lancashire, had very prejudicial effects, and by 1839 the number of persons employed had fallen to 4622. The trade has dwindled ever since and is now quite insignificant.

**Silk Manufacture.**—About the end of the 17th century French Huguenots settled in Dublin and started the manufacture of Irish poplin, a mixture of silk and wool. In 1823 between 3000 and 4000 persons were employed. But with the abolition of the protective duties in 1826 a decline set in; and though Irish poplin is still celebrated, the industry now gives employment to a mere handful of people in Dublin.

**Distilling and Brewing.**—Whisky has been extensively distilled in Ireland for several centuries. An excise duty was first imposed in 1661, the rate charged being 4d. a gallon. The imposition of a duty gave rise to a large amount of illicit distillation, a practice which still prevails to some extent, though efficient police methods have largely reduced it. During recent years the amount of whisky produced has shown a tendency to decrease. In 1900 the number of gallons charged with duty was 9,589,571, in 1903 8,215,355, and in 1906 7,337,928. There are breweries in most of the larger Irish towns, and Dublin is celebrated for the porter produced by the firm of Arthur Guinness & Son, the largest establishment of the kind in the world. The number of barrels of beer—the inclusive term used by the Inland Revenue Department—charged with duty in 1906 was 3,275,309, showing an increase of over 200,000 as compared with 1900.

The following table shows the net annual amount of excise duties received in Ireland in a series of years:—

Articles.	1900.	1902.	1904.	1906.
Beer . . . . .	£983,841	£1,200,711	£1,262,186	£1,227,528
Licences . . . . .	209,577	213,092	213,994	214,247
Spirits . . . . .	4,952,061	4,292,286	4,311,763	3,952,509
Other sources . . . . .	502	436	508	798
Total . . . . .	£6,145,981	£5,706,525	£5,788,421	£5,395,082

**Other Industries.**—Shipbuilding is practically confined to Belfast, where the firm of Harland and Wolff, the builders of the great "White Star" liners, have one of the largest yards in the world, giving employment to several thousand hands. There are extensive engineering works in the same city which supply the machinery and other requirements of the linen industry. Paper is manufactured on a considerable scale in various places, and Balbriggan is celebrated for its hosiery.

**Commerce and Shipping.**—From allusions in ancient writers it would appear that in early times Ireland had a considerable commercial intercourse with various parts of Europe. When the

merchants of Dublin fled from their city at the time of the Anglo-Norman invasion it was given by Henry II. to merchants from Bristol, to whom free trade with other portions of the kingdom was granted as well as other advantages. In the Staple Act of Edward III., Dublin, Waterford, Cork and Drogheda are mentioned as among the towns where staple goods could be purchased by foreign merchants. During the 15th century the trade of these and other towns increased rapidly. With the 17th century began the restrictions on Irish trade. In 1637 duties were imposed on the chief commodities to foreign nations not in league with England. Ireland was left out of the Navigation Act of 1663 and in the same year was prohibited from exporting cattle to England in any month previous to July. Sir William Petty estimated the value of Irish exports in 1672 at £500,000 per annum, and owing principally to the prosperity of the woollen industry these had risen in value in 1698 to £996,000, the imports in the same year amounting to £576,000. A rapid fall in exports followed upon the prohibition of the export of woollen manufactures to foreign countries, but in about 20 years' time a recovery took place, due in part to the increase of the linen trade. Statistics of exports and imports were compiled for various years by writers like Newenham, Arthur Young and C'esar Moreau, but these are vitiated by being given in Irish currency which was altered from time to time, and by the fact that the method of rating at the custom-house also varied. Taking the figures, however, for what they are worth, it appears that between 1701 and 1710 the average annual exports from Ireland to all parts of the world were valued at £553,000 (to Great Britain, £242,000) and the average annual imports at £513,000 (from Great Britain, £242,000). Between 1751 and 1760 the annual values had risen for exports to £2,002,000 (to Great Britain, £1,068,000) and for imports to £1,594,000 (from Great Britain, £734,000). Between 1794 and 1803 the figures had further risen to £4,310,000 (to Great Britain, £3,667,000) and £4,572,000 (from Great Britain £3,404,000). It is clear, therefore, that during the 18th century the increase of commerce was considerable.

In 1825 the shipping duties on the cross-Channel trade were abolished and since that date no official figures are available as to a large part of Irish trade with Great Britain. The export of cattle and other animals, however, is the most important part of this trade and details of this appear in the following table:—

Year.	Cattle.	Sheep.	Swine.	Total.
1891	630,802	893,175	505,584	2,029,561
1900	745,519	862,263	715,202	2,322,984
1905	749,131	700,626	363,973	1,813,730

The value of the animals exported in 1905 was estimated (at certain standard rates) at about £14,000,000.

Since 1870 the Board of Trade has ceased to give returns of the foreign and colonial trade for each of the separate kingdoms of England, Scotland and Ireland. Returns are given, however, for the principal ports of each kingdom. Between 1886 and 1905 these imports at the Irish ports rose from £6,802,000 in value to £12,394,000 and the exports from £825,000 to £1,887,000.

The following table shows the value of the total imports and exports of merchandise in the foreign and colonial trade at the ports of Dublin, Belfast and Limerick in each of the years 1901-1905:—

Ports.	1901.	1902.	1903.	1904.	1905.
Dublin—	£	£	£	£	£
Imports	2,666,000	2,856,000	3,138,000	2,771,000	2,664,000
Exports	54,000	63,000	122,000	79,000	78,000
Belfast—					
Imports	6,626,000	6,999,000	7,773,000	7,033,000	6,671,000
Exports	1,442,000	1,344,000	1,122,000	1,332,000	1,780,000
Cork—					
Imports	1,062,000	1,114,000	1,193,000	1,156,000	1,010,000
Exports	15,000	17,000	6,000	8,000	5,000
Limerick—					
Imports	826,000	913,000	855,000	935,000	854,000
Exports	2,000	400	3,000	600	3,000

The Department of Agriculture published in 1906 a report on the imports and exports at Irish ports for the year 1904. In this report,

the compiling of which presented great difficulties in the absence of official returns, are included (1) the direct trade between Ireland and all countries outside of Great Britain, (2) the indirect trade of Ireland with those same countries via Great Britain, and (3) the local trade between Ireland and Great Britain. The value of imports in 1904 is put at £55,148,206, and of exports at £46,606,432. But it is pointed out in the report that while the returns as regards farm produce, food stuffs, and raw materials may be considered approximately complete, the information as to manufactured goods—especially of the more valuable grades—is rough and inadequate. It was estimated that the aggregate value of the actual import and export trade in 1904 probably exceeded a total of £105,000,000. The following table gives some details:—

	Imports.	Exports.
I. Farm Produce, Food and Drink Stuffs—		
(a) Live-stock, meat, bacon, fish and dairy produce	£3,028,179	£23,445,122
(b) Crops, fruit, meal, flour, &c.	11,859,201	1,721,753
(c) Spirits, porter, ale, &c.	919,161	4,222,194
(d) Tea, coffee, tobacco, spices, &c.	4,230,478	1,121,267
II. Raw Materials—		
(a) Coal	2,663,523	
(b) Wood	1,880,095	235,479
(c) Mineral	1,012,822	282,081
(d) Animal and vegetable products	4,529,002	3,067,398
III. Goods, partly manufactured of simple manufacture	7,996,143	2,576,993
IV. Manufactured goods	17,059,611	9,934,145

From the figures given in the report it would appear that there was in 1904 an excess of imports amounting to over £8,500,000. But owing to the imperfect state of existing information, it is impossible to say with any certainty what is the real state of the balance of visible trade between Ireland and other countries.

Shipping returns also throw some light upon the commercial condition of Ireland. Old figures are not of much value, but it may be stated that Arthur Dobbs gives the number of ships engaged in the Irish trade in 1721 at 334 with a tonnage of 158,414. According to the statistics of César Moreau the number of ships belonging to Irish ports in 1788 was 1016 with a tonnage of over 60,000, and in 1826 they had increased, according to the trade and navigation returns, to 1391 with a tonnage of over 90,000. In 1905 the vessels registered at Irish ports numbered 934 with a tonnage of over 250,000. In the same year the vessels entering and clearing in the colonial and foreign trade numbered 1199 with a tonnage of over 1,086,000, and the vessels entering and clearing in the trade between Great Britain and Ireland numbered 41,983 with a tonnage of over 9,776,000.

**Government, &c.**—The executive government of Ireland is vested in a lord-lieutenant, assisted by a privy council and by a chief secretary, who is always a member of the House of Commons and generally of the cabinet. There are a large number of administrative departments and boards, some, like the Board of Trade, discharging the same duties as the similar department in England; others, like the Congested Districts Board, dealing with matters of purely Irish concern.

**Parliamentary Representation.**—The Redistribution of Seats Act 1885 entirely altered the parliamentary representation of Ireland. Twenty-two small boroughs were disfranchised. The towns of Galway, Limerick and Waterford lost one member each, while Dublin and Belfast were respectively divided into four divisions, each returning one member. As a result of these changes 85 members now represent the counties, 16 the boroughs, and 2 Dublin University—a total of 103. The total number of electors (exclusive of Dublin University) in 1906 was 686,661; 113,509 for the boroughs and 573,066 for the counties. Ireland is represented in the House of Lords by 28 temporal peers elected for life from among the Irish peers.

**Local Government.**—Irish local government was entirely remodelled by the Local Government (Ireland) Act 1898, which conferred on Ireland the same system and measure of self-government enjoyed by Great Britain. The administrative and fiscal duties previously exercised by the grand jury in each county were transferred to a county council, new administrative counties being formed for the purposes of the act, in some cases by the alteration of existing boundaries. To the county councils were also assigned the power of assessing and levying the poor rate in rural districts, the management of lunatic asylums, and the

administration of certain acts such as the Explosives Act, the Technical Education Act and the Diseases of Animals Act. Subordinate district councils, urban and rural, were also established as in England and Scotland to manage the various local areas within each county. The provisions made for the administration of the Poor Law by the act under consideration are very complicated, but roughly it may be said that it was handed over to these new subordinate local bodies. Six towns—Dublin, Belfast, Cork, Limerick, Londonderry and Waterford—were constituted county boroughs governed by separate county councils; and five boroughs—Kilkenny, Sligo, Clonmel, Drogheda and Wexford—retained their former corporations. The act provides facilities for the conversion into urban districts of (1) towns having town commissioners who are not sanitary authorities and (2) non-municipal towns with populations of over 1500 and entitled to petition for town commissioners.

**Justice.**—The Supreme Court of Judicature is constituted as follows: the court of appeal, which consists of the lord chancellor, the lord chief justice, and the master of the rolls and the chief baron of the exchequer as *ex-officio* members, and two lords justices of appeal; and the high court of justice which includes (1) the chancery division, composed of the lord chancellor, the master of the rolls and two justices, (2) the king's bench division composed of the lord chief justice, the chief baron of the exchequer and eight justices, and (3) the land commissions with two judicial commissioners. At the first vacancy the title and rank of chief baron of the exchequer will be abolished and the office reduced to a puisne judgeship. By the County Officers and Courts (Ireland) Act 1877, it was provided that the chairmen of quarter sessions should be called "county court judges and chairmen of quarter sessions" and that their number should be reduced to twenty-one, which was to include the recorders of Dublin, Belfast, Cork, Londonderry and Galway. At the same time the jurisdiction of the county courts was largely extended. There are 66 resident (stipendiary) magistrates, and four police magistrates in Dublin.

**Police.**—The Royal Irish Constabulary were established in 1822 and consisted at first of 5000 men under an inspector-general for each of the four provinces. In 1836 the entire force was amalgamated under one inspector-general. The force at present consists of about 10,000 men of all ranks, and costs over £1,300,000 a year. Dublin has a separate metropolitan police force.

**Crime.**—The following table shows the number of persons committed for trial, convicted and acquitted in Ireland in 1886, 1891, 1900 and 1905:—

Year.	Committed.	Convicted.	Acquitted.
1886	3,028	1,619	1286
1891	2,112	1,255	669
1900	1,682	1,087	331
1905	2,060	1,367	417

Of the 1367 convicted in 1905, 375 were charged with offences against the person, 205 with offences against property with violence, 545 with offences against property without violence, 52 with malicious injury to property, 44 with forgery and offences against the currency, and 146 with other offences. In 1904, 81,775 cases of drunkenness were brought before Irish magistrates as compared with 227,403 in England and 43,580 in Scotland.

**Poor Law.**—The following table gives the numbers in receipt of indoor and outdoor relief (exclusive of persons in institutions for the blind, deaf and dumb, and for idiots and imbeciles) in the years 1902-1905, together with the total expenditure for relief of the poor:—

Year.	Aggregate number relieved during the year.			Total Annual Expenditure.
	Indoor.	Outdoor.	Total.	
1902	353,483	105,501	468,984	£1,026,691
1903	363,091	90,150	453,241	986,301
1904	390,047	98,607	488,654	1,033,168
1905	434,117	124,697	558,814	1,066,733

The average daily number in receipt of relief of all kinds (except outdoor relief) during the same years was as follows: 1902, 41,163; 1903, 43,600; 1904, 43,721; 1905, 43,911. The percentage of indoor paupers to the estimated population in 1905 was 1.00.

**Congested Districts Board.**—This body was constituted by the Purchase of Land Act 1891, and is composed of the chief secretary, a member of the Land Commission and five other members. A considerable sum of money was placed at its disposal for carrying out the objects for which it was created. It was provided that where more than 20% of the population of a county lived in electoral divisions of which the total rateable value, when divided by the number of the population, gave a sum of less than £1, 10s. for each individual, these divisions should, for the purposes of the act, form a separate county, called a congested districts county, and should be subject to the operations of the board. In order to improve the condition of affairs in congested districts, the board was empowered (1) to amalgamate small holdings either by directly aiding migration or emigration of occupiers, or by recommending the Land Commission to facilitate amalgamation, and (2) generally to aid and develop out of its resources agriculture, forestry, the breeding of live-stock, weaving, spinning, fishing and any other suitable industries. Further provisions regulating the operations of funds of the board were enacted in 1893, 1896, 1899 and 1903; and by its constituting act the Department of Agriculture was empowered to exercise, at the request of the board, any of its powers and duties in congested districts.

**Religion.**—The great majority of the Irish people belong to the Roman Catholic Church. In 1801 the Roman Catholics numbered 3,547,307 or 75% of the total population, and in 1901 they numbered 3,308,661 or 74%. The adherents of the Church of Ireland came next in number (581,089 in 1901 or 13% of the population), then the Presbyterians (443,276 in 1901 or 10% of the population), the only other denomination with a considerable number of members being the Methodists (62,006 in 1901). As the result of emigration, which drains the Roman Catholic portion of the population more than any other, the Roman Catholics show a larger proportional decline in numbers than the Protestants; for example, between 1801 and 1901 the Roman Catholics decreased by over 6%, the Church of Ireland by a little over 3%, the Presbyterians by less than 1%, while the Methodists actually increased by some 11%. The only counties in which the Protestant religion predominates are Antrim, Down, Armagh and Londonderry.

The Roman Catholic Church is governed in Ireland by 4 archbishops, whose sees are in Armagh, Dublin, Cashel and Tuam, and 23 bishops, all nominated by the pope. The episcopal emoluments arise from the mensal parishes, the incumbency of which is retained by the bishops, from licences and from an annual contribution, varying in amount, paid by the clergy of the diocese. The clergy are supported by fees and the voluntary contributions of their flocks. At the census of 1901 there were 1084 parishes, and the clergy numbered 3711. In addition to the secular clergy there are several communities of regular priests scattered over the country, ministering in their own churches but without parochial jurisdiction. There are also numerous monasteries and convents, a large number of which are devoted to educational purposes. The great majority of the secular clergy are educated at Maynooth College (see below).

The Protestants of Ireland belong mainly to the Church of Ireland (episcopalian) and the Presbyterian Church. (For the former see IRELAND, CHURCH OF).

The Presbyterian Church, whose adherents are found principally in Ulster and are the descendants of Scotch settlers, was originally formed in the middle of the 17th century, and in 1840 a reunion took place of the two divisions into which the Church had formerly separated. The governing body is the General Assembly, consisting of ministers and laymen. In 1906 there were 359 congregations, arranged under 36 presbyteries, with 647 ministers. The ministers are supported by a sustentation fund formed of voluntary contributions, the rents of seats and pews, and the proceeds of the commutation of the Regium Donum made by the commissioners under the Irish Church Act 1869. Two colleges are connected with the denomination, the General Assembly's College, Belfast, and the Magee College, Londonderry. In 1881 the faculty of the Belfast College and the theological professors of the Magee College were incorporated and constituted as a faculty with the power of granting degrees in divinity.

The Methodist Church in Ireland was formed in 1878 by the

Union of the Wesleyan with the Primitive Wesleyan Methodists. The number of ministers is over 250.

**Education.**—The following table shows that the proportion per cent of the total population of five years old and upwards able to read and write has been steadily rising since 1861:—

	Proportion per cent.				
	1861.	1871.	1881.	1891.	1901.
Read and write . . . . .	41	49	59	71	79
Read only . . . . .	20	17	16	11	7
Neither read nor write . . . . .	39	33	25	18	14

Further details on the same subject, according to provinces and religious denominations in 1901, are subjoined:—

	Leinster.	Munster.	Ulster.	Connaught.
<b>Roman Catholics—</b>				
Read and write . . . . .	80	80	70	72
Read only . . . . .	7	5	11	7
Neither read nor write . . . . .	13	15	19	21
<b>Protestant Episcopalians—</b>				
Read and write . . . . .	95	95	81	93
Read only . . . . .	1	2	9	3
Neither read nor write . . . . .	4	3	10	4
<b>Presbyterians—</b>				
Read and write . . . . .	97	96	88	95
Read only . . . . .	1	2	7	3
Neither read nor write . . . . .	2	2	5	2
<b>Methodists—</b>				
Read and write . . . . .	97	97	90	96
Read only . . . . .	1	1	5	2
Neither read nor write . . . . .	2	2	5	2
<b>Others—</b>				
Read and write . . . . .	91	91	90	94
Read only . . . . .	2	2	6	1
Neither read nor write . . . . .	7	7	4	5
<b>Total—</b>				
Read and write . . . . .	83	81	79	72
Read only . . . . .	6	5	9	7
Neither read nor write . . . . .	11	14	12	21

**Language.**—The number of persons who speak Irish only continues to decrease. In 1881 they numbered 64,167; in 1891, 38,102; and in 1901, 20,953. If to those who spoke Irish only are added the persons who could speak both Irish and English, the total number who could speak Irish in 1901 was 641,142 or about 14% of the population. The purely Irish-speaking population is to be found principally in the province of Connaught, where in 1901 they numbered over 12,000. The efforts of the Gaelic League, founded to encourage the study of Gaelic literature and the Irish language, produced results seen in the census returns for 1901, which showed that the pupils learning Irish had very largely increased as compared with 1891.

The university of Dublin (*q.v.*), which is for practical purposes identical with Trinity College, Dublin, was incorporated in 1591. The government is in the hands of a board consisting of the provost and the senior fellows, assisted by a council in the election of professors and in the regulation of studies. The council is composed of the provost (and, in his absence, the vice-provost) and elected members. There is also a senate, composed of the chancellor or vice-chancellor and all doctors and masters who have kept their names on the books of Trinity College. Religious tests were abolished in 1873, and the university is now open to all; but, as a matter of fact, the vast majority of the students, even since the abolition of tests, have always belonged to the Church of Ireland, and the divinity school is purely Protestant.

In pursuance of the University Education (Ireland) Act 1879, the Queen's University in Ireland was superseded in 1882 by the Royal University of Ireland, it being provided that the graduates and students of the former should have similar rank in the new university. The government of the Royal University was vested in a senate consisting of a chancellor and senators, with power to grant all such degrees as could be conferred by any university in the United Kingdom, except in theology. Female students had exactly the same rights as male students. The university was simply an examining body, no residence in any college nor attendance at lectures being obligatory. All

appointments to the senate and to fellowships were made on the principle that one half of those appointed should be Roman Catholics and the other half Protestants; and in such subjects as history and philosophy there were two courses of study prescribed, one for Roman Catholics and the other for Protestants. In 1905 the number who matriculated was 947, of whom 218 were females, and the number of students who passed the academic examinations was 2190. The university buildings are in Dublin and the fellows were mostly professors in the various colleges whose students were undergraduates.

The three Queen's Colleges, at Belfast, Cork and Galway, were founded in 1849 and until 1882 formed the Queen's University. Their curriculum comprised all the usual courses of instruction, except theology. They were open to all denominations, but, as might be expected, the Belfast college (dissolved under the Irish Universities Act 1908; see below) was almost entirely Protestant. Its situation in a great industrial centre also made it the most important and flourishing of the three, its students numbering over 400. It possessed an excellent medical school, which was largely increased owing to private benefactions.

The Irish Universities Act 1908 provided for the foundation of two new universities, having their seats respectively at Dublin and at Belfast. The Royal University of Ireland at Dublin and the Queen's College, Belfast, were dissolved. Provision was made for a new college to be founded at Dublin. This college and the existing Queen's Colleges at Cork and Galway were made constituent colleges of the new university at Dublin. Letters patent dated December 2, 1908, granted charters to these foundations under the titles of the National University of Ireland (Dublin), the Queen's University of Belfast and the University Colleges of Dublin, Cork and Galway. It was provided by the act that no test of religious belief should be imposed on any person as a condition of his holding any position in any foundation under the act. A body of commissioners was appointed for each of the new foundations to draw up statutes for its government; and for the purpose of dealing with any matter calling for joint action, a joint commission, half from each of the above commissions, was established. Regulations as to grants-in-aid were made by the act, with the stipulation that no sum from them should be devoted to the provision or maintenance of any building, or tutorial or other office, for religious purposes, though private benefaction for such purposes is not prohibited. Provisions were also made as to the transfer of graduates and students, so that they might occupy under the new régime positions equivalent to those which they occupied previously, in respect both of degrees and the keeping of terms. The commissioners were directed to work out schemes for the employment of officers already employed in the institutions affected by the new arrangements, and for the compensation of those whose employment could not be continued. A committee of the privy council in Ireland was appointed, to be styled the Irish Universities Committee.

The Roman Catholic University College in Dublin may be described as a survival of the Roman Catholic University, a voluntary institution founded in 1854. In 1882 the Roman Catholic bishops placed the buildings belonging to the university under the control and direction of the archbishop of Dublin, who undertook to maintain a college in which education would be given according to the regulations of the Royal University. In 1883 the direction of the college was entrusted to the Jesuits. Although the college receives no grant from public funds, it has proved very successful and attracts a considerable number of students, the great majority of whom belong to the Church of Rome.

The Royal College of Science was established in Dublin in 1867 under the authority of the Science and Art Department, London. Its object is to supply a complete course of instruction in science as applicable to the industrial arts. In 1900 the college was transferred from the Science and Art Department to the Department of Agriculture and Technical Instruction.

Maynooth (q.v.) College was founded by an Irish act of

parliament in 1795 for the training of Roman Catholic students for the Irish priesthood. By an act of 1844 it was permanently endowed by a grant from the consolidated fund of over £26,000 a year. This grant was withdrawn by the Irish Church Act 1869, the college receiving as compensation a lump sum of over £372,000. The average number of students entering each year is about 100.

There are two Presbyterian colleges, the General Assembly's College at Belfast, which is purely theological, and the Magee College, Londonderry, which has literary, scientific and theological courses. In 1881 the Assembly's College and the theological professors of Magee College were constituted a faculty with power to grant degrees in divinity.

In addition to the foregoing, seven Roman Catholic institutions were ranked as colleges in the census of 1901:—All Hallows (Drumcondra), Holycross (Clonliff), University College (Blackrock), St Patrick's (Carlow), St Kieran's (Kilkenny), St Stanislaus's (Tullamore) and St Patrick's (Thurles). In 1901 the aggregate number of pupils was 715, of whom 209 were returned as under the faculty of divinity.

As regards secondary schools a broad distinction can be drawn according to religion. The Roman Catholics have diocesan schools, schools under religious orders, monastic and convent schools, and Christian Brothers' schools, which were attended, according to the census returns in 1901, by nearly 22,000 pupils, male and female. On the other hand are the endowed schools, which are almost exclusively Protestant in their government. Under this heading may be included royal and diocesan schools and schools upon the foundation of Erasmus Smith, and others privately endowed. In 1901 these schools numbered 85 and had an attendance of 26,653 pupils. To these must be added various private establishments, which in the same year had over 8000 pupils, mainly Protestants. Dealing with these secondary schools as a whole the census of 1901 gives figures as to the number of pupils engaged upon what the commissioners call the "higher studies," i.e. studies involving instruction in at least one foreign language. In 1881 the number of such pupils was 18,657; in 1891, 23,484; and in 1901, 28,484, of whom 17,103 were males and 11,381 females, divided as follows among the different religions:—Roman Catholics 18,248, Protestant Episcopalians 5659, Presbyterians 3011, Methodists 750, and others 567. This increase in the number of pupils engaged in the higher studies is probably due to a large extent to the scheme for the encouragement of intermediate education which was established by act of parliament in 1879. A sum of £1,000,000, part of the Irish Church surplus, was assigned by that act for the promotion of the intermediate secular education of boys and girls in Ireland. The administration of this fund was entrusted to a board of commissioners, who were to apply its revenue for the purposes of the act (1) by carrying on a system of public examinations, (2) by awarding exhibitions, prizes and certificates to students, and (3) by the payment of results fees to the manager of schools. An amending act was passed in 1900 and the examinations are now held under rules made in virtue of that act. The number of students who presented themselves for examination in 1905 was 9677; the amount expended in exhibitions and prizes was £8336; and the grants to schools amounted to over £50,000. The examinations were held at 259 centres in 99 different localities.

Primary education in Ireland is under the general control of the commissioners of national education, who were first created in 1831 to take the place of the society for the education of the poor, and incorporated in 1845. In the year of their incorporation the schools under the control of the commissioners numbered 3426, with 432,844 pupils, and the amount of the parliamentary grants was £75,000; while in 1905 there were 8659 schools, with 737,752 pupils, and the grant was almost £1,400,000. Of the pupils attending in the latter year, 74% were Roman Catholics, 12% Protestant Episcopalians and 11% Presbyterians. The schools under the commissioners include national schools proper, model and workhouse schools and a number of monastic and convent schools. The Irish Education Act of 1892 provided that the parents of children of not less than 6 nor more than 14 years of age should cause them to attend school in the absence of reasonable excuse on at least 150 days in the year in municipal boroughs and in towns or townships under commissioners; and provisions were made for the partial or total abolition of fees in specified circumstances, for a parliamentary school grant in lieu of abolished school fees, and for the augmentation of the salaries of the national teachers.

There are 5 reformatory schools, 3 for boys and 2 for girls, and 68 industrial schools, 5 Protestant and 63 Roman Catholic. By the constituting act of 1890 the control of technical education in Ireland was handed over to the Department of Agriculture and Technical Instruction and now forms an important part of its work. The annual sum of £55,000 was allocated for the purpose, and this is augmented in various ways. The department has devoted itself to (1) promoting instruction in experimental science, drawing, manual instruction and

Technical  
Instruc-  
tion.

domestic economy in day secondary schools, (2) supplying funds to country and urban authorities for the organization of schemes for technical instruction in non-agricultural subjects—these subjects embracing not only preparation for the highly organized industries but the teaching of such rural industries as basket-making, (3) the training of teachers by classes held at various centres, (4) the provision of central institutions, and (5) the awarding of scholarships.

*Revenue and Expenditure.*—The early statistics as to revenue and expenditure in Ireland are very fragmentary and afford little possibility of comparison. During the first 15 years of Elizabeth's reign the expenses of Ireland, chiefly on account of wars, amounted, according to Sir James Ware's estimate, to over £490,000, while the revenue is put by some writers at £8000 per annum and by others at less. In the reign of James I. the customs increased from £50 to over £9000; but although he obtained from various sources about £10,000 a year and a considerable sum also accrued from the plantation of Ulster, the revenue is supposed to have fallen short of the expenditure by about £16,000 a year. During the reign of Charles I. the customs increased fourfold in value, but it was found necessary to raise £120,000 by yearly subsidies. According to the report of the committee appointed by Cromwell to investigate the financial condition of Ireland, the revenue in 1654 was £197,304 and the expenditure £630,814. At the Restoration the Irish parliament granted an hereditary revenue to the king, an excise for the maintenance of the army, a subsidy of tonnage and poundage for the navy, and a tax on hearths in lieu of feudal burdens. "Additional duties" were granted shortly after the Revolution. "Appropriate duties" were imposed at different periods; stamp duties were first granted in 1773, and the post office first became a source of revenue in 1783. In 1706 the hereditary revenue with additional duties produced over £394,000.

Returns of the ordinary revenue were first presented to the Irish parliament in 1730. From special returns to parliament the following table shows net income and expenditure over a series of years up to 1868:—

Year.	Income.	Expenditure.
1731	£405,000	£407,000
1741	441,000	441,000
1761	571,000	773,000
1781	739,000	1,015,000
1800	3,017,757	6,615,000
1834	3,814,900	3,439,800
1850	4,332,000	4,120,000
1860	7,851,000	6,331,000
1868	6,176,000	6,621,000

The amount of imperial revenue collected and expended in Ireland under various heads for the five years 1902-1906 appears in the following tables:—

Revenue.								
Year.	Customs.	Excise.	Estate, &c. Duties and Stamps.	Property and Income Tax.	Post Office.	Miscellaneous.	Total Revenue.	Estimated True Revenue.
1902	£2,244,000	£5,822,000	£1,072,000	£1,143,000	£923,000	£149,000	£11,353,000	£9,784,000
1903	2,717,000	6,011,000	922,000	1,244,000	960,000	148,500	12,002,500	10,205,000
1904	2,545,000	5,994,000	1,033,000	1,038,000	980,000	146,500	11,646,500	9,748,500
1905	2,575,000	5,584,000	1,016,000	1,013,000	1,002,000	150,500	11,340,500	9,753,500
1906	2,524,000	5,506,000	890,000	983,000	1,043,000	150,000	11,096,000	9,447,000

Expenditure.									
Year.	Consolidated Fund.	Voted.	Local Taxation Accounts.		Total Civil Charges.	Collection of Taxes.	Post Office.	Total Expended.	Estimated True Revenue.
			Local Taxation Revenue.	Exchequer Revenue.					
1902	£169,000	£4,271,000	£389,000	£1,055,000	£5,884,000	£243,000	£1,087,000	£7,214,000	£9,784,000
1903	168,500	4,357,500	383,000	1,058,000	5,967,000	246,000	1,140,000	7,353,000	10,205,000
1904	170,000	4,569,000	376,000	1,059,000	6,174,000	248,000	1,126,000	7,548,000	9,784,500
1905	166,000	4,547,000	374,000	1,059,000	6,146,000	249,000	1,172,000	7,567,000	9,753,500
1906	164,000	4,582,500	385,000	1,059,000	6,191,500	245,000	1,199,000	7,635,500	9,447,000

Subtracting in each year the total expenditure from the estimated true revenue it would appear from the foregoing table that Ireland contributed to imperial services in the years under consideration the following sums: £2,570,000, £2,852,000, £2,200,500, £2,186,500 and £1,811,500.

The financial relations between Great Britain and Ireland have long been a subject of controversy, and in 1804 a royal commission was appointed to consider them, which presented its report in 1806. The commissioners, though differing on several points, were practically agreed on the following five conclusions: (1) that Great Britain and Ireland must, for the purposes of a financial inquiry, be considered as separate entities; (2) that the Act of Union imposed upon Ireland a burden which, as events showed, she was unable to bear; (3) that the increase of taxation laid upon Ireland between 1853 and 1860 was not justified by the then existing circumstances; (4) that identity of rates of taxation did not necessarily involve equality of burden; (5) that, while the actual tax revenue of Ireland was about one-eleventh of that of Great Britain, the relative taxable capacity of Ireland was very much smaller, and was not estimated by any of the commissioners as exceeding one-twentieth. This report furnished the material for much controversy, but little practical outcome; it was avowedly based on the consideration of Ireland as a separate country, and was therefore inconsistent with the principles of Unionism.

The public debt of Ireland amounted to over £134,000,000 in 1817, in which year it was consolidated with the British national debt.

*Local Taxation.*—The Local Government (Ireland) Act 1898 effected considerable changes in local finance. The fiscal duties of the grand jury were abolished, and the county council which took the place of the grand jury for both fiscal and administrative purposes was given three sources of revenue: (1) the agricultural grant, (2) the licence duties and other imperial grants, and (3) the poor rate. These may be considered separately. (1) It was provided that the Local Government Board should ascertain the amount of county cess and poor rate levied off agricultural land in Ireland during the year ending (as regards the poor rate) on the 29th of September, and (as regards the county cess) on the 21st of June 1897; and that half this amount, to be called the agricultural grant, should be paid annually without any variation from the original sum out of the consolidated fund to a local taxation account. The amount of the agricultural grant was ascertained to be over £727,000. Elaborate provisions were also made in the act for fixing the proportion of the grant to which each county should be entitled, and the lord-lieutenant was empowered to pay half-yearly the proportion so ascertained to the county council. (2) Before the passing of the act grants were made from the imperial exchequer to the grand juries in aid of the maintenance of lunatics and to boards of guardians for medical and educational purposes and for salaries under the Public Health (Ireland) Act. In 1897 these grants amounted to over £236,000. Under the Local Government Act they ceased, and in lieu thereof it was provided that there should be annually paid out of the consolidated fund to the local taxation account a sum equal to the duties collected in Ireland on certain

specified local taxation licences. In addition, it was enacted that a fixed sum of £70,000 should be forthcoming annually from the consolidated fund. (3) The county cess was abolished, and the county councils were empowered to levy a single rate for the rural districts and unions, called by the name of poor rate, for all the purposes of the act. This rate is made upon the occupier and not upon the landlord, and the occupier is not entitled, save in a few specified cases, to deduct any of the rate from his rent. For the year ending the 31st of March 1905, the total receipts of the Irish county councils, exclusive of the county boroughs, were £2,064,298, and their total expenditure was £2,959,961, the two chief items of expenditure being "Union Charges" £1,002,620 and "Road Expenditure" £779,174. During the same period the total receipts from local taxation in Ireland amounted to £4,013,303, and the amount granted from imperial sources in aid of local taxation was £1,781,143.

**Loans.**—The total amount issued on loan, exclusive of closed sources, by the Commissioners of Public Works, up to the 31st of March 1906, was £26,946,393, of which £15,221,913 had been repaid to the exchequer as principal and £9,011,506 as interest, and £1,609,694 had been remitted. Of the sums advanced, about £5,590,000 was under the Improvement of Lands Acts, nearly £3,500,000 under the Public Health Acts, over £3,000,000 for lunatic asylums, and over £3,000,000 under the various abattoirs Acts.

**Banking.**—The Bank of Ireland was established in Dublin in 1783 with a capital of £600,000, which was afterwards enlarged at various times, and on the renewal of its charter in 1821 it was increased to £3,000,000. It holds in Ireland a position corresponding to the Bank of England in England. There are eight other joint-stock banks in Ireland. Including the Bank of Ireland, their subscribed capital amounts to £26,349,230 and their paid-up capital to £7,309,230. The authorized note circulation is £6,354,494 and the actual note circulation in June 1906 was £6,310,643, two of the banks not being banks of issue. The deposits in the joint-stock banks amounted in 1880 to £29,350,000; in 1890 to £33,061,000; in 1900 to £40,287,000; and in 1906 to £45,842,000. The deposits in the Post Office Savings Banks rose from £1,481,000 in 1880 to £10,459,000 in 1906, and the deposits in Trustee Savings Banks from £2,100,165 in 1880 to £2,488,740 in 1905.

**National Wealth.**—To arrive at any estimate of the national wealth is exceptionally difficult in the case of Ireland, since the largest part of its wealth is derived from agriculture, and many important factors, such as the amount of capital invested in the linen and other industries, cannot be included, owing to their uncertainty. The following figures for 1905-1906 may, however, be given: valuation of land, houses, &c., £5,466,000; value of principal crops £35,362,000; value of cattle, &c., £81,508,000; paid-up capital and reserve funds of joint-stock banks, £11,300,000; deposits in joint-stock and savings banks, £8,791,000; investments in government stock, transferable at Bank of Ireland, £36,952,000; paid-up capital and debentures of railway companies, £38,405,000; paid-up capital of tramway companies, £2,074,000.

In 1906 the net value of property assessed to estate duty, &c., in Ireland was £16,016,000 as compared with £306,673,000 in England and £38,451,000 in Scotland; and in 1905 the net produce of the income tax in Ireland was £983,000, as compared with £27,423,000 in England and £2,888,000 in Scotland.

**BIBLIOGRAPHY.—Agriculture:** Accounts of the land systems of Ireland will be found in James Godkin's *Land War in Ireland* (1870); Sigerson's *History of Land Tenure in Ireland* (1871); Joseph Fisher's *History of Land Holding in Ireland* (1877); R. B. O'Brien's *History of the Irish Land Question* (1880); A. G. Ritchey's *Irish Land Laws* (1880). General information will be found in J. P. Kennedy's *Digest of the evidence given before the Devon Commission* (Dublin, 1847-1848); the *Report of the Bessborough Commission*, 1881, and of the commission on the agriculture of the United Kingdom, 1881. The Department of Agriculture publishes several official annual reports, dealing very fully with Irish agriculture.

**Manufactures and Commerce:** *Discourse on the Woolen Manufacture of Ireland* (1698); *An Inquiry into the State and Progress of the Linen Manufacture in Ireland* (Dublin, 1757); G. E. Howard's *Treatise on the Revenue of Ireland* (1776); John Hely Hutchinson's *Commercial Restraints of Ireland* (1779); Lord Sheffield's *Observations on the Manufactures, Trade and Present State of Ireland* (1785); R. B. Clarendon, *A Sketch of the Revenue and Finances of Ireland* (1791); the annual reports of the Flax Supply Association and other local bodies, published at Belfast; reports by the Department of Agriculture on Irish imports and exports (these are a new feature and contain much valuable information).

**Miscellaneous:** Sir William Petty, *Political Anatomy of Ireland* (1691); Arthur Young, *Travels on the Trade of Ireland* (1789); *Abstract of the Number of Protestant and Roman Catholics in Ireland* (1726); Arthur Young, *Tour in Ireland* (1780); P. Newman's *View of the Circumstances of Ireland* (1809), and *Inquiry into the Population of Ireland* (1805); César Moreau, *Past and Present State of Ireland* (1827); J. M. Murphy, *Ireland, Industrial, Political and Social* (1870); R. Dennis, *Industrial Ireland* (1887); Grimshaw, *Facts and Figures about Ireland* (1893); *Report of the Recess Com-*

*mittee* (1896, published in Dublin); *Report of the Financial Relations Commission* (1897); Sir H. Plunkett, *Ireland in the New Century* (London, 1905); Filson Young, *Ireland at the Cross-Roads* (London, 1904); Thom's *Almanac*, published annually in Dublin, gives a very useful summary of statistics and other information.

(W. H. Po.)

#### EARLY HISTORY

On account of its isolated position we might expect to find Ireland in possession of a highly developed system of legends bearing on the origins of its inhabitants. Ireland remained outside the pale of the ancient Roman world, and a state of society which was peculiarly favourable to the preservation of national folk-lore survived in the island until the 16th century. The jealousy with which the hereditary antiquaries guarded the tribal genealogies naturally leads us to hope that the records which have come down to us may shed some light on the difficult problems connected with the early inhabitants of these islands and the west of Europe. Although innumerable histories of Ireland have appeared in print since the publication of Roderick O'Flaherty's *Ogygia* (London, 1677), the authors have in almost every case been content to reproduce the legendary accounts without bringing any serious criticism to bear on the sources. This is partly to be explained by the fact that the serious study of Irish philology only dates from 1853 and much of the most important material has not yet appeared in print. In the middle of the 19th century O'Donovan and O'Curry collected a vast amount of undigested information about the early history of the island, but as yet J. B. Bury in his monograph on St Patrick is the only trained historian who has ever adequately dealt with any of the problems connected with ancient Ireland. Hence it is evident that our knowledge of the subject must remain extremely unsatisfactory until the chief sources have been properly sifted by competent scholars. A beginning has been made by Sir John Rhys in his "Studies in Early Irish History" (*Proceedings of the British Academy*, vol. i.), and by John MacNeill in a suggestive series of papers contributed to the *New Ireland Review* (March 1906-Feb. 1907). Much might reasonably be expected from the sciences of archaeology and anthropology. But although Ireland is as rich as, or even richer in monuments of the past than, most countries in Europe, comparatively little has been done owing in large measure to the lack of systematic investigation.

It may be as well to specify some of the more important sources at the outset. Of the classical writers who notice Ireland Ptolemy is the only one who gives us any very definite information. The legendary origins first appear in Nennius and in a number of poems by such writers as Maelduin (d. 884), Cinaed Uah Artacáin (d. 975), Eochaid ua Flaínn (d. 984), Flann Mainistrech (d. 1056) and Gilla Coemgín (d. 1072). They are also embodied in the *Leabhar Gabhdla* or *Book of Invasions*, the earliest copy of which is contained in the *Book of Leinster*, a 12th-century MS. Geoffrey Keating's *History*, Dugald MacFibris's *Genealogies* and various collections of annals such as those by the Four Masters. Of prime importance for the earlier period are the stories known collectively as the Ulster cycle, among which the lengthy epic the *Táin Bó Cuailgne* takes first place. Amongst the numerous chronicles are the *Annals of Ulster*, which commence with the year 411, are by far the most trustworthy. The *Book of Rights* is another compilation which gives valuable information with regard to the relations of the various kingdoms to one another. Finally, there are the extensive collections of genealogies preserved in Rawlinson B 502, the *Books of Leinster* and *Ballymole*.

**Earliest Inhabitants.**—There is as yet no certain evidence to show that Ireland was inhabited during the palaeolithic period. But there are abundant traces of man in the neolithic state of culture (see Sir W. R. W. Wilde's *Catalogue of the antiquities in the Museum of the Royal Irish Academy*). The use of bronze was perhaps introduced about 1450 B.C. The craniological evidence is unfortunately at present insufficient to show whether the introduction of metal coincided with a very particular invasion

either from Britain or the European continent. At any rate it was not until well on in the Bronze Age, perhaps about 600 or 500 B.C., that the Goidels, the first invaders speaking a Celtic language, set foot in Ireland. The newcomers probably overran the whole island, subduing but not exterminating the older race with which they doubtless intermarried freely, as pre-Celtic types are frequent among the populations of Connaught and Munster at the present day. What the language was that was spoken by the neolithic aborigines is a question which will probably never be settled. The division into provinces or "fifths" (Ulster, Leinster, Connaught, E. Munster and W. Munster) appears to be older than the historical period, and may be due to the Goidels. Between 300 B.C. and 150 B.C. various Belgic and other Brythonic tribes established themselves in Britain bringing with them the knowledge of how to work in iron. Probably much about the same time certain Belgic tribes effected settlements in the S.E. of Ireland. Some time must have elapsed before any Brythonic people undertook to defy the powerful Goidelic states, as the supremacy of the Brythonic kingdom of Tara does not seem to have been acknowledged before the 4th century of our era. The early Belgic settlers constituted perhaps in the main trading states which acted as intermediaries of commerce between Ireland and Gaul.<sup>1</sup> In addition to these Brythonic colonies a number of Pictish tribes, who doubtless came over from Scotland, conquered for themselves parts of Antrim and Down where they maintained their independence till late in the historical period. Picts are also represented as having settled in the county of Roscommon; but we have at present no means of ascertaining when this invasion took place.

*Classical Writers.*—Greek and Roman writers seem to have possessed very little definite information about the island, though much of what they relate corresponds to the state of society disclosed in the older epics. Strabo held the inhabitants to be mere savages, addicted to cannibalism and having no marriage ties. Solinus speaks of the luxurious pastures, but the natives he terms an inhospitable and warlike nation. The conquerors among them having first drunk the blood of their enemies, afterwards besmear their faces therewith; they regard right and wrong alike. Whenever a woman brings forth a male child, she puts his first food on the sword of her husband, and lightly introduces the first *auspicium* of nourishment into his little mouth with the point of the sword. Pomponius Mela speaks of the climate as unfit for ripening grain, but he, too, notices the luxuriance of the grass. However, it is not until we reach Ptolemy that we feel we are treading on firm ground. His description is of supreme importance for the study of early Irish ethnography. Ptolemy gives the names of sixteen peoples in Ireland, several of which can be identified. As we should expect from our knowledge of later Irish history scarcely any towns are mentioned. In the S.E., probably in Co. Wicklow, we find the Manapii—evidently a colony from N.E. Gaul. North of them, perhaps in Kildare, a similar people, the Cauci, are located. In Waterford and Wexford are placed the Brigantes, who also occur in Yorkshire. The territory to the west of the Brigantes is occupied by a people called by Ptolemy the Iverni. Their capital he gives as Ivernis, and in the extreme S.W. of the island he marks the mouth of the river Iernos, by which the top of Dingle Bay called Castlemaine Harbour is perhaps intended. The Iverni must have been a nation of considerable importance, as they play a prominent part in the historical period, where they are known as the Érainn or Éraind of Munster. It would seem that the Iverni were the first native tribe with whom foreign traders came in contact, as it is from them that the Latin name for the whole island is derived. The earliest form was probably *Ieriyō* or *Ieriyōs*, genitive *Ieriyōnos*, from which come Lat. *Iverio*, *Hiverio* (Antonine Itinerary), *Hiberio* (Confession of St Patrick), Old Irish *Eriu*, *Hériu*, gen. *Hérenn*

with regular loss of intervocalic *v*, Welsh *Iwerddon* (from the oblique cases). West of the Iverni in Co. Kerry Ptolemy mentions the Vellabori, and going in a northerly direction following the coast we find the Gangani, Autini (Autiri), Nagnatae (Magnatae). Erdini (cf. the name Lough Erne), Vennicini, Rhobogdi, Darini and Eblanii, none of whom can be identified with certainty. In south Ulster Ptolemy locates a people called the Voluntii who seem to correspond to the Ulidians of a later period (Ir. *Ulad*, in Irish Lat. *Ulota*). About Queen's county or Tipperary are situated the Urdiae, whose name is compared with the later Ossory (Ir. *Os-raige*). Lastly, in the north of Wexford we find the Coriundi who occur in Irish texts near the Boyne (Mid. Ir. *Coraind*). It would seem as if Ptolemy's description of Ireland answered in some measure to the state of affairs which we find obtaining in the older Ulster epic cycle.<sup>2</sup> Both are probably anterior to the foundation of a central state at Tara.

*Legendary Origins.*—We can unfortunately derive no further assistance from external sources and must therefore examine the native traditions. From the 9th century onwards we find accounts of various races who had colonized the island. These stories naturally become amplified as times goes on, and in what we may regard as the classical or standard versions to be found in Keating, the Four Masters, Dugald MacFhirbis and elsewhere, no fewer than five successive invasions are enumerated. The first colony is represented as having arrived in Ireland in A.M. 2520, under the leadership of an individual named Partholan who hailed from Middle Greece. His company landed in Kenmare Bay and settled in what is now Co. Dublin. After occupying the island for 300 years they were all carried off by a plague and were buried at Tallaght (Ir. *Tamlacht*, "plague-grave"), at which place a number of ancient remains (probably belonging, however, to the Viking period) have come to light. In A.M. 2850 a warrior from Scythia called Nemed reached Ireland with 900 fighting men. Nemed's people are represented as having to struggle for their existence with a race of sea-pirates known as the Fomorians. The latter's stronghold was Tory Island, where they had a mighty fortress. After undergoing great hardship the Nemedians succeeded in destroying the fortress and in slaying the enemies' leaders, but the Fomorians received reinforcements from Africa. A second battle was fought in which both parties were nearly exterminated. Of the Nemedians only thirty warriors escaped, among them being three descendants of Nemed, who made their way each to a different country (A.M. 3066). One of them, Simon Brec, proceeded to Greece, where his posterity multiplied to such an extent that the Greeks grew afraid and reduced them to slavery. In time their position became so intolerable that they resolved to escape, and they arrived in Ireland A.M. 3266. This third body of invaders is known collectively as Firbolgs, and is ethnologically and historically very important. They are stated to have had five leaders, all brothers, each of whom occupied one of the provinces or "fifths." We find them landing in different places. One party, the Fir Galeoin, landed at Inber Slangi, the mouth of the Slaney, and occupied much of Leinster. Another, the Fir Domnand, settled in Mayo where their name survives in Irrus Domnand, the ancient name for the district of Erris. A third band, the Firbolg proper, took possession of Munster. Many authorities such as Keating and MacFhirbis admit that descendants of the Firbolgs were still to be found in parts of Ireland in their own day, though they are characterized as "tattling, gulleful, tale-bearing, noisy, contemptible, mean, wretched, unsteady, harsh and inhospitable." The Firbolgs had scarcely established themselves in the island when a fresh set of invaders appeared on the scene. These were the Tuatha Dé Danann ("tribes of the god Danu"), who according to the story were also descended from Nemed. They came originally from Greece and were highly skilled in necromancy. Having to flee from Greece on account of a Syrian invasion they proceeded to Scandinavia. Under Nuadu Airgetlám they

<sup>1</sup> The importance of the commerce between Ireland and Gaul in early times, and in particular the trade in wine, has been insisted upon by H. Zimmer in papers in the *Abh. d. Berl. Akad. d. Wissenschaften* (1909).

<sup>2</sup> On the subject of Ptolemy's description of Ireland see articles by G. H. Orpen in the *Journal of the Royal Society of Antiquaries of Ireland* (June 1894), and John MacNeill in the *New Ireland Review* (September 1906).

moved to Scotland, and finally arrived in Ireland (A.M. 3303), bringing with them in addition to the celebrated Lia Fáil ("stone of destiny") which they set up at Tara, the cauldron of the Dagda and the sword and spear of Lugaid Lámfada. Eochaid, son of Érc, king of the Fírbolgs, having declined to surrender the sovereignty of Ireland, a great battle was fought on the plain of Moytura near Cong (Co. Mayo), the site of a prehistoric cemetery. In this contest the Fírbolgs were overthrown with great slaughter, and the remnants of the race according to Keating and other writers took refuge in Arran, Islay, Rathlin and the Hebrides, where they dwelt until driven out by Picts. Twenty-seven years later the Tuatha Dé had to defend themselves against the Fomorians, who were almost annihilated at the battle of north Moytura near Sligo. The Tuatha Dé then enjoyed undisturbed possession of Ireland until the arrival of the Milesians in A.M. 3500.

All the early writers dwell with great fondness on the origin and adventures of this race. The Milesians came primarily from Scythia and after sojourning for some time in Egypt, Crete and in Scythia again, they finally arrived in Spain. In the line of mythical ancestors which extends without interruption up to Noah, the names of Fenius Farsaid, Goedel Glas, Eber Scot and Breogan constantly recur in Irish story. At length eight sons of Miled (*Milesius*) set forth to conquer Ireland. The spells of the Tuatha Dé accounted for most of their number. However, after two battles the newcomers succeeded in overcoming the older race; and two brothers, Eber Find and Eremon, divided the island between them, Eber Find taking east and west Munster, whilst Eremon received Leinster and Connaught. Lugaid, son of the brother of Miled, took possession of south-west Munster. At the same time Ulster was left to Eber son of Ir son of Miled. The old historians agree that Ireland was ruled by a succession of Milesian monarchs until the reign of Roderick O'Connor, the last native king. The Tuatha Dé are represented as retiring into the *sid* or fairy mounds. Eber Find and Eremon did not remain long in agreement. The historians place the beginnings of the antithesis between north and south at the very commencement of the Milesian domination. A battle was fought between the two brothers in which Eber Find lost his life. In the reign of Eremon the Picts are stated to have arrived in Ireland, coming from Scythia. It will have been observed that Scythia had a peculiar attraction for medieval Irish chroniclers on account of its resemblance to the name Scotti, Scots. The Picts first settled in Leinster; but the main body were forced to remove to Scotland, only a few remaining behind in Meath. Among the numerous mythical kings placed by the annalists between Eremon and the Christian era we may mention Tigernmas (A.M. 3581), Ollam Fodla (A.M. 3922) who established the meeting of Tara, Cimbæath (c. 305 B.C.) the reputed founder of Emain Macha, Ugainne Mór, Labraid Loingslech, and Eochaid Feidlech, who built Rath Cruachan for his celebrated daughter, Medb queen of Connaught. During the 1st century of our era we hear of the rising of the *aithche-tuatha*, i.e. subject or plebeian tribes, or in other words the Fírbolgs, who paid *daer*- or base rent to the Milesians. From a resemblance in the name which is probably fortuitous these tribes have been identified with the Attecotti of Roman writers. Under Cairbre Cinchait ("cat-head") the oppressed peoples succeeded in wresting the sovereignty from the Milesians, whose princes and nobles were almost exterminated (A.D. 90). The line of Eremon was, however, restored on the accession of Tuathal Techtmar ("the legitimate"), who reigned A.D. 130-160. This ruler took measures to consolidate the power of the *ardri* (supreme king). He constructed a number of fortresses on the great central plain and carved out the kingdom of Meath to serve as his mensal land. The new kingdom was composed of the present counties of Meath, Westmeath and Longford together with portions of Monaghan, Cavan, King's Co. and Kildare. He was also the first to levy the famous Leinster tribute, the *boroma*, in consequence of an insult offered to him by one of the kings of that province. This tribute, which was only remitted in the 7th century at the instance of St. Moling, must have been the source of constant war and oppression. A

grandson of Tuathal's, the famous Conn Cétchathach ("the hundred-fighter"), whose death is placed in the year 177 after a reign of about twenty years, was constantly at war with the Munster ruler Eogan Mór, also called Mog Nuadat, of the race of Eber Find. Eogan had subdued the Érnai and the Corco Laighe (descendants of Lugaid son of Ith) in Munster, and even the supreme king was obliged to share the island with him. Hence the well-known names Leth Cuinn or "Conn's half" (north Ireland), and Leth Moga or "Mug's half" (south Ireland). The boundary line ran from the Bay of Galway to Dublin along the great ridge of gravel known as Eiscir Riada which stretches across Ireland. Mog Nuadat had a son Ailili Aulom who plays a prominent part in the Irish sagas and genealogies, and his sons Eogan, Cian and Cormac Cas, all became the ancestors of well-known families. Conn's grandson, Cormac son of Art, is represented as having reigned in great splendour (254-266) and as having been a great patron of learning. It was during this reign that the sept of the Déisi were expelled from Meath. They settled in Munster where their name still survives in the barony of Decies (Co. Waterford). A curious passage in Cormac's *Glossary* connects one of the leaders of this sept, Cáirpre Múch, with the settlements of the Irish in south Wales which may have taken place as early as the 3rd century. Of greater consequence was the invasion of Ulster by the three Collas, cousins of the *ardri* Muredach. The stronghold of Emain Macha was destroyed and the Ulstermen were driven across the Newry River into Dalriada, which was inhabited by Picts.

The old inhabitants of Ulster are usually termed Ulidians to distinguish them from the Milesian peoples who overran the province. With the advent of Niall Nóigíallach ("N. of the nine hostages" reigned 379-405) son of Eochaid Muigmedóin (358-366) we are treading safer ground. It was about this time that the Milesian kingdom of Tara was firmly established. Nor was Niall's activity confined to Ireland alone. Irish sources represent him as constantly engaged in marauding expeditions overseas, and it was doubtless on one of these that St. Patrick was taken captive. These movements coincide with the inroads of the Picts and Scots recorded by Roman writers. It is probably from this period that the Irish colonies in south Wales, Somerset, Devon and Cornwall date. And the earliest migrations from Ulster to Argyll may also have taken place about this time. Literary evidence of the colonization of south Wales is preserved both in Welsh and Irish sources, and some idea of the extent of Irish overseas activity may be gathered from the distribution of the Ogam inscriptions in Wales, south-west England and the Isle of Man.

*Criticism of the Legendary Origins.*—It is only in recent years that the Irish legendary origins have been subjected to serious criticism. The fondly cherished theory which attributes Milesian descent to the bulk of the native population has at length been assailed. MacNeill asserts that in MacFibris's genealogies the majority of the tribes in early Ireland do not trace their descent to Eremon and Eber Find; they are rather the descendants of the subject races, one of which figures in the list of conquests under the name of Fírbolg. The stories of the Fomorians were doubtless suggested in part by the Viking invasions, but the origin of the Partholan legend has not been discovered. The Tuatha Dé do not appear in any of the earliest quasi-historical documents, nor in Nennius, and they scarcely correspond to any particular race. It seems more probable that a special invasion was assigned to them by later writers in order to explain the presence of mythical personages going by their name in the heroic cycles, as they were found inconvenient by the monkish historians. In the early centuries of our era Ireland would therefore have been occupied by the Fírbolgs and kindred races and the Milesians. According to MacNeill the Fírbolg tribal names are formed with the suffix *-raige*, e.g. *Ciarraige*, Kerry, *Osráige*, Ossory, or with the obscure words *Corcu* and *macu* (*maccu*), e.g. *Corco Duibne*, Corkaguiney, *Corco Mrud*, Corcomroe, *Macu Laegdae*, *Macu Teimne*. In the case of *corcu* and *macu* the name which follows is frequently the name of an eponymous ancestor. The Milesians on the other hand named



themselves after an historical ancestor employing terms such as *ui*, "descendants," *cland*, "children," *dal*, "division," *cinel*, "kindred," or *sl*, "seed." In this connexion it may be noted that practically all the Milesian pedigrees converge on three ancestors in the 2nd century—Conn Cétchathach king of Tara, Cathair Mór of Leinster, and Ailill Aulom of Munster,—whilst in scarcely any of them are mythological personages absent when we go farther back than A.D. 300. Special genealogies were framed to link up other races, e.g. the Érainn and Corcu Loegdi of Munster and the Ulidians with the Milesians of Tara.

The peculiar characteristic of the Milesian conquest is the establishment of a central monarchy at Tara. No trace of such a state of affairs is to be found in the Ulster epic. In the *Táin Bó Cúailnge* we find Ireland divided into fifts, each ruled over by its own king. These divisions were: Ulster with Emain Macha as capital, Connaught with Cruachu as residence, north Munster from Slieve Bloom to north Kerry, south Munster from south Kerry to Waterford, and Leinster consisting of the two kingdoms of Tara and Ailinn. Moreover, the kings of Tara mentioned in the Ulster cycle do not figure in any list of Milesian kings. It would appear then that the central kingdom of Tara was an innovation subsequent to the state of society described in the oldest sagas and the political position reflected in Ptolemy's account. It was probably due to an invasion undertaken by Brythons<sup>1</sup> from Britain, but it is impossible to assign a precise date for their arrival. Until the end of the 3rd century the Milesian power must have been confined to the valley of the Boyne and the district around Tara. At the beginning of the 4th century the three Collas founded the kingdom of Oriel (comprising the present counties of Armagh, Monaghan, north Louth, south Fermanagh) and drove the Ulidians into the eastern part of the province. Brian and Fiachra, sons of Eochaid Muigmedóin, conquered for themselves the country of the Ui Briuin (Roscommon, Leitrim, Cavan) and Tír Fiachrach, the territory of the Firbolg tribe the Fir Domnann in the valley of the Moy (Co. Mayo). Somewhat later south Connaught was similarly wrested from the older race and colonized by descendants of Brian and Fiachra, later known as Ui Fiachrach Aidni and Ui Briuin Seola. The north of Ulster is stated to have been conquered and colonized by Conall and Eogan, sons of Niall Nógíallach. The former gave his name to the western portion, Tír Conaill (Co. Donegal), whilst Inishowen was called Tír Eogain after Eogan. The name Tír Eogain later became associated with south Ulster where it survives in the county name Tyrone. The whole kingdom of the north is commonly designated the kingdom of Ailech, from the ancient stronghold near Derry which the sons of Niall probably took over from the earlier inhabitants. At the end of the 5th century Maine, a relative of the king of Tara, was apportioned a tract of Firbolg territory to the west of the Suck in Connaught, which formed the nucleus of a powerful state known as Hy Maine (in English commonly called the "O'Kelly's country"). Thus practically the whole of the north and west gradually came under the sway of the Milesian rulers. Nevertheless one portion retained its independence. This was Ulidia, consisting of Dalriada, Dal Fiachra, Dal Araide, including the present counties of Antrim and Down. The bulk of the population here was probably Pictish; but the Dal Fiachra, representing the old Ulidians or ancient population of Ulster, maintained themselves until the 8th century when they were subdued by their Pictish neighbours. The relationship of Munster and Leinster to the Tara dynasty is not so easy to define. The small kingdom of Ossory remained independent until a very late period. As for Leinster none of the Brythonic peoples mentioned by Ptolemy left traces of their name, although it is possible that the ruling

<sup>1</sup> Scholars are only beginning to realize how close was the connexion between Ireland and Wales from early times. Pedersen has recently pointed out the large number of Brythonic and Welsh loan words received into Irish from the time of the Roman occupation of Britain to the beginning of the literary period. Welsh writers now assume an Irish origin for much of the contents of the *Mabinogion*.

family may have been derived from them. It would seem that the Fir Galeoin who play such a prominent part in the *Táin* had been crushed before authentic history begins. The king of Leinster was for centuries the most determined opponent of the *ardri*, an antithesis which is embodied in the story of the *boroma* tribute. When we turn to Munster we find that Cashel was the seat of power in historical times. Now Cashel (a loanword from Lat. *castellum*) was not founded until the beginning of the 5th century by Corc son of Lugaid. The legendary account attributes the subjugation of the various peoples inhabiting Munster to Mog Nuadat, and the pedigrees are invariably traced up to his son Ailill Aulom. Rhys adopts the view that the race of Eber Find was not Milesian but a branch of the Érainn, and this theory has much in its favour. The allegiance of the rulers of Munster to Niall and his descendants can at the best of times only have been nominal.

In this way we get a number of over-kingdoms acknowledging only the supremacy of the Tara dynasty. These were (1) Munster with Cashel as centre, (2) Connaught, (3) Ailech, (4) Oriel, (5) Ulidia, (6) Meath, (7) Leinster, (8) Ossory. Some of these states might be split up into various parts at certain periods, each part becoming for the time-being an over-kingdom. For instance, Ailech might be resolved into Tír Conaill and Tír Eogain according to political conditions. Hence the number of over-kingdoms is given variously in different documents. The supremacy was vested in the descendants of Niall Nógíallach without interruption until 1002; but as Niall's descendants were represented by four reigning families, the high-kinship passed from one branch to another. Nevertheless after the middle of the 8th century the title of *ardri* (high-king) was only held by the Cinel Eogain (northern Hy Neill) and the rulers of Meath (southern Hy Neill), as the kingdom of Oriel had dropped into insignificance. The supremacy of the *ardri* was more often than not purely nominal. This must have been particularly the case in Leth Moga.

*Religion in Early Ireland.*—Our knowledge of the beliefs of the pagan Irish is very slight. The oldest texts belonging to the heroic cycle are not preserved in any MS. before 1100, and though the sagas were certainly committed to writing several centuries before that date, it is evident that the monkish transcribers have toned down or omitted features that savoured too strongly of paganism. Supernatural beings play an important part in the *Táin Bó Cúailnge*, *Cuchulinn's Sickbed*, the  *Wooing of Emer* and similar stories, but the relations between ordinary mortals and such divine or semi-divine personages is not easy to establish. It seems unlikely that the ancient Irish had a highly developed pantheon. On the other hand there are abundant traces of animistic worship, which have survived in wells, often associated with a sacred tree (Ir. *bile*), bullans, pillar stones, weapons. There are also traces of the worship of the elements, prominent among which are sun and fire. The belief in earth spirits or fairies (Ir. *aes síde*, *síd*) forms perhaps the most striking feature of Irish belief. The sagas teem with references to the inhabitants of the fairy mounds, who play such an important part in the mind of the peasantry of our own time. These supernatural beings are sometimes represented as immortal, but often they fall victims to the prowess of mortals. Numerous cases of marriage between fairies and mortals are recorded. The Tuatha Dé Danann is used as a collective name for the *aes síde*. The representatives of this race in the *Táin Bó Cúailnge* play a somewhat similar part to the gods of the ancient Greeks in the *Iliad*, though they are of necessity of a much more shadowy nature. Prominent among them were Manannán mac Lir, who is connected with the sea and the Isle of Man, and the Dagda, the father of a numerous progeny. One of them, Bodb Derg, resided near Fortumera on the shore of Lough Derg, whilst another, Angus Mac-in-óg, dwelt at the Brug of the Boyne, the well-known tumulus at New Grange. The Dagda's daughter Brigit transmitted many of her attributes to the Christian saint of the same name (d. 523). The ancient Brigit seems to have been the patroness of the arts and was probably also the goddess of fertility. At any rate it is with her that the sacred fire at Kildare which

burnt almost uninterruptedly until the time of the Reformation was associated; and she was commonly invoked in the Hebrides, and until quite recently in Donegal, to secure good crops. Well-known fairy queens are Clíona (south Munster) and Aibell (north Munster). We frequently hear of three goddesses of war—Ana, Bodb and Macha, also generally called Morrighu and Badb. They showed themselves in battles hovering over the heads of the combatants in the form of a carrion crow. The name Bodb appears on a Gaulish stone as (*Cathu-ibodvae*. The *Geniti glinni* and *demna aoir* were other fierce spirits who delighted in carnage.

When we come to treat of religious rites and worship, our sources leave us completely in the dark. We hear in several documents of a great idol covered with gold and silver named Cromm Cruach, or Cenn Cruaich, which was surrounded by twelve lesser idols covered with brass or bronze, and stood on Mag Slecht (the plain of prostrations) near Ballymagauran, Co. Cavan. In one text the Cromm Cruach is styled the chief idol of Ireland. According to the story St Patrick overthrew the idol, and one of the lives of the saint states that the mark of his crossier might still be seen on the stone. In the *Dindsenchus* we are told that the worshippers sacrificed their children to the idol in order to secure corn, honey and milk in plenty. On the occasion of famine the druids advised that the son of a sinless married couple should be brought to Ireland to be killed in front of Tara and his blood mixed with the soil of Tara. We might naturally expect to find the druids active in the capacity of priests in Ireland. D'Arbois de Jubainville maintains that in Gaul the three classes of druids, vates and gutuatri, corresponded more or less to the pontifices, augurs and flamens of ancient Rome. In ancient Irish literature the functions of the druids correspond fairly closely to those of their Gaulish brethren recorded by Caesar and other writers of antiquity. Had we contemporary accounts of the position of the druid in Ireland prior to the introduction of Christianity, it may be doubted if any serious difference would be discovered. In early Irish literature the druids chiefly appear as magicians and diviners, but they are also the repositories of the learning of the time which they transmitted to the disciples accompanying them (see DRUIDISM). The Druids were believed to have the power to render a person insane by flinging a magic wisp of straw in his face, and they were able to raise clouds of mist, or to bring down showers of fire and blood. They claimed to be able to foretell the future by watching the clouds, or by means of divining-rods made of yew. They also resorted to sacrifice. They possessed several means for rendering a person invisible, and various peculiar and complicated methods of divination, such as *Imbas forosna*, *lein laegda*, and *dícheat do chennab*, are described in early authorities. Whether or not the Irish druids taught that the soul was immortal is a question which it is impossible to decide. There is one passage which seems to support the view that they agreed with the Gaulish druids in this respect, but it is not safe to deny the possible influence of Christian teaching in the document in question. The Irish, however, possessed some more or less definite notions about an abode of everlasting youth and peace inhabited by fairies. The latter either dwell in the *sid*, and this is probably the earlier conception, or in islands out in the ocean where they live a life of never-ending delight. These happy abodes were known by various names, as *Tír Tairngiri* (Land of Promise), *Mag Mell* (Plain of Pleasures). Conda Caem son of Conn Cétchathach was carried in a boat of crystal by a fairy maiden to the land of youth, and among other mortals who went thither Bran, son of Febal, and Ossian are the most famous. The doctrine of metempsychosis seems to have been familiar in early Ireland. Mongan king of Dalriada in the 7th century is stated to have passed after death into various shapes—a wolf, a stag, a salmon, a seal, a swan. Fintan, nephew of Partholan, is also reported to have survived the deluge and to have lived in various shapes until he was reborn as Tuan mac Cairill in the 6th century. This legend appears to have been worked up, if not manufactured, by the historians of the 9th to 11th centuries to support their fictions. It may, however, be mentioned that Giraldus Cambrensis and the *Speculum Regale*

state in all seriousness that certain of the inhabitants of Ossory were able at will to assume the form of wolves, and similar stories are not infrequent in Irish romance.

*Conversion to Christianity.*—In the beginning of the 4th century there was an organized Christian church in Britain; and in view of the intimate relations existing between Wales and Ireland during that century it is safe to conclude that there were Christians in Ireland before the time of St Patrick. Returned colonists from south Wales, traders and the raids of the Irish in Britain with the consequent influx of British captives sold into slavery must have introduced the knowledge of Christianity into the island considerably before A.D. 400. In this connexion it is interesting to find an Irishman named Fith (also called Iserninus) associated with St Patrick at Auxerre. Further, the earliest Latin words introduced into Irish show the influence of British pronunciation (e.g. O. Ir. *trindóit* from *trinitat-em* shows the Brythonic change of *d* to *ó*). Irish records preserve the names of three shadowy pre-Patrician saints who were connected with south-east Ireland, Declan, Ailbe and Ciaran.

In one source the great heresiarch Pelagius is stated to have been a Scot. He may have been descended from an Irish family settled in south Wales. We have also the statement of Prosper of Aquitaine that Palladius was sent by Pope Celestine as first bishop to the Scots that believe in Christ. But though we may safely assume that a number of scattered communities existed in Ireland, and probably not in the south alone, it is unlikely that there was any organization before the time of St Patrick. This mission arose out of the visit of St Germanus of Auxerre to Britain. The British bishops had grown alarmed at the rapid growth of Pelagianism in Britain and sought the aid of the Gaulish church. A synod summoned for the occasion commissioned Germanus and Lupus to go to Britain, which they accordingly did in 429; Pope Celestine, we are told, had given his sanction to the mission through the deacon Palladius. The heresy was successfully stamped out in Britain, but distinct traces of it are to be found some three centuries later in Ireland, and it is to Irish monks on the European continent that we owe the preservation of the recently discovered copies of Pelagius's *Commentary*. Palladius's activity in Britain probably marked him out as the man to undertake the task of bringing Ireland into touch with Western Christianity. In any case Prosper and the Irish Annals represent him as arriving in Ireland in 431 with episcopal rank. His missionary activity unfortunately is extremely obscure. Tradition associates his name with Co. Wicklow, but Irish sources state that after a brief sojourn there he proceeded to the land of the Picts, among whom he was beginning to labour when his career was cut short by death.

*St Patrick.*—At this juncture Germanus of Auxerre decided to consecrate his pupil Patrick for the purpose of carrying on the work begun by Palladius. Patrick would possess several qualifications for the dignity of a missionary bishop to Ireland. Born in Britain about 389, he had been carried into slavery in Ireland when a youth of sixteen. He remained with his master for seven years, and must have had ample opportunity for observing the conditions, and learning the language, of the people around him; and such knowledge would have been indispensable to the Christian bishop in view of the peculiar state of Irish society (see PATRICK, ST). The new bishop landed in Wicklow in 432. Leinster was probably the province in which Christianity was already most strongly represented, and Patrick may have entrusted this part of his sphere to two fellow-workers from Gaul, Auxilius and Iserninus. At any rate he seems rather to have addressed himself more especially to the task of founding churches in Meath, Ulster and Connaught. In Ireland the land nominally belonged to the tribe, but in reality a kind of feudal system existed. In order to succeed with the body of the tribe it was necessary to secure the adherence of the chief. The conversion in consequence was in large measure only apparent; and such pagan superstitions and practices as did not run directly counter to the new teaching were tolerated by the saint. Thus, whilst the mass of the people practically still continued in heathendom, the apostle was enabled to found

churches and schools and educate a priesthood which should provide the most effective and certain means of conversion. It would be a mistake to suppose that his success was as rapid or as complete as is generally assumed. There can be no doubt that he met with great opposition both from the high-king Loigaire and from the druids. But though Loigaire refused to desert the faith of his ancestors we are told that a number of his nearest kinsmen accepted Christianity; and if there be any truth in the story of the codification of the Brehon Laws we gather that he realized that the future belonged to the new religion. St Patrick's work seems to fall under two heads. In the first place he planted the faith in parts of the north and west which had probably not yet heard the gospel. He also organized the already existing Christian communities, and with this in view founded a church at Armagh as his metropolitan see (444). It is further due to him that Ireland became linked up with Rome and the Christian countries of the Western church, and that in consequence Latin was introduced as the language of the church. It seems probable that St Patrick consecrated a considerable number of bishops with small but definite dioceses which doubtless coincided in the main with the territories of the *tuatha*. In any case the ideal of the apostle from Britain was almost certainly very different from the monastic system in vogue in Ireland in the 6th and 7th centuries.

*The Early Irish Church.*—The church founded by St Patrick was doubtless in the main identical in doctrine with the churches of Britain and Gaul and other branches of the Western church; but after the recall of the Roman legions from Britain the Irish church was shut off from the Roman world, and it is only natural that there should not have been any great amount of scruple with regard to orthodox doctrine. This would explain the survival of the writings of Pelagius in Ireland until the 8th century. Even Columba himself, in his Latin hymn *Allus prosator*, was suspected by Gregory the Great of favouring Arian doctrines. After the death of St Patrick there was apparently a relapse into paganism in many parts of the island. The church itself gradually became grafted on to the feudal organization, the result of which was the peculiar system which we find in the 6th and 7th centuries. Wherever Roman law and municipal institutions had been in force the church was modelled on the civil society. The bishops governed ecclesiastical districts co-ordinate with the civil divisions. In Ireland there were no cities and no municipal institutions; the nation consisted of groups of tribes connected by kinship, and loosely held together by a feudal system which we shall examine later. Although St Patrick endeavoured to organize the Irish church on regular diocesan lines, after his death an approximation to the lay system was under the circumstances almost inevitable. When a chief became a Christian and bestowed lands on the church, he at the same time transferred all his rights as a chief; but these rights still remained with his sept, albeit subordinate to the uses of the church. At first all church offices were exclusively confined to members of the sept. In this new sept there was consequently a twofold succession. The religious sept or family consisted in the first instance not only of the ecclesiastical persons to whom the gift was made, but of all the *céli* or vassals, tenants and slaves, connected with the land bestowed. The head was the coarb (Ir. *comarba*, "co-heir"), i.e. the inheritor both of the spiritual and temporal rights and privileges of the founder; he in his temporal capacity exacted rent and tribute like other chiefs, and made war not on temporal chiefs only, the spectacle of two coarbs making war on each other not being unusual. The ecclesiastical colonies that went forth from a parent family generally remained in subordination to it, in the same way that the spreading branches of a ruling family remained in general subordinate to it. The heads of the secondary families were also called the coarbs of the original founder. Thus there were coarbs of Columba at Iona, Kells, Derry, Durrow and other places. The coarb of the chief spiritual foundation was called the high coarb (*ard-chomarba*). The coarb might be a bishop or only an abbot, but in either case all the ecclesiastics in the family were subject to him; in this way it frequently

happened that bishops, though their superior functions were recognized, were in subjection to abbots who were only priests, as in the case of St Columba, or even to a woman, as in the case of St Brigit. This singular association of lay and spiritual powers was liable to the abuse of allowing the whole succession to fall into lay hands, as happened to a large extent in later times. The temporal chief had his steward who superintended the collection of his rents and tributes; in like manner the coarb of a religious sept had his *airchinneach* (Anglo-Irish *erenach*, *herenach*), whose office was generally, but not necessarily, hereditary. The office embodied in a certain sense the lay succession in the family.

From the beginning the life of the converts must have been in some measure coenobitic. Indeed it could hardly have been otherwise in a pagan and half-savage land. St Patrick himself in his Confession makes mention of monks in Ireland in connexion with his mission, but the few glimpses we get of the monastic life of the decades immediately following his death prove that the earliest type of coenobium differed considerably from that known at a later period. The coenobium of the end of the 5th century consisted of an ordinary sept or family whose chief had become Christian. After making a gift of his lands the chief either retired, leaving it in the hands of a coarb, or remained as the religious head himself. The family went on with their usual avocations, but some of the men and women, and in some cases all, practised celibacy, and all joined in fasting and prayer. It may be inferred from native documents that grave disorders were prevalent under this system. A severer and more exclusive type of monasticism succeeded this primitive one, but apart from the separation of the sexes the general character never entirely changed.

Diocesan organization as understood in countries under Roman Law being unknown, there was not that limitation of the number of bishops which territorial jurisdiction renders necessary, and consequently the number of bishops increased beyond all proportions. Thus, St Mochta, abbot of Louth, and a reputed disciple of St Patrick, is stated to have had no less than 100 bishops in his monastic family. All the bishops in a coenobium were subject to the abbot; but besides the bishop in the monastic families, every *tuath* or tribe had its own bishop. The church in Ireland having been evolved out of the monastic nuclei already described the tribe bishop was an episcopal development of a somewhat later period. He was an important personage, his status being fixed in the Brehon laws, from which we learn that his honour price was seven *cumals*, and that he had the right to be accompanied by the same number of followers as a petty king. The power of the bishops was considerable, as they were strong enough to resist the kings with regard to the right of sanctuary, ever a fertile source of dissension. The *tuath* bishop in later centuries corresponded to the diocesan bishop as closely as it was possible in two systems so different as tribal and municipal government. When diocesan jurisdiction was introduced into Ireland in the 12th century the *tuath* became a diocese. Many of the old dioceses represent ancient *tuatha*, and even enlarged modern dioceses coincide with the territories of ancient tribal states. Thus the diocese of Kilmacduagh was the territory of the Hui Fiachrach Aidne; that of Killynora was the tribe land of Corco-Mruad or Corcomroe. Many deaneries also represent tribe territories. Thus the deanery of Musgriffin (Co. Cork) was the ancient Muscraige Mitaine, and no doubt had its tribe bishop in ancient times. Bishops without dioceses and monastic bishops were not unknown outside Ireland in the Eastern and Western churches in very early times, but they had disappeared with rare exceptions in the 6th century when the Irish reintroduced the monastic bishops and the monastic church into Britain and the continent.

In the 8th and 9th centuries, when the great emigration of Irish scholars and ecclesiastics took place, the number of wandering bishops without dioceses became a reproach to the Irish church; and there can be no doubt that it led to much inconvenience and abuse, and was subversive of the stricter discipline that the popes had succeeded in establishing in the Western

church. They were accused of ordaining serfs without the consent of their lords, consecrating bishops *per saltum*, i.e. of making men bishops who had not previously received the orders of priests, and of permitting bishops to be consecrated by a single bishop. This custom can hardly, however, be a reproach to the Irish church, as the practice was never held to be invalid; and besides, the Nicene canons of discipline were perhaps not known in Ireland until comparatively late times. The isolated position of Ireland, and the existence of tribal organization in full vigour, explain fully the anomalies of Irish discipline, many of which were also survivals of the early Christian practices before the complete organization of the church.

After the death of St Patrick the bond between the numerous church families which his authority supplied was greatly relaxed; and the saint's most formidable opponents, the druids, probably regained much of their old power. The transition period which follows the loosening of a people's faith in its old religion and before the authority of the new is universally accepted as always a time of confusion and relaxation of morals. Such a period appears to have followed the fervour of St Patrick's time. To judge from the early literature the marriage-tie seems to have been regarded very lightly, and there can be little doubt that pagan marriage customs were practised long after the introduction of Christianity. The Brehon Laws assume the existence of married as well as unmarried clergy, and when St Patrick was seeking a bishop for the men of Leinster he asked for "a man of one wife." Marriage among the secular clergy went on in Ireland until the 15th century. Like the Gaulish druids described by Caesar, the poet (*filii*) and the druid possessed a huge stock of unwritten native lore, probably enshrined in verse which was learnt by rote by their pupils. The exalted position occupied by the learned class in ancient Ireland perhaps affords the key to the wonderful outbursts of scholarly activity in Irish monasteries from the 6th to the 9th centuries. That some of the *filii* embraced Christianity from the outset is evident from the story of Dubthach. As early as the second half of the 5th century Enda, a royal prince of Oriel (c. 450-540), after spending some time at Whithorn betook himself to Aranmore, off the coast of Galway, and founded a school there which attracted scholars from all over Ireland. The connexion between Ireland and Wales was strong in the 6th century, and it was from south Wales that the great reform movement in the Irish monasteries emanated. Findian of Clonard (c. 470-548) is usually regarded as the institutor of the type of monastery for which Ireland became so famous during the next few centuries. He spent some time in Wales, where he came under the influence of St David, Gildas and Cadoc; and on returning to Ireland he founded his famous monastery at Clonard (Co. Meath) about 520. Here no less than 3000 students are said to have received instruction at the same time. Such a monastery consisted of countless tiny huts of wattles and clay (or, where stone was plentiful, of beehive cells) built by the pupils and enclosed by a fosse, or trench, like a permanent military encampment. The pupils sowed their own corn, fished in the streams, and milked their own cows. Instruction was probably given in the open air. Twelve of Findian's disciples became known as the twelve apostles of Ireland, the monastic schools they founded becoming the greatest centres of learning and religious instruction not only in Ireland, but in the whole of the west of Europe. Among the most famous were Moville (Co. Down), founded by another Findian, c. 540; Clonmacnoise, founded by Kieran, 541; Derry, founded by Columba, 546; Clonfert, founded by Brendan, 552; Bangor, founded in 558 by Comgall; Durrow, founded by Columba, c. 553. The chief reform due to the influence of the British church<sup>1</sup> seems to have been the introduction of monastic life in the strict sense of the word, i.e. communities entirely separated from the laity with complete separation of the sexes.

One almost immediate outcome of the reformation effected

by Findian was that wonderful spirit of missionary enterprise which made the name of Scot and of Ireland so well known throughout Europe, while at the same time the Irish were being driven out of their colonies in Wales and south-west Britain owing to the advance of the Saxon power. In 563 Columba founded the monastery of Hi (Iona), which spread the knowledge of the Gospel among the Picts of the Scottish mainland. From this same solitary outpost went forth the illustrious Aidan to plant another Iona at Lindisfarne, which, "long after the poor parent brotherhood had fallen to decay, expanded itself into the bishopric of Durham." And Lightfoot claims for Aidan "the first place in the evangelization of the English race. Augustine was the apostle of Kent, but Aidan was the apostle of England." In 590 Columbanus, a native of Leinster (b. 543), went forth from Bangor, accompanied by twelve companions, to preach the Gospel on the continent of Europe. Columbanus was the first of the long stream of famous Irish monks who left their traces in Italy, Switzerland, Germany and France; amongst them being Gallus or St Gall, founder of St Gallen, Kilian of Würzburg, Virgil of Salzburg, Cathald of Tarentum and numerous others. At the beginning of the 8th century a long series of missionary establishments extended from the mouths of the Meuse and Rhine to the Rhône and the Alps, whilst many others founded by Germans are the offspring of Irish monks. Willibrord, the apostle of the Frisians, for instance, spent twelve years in Ireland. Other Irishmen seeking remote places wherein to lead the lives of anchorites, studded the numerous islands on the west coast of Scotland with their little buildings. Cormac ua Liathain, a disciple of St Columba, visited the Orkneys, and when the Northmen first discovered Iceland they found there books and other traces of the early Irish church. It may be mentioned that the geographer Dicuil who lived at the court of Charlemagne gives a description of Iceland which must have been obtained from some one who had been there. The peculiarities which owing to Ireland's isolation had survived were brought into prominence when the Irish missionaries came into contact with Roman ecclesiastics. The chief points of difference were the calculation of Easter and the form of the tonsure, in addition to questions of discipline such as the consecration of bishops *per saltum* and bishops without dioceses. With regard to tonsure it would seem that the druids shaved the front part of the head from ear to ear. St Patrick doubtless introduced the ordinary coronal tonsure, but in the period following his death the old druidical tonsure was again revived. In the calculation of Easter the Irish employed the old Roman and Jewish 84-years' cycle which they may have received from St Patrick and which had once prevailed all over Europe. Shut off from the world, they were probably ignorant of the new cycle of 532 years which had been adopted by Rome in 463. This question aroused a controversy which waxed hottest in England, and as the Irish monks stubbornly adhered to their traditions they were vehemently attacked by their opponents. As early as 633 the church of the south of Ireland, which had been more in contact with Gaul, had been won over to the Roman method of computation. The north and Iona on the other hand refused to give in until Adamán induced the north of Ireland to yield in 697, while Iona held out until 716, although by this time the monastery had lost its influence in Pictland. Owing to these controversies the real work of the early Irish missionaries in converting the pagans of Britain and central Europe, and sowing the seeds of culture there, is apt to be overlooked. Thus, when the Anglo-Saxon, Winfrid, surnamed Boniface, appeared in the kingdom of the Franks as papal legate in 723, to romanize the existing church of the time, neither the Franks, the Thuringians, the Alemanni nor the Bavarians could be considered as pagans. What Irish missionaries and their foreign pupils had implanted for more than a century quite independently of Rome, Winfrid organized and established under Roman authority partly by force of arms.

During the four centuries which elapsed between the arrival of St Patrick and the establishment of a central state in Dublin by the Norsemen the history of Ireland is almost a blank as

<sup>1</sup> It seems probable that the celebrated monastery of Whithorn in Galloway played some part in the reform movement, at any rate in the north of Ireland. Findian of Moville spent some years there.

regards outstanding events. From the time that the Milesians of Tara had come to be recognized as suzerains of the whole island all political development ceases. The annals contain nothing save a record of intertribal warfare, which the high-king was rarely powerful enough to stay. The wonderful achievements of the Irish monks did not affect the body politic as a whole, and it may be doubted if there was any distinct advance in civilization in Ireland from the time of Niall Nógíallach to the Anglo-Norman invasion. Niall's posterity held the position of *ardri* uninterruptedly until 1002. Four of his sons, Loigaire, Conall Crimthand, Fiacc and Maine, settled in Meath and adjoining territories, and their posterity were called the southern Hy Neill. The other four, Eogan, Enna Find, Cairpre and Conall Gulban, occupied the northern part of Ulster. Their descendants were known as the northern Hy Neill.<sup>1</sup> The descendants of Eogan were the O'Neills and their numerous kindred sept; the posterity of Conall Gulban were the O'Donnells and their kindred sept. Niall died in 406 in the English Channel whilst engaged in a marauding expedition. He was succeeded by his nephew Dathi, son of Fiachra, son of Eochaid Muigmedóin, who is stated to have been struck by lightning at the foot of the Alps in 428. Loigaire, son of Niall (428-463), is identified with the story of St Patrick. According to tradition it was during his reign that the codification of the *Senchus Mór* took place. A well-known story represents him as constantly at war with the men of Leinster. His successor, Ailill Molt (463-483), son of Dathi, is remarkable as being the last high-king for 500 years who was not a direct descendant of Niall.

In 503 a body of colonists under Fergus, son of Erc, moved from Dalriada to Argyll and effected settlements there. The circumstances which enabled the Scots to succeed in occupying Kintyre and Islay cannot now be ascertained. The little kingdom had great difficulty to maintain itself, and its varying fortunes are very obscure. Neither is it clear that bodies of Scots had not already migrated to Argyll. Diarmaid, son of Fergus Cerbaill (544-565), of the southern Hy Neill, undoubtedly professed Christianity though he still clung to many pagan practices, such as polygamy and the use of druidical incantations in battle. The annals represent him as getting into trouble with the Church on account of his violation of the right of sanctuary. At an assembly held at Tara in 554 Curnan, son of the king of Connaught, slew a nobleman, a crime punishable with death. The author of the deed fled for sanctuary to St Columba. But Diarmaid pursued him, and disregarding the opposition of the saint seized Curnan and hanged him. St Columba's kinsmen, the northern Hy Neill, took up the quarrel, and attacked and defeated the king at Culdreimne in 561. In this battle Diarmaid is stated to have employed druids to form an *airbe druad* (fence of protection?) round his host. A few years later Diarmaid seized by force the chief of Hy Maine, who had slain his herald and had taken refuge with St Ruadan of Lothra. According to the legend the saint, accompanied by St Brendan of Birr, followed the king to Tara and solemnly cursed it, from which time it was deserted. It has been suggested that Tara was abandoned during the plague of 548-549. Others have surmised that it was abandoned as a regular place of residence long before this, soon after the northern and southern branches of the Hy Neill had consolidated their power at Ailech and in Westmeath. Whatever truth there may be in the legend, it demonstrates conclusively the absence of a rallying point where the idea of a central government might have taken root. Aed, son of Ainmire (572-598) of the northern Hy Neill, figures prominently in the story of St Columba. It was during his reign that the famous assembly of Drumcett (near Newtownlimavaddy in Co. Derry) was held. The story goes that the *fiid* had increased in number to such an extent that they included one-third of the freemen. There was thus quite an army of impudent swaggering idlers roaming about the country and

quartering themselves on the chiefs and nobles during the winter and spring, story-telling, and lampooning those who dared to hesitate to comply with their demands.

Some idea of the style of living of the learned professions in early Ireland may be gathered from the income enjoyed in later times by the literati of Tír Conaill (Co. Donegal). It has been computed that no less than £2000 was set aside yearly in this small state for the maintenance of the class. No wonder, then, that Aed determined to banish them from Ireland. At the convention of Drumcett the number of *fiid* was greatly reduced, lands were assigned for their maintenance, the ollams were required to open schools and to support the inferior bards as teachers. This reform may have helped to foster the cultivation of the native literature, and it is possible that we owe to it the preservation of the Ulster epic. But the Irish were unfortunately incapable of rising above the saga, consisting of a mixture of prose and verse. Their greatest achievement in literature dates back to the dawn of history, and we find no more trace of development in the world of letters than in the political sphere. The Irishman, in his own language at any rate, seems incapable of a sustained literary effort, a consequence of which is that he invents the most intricate measures. Sense is thus too frequently sacrificed to sound. The influence of the professional literary class kept the clan spirit alive with their elaborate genealogies, and in their poems they only pandered to the vanity and vices of their patrons. That no new ideas came in may be gathered from the fact that the bulk of Irish literature so far published dates from before 800, though the MSS. which contain it are much later. Bearing in mind how largely the Finn cycle is modelled on the older Ulster epic, works of originality composed between 1000 and 1600 are with one or two exceptions conspicuously absent.

At the convention of Drumcett the status of the Dalriadic settlement in Argyll was also regulated. The *ardri* desired to make the colony an Irish state tributary to the high-king; but on the special pleading of St Columba it was allowed to remain independent. Aed lost his life in endeavouring to exact the *boroma* tribute from Brandub, king of Leinster, who defeated him at Dunbolg in 598. After several short reigns the throne was occupied by Aed's son Domnall (627-641). His predecessor, Suibne Menn, had been slain by the king of Dalaraide, Congal Claen. The latter was driven out of the country by Domnall, whereupon Congal collected an army of foreign adventurers made up of Saxons, Dalriadic Scots, Britons and Picts to regain his lands and to avenge himself on the high-king. In a sanguinary encounter at Mag Raith (Moira in Co. Down), which forms the subject of a celebrated romance, Congal was slain and the power of the settlement in Kintyre weakened for a considerable period. A curious feature of Hy Neill rule about this time was joint kingship. From 563 to 656 there were no less than five such pairs. In 681 St Moling of Ferns prevailed upon the *ardri* Finnachta (674-690) to renounce for ever the *boroma*, tribute, which had always been a source of friction between the supreme king and the ruler of Leinster. This was, however, unfortunately not the last of the *boroma*. Fergal (711-722), in trying to enforce it again, was slain in a famous battle at Allen in Kildare. As a sequel Fergal's son, Aed Allan (734-743), defeated the men of Leinster with great slaughter at Ballyshannon (Co. Kildare) in 737. If there was so little cohesion among the various provinces it is small wonder that Ireland fell such an easy prey to the Vikings in the next century. In 697 an assembly was held at Tara in which a law known as *Cáin Adamnáin* was passed, at the instance of Adamnáin, prohibiting women from taking part in battle; a decision that shows how far Ireland with its tribal system lagged behind Teutonic and Latin countries in civilization. A similar enactment exempting the clergy, known as *Cáin Patraic*, was agreed to in 803. The story goes that the *ardri* Aed Oirdnighe (797-810) made a hostile incursion into Leinster and forced the prime of Armagh and all his clergy to attend him. When representations were made to the king as to the impropriety of his conduct, he referred the matter to his adviser, Fothud, who was also a cleric. Fothud pronounced that

<sup>1</sup> The O'Neills who played such an important part in later Irish history do not take their name from Niall Nógíallach, though they are descended from him. They take their name from Niall Glúndub (d. 919).

the clergy should be exempted, and three verses purporting to be his decision are still extant.

*Invasion of the Northmen.*—The first incursion of the Northmen took place in A.D. 795, when they plundered and burnt the church of Rechru, now Lambay, an island north of Dublin Bay. When this event occurred, the power of the over-king was a mere shadow. The provincial kingdoms had split up into more or less independent principalities, almost constantly at war with each other. The oscillation of the centre of power between Meath and Tir Eogain, according as the *ardri* belonged to the southern or northern Hy Neill, produced corresponding perturbations in the balance of parties among the minor kings. The army consisted of a number of tribes, each commanded by its own chief, and acting as so many independent units without cohesion. The tribesmen owed fealty only to their chiefs, who in turn owed a kind of conditional allegiance to the over-king, depending a good deal upon the ability of the latter to enforce it. A chief might through pique or other causes withdraw his tribe even on the eve of a battle without such defection being deemed dishonourable. What the tribe was to the nation or the province, the *fine* or sept was to the tribe itself. The head of a sept had a voice not only in the question of war or peace, for that was determined by the whole tribe, but in all subsequent operations. However brave the individual soldiers of such an army might be, the army itself was unreliable against a well-organized and disciplined enemy. Again, such tribal forces were only levies gathered together for a few weeks at most, unprovided with military stores or the means of transport, and consequently generally unprepared to attack fortifications of any kind, and liable to melt away as quickly as they were gathered together. Admirably adapted for a sudden attack, such an army was wholly unfit to carry on a regular campaign or take advantage of a victory. These defects of the Irish military system were abundantly shown throughout the Viking period and also in Anglo-Norman times.

The first invaders were probably Norwegians<sup>1</sup> from Hórdaland in search of plunder and captives. Their attacks were not confined to the sea-coasts; they were able to ascend the rivers in their ships, and already in 801 they are found on the upper Shannon. At the outset the invaders arrived in small bodies, but as these met with considerable resistance large fleets commanded by powerful Vikings followed. With such forces it was possible to put fleets of boats on the inland lakes. Rude earthen or stockaded forts, serving as magazines and places of retreat, were erected; or in some cases use was made of strongholds already existing, such as Dun Almaín in Kildare, Dunlavin in Wicklow and Fermoy in Cork. Some of these military posts in course of time became trading stations or grew into towns. During the first half of the 9th century attacks were incessant in most parts of the island. In 801 we find Norwegians on the upper Shannon; in 820 the whole of Ireland was harried; and five years later we hear of Vikings in Co. Dublin, Meath, Kildare, Wicklow, Queen's Co., Kilkenny and Tipperary. However, the invaders do not appear to have acted in concert until 830. About this time a powerful leader, named Turgeis (Turgesius), accompanied by two nobles, Saxolt and Domrair (Thorir), arrived with a "royal fleet." Sailing up the Shannon they built strongholds on Lough Ree and devastated Connaught and Meath. Eventually Turgeis established himself in Armagh, whilst his wife Ota settled at Clonmacnoise and profaned the monastery church with pagan rites. Indeed, the numerous ecclesiastical establishments appear to have been quite as much the object of the invaders' fury as the civil authorities. The monastery of Armagh was rebuilt ten times, and as often destroyed. It was sacked three times in one month. Turgeis himself is reported to have usurped the abbacy of Armagh. To escape from the continuous attacks on the monasteries, Irish monks and scholars fled in large numbers to the continent carrying with them their precious books. Among them were

many of the greatest lights in the world of letters of the time, such as Sedulius Scottus and Johannes Scottus Erigena. The figure of Turgeis has given rise to considerable discussion, as there is no mention of him in Scandinavian sources. It seems probable that his Norwegian name was Thorgrids and he was possibly related to Godfred, father of Olaf the White, who figures prominently in Irish history a little later. Turgeis apparently united the Viking forces, as he is styled the first king of the Norsemen in Ireland. A permanent sovereignty over the whole of Ireland, such as Turgeis seems to have aimed at, was then as in later times impossible because of the state of society. During his lifetime various cities were founded—the first on Irish soil. Dublin came into existence in 840, and Waterford and Limerick appear in history about the same time. Although the Norsemen were constantly engaged in conflict with the Irish, these cities soon became important commercial centres trading with England, France and Norway. Turgeis was captured and drowned by the *ardri* Maelsechlainn in 844, and two years later Domrair was slain. However cruel and rapacious the Vikings may have been, the work of disorder and ruin was not all theirs. The condition of the country afforded full scope for the jealousy, hatred, cupidity and vanity which characterize the tribal state of political society. For instance, Fedilmid, king of Munster and archbishop of Cashel, took the opportunity of the misfortunes of the country to revive the claims of the Munster dynasty to be kings of Ireland. To enforce this claim he ravaged and plundered a large part of the country, took hostages from Niall Caille the over-king (833–845), drove out the *comarbs* of St Patrick, or archbishop of Armagh, and for a whole year occupied his place as bishop. On his return he plundered the terrors lands of Clonmacnoise "up to the church door," an exploit which was repeated the following year. There is no mention of his having helped to drive out the foreigners.

For some years after the death of Turgeis the Norsemen appear to have lacked a leader and to have been hard pressed. It was during this period that Dublin was chosen as the point of concentration for their forces. In 848 a Danish fleet from the south of England arrived in Dublin Bay. The Danes are called in Irish *Dubgaill*, or black foreigners, as distinguished from the *Finggaill*,<sup>2</sup> or white foreigners, i.e. Norwegians. The origin of these terms, as also of the Irish name for Norway (*Lochlann*), is obscure. At first the Danes and Norwegians appear to have made common cause, but two years later the new city of Dublin was stormed by the Danes. In 851 the Dublin Vikings succeeded in vanquishing the Danes after a three days' battle at Snaim Aigneach (Carlingford Lough), whereupon the defeated party under their leader Horn took service with Cerball, king of Ossory. Even in the first half of the 9th century there must have been a great deal of intermarriage between the invaders and the native population, due in part at any rate to the number of captive women who were carried off. A mixed race grew up, recruited by many Irish of pure blood, whom a love of adventure and a lawless spirit led away. This heterogeneous population was called *Gallgoidel* or foreign Irish (whence the modern name Galloway), and like their northern kinsmen they betook themselves to the sea and practised piracy. The Christian element in this mixed society soon lapsed to a large extent, if not entirely, into paganism. The Scandinavian settlements were almost wholly confined to the seaport towns, and except Dublin included none of the surrounding territory. Owing to its position and the character of the country about it, especially the coast-land to the north of the Liffey which formed a kind of border-land between the territories of the kings of Meath and Leinster, a considerable tract passed into the possession of so powerful a city as Dublin.

The social and political condition of Ireland, and the pastoral occupation of the inhabitants, were unfavourable to the development of foreign commerce, and the absence of coined money among them shows that it did not exist on an extensive scale.

<sup>1</sup> At this period it is extremely difficult to distinguish between Norwegians and Danes on account of the close connexion between the ruling families of both countries.

<sup>2</sup> This name survives in Fingall, the name of a district north of Dublin City. Dubgall is contained in the proper names MacDougall, MacDowall.

The foreign articles of luxury (dress, ornaments, wine, &c.) required by them were brought to the great *oenachs* or fairs held periodically in various parts of the country. A flourishing commerce, however, soon grew up in the Scandinavian towns; mints were established, and many foreign traders—Flemings, Italians and others—settled there. It was through these Scandinavian trading communities that Ireland came into contact with the rest of Europe in the 11th and 12th centuries. If evidence were needed it is only necessary to point to the names of three of the Irish provinces, Ulster, Leinster, Munster, which are formed from the native names (*Ulaid, Loigin, Muma-n*) with the addition of Norse *stæw*; and the very name by which the island is now generally known is Scandinavian in form (*Ira-land*, the land of the Irish). The settlers in the Scandinavian towns early came to be looked upon by the native Irish as so many septs of a tribe added to the system of petty states forming the Irish political system. They soon mixed in the domestic quarrels of neighbouring tribes, at first selling their protection, but afterwards as vassals, sometimes as allies, like the septs and tribes of the Goidel among themselves. The latter in turn acted in similar capacities with the Irish-Norwegian chiefs, Irish tribes often forming part of the Scandinavian armies in Britain. This intercourse led to frequent intermarriage between the chiefs and nobility of the two peoples. As an instance, the case of Cerball, king of Osory (d. 887), may be cited. Eyvindr, surnamed *Austmaðr*, "the east-man,"<sup>1</sup> son of Björn, agreed to defend Cerball's territory on condition of receiving his daughter *Raforta* in marriage. Among the children of this marriage were *Helgi Magri*, one of the early settlers in Iceland, and *Thurida*, wife of *Thorstein* the Red. Three other daughters of Cerball married Scandinavians: *Gormfaith* (*Kormlöß*) married *Grímolf*, who settled in Iceland, *Frígerda* married *Thorir Hyma*, and *Ethne* (*Edna*) married *Hlöðver*, father of *Earl Sigurd Djgri* who fell at *Clontarf*. Cerball's son *Domnall* (*Duniall*) was the founder of an Icelandic family, whilst the names *Raudi* and *Baugr* occur in the same family. Hence the occurrence of such essentially Irish names as *Konnal*, *Kjarn*, *Njall*, *Kormakr*, *Brigit*, *Kaölin*, &c., among Icelanders and Norwegians cannot be a matter for surprise; nor that a number of Norse words were introduced into Irish, notably terms connected with trade and the sea.

The obscure contest between the Norwegians and Danes for supremacy in Dublin appears to have made the former feel the need of a powerful leader. At any rate, in 857-852 the king of *Lochlann* (Norway) sent his son *Amlaib* (*Olaf the White*) to assume sovereignty over the Norsemen in Ireland and to receive tribute and vassals. From this time it is possible to speak of a Scandinavian kingdom of Dublin, a kingdom which lasted almost without interruption until the Norman Conquest. The king of Dublin exercised overlordship over the other Viking communities in the island, and thus became the most dangerous opponent of the *ardri*, with whom he was constantly at variance. *Amlaib* was accompanied by *Ivar*, who is stated in one source to have been his brother. Some writers wish to identify this prince with the famous *Ivar Beinlaus*, son of *Ragnar Lodbrok*. *Amlaib* was opposed to the *ardri* *Maelsechlainn I.* (846-863) who had overcome *Turgeis*. This brave ruler gained a number of victories over the Norsemen, but in true Irish fashion they were never followed up. Although his successor *Aed Finnliath* (863-870) gave his daughter in marriage to *Amlaib*, no better relations were established. The king of Dublin was certainly the most commanding figure in Ireland in his day, and during his lifetime the Viking power was greatly extended. In 870 he captured the strongholds of *Dumbarton* and *Dunseverick* (*Co. Antrim*). He disappears from the scene in 873. One source represents him as dying in Ireland, but the circumstances are quite obscure. *Ivar* only survived *Olaf* two or three years, and it is stated that he died a Christian. During the ensuing period Dublin was the scene of constant family feuds, which weakened

its power to such an extent that in 901 *Dublin* and *Waterford* were captured by the Irish and were obliged to acknowledge the supremacy of the high-king. The Irish Annals state that there were no fresh invasions of the Northmen for about forty years dating from 877. During this period Ireland enjoyed comparative rest notwithstanding the intertribal feuds in which the Norse settlers shared, including the campaigns of *Cormac*, son of *Cullenan*, the scholarly king-bishop of *Cashel*.

Towards the end of this interval of repose a certain *Sigtrygg*, who was probably a great-grandson of the *Ivar* mentioned above, addressed himself to the task of winning back the kingdom of his ancestor. *Waterford* was retaken in 914 by *Ivar*, grandson of *Ragnall* and *Earl Ottir*, and *Sigtrygg* won a signal victory over the king of *Leinster* at *Cenn Fuait* (*Co. Kilkenny*?) two years later. *Dublin* was captured, and the high-king *Niall Glúndub* (910-919) prepared to oppose the invaders. A battle of prime importance was gained by *Sigtrygg* over the *ardri*, who fell fighting gallantly at *Kilmashogue* near *Dublin* in 919. Between 920 and 970 the Scandinavian power in Ireland reached its zenith. The country was desolated and plundered by natives and foreigners alike. The lower *Shannon* was more thoroughly occupied by the Norsemen, with which fact the rise of *Limerick* is associated. *Carlow*, *Kilkenny* and the territory round *Lough Neagh* were settled, and after the capture of *Lough Erne* in 932 much of *Longford* was colonized. The most prominent figures at this time were *Muirchertach* "of the leather cloaks," son of *Niall Glúndub*, *Cellachan* of *Cashel* and *Amlaib* (*Olaf*) *Cuarán*. The first-named waged constant warfare against the foreigners and was the most formidable opponent the Scandinavians had yet met. In his famous circuit of Ireland (941) he took all the provincial kings, as well as the king of *Dublin*, as hostages, and after keeping them for five months at *Ailech* he handed them over to the feeble titular *ardri*, showing that his loyalty was greater than his ambition. Unlike *Muirchertach*, *Cellachan* of *Cashel*, the hero of a late romance, was not particular whether he fought for or against the Norsemen. In 920 *Sigtrygg* (d. 927) was driven out of *Dublin* by his brother *Godfred* (d. 934) and retired to *York*, where he became king of *Northumbria*. His sons *Olaf* and *Godfred* were expelled by *Æthelstan*. The former, better known as *Amlaib* (*Olaf*) *Cuarán*, married the daughter of *Constantine*, king of *Scotland*, and fought at *Brunanburh* (938). Born about 920, he perhaps became king of *York* in 941. Expelled in 944-945 he went to *Dublin* and drove out his cousin *Blákäre*, son of *Godfred*. At the same time he held sway over the kingdom of *Man* and the *Isles*. We find this romantic character constantly engaged on expeditions in *England*, *Ireland* and *Scotland*. In 956 *Congalach*, the high-king, was defeated and slain by the Norse of *Dublin*. In 973 his son *Domnall*, in alliance with *Amlaib*, defeated the high-king *Domnall O'Neill* at *Cell Mona* (*Kilmoon* in *Co. Meath*). This *Domnall O'Neill*, son of *Muirchertach*, son of *Niall Glúndub*, was the first to adopt the name *O'Neill* (*Ir. ua, ó* = "grandson"). The tanists or heirs of the northern and southern *Hy Neill* having died, the throne fell to *Maelsechlainn II.*, of the *Cland Colmáin*, the last of the *Hy Neill* who was undisputed king of *Ireland*. *Maelsechlainn*, who succeeded in 980, had already distinguished himself as king of *Meath* in war with the Norsemen. In the first year of his reign as high-king he defeated them in a bloody battle at *Tara*, in which *Amlaib's* son, *Ragnall*, fell. This victory, won over the combined forces of the Scandinavians of *Dublin*, *Man* and the *Isles*, compelled *Amlaib* to deliver up all his captives and hostages,—among whom were *Domnall Claen*, king of *Leinster*, and several notables—to forgo the tribute which he had imposed upon the southern *Hy Neill* and to pay a large contribution of cattle and money. *Amlaib's* spirit was so broken by this defeat that he retired to the monastery of *Iff*, where he died the same year.

*The Dalcaisis Dynasty*.—We have already seen that the dominant race in *Munster* traced descent from *Ailill Aulom*. The *Cashel* dynasty claimed to descend from his eldest son *Eogan*, whilst the *Dalcaissians* of *Clare* derived their origin from a younger son *Cormac Cas*. *Ailill Aulom* is said to have ordained that the

<sup>1</sup> In Anglo-Norman times the Scandinavians of *Dublin* and other cities are always called *Ostmen*, i.e. Eastmen; hence the name *Ostmanstown*, now *Oxmanstown*, a part of the city of *Dublin*.

succession to the throne should alternate between the two lines, as in the case of the Hy Neill. This, however, is perhaps a fiction of later poets who wished to give lustre to the ancestry of Brian Boruma, as very few of the Dalcais princes appear in the list of the kings of Cashel. The Dalcaissians play no prominent part in history until, in the middle of the 10th century, they were ruled by Kennedy (Cennétig), son of Lorcan, king of Thomond (d. 954), by whom their power was greatly extended. He left two sons, Mathgamain (Mahon) and Brian, called Brian Boruma, probably from a village near Killaloe.<sup>1</sup> About the year 920 a Viking named Tomrair, son of Elgi, had seized the lower Shannon and established himself in Limerick, from which point constant incursions were made into all parts of Munster. After a period of guerrilla warfare in the woods of Thomond, Mathgamain concluded a truce with the foreigners, in which Brian refused to join. Thereupon Mathgamain crossed the Shannon and gained possession of the kingdom of Cashel, as Dunchad, the representative of the older line, had just died. Receiving the support of several of the native tribes, he felt himself in a position to attack the settlements of the foreigners in Munster. This aroused the ruler of Limerick, Ivar, who determined to carry the war into Thomond. He was supported by Maelmud, king of Desmond, and Donoban, king of Hy Fidgeinte, and Hy Cairpri. Their army was met by Mathgamain at Sulchoit near Tipperary, where the Norsemen were defeated with great slaughter (968). This decisive victory gave the Dalcais Limerick, which they sacked and burnt, and Mathgamain then took hostages of all the chiefs of Munster. Ivar escaped to Britain, but returned after a year and entrenched himself at Inis Cathaig (Scattery Island in the lower Shannon). A conspiracy was formed between Ivar and his son Dubcenn and the two Munster chieftains Donoban and Maelmud. Donoban was married to the daughter of a Scandinavian king of Waterford, and his own daughter was married to Ivar of Waterford.<sup>2</sup> In 976 Inis Cathaig was attacked and plundered by the Dalcais and the garrison, including Ivar and Dubcenn, slain. Shortly before this Mathgamain had been murdered by Donoban, and Brian thus became king of Thomond, whilst Maelmud succeeded to Cashel. In 977 Brian made a sudden and rapid inroad into Donoban's territory, captured his fortress and slew the prince himself with a vast number of his followers. Maelmud, the other conspirator, met with a like fate at Belach Lechta in Barnaderg (near Ballyorgan). After this battle Brian was acknowledged king of all Munster (978). After reducing the Déisi, who were in alliance with the Northmen of Waterford and Limerick, in 984 he subdued Ossory and took hostages from the kings of East and West Leinster. In this manner he became virtually king of Leth Moga.

This rapid rise of the Dalcaissian leader was bound to bring him into conflict with the *ardri*. Already in 982 Maelsechlainn had invaded Thomond and uprooted the venerable tree under which the Dalcais rulers were inaugurated. After the battle of Tara he had placed his half-brother Gluniarind, son of Amlaib Cuarán, in Dublin. This prince was murdered in 989 and was succeeded by Sigtrygg Silkiskeggi, son of Amlaib and Gormfaith, sister of Maelmorda, king of Leinster. In the same year Maelsechlainn took Dublin and imposed an annual tribute on the city. During these years there were frequent trials of strength between the *ardri* and the king of Munster. In 992 Brian invaded Meath, and four years later Maelsechlainn defeated Brian in Munster. In 998 Brian ascended the Shannon with a large force, intending to attack Connaught, and Maelsechlainn, who received no support from the northern Hy Neill, came to terms with him. All hostages held by the over-king from the Northmen and Irish of Leth Moga were to be given up to Brian, which was a virtual surrender of all his rights over the southern half of Ireland; while Brian on his part recognized Maelsechlainn as sole king of Leth Cuinn. In 1000 Leinster revolted against Brian and entered into an alliance with the king of Dublin. Brian advanced towards the city, halting at a place called Glen Mama near

Dunlavin (Co. Wicklow). He was attacked by the allied forces, who were repulsed with great slaughter. Maelmorda, king of Leinster, was taken prisoner, and Sigtrygg fled for protection to Ailech. The victor gave proof at once that he was not only a clever general but also a skilful diplomatist. Maelmorda was restored to his kingdom, Sigtrygg received Brian's daughter in marriage, whilst Brian took to himself the Dublin king's mother, the notorious Gormfaith, who had already been divorced by Maelsechlainn. After thus establishing peace and consolidating his power, Brian returned to his residence Cenn Corad and matured his plan of obtaining the high-kingship for himself. When everything was ready he entered Mag Breg with an army consisting of his own troops, those of Ossory, his South Connaught vassals and the Norsemen of Munster. The king of Dublin also sent a small force to his assistance. Maelsechlainn, taken by surprise and feeling himself unequal to the contest, endeavoured to gain time. An armistice was concluded, during which he was to decide whether he would give Brian hostages (*i.e.* abdicate) or not. He applied to the northern Hy Neill to come to his assistance, and even offered to abdicate in favour of the chief of the Cinél Eogain, but the latter refused unless Maelsechlainn undertook to cede to them half the territory of his own tribe, the Cland Colmáin. The attempt to unite the whole of the Eremonian against the Eberian race and preserve a dynasty that had ruled Ireland for 600 years, having failed, Maelsechlainn submitted to Brian, and without any formal act of cession the latter became *ardri*. During a reign of twelve years (1002-1014) he is said to have effected much improvement in the country by the erection and repair of churches and schools, and the construction of bridges, causeways, roads and fortresses. We are also told that he administered rigid and impartial justice and dispensed royal hospitality. As he was liberal to the bards, they did not forget his merits.

Towards the end of Brian's reign a conspiracy was entered into between Maelmorda, king of Leinster, and his nephew Sigtrygg of Dublin. The ultimate cause of this movement was an insult offered by Murchad, Brian's son, to the king of Leinster, who was egged on by his sister Gormfaith. Sigtrygg secured promises of assistance from Sigurd, earl of Orkney, and Brodir of Man. In the spring of 1014 Maelmorda and Sigtrygg had collected a considerable army in Dublin, consisting of contingents from all the Scandinavian settlements in the west in addition to Maelmorda's own Leinster forces, the whole being commanded by Sigurd, earl of Orkney. This powerful prince, whose mother was a daughter of Cerball of Ossory (d. 887), appears to have aimed at the supreme command of all the Scandinavian settlements of the west, and in the course of a few years conquered the kingdom of the Isles, Sutherland, Ross, Moray and Argyll. To meet such formidable opponents, Brian, now an old man unable to lead in person, mustered all the forces of Munster and Connaught, and was joined by Maelsechlainn in command of the forces of Meath. The northern Hy Neill and the Ulaid took no part in the struggle. Brian advanced into the plain of Fingall, north of Dublin, where a council of war was held. The longest account of the battle that followed occurs in a source very partial to Brian and the deeds of Munstermen, in which Maelsechlainn is accused of treachery, and of holding his troops in reserve. The battle, generally known as the battle of Clontarf, though the chief fighting took place close to Dublin, about the small river Tolka, was fought on Good Friday 1014. After a stout and protracted resistance the Norse forces were routed. Maelsechlainn with his Meathmen came down on the fugitives as they tried to cross the bridge leading to Dublin or to reach their ships. On both sides the slaughter was terrible, and most of the leaders lost their lives. Brian himself perished along with his son Murchad and Maelmorda. This great struggle finally disposed of the possibility of Scandinavian supremacy in Ireland, but in spite of this it can only be regarded as a national misfortune. The power of the kingdom of Dublin had been already broken by the defeat of Amlaib Cuarán at Tara in 980, and the main result of the battle of Clontarf was to weaken the central power and to throw the

<sup>1</sup> On the name see K. Meyer *Eriu*, iv, pp. 71-73.

<sup>2</sup> Donoban, the son of this Ivar of Waterford, is the ancestor of the O'Donovans, Donoban that of the O'Donovans.



whole island into a state of anarchy. Although beaten on the field of battle the Norsemen still retained possession of their fortified cities, and gradually they assumed the position of native tribes. The Dalcaasian forces had been so much weakened by the great struggle that Maelsechlainn was again recognized as king of Ireland. However, the effects of Brian's revolution were permanent; the prescriptive rights of the Hy Neill were disputed, and from the battle of Clontarf until the coming of the Normans the history of Ireland consisted of a struggle for ascendancy between the O'Brians of Munster, the O'Neills of Ulster and the O'Connors of Connaught.

*From the Battle of Clontarf to the Anglo-Norman Invasion.*—The death of Maelsechlainn in 1022 afforded an opportunity for an able and ambitious man to subdue Ireland, establish a strong central government, break up the tribal system and further the gradual fusion of factions into a homogeneous nation. Such a man did not arise; those who afterwards claimed to be *ardri* lacked the qualities of founders of strong dynasties, and are termed by the annalists "kings with opposition." Brian was survived by two sons, Tadg and Donnchad, the elder of whom was slain in 1023. Donnchad (d. 1064) was certainly the most distinguished figure in Ireland in his day. He subdued more than half of Ireland, and almost reached the position once held by his father. His strongest opponent was his son-in-law Diarmait Mael-na-mBó, king of Leinster, who was also the foster-father of his brother Tadg's son, Tordelbach (Turlough) O'Brian. On the death of Diarmait in 1072 Tordelbach (d. 1086) reigned supreme in Leth Moga; Meath and Connaught also submitted to him, but he failed to secure the allegiance of the northern Hy Neill. He was succeeded by his son Muirchertach (d. 1119), who spent most of his life contending against his formidable opponent Donnall O'Lochlainn, king of Tir Eogain (d. 1127). The struggle for the sovereignty between these two rivals continued, with intervals of truce negotiated by the clergy, without any decisive advantage on either side. In 1102 Magnus Barefoot made his third and last expedition to the west with the express design of conquering Ireland. Muirchertach opposed him with a large force, and a conference was arranged at which a son of Magnus was betrothed to Biadmuin, daughter of the Irish prince. He was also mixed up in English affairs, and as a rule maintained cordial relations with Henry I. After the death of Donnall O'Lochlainn there was an interregnum of about fifteen years with no *ardri*, until Tordelbach (Turlough) O'Connor, king of Connaught, resolved to reduce the other provinces. Munster and Meath were repeatedly ravaged, and in 1151 he crushed Tordelbach (Turlough) O'Brian, king of Thomond, at Moanmor. O'Connor's most stubborn opponent was Muirchertach O'Lochlainn, with whom he wrestled for supremacy until the day of his death (1156). Tordelbach, who enjoyed a great reputation even after his death, was remembered as having thrown bridges over the Shannon, and as a patron of the arts. However, war was so constant in Ireland at this time that under the year 1145 the Four Masters describe the island as a "trembling sod." Tordelbach was succeeded by his son Ruadri (Roderick, *q.v.*), who after some resistance had to acknowledge Muirchertach O'Lochlainn's supremacy. The latter, however, was slain in 1166 in consequence of having wantonly blinded the king of Dal Araide. Ruadri O'Connor, now without a serious rival, was inaugurated with great pomp at Dublin.

Diarmait MacMurchada (Dermod MacMurrough), great-grandson of Diarmait Mael-na-mBó, as king of Leinster was by descent and position much mixed up with foreigners, and generally in a state of latent if not open hostility to the high-kings of the Hy Neill and Dalcais dynasties. He was a tyrant and a bad character. In 1152 Tigernan O'Rourke, prince of Breifne, had been dispossessed of his territory by Tordelbach O'Connor, aided by Diarmait, and the latter is accused also of carrying off Derbforgaill, wife of O'Rourke. On learning that O'Rourke was leading an army against him with the support of Ruadri, he burnt his castle of Ferns and went to Henry II. to seek assistance. The momentous consequences of this step belong

to the next section, and it now remains for us to state the condition of the church and society in the century preceding the Anglo-Norman invasion.

Although the Irish Church conformed to Roman usage in the matter of Easter celebration and tonsure in the 7th century, the bond between Ireland and Rome was only slight until several centuries later. Whatever co-ordination may have existed in the church of the 8th century was doubtless destroyed during the troubled period of the Viking invasions. It is probable that St Patrick established Armagh as a metropolitan see, but the history of the primacy, which during a long period can only have been a shadow, is involved in obscurity. Its supremacy was undoubtedly recognized by Brian Boru in 1004, when he laid 20 oz. of gold upon the high altar. In the 11th century a competitor arose in the see of Dublin. The Norse rulers were bound to come under the influence of Christianity at an early date. For instance, Amlaib Cuarán was formally converted in England in 942 and was baptized by Wulfhelm of Canterbury. The antithesis between the king of Dublin and the *ardri* seems to have had the effect of linking the Dublin Christian community rather with Canterbury than Armagh. King Sigtrygg founded the bishopric of Dublin in 1035, and the early bishops of Dublin, Waterford and Limerick were all consecrated by the English primate. As Lanfranc and Anselm were both anxious to extend their jurisdiction over the whole of Ireland, the submission of Dublin opened the way for Norman and Roman influences. At the beginning of the 12th century Gilbert, bishop of Limerick and papal legate, succeeded in winning over Celsus, bishop of Armagh (d. 1129), to the reform movement. Celsus belonged to a family which had held the see for 200 years; he was grandson of a previous primate and is said to have been himself a married man. Yet he became, in the skillful hands of Gilbert and Maelmaeóic O'Morgair, the instrument of overthrowing the hereditary succession to the primatial see. In 1118 the important synod of Rathbreisil was held, at which Ireland was divided into dioceses, this being the first formal attempt at getting rid of that anarchical state of church government which had hitherto prevailed. The work begun under Celsus was completed by his successor Maelmaeóic (Malachy). At a national synod held about 1134 Maelmaeóic, in his capacity as bishop of Armagh, was solemnly elected to the primacy; and armed with full power of church and state he was able to overcome all opposition. Under his successor Gelasius, Cardinal Paparo was despatched as supreme papal legate. At the synod of Kells (1152) there was established that diocesan system which has ever since continued without material alteration. Armagh was constituted the seat of the primacy, and Cashel, Tuam and Dublin were raised to the rank of archbishoprics. It was also ordained that tithes should be levied for the support of the clergy.

*Social Conditions.*—In the middle ages there were considerable forests in Ireland encompassing broad expanses of upland pastures and marshy meadows. It is traditionally stated that fences first came into general use in the 7th century. There were no cities or large towns before the arrival of the Norsemen; no stone bridges spanned the rivers; stepping stones or hurdle bridges at the fords or shallows offered the only mode of crossing the broadest streams, and connecting the unpaved roads or bridle paths which crossed the country over hill and dale from the principal *dáns*. The forests abounded in game, the red deer and wild boar were common, whilst wolves ravaged the flocks. Scattered over the country were numerous small hamlets, composed mainly of wicker cabins, among which were some which might be called houses; other hamlets were composed of huts of the rudest kind. Here and there were large villages that had grown up about groups of houses surrounded by an earthen mound or rampart; similar groups enclosed in this manner were also to be found without any annexed hamlet. Sometimes there were two or three circumvallations or even more, and where water was plentiful the ditch between was flooded. The simple rampart enclosed a space called *lis*<sup>1</sup> which contained

<sup>1</sup> The term *rath* was perhaps applied to the rampart, but both *lis* and *rath* are used to denote the whole structure.

the agricultural buildings and the groups of houses of the owners. The enclosed houses belonged to the free men (*aire*, pl. *airig*). The size of the houses and of the enclosing mound and ditch marked the wealth and rank of the *aire*. If his wealth consisted of chattels only, he was a *bó-aire* (cow-*aire*). When he possessed ancestral land he was a *flaith* or lord, and was entitled to let his lands for grazing, to have a hamlet in which lived labourers and to keep slaves. The larger fort with several ramparts was a *dún*, where the *rí* (chieftain) lived and kept his hostages if he had subreguli. The houses of all classes were of wood, chiefly wattles and wicker-work plastered with clay. In shape they were most frequently cylindrical, having conical roofs thatched with rushes or straw. The oratories were of the same form and material, but the larger churches and kingly banqueting halls were rectangular and made of sawn boards. Bede, speaking of a church built by Finan at Lindisfarne, says, "nevertheless, after the manner of the Scots, he made it not of stone but of hewn oak and covered it with reeds." When St Maelmaeóid in the first half of the 12th century thought of building a stone oratory at Bangor it was deemed a novelty by the people, who exclaimed, "we are Scotti not Galli." Long before this, however, stone churches had been built in other parts of Ireland, and many round towers. In some of the stone-forts of the south-west (Ir. *cathir*) the houses within the rampart were made of stone in the form of a bee-hive, and similar cloghans, as they are called, are found in the western isles of Scotland.

Here and there in the neighbourhood of the hamlets were patches of corn grown upon allotments which were gavelled, or redistributed, every two or three years. Around the *dúns* and *raiths*, where the corn land was the fixed property of the lord, the cultivation was better. Oats was the chief crop, but wheat, barley and rye were also grown. Much attention was paid to bee-keeping and market-gardening, which had probably been introduced by the church. The only industrial plants were flax and the dye-plants, chief among which were woad and rud, roid (a kind of bed-straw?). Portions of the pasture lands were reserved as meadows; the tilled land was manured. There are native names for the plough, so it may be assumed that some form of that implement, worked by oxen, yoked together with a simple straight yoke, was in use in early times. Wheeled carts were also known; the wheels were often probably only solid disks, though spoked wheels were used for chariots. Droves of swine under the charge of swineherds wandered through the forests; some belonged to the *rí*, others to lords (*flaith*) and others again to village communities. The house-fed pig was then as now an important object of domestic economy, and its flesh was much prized. Indeed, fresh pork was one of the inducements held out to visitors to the Irish Elysium. Horned cattle constituted the chief wealth of the country, and were the standard for estimating the worth of anything, for the Irish had no coined money and carried on all commerce by barter. The unit of value was called a *set*, a word denoting a jewel or precious object of any kind. The normal *set* was an average milk-cow. Gold, silver, bronze, tin, clothes and all other kinds of property were estimated in *sets*. Three *sets* were equal to a *cumal* (female slave). Sheep were kept everywhere for their flesh and their wool, and goats were numerous. Horses were extensively employed for riding, working in the fields and carrying loads. Irish horsemen rode without saddle or stirrups. So important a place did bee-culture hold in the rural economy of the ancient Irish that a lengthy section is devoted to the subject in the Brehon Laws. The honey was used both in cooking and for making mead, as well as for eating.

The ancient Irish were in the main a pastoral people. When they had sown their corn, they drove their herds and flocks to the mountains, where such existed, and spent the summer there, returning in autumn to reap their corn and take up their abode in their more sheltered winter residences. This custom of "booleyng" (Ir. *buailte*, "shielding") is not originally Irish, according to some writers, but was borrowed from the Scandinavians. Where the tribe had land on the sea-coast they also appear to have migrated thither in summer. The chase in the

summer occupied the freemen, not only as a source of enjoyment but also as a matter of necessity, for wolves were very numerous. For this purpose they bred dogs of great swiftness, strength and sagacity, which were much admired by the Romans.

The residences within enclosing ramparts did not consist of one house with several apartments, but every room was a separate house. Thus the buildings forming the residence of a well-to-do farmer of the *bó-aire* class as described in the Laws, consisted of a living-house in which he slept and took his meals, a cooking-house, a kiln for drying corn, a barn, a byre for calves, a sheep-fold and a pigsty. In the better classes the women had a separate house known as *grianán* (sun-chamber). The round houses were constructed in the following manner. The wall was formed of long stout poles placed in a circle close to one another, with their ends fixed firmly in the ground. The spaces between were closed in with rods (usually hazel) firmly interwoven. The poles were peeled and polished smooth. The whole surface of the wicker-work was plastered on the outside and made brilliantly white with lime, or occasionally striped in various colours, leaving the white poles exposed to view. There was no chimney; the fire was made in the centre of the house and the smoke escaped through a hole in the roof, or through the door as in Hebridean houses of the present day. Near the fire, fixed in a kind of holder, was a candle of tallow or raw beeswax. Around the wall in the houses of the wealthy were arranged the bedsteads, or rather compartments, with testers and fronts, sometimes made of carved yew. At the foot of each compartment, and projecting into the main room, there was a low fixed seat, often stuffed with some soft material, for use during the day. Besides these there were on the floor of the main apartment a number of detached movable couches or seats, all low, with one or more low tables of some sort. In the halls of the kings the position of each person's bed and seat, and the portion of meat which he was entitled to receive from the distributor, were regulated according to a rigid rule of precedence. Each person who had a seat in the king's house had his shield suspended over him. Every king had hostages for the fealty of his vassals; they sat unarmed in the hall, and those who had become forfeited by a breach of treaty or allegiance were placed along the wall in fetters. There were places in the king's hall for the judge, the poet, the harper, the various craftsmen, the juggler and the fool. The king had his bodyguard of four men always around him; these were commonly men whom he had saved from execution or redeemed from slavery. Among the miscellaneous body of attendants about the house of a king or noble were many Saxon slaves, in whom there was a regular trade until it was abolished by the action of the church in 1171. The slaves slept on the ground in the kitchen or in cabins outside the fort.

The children of the upper classes in Ireland, both boys and girls, were not reared at home but were sent elsewhere to be fostered. It was usual for a chief to send his child to one of his own sub-chiefs, but the parents often chose a chief of their own rank. For instance, the *ollam fili*, or chief poet, who ranked in some respects with a tribe-king, sent his sons to be fostered by the king of his own territory. Fosterage might be undertaken out of affection or for payment. In the latter case the fee varied according to rank, and there are numerous laws extant fixing the cost and regulating the food and dress of the child according to his position. Sometimes a chief acted as foster-father to a large number of children. The cost of the fosterage of boys seems to have been borne by the mother's property, that of the daughters by the father's. The ties created by fosterage were nearly as close and as binding on children as those of blood.

There is ample evidence that great luxury prevailed with regard to the marriage tie even after the introduction of Christianity, as marrying within the forbidden degrees and repudiation continued to be very frequent in spite of the efforts of the church. Marriage by purchase was universal, and the wealth of the contracting parties constituted the primary element of a legitimate union. The bride and bridegroom should be provided with a joint fortune proportionate to their rank. When they were of equal rank, and the family of each contributed an equal

share to the marriage portion, the marriage was legal in the full sense and the wife was a wife of equal rank. The church endeavoured to make the wife of a first marriage the only true wife; but concubinage was known as an Irish institution until long after the Anglo-Norman invasion, and it is recognized in the Laws. If a concubine had sons her position did not differ materially in some respects from that of a chief wife. As the tie of the sept was blood, all the acknowledged children of a man, whether legitimate or illegitimate, belonged equally to his sept. Even adulterine bastardy was no bar to a man becoming chief of his tribe, as in the case of Hugh O'Neill, earl of Tyrone. (See O'NEILL.)

The food of the Irish was very simple, consisting in the main of oaten cakes, cheese, curds, milk, butter, and the flesh of domestic animals both fresh and salted. The better classes were acquainted with wheat bread also. The food of the inhabitants of the Land of Promise consisted of fresh pork, new milk and ale. Fish, especially salmon, and game should of course be added to the list. The chief drinks were ale and mead.

The dress of the upper classes was similar to that of a Scottish Highlander before it degenerated into the present conventional garb of a highland regiment. Next the skin came a shirt (*liine*) of fine texture often richly embroidered. Over this was a tightly fitting tunic (*inar, lend*) reaching below the hips with a girdle at the waist. In the case of women the *inar* fell to the feet. Over the left shoulder and fastened with a brooch hung the loose cloak (*brat*), to which the Scottish plaid corresponds. The kilt seems to have been commonly worn, especially by soldiers, whose legs were usually bare, but we also hear of tight-fitting trousers extending below the ankles. The feet were either entirely naked or encased in shoes of raw hide fastened with thongs. Sandals and shoes of bronze are mentioned in Irish literature, and quite a number are to be seen in museums. A loose flowing garment, intermediate between the *brat* and *lend*, usually of linen dyed saffron, was commonly worn in outdoor life, and was still used in the Hebrides about 1700. A modified form of this over-tunic with loose sleeves and made of frieze formed probably the general covering of the peasantry. Among the upper classes the garments were very costly and variously coloured. It would seem that the number of colours in the dress indicated the rank of the wearer. The hair was generally worn long by men as well as women, and ringlets were greatly admired. Women braided their hair into tresses, which they confined with a pin. The beard was also worn long. Like all ancient and semi-barbarous people, the Irish were fond of ornaments. Indeed the profusion of articles of gold which have been found is remarkable in the Dublin Museum may be seen bracelets, armlets, finger-rings, torques, crescents, gorgets, necklets, fibulæ and diadems, all of solid gold and most exquisite workmanship.

The principal weapons of the Irish soldiers were a lance, a sword and a shield; though prior to the Anglo-Norman invasion they had adopted the battle-axe from the Scandinavians. The shields were of two kinds. One was the *scíath*, oval or oblong in shape, made of wicker-work covered with hide, and often large enough to cover the whole body. This was doubtless the form introduced by the Brythonic invaders. But round shields, smaller in size, were also commonly employed. These were made of bronze backed with wood, or of yew covered with hide. This latter type scarcely goes back to the round shield of the Bronze age. Armour and helmets were not generally employed at the time of the Anglo-Norman invasion.

In the Brehon Laws the land belongs in theory to the tribe, but this did not by any means correspond to the state of affairs. We find that the power of the petty king has made a very considerable advance, and that all the elements of feudalism are present, save that there was no central authority strong enough to organize the whole of Irish society on a feudal basis. The *tuath* or territory of a *rí* (represented roughly by a modern barony) was divided among the septs. The lands of a sept consisted of the estates in severality of the lords (*flaithi*), and of the *ferand duthaig*, or common lands of the sept. The dwellers on each of these kinds of land differed materially from each other.

On the former lived a motley population of slaves, horse-boys, and mercenaries composed of broken men of other clans, many of whom were fugitives from justice, possessing no rights either in the sept or tribe and entirely dependent on the bounty of the lord, and consequently living about his fortified residence. The poorer servile classes or cottiers, wood-cutters, swine-herds, &c., who had a right of domicile (acquired after three generations), lived here and there in small hamlets on the mountains and poorer lands of the estate. The good lands were let to a class of tenants called *fuidirs*, of whom there were several kinds, some grazing the land with their own cattle, others receiving both land and cattle from the lord. *Fuidirs* had no rights in the sept; some were true serfs, others tenants-at-will; they lived in scattered homesteads like the farmers of the present time. The lord was responsible before the law for the acts of all the servile classes on his estates, both new-comers and *senchleithe*, i.e. descendants of *fuidirs*, slaves, &c., whose families had lived on the estate during the time of three lords. He paid their blood-fines and received compensation for their slaughter, maiming or plunder. The *fuidirs* were the chief source of a lord's wealth, and he was consequently always anxious to increase them.

The freemen were divided into freemen pure and simple, freemen possessing a quantity of stock, and nobles (*flaithi*) having vassals. Wealth consisted in cattle. Those possessed of large herds of kine lent out stock under various conditions. In the case of a chief such an offer could not be refused. In return, a certain customary tribute was paid. Such a transaction might be of two kinds. By the one the freemen took *saer*-stock and retained his status. But if he accepted *daer*-stock he at once descended to the rank of a vassal. In this way it was possible for the chief to extend his power enormously. Rent was commonly paid in kind. As a consequence of this, in place of receiving the farm produce at his own home the chief or noble reserved to himself the right of quartering himself and a certain number of followers in the house of his vassal, a practice which must have been ruinous to the small farmers. Freemen who possessed twenty-one cows and upwards were called *airíg* (sing. *aire*), or, as we should say, had the franchise, and might fulfil the functions of bail, witness, &c. As the chief sought to extend his power in the *tuath*, he also endeavoured to aggrandize his position at the expense of other *tuatha* by compelling them to pay tribute to him. Such an aggregate of *tuatha* acknowledging one *rí* was termed a *nóthtuath*. The ruler of a *nóthtuath* paid tribute to the provincial king, who in his turn acknowledged at any rate in theory the overlordship of the *ardrí*.

The privileges and tributes of the provincial kings are preserved in a remarkable 10th century document, the *Book of Rights*. The rules of succession were extraordinarily complicated. Theoretically the members of a sept claimed common descent from the same ancestor, and the land belonged to the freemen. The chief and nobles, however, from various causes had come to occupy much of the territory as private property; the remainder consisted of tribe-land and commons-land. The portions of the tribe-land were not occupied for a fixed term, as the land of the sept was liable to gavelkind or redistribution from time to time. In some cases, however, land which belonged originally to a *flaith* was owned by a family; and after a number of generations such property presented a great similarity to the gavelled land. A remarkable development of family ownership was the *gailfine* system, under which four groups of persons, all nearly related to each other, held four adjacent tracts of land as a sort of common property, subject to regulations now very difficult to understand.<sup>1</sup> The king's mensal land, as also that of the tanist or successor to the royal office appointed during the king's lifetime, was not divided up but passed on in its entirety to the next individual elected to the position. When the family of an *aire* remained in possession of his estate in a corporate capacity, they formed a "joint and undivided family;" the head of which was an *aire*, and thus kept up the rank of the family. Three or four poor members of a sept might combine their property and agree to form a "joint family," one of whom

<sup>1</sup> See D'Arbois de Jubainville, *Revue celtique*, xxv. 1 ff. 181 ff.

as the head would be an *aire*. In consequence of this organization the homesteads of *airig* commonly included several families, those of his brothers, sons, &c. (see BREHON LAWS).

The ancient Irish never got beyond very primitive notions of justice. Retaliation for murder and other injuries was a common method of redress, although the church had endeavoured to introduce various reforms. Hence we find in the Brehon Laws a highly complicated system of compensatory payment; but there was no authority except public opinion to enforce the payment of the fines determined by the brehon in cases submitted to him.

There were many kinds of popular assemblies in ancient Ireland. The sept had its special meeting summoned by its chief for purposes such as the assessment of blood-fines due from the sept, and the distribution of those due to it. At larger gatherings the question of peace and war would be deliberated. But the most important of all such assemblies was the fair (*oenach*), which was summoned by a king, those summoned by the kings of provinces having the character of national assemblies. The most famous places of meeting were Tara, Telltown and Carman. The *oenach* had many objects. The laws were publicly promulgated or rehearsed; there were councils to deal with disputes and matters of local interest; popular sports such as horse-racing, running and wrestling were held; poems and tales were recited, and prizes were awarded to the best performers of every *dán* or art; while at the same time foreign traders came with their wares, which they exchanged for native produce, chiefly skins, wool and frieze. At some of these assemblies match-making played a prominent part. Tradition connects the better known of these fairs with pagan rites performed round the tombs of the heroes of the race; thus the assembly of Telltown was stated to have been instituted by Lugaid Lámfada. Crimes committed at an *oenach* could not be commuted by payment of fines. Women and men assembled for deliberation in separate *airechta* or gatherings, and no man durst enter the women's *airecht* under pain of death.

The noble professions almost invariably ran in families, so that members of the same household devoted themselves for generations to one particular science or art, such as poetry, history, medicine, law. The heads of the various professions in the *tuath* received the title of *ollam*. It was the rule for them to have paying apprentices living with them. The literary *ollam* or *filí* was a person of great distinction. He was provided with mensal land for the support of himself and his scholars, and he was further entitled to free quarters for himself and his retinue. The harper, the metal-worker (*cerad*), and the smith were also provided with mensal land, in return for which they gave to the chief their skill and the product of their labour as customary tribute (*béstigi*).

AUTHORITIES.—The *Annals of the Four Masters*, ed. J. O'Donovan (7 vols., Dublin, 1856); *Annals of Ulster* (4 vols., London, 1887-1892); Keating's *Forus Feasa ar Éirinn* (3 vols., ed. D. Comyn and P. Dinneen, London, 1902-1908); E. Windisch, *Táin Bó Cúalnge* (Leipzig, 1905), with a valuable introduction; P. W. Joyce, *A Social History of Ancient Ireland* (2 vols., London, 1903), also *A Short History of Ireland from the Earliest Times to 1608* (London, 1885); A. G. Ritchie, *A Short History of the Irish People* (Dublin, 1897); W. F. Skene, *Celtic Scotland* (5 vols., Edinburgh, 1876-1880); J. Rhys, "Studies in Early Irish History," in *Proceedings of the British Academy*, vol. i.; John MacNeill, papers in *New Ireland Review* (March 1906-February 1907); *Leabhar na gCeart*, ed. O'Donovan (Dublin, 1847); E. O'Curry, *The Manners and Customs of the Ancient Irish*, ed. W. K. Sullivan (3 vols., London, 1873); G. T. Stokes, *Ireland and the Celtic Church*, revised by H. J. Lawlor (London, 1907); J. Healy, *Ireland's Ancient Schools and Scholars* (Dublin, 1897); H. Zimmer, article "Keltische Kirche" in Hauck's *Realencyclopädie für protestantische Theologie und Kirche* (trans. A. Meyer, London, 1902), cf. H. Williams, "H. Zimmer on the History of the Celtic Church," *Zeitschr. f. celt. Phil.* iv, 527-574; H. Zimmer, "Die Bedeutung des irischen Elements in der mittelalterlichen Kultur," *Preussische Jahrbücher*, vol. lxx., trans. J. L. Edmonds, *The Irish Element in Medieval Culture* (New York, 1891); J. H. Todd, *St Patrick, the Apostle of Ireland* (Dublin, 1864); J. B. Bury, *Life of St Patrick* (London, 1905); W. Reeves, *Adamnan's Life of Columba* (Dublin, 1857; also ed. with introd. by J. T. Fowler, Oxford, 1894); M. Roger, *L'Enseignement des lettres classiques d'Ausone à Alcuin* (Paris, 1905); J. H. Todd, *The*

*War of the Gadhil with the Gall* (London, 1867); L. J. Vogt, *Dublin som Norsk By* (Christiania, 1897); J. Steenstrup, *Normannene*, vols. ii., iii. (Copenhagen, 1878-1882); W. G. Collingwood, *Scandinavian Britain* (London, 1908). (E. C. Q.)

#### History from the Anglo-Norman Invasion.

According to the *Metalogus* of John of Salisbury, who in 1155 went on a mission from King Henry II. to Pope Adrian IV., the only Englishman who has ever occupied the "Bull" of the papal chair, the pope in response to the envoy's prayers granted to the king of the English the hereditary lordship of Ireland, sending a letter, with a ring as the symbol of investiture. Giraldus Cambrensis, in his *Expugnatio Hibernica*, gives what purports to be the text of this letter, known as "the Bull Laudabiliter," and adds further a *Privilegium* of Pope Alexander III. confirming Adrian's grant. The *Privilegium* is undoubtedly spurious, a fact which lends weight to the arguments of those who from the 19th century onwards have attacked the genuineness of the "Bull." This latter, indeed, appears to have been concocted by Gerald, an ardent champion of the English cause in Ireland, from genuine letters of Pope Alexander III., still preserved in the *Black Book of the Exchequer*, which do no more than commend King Henry for reducing the Irish to order and extirpating *lontae abominatiosis spurcitiis*, and exhort the Irish bishops and chiefs to be faithful to the king to whom they had sworn allegiance.<sup>1</sup>

Henry was, indeed, at the outset in a position to dispense with the moral aid of a papal concession, of which even if it existed he certainly made no use. In 1156 Dermot MacMurrough (Diarmait MacMurchada), deposed for his tyranny from the kingdom of Leinster, repaired to Henry in Aquitaine (see *Early History* above). The king was busy with the French, but gladly seized the opportunity, and gave Dermot a letter authorizing him to raise forces in England. Thus armed, and provided with gold extorted from his former subjects in Leinster, Dermot went to Bristol and sought the acquaintance of Richard de Clare, earl of Pembroke, a Norman noble of great ability but broken fortunes. Earl Richard, whom later usage has named Strongbow, agreed to reconquer Dermot's kingdom for him. The stipulated consideration was the hand of Eva his only child, and according to feudal law his sole heiress, to whose issue lands and kingdoms would naturally pass. But Irish customs admitted no estates of inheritance, and Eva had no more right to the reversion of Leinster than she had to that of Japan. It is likely that Strongbow had no conception of this, and that his first collision with the tribal system was an unpleasant surprise. Passing through Wales, Dermot agreed with Robert Fitzstephen and Maurice Fitzgerald to invade Ireland in the ensuing spring.

About the 1st of May 1169 Fitzstephen landed on the Wexford shore with a small force, and next day Maurice de Prendergast brought another band nearly to the same spot. The invasion of Dermot joined them, and the Danes of Wexford soon submitted. According to agreement Dermot granted the territory of Wexford, which had never belonged to him, to Robert and Maurice and their heirs for ever; and here begins the conflict between feudal and tribal law which was destined to deluge Ireland in blood. Maurice Fitzgerald soon followed with a fresh detachment. About a year after the first landing Raymond Le Gros was sent over by Earl Richard with his advanced guard, and Strongbow himself landed near Waterford on the 23rd of August 1170 with 200 knights and about 1000 other troops.

The natives did not understand that this invasion was quite different from those of the Danes. They made alliances with the strangers to aid them in their intestine wars, and the annalist writing in later years (*Annals of Inishe Cē*) describes with pathetic brevity the change wrought in Ireland:—"Earl Strongbow came into Erin with Dermot MacMurrough to avenge his expulsion by Roderick, son of Turlough O'Connor; and Dermot gave

<sup>1</sup> The whole question is discussed by Mr J. H. Round in his article on "The Pope and the Conquest of Ireland" (*Commune of London*, 1899, pp. 171-200), where further references will be found.

him his own daughter and a part of his patrimony, and Saxon foreigners have been in Erin since then."

Most of the Norman leaders were near relations, many being descended from Nesta, daughter of Rhys Ap Tudor, prince of South Wales, the most beautiful woman of her time, and mistress of Henry I. Her children by that king were called FitzHenry. She afterwards married Gerald de Windsor, by whom she had three sons—Maurice, ancestor of all the Geraldines; William, from whom sprang the families of Fitzmaurice, Carew, Grace and Gerard; and David, who became bishop of St David's. Nesta's daughter, Angareth, married to William de Barri, bore the chronicler Giraldus Cambrensis, and was ancestress of the Irish Barries. Raymond le Gros, Hervey de Montmorency, and the Cogans were also descendants of Nesta, who, by her second husband, Stephen the Castellain, was mother of Robert Fitzstephen.

While waiting for Strongbow's arrival, Raymond and Hervey were attacked by the Danes of Waterford, whom they overthrew. Strongbow himself took Waterford and Dublin, and the Danish inhabitants of both readily combined with their French-speaking kinsfolk, and became firm supporters of the Anglo-Normans against the native Irish.

Alarmed at the principality forming near him, Henry invaded Ireland in person, landing near Waterford on the 18th of October 1172. Giraldus says he had 500 knights and many other soldiers; Regan, the metrical chronicler, says he had 4000 men, of whom 400 were knights; the *Annals of Lough Cé* that he had 240 ships. The Irish writers tell little about these great events, except that the king of the Saxons took the hostages of Munster at Waterford, and of Leinster, Ulster, Thomond and Meath at Dublin. They did not take in the grave significance of doing homage to a Norman king, and becoming his "man."

Henry's farthest point westward was Cashel, where he received the homage of Donald O'Brien, king of Thomond, but he does not appear to have been present at the famous synod.

Henry II.  
in Ireland.

Christian O'Conarchy, bishop of Lismore and papal legate, presided, and the archbishops of Dublin, Cashel and Tuam attended with their suffragans, as did many abbots and other dignitaries. The primate of Armagh, the saintly Gelasius, was absent, and presumably his suffragans also, but Giraldus says he afterwards came to the king at Dublin, and favoured him in all things. Henry's sovereignty was acknowledged, and constitutions made which drew Ireland closer to Rome. In spite of the "enormities and filthiness," which Giraldus says defiled the Irish Church, nothing worse could be found to condemn than marriages within the prohibited degrees and trifling irregularities about baptism. Most of the details rest on the authority of Giraldus only, but the main facts are clear. The synod is not mentioned by the Irish annalists, nor by Regan, but it is by Hoveden and Ralph de Diceto. The latter says it was held at Lismore, an error arising from the president having been bishop of Lismore. Tradition says the members met in Cormac's chapel.

Henry at first tried to be suzerain without displacing the natives, and received the homage of Roderick O'Connor, the high king. But the adventurers were uncontrollable, and he had to let them conquer what they could, exercising a precarious authority over the Normans only through a viceroys. The early governors seemingly had orders to deal as fairly as possible with the natives, and this involved them in quarrels with the "conquerors," whose object was to carve out principalities for themselves, and who only nominally respected the sovereign's wishes. The mail-clad knights were not uniformly successful against the natives, but they generally managed to occupy the open plains and fertile valleys. Geographical configuration preserved centres of resistance—the O'Neills in Tyrone and Armagh, the O'Donnells in Donegal, and the Macarthes in Cork being the largest tribes that remained practically unbroken. On the coast from Bray to Dundak, and by the navigable rivers of the east and south coasts, the Norman put his iron foot firmly down.

Prince John landed at Waterford in 1185, and the neighbouring

chiefs hastened to pay their respects to the king's son. Prince and followers alike soon earned hatred, the former showing the incurable vices of his character, and pulling the beards of the chieftains. After eight disgraceful months he left the government to John de Courci, but retained the title "Dominus Hiberniæ." It was even intended to crown him; and Urban III. sent a licence and a crown of peacock's feathers, which was never placed on his head. Had Richard I. had children Ireland might have become a separate kingdom.

Henry II. had granted Meath, about 800,000 acres, to Hugh de Lacy (d. 1186), reserving scarcely any prerogative to the crown, and making his vassal almost independent. De Lacy sublet the land among kinsmen and retainers, and to his grants the families of Nugent, Tyrell, Nangle, Tuyst, Fleming and others owe their importance in Irish history. It is not surprising that the Irish bordering on Meath should have thought De Lacy the real king of Ireland.

During his brother Richard I.'s reign, John's viceroys was William Marshal, earl of Pembroke, who married Strongbow's daughter, and thus succeeded to his claims in Leinster. John's reputation was no better in Ireland than in *King John*. England. He thwarted or encouraged the Anglo-Normans as best suited him, but on the whole they increased their possessions. In 1210 John, now king, visited Ireland again, and being joined by Cathal Croidverg O'Connor, king of Connaught, marched from Waterford by Dublin to Carrickfergus without encountering any serious resistance from Hugh de Lacy (second son of the Hugh de Lacy mentioned above), who had been made earl of Ulster in 1205. John did not venture farther west than Trim, but most of the Anglo-Norman lords swore fealty to him, and he divided the partially obedient districts into twelve counties—Dublin (with Wicklow), Meath (with Westmeath), Louth, Carlow, Kilkenny, Wexford, Waterford, Cork, Limerick, Kerry and Tipperary. John's resignation of his kingdom to the pope in 1213 included Ireland, and thus for the second time was the papal claim to Ireland formally recorded.

During Henry III.'s long reign the Anglo-Norman power increased, but underwent great modifications. Richard Marshal, grandson of Strongbow, and to a great extent heir of his power, was foully murdered by his own feudatories *Henry III. 1216-1272*.—men of his own race; and the colony never quite recovered this blow. On the other hand, the De Burghs, partly by alliance with the Irish, partly by sheer hard fighting, made good their claims to the lordship of Connaught, and the western O'Connors henceforth play a very subordinate part in Irish history. Tallage was first imposed on the colony in the first year of this reign, but yielded little, and tithes were not much better paid.

On the 14th of January 1217 the king wrote from Oxford to his justiciary, Geoffrey de Marisco, directing that no Irishman should be elected or preferred in any cathedral in Ireland, "since by that means our land might be disturbed, which is to be deprecated." This order was annulled in 1224 by Honorius III., who declared it "desitute of all colour of right and honesty." The pope's efforts failed, for in the 14th century several Cistercian abbeys excluded Irishmen, and as late as 1436 the monks of Abingdon complained bitterly that an Irish abbot had been imposed on them by lay violence. Parliament was not more liberal, for the statute of Kilkenny, passed in 1366, ordained that "no Irishman be admitted into any cathedral or collegiate church, nor to any benefice among the English of the land," and also "that no religious house situated among the English shall henceforth receive an Irishman to their profession." This was confirmed by the English parliament in 1416, and an Irish act of Richard III. enabled the archbishop of Dublin to collate Irish clerks for two years, an exception proving the rule. Many Irish monasteries admitted no Englishmen, and at least one attempt was made, in 1250, to apply the same rule to cathedrals. The races remained nearly separate, the Irish simply staying outside the feudal system. If an Englishman *Separation of the two races.*

slew an Irishman (except one of the five regal and privileged bloods) he was not to be tried for murder, for Irish law admitted composition (*eric*) for murder. In Magna Charta there is a proviso that foreign merchants shall be treated as English merchants are treated in the country whence the travellers came. Yet some enlightened men strove to fuse the two nations together, and the native Irish, or that section which bordered on the settlements and suffered great oppression, offered 8000 marks to Edward I. for the privilege of living under English law. The justiciary supported their petition, but the prelates and nobles refused to consent.

There is a vague tradition that Edward I. visited Ireland about 1256, when his father ordained that the prince's seal should have regal authority in that country. A vast number of documents remain to prove that he did not neglect Irish business. Yet this great king cannot be credited with any specially enlightened views as to Ireland.

**Edward I.**  
(1272-1307). Hearing with anger of enormities committed in his name, he summoned the viceroy, Robert de Ufford (d. 1298), to explain, who coolly said that he thought it expedient to wink at one knave cutting off another, "whereat the king smiled and bade him return into Ireland." The colonists were strong enough to send large forces to the king in his Scottish wars, but as there was no corresponding immigration this really weakened the English, whose best hopes lay in agriculture and the arts of peace, while the Celtic race waxed proportionally numerous. Outwardly all seemed fair. The De Burghs were supreme in Connaught, and English families occupied eastern Ulster. The fertile southern and central lands were dominated by strong castles. But Tyrone and Tyrconnel, and the mountains everywhere, sheltered the Celtic race, which, having reached its lowest point under Edward I., began to recover under his son.

In 1315, the year after Bannockburn, Edward Bruce landed near Larne with 6000 men, including some of the best knights in Scotland. Supported by O'Neill and other chiefs,

**Edward II.**  
(1307-1327). and for a time assisted by his famous brother, Bruce gained many victories. There was no general effort of the natives in their favour; perhaps the Irish thought one Norman no better than another, and their total incapacity for national organization forbade the idea of a native sovereign. The family quarrels of the O'Connors at this time, and their alliances with the Burkes, or De Burghs, and the Berminghams, may be traced in great detail in the annals—the general result being fatal to the royal tribe of Connaught, which is said to have lost 10,000 warriors in the battle of Templetogether. In other places the English were less successful, the Butlers being beaten by the O'Carrolls in 1318, and Richard de Clare falling about the same time in the decisive battle of Dysert O'Dea. The O'Briens re-established their sway in Thomond and the illustrious name of Clare disappears from Irish history. Edward Bruce fell in battle near Dundalk, and most of his army crossed the channel, leaving behind a reputation for cruelty and rapacity. The colonists were victorious, but their organization was undermined, and the authority of the crown, which had never been able to keep the peace, grew rapidly weaker. Within twenty years after the great victory of Dundalk, the quarrels of the barons allowed the Irish to recover much of the land they had lost.

John de Bermingham, earl of Louth, the conqueror of Bruce, was murdered in 1320 by the Gernons, Cusacks, Everards and other English of that county, who disliked his firm government. They were never brought to justice. **Edward III.** (1327-1377). Talbot of Malahide and two hundred of Bermingham's relations and adherents were massacred at the same time. In 1333, William de Burgh, the young earl of Ulster, was murdered by the Mandevilles and others; in this case signal vengeance was taken, but the feudal dominion never recovered the blow, and on the north-east coast the English laws and language were soon confined to Drogheda and Dundalk. The earl left one daughter, Elizabeth, who was of course a royal ward. She married Lionel, duke of Clarence, and from her springs the

royal line of England from Edward IV., as well as James V. of Scotland and his descendants.

The two chief men among the De Burghs were loth to hold their lands of a little absentee girl. Having no grounds for opposing the royal title to the wardship of the heiress, they abjured English law and became Irish chieftains. As such they were obeyed, for the king's arm was short in Ireland. The one appropriated Mayo as the Lower (Oughter) M'William, and the earldom of Mayo perpetuates the memory of the event. The other as the Upper (Eighther) M'William took Galway, and from him the earls of Clanricarde afterwards sprung.

Edward III. being busy with foreign wars had little time to spare for Ireland, and the native chiefs everywhere seized their opportunity. Perhaps the most remarkable of these aggressive chiefs was Lysaght O'More, who reconquered Leix. Clyn the Franciscan annalist, whose Latinity is so far above the mediæval level as almost to recall Tacitus, sums up Lysaght's career epigrammatically: "He was a slave, he became a master; he was a subject, he became a prince (*de servo dominus, de subiecto princeps effectus*)." The two great earldoms whose contests form a large part of the history of the south of Ireland were created by Edward III. James Butler, eldest son of Edmund, earl of Carrick, became earl of Ormonde and palatine of Tipperary in 1328. Next year Maurice Fitzgerald was made earl of Desmond, and from his three brethren descended the historic houses of the White Knight, the knight of Glin, and the knight of Kerry. The earldom of Kildare dates from 1316. In this reign too was passed the statute of Kilkenny (*q.v.*), a confession by the crown that obedient subjects were the minority. The enactments against Irish dress and customs, and against marriage and fostering proved a dead letter.

In two expeditions to Ireland Richard II. at first overcame all opposition, but neither had any permanent effect. Art MacMurrough, the great hero of the Leinster Celts, practically had the best of the contest. The king in his despatches divided the population into Irish enemies, Irish rebels and English subjects. As he found them so he left them, lingering in Dublin long enough to lose his own crown. But for MacMurrough and his allies the house of Lancaster might never have reigned. No English king again visited Ireland until James II., declared by his English subjects to have abdicated, and by the more outspoken Scots to have forfeited the crown, appealed to the loyalty or piety of the Catholic Irish.

Henry IV. had a bad title, and his necessities were conducive to the growth of the English constitution, but fatal to the Anglo-Irish. His son Thomas, duke of Clarence, was viceroy in 1401, but did very little. "Your son," wrote the Irish council to Henry, "is so destitute of money that he has not a penny in the world, nor can borrow a single penny, because all his jewels and his plate that he can spare, and those which he must of necessity keep, are pledged to lie in pawn." The nobles waged private war unrestrained, and the game of playing off one chieftain against another was carried on with varying success. The provisions of the statute of Kilkenny against trading with the Irish failed, for markets cannot exist without buyers.

The brilliant reign of Henry V. was a time of extreme misery to the colony in Ireland. Half the English-speaking people fled to England, where they were not welcome. The disastrous reign of the third Lancastrian completed the discomfiture of the original colony in Ireland.

Quarrels between the Ormonde and Talbot parties paralysed the government, and a "Pale" of 30 m. by 20 was all that remained. Even the walled towns, Kilkenny, Ross, Wexford, Kinsale, Youghal, Clonmel, Kilmallock, Thomastown, Fethard and Cashel, were almost starved out; Waterford itself was half ruined and half deserted.

Henry VI. (1422-1461). Only one parliament was held for thirty years, but taxation was not remitted on that account. No viceroy even pretended to reside continuously. The north and west were still

**Richard II.**  
(1377-1399).

**Henry IV.**  
(1399-1413).

**Henry V.**  
(1413-1422).

**Henry VI.**  
(1422-1461).

worse off than the south. Some thoughtful men saw clearly the danger of leaving Ireland to be seized by the first chance comer, and the *Libel of English Policy*, written about 1436, contains a long and interesting passage declaring England's interests in protecti<sup>g</sup> Ireland as "a boterasse and a poste" of her own power. Sir John Talbot, immortalized by Shakespeare, was several times viceroy; he was almost uniformly successful in the field, but feeble in council. He held a parliament at Trim which made one law against men of English race wearing moustaches, lest they should be mistaken for Irishmen, and another obliging the sons of agricultural labourers to follow their father's vocation under pain of fine and imprisonment. The earls of Shrewsbury are still earls of Waterford, and retain the right to carry the white staff as hereditary stewards, and the palatine jurisdiction over Wexford was taken away by Henry VIII. The Ulster annalists give a very different estimate of the great Talbot from that of Shakespeare: "A son of curses for his venom and a devil for his evils; and the learned say of him that there came not from the time of Herod, by whom Christ was crucified, any one so wicked in evil deeds." (*O'Donovan's Four Masters*).

In 1449 Richard, duke of York, right heir by blood to the throne of Edward III., was forced to yield the regency of France to his rival Somerset, and to accept the Irish viceroyalty. He landed at Howth with his wife Cicely Neville, and Margaret of Anjou hoped thus to get rid of one who was too great for a subject. The Irish government was given to him for ten years on unusually liberal terms. He ingratiated himself with both races, taking care to avoid identification with any particular family. At the baptism of his son George—"false, fleeting, perjured Clarence"—who was born in Dublin Castle, Desmond and Ormonde stood sponsors together. In legislation Richard fared no better than others. The rebellion of Jack Cade, claiming to be a Mortimer and cousin to the duke of York, took place at this time. This adventurer, at once ludicrous and formidable, was a native of Ireland, and was thought to be put forward by Richard to test the popularity of the Yorkist cause. Returning suddenly to England in 1450, Richard left the government to James, earl of Ormonde and Wiltshire, who later married Eleanor, daughter of Edmund Beaufort, duke of Somerset, and was deeply engaged on the Lancastrian side. This earl began the deadly feud with the house of Kildare, which lasted for generations. After Blore Heath Richard was attainted by the Lancastrian parliament, and returned to Dublin, where the colonial parliament acknowledged him and assumed virtual independence. A separate coinage was established, and the authority of the English parliament was repudiated. William Overy, a bold squire of Ormonde's, offered to arrest Richard as an attainted traitor, but was seized, tried before the man whom he had come to take, and hanged, drawn and quartered. The duke only maintained his separate kingdom about a year. His party triumphed in England, but he himself fell at Wakefield.

Among the few prisoners taken on the bloody field of Towton was Ormonde, whose head long adorned London Bridge. He and his brothers were attainted in England and by the Yorkist parliament in Ireland, but the importance of the family was hardly diminished by this. For the first six years of Edward's reign the two Geraldine earls engrossed official power. The influence of Queen Elizabeth Woodville, whom Desmond had offended, then made itself felt. Tiptoft, earl of Worcester, became deputy. He was an accomplished Oxonian, who made a speech at Rome in such good Latin as to draw tears from the eyes of that great patron of letters Pope Pius II. (Aeneas Sylvius). But his Latinity did not soften his manners, and he was thought cruel even in that age. Desmond was beheaded, ostensibly for using Irish exactions, really, as the partisans of his family hold, to please Elizabeth. The remarkable lawlessness of this reign was increased by the practice of coining. Several mints had been established since Richard of York's time; the standards varied and imitation was easy.

During Richard III.'s short reign the earl of Kildare, head of the Irish Yorkists, was the strongest man in Ireland. He espoused the cause of Lambert Simnel (1487), whom the Irish in general seem always to have thought a true Plantagenet. The Italian primate, Octavian de Palatio, knew better, and incurred the wrath of Kildare by refusing to officiate at the impostor's coronation. The local magnates and several distinguished visitors attended, and Lambert was shown to the people borne aloft on "great D'Arcy of Platten's" shoulders. His enterprise ended in the battle of Stoke, near Newark, where the flower of the Anglo-Irish soldiery fell. "The Irish," says Bacon, "did not fail in courage or ferocity, but, being almost naked men, only armed with darts and spears, it was rather an execution than a fight upon them." Conspicuous among Henry VII.'s adherents in Ireland were the citizens of Waterford, who, with the men of Clonmel, Callan, Fethard and the Butler connexion generally, were prepared to take the field in his favour. Waterford was equally conspicuous some years later in resisting Perkin Warbeck, who besieged it unsuccessfully, and was chased by the citizens, who fitted out a fleet at their own charge. The king conferred honour and rewards on the loyal city, to which he gave the proud title of *urbis intacta*. Other events of this reign were the parliament of Drogheda, held by Sir Edward Poynings, which gave the control of Irish legislation to the English council ("the Poynings's Act"—the great bone of contention in the later days of Flood and Grattan), and the battle of Knockdoe, in which the earl of Kildare used the viceregal authority to avenge a private quarrel.

Occupied in pleasure or foreign enterprise, Henry VIII. at first paid little attention to Ireland. The royal power was practically confined to what in the previous century had become known as the "Pale," that is Dublin, Louth, Kildare and a part of Meath, and within this narrow limit the earls of Kildare were really more powerful than the crown. Waterford, Drogheda, Dundalk, Cork, Limerick and Galway were not Irish, but rather free cities than an integral part of the kingdom; and many inland towns were in the same position. The house of Ormonde had created a sort of small Pale about Kilkenny, and part of Wexford had been colonized by men of English race. The Desmonds were Irish in all but pride of blood. The Barretts, Condons, Courcies, Savages, Arundels, Carews and others had disappeared or were merged in the Celtic mass. Anglo-Norman nobles became chiefs of pseudo-tribes, which acknowledged only the Brehon law, and paid dues and services in kind. These pseudo-tribes were often called "nations," and a vast number of exactions were practised by the chiefs. "Coyne and livery"—the right of free-quarters for man and beast—arose among the Anglo-Normans, and became more oppressive than any native custom. When Henry took to business, he laid the foundation of reconquest. The house of Kildare, which had actually besieged Dublin (1534), was overthrown, and the Pale saved from a standing danger (see FITZGERALD). But the Pale scarcely extended 20 m. from Dublin, a march of uncertain width intervening between it and the Irish districts. Elsewhere, says an elaborate report, all the English folk were of "Irish language and Irish condition," except in the cities and walled towns. Down and Louth paid black rent to O'Neill, Meath and Kildare to O'Connor, Wexford to the Kavanaghs, Kilkenny and Tipperary to O'Carroll, Limerick to the O'Briens, and Cork to the MacCarthyes. MacMurrough Kavanagh, in Irish eyes the representative of King Dermot, received an annual pension from the exchequer. Henry set steadily to work to reassert the royal title. He assumed the style of king of Ireland, so as to get rid of the notion that he held the island of the pope. The Irish chiefs acknowledged his authority and his ecclesiastical supremacy, abjuring at the same time that of the Holy See. The lands of the earl of Shrewsbury and other absentees, who had performed no duties, were resumed; and both Celtic and feudal nobles were encouraged to come to court. Here begins the long line of official deputies, often men of moderate birth and fortune.

**Richard of York in Ireland.**

**Richard III.**

**Henry VII. (1485-1509).**

**Henry VIII. (1509-1547).**

**Edward IV. (1461-1483).**

Butler and Geraldine, O'Neill and O'Donnell, continued to spill each other's blood, but the feudal and tribal systems were alike doomed. In the names of these Tudor deputies and other officers we see the origin of many great Irish families—Skeffington, Brabazon, St Leger, Fitzwilliam, Wingfield, Bellingham, Carew, Bingham, Loftus and others. Nor were the Celts overlooked. O'Neill and O'Brien went to London to be invested as earls of Tyrone and Thomond respectively. O'Donnell, whose descendants became earls of Tyrconnel, went to court and was well received. The pseudo-chief MacWilliam became earl of Clanricarde, and others reached lower steps in the peerage, or were knighted by the king's own hand. All were encouraged to look to the crown for redress of grievances, and thus the old order slowly gave place to the new.

The moment when Protestantism and Ultramontanism are about to begin their still unfinished struggle is a fit time to notice the chief points in medieval Irish church history.

**The Irish Church.** Less than two years before Strongbow's arrival Pope Eugenius had established an ecclesiastical constitution in Ireland depending on Rome, but the annexation was very imperfectly carried out, and the hope of fully asserting the Petrine claims was a main cause of Adrian's gift to Henry II. Hitherto the Scandinavian section of the church in Ireland had been most decidedly inclined to receive the hierarchical and diocesan as distinguished from the monastic and quasi-tribal system. The bishops or abbots of Dublin derived their succession from Canterbury from 1038 to 1162, and the bishops of Waterford and Limerick also sought consecration there. But both Celt and Norman acknowledged the polity of Eugenius, and it was chiefly in the matters of tithes, Peter's pence, canonical degrees and the observance of festivals that Rome had still victories to gain. Between churchmen of Irish and English race there was bitter rivalry; but the theory that the ancient Celtic church remained independent, and as it were Protestant, while the English colony submitted to the Vatican, is a mere controversial figment. The crown was weak and papal aggression made rapid progress. It was in the Irish church, about the middle of the 13th century, that the system of giving jurisdiction to the bishops "in temporalibus" was adopted by Innocent IV. The vigour of Edward I. obtained a renunciation in particular cases, but the practice continued unabated. The system of provisions was soon introduced at the expense of free election, and was acknowledged by the statute of Kilkenny. In the more remote districts it must have been almost a matter of necessity. Many Irish parishes grew out of primitive monasteries, but other early settlements remained monastic, and were compelled by the popes to adopt the rule of authorized orders, generally that of the Augustinian canons. That order became much the most numerous in Ireland, having not less than three hundred houses. Of other sedentary orders the Cistercians were the most important, and the mendicants were very numerous. Both Celtic chiefs and Norman nobles founded convents after Henry II.'s time, but the latter being healthier were most distinguished in this way. Religious houses were useful as abodes of peace in a turbulent country, and the lands attached were better cultivated than those of lay proprietors. Attempts to found a university at Dublin (1311) or Drogheda (1465) failed for want of funds. The work of education was partially done by the great abbeys, boys of good family being brought up by the Cistercians of Dublin and Jerpoint, and by the Augustinians of Dublin, Kells and Connel, and girls by the canonesses of Gracedieu. A strong effort was made to save these six houses, but Henry VIII. would not hear of it, and there was no Irish Wolsey partially to supply the king's omissions.

Ample evidence exists that the Irish church was full of abuses before the movement under Henry VIII. We have detailed accounts of three sees—Clonmacnoise, Enaghduane and Ardagh. Ross, also in a wild district, was in rather better case. But even in Dublin strange things happened; thus the archiepiscopal crozier was in pawn for eighty years from 1449. The morals of the clergy were no better than in other countries, and we have evidence of many scandalous irregularities. But perhaps the most

severe condemnation is that of the report to Henry VIII. in 1515. "There is," says the document, "no archbishop, no bishop, abbot, no prior, parson, no vicar, no any other person of the church, high or low, great or small, English or Irish, that useth to preach the word of God, saving the poor friars beggars. . . . the church of this land use not to learn any other science, but the law of canon, for covetise of lucre transitory." Where his hand reached Henry had little difficulty in suppressing the monasteries or taking their lands, which Irish chiefs swallowed as greedily as men of English blood. But the friars, though pretty generally turned out of doors, were themselves beyond Henry's power, and continued to preach everywhere among the people. Their devotion and energy may be freely admitted; but the mendicant orders, especially the Carmelites, were not uniformly distinguished for morality. Monasticism was momentarily suppressed under Oliver Cromwell, but the Restoration brought the monks back to their old haunts. The Jesuits, placed by Paul III. under the protection of Conn O'Neill, "prince of the Irish of Ulster," came to Ireland towards the end of Henry's reign, and helped to keep alive the Roman tradition. Anglicanism was regarded as a symbol of conquest and intrusion. The *Four Masters* thus describes the Reformation: "A heresy and new error arising in England, through pride, vain glory, avarice, and lust, and through many strange sciences, so that the men of England went into opposition to the pope and to Rome." The destruction of relics and images and the establishment of a schismatic hierarchy is thus recorded: "Though great was the persecution of the Roman emperors against the church, scarcely had there ever come so great a persecution from Rome as this."

The able opportunist Sir Anthony St Leger, who was accused by one party of opposing the Reformation and by the other of lampooning the Sacrament, continued to rule during the early days of Edward VI. To him succeeded **Edward VI. (1547-1553).** Sir Edward Bellingham, a Puritan soldier whose hand was heavy on all who disobeyed the king. He bridled Connaught by a castle at Athlone, and Munster by a garrison at Leighlin Bridge. The O'Mores and O'Connors were brought low, and forts erected where Maryborough and Philipstown now stand. Both chiefs and nobles were forced to respect the king's representative, but Bellingham was not wont to flatter those in power, and his administration found little favour in England. Sir Francis Bryan, Henry VIII.'s favourite, succeeded him, and on his death St Leger was again appointed. Neither St Leger nor his successor Sir James Croft could do anything with Ulster, where the papal primate Wauchope, a Scot by birth, stirred up rebellion among the natives and among the Hebridean invaders. But little was done under Edward VI. to advance the power of the crown, and that little was done by Bellingham.

The English government long hesitated about the official establishment of Protestantism, and the royal order to that effect was withheld until 1551. Copies of the new **The Reformation.** liturgy were sent over, and St Leger had the communion service translated into Latin, for the use of priests and others who could read, but not in English. The popular feeling was strong against innovation, as Edward Staples, bishop of Meath, found to his cost. The opinions of Staples, like those of Cranmer, advanced gradually until at last he went to Dublin and preached boldly against the mass. He saw men shrink from him on all sides. "My lord," said a beneficed priest, whom he had himself promoted, and who wept as he spoke, "before ye went last to Dublin ye were the best beloved man in your diocese that ever came in it, now ye are the worst beloved. . . . Ye have preached against the sacrament of the altar and the saints, and will make us worse than Jews. . . . The country folk would eat you. . . . Ye have more curses than ye have hairs of your head, and I advise you for Christ's sake not to preach at Navan." Staples answered that preaching was his duty, and that he would not fail; but he feared for his life. On the same prelate fell the task of conducting a public controversy with the archbishop of Armagh, George Dowdall, which of course ended in the conversion



of neither. Dowdall fled; his see was treated as vacant, and Cranmer cast about him for a Protestant to fill St Patrick's chair. His first nominee, Dr Richard Turner, resolutely declined the honour, declaring that he would be unintelligible to the people; and Cranmer could only answer that English was spoken in Ireland, though he did indeed doubt whether it was spoken in the diocese of Armagh. John Bale, a man of great learning and ability, became bishop of Ossory. There is no reason to doubt his sincerity, but he was coarse and intemperate—Froude roundly calls him a foul-mouthed ruffian—without the wisdom of the serpent or the harmlessness of the dove. His choice rhetoric stigmatized the dean of St Patrick's as as-headed, a blockhead who cared only for his kitchen and his belly.

The Reformation having made no real progress, Mary found it easy to recover the old ways. Dowdall was restored; Staples and others were deprived. Bale fled for bare life, and his see was treated as vacant. Yet the queen found it impossible to restore the monastic lands, though she showed some disposition to scrutinize the titles of grantees. She was Tudor enough to declare her intention of maintaining the old prerogatives of the crown against the Holy See, and assumed the royal title without papal sanction. Paul IV. was fain to curb his fiery temper, and to confer graciously what he could not withhold. English Protestants fled to Ireland to escape the Marian persecution; but had the reign continued a little longer, Dublin would probably have been no safe place of refuge.

Mary scarcely varied the civil policy of her brother's ministers. Gerald of Kildare, who had been restored to his estates by Edward VI., was created earl of Kildare. The plan of settling Leix and Offaly by dividing the country between colonists and natives holding by English tenure failed, owing to the unconquerable love of the people for their own customs. But resistance gradually grew fainter, and we hear little of the O'Connors after this. The O'Mores, reduced almost to brigandage, gave trouble till the end of Elizabeth's reign, and a member of the clan was chief contriver of the rebellion of 1641. Maryborough and Philipstown, King's county and Queen's county, commemorate Mary's marriage.

Anne Boleyn's daughter succeeded quietly, and Sir Henry Sidney was sworn lord-justice with the full Catholic ritual. When Thomas Radclyffe, earl of Sussex, superseded him as lord-lieutenant, the litany was chanted in English, both cathedrals having been painted, and scripture texts substituted for "pictures and popish fancies." At the beginning of 1560 a parliament was held which restored the ecclesiastical legislation of Henry and Edward. In two important points the Irish Church was made more dependent on the state than in England: *congregatio dicitur* were abolished and heretics made amenable to royal commissioners or to parliament without reference to any synod or convocation. According to a contemporary list, this parliament consisted of 3 archbishops, 17 bishops, 23 temporal peers, and members returned by 10 counties and 28 cities and boroughs. Some of the Irish bishops took the oath of supremacy, some were deprived. In other cases Elizabeth connived at what she could not prevent, and hardly pretended to enforce uniformity except in the Pale and in the large towns.

Ulster demanded the immediate attention of Elizabeth. Her father had conferred the earldom of Tyrone on Conn Bacach O'Neill, with remainder to his supposed son Matthew, created baron of Dungannon, the offspring of a smith's wife at Dundalk, who in her husband's lifetime brought the child to Conn as his own. When the chief's legitimate son Shane grew up he declined to be bound by this arrangement, which the king may have made in partial ignorance of the facts. "Being a gentleman," he said, "my father never refused no child that any woman namyd to be his." When Tyrone died, Matthew's son, Brian O'Neill, baron of Dungannon, claimed his earldom under the patent. Shane being chosen O'Neill by his tribe claimed to be chief by election,

and earl as Conn's lawful son. Thus the English government was committed to the cause of one who was at best an adulterine bastard, while Shane appeared as champion of hereditary right (See O'NEILL). Shane maintained a contest which had begun under Mary until 1567, with great ability and a total absence of morality, in which Sussex had no advantage over him. The lord-lieutenant twice tried to have Shane murdered; once he proposed to break his safe-conduct; and he held out hopes of his sister's hand as a snare. Shane was induced to visit London, where the government detained him for some time. On his return to Ireland, Sussex was outmatched both in war and diplomacy; the loyal chiefs were crushed one by one; and the English suffered checks of which the moral effect was ruinous. Shane diplomatically acknowledged Elizabeth as his sovereign, and sometimes played the part of a loyal subject, wreaking his private vengeance under colour of expelling the Scots from Ulster. At last, in 1566, the queen placed the sword of state in Sidney's strong grasp. Shane was driven helplessly from point to point, and perished miserably at the hands of the MacDonnells, whom he had so often oppressed and insulted.

Peace was soon broken by disturbances in the south. The earl of Desmond having shown rebellious tendencies was detained for six years in London. Treated leniently, but grievously pressed for money, he tried to escape, and, the attempt being judged treasonable, he was persuaded to surrender his estates—to receive them back or not at the queen's discretion. Seizing the opportunity, English adventurers proposed to plant a military colony in the western half of Munster, holding the coast from the Shannon to Cork harbour. Some who held obsolete title-deeds were encouraged to go to work at once by the example of Sir Peter Carew, who had established his claims in Carlow. Carew's title had been in abeyance for a century and a half, yet most of the Kavanaghs attorned to him. Falling foul of Ormonde's brothers, seizing their property and using great cruelty and violence, Sir Peter drove the Butlers, the only one among the great families really loyal, into rebellion. Ormonde, who was in London, could alone restore peace; all his disputes with Desmond were at once settled in his favour, and he was even allowed to resume the exaction of coyne and livery, the abolition of which had been the darling wish of statesmen. The Butlers returned to their allegiance, but continued to oppose Carew, and great atrocities were committed on both sides. Sir Peter had great but undefined claims in Munster also, and the people there took warning. His imitators in Cork were swept away. Sidney first, and after him Humphrey Gilbert, could only circumscribe the rebellion. The presidency of Munster, an office the creation of which had long been contemplated, was then conferred on Sir John Perrot, who drove James "Fitzmaurice" Fitzgerald into the mountains, reduced castles everywhere, and destroyed a Scottish contingent which had come from Ulster to help the rebels. Fitzmaurice came in and knelt in the mud at the president's feet, confessing his sins; but he remained the real victor. The colonizing scheme was dropped, and the first presidency of Munster left the Desmonds and their allies in possession. Similar plans were tried unsuccessfully in Ulster, first by a son of Sir Thomas Smith, afterwards by Walter Devereux, earl of Essex, a knight-errant rather than a statesman, who was guilty of many bloody deeds. He treacherously captured Sir Brian O'Neill and massacred his followers. The Scots in Rathlin were slaughtered wholesale. Essex struggled on for more than three years, seeing his friends gradually drop away, and dying ruined and unsuccessful.

Towards the end of 1575 Sidney was again persuaded to become viceroy. The Irish recognized his great qualities, and he went everywhere without interruption. Henceforth presidencies became permanent institutions. Sir William Drury in Munster hanged four hundred persons in one year, Sir Nicholas Malby in reducing the Connaught Burkes spared neither young nor old, and burned all corn and houses. The Desmonds determined on a great effort. A holy war was declared. Fitzmaurice landed in Kerry with a few followers, and accompanied by the

Mary  
(1553-  
1558).

Elizabeth  
(1559-  
1603).

Rebellion  
of Shane  
O'Neill.

First  
Desmond  
Rebellion,  
1574.

famous Nicholas Sanders, who was armed with a legate's commission and a banner blessed by the pope. Fitzmaurice fell soon after in a skirmish near Castleconnell, but Sanders and Desmond's brothers still kept the field. When it was too late to act with effect, Desmond himself, a vain man, neither frankly loyal nor a bold rebel, took the field. He surprised Youghal, then an English town, by night, sacked it, and murdered the people. Roused at last, Elizabeth sent over Ormonde as general of Munster, and after long delay gave him the means of conducting a campaign. It was as much a war of Butlers against Geraldines as of loyal subjects against rebels, and Ormonde did his work only too well. Lord Balinglass raised a hopeless subsidiary revolt in Wicklow (1580), which was signalized by a crushing defeat of the lord deputy, Lord Grey de Wilton (Arthegal) in Glenmalur. A force of Italians and Spaniards landing at Smerwick in Kerry, Grey hurried thither, and the foreigners, who had no commission, surrendered at discretion, and were put to the sword. Neither Grey nor the Spanish ambassador seems to have seen anything extraordinary in thus disposing of inconvenient prisoners. Spenser and Raleigh were present. Sanders perished obscurely in 1581, and in 1583 Desmond himself was hunted down and killed in the Kerry mountains. More than 500,000 Irish acres were forfeited to the crown. The horrors of this war it is impossible to exaggerate. The *Four Masters* says that the lowing of a cow or the voice of a ploughman could scarcely be heard from Cashel to the farthest point of Kerry; Ormonde, who, with all his severity, was honourably distinguished by good faith, claimed to have killed 5000 men in a few months. Spenser, an eye-witness, says famine slew far more than the sword. The survivors were unable to walk, but crawled out of the woods and glens. "They looked like anatomies of death; they did eat the dead carrion and one another soon after, insomuch as the very carcasses they spared not to scrape out of their graves; . . . to a plot of watercourses or shamrocks they flocked as to a feast."

In 1584 Sir John Perrot, the ablest man available after Sidney's retirement, became lord-deputy. Sir John Norris, famed in the Netherland wars, was president of Munster, and so impressed the Irish that they averred him to be in league with the devil. Perrot held a parliament in 1585 in which the number of members was considerably increased. He made a strenuous effort to found a university in Dublin, and proposed to endow it with the revenues of St Patrick's, reasonably arguing that one cathedral was enough for any city. Here he was opposed by Adam Loftus, archbishop of Dublin and chancellor, who had expressed his anxiety for a college, but had no idea of endowing it at his own expense. The colonization of the Munster forfeitures was undertaken at this time. It failed chiefly from the grants to individuals who neglected to plant English farmers, and were often absentees themselves. Raleigh obtained 42,000 acres. The quit rents reserved to the crown were less than one penny per acre. Racked with the stone, hated by the official clique, thwarted on all sides, Perrot was goaded into using words capable of a reasonable interpretation. Archbishop Loftus pursued him to the end. He died in the Tower of London under sentence for treason, and we may charitably hope that Elizabeth would have pardoned him. In his will, written after sentence, he emphatically repudiates any reasonable intention—"I deny my Lord God if ever I proposed the same."

In 1584 Hugh O'Neill, if O'Neill he was (being second son of Matthew, mentioned above), became chief of part of Tyrone; in 1587 he obtained the coveted earldom, and in 1593 was the admitted head of the whole tribe. A quarrel with the government was inevitable, and, Hugh Roe O'Donnell having joined him, Ulster was united against the crown. In 1598 James Fitzthomas Fitzgerald assumed the title of Desmond, to which he had some claims by blood, and which he pretended to hold as Tyrone's gift. Tyrone had received a crown of peacock's feathers from the pope, who was regarded by many as king of Ireland. The title of *Sagan* or straw-ropes earl has been generally given to the Desmond pretender. Both ends of the island were soon

in a blaze, and the *Four Masters* says that in seventeen days there was not one son of a Saxon left alive in the Desmond territories. Edmund Spenser lost his all, escaping only to die of misery in a London garret. Tyrone more than held his own in the north, completely defeated Sir Henry Bagnal in the battle of the Yellow Ford (1598), invaded Munster, and ravaged the lands of Lord Barrymore, who had remained true to his allegiance. Tyrone's ally, Hugh Roe O'Donnell, overthrew the president of Connaught, Sir Conyers Clifford. "The Irish of Connaught," says the *Four Masters*, "were not pleased at Clifford's death; . . . he had never told them a falsehood." Robert Devereux, earl of Essex, came over in 1599 with a great army, but did nothing of moment, was outgeneralled and outwitted by Tyrone, and threw up his command to enter on the mad and criminal career which led to the scaffold. In 1600 Sir George Carew became president of Munster, and, as always happened when the crown was well served, the rebellion was quickly put down. Charles Blount, Lord Mountjoy (afterwards earl of Devonshire), who succeeded Essex, joined Carew, and a Spanish force which landed at Kinsale surrendered. The destruction of their crops starved the people into submission, and the contest was only less terrible than the first Desmond war because it was much shorter. In Ulster Mountjoy was assisted by Sir Henry Docwra, who founded the second settlement at Derry, the first under Edward Randolph having been abandoned. Hugh O'Donnell sought help in Spain, where he died. Tyrone submitted at last, craving pardon on his knees, renouncing his Celtic chiefly, and abjuring all foreign powers, but still retaining his earldom, and power almost too great for a subject. Scarcely was the compact signed when he heard of the great queen's death. He burst into tears, not of grief, but of vexation at not having held out for better terms.

In reviewing the Irish government of Elizabeth we shall find much to blame, a want of truth in her dealings and of steadiness in her policy. Violent efforts of coercion were succeeded by fits of clemency, of parsimony *Elizabethan Conquest of Ireland.* or of apathy. Yet it is fair to remember that she was surrounded by enemies, that her best energies were expended in the death-struggle with Spain, and that she was rarely able to give undivided attention to the Irish problem. After all she conquered Ireland, which her predecessors had failed to do, though many of them were as crooked in action and less upright in intention. Considering the times, Elizabeth cannot be called a persecutor. "Do not," she said to the elder Essex, "seek too hastily to bring people that have been trained in another religion from that in which they have been brought up." Elizabeth saw that the Irish could only be reached through their own language. But for that harvest the labourers were necessarily few. The fate of Bishop Daly of Kildare, who preached in Irish, and who thrice had his house burned over his head, was not likely to encourage missionaries. In all wild parts divine service was neglected, and wandering friars or subtle Jesuits, supported by every patriotic or religious feeling of the people, kept Ireland faithful to Rome. Against her many shortcomings we must set the queen's foundation of the university of Dublin, which has been the most successful English institution in Ireland, and which has continually borne the fairest fruit.

Great things were expected of James I. He was Mary Stuart's son, and there was a curious antiquarian notion afloat that, because the Irish were the original "Scotti," a Scottish king would sympathize with Ireland. Corporate towns set up the mass, and Mountjoy, who could argue as well as fight, had to teach them a sharp lesson. Finding Ireland conquered and in no condition to rise again, James established circuits and a complete system of shires. Sir John Davies was sent over as solicitor-general. His famous book (*Discoverie of the State of Ireland*) in which he glorifies his own and the king's exploits gives far too much credit to the latter and far too little to his great predecessor.

Two legal decisions swept away the customs of tanistry and of Irish gavelkind, and the English land system was violently

*Elizabethan Conquest of Ireland.*

*Religious policy.*

*James I. (1603-1625).*

substituted. The earl of Tyrone was harassed by sheriffs and other officers, and the government, learning that he was engaged in an insurrectionary design, prepared to seize him. The information was probably false, but Tyrone was growing old and perhaps despaired of making good his defence. By leaving Ireland he played into his enemies' hands. Rory O'Donnell, created earl of Tyrconnel, accompanied him. Cucconaught Maguire had already gone. The "flight of the earls," as it is called, completed the ruin of the Celtic cause. Reasons or pretexts for declaring forfeitures against O'Cahan were easily found. O'Dogherty, chief of Inishowen, and foreman of the grand jury which found a bill for treason against the earls of Tyrone and Tyrconnel, was insulted by Sir George Paulet, the governor of Derry. O'Dogherty rose, Derry was sacked, and Paulet murdered. O'Dogherty having been killed and O'Hanlon and others being implicated, the whole of northern Ulster was at the disposal of the government. Tyrone, Donegal, Armagh, Cavan, Fermanagh and Derry were parcelled out among English and Scottish colonists, portions being reserved to the natives. The site of Derry was granted to the citizens of London, who fortified and armed it, and Londonderry became the chief bulwark of the colonists in two great wars. Whatever may have been its morality, in a political point of view the plantation of Ulster was successful. The northern province, which so severely taxed the energies of Elizabeth, has since been the most prosperous and loyal part of Ireland. But the conquered people remained side by side with the settlers; and Sir George Carew, who reported on the plantation in 1611, clearly foresaw that they would rebel again. Those natives who retained land were often oppressed by their stronger neighbours, and sometimes actually swindled out of their property. It is probable that in the neglect of the grantees to give proper leases to their tenants arose the Ulster tenant-right custom which attracted so much notice in more modern times.

#### Plantation of Ulster.

The parliamentary history of the English colony in Ireland corresponds pretty closely to that of the mother country. First there are informal meetings of eminent persons; then, in 1295, there is a parliament of which some acts remain, and to which only knights of the shire were summoned to represent the commons. Burgesses were added as early as 1310. The famous parliament of Kilkenny in 1366 was largely attended, but the details of its composition are not known. That there was substantial identity in the character of original and copy may be inferred from the fact that the well-known tract called *Modus tenendi parliamentum* was exemplified under the Great Seal of Ireland in 6 Hen. V. The most ancient Irish parliament remaining on record was held in 1374, twenty members in all being summoned to the House of Commons, from the counties of Dublin, Louth, Kildare and Carlow, the liberties and crosses of Meath, the city of Dublin, and the towns of Drogheda and Dundalk. The liberties were those districts in which the great vassals of the crown exercised palatinate jurisdiction, and the crosses were the church lands, where alone the royal writ usually ran. In addition to another parliament in the same year were addressed in writs to the counties of Waterford, Cork and Limerick; the liberties and crosses of Ulster, Wexford, Tipperary and Kerry; the cities of Waterford, Cork and Limerick; and the towns of Youghal, Kinsale, Ross, Wexford and Kilkenny. The counties of Clare and Longford, and the towns of Galway and Athenry, were afterwards added, and the number of popular representatives does not appear to have much exceeded sixty during the later middle ages. In the House of Lords the temporal peers were largely outnumbered by the bishops and mitred abbots. In the parliament which conferred the royal title on Henry VIII. it was finally decided that the proctors of the clergy had no voice or votes. Elizabeth's first parliament, held in 1559, was attended by 76 members of the Lower House, which increased to 122 in 1585. In 1613 James I. by a wholesale creation of new boroughs, generally of the last insignificance, increased the House of Commons to 232, and thus secured an Anglican majority to

#### The Irish Parliament.

carry out his policy. He told those who remonstrated to mind their own business. "What is it to you if I had created 40 noblemen and 400 boroughs? The more the merrier, the fewer the better cheer." In 1639 the House of Commons had 274 members, a number which was further increased to 300 at the Revolution, and so it remained until the Union.

Steepled in absolutist ideas, James was not likely to tolerate religious dissent. He thought he could "mak what liked him law and gospel." A proclamation for banishing Romish priests issued in 1605, and was followed by an active and general persecution, which was so far from succeeding that they continued to flock in from abroad, the lord-deputy Arthur Chichester admitting that every house and hamlet was to them a sanctuary. The most severe English statutes against the Roman Catholic laity had never been re-enacted in Ireland, and, in the absence of law, illegal means were taken to enforce uniformity. Privy seals addressed to men of wealth and position commanded their attendance at church before the deputy or the provincial president, on pain of unlimited fine and imprisonment by the Irish Star Chamber. The Roman Catholic gentry and lawyers, headed by Sir Patrick Barnewall, succeeded in proving the flagrant illegality of these mandates, and the government had to yield. On the whole Protestantism made little progress, though the number of Protestant settlers increased. As late as 1622, when Sir Henry Cary, Viscount Falkland, was installed as deputy, the illustrious James Ussher, then bishop of Meath, preached from the text "he beareth not the sword in vain," and descanted on the over-indulgence shown to recusants. The primate, Christopher Hampton, in a letter which is a model of Christian eloquence, mildly rebuked his eminent suffragan.

The necessities of Charles I. induced his ministers to propose that a great part of Connaught should be declared forfeited, owing to mere technical flaws in title, and planted like Ulster. Such was the general outcry that the scheme had to be given up; and, on receiving a large grant from the Irish parliament, the king promised certain graces, of which the chief were security for titles, free trade, and the substitution of an oath of allegiance for that of supremacy. Having got the money, Charles as usual broke his word; and in 1635 the lord-deputy Strafford began a general system of extortion. The Connaught and Munster landowners were shamelessly forced to pay large fines for the confirmation of even recent titles. The money obtained by oppressing the Irish nation was employed to create an army for the oppression of the Scottish and English nations. The Roman Catholics were neither awed nor conciliated. Twelve bishops, headed by the primate Ussher, solemnly protested that "to tolerate popery is a grievous sin." The Ulster Presbyterians were rigorously treated. Of the prelates employed by Strafford in this persecution the ablest was John Bramhall (1594-1665) of Derry, who not only oppressed the ministers but insulted them by coarse language. The "black oath," which bound those who took it never to oppose Charles in anything, was enforced on all ministers, and those who refused it were driven from their manses and often stripped of their goods.

Strafford was recalled to expiate his career on the scaffold; the army was disbanded; and the helm of the state remained in the hands of a land-jobber and of a superannuated soldier. Disbanded troops are the ready weapons of conspiracy, and the opportunity was not lost. The Roman Catholic insurgents of 1641 just failed to seize Dublin, but quickly became masters of nearly the whole country. That there was no definite design of massacring the Protestants is likely, but it was intended to drive them out of the country. Great numbers were killed, often in cold blood and with circumstances of great barbarity. The English under Sir Charles Coote and others retaliated. In 1642 a Scottish army under General Robert Monro landed in Ulster, and formed a rallying point for the colonists. Londonderry, Enniskillen, Coleraine, Carrickfergus and some other places defied Sir Phelim O'Neill's

#### Religious policy of James I.

#### Charles I. (1625-1649).

#### Administrators of Strafford.

#### Rebellion of 1641.

tumultuary host. Trained in foreign wars, Owen Roe O'Neill gradually formed a powerful army among the Ulster Irish, and showed many of the qualities of a skilful general. But like other O'Neills, he did little out of Ulster, and his great victory over Monro at Benburb on the Blackwater (June 5, 1646) had no lasting results. The English of the Pale were forced into rebellion, but could never get on with the native Irish, who hated them only less than the new colonists. Ormonde throughout maintained the position of a loyal subject, and, as the king's representative, played a great but hopeless part. The Celts cared nothing for the king except as a weapon against the Protestants; the old Anglo-Irish Catholics cared much, but the nearer Charles approached them the more completely he alienated the Protestants. In 1645 Rinuccini reached Ireland as papal legate. He could never co-operate with the Roman Catholic confederacy at Kilkenny, which was under old English influence, and by throwing in his lot with the Celts only widened the gulf between the two sections. The state of parties at this period in Ireland has been graphically described by Carlyle. "There are," he says, "Catholics of the Pale, demanding freedom of religion, under my lord this and my lord that. There are Old-Irish Catholics, under pope's nuncios, under Abba O'Teague of the excommunications, and Owen Roe O'Neill, demanding not religious freedom only, but what we now call 'repal of the union,' and unable to agree with Catholics of the English Pale. Then there are Ormonde Royalists, of the Episcopalian and mixed creeds, strong for king without covenant; Ulster and other Presbyterians strong for king and covenant; lastly, Michael Jones and the Commonwealth of England, who want neither king nor covenant."

In all their negotiations with Ormonde and Glamorgan, Henrietta Maria and the earl of Bristol, the pope and Rinuccini stood out for an arrangement which would have destroyed the royal supremacy and established Romanism in Ireland, leaving to the Anglicans bare toleration, and to the Presbyterians not even that. Charles behaved with his usual weakness. Ormonde was forced to surrender Dublin to the Parliamentarians (July 1647), and the inextricable knot awaited Cromwell's sword.

Cromwell's campaign (1649-1650) showed how easily a good general with an efficient army might conquer Ireland. Resistance in the field was soon at an end; the starving-out policy of Carew and Mountjoy was employed against the guerrillas, and the soldiers were furnished with scythes to cut down the green corn. Bibles were also regularly served out to them. Oliver's severe conduct at Drogheda and elsewhere is not morally defensible, but such methods were common in the wars of the period, and much may be urged in his favour. Strict discipline was maintained, soldiers being hanged for stealing chickens; faith was always kept; and short, sharp action was more merciful in the long run than a milder but less effective policy. Cromwell's civil policy, to use Macaulay's words, was "able, straightforward, and cruel." He thinned the disaffected population by allowing foreign enlistment, and 40,000 are said to have been thus got rid of. Already Irish Catholics of good family had learned to offer their swords to foreign princes. In Spain, France and the Empire they often rose to the distinction which they were denied at home. About 9000 persons were sent to the West Indies, practically into slavery. Thus, and by the long war, the population was reduced to some 850,000, of whom 150,000 were English and Scots. Then came the transplantation beyond the Shannon. The Irish Catholic gentry were removed bodily with their servants and such tenants as consented to follow them, and with what remained of their cattle. They suffered dreadful hardships. To exclude foreign influences, a belt of 1 m. was reserved to soldiers on the coast from Sligo to the Shannon, but the idea was not fully carried out. The derelict property in the other provinces was divided between adventurers who had advanced money and soldiers who had fought in Ireland. Many of the latter sold their claims to officers or speculators, who were thus enabled to form estates. The majority of Irish labourers stayed to work under the settlers, and the country gradually became

peaceful and prosperous. Some fighting Catholics haunted woods and hills under the name of tories, afterwards given in derision to a great party, and were hunted down with as little compunction as the wolves to which they were compared. Measures of great severity were taken against Roman Catholic priests; but it is said that Cromwell had great numbers in his pay, and that they kept him well informed. All classes of Protestants were tolerated, and Jeremy Taylor preached unmolested. Commercial equality being given to Ireland, the woollen trade at once revived, and a shipping interest sprang up. A legislative union was also effected, and Irish members attended at Westminster.

Charles II. was bound in honour to do something for such Irish Catholics as were innocent of the massacres of 1641, and the claims were not scrutinized too severely. It was found impossible to displace the Cromwells, but they were shorn of about one-third of their lands. When the Caroline settlement was complete it was found that the great rebellion had resulted in reducing the Catholic share of the fertile parts of Ireland from two-thirds to one-third. Ormonde, whose wife had been allowed by Cromwell's clemency to make him some remittances from the wreck of his estate, was largely and deservedly rewarded. A revenue of £30,000 was settled on the king, in consideration of which Ireland was in 1663 excluded from the benefit of the Navigation Act, and her nascent shipping interest ruined. In 1666 the importation of Irish cattle and horses into England was forbidden, the value of the former at once falling five-fold, of the latter twenty-fold. Dead meat, butter and cheese were also excluded, yet peace brought a certain prosperity. The woollen manufacture grew and flourished, and Macaulay is probably warranted in saying that under Charles II. Ireland was a pleasanter place of residence than it has been before or since. But it was pleasant only for those who conformed to the state religion. Roman Catholicism was tolerated, or rather connived at; but its professors were subject to frequent alarms, and to great severities during the ascendancy of Titus Oates. Bramhall became primate, and his hand was heavy against the Ulster Presbyterians. Jeremy Taylor began a persecution which stopped the influx of Scots into Ireland. Deprived of the means of teaching, the Independents and other sectaries soon disappeared. In a military colony women were scarce, and the "Ironsides" had married natives. Roman Catholicism held its own. The Quakers became numerous during this reign, and their peaceful industry was most useful. They venerate as their founder William Edmundson (1627-1712), a Westmorland man who had borne arms for the Parliament, and who settled in Antrim in 1652.

The duke of Ormonde was lord-lieutenant at the death of Charles II. At seventy-five his brain was as clear as ever, and James saw that he was no fit tool for his purpose. "See, gentlemen," said the old chief, lifting his glass at a military dinner-party, "they say at court I am old and dotting. But my hand is steady, nor doth my heart fail. . . . To the king's health." Calculating on his loyal subservience, James appointed his brother-in-law, Lord Clarendon, to succeed Ormonde. Monmouth's enterprise made no stir, but gave an excuse for disarming the Protestant militia. The tories at once emerged from their hiding-places, and Clarendon found Ireland in a ferment. It was now the turn of the Protestants to feel persecution. Richard Talbot, one of the few survivors of Drogheda, governed the king's Irish policy, while the lord-lieutenant was kept in the dark. Finally Talbot, created earl of Tyrconnel, himself received the sword of state. Protestants were weeded out of the army, Protestant officers in particular being superseded by idle Catholics of gentle blood, where they could be found, and in any case by Catholics. Bigotry rather than religion was Tyrconnel's ruling passion, and he filled up offices with Catholics independently of character. Sir Alexander Fittin, a man convicted of forgery, became chancellor, and but three Protestant judges were left on the bench. The outlawries growing out of the affairs of 1641 were reversed as quickly as possible. Protestant corporations were dissolved by

Charles II.  
(1660-1685).

James II.  
(1685-1689).

"quo warrantos"; but James was still Englishman enough to refuse an Irish parliament, which might repeal Poyning's Act and the Act of Settlement.

At the close of 1688 James was a fugitive in France. By this time Londonderry and Enniskillen had closed their gates, and the final struggle had begun. In March 1689 James reached Ireland with some French troops, and summoned a parliament which repealed the Act of Settlement. The estates of absentees vested in the crown, and, as only two months law was given, this was nearly equivalent to confiscating the property of all Protestants. Between 2000 and 3000 Protestants were attainted by name, and moreover the act was not published. The appalling list may be read in the *State of the Protestants* by William King, archbishop of Dublin, one of many divines converted by the logic of events to believe in the lawfulness of resistance. Interesting details may be gleaned from Edmundson's *Diary*. The dispossessed Protestants escaped by sea or flocked into Ulster, where a gallant stand was made. The glories of Londonderry and Enniskillen will live as long as the English language. The Irish cause produced one great achievement—the defence of Limerick, and one great leader—Patrick Sarsfield. The Roman Catholic Celts aided by France were entirely beaten, the Protestant colonists aided by England were entirely victorious

at the battle of the Boyne, on the 1st of July 1690; and at the battle of Aughrim on the 12th of July 1691. Even the siege of Limerick showed the irreconcilable divisions which had nullified the efforts of 1641. Hugh Baldearg O'Donnell, last of Irish chiefs, sold his services to William for £500 a year. But it was their king that condemned the Irish to hopeless failure. He called them cowards, whereas the cowardice was really his own, and he deserted them in their utmost need. They repaid him with the opprobrious nickname of "Sheemas-a-Cacagh," or dirty James.

Irish rhetoric commonly styles Limerick "the city of the violated treaty." The articles of capitulation (Oct. 3, 1691) may be read in Thomas Leland's *History of Ireland* (1773) or in F. P. Plowden's *History of Ireland* (1800); from the first their interpretation was disputed. Hopes of religious liberty were held out, but were not fulfilled. Lords Justices Porter and Coningsby promised to do their utmost to obtain a parliamentary ratification, but the Irish parliament would not be persuaded. There was a paragraph in the original draft which would have protected the property of the great majority of Roman Catholics, but this was left out in the articles actually signed. William thought the omission accidental, but this is hardly possible. At all events he ratified the treaty in the sense most favourable to the Catholics, while the Irish parliament adhered to the letter of the document. Perhaps no breach of faith was intended, but the sorrowful fact remains that the modern settlement of Ireland has the appearance of resting on a broken promise. More than 1,000,000 Irish acres were forfeited, and, though some part returned to Catholic owners, the Catholic interest in the land was further diminished. William III. was the most liberally minded man in his dominions; but the necessities of his position, such is the awful penalty of greatness, forced him into intolerance against his will, and he promised to discourage the Irish woollen trade. His manner of disposing of the Irish forfeitures was inexorable. The lands were resumed by the English parliament, less perhaps from a sense of justice than from a desire to humiliate the deliverer of England, and were resold to the highest bidder. Nevertheless it became the fashion to reward nameless English services at the expense of Ireland. Pensions and sinecures which would not bear the light in England were charged on the Irish establishment, and even bishoprics were given away on the same principle. The tremendous uproar raised by Swift about Wood's halfpence was heightened by the fact that Wood shared his profits with the duchess of Kendal, the mistress of George I.

From the first the victorious colonists determined to make another 1641 impossible, and the English government failed to moderate their severity. In 1708 Swift declared that the Papists were politically as inconsiderable as the women and children.

In despair of effecting anything at home, the young and strong enlisted in foreign armies, and the almost incredible number of 450,000 are said to have emigrated for this purpose between 1691 and 1745. This and the hatred felt towards James II. prevented any rising in 1715 or 1745. The panic-stricken severity of minorities is proverbial, but it is not to be forgotten that the Irish Protestants had been turned out of house and home twice within fifty years. The restrictions on Irish commerce provoked Locke's friend William Molyneux (1656-1698) to write his famous plea for legislative independence (1698). Much of the learning contained in it now seems obsolete, but the question is less an antiquarian one than he supposed. Later events have shown that a mother country must have supreme authority, or must relax the tie with self-governing colonies merely into a close alliance. In the case of Ireland the latter plan has always been impossible. In 1703 the Irish parliament begged for a legislative union, but as that would have involved at least partial free trade the English monopolists prevented it. By Poyning's law (see above) England had control of all Irish legislation, and was therefore an accomplice in the penal laws. These provided that no Papist might teach a school or any child but his own, or send children abroad, the burden of proof lying on the accused, and the decision being left to magistrates without a jury. Mixed marriages were forbidden between persons of property, and the children might be forcibly brought up Protestants. A Catholic could not be a guardian, and all wards in chancery were brought up Protestants. The Protestant eldest son of a Catholic landed proprietor might make his father tenant for life and secure his own inheritance. Among Catholic children land went in compulsory gavelkind. Catholics could not take longer leases than thirty-one years at two-thirds of a rack rent; they were even required to conform within six months of an inheritance accruing, on pain of being ousted by the next Protestant heir. Priests from abroad were banished, and their return declared treason. All priests were required to register and to remain in their own parishes, and informers were to be rewarded at the expense of the Catholic inhabitants. No Catholic was allowed arms, two justices being empowered to search; and if he had a good horse any Protestant might claim it on tendering £5.

These laws were of course systematically evaded. The property of Roman Catholics was often preserved through Protestant trustees, and it is understood that faith was generally kept. Yet the attrition if slow was sure, and by the end of the century the proportion of land belonging to Roman Catholics was probably not more than one-tenth of the whole. We can see now that if the remaining Roman Catholic landlords had been encouraged they would have done much to reconcile the masses to the settlement. Individuals are seldom as bad as corporations, and the very men who made the laws against priests practically shielded them. The penal laws put a premium on hypocrisy, and many conformed only to preserve their property or to enable them to take office. Proselytizing schools, though supported by public grants, entirely failed.

The restraints placed by English commercial jealousy on Irish trade destroyed manufacturing industry in the south and west (see the section *Economics* above). Driven by the Caroline legislation against cattle into breeding sheep, Irish graziers produced the best wool in Europe. Forbidden to export it, or to work it up profitably at home, they took to smuggling, for which the indented coast gave great facilities. The enormous profits of the contraband trade with France enabled Ireland to purchase English goods to an extent greater than her whole lawful traffic. The moral effect was disastrous. The religious penal code it was thought meritorious to evade; the commercial penal code was ostentatiously defied; and both tended to make Ireland the least law-abiding country in Europe. The account of the smugglers is the most interesting and perhaps the most valuable part of J. A. Froude's work in Ireland, and should be compared with the Irish and Scottish chapters of Lecky's *History*.

When William III. promised to depress the Irish woollen trade, he promised to do all he could for Irish linen. England did not fulfil the second promise; still the Ulster weavers were not crushed, and their industry flourished. Some Huguenot refugees, headed by Louis Crommelin (1652-1727), were established by William III. at Lisburn, and founded the manufacturing prosperity of Ulster. Other Huguenots attempted other industries, but commercial restraints brought them to nought. The peculiar character of the flax business has prevented it from crossing the mountains which bound the northern province. Wool was the natural staple of the south.

The Scottish Presbyterians who defended Londonderry were treated little better than the Irish Catholics who besieged it—the sacramental test of 1704 being the work of the English council rather than of the Irish parliament. In 1715 the Irish House of Commons resolved that any one who should prosecute a Presbyterian for accepting a commission in the army without taking the test was an enemy to the king and to the Protestant interest. Acts of indemnity were regularly passed throughout the reign of George II., and until 1780, when the Test Act was repealed. A bare toleration had been granted in 1720. Various abuses, especially forced labour on roads which were often private jobs, caused the Oakboy Insurrection in 1764. Eight years later the Steelboys rose against the exactions of absentee landlords, who often turned out Protestant yeomen to get a higher rent from Roman Catholic cottiers. The dispossessed men carried to America an undying hatred of England which had much to say to the American revolution, and that again reacted on Ireland. Lawless Protestant associations, called Peep o' Day Boys, terrorized the north and were the progenitors of the Orangemen (1789). Out of the rival "defenders" Ribbonism in part sprung, and the United Irishmen drew from both sources (1791).

The Ulster peasants were never as badly off as those of the south and west. Writers the most unlike each other—Swift and Hugh Boulter, George Berkeley and George Stone, Arthur Young and Dr Thomas Campbell—all tell the same tale. Towards the end of the 17th century Raleigh's fatal gift had already become the food of the people. When Sir Stephen Rice (1637-1715), chief baron of the Irish exchequer, went to London in 1688 to urge the Catholic claims on James II., the hostile populace escorted him in mock state with potatoes stuck on poles. Had manufactures been given fair play in Ireland, population might have preserved some relation to capital. As it was, land became almost the only property, and the necessity of producing wool for smuggling kept the country in grass. The poor squatted where they could, receiving starvation wages, and paying exorbitant rents for their cabins, partly with their own labour. Unable to rise, the wretched people multiplied on their potato plots with perfect recklessness. During the famine which began in the winter of 1739 one-fifth of the population is supposed to have perished; yet it is hardly noticed in literature, and seems not to have touched the conscience of that English public which in 1755 subscribed £100,000 for the sufferers by the Lisbon earthquake. As might be expected where men were allowed to smuggle and forbidden to work, redress was sought in illegal combinations and secret societies. The dreaded name of Whiteboy was first heard in 1761; and agrarian crime has never since been long absent. Since the Union we have had the Threshers, the Terry Alts, the Molly Maguires, the Rockites, and many others. Poverty has been the real cause of all these disturbances, which were often aggravated by the existence of factions profoundly indicative of barbarism. Communism, cupidity, scoundrelism of all kinds have contributed to every disturbance. The tendency shown to screen the worst criminals is sometimes the result of sympathy, but more often of fear. The cruelties which have generally accompanied Whiteboyism is common to servile insurrections all over the world. No wonder if Irish landlords were formerly tyrannical, for they were in the position of slave-owners. The steady application of modern principles, by extend-

ing legal protection to all, has altered the slavish character of the oppressed Irish. The cruelty has not quite died out, but it is much rarer than formerly; and, generally speaking, the worst agrarianism has of late years been seen in the districts which retain most of the old features.

The mediæval colony in Ireland was profoundly modified by the pressure of the surrounding tribes. While partially adopting their laws and customs, the descendants of the conquerors often spoke the language of the natives, and in so doing nearly lost their own. The *Book of Howth* and many documents composed in the Pale during the 16th century show this clearly. Those who settled in Ireland after 1641 were in a very different mood. They hated, feared and despised the Irish, and took pride in preserving their pure English speech. Molyneux and Petty, who founded the Royal Society of Dublin in 1683, were equally Englishmen, though the former was born in Ireland. Swift and Berkeley did not consider themselves Irishmen at all. Burke and Goldsmith, coming later, though they might not call themselves Englishmen, were not less free from provincialism. It would be hard to name other four men who, within the same period, used Shakespeare's language with equal grace and force. They were all educated at Trinity College, Dublin. The Sheridans were men of Irish race, but with the religion they adopted the literary tone of the dominant caste, which was small and exclusive, with the virtues and the vices of an aristocracy. Systematic infringement of English copyright was discreditable in itself, but sure evidence of an appetite for reading. "The bookseller's property," says Gibbon of his first volume, "was twice invaded by the pirates of Dublin." The oratory of the day was of a high order, and incursions into the wide field of pamphlet literature often repay the student. Handel was appreciated in Dublin at a time when it was still the fashion to decry him in London. The public buildings of the Irish capital have great architectural merit, and private houses still preserve much evidence of a refined taste. Angelica Kauffmann worked long in Ireland; James Barry and Sir Martin Archer Shee were of Irish birth; and on the whole, considering the small number of educated inhabitants, it must be admitted that the Ireland of Flood and Grattan was intellectually fertile.

The volunteers (see FLOOD, HENRY) extorted partial free trade (1779), but manufacturing traditions had perished, and common experience shows how hard these are to recover. The demand for union was succeeded by a craving for independence. Poyning's Law was repealed, and in 1782, in Grattan's opinion, Ireland was at last a nation. The ensuing period of eighteen years is the best known in Irish history. The quarrel and reconciliation of Flood and Grattan (*q.v.*), the kindly patriotism of Lord Charlemont, the eloquence, the devotion, the corruption, are household words. (Details will be found in the biographical articles on these and other men of the period.) In the parliament of 1784, out of 302 members 82 formed the regular opposition, of whom 30 were the nominees of Whig potentates and 52 were really elected. The majority contained 29 members considered independent, 44 who expected to be bought, 44 placemen, 12 sitting for regular government boroughs, and 12 who were supposed to support the government on public grounds. The remaining seats were proprietary, and were let to government for valuable consideration. The House of Lords, composed largely of borough mongers and controlled by political bishops, was even less independent. Only Protestant freeholders had votes, which encouraged leases for lives, about the worst kind of tenure, and the object of each proprietor was to control as many votes as possible. The necessity of finding Protestants checked subdivision for a time, but in 1793 the Roman Catholics received the franchise, and it became usual to make leases in common, so that each lessee should have a freehold interest of 40s. The landlord indeed had little choice, for his importance depended on the poll-book. Salaries, sinecures, even commissions in the army were reserved for those who contributed to the return of some local magnate.

**Ulster prosperous.**

**Dis-senters.**

**Poverty of the peasantry.**

**Struggle for independence.**

But no political cause swelled the population as much as the potato. Introduced by Raleigh in 1610, the cultivation of this important tuber developed with extraordinary rapidity. The Elizabethan wars were most injurious to industry, for men will not sow unless they hope to reap, and the very essence of military policy had been to deprive a recalcitrant people of the means of living. The Mantuan peasant was grieved at the notion of his harvest being gathered by barbarian soldiers, and the Irishman could not be better pleased to see his destroyed. There was no security for any one, and every one was tempted to live from hand to mouth. The decade of anarchy which followed 1641 stimulated this tendency fearfully. The labour of one man could plant potatoes enough to feed forty, and they could neither be destroyed nor carried away easily. When Petty wrote, early in Charles II.'s reign, this demoralizing esculent was already the national food. Potatoes cannot be kept very long, but there was no attempt to keep them at all; they were left in the ground, and dug as required. A frost which penetrated deep caused the famine of 1739. Even with the modern system of storing in pits the potato does not last through the summer, and the "meal months"—June, July and August—always brought great hardship. The danger increased as the growing population pressed ever harder upon the available land. Between 1831 and 1842 there were six seasons of dearth, approaching in some places to famine.

The population increased from 2,845,932 in 1785 to 5,356,594 in 1803. They married and were given in marriage. Wise men foresaw the deluge, but people who were already half-starved every summer did not think their case could well be better. In 1845 the population had swelled to 8,205,061, the greater part of whom depended on the potato only. There was no margin, and when the "precarious exotic" failed an awful famine was the result.

Great public and private efforts were made to meet the case, and relief works were undertaken, on which, in March 1847, 734,000 persons, representing a family aggregate of not less than 3,000,000, were employed. It was found that labour and exposure were not good for half-starved men. The jobbing was frightful, and is probably inseparable from wholesale operations of this kind. The policy of the government was accordingly changed, and the task of feeding a whole people was undertaken. More than 3,000,000 rations, generally cooked, were at one time distributed, but no exertions could altogether avert death in a country where the usual machinery for carrying, distributing and preparing food was almost entirely wanting. From 200,000 to 300,000 perished of starvation or of fever caused by insufficient food. An exodus followed which, necessary as it was, caused dreadful hardship, and among the Roman Catholic Irish in America Fenianism took its rise. One good result of the famine was thoroughly to awaken Englishmen to their duty towards Ireland. Since then, purse-strings have been even too readily untied at the call of Irish distress.

Great brutalities disgraced the rebellion of 1798, but the people had suffered much and had French examples before them. The real originator of the movement was Theobald Wolfe Tone (q.v.), whose proffered services were rejected by Pitt, and who founded the United Irishmen. His Parisian adventures detailed by himself are most interesting, and his tomb is still the object of an annual pilgrimage. Tone was a Protestant, but he had imbibed socialist ideas, and hated the priests whose influence counteracted his own. In Wexford, where the insurrection went farthest, the ablest leaders were priests, but they acted against the policy of their church.

The inevitable union followed (1st January 1801). From this period the history of Ireland naturally becomes intermingled with English politics (see ENGLISH HISTORY), and much of the detail will also be found in the biographical articles on prominent Irishmen and other politicians. Pitt had some time before (1785) offered a commercial partnership, which had been rejected on the ground that it involved the ultimate right of England to tax Ireland.

He was not less liberally inclined in religious matters, but George III. stood in the way, and like William III. the minister would not risk his imperial designs. Carried in great measure by means as corrupt as those by which the constitution of '82 had been worked, the union earned no gratitude. But it was a political necessity, and Grattan never gave his countrymen worse advice than when he urged them to "keep knocking at the union." The advice has, however, been taken. Robert Emmet's insurrection (1803) was the first emphatic protest. Then came the struggle for emancipation. It was proposed to couple the boon with a veto on the appointment of Roman Catholic bishops. It was the ghost of the old question of investitures. The remnant of the Roman Catholic aristocracy would have granted it; even Pius VII. was not invincibly opposed to it; but Daniel O'Connell took the lead against it. Under his guidance the Catholic association became a formidable body. At last the priests gained control of the elections; the victor of Waterloo was obliged to confess that the king's government could no longer be carried on, and Catholic emancipation had to be granted in 1829. The title war followed, and this most oppressive of all taxes was unfortunately commuted (1838) only in deference to clamour and violence. The repeal agitation was unsuccessful, but let us not be extreme to mark the faults of O'Connell's later years. He doubtless believed in repeal at first; probably he ceased to believe in it, but he was already deeply committed, and had abandoned a lucrative profession for politics. With some help from Father Mathew he kept the monster meetings in order, and his constant denunciations of lawless violence distinguish him from his imitators. His trial took place in 1844. There is a sympathetic sketch of O'Connell's career in *Lecky's Leaders of Public Opinion in Ireland* (1871); Sir Thomas *Wyse's Historical Sketch of the late Catholic Association* (1829) gives the best account of the religious struggle, and much may be learned from W. J. Fitzpatrick's *Life of Bishop Doyle* (1880).

The national system of education introduced in 1833 was the real recantation of intolerant opinions, but the economic state of Ireland was fearful. The famine, emigration and the new poor law nearly got rid of starvation, but the people never became frankly loyal, feeling that they owed more to their own impurity and to their own misfortunes than to the wisdom of their rulers. The literary efforts of young Ireland eventuated in another rebellion (1848); a revolutionary wave could not roll over Europe without touching the unlucky island. After the failure of that outbreak there was peace until the close of the American civil war released a number of adventurers trained to the use of arms and filled with hatred to England.

Already in 1858 the discovery of the Phoenix conspiracy had shown that the policy of John Mitchel (1815-1875) and his associates was not forgotten. John O'Mahony, one of the men of '48, organized a formidable secret society in America, which his historical studies led him to call the Fenian brotherhood (see FENIANS).

The Fenian movement disclosed much discontent, and was attended by criminal outrages in England. The disestablishment of the Irish Church, the privileged position of which had long been condemned by public opinion, was then decreed (1869) and the land question was next taken in hand (1870). These reforms did not, however, put an end to Irish agitation. The Home Rule party which demanded the restoration of a separate Irish parliament, showed increased activity, and the general election of 1874 gave it a strong representation at Westminster, where one section of the party developed into the "obstructionists" (see the articles on ISAAC BUTT and C. S. PARNELL).

Isaac Butt, who died in May 1879, led a parliamentary party of fifty-four, but the Conservatives were strong enough to out-vote them and the Liberals together. His procedure was essentially lawyer-like, for he respected the House of Commons and dreaded revolutionary violence. His death left the field

Dependence on the potato.

Catholic Emancipation.

Repeal agitation.

Rebellion of 1798.

Union of Great Britain and Ireland.

clear for younger and bolder men. William Shaw succeeded him as chairman of the Irish party in Parliament; but after the election of 1880, Parnell, who had the Land League at his back, ousted him by 23 votes to 18.

The Land Law of 1860, known as Deasy's Act, had been based on the principle that every tenancy rested on contract either expressed or implied. The act of 1870, admitting the divergence between theory and practice, protected the tenants' improvements and provided compensation for disturbance within certain limits, but not where the ejection was for non-payment of rent. In good times this worked well enough, but foreign competition began to tell, and 1879 was the worst of several bad seasons. A succession of wet summers told against all farmers, and in mountainous districts it was difficult to dry the turf on which the people depended for fuel. A famine was feared, and in the west there was much real distress. The Land League, of which Michael Davitt (*q.v.*) was the founder, originated in Mayo in August, and at a meeting in Dublin in October the organization was extended to all Ireland, with Parnell as president. The country was thickly covered with branches before the end of the year, and in December Parnell went to America to collect money. He was absent just three months, visiting over sixty cities and towns; and 200,000 dollars were subscribed. Parnell had to conciliate the Clan-na-Gael and the Fenians generally, both in Ireland and America, while abstaining from action which would make his parliamentary position untenable. He did not deny that he would like an armed rebellion, but acknowledged that it was an impossibility. Speaking at Cincinnati on the 23rd of February 1880, he declared that the first thing necessary was to undermine English power by destroying the Irish landlords. Ireland might thus become independent. "And let us not forget," he added, "that that is the ultimate goal at which all we Irishmen aim. None of us, whether we be in America or in Ireland, or wherever we may be, will be satisfied until we have destroyed the last link which keeps Ireland bound to England." At Galway in October of the same year he said that he "would not have taken off his coat" to help the tenant farmers had he not known that that was the way to legislative independence. Fenianism and agrarianism, essentially different as they are, might be worked to the same end.

To meet the partial failure of the potatoes in Connaught and Donegal, very large sums were subscribed and administered by two committees, one under the duchess of Marlborough and the other under the lord mayor of Dublin. When Lord Beaconsfield appealed to the country in March 1880, he reminded the country in a letter to the viceroy, the duke of Marlborough, that there was a party in Ireland "attempting to sever the constitutional tie which unites it to Great Britain in that bond which has favoured the power and prosperity of both," and that such an agitation might in the end be "scarcely less disastrous than pestilence and famine." But the general election did not turn mainly upon Ireland, and the result gave Gladstone a majority of 50 over Conservatives and Home Rulers combined. Earl Cowper became lord-lieutenant, with W. E. Forster (*q.v.*) as chief secretary, and Parnell remained chairman of his own party in parliament. The Compensation for Disturbance Bill, even where the ejection was for non-payment of rent, passed the House of Commons, but the Lords threw it out, and this has often been represented as the great cause of future trouble. Probably it made little real difference, for the extreme party in Ireland were resolved to stop at nothing. It is not easy to defend the principle that a landlord who has already lost his rent should also have to pay the defaulter before getting a new tenant or deriving a profit from the farm by working it himself. Speaking at Ennis on the 19th of September,

**Boycotting.** Parnell told the people to punish a man for taking a farm from which another had been evicted "by isolating him from his kind as if he was a leper of old." The advice was at once taken and its scope largely extended. For refusing to receive rents at figures fixed by the tenants, Captain Boycott (1832-1897), Lord Erne's agent in Mayo, was severely

"boycotted," the name of the first victim being given to the new system. His servants were forced to leave him, his crops were left unsaved, even the post and telegraph were interfered with. The Ulster Orangemen resolved to get in the crops, and to go in armed force sufficient for the purpose. The government allowed 50 of them to go under the protection of about 900 soldiers. The cost seemed great, but the work was done and the law vindicated. In Cork William Bence-Jones (1812-1882) was attacked. The men in the service of the steam-packet companies refused to put his cattle on board, and they were eventually smuggled across the Channel in small lots. Several associations were formed which had more or less success against the League, and at last a direct attack was made. Parnell with four other members of parliament and the chief officers of the Land League were indicted for conspiracy in the Queen's Bench. No means of intimidating the jurors was neglected, and in the then state of public feeling a verdict was hardly to be expected. On the 25th of January 1881 the jury disagreed, and Parnell became stronger than ever.

Then followed a reign of terror which lasted for years. No one was safe, and private spite worked freely in the name of freedom. The system originated by Parnell's Ennis speech became an all-devouring tyranny. In the House of Commons, on the 24th of May 1882, Gladstone said that boycotting required a sanction like every other creed, and that the sanction which alone made it effective "is the murder which is not to be denounced." The following description by a resident in Munster was published in *The Times* of the 5th of November 1885: "Boycotting means that a peaceable subject of the queen is denied food and drink, and that he is ruined in his business; that his cattle are unsaleable at fairs; that the smith will not shoe his horse, nor the carpenter mend his cart; that old friends pass him by on the other side, making the sign of the cross; that his children are hooted at the village school; that he sits apart like an outcast in his usual place of public worship; all for doing nothing but what the law says he has a perfect right to do. I know of a man who is afraid to visit his own son. A trader who is even suspected of dealing with such a victim of tyranny may be ruined by the mere imputation; his customers shun him from fear, and he is obliged to get a character from some notorious leaguer. Membership of the National League is, in many cases, as necessary a protection as ever was a certificate of civism under Robespierre. The real Jacobins are few, but the masses groan and submit." Medicine was refused by a shopkeeper even for the sick child of a boycotted person. A clergyman was threatened for visiting a parishioner who was under the ban of the League. Sometimes no one could be found to dig a grave. The League interfered in every relation of life, and the mere fact of not belonging to it was often severely punished. "The people," says the report of the Cowper Commission, "are more afraid of boycotting, which depends for its success on the probability of outrage, than they are of the judgments of the courts of justice. This unwritten law in some districts is supreme."

The session of parliament of 1881 was chiefly occupied with Ireland. "With fatal and painful precision," Gladstone told the House of Commons on the 28th of January, **Coercion.** "the steps of crime dogged the steps of the Land League," and the first thing was to restore the supremacy of the law. In 1871 there had been an agrarian war in Westmeath, and an act had been passed authorizing the arrest of suspected persons and their detention without trial. The ringleaders disappeared and the county became quiet again. It was now proposed to do the same thing for the whole of Ireland, the power of detention to continue until the 30th of September 1882. Parnell cared nothing for the dignity of the House of Commons. His leading idea was that no concession could be got from England by fair means, and he made himself as disagreeable as possible. Parliamentary forms were used with great success to obstruct parliamentary action. The "Coercion Bill" was introduced on the 24th of January 1881. There was a sitting of 22 hours and another of 41 hours, and on the 2nd of February



the debate was closed by the Speaker on his own responsibility and the bill read a first time. The Speaker's action was approved by the House generally, but acrimonious debates were raised by Irish members. Parnell and 35 of his colleagues were suspended, and the bill became law on the 2nd of March, but not before great and permanent changes were made in parliamentary procedure. An Arms Bill, which excited the same sort of opposition, was also passed into law.

As that a Land Act should be passed was a foregone conclusion as soon as the result of the general election was known. There were many drafts and plans which never saw the light, but it was at last resolved to adopt the policy known as the "Three F's"—free sale, fixity of tenure and fair rents. By the first tenants at will were empowered to sell their occupation interests, the landlord retaining a right of pre-emption. By the second the tenant was secured from eviction except for non-payment of rent. By the third the tenant was given the right to have a "fair rent" fixed by a newly formed Land Commission Court, the element of competition being entirely excluded. There were several exceptions and qualifying clauses, but most of them have been swept away by later acts. The act of 1881 can scarcely be said to have worked well or smoothly, but it is not easy to see how any sort of settlement could have been reached without accepting the principle of having the rent fixed by a third party. Drastic as the bill was, Parnell refused to be a party to it, and on the second reading, which was carried by 352 to 176, he walked out of the House with 35 of his followers. When the bill became law in August he could not prevent the tenants from using it, but he did what he could to discourage them in order to please his American paymasters, who repudiated all parliamentary remedies. In September a convention was held in Dublin, and Parnell reported its action to the American Land League: "Resolutions were adopted for national self-government, the unconditional liberation of the land for the people, tenants not to use the rent-fixing clauses of the Land Act, but follow old Land League lines, and rely on the old methods to reach justice. The executive of the League is empowered to select test cases, in order that tenants in surrounding districts may realize, by the results of cases decided, the hollowness of the act" (Barry O'Brien, *Life of C. S. Parnell*, i. 306). His organ *United Ireland* declared that the new courts must be cowed into giving satisfactory decisions. The League, however, could not prevent the farmers from using the fair-rent clauses. It was more successful in preventing free sale, maintaining the doctrine that, rent or no rent, no evictions were to be allowed.

At the first sitting of the Land Commission in Dublin the crier, perhaps by accident, declared "the court of the Land League to be open." Speaking at Leeds on the 7th of October, Gladstone said "the resources of civilization were not exhausted," adding that Parnell "stood between the living and the dead, not like Aaron to stay the plague, but to spread the plague." Two days later Parnell called the prime minister a "masquerading knight-errant," ready to oppress the unarmed, but submissive to the Boers as soon as he found "that they were able to shoot straighter than his own soldiers." Four days after this Parnell was arrested under the Coercion Act and lodged in Kilmainham

gaol. The Land League having retorted by ordering the tenants to pay no rent, it was declared illegal, and suppressed by proclamation. Parnell is said to have disapproved of the no-rent manifesto, as also Mr John Dillon, who was in Kilmainham with him, but both of them signed it (*ib.* i. 310). At Liverpool on the 27th of October Gladstone described Parnell and his party as "marching through rapine to the disintegration and dismemberment of the empire." In 1881, 4439 agrarian outrages were reported; nothing attracted more attention in England than the cruel mutilations of cattle, which became very frequent. The Ladies' Land League tried to carry on the work of the suppressed organization and there was even an attempt at a Children's League. Sex had no effect in softening the prevalent style of oratory, but the government thought it better to take no

notice. The imprisonment of suspects under the Coercion Act had not the expected result, and outrages were incessant, the agitation being supported by constant supplies of money from America. Gladstone resolved on a complete change of policy. It was decided to check evictions by an Arrears Bill, and the three imprisoned members of parliament—Messrs Parnell, Dillon and O'Kelly—were released on the 2nd of May 1882, against the wishes of the Irish government. This was known as the Kilmainham Treaty. Lord Cowper and Forster at once resigned, and were succeeded by Lord Spencer and Lord Frederick Cavendish, who entered Dublin on the 6th of May.

That same evening Lord Frederick and the permanent under-secretary Thomas Henry Burke were murdered in the Phoenix Park in broad daylight. The weapons were amputating knives imported for the purpose. The assassins drove rapidly away; no one, not even those who saw the deed from a distance, knew what had been done.

A Dublin tradesman named Field, who had been a juror in a murder trial, was attacked by the same gang and stabbed in many places. He escaped with life, though with shattered health, and it was the identification of the man who drove his assailants' car that afterwards led to the discovery of the whole conspiracy. The clue was obtained by a private examination of suspected persons under the powers given by the Crimes Act. To obtain convictions the evidence of an informer was wanted, and the person selected was James Carey, a member of the Dublin Corporation and a chief contriver of the murders. He swore that they had been ordered immediately after the appearance of an article in the *Freeman's Journal* which declared that a "clean sweep" should be made of Dublin Castle officials. The evidence disclosed the fact that several abortive attempts had been previously made to murder Forster. Out of twenty persons, subsequently arraigned, five were hanged, and others sentenced to long terms of imprisonment. Carey embarked for South Africa in the following July, and was murdered on board ship by Patrick O'Donnell, who was brought to England, convicted, and hanged on the 17th of December 1883.

Mr (afterwards Sir) G. O. Trevelyan had been appointed chief secretary in May 1882, and in July the Crimes Prevention Act was passed for three years on lines indicated by Lord Cowper. In the first six months of the year 2597 agrarian outrages were reported, and in the last six months 836. They fell to 834 in 1883, and to 744 in 1884. The Arrears Bill also became law. Money enough was advanced out of the surplus property of the Irish Church to pay for tenants of holdings under £30 one year's rent upon all arrears accruing before November 1880, giving them a clear receipt to that date on condition of their paying another year themselves; of the many reasons against the measure the most important was that it was a concession to agrarian violence. But the same could be and was said of the Land Act of 1881. That had been passed, and it was probably impossible to make it work at all smoothly without checking evictions by dealing with old arrears. The Irish National League was, however, founded in October to take up the work of the defunct Land League, and the country continued to be disturbed. The law was paralysed, for no jury could be trusted to convict even on the clearest evidence, and the National League branches assumed judicial functions. Men were openly tried all over the country for disobeying the revolutionary decrees, and private spite was often the cause of their being accused. "Tenants," to quote the Cowper Commission again, "who have paid even the judicial rents have been summoned to appear before self-constituted tribunals, and if they failed to do so, or on appearing failed to satisfy those tribunals, have been fined or boycotted." In February 1883 Mr Trevelyan gave an account of his stewardship at Hawick, and said that all law-abiding Irishmen, whether Conservative or Liberal, were on one side, while on the other were those who "planned and executed the Galway and Dublin murders, the boycotting and

Land Act,  
1881.

Phoenix  
Park  
murders.

National  
League.

fring into houses, the mutilation of cattle and intimidation of every sort." In this year the campaign of outrage in Ireland was reinforced by one of dynamite in Great Britain.

**Dynamite.** The home secretary, Sir W. Harcourt, brought in an Explosives Bill on the 9th of April, which was passed through all its stages in one day and received the royal assent on the next. The dynamiters were for the most part Irish-Americans, who for obvious reasons generally spared Ireland, but one land-agent's house in Kerry was shaken to its foundations in November 1884. At Belfast in the preceding June Lord Spencer, who afterwards became a Home Ruler, had announced that the secret conspirators would "not terrify the English nation." On the 22nd of February 1885 Forster made his great attack on Parnell in the House of Commons, accusing him of moral complicity with Irish crime. A detailed answer was never attempted, and public attention was soon drawn to the trial of the "Invincibles" who contrived the Phoenix Park murders. On the 11th of December Parnell received a present of £37,000 from his followers in Ireland. The tribute, as it was called, was raised in spite of a papal prohibition. As a complement to the Land Act and Arrears Act, boards of guardians were this year empowered to build labourers' cottages with money borrowed on the security of the rates and repayable out of them. Half an acre of land went with the cottage, and by a later act this was unwisely extended to one acre. That the labourers had been badly housed was evident, and there was little chance of improvement by private capitalists, for cottage property is not remunerative. But the working of the Labourers Acts was very costly, cottages being often assigned to people who were not agricultural labourers at all. In many districts the building was quite overdone, and the rent obtainable being far less than enough to recoup the guardians, the system operated as out-door relief for the able-bodied and as a rate in aid of wages.

The Explosives Act, strong as it was, did not at once effect its object. In February 1884 there was a plot to blow up four London railway stations by means of clockwork infernal machines containing dynamite, brought from America. Three Irish-Americans were convicted, of whom one, John Daly, who was sentenced to penal servitude for life, lived to be mayor of Limerick in 1899. In January 1885 Parnell visited Thurles, where he gave a remarkable proof of his power by breaking down local opposition to his candidate for Tipperary. In April the prince and princess of Wales visited Ireland. At Dublin they were well received, and at Belfast enthusiastically, but there were hostile demonstrations at Mallow and Cork. In May it was intended to renew the Crimes Prevention Act, but before that was done the government was beaten on a financial question by 264 to 252, Parnell and 39 of his followers voting with the Conservatives. The Crimes Prevention Act expired on the 12th of July, and the want of it was at once felt. The number of agrarian outrages reported in the first six months of the year was 373; in the last six months they rose to 543, and the number of persons boycotted was almost trebled. Lord Salisbury came into office, with Lord Carnarvon as lord-lieutenant and Sir W. Hart Dyke as chief secretary. The lord-lieutenant had an interview with Parnell, of which very conflicting accounts were given, but the Irish leader issued a manifesto advising his friends to vote against the Liberals as oppressors and coercionists, who promised everything and did nothing. The constitutional Liberal party in Ireland was in fact annihilated by the extension of the franchise to agricultural labourers and very small farmers. The most important Irish measure of

the session was the Ashbourne Act, by which £5,000,000 was allotted on the security of the land for the creation of an occupying proprietary. Later the same sum was again granted, and there was still a good deal unexpended when the larger measure of 1891 became law. In December 1885, when the general election was over, an anonymous scheme of Home Rule appeared in some newspapers, and in spite of disclaimers it was at once believed that Gladstone had made up his mind to surrender. In October 1884, only fourteen

months before, he had told political friends that he had a sneaking regard for Parnell, and that Home Rule might be a matter for serious consideration within ten years (Sir A. West's *Recollections*, 1899, ii. 206). The shortening of the time was perhaps accounted for by the fact that the new House of Commons consisted of 331 Liberals, 249 Conservatives, 86 Home Rulers and Independents, Parnell thus holding the balance of parties. In Ireland there had been 66 elections contested, and out of 451,000 voters 93,000 were illiterates. Such were the constituencies to whom it was proposed to hand Ireland over. On the 26th of January 1886 the government were defeated by a combination of Liberal and Nationalists on an issue not directly connected with Ireland, and their resignation immediately followed. Gladstone became prime minister, with Lord Aberdeen as lord-lieutenant

**Home Rule Bill, 1886.**

and Mr John Morley as chief secretary. Lord Hartington and Mr Goschen were not included in this administration. In February Parnell again showed his power by forcing Captain O'Shea upon the unwilling electors of Galway. He introduced a Land Bill to relieve tenants from legal process if they paid half their rent, and foretold disorder in consequence of its rejection. In April the Government of Ireland Bill was brought in, Mr Chamberlain (*q.v.*), Mr Trevelyan and others leaving the ministry. The bill attempted to safeguard British interests, while leaving Ireland at the mercy of the native politicians. Irish members were excluded from the imperial parliament. The local legislature was to consist of two orders sitting and voting together, but with the power of separating on the demand of either order present. The 28 representative peers, with 75 other members having an income of £200, or a capital of £4000, elected for ten years by £25 occupiers, were to constitute the first order. The second was to have 204 members returned for five years by the usual parliamentary electorate. The status of the lord-lieutenant was unalterable by this legislature. Holders of judicial offices and permanent civil servants had the option of retiring with pensions, but the constabulary, whom the Home Rulers had openly threatened to punish when their time came, were to come after an interval under the power of the Irish Parliament. Parnell accepted the bill, but without enthusiasm.

The Government of Ireland Bill gave no protection to landowners, but as the crisis was mainly agrarian, it would have been hardly decent to make no show of considering them. A Land Purchase Bill was accordingly introduced on the 16th of April by the prime minister under "an obligation of honour and policy," to use his own words. Fifty millions sterling in three years was proposed as payment for what had been officially undervalued at 113 millions. It was assumed that there would be a rush to sell, the choice apparently lying between that and confiscation, and priority was to be decided by lot. The Irish landlords, however, showed no disposition to sell their country, and the Purchase Bill was quickly dropped, though Gladstone had declared the two measures to be inseparable. He reminded the landlords that the "sands were running in the hour-glass," but this threat had no effect. The Unionists of Ireland had been taken by surprise, and out of Ulster they had no organization capable of opposing the National League and the government combined. Individuals went to England and spoke wherever they could get a hearing, but it was uphill work. In Ulster the Orange lodges were always available, and the large Protestant population made itself felt. Terrible riots took place at Belfast in June, July and August. In October there was an inquiry by a royal commission with Mr Justice Day at its head, and on the report being published in the following January there were fresh riots. Foolish and criminal as these disturbances were, they served to remind the English people that Ireland would not cease to be troublesome under Home Rule. In parliament the Home Rule Bill soon got into rough water; John Bright declared against it. The "dissentient Liberals," as Gladstone always called them, were not converted by the abandonment of the Purchase Bill, and on the 7th of June 93 of them voted against the second reading,

which was lost by 30 votes. A general election followed in July, and 74 Liberal Unionists were returned, forming with the Conservatives a Unionist party, which outnumbered Gladstonians and Parnellites together by over a hundred. Gladstone resigned, and Lord Salisbury became prime minister, with Lord Londonderry as lord-lieutenant and Sir M. Hicks-Beach (afterwards Lord St Aldwyn) as chief secretary.

The political stroke having failed, agrarianism again occupied the ground. The "plan of campaign" was started, against

Parnell's wishes, towards the end of 1886. The gist of this movement was that tenants should offer what they were pleased to consider a fair rent, and if it was refused, should pay the money into the hands of a committee. In March 1887 Sir M. Hicks-Beach resigned on account of illness, and Mr Arthur Balfour (*g.r.*) became chief secretary. The attempt to govern Ireland under what was called "the ordinary law" was necessarily abandoned, and a perpetual Crimes Act was passed which enabled the lord-lieutenant to proclaim disturbed districts and dangerous associations, and substituted trial by magistrates for trial by jury in the case of certain acts of violence. In August the National League was suppressed by proclamation. The conservative instincts of the Vatican were alarmed by the lawless state of Ireland, and an eminent ecclesiastic, Monsignor Persico, arrived in the late summer on a special commission of inquiry. He made no secret of his belief that the establishment of an occupying proprietary was the only lasting cure, but the attitude of the clergy became gradually more moderate. The government passed a bill giving leaseholders the benefit of the act of 1881, and prescribing a temporary reduction upon judicial rents already fixed. This last provision was open to many great and obvious objections, but was more or less justified by the fall in prices which had taken place since 1881.

The steady administration of the Crimes Act by Mr Balfour gradually quieted the country. Parnell had now gained the bulk of the Liberal party, including Lord Spencer (in spite of all that he had said and done) and Sir G. Trevelyan (in spite of his Hawick speech). In the circumstances the best chance for Home Rule was not to stir the land question. Cecil Rhodes, hoping to help imperial federation, gave Parnell £10,000 for the cause. In September 1887 a riot arising out of the "plan of campaign" took place at Mitchelstown. The police fired, and two lives were lost, Mr Henry Labouchere and Mr (afterwards Sir John) Brunner, both members of parliament, being present at the time. The coroner's jury brought in a verdict against the police, but that was a matter of course, and the government ignored it. A telegram sent by Gladstone a little later, ending with the words "remember Mitchelstown," created a good deal of feeling, but it did the Home Rulers no good. In October Mr Chamberlain visited Ulster, where he was received with enthusiasm, and delivered several stirring Unionist speeches. In November Lord Hartington and Mr Goschen were in Dublin, and addressed a great loyalist meeting there.

In July 1888 an act was passed appointing a commission, consisting of Sir James Hannen, Mr Justice Day and Mr Justice

**Parnell's  
Commission.**

A. L. Smith, to inquire into certain charges made by *The Times* against Parnell and his party. What caused most excitement was the publication by *The*

*Times* on the 15th of May 1887 of a facsimile letter purporting to have been written by Parnell on the 15th of May 1882, nine days after the Phoenix Park murders. The writer of this letter suggested that his open condemnation of the murders had been a matter of expediency, and that Burke deserved his fate. Parnell at once declared that this was a forgery, but he did nothing more at the time. Other alleged incriminating letters followed. The case of *O'Donnell v. Walter*, tried before the Lord Chief Justice of England in July 1888, brought matters to a head, and the special commission followed. The proceedings were necessarily of enormous length, and the commissioners did not report until the 13th of February 1890, but the question of the letters was decided just twelve months earlier, Richard Pigott, who shot himself at Madrid,

having confessed to the forgeries. A few days later, on the 8th of March 1889, Parnell was entertained at dinner by the Eighty Club, Lords Spencer and Rosebery being present; and he was well received on English platforms when he chose to appear. Yet the special commission shed a flood of light on the agrarian and Nationalist movement in Ireland. Eight members of parliament were pronounced by name to have conspired for the total political separation of the two islands. The whole party were proved to have disseminated newspapers tending to incite to sedition and the commission of crime, to have abstained from denouncing the system of intimidation, and to have compensated persons injured in committing crime. (See PARNELL.)

The conduct of the agrarian war had in the meantime almost passed from Parnell's hands. The "plan of campaign" was not his work, still less its latest and most remarkable exploit. To punish Mr Smith-Barry (afterwards <sup>New</sup> Lord Barrymore) for his exertions in favour of a brother Tipperary. lord, his tenants in Tipperary were ordered to give up their holdings. A sum of £50,000 was collected to build "New Tipperary," and the fine shops and flourishing concerns in the town were deserted to avoid paying small ground-rents. The same course was pursued with the farmers, some of whom had large capitals invested. Mr William O'Brien presided at the inaugural dinner on the 12th of April, and some English M.P.'s were present, but his chief supporter throughout was Father Humphreys. Parnell was invited, but neither came nor answered. No shopkeeper nor farmer had any quarrel with his landlord. "Heretofore," a tenant wrote in *The Times* in the following December, "people were boycotted for taking farms; I am boycotted for not giving up mine, which I have held for twenty-five years. A neighbour of mine, an Englishman, is undergoing the same treatment, and we alone. We are the only Protestant tenants on the Cashel estate. The remainder of the tenants, about thirty, are clearing everything off their land, and say they will allow themselves to be evicted." In the end the attack on Mr Smith-Barry completely failed, and he took back his misguided tenants. But the town of Tipperary has not recovered its old prosperity.

The principal Irish measure passed in 1891 was Mr Balfour's Purchase Act, to extend and modify the operation of the Ashbourne acts. £30,000,000 were provided to convert tenants into proprietors, the instalments paid being <sup>Land</sup> again available, so that all the tenanted land in Ireland might ultimately be passed through if desired. The land itself in one shape or another formed the security, and guaranteed stock was issued which the holder might exchange for consols. The 40th clause of the Land Act of 1896 greatly stimulated the creation of occupying owners in the case of over-incumbered estates, but solvent landlords were not in a hurry to sell. The interests of the tenant were so carefully guarded that the prices obtainable were ruinous to the vendor unless he had other resources. The security of the treasury was also so jealously scrutinized that even the price which the tenant might be willing to pay was often disallowed. Thus the Land Commission really fixed the price of all property, and the last vestige of free contract was obliterated. Compulsory purchase became a popular cry, especially in Ulster. Owners, however, could not with any pretence of justice be forced to sell at ruinous prices, nor tenants be forced to give more than they thought fair. If the state, for purposes of its own, insisted upon expropriating all landlords, it was bound to find the difference, or to enter upon a course of undisguised confiscation. The Purchase Act was not the only one relied on by Mr Balfour. The Light Railways Act, passed by him in 1890, did much to open up some of the poorest parts of the west, and the temporary scarcity of that year was dealt with by relief works.

An action begun by Parnell against *The Times* was settled by the payment of a substantial sum. The Nationalist leader seemed to stand higher than ever, but the writ in the divorce proceedings, brought by Captain O'Shea against his wife, with the Irish leader as co-respondent, was hanging over him. To

public astonishment, when the case came on for trial there was no defence, and on the 17th of November 1890 a decree *nisi* was granted. Parnell's subsequent marriage with the respondent before a registrar did him no good with his Roman Catholic supporters. The Irish bishops remained silent, while in England the "Nonconformist conscience" revolted. Three days after the verdict a great meeting was held in the Leinster Hall, Dublin, attended by 25 members of the Irish parliamentary party. The result was an enthusiastic vote of confidence in Parnell, moved by Mr Justin McCarthy and seconded by Mr T. M. Healy. Five days later he was unanimously re-elected chairman by his party in parliament, but the meeting was scarcely over when Gladstone's famous letter to Mr Morley became public. The writer in effect demanded Parnell's resignation of the leadership as the condition upon which he could continue at the head of the Liberal party. He had to choose between the Nonconformist vote and the Irish leader, and he preferred the former. Next day the secession of the Irish members from their chief began. Long and acrimonious debates followed in committee-room 15, and on the 6th of December Parnell was left in the chair with only 26 supporters. The majority of 45 members—Anti-Parnellites, as they came to be called—went into another room, unanimously deposed him, and elected Mr Justin McCarthy in his place. Parnell then began a campaign as hopeless as that of Napoleon after Leipzig. He seized the office of *United Ireland* in person. The Fenian element was with him, as he admitted, but the clergy were against him, and the odds were too great, especially against a Protestant politician. His candidate in a by-election at Kilkenny was beaten by nearly two to one, and he himself was injured in the eyes by lime being thrown at him. Similar defeats followed at Sligo and Carlow. He went over to France to meet Messrs Dillon and O'Brien, who had not yet taken sides, but nothing was agreed to, and in the end both these former followers went against him. Every Saturday he went from London to Dublin and addressed some Sunday meeting in the country. The last was on the 27th of September. On the 6th of October 1891 he died at Brighton, from the effects of a chill following on overwork and excitement. His funeral at Glasnevin was attended by 200,000 people. At the general election of 1892, however, only 9 Parnellites—the section which under Mr John Redmond remained staunch to his memory—were returned to parliament.

The "Parnellite split," as it was called, proved fatal to the cause of Home Rule, for the Nationalist party broke up into factions. No one of the sectional leaders commanded general confidence, and personal rivalries were of the bitterest kind. An important result of these quarrels was to stop the supply of American money, without which neither the Land League nor the Home Rule agitation could have been worked. The Unionist party had adopted a policy of local government for Ireland while opposing legislative independence, and a bill was introduced into the House of Commons by Mr Balfour in February 1892. The principle was affirmed by a great majority, but the measure could not then be proceeded with. At the general election in July the Gladstonians and Nationalists together obtained a majority of 40 over Conservatives and Liberal Unionists. Lord Salisbury resigned in August, and was succeeded by Gladstone, with Lord Houghton (afterwards earl of Crewe) as lord-lieutenant and Mr John Morley as chief secretary. The Crimes Act, which had already been relaxed, was altogether suspended, and the proclamation declaring the National League illegal was revoked. The lord-lieutenant, on taking up his quarters in Dublin, refused a loyal address because of its Unionist tone; and in October the government issued a commission, with Mr Justice Mathew as chairman, which had the restoration of the evicted tenants as its avowed object. Two of the commissioners very shortly resigned, and the whole inquiry became somewhat farcical. It was given in evidence that out of £234,431 collected under the plan of campaign only £125,000 had been given to evicted tenants.

In February 1893, on the application of the sheriff of Kerry, an order from Dublin Castle, refusing protection, was pronounced illegal in the Queen's Bench, and persons issuing it were declared liable to criminal prosecution. In the same month Gladstone introduced his second Home Rule Bill, which proposed to retain 80 Irish members in the imperial parliament instead of 103, but they were not to vote on any proceedings expressly confined to Great Britain. On the 8th of April 1886 he had told the House of Commons that it "passed the wit of man" to draw a practical distinction between imperial and non-imperial affairs. On the 20th of July 1888 he informed the same assembly that there was no difficulty in doing so. It had become evident, in the meantime, to numberless Englishmen that the exclusion of the Irish members would mean virtual separation. The plan now proposed met with no greater favour, for a good many English Home Rulers had been mainly actuated all along by the wish to get the Irish members out of their way. The financial provisions of the bill were objected to by the Nationalists as tending to keep Ireland in bondage.

During the year 1892 a vast number of Unionist meetings were held throughout Ireland, the most remarkable being the great Ulster convention in Belfast, and that of the three other provinces in Dublin, on the 14th and 23rd of June. On the 22nd of April 1893, the day after the second reading of the bill, the Albert Hall in London was filled by enthusiastic Unionist delegates from all parts of Ireland. Next day the visitors were entertained by Lord Salisbury at Hatfield, the duke of Devonshire, Mr Balfour, Mr Goschen and Mr Chamberlain being present. Between the second reading and the third on 1st September the government majority fell from 43 to 34. A great part of the bill was closed by what was known as the device of the "gag" without discussion, although it occupied the House of Commons altogether eighty-two nights. It was thrown out by the Lords by 410 to 41, and the country undoubtedly acquiesced in their action. On the 3rd of March 1894 Gladstone resigned, and Lord Rosebery (*q.v.*) became prime minister. A bill to repeal the Crimes Act of 1887 was read a second time in the Commons by 60, but went no farther. A committee on the Irish Land Acts was closed at the end of July by the casting vote of the chairman, Mr Morley, and the minority refused to join in the report. The bill to restore the evicted tenants, which resulted from the Mathew Commission, was rejected in the Lords by 249 to 30. In March 1895 Mr Morley introduced a Land Bill, but the government majority continued to dwindle. Another Crimes Act Repeal Bill passed the second reading in May by only 222 to 208. In July, however, the government were defeated on the question of the supply of small-arms ammunition. A general election followed, which resulted in a Unionist majority of 150. The Liberal Unionists, whose extinction had once been so confidently foretold, had increased from 46 to 71, and the Parnellites, in spite of the most violent clerical opposition, from 9 to 12. Lord Cadogan became lord-lieutenant of Ireland, and Mr Gerald Balfour—who announced a policy of "killing Home Rule by kindness"—chief secretary.

In the session of 1896 a new Land Act was added to the statute-book. The general effect was to decide most disputed points in favour of the tenants, and to repeal the exceptions made by former acts in the landlord's favour. Dairy farms, to mention only a few of the most important points which had been hitherto excluded, were admitted within the scope of the Land Acts, and purely pastoral holdings of between £50 and £100 were for the first time included. A presumption of law in the tenant's favour was created as to improvements made since 1850. The 40th clause introduced the principle of compulsory sale to the tenants of estates in the hands of receivers. The tendency of this provision to lower the value of all property was partly, but only partly, neutralized by the firmness of the land judge. The landlords of Ireland, who had made so many sacrifices and worked so hard to return Lord Salisbury to power, felt that

*Home Rule Bill 1893.*

*Land Act 1896.*

the measure was hardly what they had a right to expect from a Unionist administration. In their opinion it unsettled the agricultural mind, and encouraged judicial tenants to go to law at the expiration of the first fifteen years' term instead of bargaining amicably with their landlords.

In the autumn of this year was published the report of the royal commission on the financial relations between England and Ireland. Mr Hugh C. E. Childers was the original chairman of this commission, which was appointed in 1864 with the object of determining the fiscal contribution of Ireland under Home Rule, and after his death in 1866 the O'Connor Don presided. The report—or rather the collection of minority reports—gave some countenance to those who held that Ireland was overtaxed, and there was a strong agitation on the subject, in which some Irish Unionists joined without perceiving the danger of treating the two islands as “separate entities.” No individual Irishman was taxed on a higher scale than any corresponding citizen of Great Britain. No tax, either on commodities or property, was higher in Ireland than in England. The alleged grievance was, however, exploited to the utmost extent by the Nationalist party. In 1867 a royal commission, with Sir Edward Fry as chairman, was appointed to inquire into the operation of the Land Acts. Voluminous evidence was taken in different parts of Ireland, and the commissioners reported in the following year. The methods and procedure of the Land Commission were much criticized, and many recommendations were made, but no legislation followed. This inquiry proved, what few in Ireland doubted, that the prices paid for occupancy interest or tenant right increased as the landlord's rent was cut down.

The session of 1868 was largely occupied with the discussion of a bill to establish county and district councils on the lines of the English Act of 1888. The fiscal jurisdiction of grand juries, which had lasted for more than two centuries and a half, was entirely swept away. Local government for Ireland had always been part of the Unionist programme, and the vote on the abortive bill of 1862 had committed parliament to legislation. It may, nevertheless, be doubted whether enough attention was paid to the local peculiarities of Ireland, and whether English precedents were not too closely followed. In Ireland the poor-rate used to be divided between landlord and tenant, except on holdings valued at £4 and under, in which the landlord paid the whole. Councils elected by small farmers were evidently unfit to impose taxes so assessed. The poor-rate and the county cess, which latter was mostly paid by the tenants, were consolidated, and an agricultural grant of £730,000 was voted by parliament in order to relieve both parties. The consolidated rate was now paid by the occupier, who would profit by economy and lose by extravagance. The towns gained nothing by the agricultural grant, but union rating was established for the first time. The net result of the county council elections in the spring of 1869 was to displace, except in some northern counties, nearly all the men who had hitherto done the local business. Nationalist pledges were exacted, and long service as a grand juror was an almost certain bar to election. The Irish gentry, long excluded, as landlords and Unionists, from political life, now felt to a great extent that they had no field for activity in local affairs. The new councils very generally passed resolutions of sympathy with the Boers in the South African war. The one most often adopted, though sometimes rejected as too mild, was that of the Limerick corporation, hoping “that it may end in another Majuba Hill.” Efforts not wholly unsuccessful were made to hinder recruiting in Ireland, and every reverse or repulse of British arms was greeted with Nationalist applause.

The scheme for a Roman Catholic University—of which Mr Arthur Balfour, speaking for himself and not for the government, made himself a prominent champion—was much canvassed in 1869, but it came to nothing. It had not been forgotten that this question wrecked the Liberal party in 1874.

The chief Irish measure of 1869 was an Agricultural and Technical Instruction Act, which established a new department (see the section *Economics* above) with the chief secretary at its head and an elaborate system of local committees. Considerable funds were made available, and Mr (afterwards Sir) Horace Plunkett, who as an independent Conservative member had been active in promoting associations for the improvement of Irish methods in this direction, became the first vice-president. The new county councils were generally induced to further attempts at technical instruction and to assist them out of the rates, but progress in this direction was necessarily slow in a country where organized industries have hitherto been so few. In agriculture, and especially in cattle-breeding, improvement was formerly due mainly to the landlords, who had now been deprived by law of much of their power. The gap has been partly filled by the new department, and a good deal has been done. Some experience has been gained not only through the voluntary associations promoted by Sir H. Plunkett, but also from the Congested Districts Board founded under the Land Purchase Act of 1891. This board has power within the districts affected by it to foster agriculture and fisheries, to enlarge holdings, and to buy and hold land. In March 1869 it had from first to last laid out a little more than half a million. The principal source of income was a charge of £41,250 a year upon the Irish Church surplus, but the establishment expenses were paid by parliament.

At the opening of the session in January 1869 there was a formal reconciliation of the Dillonite, Healyite, and Redmondite or Parnellite factions. It was evident from the speeches made on the occasion that there was not much cordiality between the various leaders, but the outward solidarity of the party was calculated to bring in renewed subscriptions both at home and from America. It was publicly agreed that England's difficulty in South Africa was Ireland's opportunity, and that all should abstain from supporting an amendment to the address which admitted that the war would have to be fought out. Mr John Redmond was chosen chairman, and the alliance of Nationalists and Gladstonian Liberals was dissolved. The United Irish League, founded in Mayo in 1868 by Mr William O'Brien, had recently become a sort of rival to the parliamentary party, its avowed object being to break up the great grass farms, and its methods resembling those of the old Land League.

The most striking event, however, in Ireland in the earlier part of 1869 was Queen Victoria's visit. Touched by the gallantry of the Irish regiments in South Africa, and moved to some extent, no doubt, by the presence of the duke of Connaught in Dublin as commander-in-chief, the queen determined in April to make up for the loss of her usual spring holiday abroad by paying a visit to Ireland. The last time the queen had been in Dublin was in 1861 with the Prince Consort. Since then, besides the visit of the prince and princess of Wales in 1885, Prince Albert Victor and Prince George of Wales had visited Ireland in 1887, and the duke and duchess of York (afterwards prince and princess of Wales) in 1897; but the lack of any permanent royal residence and the long-continued absence of the sovereign in person had aroused repeated comment. Directly the announcement of the queen's intention was made the greatest public interest was taken in the project. Shortly before St Patrick's Day the queen issued an order which intensified this interest, that Irish soldiers might in future wear a sprig of shamrock in their headgear on this national festival. For some years past the “wearing of the green” had been regarded by the army authorities as improper, and friction had consequently occurred, but the queen's order put an end in a graceful manner to what had formerly been a grievance. The result was that St Patrick's Day was celebrated in London and throughout the empire as it never had been before, and when the queen went over to Dublin at the beginning of April she was received with the greatest enthusiasm.

The general election later in the year made no practical

Financial  
relations.Local  
Government Act  
1888.

difference in the strength of parties, but Mr George Wyndham took Mr Gerald Balfour's place as chief secretary, without a seat in the Cabinet. Both before and after the election the United Irish League steadily advanced, fresh branches continually springing up.

The visit of Mr Redmond and others to America in 1901 was not believed to have brought in much money, and the activity of the League was more or less restrained by want of funds. Boycotting, however, became rife, especially in Sligo, and paid agents also promoted an agitation against grass farms in Tipperary, Clare and other southern counties. In Roscommon there was a strike against rent, especially on the property of Lord De Freyne. This was due to the action of the Congested Districts Board in buying the Dillon estate and reducing all the rents without consulting the effect upon others. It was argued that no one else's tenants could be expected to pay more. Some prosecutions were undertaken, but the government was much criticized for not using the special provisions of the Crimes Act; and in April 1902 certain counties were "proclaimed" under it. In February 1902 Lord Rosebery definitely repudiated Home Rule, and steps to oppose his followers were at once taken among Irish voters in English constituencies.

Lord Cadogan resigned the viceroyalty in July 1902, and was succeeded by Lord Dudley. In November Sir Antony Macdonnell (b. 1844), a member of the Indian Council, became under-secretary to the lord-lieutenant. During a long and successful career in India (1865-1901) Sir Antony had never concealed his Nationalist proclivities, but his appointment, about the form of which there was nothing peculiar, was favoured by Lord Lansdowne and Lord George Hamilton, and ultimately sanctioned by Mr Balfour, who had been prime minister since Lord Salisbury's resignation in July. About the same time a conference took place in Dublin between certain landlords and some members of the Nationalist party, of whom Mr W. O'Brien was the most conspicuous. Lord Dunraven presided, and it was agreed to recommend a great extension of the Land Purchase system with a view to give the vendor as good an income as before, while decreasing the tenants' annual burden. This was attempted in Mr Wyndham's Land Purchase Act of 1903, which gave the tenants a material reduction, a bonus of 12% on the purchase-money being granted to vendors from funds provided by parliament. A judicial decision made it doubtful whether this percentage became the private property of tenants for life on settled estates, but a further act passed in 1904 answered the question in the affirmative. After this the sale of estates proceeded rapidly. In March 1903 was published the report of the Royal Commission on Irish University Education appointed two years before with Lord Robertson as chairman, Trinity College, Dublin, being excluded from the inquiry. The report, which was not really unanimous, was of little value as a basis for legislation. It recommended an examining university with the Queen's Colleges at Belfast, Cork and Galway, and with a new and well-endowed Roman Catholic college in Dublin.

In August was formed the Irish Reform Association out of the wreckage of the late Land Conference and under Lord Dunraven's presidency, and it was seen that Sir A. Macdonnell took a great interest in the proceedings. Besides transferring private bill legislation to Dublin on the Scottish plan, to which no one in Ireland objected, it was proposed to hand over the internal expenditure of Ireland to a financial council consisting half of nominated and half of elected members, and to give an Irish assembly the initiative in public Irish bills. This policy, which was called Devolution, found little support anywhere, and was ultimately repudiated both by Mr Wyndham and by Mr Balfour. But a difficult parliamentary crisis, caused by Irish Unionist suspicions on the subject, was only temporarily overcome by Mr Wyndham's resignation in March 1905. Mr Walter Long succeeded him. One of the chief questions at issue was the position actually occupied by Sir Antony Macdonnell. The

new chief secretary, while abstaining from displacing the under-secretary, whose encouragement of "devolution" had caused considerable commotion among Unionists, announced that he considered him as on the footing of an ordinary and subordinate civil servant, but Mr Wyndham had said that he was "invited by me rather as a colleague than as a mere under-secretary to register my will," and Lord Lansdowne that he "could scarcely expect to be bound by the narrow rules of routine which are applicable to an ordinary member of the civil service." While Mr Long remained in office no further complication arose, but in 1906 (Sir A. Macdonnell being retained in office by the Liberal government) his Nationalist leanings again became prominent, and the responsibility of the Unionist government in introducing him into the Irish administration became a matter of considerable heart-burning among the Unionist party.

Mr Balfour resigned in December 1905 and was succeeded by Sir Henry Campbell-Bannerman, Lord Aberdeen becoming lord-lieutenant for the second time, with Mr James Bryce as chief secretary. The general election at the beginning of 1906 was disastrous to the Unionist party, and the Liberal government secured an enormous majority. Mr Walter Long, unseated at Bristol, had made himself very popular among Irish Unionists, and a seat was found him in the constituency of South-Dublin. Speaking in August 1906 he raised anew the Macdonnell question and demanded the production of all correspondence connected with the under-secretary's appointment. Sir A. Macdonnell at once admitted through the newspapers that he had in his possession letters (rumoured to be "embarrassing" to the Unionist leaders) which he might publish at his own discretion; and the discussion as to how far his appointment by Mr Wyndham had prejudiced the Unionist cause was reopened in public with much bitterness, in view of the anticipation of further steps in the Home Rule direction by the Liberal ministry. In 1908 Sir Antony resigned and was created a peer as Baron Macdonnell. Soon after the change of government in 1906 a royal commission, with ex-Lord Justice Fry as chairman, was appointed to investigate the condition of Trinity College, Dublin, and another under Lord Dudley to inquire into the question of the congested districts.

Mr Bryce being appointed ambassador to Washington, Mr Birrell faced the session of 1907 as chief secretary. Before he left office Mr Bryce publicly sketched a scheme of his own for remodelling Irish University Education, but his scheme was quietly put on the shelf by his successor and received almost universal condemnation. Mr Birrell began by introducing a bill for the establishment of an Irish Council, which would have given the Home Rulers considerable leverage, but, to the surprise of the English Liberals, it was summarily rejected by a Nationalist convention in Dublin, and was forthwith abandoned. The extreme party of Sinn Féin ("ourselves alone") were against it because of the power it gave to the government officials, and the Roman Catholic clergy because it involved local control of primary education, which would have imperilled their position as managers. An Evicted Tenants Bill was however passed at the end of the session, which gave the Estates Commissioners unprecedented powers to take land compulsorily. In the late summer and autumn, agitation in Ireland (led by Mr Ginnell, M.P.) took the form of driving cattle off large grass farms, as part of a campaign against what was known as "ranching." This reckless and lawless practice extended to several counties, but was worst in Galway and Roscommon. The government was determined not to use the Crimes Act, and the result was that offenders nearly always went unpunished, benches of magistrates being often swamped by the chairmen of district councils who were *ex officio* justices under the act of 1898.

The general election of 1910 placed the Liberal and Unionist parties in a position of almost exact equality in the House of Commons, and it was at once evident that the Nationalists under Mr Redmond's leadership would hold the balance of power and control the fortunes of Mr Asquith's government.

A small body of "independent Nationalists," led by Mr William O'Brien and Mr T. M. Healy, voiced the general dislike in Ireland of the Budget of 1909, the rejection of which by the House of Lords had precipitated the dissolution of parliament. But although this band of free-lances was a menace to Mr Redmond's authority and to the solidarity of the "pledge-bound" Irish parliamentary party, the two sections did not differ in their desire to get rid of the "veto" of the House of Lords, which they recognized as the standing obstacle to Home Rule, and which it was the avowed policy of the government to abolish.

**BIBLIOGRAPHY.**—Ancient: The *Annals of the Four Masters*, ed. J. O'Donovan (1851), compiled in Donegal under Charles I., gives a continuous account of Celtic Ireland down to 1616. The independent *Annals of Lough Cè* (Rolls series) end with 1590. The *Topographia and Expugnatio* of Giraldus Cambrensis (Rolls series) are chiefly valuable for his account of the Anglo-Norman invaders and for descriptions of the country. Sir J. T. Gilbert's *Federal History of Ireland* (Dublin, 1865) gives a connected view of the feudal establishment to the accession of Henry VIII. The *Calendar of Documents relating to Ireland in the Public Record Office* extends from 1171 to 1307. Christopher Pembrige's *Annals from 1162 to 1370* were published by William Camden and reprinted in Sir J. T. Gilbert's *Chartularies of St Mary's Abbey* (Dublin, 1884). The *Annals of Clyn, Douling and Grace* have been printed by the Irish Archaeological Society and the Celtic Society.

For the 16th century see volumes ii. and iii. of the *Printed State Papers* (1834), and the *Calendars of State Papers, Ireland*, including that of the Carew MSS. 1515 to 1603. See also Richard Stanihurst's *Chronicle*, continued by John Hooker, which is included in Holinshed's *Chronicles*; E. Spenser, *View of the State of Ireland*, edited by H. Morley (1890); Fynes Moryson, *History of Ireland* (1735); Thomas Stafford, *Patata Hibernia* (1810); and R. Bagwell, *Ireland under the Tudors* (1885-1890).

For the 17th century see the *Calendars of Irish State Papers, 1603-1665* (Dublin, 1772); *Strawford Letters*, edited by W. Knower (1739); Thomas Carte, *Life of Ormonde* (1735-1736), and *Ormonde Papers* (1739); Roger Boyle, earl of Ormonde, *State Letters* (1743); *The Contemporary History of Affairs in Ireland, 1641-1652* (1879, 1880), and *History of the Irish Confederation and the War in Ireland, 1641-1649* (1882-1891), both edited by Sir J. T. Gilbert; Edmund Ludlow's *Memoirs*, edited by C. H. Firth (1894); *The Memoirs of James Touchet, earl of Castletown* (1815); and *Cromwell's Letters and Speeches*, edited by T. Carlyle (1904). See also J. P. Prendergast, *The Constitutional Settlement of Ireland* (1870); Denis Murphy, *Cromwell in Ireland* (1885); M. Jackson, *Ireland in the 17th Century* (1884); Sir John Temple, *History of the Irish Rebellion* (1812); P. Walsh, *History of the Remonstrance* (1674); George Story, *Impartial History of the Wars of Ireland* (1693); Thomas Withrow, *Derry and Enniskillen* (1873); Philip Dwyer, *Siege of Derry* (1893); Lord Macaulay, *History of England*; and S. R. Gardiner, *History of England, 1603-1656*. Further writings which may be consulted are: *The Embassy in Ireland of Rinuccini, 1645-1649*, translated from the Italian by A. Hutton (1873); Sir William Petty's *Dean Survey*, edited by T. A. Larcom (1851), and his *Economic Writings*, edited by C. H. Hull (1890); Charles O'Kelly's *Miscarise Excidium*, edited by J. C. O'Callaghan (1850); and *A Jacobite Narrative of the War in Ireland, 1688-91*, edited by Sir J. T. Gilbert (1892).

For the 18th century J. A. Froude's *English in Ireland* and W. E. H. Lecky's *History of England* cover the whole ground. See also the *Letters 1724-1738* of Archbishop Hugh Boulter, edited by the publisher (1770); the *Works of Dean Swift*; John Campbell's *Philosophical Survey of Ireland* (1778); Arthur Young's *Tour in Ireland* (1780); Henry Grattan's *Life of the Right Hon. Henry Grattan* (1839-1846); the *Correspondence of the Marquis Cornwallis*, edited by C. Ross (1850); Wolfe Tone's *Autobiography*, edited by R. B. O'Brien (1893); and R. M. Madden's *United Irishmen* (1842-1846).

For the 19th and the beginning of the 20th century see the *Annual Register*; R. M. Martin, *Ireland before and after the Union* (1848); Sir T. D. Bayly, *Historical Sketch of the late Catholic Association* (1829); G. L. Sneyd, *Ireland, Historical and Statistical* (1844-1849); Sir C. E. Trevelyan, *The Irish Crisis* (1880); N. W. Senior, *Letters, Conversations and Essays relating to Ireland* (1868); Sir G. C. Lewis, *On Local Disturbances in Ireland and on the Irish Church Question* (1836); John Morley, *Life of W. E. Gladstone*; Lord Fitzmaurice, *Life of Lord Granville* (1905); and R. Barry O'Brien, *Life of Parnell* (1898). Other authorities are Isaac Butt, *Irish Federalism* (1870); H. O. Arnold-Forster, *The Truth about the Land League* (1885); A. V. Dicey, *England's Case against Home Rule* (1886); W. E. Gladstone, *History of an Idea* (1886), and a reply to this by J. E. Webb entitled *The Queen's Enemies in America* (1886); and Mrs E. Lynn Linton, *About Ireland* (1890). See also the *Report of the Parnell Special Commission* (1890); the *Report of the Bessborough Commission* (1881), of the Richmond Commission (1881), of the Cowper Commission (1887), and of the Mathew

Commission (1893), and the *Report of the Congested Districts Board* (1899).

For the church in Ireland see: Henry Cotton, *Fasti ecclesiae hibernicae* (1848-1878); W. M. Brady, *The Episcopal Succession* (Rome, 1876); R. Mant, *History of the Church of Ireland* (1840); J. T. Ball, *The Reformed Church in Ireland, 1537-1886* (1886); and W. D. Killen, *Ecclesiastical History of Ireland* (1875). A. Theiner's *Vetera Monumenta* (Rome, 1864) contains documents concerning the medieval church, and there are many others in Usheer's *Works*, and for a later period in Cardinal Moran's *Spicilegium Ossoriense* (1874-1884). The *Works of Sir James Ware*, edited by Walter Harris, are generally useful, and Alice S. Green's *The Making of Ireland and its Undoing* (1908), although written from a partisan standpoint, may also be consulted. (R. BA.)

**IRELAND, CHURCH OF.** The ancient Church of Ireland (described in the Irish Church Act 1869 by this its historic title) has a long and chequered history, which it will be interesting to trace in outline. The beginnings of Christianity in Ireland are difficult to trace, but there is no doubt that the first Christian missionary whose labours were crowned with any considerable success was Patrick (fl. c. 450), who has always been reckoned the patron saint of the country. For six centuries the Church of which he was the founder occupied a remarkable position in Western Christendom. Ireland, in virtue of once of its geographical situation and of the spirit of its people, was less affected than other countries by the movements of European thought; and thus its development, social and religious, was largely independent of foreign influences, whether Roman or English. In full communion with the Latin Church, the Irish long preserved many peculiarities, such as their monastic system and the date at which Easter was kept, which distinguished them in discipline, though not conspicuously in doctrine, from the Christians of countries more immediately under papal control (see IRELAND: *Early History*). The incessant incursions of the Danes, who were the scourge of the land for a period of nearly three hundred years, prevented the Church from redeeming the promise of her infancy; and at the date of the English conquest of Ireland (1172) she had lost much of her ancient zeal and of her independence. By this time she had come more into line with the rest of Europe, and the Synod of Cashel put the seal to a new policy by its acknowledgment of the papal jurisdiction and by its decrees assimilating the Church, in ritual and usages, to that of England. There was no thought of a breach of continuity, but the distinctive features of Celtic Christianity gradually disappeared from this time onwards. English influence was strong only in the region round Dublin (known as the Pale); and beyond this district the Irish were not disposed to view with favour any ecclesiastical reforms which had their origin in the sister country. Thus from the days of Henry VIII. the Reformation movement was hindered in Ireland by national prejudice, and it never succeeded in gaining the allegiance of the Irish people as a whole. The policy which directed its progress was blundering and stupid, and reflects little credit on the English statesmen who were responsible for it. No attempt was made to commend the principles of the Reformation to the native Irish by conciliating national sentiment; and the policy which forbade the translation of the Prayer Book into the Irish language, and suggested that where English was not understood Latin might be used as an alternative, was doomed to failure from the beginning. And, in fact, the reformed church of Ireland is to this day the church of a small section only of the population.

The Reformation period begins with the passing of the Irish Supremacy Act 1537. As in England, the changes in religion of successive sovereigns alternately checked and promoted the progress of the movement, although in Ireland the mass of the people were less deeply affected by the religious controversies of the times than in Great Britain. At Mary's accession five bishops either abandoned, or were deprived of, their sees; but the Anglo-Irish who remained faithful to the Reformation were not subjected to persecution such as would have been their fate on the other side of the Channel. Again, under Elizabeth, while two bishops (William Walsh of Meath and Thomas Leverous of Kildare) were deprived for open resistance

to the new order of things, and while stern measures were taken to suppress treasonable plotting against the constitution, the uniform policy of the government in ecclesiastical matters was one of toleration. James I. caused the Supremacy Act to be rigorously enforced, but on political rather than on religious grounds. In distant parts of Ireland, indeed, the unreformed order of service was often used without interference from the secular authority, although the bishops had openly accepted the Act of Uniformity.

The episcopal succession, then, was unbroken at the Reformation. The Marian prelates are admitted on all hands to have been the true bishops of the Church, and in every case they were followed by a line of lawful successors, leading down to the present occupants of the several sees. The rival lines of Roman Catholic titulars are not in direct succession to the Marian bishops, and cannot be regarded as continuous with the mediæval Church. The question of the continuity of the pre-Reformation Church with the Church of the Celtic period before the Anglo-Norman conquest of Ireland is more difficult. Ten out of eleven archbishops of Armagh who held office between 1272 and 1439 were consecrated outside Ireland, and there is no evidence forthcoming that any one of them derived his apostolic succession through bishops of the Irish Church. It may be stated with confidence that the present Church of Ireland is the direct and legitimate successor of the Church of the 14th and 15th centuries, but it cannot so clearly be demonstrated that any existing organization is continuous with the Church of St. Patrick. In the reign of James I. the first Convocation of the clergy was summoned in Ireland, of which assembly the most notable act was the adoption of the "Irish Articles" (1615). These had been drawn up by Usher, and were more decidedly Calvinistic in tone than the Thirty-nine Articles, which were not adopted as standards in Ireland until 1634, when Strafford forced them on Convocation. During the Commonwealth period the bishoprics which became vacant were not filled; but on the accession of Charles II. the Church was strengthened by the translation of John Bramhall (the most learned and zealous of the prelates) from Derry to the primate's see of Armagh, and the consecration of twelve other bishops, among whom was Jeremy Taylor. The short period during which the policy of James II. prevailed in Ireland was one of disaster to the Church; but under William and Mary she regained her former position. She had now been reformed for more than 100 years, but had made little progress; and the tyrannical provisions of the Penal Code introduced by the English government made her more unpopular than ever. The clergy, finding their ministrations unacceptable to the great mass of the population, were tempted to indolence and non-residence; and although bright exceptions could be named, there was much that called for reform. To William King (1650-1720), bishop of Derry, and subsequently archbishop of Dublin, it was mainly due that the work of the Church was reorganized, and the impulse which he gave it was felt all through the 18th century. His ecclesiastical influence was exerted in direct opposition to Primate Hugh Boulter and his school, who aimed at making the Established Church the instrument for the promotion of English political opinions rather than the spiritual home of the Irish people. In 1800 the Act of Union was passed by the Legislature; and thenceforward, until Disestablishment, there was but one "United Church of England and Ireland."

Continuous agitation for the removal of Roman Catholic disabilities brought about in 1833 the passing of the Church Temporalities Act, one of the most important provisions of which was the reduction of the number of Irish archbishoprics from four to two, and of bishoprics from eighteen to ten, the funds thus released being administered by commissioners. In 1838 the Tithe Rentcharge Act, which transferred the payment of tithes from the occupiers to the owners of land, was passed, and thus a substantial grievance was removed. It became increasingly plain, however, as years passed, that all such measures of relief were inadequate to allay the dissatisfaction felt by the majority of Irishmen because of the continued

existence of the Established Church. Her position had been pledged to her by the Act of Union, and she was undoubtedly the historical representative of the ancient Church of the land; but such arguments proved unavailing in view of the visible fact that she had not gained the affections of the people. The census of 1861 showed that out of a total population of 5,708,967 only 693,357 belonged to the Established Church, 4,505,265 being Roman Catholics; and once this had been made clear, the passing of the Act of Disestablishment was only a question of time. Introduced by Mr Gladstone, and passed in 1869, it became law on the 1st of January 1871.

The Church was thus suddenly thrown on her own resources, and called on to reorganize her ecclesiastical system, as well as to make provision for the maintenance of her future clergy. A convention of the bishops, clergy, and laity was summoned in 1870, and its first act was to declare the adherence of the Church of Ireland to the ancient standards, and her determination to uphold the doctrine and discipline of the Catholic and Apostolic Church, while reaffirming her witness, as Protestant and Reformed, against the innovations of Rome. Under the constitution then agreed on, the supreme governing body of the Church is the General Synod, consisting of the bishops and of 208 clerical and 416 lay representatives of the several dioceses, whose local affairs are managed by subordinate Diocesan Synods. The bishops are elected as vacancies arise, and, with certain restrictions, by the Diocesan Synods, the Primate, whose see is Armagh, being chosen by the bishops out of their own number. The patronage of benefices is vested in boards of nomination, on which both the diocese and the parish are represented. The Diocesan Courts, consisting of the bishop, his chancellor, and two elected members, one clerical and the other lay, deal as courts of first instance with legal questions; but there is an appeal to the Court of the General Synod, composed of three bishops and four laymen who have held judicial office. During the years 1871 to 1878 the revision of the Prayer Book mainly occupied the attention of the General Synod; but although many far-reaching resolutions were proposed by the then predominant Evangelical party, few changes of moment were carried, and none which affected the Church's doctrinal position. A two-thirds majority of both the lay and clerical vote is necessary before any change can be made in the formularies, and an ultimate veto rests, on certain conditions, with the house of bishops.

The effects of Disestablishment have been partly good and partly evil. On the one hand, the Church has now all the benefits of autonomy and is free from the anomalies incidental to state control. Her laws are definite, and the authority of her judicial courts is recognized by all her members. The place given to the laity in her synods has quickened in them the sense of responsibility so essential to the Church's progress. And although there are few worldly inducements to men to take orders in Ireland, the clergy are, for the most part, the equals of their predecessors in social standing and in intellectual equipment, while the standard of clerical activity is higher than in pre-Disestablishment days. On the other hand, the vesting of patronage in large bodies like synods, or (as is the case in some districts) in nominators with little knowledge of the Church beyond the borders of their own parish, is not an ideal system, although it is working better as the dangers of parochialism and provinciality are becoming more generally recognized than in the early years of Disestablishment.

The finances are controlled by the Representative Church Body, to which the sum of £7,581,075, sufficient to provide life annuities for the existing clergy (2043 in number), amounting to £596,913, was handed over by the Church Temporalities Commissioners in 1870. So skillfully was this fund administered, and so generous were the contributions of clergy and laity, at and since Disestablishment, that while on 31st December 1906 only 136 annuitants were living, the total assets in the custody of the Representative Church Body amounted at that date to £8,729,041. Of this sum no less than £6,525,952 represented the free-will offerings of the members of the Church



for the thirty-seven years ending 31st December 1906. Out of the interest on capital, augmented by the annual parochial assessments, which are administered by the central office, provision has to be made for two archbishops at £2500 per annum, eleven bishops, who receive about £1500 each, and over 1500 parochial clergy. Of the clergy only 338 are curates, while 1161 are incumbents, the average annual income of a benefice being about £240, with (in most cases) a house. The large majority of the clergy receive their training in the Divinity School of Trinity College, Dublin. At the census of 1901 the members of the Church of Ireland numbered 579,385 out of a total population of 4,456,546.

See R. Mant, *History of the Church of Ireland* (2 vols., London, 1840); *Essays on the Irish Church*, by various writers (Oxford, 1866); Maziere Brady, *The Alleged Conversion of the Irish Bishops* (London, 1877); A. T. Lee, *The Irish Episcopal Succession* (Dublin, 1867); G. T. Stokes, *Ireland and the Celtic Church* (London, 1888), *Ireland and the Anglo-Norman Church* (London, 1892), *Some Writings of the Irish Church* (London, 1900); T. Olden, *The Church of Ireland* (London, 1892); J. T. Ball, *The Reformed Church of Ireland* (London, 1890); H. C. Groves, *The Titular Archbishops of Ireland* (Dublin, 1897); W. Lawlor, *The Reformation in Ireland* (London, 1906); *Reports of the Representative Church Body* (Dublin, 1872-1905). (J. H. BE.)

**IRENAEUS**, bishop of Lyons at the end of the 2nd century, was one of the most distinguished theologians of the ante-Nicene Church. Very little is known of his early history. His childhood was spent in Asia Minor, probably at or near Smyrna; for he himself tells us (*Adv. haer.* iii. 3, 4, and *Euseb. Hist. Eccl.* v. 20) that as a child he heard the preaching of Polycarp, the aged bishop of Smyrna (d. February 22, 156). But we do not know when this was. He can hardly have been born very long after 130, for later on he frequently mentions having met certain Christian presbyters who had actually seen John, the disciple of our Lord. The circumstances under which he came into the West are also unknown to us; the only thing which is certain is that at the time of the persecution of the Gallic Church under Marcus Aurelius (177) he was a presbyter of the church at Lyons. In 177 or 178 he went to Rome on a mission from this church, to make representations to Bishop Eleutherus in favour of a more lenient treatment of the Montanists (see MONTANISM; *Eus.* v. 4, 2). On his return he was called upon to undertake the direction of the church at Lyons in the place of Bishop Pothinus, who had perished in the persecution (*Eus.* v. 5, 8). As bishop he carried on a great and fruitful work. Though the statement of Gregory of Tours (*Hist. Franc.* i. 29), that within a short time he succeeded in converting all Lyons to Christianity, is probably exaggerated, from him at any rate dates the wide spread of Christianity in Lyons and its neighbourhood. He devoted particular attention to trying to reconcile the numerous sects which menaced the existence of the church (see below). In the dispute on the question of Easter, which for a long time disturbed the Christian Church both in West and East, he endeavoured by means of many letters to effect a compromise, and in particular to exercise a moderating influence on Victor, the bishop of Rome, and his underlying attitude towards the dissentient churches of Africa, thus justifying his name of "peace-maker" (*Eirenaïos*) (*Eus. H.E.* v. 24, 28). The date of his death is unknown. His martyrdom under Septimius Severus is related by Gregory of Tours, but by no earlier writer.

The chief work of Irenaeus, written about 180, is his "Refutation and Overthrow of Gnosis, falsely so called" (usually indicated by the name *Against the Heresies*). Of the Greek original of this work only fragments survive; it only exists in full in an old Latin translation, the slavish fidelity of which to a certain extent makes up for the loss of the original text. The treatise is divided into five books: of these the first two contain a minute and well-informed description and criticism of the tenets of various heretical sects, especially the Valentinians; the other three set forth the true doctrines of Christianity, and it is from them that we find out the theological opinions of the author. Irenaeus admits himself that he is not a good writer. And indeed, as he worked, his materials assumed such unmanageable proportions that he could not succeed in throwing

them into a satisfactory form. But however clumsily he may have handled his material, he has produced a work which is even nowadays rightly valued as the first systematic exposition of Catholic belief. The foundation upon which Irenaeus bases his system consists in the episcopate, the canon of the Old and New Testaments, and the rule of faith. With their assistance he sets forth and upholds, in opposition to the gnostic dualism, *i.e.* the severing of the natural and the supernatural, the Catholic monism, *i.e.* the unity of the life of faith as willed by God. The "grace of truth" (the *charisma*), which the apostles had called down upon their first disciples by prayer and laying-on of hands, and which was to be imparted anew by way of succession (*διαδοχή*, *successio*) to the bishops from generation to generation without a break, makes those who receive it living witnesses of the salvation offered to the faithful by written and spoken tradition. The Scriptures of the Old and New Testaments, rightly expounded by the church alone, give us an insight into God's plan of salvation for mankind, and explain to us the covenant which He made on various occasions (Moses and Christ; or Noah, Abraham, Moses and Christ). Finally, the "rule of faith" (*regula fidei*), received at baptism, contains in itself all the riches of Christian truth. To distribute these, *i.e.* to elucidate the rule of faith as set forth in the creed, and further to point out its agreement with the Scriptures, is the object of Irenaeus as a theologian. Hence he lays the greatest stress on the conception of God's disposition of salvation towards mankind (*oeconomia*), the object of which is that mankind, who in Adam were sunk in sin and death, should in Christ, comprised as it were in his person, be brought back to life. God, as the head of the family, so to speak, disposes of all. The Son, the Word (*Logos*) for ever dwelling with the Father, carries out His behests. The Holy Ghost (*Pneuma*), however, as the Spirit of wisdom for ever dwelling with the Father, controls what the Father has appointed and the Son fulfilled, and this Spirit lives in the church. The climax of the divine plan of salvation is found in the incarnation of the Word. God was to become man, and in Christ he became man. Christ must be God; for if not, the devil would have had a natural claim on him, and he would have been no more exempt from death than the other children of Adam; he must be man, if his blood were indeed to redeem us. On God incarnate the power of the devil is broken, and in Him is accomplished the reconciliation between God and man, who henceforth pursues his true object, namely, to become like unto God. In the God-man God has drawn men up to Himself. Into their human, fleshly and perishable nature imperishable life is thereby grafted; it has become deified, and death has been changed into immortality. In the sacrament of the Lord's Supper it is the heavenly body of the God-man which is actually partaken of in the elements. This exposition by Irenaeus of the divine economy and the incarnation was taken as a criterion by later theologians, especially in the Greek Church (cf. Athanasius, Gregory of Nyssa, Cyril of Alexandria, John of Damascus). He himself was especially influenced by St John and St Paul. Before him the Fourth Gospel did not seem to exist for the Church; Irenaeus made it a living force. His conception of the Logos is not that of the philosophers and apologists; he looks upon the Logos not as the "reason" of God, but as the "voice" with which the Father speaks in the revelation to mankind, as did the writer of the Fourth Gospel. And the Pauline epistles are adopted almost bodily by Irenaeus, according to the ideas contained in them; his expositions often present the appearance of a patchwork of St Paul's ideas. Certainly, it is only one side of Paul's thought that he displays to us. The great conceptions of justification and atonement are hardly ever touched by Irenaeus. In Irenaeus is no longer heard the Jew, striving about and against the law, who has had to break free from his early tradition of Pharisaism.

Till recent times whatever other writings and letters of Irenaeus are mentioned by Eusebius appeared to be lost, with the exception of a fragment here or there. Recently, however, two Armenian scholars, Karapet Ter-Mékertschian and Erwand

Ter-Minassianz, have published from an Armenian translation a German edition (Leipzig, 1907; minor edition 1908) of the work "in proof of the apostolic teaching" mentioned by Eusebius (*H.E. v. 26*). This work, which is in the form of a dialogue with one Marcianus, otherwise unknown to us, contains a statement of the fundamental truths of Christianity. It is the oldest catechism extant, and an excellent example of how Bishop Irenaeus was able not only to defend Christianity as a theologian and expound it theoretically, but also to preach it to laymen.

**BIBLIOGRAPHY.**—The edition of the Benedictine R. Massuet (Paris, 1710 and 1734, reprinted in Migne, *Cursus patrologiae*, Series Graeca, vol. v. Paris, 1857) long continued to be the standard one, till it was superseded by the editions of Adolph Stieren (2 vols., Leipzig, 1848-1853) and of W. Wigan Harvey (2 vols., Cambridge, 1857), the latter being the only edition which contains the Syriac fragments. For an English translation see the *Ante-Nicene Library*. Of modern monographs consult H. Ziegler, *Irenaeus, der Bischof von Lyon* (Berlin, 1871); Friedrich Loofs, *Irenaeus-Handschriften* (Leipzig, 1888); Johannes Werner, *Der Paulinismus des Irenaeus* (Leipzig, 1889); Johannes Kunze, *Die Gotteslehre des Irenaeus* (Leipzig, 1891); Ernst Klebba, *Die Anthropologie des heiligen Irenaeus* (Münster, 1904); Albert Dufourcq, *Saint Irenaeus* (Paris, 1904); Franz Stoll, *Die Lehre des Heil. Irenaeus von der Erlösung und Heiligung* (Mainz, 1905); also the histories of dogma, especially Harnack, and Bethune-Baker, *An Introduction to the Early History of Christian Doctrine* (London, 1903). (G. K.)

**IRENE**, the name of several Byzantine empresses.

1. **IRENE** (752-803), the wife of Leo IV., East Roman emperor. Originally a poor but beautiful Athenian orphan, she speedily gained the love and confidence of her feeble husband, and at his death in 780 was left by him sole guardian of the empire and of their ten-year-old son Constantine VI. Seizing the supreme power in the name of the latter, Irene ruled the empire at her own discretion for ten years, displaying great firmness and sagacity in her government. Her most notable act was the restoration of the orthodox image-worship, a policy which she always had secretly favoured, though compelled to abjure it in her husband's lifetime. Having elected Tarasius, one of her partisans, to the patriarchate (784), she summoned two church councils. The former of these, held in 786 at Constantinople, was frustrated by the opposition of the soldiers. The second, convened at Nicaea in 787, formally revived the adoration of images and reunited the Eastern church with that of Rome. As Constantine approached maturity he began to grow restive under her autocratic sway. An attempt to free himself by force was met and crushed by the empress, who demanded that the oath of fidelity should thenceforward be taken in her name alone. The discontent which this occasioned swelled in 790 into open resistance, and the soldiers, headed by the Armenian guard, formally proclaimed Constantine VI. as the sole ruler. A hollow semblance of friendship was maintained between Constantine and Irene, whose title of empress was confirmed in 792; but the rival factions remained, and Irene, by skilful intrigues with the bishops and courtiers, organized a powerful conspiracy on her own behalf. Constantine could only flee for aid to the provinces, but even there he was surrounded by participants in the plot. Seized by his attendants on the Asiatic shore of the Bosphorus, the emperor was carried back to the palace at Constantinople; and there, by the orders of his mother, his eyes were stabbed out. An eclipse of the sun and a darkness of seventeen days' duration were attributed by the common superstition to the horror of heaven. Irene reigned in prosperity and splendour for five years. She is said to have endeavoured to negotiate a marriage between herself and Charlemagne; but according to Theophanes, who alone mentions it, the scheme was frustrated by Aëtius, one of her favourites. A projected alliance between Constantine and Charlemagne's daughter, Rothrude, was in turn broken off by Irene. In 802 the patricians, upon whom she had lavished every honour and favour, conspired against her, and placed on the throne Nicephorus, the minister of finance. The haughty and unscrupulous princess, "who never lost sight of political power in the height of her religious zeal," was exiled to Lesbos and forced to support herself by spinning. She died the following year. Her zeal in restoring images and

monasteries has given her a place among the saints of the Greek church.

See E. Gibbon, *The Decline and Fall of the Roman Empire* (ed. J. Bury, London, 1896), vol. v.; G. Finlay, *History of Greece* (ed. 1847; Oxford) vol. II.; F. C. Schlosser, *Geschichte der bildungsstärkenden Kaiser des oströmischen Reiches* (Frankfurt, 1812); I. D. Phoropoulos, *ΕΙΡΗΝΗ ἡ ἀντοράτορος Παύλου* (Leipzig, 1887); J. B. Bury, *The Later Roman Empire* (London, 1886), ii. 480-498; C. Diehl, *Figures byzantines* (Paris, 1906), pp. 77-109. (M. O. B. C.)

2. **IRENE** (c. 1066-c. 1120), the wife of Alexius I. The best-known fact of her life is the unsuccessful intrigue by which she endeavoured to divert the succession from her son John to Nicephorus Bryennius, the husband of her daughter Anna. Having failed to persuade Alexius, or, upon his death, to carry out a *coup d'état* with the help of the palace guards, she retired to a monastery and ended her life in obscurity.

3. **IRENE** (d. 1161), the first wife of Manuel Comnenus. She was the daughter of the count of Sulzbach, and sister-in-law of the Roman emperor Conrad II., who arranged her betrothal. The marriage was celebrated at Constantinople in 1146. The new empress, who had exchanged her earlier name of Bertha for one more familiar to the Greeks, became a devoted wife, and by the simplicity of her manner contrasted favourably with most Byzantine queens of the age.

H. v. Kap-Herr, *Die abendländische Politik des Kaisers Manuel* (Strassburg, 1881).

**IRETON, HENRY** (1611-1651), English parliamentary general, eldest son of German Ireton of Attenborough, Nottinghamshire, was baptized on the 3rd of November 1611, became a gentleman commoner of Trinity College, Oxford, in 1626, graduated B.A. in 1629, and entered the Middle Temple the same year. On the outbreak of the Civil War he joined the parliamentary army, fought at Edgehill and at Gainsborough in July 1643, was made by Cromwell deputy-governor of the Isle of Ely, and next year served under Manchester in the Yorkshire campaign and at the second battle of Newbury, afterwards supporting Cromwell in his accusations of incompetency against the general. On the night before the battle of Naseby, in June 1645, he succeeded in surprising the Royalist army and captured many prisoners, and next day, on the suggestion of Cromwell, he was made commissary-general and appointed to the command of the left wing, Cromwell himself commanding the right. The wing under Ireton was completely broken by the impetuous charge of Rupert, and Ireton was wounded and taken prisoner, but after the rout of the enemy which ensued on the successful charge of Cromwell he regained his freedom. He was present at the siege of Bristol in the September following, and took an active part in the subsequent victorious campaign which resulted in the overthrow of the royal cause. On the 30th of October 1645 Ireton entered parliament as member for Appleby, and while occupied with the siege of Oxford he was, on the 15th of June 1646, married to Bridget, daughter of Oliver Cromwell. This union brought Ireton into still closer connexion with Cromwell, with whose career he was now more completely identified. But while Cromwell's policy was practically limited to making the best of the present situation, and was generally inclined to compromise, Ireton's attitude was based on well-grounded principles of statesmanship. He was opposed to the destructive schemes of the extreme party, disliked especially the abstract and unpractical theories of the Republicans and the Levellers, and desired, while modifying their mutual powers, to retain the constitution of King, Lords and Commons. He urged these views in the negotiations of the army with the parliament, and in the conferences with the king, being the person chiefly entrusted with the drawing up of the army proposals, including the manifesto called "The Heads of the Proposals." He endeavoured to prevent the breach between the army and the parliament, but when the division became inevitable took the side of the former. He persevered in supporting the negotiations with the king till his action aroused great suspicion and unpopularity. He became at length convinced of the hopelessness of dealing with Charles, and after the king's flight to the Isle of Wight treated his further proposals with coldness and urged the parliament

to establish an administration without him. Ireton served under Fairfax in the second civil war in the campaigns in Kent and Essex, and was responsible for the executions of Lucas and Lisle at Colchester. After the rejection by the king of the last offers of the army, he showed special zeal in bringing about his trial, was one of the chief promoters of "Pride's Purge," attended the court regularly, and signed the death-warrant. The regiment of Ireton having been chosen by lot to accompany Cromwell in his Irish campaign, Ireton was appointed major-general; and on the recall of his chief to take the command in Scotland, he remained with the title and powers of lord-deputy to complete Cromwell's work of reduction and replantation. This he proceeded to do with his usual energy, and as much by the severity of his methods of punishment as by his military skill was rapidly bringing his task to a close, when he died on the 26th of November 1651 of fever after the capture of Limerick. His loss "struck a great sadness into Cromwell," and perhaps there was no one of the parliamentary leaders who could have been less spared, for while he possessed very high abilities as a soldier, and great political penetration and insight, he resembled in stern unflinchingness of purpose the protector himself. By his wife, Bridget Cromwell, who married afterwards General Charles Fleetwood, Ireton left one son and three daughters.

**BIBLIOGRAPHY.**—Article by C. H. Firth in *Dict. of Nat. Biog.* with authorities there quoted; Wood's *Ath. Oxon.* iii 298, and *Fasts*, i. 451; Cornelius Brown's *Lives of Notis Worthies*, 181; *Clarke Papers* published by Camden Society; Gardiner's *History of the Civil War and of the Commonwealth*.

**IRIARTE** (or **YRIARTE**) **Y OROPESA, TOMÁS DE** (1750-1791), Spanish poet, was born on the 18th of September 1750, at Orotava in the island of Tenerife, and received his literary education at Madrid under the care of his uncle, Juan de Iriarte, librarian to the king of Spain. In his eighteenth year the nephew began his literary career by translating French plays for the royal theatre, and in 1770, under the anagram of Tirso Imarete, he published an original comedy entitled *Hacer que hacemos*. In the following year he became official translator at the foreign office, and in 1776 keeper of the records in the war department. In 1780 appeared a dull didactic poem in *silvas* entitled *La Música*, which attracted some attention in Italy as well as at home. The *Fábulas literarias* (1781), with which his name is most intimately associated, are composed in a great variety of metres, and show considerable ingenuity in their humorous attacks on literary men and methods; but their merits have been greatly exaggerated. During his later years, partly in consequence of the *Fábulas*, Iriarte was absorbed in personal controversies, and in 1786 was reported to the Inquisition for his sympathies with the French philosophers. He died on the 17th of September 1791.

He is the subject of an exhaustive monograph (1897) by Emilio Cotarelo y Mori.

**IRIDACEAE** (the iris family), in botany, a natural order of flowering plants belonging to the series Liliiflorae of the class Monocotyledons, containing about 800 species in 57 genera, and widely distributed in temperate and tropical regions. The members of this order are generally perennial herbs growing from a corm as in *Crocus* and *Gladiolus*, or a rhizome as in *Iris*; more rarely, as in the Spanish iris, from a bulb. A few South African representatives have a shrubby habit. The flowers are hermaphrodite and regular as in *Iris* (fig. 1) and *Crocus* (fig. 3), or with a symmetry in the median plane as in *Gladiolus*. The petaloid perianth consists of two series, each with three members, which are joined below into a longer or shorter tube, followed by one whorl of three stamens; the inferior ovary is three-celled and contains numerous ovules on an axile placenta; the style is branched and the branches are often petaloid. The fruit (fig. 2) is a capsule opening between the partitions and containing generally a large number of roundish or angular seeds. The arrangement of the parts in the flower resembles that in the nearly allied order Amaryllidaceae (*Narcissus*, *Snowdrop*, &c.), but differs in the absence of the inner whorl of stamens.

The most important genera are *Crocus* (q.v.), with about 70

species, *Iris* (q.v.), with about 100, and *Gladiolus* (q.v.), with 150. *Ixia*, *Freesia* (q.v.) and *Tritonia* (including *Montbretia*),

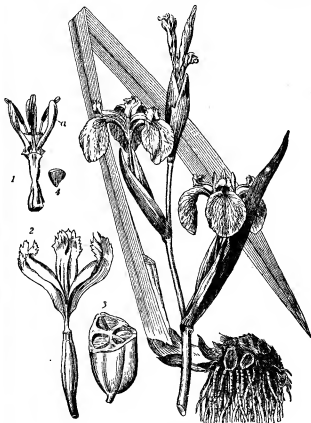

FIG. 1.—Yellow Iris, *Iris Pseudacorus*.

1. Flower, from which the outer petals and the stigmas have been removed, leaving the inner petals (a) and stamens.
2. Pistil with petaloid stigmas.
3. Fruit cut across showing the three chambers containing seeds.
4. A seed. 1-4 about  $\frac{1}{2}$  nat. size.

all natives of South Africa, are well known in cultivation. *Sisyrinchium*, blue-eyed grass, is a new-world genus extending

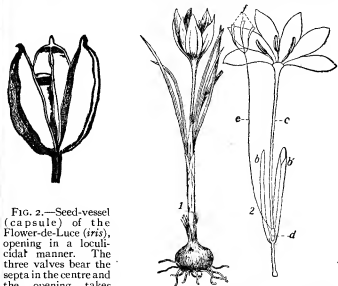

FIG. 2.—Seed-vessel (capsule) of the Flower-de-Luce (*Iris*), opening in a loculicidal manner. The three valves bear the septa in the centre and the opening takes place through the back of the chambers. Each valve is formed by the halves of contiguous carpels.

FIG. 3.—1. *Crocus* in flower, reduced. 2. Flower dissected. *b, b'*, Upper and lower membranous spathe-like bracts; *c*, Tube of perianth; *d*, Ovary; *e*, Style; *f*, Stigma.

from arctic America to Patagonia and the Falkland Isles. One

species, *S. angustifolium*, an arctic and temperate North American species, is also native in Galway and Kerry in Ireland. Other British representatives of the order are: *Iris Pseudacorus*, (yellow iris), common by river-banks and ditches, *I. foetidissima* (stinking iris), *Gladiolus communis*, a rare plant found in the New Forest and the Isle of Wight, and *Romulea Columnae*, a small plant with narrow recurved leaves a few inches long and a short scape bearing one or more small regular funnel-shaped flowers, which occurs at Dawlish in Devonshire.

**IRIDIUM** (symbol Ir.; atomic weight 193.1), one of the metals of the platinum group, discovered in 1802 by Smithson Tennant during the examination of the residue left when platinum ores are dissolved in *aqua regia*; the element occurs in platinum ores in the form of alloys of platinum and iridium, and of osmium and iridium. Many methods have been devised for the separation of these metals (see PLATINUM), one of the best being that of H. St. C. Deville and H. J. Debray (*Comptes rendus*, 1874, 78, p. 1502). In this process the osmidrium is fused with zinc and the excess of zinc evaporated; the residue is then ignited with barium nitrate, extracted with water and boiled with nitric acid. The iridium is then precipitated from the solution (as oxide) by the addition of baryta, dissolved in *aqua regia*, and precipitated as iridium ammonium chloride by the addition of ammonium chloride. The double chloride is fused with nitre, the melt extracted with water and the residue fused with lead, the excess of lead being finally removed by solution in nitric acid and *aqua regia*. It is a brittle metal of specific gravity 22.4 (Deville and Debray), and is only fusible with great difficulty. It may be obtained in the spongy form by igniting iridium ammonium chloride, and this variety of the metal readily oxidizes when heated in air.

Two oxides of iridium are known, namely the sesquioxide,  $\text{Ir}_2\text{O}_3$ , and the dioxide,  $\text{IrO}_2$ , corresponding to which there are two series of salts, the sesqui-salts and the iridic salts; a third series of salts is also known (the iridous salts) derived from an oxide  $\text{IrO}$ . Iridium sesquioxide,  $\text{Ir}_2\text{O}_3$ , is obtained when potassium iridium chloride is heated with sodium or potassium carbonates, in a stream of carbon dioxide. It is a bluish-black powder which at high temperatures decomposes into the metal, dioxide and oxygen. The hydroxide,  $\text{Ir}(\text{OH})_3$ , may be obtained by the addition of caustic potash to iridium sodium chloride, the mixture being then heated with alcohol. Iridium dioxide,  $\text{IrO}_2$ , may be obtained as small needles by heating the metal to bright redness in a current of oxygen (G. Geisenheiner, *Comptes rendus*, 1890, 110, p. 855). The corresponding hydroxide,  $\text{Ir}(\text{OH})_4$ , is formed when potassium iridate is boiled with ammonium chloride, or when the tetrachloride is boiled with caustic potash or sodium carbonate. It is an indigo-blue powder, soluble in hydrochloric acid, but insoluble in dilute nitric and sulphuric acids. On the oxides see L. Wöhler and W. Witzmann, *Zeit. anorg. Chem.* (1908), 57, p. 323. Iridium sesquichloride,  $\text{IrCl}_3$ , is obtained when one of the corresponding double chlorides is heated with concentrated sulphuric acid, the mixture being then thrown into water. It is thus obtained as an olive green precipitate which is insoluble in acids and alkalis. Potassium iridium sesquichloride,  $\text{K}_2\text{IrCl}_6 \cdot 3\text{H}_2\text{O}$ , is obtained by passing sulphur dioxide into a suspension of potassium chloridate in water until all dissolves, and then adding potassium carbonate to the solution (C. Claus, *Jour. prak. Chem.*, 1847, 42, p. 351). It forms green prisms which are readily soluble in water. Similar sodium and ammonium compounds are known. Iridium tetrachloride,  $\text{IrCl}_4$ , is obtained by dissolving the finely divided metal in *aqua regia*; by dissolving the hydroxide in hydrochloric acid; and by digesting the hydrated sesquichloride with nitric acid. On evaporating the solution (not above  $40^\circ\text{C}$ ) a dark mass is obtained, which contains a little sesquichloride. It forms double chlorides with the alkaline chlorides. For a bromide see A. Gautbier and M. Riess, *Ber.*, 1909, 42, p. 3905. Iridium sulphide,  $\text{IrS}$ , is obtained when the metal is ignited in sulphur vapour. The sesquisulphide,  $\text{Ir}_2\text{S}_3$ , is obtained as a brown precipitate when sulphuretted hydrogen is passed into a solution of one of the sesqui-salts. It is slightly soluble in potassium sulphide. The disulphide,  $\text{IrS}_2$ , is formed when powdered iridium is heated with sulphur and an alkaline carbonate. It is a dark brown powder. Iridium forms many ammine derivatives, which are analogous to the corresponding platinum compounds (see M. Skoblikoff, *Jahresb.*, 1852, p. 428; W. Palmer, *Ber.*, 1889, 22, p. 15; 1890, 23, p. 351; 1891, 24, p. 2090; *Zeit. anorg. Chem.*, 1896, 13, p. 211).

Iridium is always determined quantitatively by conversion into the metallic state. The atomic weight of the element has been determined in various ways, C. Seubert (*Ber.*, 1878, 11, p. 1770), by the analysis of potassium chloridate obtaining the value 192.74, and A. Joly (*Comptes rendus*, 1890, 110, p. 1131) from analyses of potassium and ammonium chloridates, the value 191.78 (O = 15.88).

**IRIGA**, a town of the province of Ambos Camarines, Luzon, Philippine Islands, on the Bicol river, about 20 m. S.E. of Nueva Cáceres and near the S.W. base of Mt. Iriga, a volcanic peak reaching a height of 4092 ft. above the sea. Pop. (1903) 19,297. Iriga has a temperate climate. The soil in its vicinity is rich, producing rice, Indian corn, sugar, pepper, cacao, cotton, abaca, tobacco and copra. The neighbouring forests furnish ebony, molave, tindalo and other very valuable hardwoods. The language is Bicol.

**IRIS**, in Greek mythology, daughter of Thaumias and the Ocean nymph Electra (according to Hesiod), the personification of the rainbow and messenger of the gods. As the rainbow unites earth and heaven, Iris is the messenger of the gods to men; in this capacity she is mentioned frequently in the *Iliad*, but never in the *Odyssey*, where Hermes takes her place. She is represented as a youthful virgin, with wings of gold, who hurries with the swiftness of the wind from one end of the world to the other, into the depths of the sea and the underworld. She is especially the messenger of Zeus and Hera, and is associated with Hermes, whose caduceus or staff she often holds. By command of Zeus she carries in an ewer water from the Styx, with which she puts to sleep all who perjure themselves. Her attributes are the caduceus and a vase.

**IRIS**, in botany. The iris flower belongs to the natural order Iridaceae of the class Monocotyledons, which is characterized by a petaloid six-parted perianth, an inferior ovary and only three stamens (the outer series), being thus distinguished from the Amaryllidaceae family, which has six stamens. They are handsome showy-flowered plants, the Greek name having been applied on account of the hues of the flowers. The genus contains about 170 species widely distributed throughout the north temperate zone. Two of the species are British. *I. Pseudacorus*, the yellow flag or iris, is common in Britain on river-banks, and in marshes and ditches. It is called the "water-flag" or "bastard floure de-luce" by Gerard, who remarks that "although it be a water plant of nature, yet being planted in gardens it prospereth well." Its flowers appear in June and July, and are of a golden-yellow colour. The leaves are from 2 to 4 ft. long, and half an inch to an inch broad. Towards the latter part of the year they are eaten by cattle. The seeds are numerous and pale-brown; they have been recommended when roasted as a substitute for coffee, of which, however, they have not the properties. The astringent rhizome has diuretic, purgative and emetic properties, and may, it is said, be used for dyeing black, and in the place of galls for ink-making. The other British species, *I. foetidissima*, the fetid iris, gladdon or roast-beef plant, the *Xyris* or stinking gladdon of Gerard, is a native of England south of Durham, and also of Ireland, southern Europe and North Africa. Its flowers are usually of a dull, leaden-blue colour; the capsules, which remain attached to the plant throughout the winter, are 2 to 3 in. long; and the seeds scarlet. When bruised this species emits a peculiar and disagreeable odour.

*Iris florentina*, with white or pale-blue flowers, is a native of the south of Europe, and is the source of the violet-scented orris root used in perfumery. *Iris versicolor*, or blue flag, is indigenous to North America, and yields "iridin," a powerful hepatic stimulant. *Iris germanica* of central Europe, "the most common purple Fleur de Luce" of Ray, is the large common blue iris of gardens, the bearded iris or fleur de luce and probably the Illyrian iris of the ancients. From the flowers of *Iris florentina* a pigment—the "verdelis," "vert d'iris," or iris-green, formerly used by miniature painters—was prepared by maceration, the fluid being left to putrefy, when chalk or alum was added. The garden plants known as the Spanish iris and the English iris are both of Spanish origin, and have very showy flowers. Along with some other species, as *I. reticulata* and *I. persica*, both of which are fragrant, they form great favourites with florists. All these just mentioned differ from those formerly named in the nature of the underground stem, which forms a bulb and not a strict creeping rhizome as in *I. Pseudacorus*, *germanica*, *florentina*, &c. Some botanists separate these bulbous

irises from the genus *Iris*, and place them apart in the genus *Xiphium*, the Spanish iris, including about 30 species, all from the Mediterranean region and the East.

The iris flower is of special interest as an example of the relation between the shape of the flower and the position of the pollen-



FIG. 1.—Gynoecium of *Iris*, consisting of an inferior ovary *o*, and a style, with three petaloid segments *s*, bearing stigmas *st*.



FIG. 2.—Diagram of Trimerus Symmetrical Flower of *Iris*, with two whorls of perianth, three stamens in one whorl and an ovary formed of three carpels. The three dots indicate the position of an inner whorl of stamens which is present in the allied families Amaryllidaceae and Liliaceae but absent in Iridaceae.

beneath the over-arching style arm above the stigma, so that the insect comes in contact with its pollen-covered surface only after passing the stigma, while in backing out of the flower it will come in contact only with the non-receptive lower face of the stigma. Thus an insect bearing pollen from one flower will in entering a second deposit the pollen on the stigma, while in backing out of a flower the pollen which it bears will not be rubbed off on the stigma of the same flower.

The hardier bulbous irises, including the Spanish iris (*I. Xiphium*) and the English iris (*I. xiphoides*, so called, which is also of Spanish origin), require to be planted in thoroughly drained beds in very light open soil, moderately enriched, and should have a rather sheltered position. Both these present a long series of beautiful varieties of the most diverse colours, flowering in May, June and July, the smaller Spanish iris being the earlier of the two. There are many other smaller species of bulbous iris. Being liable to perish from excess of moisture, they should have a well-drained bed of good but porous soil made up for them, in some sunny spot, and in winter should be protected by a 6-in. covering of half-decayed leaves or fresh coco-fibre refuse. To this set belong *I. persica*, *reticulata*, *filifolia*, *Histrio*, *juicea*, *Danfordiae*, *Rosenbachiana* and others which flower as early as February and March.

The flag irises are for the most part of the easiest culture; they grow in any good free garden soil, the smaller and more delicate species only needing the aid of turfy ingredients, either peaty or loamy, to keep it light and open in texture. The earliest to bloom are the dwarf forms of *Iris pumila*, which blossom during March, April and May; and during the latter month and the following one most of the larger growing species, such as *I. germanica*, *florentina*, *pauciflora*, *variegata*, *amoena*, *flavescens*, *sambucina*, *neglecta*, *ruthenica*, &c., produce their gorgeous flowers. Of many of the named varieties there are, besides the typical form, a considerable number of various garden varieties. *Iris unguicularis* (or *stydosa*) is a remarkable winter flowering species from Algeria, with sky-blue flowers blotched with yellow, produced at irregular intervals from November to March, the blakest period of the year.

The beautiful Japanese *Iris Kaempferi* (or *I. laetigiflora*) is of comparatively modern introduction, and though of a distinct type is equally beautiful with the better-known species. The outer segments are rather spreading than deflexed, forming an almost circular flower, which becomes quite so in some of the very remarkable duplex varieties, in which six of these broad segments are produced instead of three. Of this too there are numberless varieties cultivated under names. They require a sandy peat soil on a cool moist subsoil.

What are known as *Oncocyclus*, or cushion irises, constitute a magnificent group of plants remarkable for their large, showy and beautifully marked flowers. Compared with other irises the "cushion" varieties are scantily furnished with narrow sickle-shaped leaves and the blossoms are usually borne singly on the stalks. The best-known kinds are *atrofucosa*, *Barnumiae*, *Bismarckiana*, *Gatesii*, *Helyandiana*, *Iberica*, *Lortetii*, *Haynesii*, *lupulina*, *Mariae*, *meda-paradoxa*, *suri*, *safarana* and *sustiana*—the last-named being popularly called the "mourning" iris owing to the dark silvery

appearance of its huge flowers. All these cushion irises are somewhat fastidious growers, and to be successful with them they must be planted rather shallow in very gritty well-drained soil. They should not be disturbed in the autumn, and after the leaves have withered the roots should be protected from heavy rains until growth starts again naturally.

A closely allied group to the cushion irises are those known as *Regelia*, of which *Koroikowi*, *Leichlinii* and *tuga* are the best known. Some magnificent hybrids have been raised between these two groups, and a hardier and more easily grown race of garden irises has been produced under the name of *Regelio-Cyclus*. They are best planted in September or October in warm sunny positions, the rhizomes being lifted the following July after the leaves have withered.

**IRISH MOSS**, or **CARRAGEEN** (*Iris carraigeen*, "a moss of the rock"), a sea-weed (*Chondrus crispus*) which grows abundantly along the rocky parts of the Atlantic coast of Europe and North America. In its fresh condition the plant is soft and cartilaginous, varying in colour from a greenish-yellow to a dark purple or purplish-brown; but when washed and sun-dried for preservation it has a yellowish translucent horn-like aspect and consistency. The principal constituent of Irish moss is a mucilaginous body, of which it contains about 55%; and with that it has nearly 10% of albuminoids and about 15% of mineral matter rich in iodine and sulphur. When softened in water it has a sea-like odour, and from the abundance of its mucilage it will form a jelly on boiling with from 20 to 30 times its weight of water. The jelly of Irish moss is used as an occasional article of food. It may also be used as a thickener in calico-printing and for firing beer. Irish moss is frequently mixed with *Gigartina mammillosa*, *G. acicularis* and other sea-weeds with which it is associated in growth.

**IRKUTSK**, a government of Asiatic Russia, in East Siberia, bounded on the W. by the government of Yeniseisk, on the N. by Yakutsk, on the E. by Lake Baikal and Transbaikalia and on the S. and S.W. by Mongolia; area, 287,061 sq. m. The most populous region is a belt of plains 1200 to 2000 ft. in altitude, which stretch north-west to south-east, having the Sayan mountains on the south and the Baikal mountains on the north, and narrowing as it approaches the town of Irkutsk. The high road, now the Trans-Siberian railway, follows this belt. The south-western part of the government is occupied by mountains of the Sayan system, whose exact orography is as yet not well known. From the high plateau of Mongolia, fringed by the Sayan mountains, of which the culminating point is the snow-clad Munko-sardyk (11,150 ft.), a number of ranges, 7500 to 8500 ft. high, strike off in a north-east direction. Going from south to north they are distinguished as the Tunka Alps, the Kitoi Alps (both snow-clad nearly all the year round), the Ida mountains and the Kuitun mountains. These are, however, by no means regular chains, but on the contrary are a complex result of upheavals which took place at different geological epochs, and of denudation on a colossal scale. A beautiful, fertile valley, drained by the river Irkut, stretches between the Tunka Alps and the Sayan, and another somewhat higher plain, but not so wide, stretches along the river Kitoi. A succession of high plains, 2000 to 2500 ft. in altitude, formed of horizontal beds of Devonian (or Upper Silurian) sandstone and limestone, extends to the north of the railway along the Angara, or Verkhnyaya (i.e. upper) Tunguzka, and the upper Lena, as far as Kirensk. The Bratskaya Steppe, west of the Angara, is a prairie peopled by Buriats. A mountain region, usually described as the Baikal range, but containing in reality of several ranges running north-eastwards, across Lake Baikal, and scooped out to form the depression occupied by the lake, is fringed on its north-western slope by horizontal beds of sandstone and limestone. Farther north-east the space between the Lena and the Vitim is occupied by another mountain region belonging to the Olekma and Vitim system, composed of several parallel mountain chains running north-eastwards (across the lower Vitim), and auriferous in the drainage area of the Mama (N.E. of Lake Baikal). Lake Baikal separates Irkutsk from Transbaikalia. The principal rivers of the government are the Angara, which flows from this lake northwards, with numerous sharp windings, and receives from the left several large tributaries.

as the Irkut, Kitoi, Byelaya, Oka and Iya. The Lena is the principal means of communication both with the gold-mines on its own tributary, the lower Vitim, and with the province of Yakutsk. The Nizhnyaya Tunguzka flows northwards, to join the Yenisei in the far north, and the mountain streams tributary to the Vitim drain the north-east.

The post-Tertiary formations are represented by glacial deposits in the highlands and less on their borders. Jurassic deposits are met with in a zone running north-westwards from Lake Baikal to Nizhne-udinsk. The remainder of this region is covered by vast series of Carboniferous, Devonian and Silurian deposits—the first two but slightly disturbed over wide areas. All the highlands are built up of older, semi-crystalline Cambro-Silurian strata, which attain a thickness of 2500 ft., and of crystalline slates and limestones of the Laurentian system, with granites, syenites, diorites and diabases protruding from beneath them. Very extensive beds of basaltic lavas and other volcanic deposits are spread along the border ridge of the high plateau, about Munko-sarydk, up the Irkut, and on the upper Oka, where cones of extinct volcanoes are found (Jun-bulak). Earthquakes are frequent in the neighbourhood of Lake Baikal and the surrounding region. Gold is extracted in the Nizhne-udinsk district; graphite is found on the Botu-gol and Alibert mountains (abandoned many years since) and on the Olkhon island of Lake Baikal. Brown coal (Jurassic) is found in many places, and coal on the Oka. The salt springs of Ussolye (45 m. west of Irkutsk), as also those on the Ilm and of Ust-Kutsk (on the Lena), yield annually about 7000 tons of salt. Fireclay, grindstones, marble and mica, lapis-lazuli, granites and various semi-precious stones occur on the Sludnyanka (south-west corner of the Baikal).

The climate is severe; the mean temperatures being at Irkutsk (1520 ft.) for the year 31° Fahr., for January -6°, for July 65°; at Shimki (valley of the Irkut, 2620 ft.), for the year 24°, for January -17°, for July 63°. The average rainfall is 15 in. a year. Virgin forests cover all the highlands up to 6500 ft.

The population which was 383,578 in 1870, was 515,132 in 1897, of whom 238,997 were women and 60,396 were urban; except about 109,000 Buriats and 1700 Tunguses, they are Russians. The estimated population in 1906 was 552,700. Immigration contributes about 14,000 every year. Schools are numerous at Irkutsk, but quite insufficient in the country districts, and only 12% of the children receive education. The soil is very fertile in certain parts, but meagre elsewhere, and less than a million acres are under crops (rye, wheat, barley, oats, buckwheat, potatoes). Grain has to be imported from West Siberia and cattle from Transbaikalia. Fisheries on Lake Baikal supply every year about 2,400,000 Baikal herring (*omul*). Industry is only beginning to be developed (iron-works, glass- and pottery-works and distilleries, and all manufactured goods are imported from Russia. The government is divided into five districts, the chief towns of which are Irkutsk (*g.n.*), Balagansk (pop., 1313 in 1897), Kirensk (2253), Nizhneudinsk and Verkhloensk. (P. A. K.; J. T. Bc.)

**IRKUTSK**, the chief town of the above government, is the most important place in Siberia, being not only the largest centre of population and the principal commercial depot north of Tashkent, but a fortified military post, an archbishopric of the Orthodox Greek Church and the seat of several learned societies. It is situated in 52° 17' N. and 104° 16' E., 3792 m. by rail from St Petersburg. Pop. (1875) 32,512, (1900) 49,106. The town proper lies on the right bank of the Angara, a tributary of the Yenisei, 45 m. below its outflow from Lake Baikal, and on the opposite bank lies the Glaskovsk suburb. The river, which has a breadth of 1000 ft., is crossed by a flying bridge. The Irkut, from which the town takes its name, is a small river which joins the Angara directly opposite the town, the main portion of which is separated from the monastery, the castle, the port and the suburbs by another affluent, the Ida or Ushakovka. Irkutsk has long been reputed a remarkably fine city—its streets being straight, broad, well paved and well lighted; but in 1879, on the 4th and 6th of July, the palace of the (then) governor-general, the principal administrative and municipal offices and many of the other public buildings were destroyed by fire; and the government archives, the library and museum of the Siberian section of the Russian Geographical Society were utterly ruined. A cathedral (built of wood in 1693 and rebuilt of stone in 1718), the governor's palace, a school of medicine, a museum, a military hospital, and the crown factories are among

the public institutions and buildings. An important fair is held in December. Irkutsk grew out of the winter-quarters established (1652) by Ivan Pokhobov for the collection of the fur tax from the Buriats. Its existence as a town dates from 1686.

**IRMIN**, or **IRMINUS**, in Teutonic mythology, a deified epynymic hero of the Hermiones. The chief seat of his worship was Irmlins, or Ermensul, in Westphalia, destroyed in 772 by Charlemagne. Huge wooden posts (Irmin pillars) were raised to his honour, and were regarded as sacred by the Saxons.

**IRNERIUS** (Hirnerius, Hyrnerius, Iernerius, Germerius, Guamerius, Warnerius, Wernerius, Yrnerius), Italian jurist, sometimes referred to as "lucerna juris." He taught the "free arts" at Bologna, his native city, during the earlier decades of the 12th century. Of his personal history nothing is known, except that it was at the instance of the countess Matilda, Hildebrand's friend, who died in 1115, that he directed his attention and that of his students to the *Institutes* and *Code* of Justinian; that after 1116 he appears to have held some office under the emperor Henry V.; and that he died, perhaps during the reign of the emperor Lothair II., but certainly before 1140. He was the first of the Glossators (see GLOSS), and according to ancient opinion (which, however, has been much controverted) was the author of the epitome of the *Novellae* of Justinian, called the *Authentica*, arranged according to the titles of the *Code*. His *Formularium tabellionum* (a directory for notaries) and *Questiones* (a book of decisions) are no longer extant. (See ROMAN LAW.)

See Savigny, *Gesch. d. röm. Rechts im Mittelalter*, iii. 83; Vecchio, *Notizie di Irnerio e della sua scuola* (Pisa, 1869); Ficker, *Forsch. z. Reichs- u. Rechtsgesch. Italiens*, vol. iii. (Innsbruck, 1870); and Fitting, *Die Anfänge der Rechtsschule zu Bologna* (Berlin, 1889).

**IRON** [symbol Fe, atomic weight 55.85 (O=16)], a metallic chemical element. Although iron occurs only sparingly in the free state, the abundance of ores from which it may be readily obtained led to its application in the arts at a very remote period. It is generally agreed, however, that the Iron Age, the period of civilization during which this metal played an all-important part, succeeded the ages of copper and bronze, notwithstanding the fact that the extraction of these metals required greater metallurgical skill. The Assyrians and Egyptians made considerable use of the metal; and in Genesis iv. 22 mention is made of Tubal-cain as the instructor of workers in iron and copper. The earlier sources of the ores appear to have been in India; the Greeks, however, obtained it from the Chalybes, who dwelt on the south coast of the Black Sea; and the Romans, besides drawing from these deposits, also exploited Spain, Elba and the province of Noricum. (See METAL-WORK.)

The chief occurrences of metallic iron are as minute spicules disseminated through basaltic rocks, as at Giant's Causeway and in the Auvergne, and, more particularly, in meteorites (*g.n.*). In combination it occurs, usually in small quantity, in most natural waters, in plants, and as a necessary constituent of blood. The economic sources are treated under IRON AND STEEL below; in the same place will be found accounts of the manufacture, properties, and uses of the metal, the present article being confined to its chemistry. The principal iron ores are the oxides and carbonates, and these readily yield the metal by smelting with carbon. The metal so obtained invariably contains a certain amount of carbon, free or combined, and the proportion and condition regulate the properties of the metal, giving origin to the three important varieties: cast iron, steel, wrought iron. The perfectly pure metal may be prepared by heating the oxide or oxalate in a current of hydrogen; when obtained at a low temperature it is a black powder which oxidizes in air with incandescence; produced at higher temperatures the metal is not pyrophoric. Péligré obtained it as minute tetragonal octahedra and cubes by reducing ferrous chloride in hydrogen. It may be obtained electrolytically from solutions of ferrous and magnesium sulphates and sodium bicarbonate, a wrought iron anode and a rotating cathode of copper, thinly silvered and iodized, being employed (S. Maximowitsch, *Zeit. Elektrochem.*, 1905, 11, p. 52).

In bulk, the metal has a silvery white lustre and takes a high polish. Its specific gravity is 7.84; and the average specific heat over the range  $15^{\circ}$ – $100^{\circ}$  is 0.10983; this value increases with temperature to  $850^{\circ}$ , and then begins to diminish. It is the most tenacious of all the ductile metals at ordinary temperatures with the exception of cobalt and nickel; it becomes brittle, however, at the temperature of liquid air. It softens at a red heat, and may be readily welded at a white heat; above this point it becomes brittle. It fuses at about  $1550^{\circ}$ – $1600^{\circ}$ , and may be distilled in the electric furnace (H. Moissan, *Compt. rend.*, 1906, 142, p. 425). It is attracted by a magnet and may be magnetized, but the magnetization is quickly lost. The variation of physical properties which attends iron on heating has led to the view that the metal exists in allotropic forms (see IRON AND STEEL, below).

Iron is very reactive chemically. Exposed to atmospheric influences it is more or less rapidly corroded, giving the familiar rust (*q.v.*). S. Burnie (*Abst. J.C.S.*, 1907, ii, p. 469) has shown that water is decomposed at all temperatures from  $0^{\circ}$  to  $100^{\circ}$  by the finely divided metal with liberation of hydrogen, the action being accelerated when oxides are present. The decomposition of steam by passing it through a red-hot gun-barrel, resulting in the liberation of hydrogen and the production of magnetic iron oxide,  $\text{Fe}_3\text{O}_4$ , is a familiar laboratory method for preparing hydrogen (*q.v.*). When strongly heated iron inflames in oxygen and in sulphur vapour; it also combines directly with the halogens. It dissolves in most dilute acids with liberation of hydrogen; the reaction between sulphuric acid and iron turnings being used for the commercial manufacture of this gas. It dissolves in dilute cold nitric acid with the formation of ferrous and ammonium nitrates, no gases being liberated; when heated or with stronger acid ferric nitrate is formed with evolution of nitrogen oxides.

It was observed by James Keir (*Phil. Trans.*, 1790, p. 350) that iron, after having been immersed in strong nitric acid, is insoluble in acids, neither does it precipitate metals from solutions. This "passivity" may be brought about by immersion in other solutions, especially by those containing such oxidizing anions as  $\text{NO}_3^-$ ,  $\text{ClO}_3^-$ , less strongly by the anions  $\text{SO}_4^{2-}$ ,  $\text{CN}^-$ ,  $\text{CNS}^-$ ,  $\text{C}_2\text{H}_3\text{O}_2^-$ ,  $\text{OH}^-$ , while  $\text{Cl}^-$ ,  $\text{Br}^-$  practically inhibit passivity;  $\text{H}^+$  is the only cation which has any effect, and this tends to exclude passivity. It is also occasioned by anodic polarization of iron in sulphuric acid. Other metals may be rendered passive; for example, zinc does not precipitate copper from solutions of the double cyanides and sulphocyanides, nickel and cadmium from the nitrates, and iron from the sulphate, but it immediately throws down nickel and cadmium from the sulphates and chlorides, and lead and copper from the nitrates (see O. Sackur, *Zeit. Elektrochem.*, 1904, 10, p. 841). Anodic polarization in potassium chloride solution renders molybdenum, niobium, ruthenium, tungsten, and vanadium passive (W. Muthmann and F. Frauenberger, *Sitz. Bayer. Akad. Wiss.*, 1904, 34, p. 201), and also gold in commercial potassium cyanide solution (A. Coehn and C. L. Jacobsen, *Abst. J.C.S.*, 1907, ii, p. 026). Several hypotheses have been promoted to explain this behaviour, and, although the question is not definitely settled, the more probable view is that it is caused by the formation of a film of an oxide, a suggestion made many years ago by Faraday (see P. Krassa, *Zeit. Elektrochem.*, 1900, 15, p. 490). Fredenhagen (*Zeit. physik. Chem.*, 1903, 43, p. 1), on the other hand, regarded it as due to surface films of a gas; submitting that the difference between iron made passive by nitric acid and by anodic polarization was explained by the film being of nitrogen oxides in the first case and of oxygen in the second case. H. L. Heathcote and others regard the passivity as invariably due to electrolytic action (see papers in the *Zeit. physik. Chem.*, 1901 et seq.).

#### Compounds of Iron.

**Oxides and Hydroxides.**—Iron forms three oxides: ferrous oxide,  $\text{FeO}$ , ferric oxide,  $\text{Fe}_2\text{O}_3$ , and ferroso-ferric oxide,  $\text{Fe}_3\text{O}_4$ . The first two give origin to well-defined series of salts, the ferrous

salts, wherein the metal is divalent, and the ferric salts, wherein the metal is trivalent; the former readily pass into the latter on oxidation, and the latter into the former on reduction.

**Ferrous oxide** is obtained when ferric oxide is reduced in hydrogen at  $300^{\circ}$  as a black pyrophoric powder. Sabatier and Senderens (*Compt. rend.*, 1892, 114, p. 1420) obtained it by acting with nitrous oxide on metallic iron at  $200^{\circ}$ , and Tissandier by heating the metal to  $900^{\circ}$  in carbon dioxide; Donau (*Monats.*, 1904, 25, p. 181), on the other hand, obtained a magnetic and crystalline-ferroso-ferric oxide at  $1200^{\circ}$ . It may also be prepared as a black velvety powder which readily takes up oxygen from the air by adding ferrous oxalate to boiling caustic potash. Ferrous hydrate,  $\text{Fe}(\text{OH})_2$ , when prepared from a pure ferrous salt and caustic soda or potash free from air, is a white powder which may be preserved in an atmosphere of hydrogen. Usually, however, it forms a greenish mass, owing to partial oxidation. It oxidizes on exposure with considerable evolution of heat; it rapidly absorbs carbon dioxide; and readily dissolves in acids to form ferrous salts, which are usually white when anhydrous, but greenish when hydrated.

**Ferric oxide** or iron sesquioxide,  $\text{Fe}_2\text{O}_3$ , constitutes the valuable ores red haematite and specular iron; the minerals brown haematite or limonite, and gōthite and also iron rust are hydrated forms. It is obtained as a steel-grey crystalline powder by igniting the oxide or any ferric salt containing a volatile acid. Small crystals are formed by passing ferric chloride vapour over heated lime. When finely ground these crystals yield a brownish red powder which dissolves slowly in acids, the most effective solvent being a boiling mixture of 8 parts of sulphuric acid and 3 of water. Ferric oxide is employed as a pigment, as jeweller's rouge, and for polishing metals. It forms several hydrates, the medicinal value of which was recognized in very remote times. Two series of synthetic hydrates were recognized by Muck and Tommasi: the "red" hydrates, obtained by precipitating ferric salts with alkalis, and the "yellow" hydrates, obtained by oxidizing moist ferrous hydroxide or carbonates. J. van Bemmelen has shown that the red hydrates are really colloids, the amount of water retained being such that its vapour pressure equals the pressure of the aqueous vapour in the superincumbent atmosphere. By heating freshly prepared red ferric hydrate with water under 5000 atmospheres pressure Ruff (*Ber.*, 1901, 34, p. 3417) obtained definite hydrates corresponding to the minerals limonite ( $30^{\circ}$ – $42.5^{\circ}$ ), gōthite ( $42.5^{\circ}$ – $62.5^{\circ}$ ), and hydrohaematite (above  $62.5^{\circ}$ ). Thomas Graham obtained a soluble hydrate by dissolving the freshly prepared hydrate in ferric chloride and dialysing the solution, the soluble hydrate being left in the dialyser. All the chlorine, however, does not appear to be removed by this process, the residue having the composition  $82\text{Fe}(\text{OH})_3 \cdot \text{FeCl}_3$ ; but it may be by electrolysis in a porous cell (Tribot and Chrétien, *Compt. rend.*, 1905, 140, p. 144). On standing, the solution usually gelatinizes, a process accelerated by the addition of an electrolyte. It is employed in medicine under the name *Liquor ferri dialysati*. The so-called soluble meta-ferric hydroxide,  $\text{FeO}(\text{OH})$  (?), discovered by Péan de St Gilles in 1856, may be obtained by several methods. By heating solutions of certain iron salts for some time and then adding a little sulphuric acid it is precipitated as a brown powder. Black scales, which dissolve in water to form a red solution, are obtained by adding a trace of hydrochloric acid to a solution of basic ferric nitrate which has been heated to  $100^{\circ}$  for three days. A similar compound, which, however, dissolves in water to form an orange solution, results by adding salt to a heated solution of ferric chloride. These compounds are insoluble in concentrated, but dissolve readily in dilute acids.

Red ferric hydroxide dissolves in acids to form a well-defined series of salts, the ferric salts, also obtained by oxidizing ferrous salts; they are usually colourless when anhydrous, but yellow or brown when hydrated. It has also feebly acidic properties, forming ferrites with strong bases.

**Magnetite**,  $\text{Fe}_3\text{O}_4$ , may be regarded as ferrous ferrite,  $\text{FeO} \cdot \text{Fe}_2\text{O}_3$ . This important ore of iron is most celebrated for its magnetic properties (see MAGNETISM and COMPASS), but the

mineral is not always magnetic, although invariably attracted by a magnet. It may be obtained artificially by passing steam over red-hot iron. It dissolves in acids to form a mixture of a ferrous and ferric salt,<sup>1</sup> and if an alkali is added to the solution a black precipitate is obtained which dries to a dark brown mass of the composition  $\text{Fe}(\text{OH})_2 \cdot \text{Fe}_2\text{O}_3$ ; this substance is attracted by a magnet, and thus may be separated from the admixed ferric oxide. Calcium ferrite, magnesium ferrite and zinc ferrite,  $\text{RO} \cdot \text{Fe}_2\text{O}_3$  (R = Ca, Mg, Zn), are obtained by intensely heating mixtures of the oxides; magnesium ferrite occurs in nature as the mineral magnoferrite, and zinc ferrite as franklinite, both forming black octahedra.

**Ferric acid,  $\text{H}_2\text{FeO}_4$ .** By fusing iron with saltpetre and extracting the melt with water, or by adding a solution of ferric nitrate in nitric acid to strong potash, an amethyst or purple-red solution is obtained which contains potassium ferrate. E. Frémy investigated this discovery, made by Stahl in 1702, and showed that the same solution resulted when chlorine is passed into strong potash solution containing ferric hydrate in suspension. Haber and Pick (*Zeit. Elektrochem.*, 1900, 7, p. 215) have prepared potassium ferrate by electrolyzing concentrated potash solution, using an iron anode. A temperature of  $70^\circ$ , and a reversal of the current (of low density) between two cast iron electrodes every few minutes, are the best working conditions. When concentrated the solution is nearly black, and on heating it yields a yellow solution of potassium ferrite, oxygen being evolved. Barium ferrate,  $\text{BaFeO}_4 \cdot \text{H}_2\text{O}$ , obtained as a dark red powder by adding barium chloride to a solution of potassium ferrate, is fairly stable. It dissolves in acetic acid to form a red solution, is not decomposed by cold sulphuric acid, but with hydrochloric or nitric acid it yields barium and ferric salts, with evolution of chlorine or oxygen (Bascieri, *Gazzetta*, 1906, 36, ii, p. 282).

**Halogen Compounds.**—Ferrous fluoride,  $\text{FeF}_2$ , is obtained as colourless prisms (with  $8\text{H}_2\text{O}$ ) by dissolving iron in hydrofluoric acid, or as anhydrous colourless rhombic prisms by heating iron or ferric chloride in dry hydrofluoric acid gas. Ferric fluoride,  $\text{FeF}_3$ , is obtained as colourless crystals (with  $4\frac{1}{2}\text{H}_2\text{O}$ ) by evaporating a solution of the hydroxide in hydrofluoric acid. When heated in air it yields ferric oxide. Ferrous chloride,  $\text{FeCl}_2$ , is obtained as shining scales by passing chlorine, or better, hydrochloric acid gas, over red-hot iron, or by reducing ferric chloride in a current of hydrogen. It is very deliquescent, and freely dissolves in water and alcohol. Heated in air it yields a mixture of ferric oxide and chloride, and in steam magnetic oxide, hydrochloric acid, and hydrogen. It absorbs ammonia gas, forming the compound  $\text{FeCl}_2 \cdot 6\text{NH}_3$ , which on heating loses ammonia, and, finally, yields ammonium chloride, nitrogen and iron nitride. It fuses at a red-heat, and volatilizes at a yellow-heat; its vapour density at  $1300^\circ$ – $1400^\circ$  corresponds to the formula  $\text{FeCl}_2$ . By evaporating in vacuo the solution obtained by dissolving iron in hydrochloric acid, there results bluish, monoclinic crystals of  $\text{FeCl}_2 \cdot 4\text{H}_2\text{O}$ , which deliquesce, turning greenish, on exposure to air, and effloresce in a desiccator. Other hydrates are known. By adding ammonium chloride to the solution, evaporating in vacuo, and then volatilizing the ammonium chloride, anhydrous ferrous chloride is obtained. The solution, in common with those of most ferrous salts, absorbs nitric oxide with the formation of a brownish solution.

Ferric chloride,  $\text{FeCl}_3$ , known in its aqueous solution to Glauber as *oleum martis*, may be obtained anhydrous by the action of dry chlorine on the metal at a moderate red-heat, or by passing hydrochloric acid gas over heated ferric oxide. It forms iron-black plates or tablets which appear red by transmitted and metallic green by reflected light. It is very deliquescent, and readily dissolves in water, forming a brown or yellow solution, from which several hydrates may be separated (see SOLUTION). The solution is best prepared by dissolving the hydrate in hydrochloric acid and removing the excess of acid by evaporation, or by passing chlorine into the solution obtained by dissolving the metal in hydrochloric acid and removing the excess of chlorine by a current of carbon dioxide. It also dissolves in alcohol and ether; boiling point determinations of the molecular weight in these solutions point to the formula  $\text{FeCl}_3$ . Vapour density determinations at  $448^\circ$  indicate a partial dissociation of the double molecule  $\text{Fe}_2\text{Cl}_6$  into stronger heating it splits into ferrous chloride and chlorine. It forms red crystalline double salts with the chlorides of the metals of the alkalis and of the

magnesium group. An aqueous solution of ferric chloride is used in pharmacy under the name *liquor ferri perchloridi*; and an alcoholic solution constitutes the *Quack jermi* known as "Lamotte's golden drops." Many oxychlorides are known; soluble forms are obtained by dissolving precipitated ferric hydrate in ferric chloride, whilst insoluble compounds result when ferrous chloride is oxidized in air, or by boiling for some time aqueous solutions of ferric chloride.

Ferrous bromide,  $\text{FeBr}_2$ , is obtained as yellowish crystals by the union of bromine with iron at a dull red-heat, or as bluish-green rhombic tables of the composition  $\text{FeBr}_2 \cdot 6\text{H}_2\text{O}$  by crystallizing a solution of iron in hydrobromic acid. Ferric bromide,  $\text{FeBr}_3$ , is obtained as dark red crystals by heating iron in an excess of bromine vapour. It closely resembles the chloride in being deliquescent, dissolving ferric hydrate, and in yielding basic salts. Ferrous iodide,  $\text{FeI}_2$ , is obtained as a grey crystalline mass by the direct union of its components. Ferric iodide does not appear to exist.

**Sulphur Compounds.**—Ferrous sulphide,  $\text{FeS}$ , results from the direct union of its elements, best by stirring molten sulphur with a wire-hot iron rod, when the sulphide drops to the bottom of the crucible. It then forms a yellowish crystalline mass, which readily dissolves in acids with the liberation of sulphuretted hydrogen. Heated in air it at first partially oxidizes to ferrous sulphate, and at higher temperatures it yields sulphur dioxide and ferric oxide. It is unaltered by ignition in hydrogen. An amorphous form results when a mixture of iron filings and sulphur are triturated with water. This modification is rapidly oxidized by the air with such an elevation of temperature that the mass may become incandescent. Another black amorphous form results when ferrous salts are precipitated by ammonium sulphide.

Ferrous sulphide,  $\text{FeS}_2$ , is obtained by gently heating mixture of its constituent elements, or by the action of sulphuretted hydrogen on ferric oxide at temperatures below  $100^\circ$ . It is also prepared by precipitating a ferric salt with ammonium sulphide; unless the alkali be in excess a mixture of ferrous sulphide and sulphur is obtained. It combines with other sulphides to form compounds of the type  $\text{M}'_2\text{FeS}_2$ . Potassium ferric sulphide,  $\text{K}_2\text{FeS}_4$ , obtained by heating a mixture of iron filings, sulphur and potassium carbonate, forms purple glistening crystals, which burn when heated in air. Magnetic pyrites or pyrrhotite has a composition varying between  $\text{FeS}_2$  and  $\text{FeS}$ , i.e.  $3\text{FeS} \cdot \text{FeS}_2$  and  $6\text{FeS} \cdot \text{FeS}_2$ . It has a somewhat anisotropic structure, and occurs in rhombic plates; it is attracted by a magnet and is sometimes itself ferromagnetic; mineral is abundant in Canada, where the presence of about 5% of nickel makes it a valuable ore of this metal. Iron disulphide,  $\text{FeS}_2$ , constitutes the minerals pyrite and marcasite (q.v.); copper pyrites is (Cu, Fe) $\text{S}_2$ . Pyrite may be prepared artificially by gently heating ferrous sulphide with sulphur, or as brassy octahedra and cubes by slowly heating an intimate mixture of ferric oxide, sulphur and sal-ammoniac. It is insoluble in dilute acids, but dissolves in nitric acid with separation of sulphur.

Ferrous sulphate,  $\text{FeSO}_4$ , iron dissolves in a solution of sulphur in the absence of air to form ferrous sulphate and thio-sulphate; the former, being less soluble than the latter, separates out as colourless or greenish crystals on standing.

Ferrous sulphate, green vitriol or coppers,  $\text{FeSO}_4 \cdot 7\text{H}_2\text{O}$ , was known to, and used by, the alchemists; it is mentioned in the writings of Agricola, and its preparation from iron and sulphuric acid occurs in the *Tractatus chymico-philosophicus* ascribed to Basil Valentine. It occurs in nature as the mineral melanterite, either crystalline or fibrous, but usually massive; it appears to have been formed by the oxidation of pyrite or marcasite. It is manufactured by oxidizing pyrites in heaps, or by exposing it to atmospheric oxidation, the ferrous sulphate thus formed being dissolved in water, the solution run into tanks, where any sulphuric acid which may be formed is decomposed by adding scrap iron. By evaporation the green vitriol is obtained as large crystals. The chief impurities are copper and ferric sulphates; the former may be removed by adding scrap iron, which precipitates the copper; the latter is eliminated by recrystallization. Other impurities such as zinc and manganese sulphates are more difficult to remove, and hence to prepare the pure salt it is best to dissolve pure iron wire in dilute sulphuric acid. Ferrous sulphate forms large green crystals belonging to the monoclinic system; rhombic crystals, isomorphous with zinc sulphate, are obtained by inoculating a solution with crystal of zinc sulphate, and triclinic crystals of the formula  $\text{FeSO}_4 \cdot 5\text{H}_2\text{O}$  by inoculating with copper sulphate. By evaporating a solution containing free sulphuric acid in a vacuum, the hepta-hydrated salt first separates, then the penta-, and then a tetra-hydrate,  $\text{FeSO}_4 \cdot 4\text{H}_2\text{O}$ , isomorphous with manganese sulphate. By gently heating in a vacuum to  $140^\circ$ , the hepta-hydrate loses 6 molecules of water, and yields a white powder, which on heating in the absence of air gives the anhydrous salt. The monohydrate also results as a white precipitate when concentrated sulphuric acid is added to a saturated solution of ferrous sulphate. Below also results from the salt from aqueous solution, the composition of the precipitate varying with the amount of salt and precipitant employed. The solution absorbs nitric oxide to form a dark brown solution, which loses the gas on heating or by placing in a vacuum. Ferrous sulphate forms double salts with the alkaline sulphates. The most important is ferrous ammonium sulphate,  $\text{FeSO}_4 \cdot (\text{NH}_4)_2\text{SO}_4 \cdot 6\text{H}_2\text{O}$ , obtained by dissolving equivalent amounts

<sup>1</sup> By solution in concentrated hydrochloric acid, a yellow liquid is obtained, which on concentration over sulphuric acid gives yellow deliquescent crusts of ferrous-ferric chloride,  $\text{Fe}_2\text{Cl}_4 \cdot 18\text{H}_2\text{O}$ .



of the two salts in water and crystallizing. It is very stable and is much used in volumetric analysis.

Ferric sulphate,  $\text{Fe}_2(\text{SO}_4)_3$ , is obtained by adding nitric acid to a hot solution of ferrous sulphate containing sulphuric acid, colourless crystals being deposited on evaporating the solution. The anhydrous salt is obtained by heating, or by adding concentrated sulphuric acid to a strongly soluble iron salt, and on cooling on heating it yields ferric oxide and sulphur dioxide. The mineral coquimbite is  $\text{Fe}_2(\text{SO}_4)_3 \cdot 9\text{H}_2\text{O}$ . Many basic ferric sulphates are known, some of which occur as minerals; carposiderite is  $\text{Fe}(\text{FeO})_2(\text{SO}_4)_2 \cdot 10\text{H}_2\text{O}$ ; amarantite is  $\text{Fe}(\text{FeO})_2(\text{SO}_4)_2 \cdot 7\text{H}_2\text{O}$ ; utahite is  $3\text{Fe}(\text{FeO})_2(\text{SO}_4)_2 \cdot 4\text{H}_2\text{O}$ ; copiapite is  $\text{Fe}_2(\text{FeO})_2(\text{SO}_4)_2 \cdot 18\text{H}_2\text{O}$ ; castanite is  $\text{Fe}(\text{FeO})_2(\text{SO}_4)_2 \cdot 8\text{H}_2\text{O}$ ; römérite is  $\text{Fe}_2\text{O}_3 \cdot \text{Fe}_2(\text{SO}_4)_3 \cdot 12\text{H}_2\text{O}$ . The iron alums are obtained by crystallizing solutions of equivalent quantities of ferric and an alkaline sulphate. Ferric potassium sulphate, the common iron alum,  $\text{K}_2\text{SO}_4 \cdot \text{Fe}_2(\text{SO}_4)_3 \cdot 24\text{H}_2\text{O}$ , forms bright violet octahedra.

**Nitrates, Nitrites, &c.**—Several nitrates are known. Gunz (Compt. rend., 1902, 135, p. 738) obtained ferrous nitride,  $\text{Fe}_2\text{N}_2$ , and ferric nitride,  $\text{Fe}_3\text{N}$ , as black powders by heating lithium nitride with ferrous potassium chloride and ferric potassium chloride respectively. Fowler (Jour. Chem. Soc., 1901, p. 285) obtained a nitride  $\text{Fe}_3\text{N}$  by acting upon anhydrous ferrous chloride or bromide, finely divided reduced iron, or iron amalgam with ammonia at  $420^\circ$ ; and, also, in a compact form, by the action of ammonia on iron and hot iron wire. It oxidizes on heating in air, and ignites in chlorine; on solution in mineral acids it yields ferrous and ammonium salts, hydrogen being liberated. A nitride appears to be formed when nitrogen is passed over heated iron, since the metal is rendered brittle. Ferrous nitrate,  $\text{Fe}(\text{NO}_3)_2 \cdot 6\text{H}_2\text{O}$ , is a very unstable salt, and is obtained by mixing solutions of ferrous sulphate and barium nitrate, filtering, and crystallizing in a vacuum over sulphuric acid. Ferric nitrate,  $\text{Fe}(\text{NO}_3)_3$ , is obtained by dissolving iron in nitric acid (the cold dilute acid leads to the formation of ferrous and ammonium nitrates) and crystallizing, when cubes of  $\text{Fe}(\text{NO}_3)_3 \cdot 6\text{H}_2\text{O}$  or monoclinic crystals of  $\text{Fe}(\text{NO}_3)_3 \cdot 9\text{H}_2\text{O}$  are obtained. It is used as a mordant.

Ferrous solutions absorb nitric oxide, forming dark green to black solutions. The coloration is due to the production of unstable compounds of the ferrous salt and nitric oxide, and it seems that in neutral solutions the compound is made up of one molecule of salt to one of gas; the reaction, however, is reversible, the composition varying with temperature, concentration and nature of the salt. Ferrous chloride, for example, forms a mononitrosous salt, and two molecules of the gas (Kohlschütter and Kutscheroff, Ber., 1907, 40, p. 873). Ferric chloride also absorbs the gas. Reddish brown amorphous powders of the formulae  $2\text{FeCl}_2 \cdot \text{NO}$  and  $4\text{FeCl}_2 \cdot \text{NO}$  are obtained by passing the gas over anhydrous ferric chloride. By passing the gas into an ethereal solution of the salt, nitrosyl chloride is produced, and on evaporating over sulphuric acid, black needles of  $\text{FeCl}_2 \cdot \text{NO} \cdot 2\text{H}_2\text{O}$  are obtained, which at  $60^\circ$  form the yellow  $\text{FeCl}_2 \cdot \text{NO}$ . Complicated compounds, discovered by Reuss in 1858, are obtained by the interaction of ferrous sulphate and alkaline nitrates and sulphides. Two classes may be distinguished:—(1) the ferrodinitroso salts, e.g.  $\text{K}[\text{Fe}(\text{NO})\text{S}]$ , potassium ferrodinitrososulphide, and (2) the ferroeheptanitroso salts, e.g.  $\text{K}[\text{Fe}(\text{NO})_7\text{S}]$ , potassium ferroeheptanitrososulphide. These salts yield the corresponding acids with sulphuric acid. The dinitroso acid slowly decomposes into sulphuretted hydrogen, nitrogen, nitrous oxide, and the heptanitroso acid. The heptanitroso acid is precipitated as a brown amorphous mass by dilute sulphuric acid, but if the salt be heated with strong acid it yields nitrogen, nitric oxide, sulphur, sulphuretted hydrogen, and ferric ammonium and potassium sulphates.

**Phosphides, Phosphates.**—H. Le Chatelier and S. Wolodine (Compt. rend., 1909, 149, p. 709) have obtained  $\text{Fe}_3\text{P}$ ,  $\text{Fe}_2\text{P}$ ,  $\text{FeP}$ ,  $\text{Fe}_2\text{P}_2$ , but failed to prepare five other phosphides previously described.  $\text{Fe}_3\text{P}$  occurs as crystals in the product of fusing iron with phosphorus; it dissolves in strong hydrochloric acid,  $\text{Fe}_3\text{P}$  forms crystalline needles insoluble in acids except aqua regia; it is obtained by fusing copper phosphide with iron.  $\text{FeP}$  is obtained by passing phosphorus vapour over iron as a red mass.  $\text{Fe}_2\text{P}$  is prepared by the action of phosphorus iodide vapour on reduced iron. Ferrous phosphate,  $\text{Fe}_3(\text{PO}_4)_2 \cdot 8\text{H}_2\text{O}$ , occurs in nature as the mineral vivianite. It may be obtained artificially as a white precipitate, which rapidly turns blue or green on exposure, by mixing solutions of ferrous sulphate and sodium phosphate. It is employed in medicine. Normal ferric phosphate,  $\text{FePO}_4 \cdot 2\text{H}_2\text{O}$ , occurs as the mineral strengite, and is obtained as a yellowish-white precipitate by mixing solutions of ferric chloride and sodium phosphate. It is insoluble in dilute acetic acid but dissolves in mineral acids. The acids  $\text{Fe}_2(\text{PO}_4)_2$  and  $2\text{H}_3\text{Fe}_2(\text{PO}_4)_3 \cdot 3\text{H}_2\text{O}$  have been described. Basic salts have been prepared, and several occur in the mineral kingdom; dufernite is  $\text{Fe}_2(\text{OH})_2\text{PO}_4$ .

**Arsenides, Arsenites, &c.**—Several iron arsenides occur as minerals; lörlingite,  $\text{FeAs}_2$ , forms silvery rhombic prisms; mispickel or arsenical pyrites,  $\text{Fe}_7\text{As}_8$ , is an important commercial source of arsenic. A basic ferric arsenite,  $4\text{Fe}_2\text{O}_3 \cdot \text{As}_2\text{O}_5 \cdot 3\text{H}_2\text{O}$ , is obtained as a flocculent iron precipitate by adding an arsenite to ferric acetate, or by shaking freshly prepared ferric hydrate with a solution of arsenious oxide. The latter reaction is the basis of the application of ferric

hydrate as an antidote in arsenical poisoning. Normal ferric arsenate,  $\text{FeAsO}_4 \cdot 2\text{H}_2\text{O}$ , constitutes the mineral scorodite; pharmacosiderite is the basic arsenate  $2\text{FeAsO}_4 \cdot \text{Fe}(\text{OK})_2 \cdot 5\text{H}_2\text{O}$ . An acid arsenate,  $2\text{Fe}_2(\text{HAsO}_4)_2 \cdot 9\text{H}_2\text{O}$ , is obtained as a white precipitate by mixing solutions of ferric chloride and ordinary sodium phosphate. It readily dissolves in hydrochloric acid.

**Carbonates, Bicarbonates.**—The carbonates of iron play an important part in determining the properties of the different modifications of the commercial metal, and are discussed under IRON AND STEEL.

Ferrous carbonate,  $\text{FeCO}_3$ , or spathic iron ore, may be obtained as microscopic rhombohedra by adding sodium bicarbonate to ferrous sulphate and heating to  $150^\circ$  for 36 hours. Ferrous sulphate and sodium carbonate in the cold give a flocculent precipitate, at first white but rapidly turning green owing to oxidation. A soluble carbonate and a ferric salt give a precipitate which loses carbon dioxide on drying. Of great interest are the carbonyl compounds, ferropentacarbonyl,  $\text{Fe}(\text{CO})_5$ , obtained by L. Mond, Quincke and Langer (Jour. Chem. Soc., 1891; see also *ibid.*, 1910, p. 798) by treating iron from ferrous oxalate with carbon monoxide, and heating at  $150^\circ$ , is a pale yellow liquid which freezes at about  $-20^\circ$ , and boils at  $102.5^\circ$ . Air and moisture decompose it. The halogens give ferrous and ferric haloids and carbon monoxide; hydrochloric and hydrobromic acids have no action, but hydriodic decomposes it. By exposure to sunlight, either alone or dissolved in ether or ligroin, it gives a series of orange plates of diferrocyanonyl,  $\text{Fe}_2(\text{CO})_8$ . If this substance be heated in ethereal solution to  $50^\circ$ , it deposits lustrous dark-green tablets of ferrotetracarbonyl,  $\text{Fe}(\text{CO})_4$ , very stable at ordinary temperatures, but decomposing at  $140^\circ$ – $150^\circ$  into iron and carbon monoxide (J. Dewar and H. O. Jones, *Abst. J.C.S.*, 1907, ii. 266). For the cyanides see PRUSSIC ACID.

Ferrous salts give a greenish precipitate with an alkali, whilst ferric give a characteristic red one. Ferrous salts also give a bluish white precipitate with ferrocyanide, which on exposure turns to a dark blue; ferric salts are characterized by the intense purple coloration with a thiocyanate. (See also CHEMISTRY, § Analytical.) For the quantitative estimation see ASSAYING.

A recent atomic weight determination by Richards and Baxter (*Zeit. anorg. Chem.*, 1900, 23, p. 245; 1904, 38, p. 232), who found the amount of silver bromide given by ferrous bromide, gave the value  $55.44 [O = 16]$ .

#### Pharmacology.

All the official salts and preparations of iron are made directly or indirectly from the metal. The pharmacopoeial forms of iron are as follows:—

1. *Ferrum*, annealed iron wire No. 35 or wrought iron nails free from oxide; from which we have the preparation *Vinum ferri*, iron wine, iron digested in sherry wine for thirty days. (Strength, 1 in 20.)
2. *Ferrum reductum*, reduced iron, a powder containing at least 75% of metallic iron and a variable amount of oxide. A preparation of it is *Trochiscus ferri reducti* (strength, 1 grain of reduced iron in each).
3. *Ferri sulphas*, ferrous sulphate, from which is prepared *Mistura ferri composita*, "Griffiths' mixture," containing ferrous sulphate 25 gr., potassium carbonate 30 gr., myrrh 60 gr., sugar 60 gr., spirit of nutmeg 50 m., rose water 10 fl. oz.
4. *Ferri sulphas exsiccatus*, which has two subpreparations: (a) *Pülula ferri*, "Blaud's pill" (exsiccated ferrous sulphate 150, exsiccated sodium carbonate 95, gum acacia 50, tragacanth 15, glycerin 10, syrup 150, water 20, each to contain about 1 grain of ferrous carbonate); (b) *Pülula aloes et ferri* (Barbadoe aloes 2, exsiccated ferrous sulphate 1, compound powder of cinnamon 3, syrup of glucose 3).
5. *Ferri carbonas saccharatus*, saccharated iron carbonate. The carbonate forms about one-third and is mixed with sugar into a greivish powder.
6. *Ferri arsenas*, iron arsenate, ferrous and ferric arsenates with some iron oxide, a greenish powder.
7. *Ferri phosphas*, a slate-blue powder of ferrous and ferric phosphates with some oxide. Its preparations are: (a) *Syrupus ferri phosphatis* (strength, 1 gr. of ferrous phosphate in each fluid drachm); (b) *Syrupus ferri phosphatis cum quina et strychnina*, "Easton's syrup" (iron wire 75 grs., concentrated phosphoric acid 10 fl. dr., powdered strychnine 5 gr., quinine sulphate 130 gr., syrup 14 fl. oz., water to make 20 fl. oz.), in which each fluid drachm represents 1 gr. of ferrous phosphate,  $\frac{1}{2}$  gr. of quinine sulphate, and  $\frac{1}{2}$  gr. of strychnine.
8. *Syrupus ferri iodidi*, iron wire iodine, water and syrup (strength, 5.5 gr. of ferrous iodide in one fl. dr.).
9. *Liquor ferri perchloridi fortis*, strong solution of ferric chloride (strength, 22.5% of iron); its preparations only are prescribed, viz. *Liquor ferri perchloridi* and *Tinctura ferri perchloridi*.
10. *Liquor ferri persulphatis*, solution of ferric sulphate.
11. *Liquor ferri pernitratu*, solution of ferric nitrate (strength, 3.3% of iron).
12. *Liquor ferri acetatis*, solution of ferric acetate.
13. The scale preparations of iron, so called because they are dried to form scales, are three in number, the base of all being ferric hydrate:

(a) *Ferrum tartaratum*, dark red scales, soluble in water.

(b) *Ferri et quininae citratis*, greenish yellow scales soluble in water.

(c) *Ferri et ammonii citratis*, red scales soluble in water, from which is prepared *Vinum ferri citratis* (ferri et ammonii citratis 1 gr., orange wine 1 fl. dr.).

Substances containing tannic or gallic acid turn black when compounded with ferric salt, so it cannot be used in combination with vegetable astringents, except with the infusion of quassia or columba. Iron may, however, be prescribed in combination with digitalis by the addition of dilute phosphoric acid. Alkalis and their carbonates, lime water, carbonate of calcium, magnesia and its carbonate give green precipitates with ferrous and brown with ferric salts.

Unofficial preparations of iron are numberless, and some of them are very useful. *Ferri hydroxidum* (U.S.P.), the hydrated oxide of iron, made by precipitating ferric sulphate with ammonia, is used solely as an antidote in arsenic poisoning. The *Syrupus ferri phosphatis* Co. is well known as "Parriah's" syrup or chemical food, and the *Pulver ferri phosphatis cum quinina et strychnina*, known as Easton's pills, form a solid equivalent to Easton's syrup.

There are numerous organic preparations of iron. Ferratin is a reddish brown substance which claims to be identical with the iron substance found in pig's liver. Carniferin is another tasteless powder containing iron in combination with the phosphoric acid of muscle preparations, and contains 35% of iron. Ferratogen is prepared from ferric nuclei. Triferin is a paracuculein of iron, and contains 22% of iron and 21% of organically combined phosphorus, prepared from the casein of cow's milk. Haemoglobin is extracted from the blood of an ox and may be administered in bolus form. Dieterich's solution of peptonated iron contains about 2 gr. of iron per oz. Vachetta has used the albuminate of iron with striking success in grave cases of anaemia. Succinate of iron has been prepared by Hausmann. Haematogen, introduced by Hommel, claims to contain the albuminous constituents of the blood serum and all the blood salts as well as pure haemoglobin. Sirco, the name given to dry haematogen, is a tasteless powder. Haemalbumen, introduced by Dahmen, is soluble in warm water.

#### Therapeutics.

Iron is a metal which is used both as a food and as a medicine and has also a definite local action. Externally, it is not absorbed by the unbroken skin, but when applied to the broken skin, sores, ulcers and mucous surfaces, the ferric salts are powerful astringents, because they coagulate the albuminous fibrin of the tissue themselves.

The salts of iron quickly cause coagulation of the blood, and the clot plugs the bleeding vessels. They thus act locally as haemostatics or styptics, and will often arrest severe haemorrhage from parts which are accessible, such as the nose. They were formerly used in the treatment of *post partum* haemorrhage. The perchloride, sulphate and permanganate are strongly astringent; less extensively they are used in chronic discharges from the vagina, rectum and nose, while injected into the rectum they destroy worms.

Internally, a large proportion of the various articles of ordinary diet contains iron. When given medicinally preparations of iron have an astringent taste, and the teeth and tongue are blackened owing to the formation of sulphide of iron. It is therefore advisable to take liquid iron preparations through a glass tube or a quill.

In the stomach all salts of iron, whatever their nature, are converted into ferric chloride. If iron be given in excess, or if the hydrochloric acid in the gastric juice be deficient, iron acts directly as an astringent upon the mucous membrane of the stomach wall. Iron, therefore, may disorder the digestion even in healthy subjects. Acid preparations are more likely to do this, and the acid set free after the formation of the chloride may act as a tritant. Iron, therefore, must not be given to subjects in whom the gastric functions are disturbed, and it should always be given after meals. Preparations which are not acid, or are only slightly acid, such as reduced iron, dialysed iron, the carbonate and scale preparations, do not disturb the digestion. If the sulphate is prescribed in the form of a pill, it may be so coated as only to be soluble in the intestinal digestive fluid. In the intestine the ferric chloride becomes changed into an oxide of iron; the sub-chloride is converted into a ferrous carbonate, which is soluble. Lower iron in the form of these compounds are converted into ferrous sulphide and tannate, and are eliminated with the faeces, turning them black. Iron in the intestine causes an astringent or constipating effect. The astringent salts are therefore useful occasionally to check diarrhoea and dysentery. Thus most salts of iron are distinctly constipating, and are best used in combination with a purgative. The pill of iron and aloes (B.P.) is designed for this purpose. Iron is certainly absorbed from the intestinal canal. As the iron in the food supplies all the iron in the body of a healthy person, there is no doubt that it is absorbed in the organic form. Whether inorganic salts are directly absorbed has been a matter of much discussion; it has, however, been directly proved by the experiments of Kunkel (*Archiv für die gesamte Physiologie des Menschen und der Tiere*, lxi.) and Gaule. The amount of iron existing in the human body is only 38 gr.; therefore, when an excess of iron is absorbed, part is excreted immediately by the bowel and kidneys, and part is stored in the liver and spleen.

Iron being a constituent part of the blood itself, there is a direct indication for the physician to prescribe it when the amount of haemoglobin in the blood is lowered or the red corpuscles are diminished. In certain forms of anaemia the administration of iron rapidly improves the blood in both respects. The exact method in which the prescribed iron acts is still a matter of dispute. Ralph Stockman points out that there are three chief theories as to the action of iron in anaemia. The first is based on the fact that the iron in the haemoglobin of the blood must be derived from the food, therefore iron medicinally administered is absorbed. The second theory is that there is no absorption of iron given by the mouth, but it acts as a local stimulant to the mucous membrane, and so improves anaemia by increasing the digestion of the food. The third theory is that of Bunge, who says that in chlorotic conditions there is an excess of sulphuretted hydrogen in the bowel, changing the food iron into sulphide of iron, which Bunge states cannot be absorbed. He believes that inorganic iron saves the organic iron of the food by combining with the sulphur, and improves anaemia by protecting the organic food iron. Stockman's own experiments are, however, directly opposed to Bunge's view. Wharfinger states that in chlorosis the specific action of iron is only obtained by administering those inorganic preparations which give a reaction with the ordinary reagents; the iron ions in a state of dissociation act as a catalytic agent, destroying the hypothetical toxin which is the cause of chlorosis. Practical experience teaches every clinician that, whatever the mode of action, iron is most valuable in anaemia, though in many cases where there is well-marked osmotic absorption from the intestinal products, not only laxatives in combination with iron but intestinal antiseptics are necessary. That form of neuralgia which is associated with anaemia usually yields to iron.

**IRON AGE**, the third of the three periods, Stone, Bronze and Iron Ages, into which archaeologists divide prehistoric time; the weapons, utensils and implements being as a general rule made of iron (see **ARCHAEOLOGY**). The term has no real chronological value, for there has been no universal synchronous sequence of the three epochs in all quarters of the world. Some countries, such as the islands of the South Pacific, the interior of Africa, and parts of North and South America, have passed direct from the Stone to the Iron Age. In Europe the Iron Age may be said to cover the last years of the prehistoric and the early years of the historic periods. In Egypt, Chaldaea, Assyria, China, it reaches far back, to perhaps 4000 years before the Christian era. In Africa, where there has been no Bronze Age, the use of iron succeeded immediately the use of stone. In the Black Pyramid of Abusir (VIth Dynasty), at least 3000 B.C., Gaston Maspero found some pieces of iron, and in the funeral text of Pepi I. (about 3400 B.C.) the metal is mentioned. The use of iron in northern Europe would seem to have been fairly general long before the invasion of Caesar. But iron was not in common use in Denmark until the end of the 1st century A.D. In the north of Russia and Siberia its introduction was even as late as A.D. 800, while Ireland enters upon her Iron Age about the beginning of the 1st century. In Gaul, on the other hand, the Iron Age dates back some 800 years B.C.; while in Etruria the metal was known some six centuries earlier. Homer represents Greece as beginning her Iron Age twelve hundred years before our era. The knowledge of iron spread from the south to the north of Europe. In approaching the East from the north of Siberia or from the south of Greece and the Troad, the history of iron in each country eastward is relatively later; while a review of European countries from the north towards the south shows the latter becoming acquainted with the metal earlier than the former. It is suggested that these facts support the theory that it is from Africa that iron first came into use. The finding of worked iron in the Great Pyramids seems to corroborate this view. The metal, however, is singularly scarce in collections of Egyptian antiquities. The explanation of this would seem to lie in the fact that the relics are in most cases the paraphernalia of tombs, the funeral vessels and vases, and iron being considered an impure metal by the ancient Egyptians it was never used in their manufacture of these or for any religious purposes. This idea of impurity would seem a further proof of the African origin of iron. It was attributed to Seth, the spirit of evil who according to Egyptian tradition governed the central deserts of Africa. The Iron Age in Europe is characterized by an elaboration of designs in weapons, implements and utensils. These are no longer cast but hammered into shape, and decoration is elaborate curvilinear rather than simple

rectilinear, the forms and character of the ornamentation of the northern European weapons resembling in some respects Roman arms, while in others they are peculiar and evidently representative of northern art. The dead were buried in an extended position, while in the preceding Bronze Age cremation had been the rule.

See Lord Avebury, *Prehistoric Times* (1865; 1900); Sir J. Evans, *Ancient Stone Implements* (1897); *Horae Ferales, or Studies in the Archaeology of Northern Nations*, by Kemble (1863); Gaston C. C. Maspero, *Guide du Musée de Boulogne*, 296; *Scotland in Pagan Times—The Iron Age*, by Joseph Anderson (1883).

**IRON AND STEEL.** 1. Iron, the most abundant and the cheapest of the heavy metals, the strongest and most magnetic of known substances, is perhaps also the most indispensable of all save the air we breathe and the water we drink. For one kind of meat we could substitute another; wool could be replaced by cotton, silk or fur; were our common silicate glass gone, we could probably perfect and cheapen some other of the transparent solids; but even if the earth could be made to yield any substitute for the forty or fifty million tons of iron which we use each year for rails, wire, machinery, and structural purposes of many kinds, we could not replace either the steel of our cutting tools or the iron of our magnets, the basis of all commercial electricity. This usefulness iron owes in part, indeed, to its abundance, through which it has led us in the last few thousands of years to adapt our ways to it; but still in chief part first to the single qualities in which it

very weak; conducting heat and electricity easily, and again offering great resistance to their passage; here welding readily, there incapable of welding; here very infusible, there melting with relative ease. The coincidence that so indispensable a thing should also be so abundant, that an iron-needing man should be set on an iron-cored globe, certainly suggests design. The indispensableness of such abundant things as air, water and light is readily explained by saying that their very abundance has evolved a creature dependent on them. But the indispensable qualities of iron did not shape man's evolution, because its great usefulness did not arise until historic times, or even, as in case of magnetism, until modern times.

These variations in the properties of iron are brought about in part by corresponding variations in mechanical and thermal treatment, by which it is influenced profoundly, and in part by variations in the proportions of certain foreign elements which it contains; for, unlike most of the other metals, it is never used in the pure state. Indeed pure iron is a rare curiosity. Foremost among these elements is carbon, which iron inevitably absorbs from the fuel used in extracting it from its ores. So strong is the effect of carbon that the use to which the metal is put, and indeed its division into its two great classes, the malleable one, comprising steel and wrought iron, with less than 2.20% of carbon, and the unmalleable one, cast iron, with more than this quantity, are based on carbon-content. (See Table I.)

TABLE I.—General Classification of Iron and Steel according (1) to Carbon-Content and (2) to Presence or Absence of Inclosed Slag.

	Containing very little Carbon (say, less than 0.30%).	Containing an Intermediate Quantity of Carbon (say, between 0.30 and 2.2%).	Containing much Carbon (say, from 2.2 to 5%).
Slag-bearing or "Weld-metal" Series.	<b>WROUGHT IRON.</b> Puddled and bloomary, or Charcoal-hearth iron belong here.	<b>WELD STEEL.</b> Puddled and blister steel belong here.	
Slagless or "Ingot-Metal" Series.	<b>LOW-CARBON or MILD STEEL,</b> sometimes called "ingot-iron." It may be either Bessemer, open-hearth, or crucible steel.	<b>HALF-HARD and HIGH-CARBON STEELS,</b> sometimes called "ingot-steel." They may be either Bessemer, open-hearth, or crucible steel. Malleable cast iron also often belongs here.	<b>CAST IRON.</b> Normal cast iron, "washed" metal, and most "malleable cast iron" belong here.
		<b>ALLOY STEELS.</b> Nickel, manganese, tungsten, and chrome steels belong here.	<b>ALLOY CAST IRONS.*</b> Spiegeleisen, ferro-manganese, and silico-spiegel belong here.

\* The term "Alloy Cast Irons" is not actually in frequent use, not because of any question as to its fitness or meaning, but because the need of such a generic term rarely arises in the industry.

excels, such as its strength, its magnetism, and the property which it alone has of being made at will extremely hard by sudden cooling and soft and extremely pliable by slow cooling; second, to the special combinations of useful properties in which it excels, such as its strength with its ready welding and shaping both hot and cold; and third, to the great variety of its properties. It is a very Proteus. It is extremely hard in our files and razors, and extremely soft in our horse-shoe nails, which in some countries the smith rejects unless he can bend them on his forehead; with iron we cut and shape iron. It is extremely magnetic and almost non-magnetic; as brittle as glass and almost as pliable and ductile as copper; extremely springy, and springless and dead; wonderfully strong, and

1 The word "iron" was in O. Eng. *iren, isern or isen*, cf. Ger. *Eisen*, Dut. *ysen*, Swed. *jarn*, Dan. *jern*; the original Teut. base is *isarn*, and cognates are found in Celtic, Ir. *iaran*, Gael. *iarrunn*, Breton, *houarn*, &c. The ulterior derivation is unknown; connexion has been suggested without much probability with *is*, i.e. from its hard bright surface, or with Lat. *ars, aeris*, brass. The change from *isen* to *iron* (in 16th cent. *iron*) is due to rhotacism, but whether direct from *isen* or through *isarn, isern* is doubtful. "Steel" represents the O. Eng. *stiel or stela* (the true iron; only found, however, with spelling *stle*, cf. *stle-arg*, steel-edged), cognate with Ger. *Stahl*, Dut. and Dan. *stål*, &c.; the word is not found outside Teutonic. Skeat (*Etym. Dict.*, 1898) finds the ultimate origin in the Indo-European base *stok-*, to be firm or still, and compares Lat. *stagnum*, standing-water.

2. *Nomenclature.*—Until about 1860 there were only three important classes of iron—wrought iron, steel and cast iron. The essential characteristic of wrought iron was its nearly complete freedom from carbon; that of steel was its moderate carbon-content (say between 0.30 and 2.2%), which, though great enough to confer the property of being rendered intensely hard and brittle by sudden cooling, yet was not so great but that the metal was malleable when cooled slowly; while that of cast iron was that it contained so much carbon as to be very brittle whether cooled quickly or slowly. This classification was based on carbon-content, or on the properties which it gave. Beyond this, wrought iron, and certain classes of steel which then were important, necessarily contained much slag or "cinder," because they were made by welding together pasty particles of metal in a bath of slag, without subsequent fusion. But the best class of steel, crucible steel, was freed from slag by fusion in crucibles; hence its name, "cast steel." Between 1860 and 1870 the invention of the Bessemer and open-hearth processes introduced a new class of iron to-day called "mild" or "low-carbon steel," which lacked the essential property of steel, the hardening power, yet differed from the existing forms of wrought iron in freedom from slag, and from cast iron in being very malleable. Logically it was wrought iron, the essence of which was that it was (1) "iron" as distinguished from steel, and

(2) malleable, *i.e.* capable of being "wrought." This name did not please those interested in the new product, because existing wrought iron was a low-priced material. Instead of inventing a wholly new name for the wholly new product, they appropriated the name "steel," because this was associated in the public mind with superiority. This they did with the excuse that the new product resembled one class of steel—cast steel—in being free from slag; and, after a period of protest, all acquiesced in calling it "steel," which is now its firmly established name. The old varieties of wrought iron, steel and cast iron preserve their old names; the new class is called steel by main force. As a result, certain varieties, such as blister steel, are called "steel" solely because they have the hardening power, and others, such as low-carbon steel, solely because they are free from slag. But the former lack the essential quality, slaglessness, which makes the latter steel, and the latter lack the essential quality, the hardening power, which makes the former steel. "Steel" has come gradually to stand rather for excellence than for any specific quality. These anomalies, however confusing to the general reader, in fact cause no appreciable trouble to important makers or users of iron and steel, beyond forming an occasional side-issue in litigation.

3. *Definitions.*—Wrought iron is slag-bearing malleable iron, containing so little carbon (0.30% or less), or its equivalent, that it does not harden greatly when cooled suddenly.

Steel is iron which is malleable at least in some one range of temperature, and also is either (a) cast into an initially malleable mass, or (b) is capable of hardening greatly by sudden cooling, or (c) is both so cast and so capable of hardening. (Tungsten steel and certain classes of manganese steel are malleable only when red-hot.) Normal or carbon steel contains between 0.30 and 2.20% of carbon, enough to make it harden greatly when cooled suddenly, but not enough to prevent it from being usefully malleable when hot.

Cast iron is, generally, iron containing so much carbon (2.20% or more) or its equivalent that it is not usefully malleable at any temperature. Specifically, it is cast iron in the form of castings other than pigs, or remelted cast iron suitable for such castings, as distinguished from pig iron, *i.e.* the molten cast iron as it issues from the blast furnace, or the pigs into which it is cast.

Malleable cast iron is iron which has been cast in the condition of cast iron, and made malleable by subsequent treatment without fusion.

Alloy steels and cast irons are those which owe their properties chiefly to the presence of one or more elements other than carbon.

Ingot iron is slagless steel with less than 0.30% of carbon.

Ingot steel is slagless steel containing more than 0.30% of carbon.

Weld steel is slag-bearing iron malleable at least at some one temperature, and containing more than 0.30% of carbon.

4. *Historical Sketch.*—The iron oxide of which the ores of iron consist would be so easily deoxidized and thus brought to the metallic state by the carbon, *i.e.* by the glowing coals of any primeval savage's wood fire, and the resulting metallic iron would then differ so strikingly from any object which he had previously seen, that its very early use by our race is only natural. The first observing savage who noticed it among his ashes might easily infer that it resulted from the action of burning wood on certain extremely heavy stones. He could pound it out into many useful shapes. The natural steps first of making it intentionally by putting such stones into his fire, and next of improving his fire by putting it and these stones into a cavity on the weather side of some bank with an opening towards the prevalent wind, would give a simple forge, differing only in size, in lacking forced blast, and in details of construction, from the Catalan forges and bloomeries of to-day. Moreover, the coals which deoxidized the iron would inevitably carburize some lumps of it, here so far as to turn it into the brittle and relatively useless cast iron, there only far enough to convert it into steel, strong and very useful even in its unhardened state. Thus it is almost certain that much of the earliest iron was in fact steel. How soon after

man's discovery, that he could beat iron and steel out while cold into useful shapes, he learned to forge it while hot is hard to conjecture. The pretty elaborate appliances, tongs or their equivalent, which would be needed to enable him to hold it conveniently while hot, could hardly have been devised till a very much later period; but then he may have been content to forge it inconveniently, because the great ease with which it mashes out when hot, perhaps pushed with a stout stick from the fire to a neighbouring flat stone, would compensate for much inconvenience. However this may be, very soon after man began to practise hot-forging he would inevitably learn that sudden cooling, by quenching in water, made a large proportion of his metal, his steel, extremely hard and brittle, because he would certainly try by this very quenching to avoid the inconvenience of having the hot metal about. But the invaluable and rather delicate art of tempering the hardened steel by a very careful and gentle reheating, which removes its extreme brittleness though leaving most of its precious hardness, needs such skilful handling that it can hardly have become known until very long after the art of hot-forging.

The oxide ores of copper would be deoxidized by the savage's wood fire even more easily than those of iron, and the resulting copper would be recognized more easily than iron, because it would be likely to melt and run together into a mass conspicuous by its bright colour and its very great malleableness. From this we may infer that copper and iron probably came into use at about the same stage in man's development, copper before iron in regions which had oxidized copper ores, whether they also had iron ores or not, iron before copper in places where there were pure and easily reduced ores of iron but none of copper. Moreover, the use of each metal must have originated in many different places independently. Even to-day isolated peoples are found with their own primitive iron-making, but ignorant of the use of copper.

If iron thus preceded copper in many places, still more must it have preceded bronze, an alloy of copper and tin much less likely than either iron or copper to be made unintentionally. Indeed, though iron ores abound in many places which have neither copper nor tin, yet there are but few places which have both copper and tin. It is not improbable that, once bronze became known, it might replace iron in a measure, perhaps even in a very large measure, because it is so fusible that it can be cast directly and easily into many useful shapes. It seems to be much more prominent than iron in the Homeric poems; but they tell us only of one region at one age. Even if a nation here or there should give up the use of iron completely, that all should is neither probable nor shown by the evidence. The absence of iron and the abundance of bronze in the relics of a prehistoric people is a piece of evidence to be accepted with caution, because the great defect of iron, its proneness to rust, would often lead to its complete disappearance, or conversion into an unrecognizable mass, even though tools of bronze originally laid down beside it might remain but little corroded. That the ancients should have discovered an art of hardening bronze is grossly improbable, first because it is not to be hardened by any simple process like the hardening of steel, and second because, if they had, then a large proportion of the ancient bronze tools now known ought to be hard, which is not the case.

Because iron would be so easily made by prehistoric and even by primeval man, and would be so useful to him, we are hardly surprised to read in Genesis that Tubal Cain, the sixth in descent from Adam, discovered it; that the Assyrians had knives and saws which, to be effective, must have been of hardened steel, *i.e.* of iron which had absorbed some carbon from the coals with which it had been made, and had been quenched in water from a red heat; that an iron tool has been found embedded in the ancient pyramid of Kephron (probably as early as 3500 B.C.); that iron metallurgy had advanced at the time of Thothmesis (Thothmes) III. (about 1500 B.C.) so far that bellows were used for forcing the forge fire; that in Homer's time (not later than the 9th century B.C.) the delicate art of hardening and tempering steel was so familiar that the poet used it for a simile, likening

the hissing of the stake which Ulysses drove into the eye of Polyphemus to that of the steel which the smith quenches in water, and closing with a reference to the strengthening effect of this quenching; and that at the time of Pliny (A.D. 23-79) the relative value of different baths for hardening was known, and oil preferred for hardening small tools. These instances of the very early use of this metal, intrinsically at once so useful and so likely to disappear by rusting away, tell a story like that of the single foot-print of the savage which the waves left for Robinson Crusoe's warning. Homer's familiarity with the art of tempering could come only after centuries of the wide use of iron.

5. *Three Periods.*—The history of iron may for convenience be divided into three periods: a first in which only the direct extraction of wrought iron from the ore was practised; a second which added to this primitive art the extraction of iron in the form of carburized or cast iron, to be used either as such or for conversion into wrought iron; and a third in which the iron worker used a temperature high enough to melt wrought iron, which he then called molten steel. For brevity we may call these the periods of wrought iron, of cast iron, and of molten steel, recognizing that in the second and third the earlier processes continued in use. The first period began in extremely remote prehistoric times; the second in the 14th century; and the third with the invention of the Bessemer process in 1856.

6. *First Period.*—We can picture to ourselves how in the first period the savage smith, step by step, bettered his control over his fire, at once his source of heat and his deoxidizing agent. Not content to let it burn by natural draught, he would blow it with his own breath, would expose it to the prevalent wind, would urge it with a fan, and would devise the first crude valveless bellows, perhaps the pigskin already familiar as a water-bottle, of which the psalmist says: "I will become as a bottle in the smoke." To drive the air out of this skin by pressing on it, or even by walking on it, would be easy; to fill it again with air by pulling its sides apart with his fingers would be so irksome that he would soon learn to distend it by means of strings. If his bellows had only a single opening, that through which they delivered the blast upon the fire, then in inflating them he would draw back into them the hot air and ashes from the fire. To prevent this he might make a second or suction hole, and thus he would have a veritable engine, perhaps one of the very earliest of all. While inflating the bellows he would leave the suction port open and close the discharge port with a pinch of his finger; and while blowing the air against the fire he would leave the discharge port open and pinch together the sides of the suction port.

The next important step seems to have been taken in the 4th century when some forgotten Watt devised valves for the bellows. But in spite of the activity of the iron manufacture in many of the Roman provinces, especially England, France, Spain, Carinthia and near the Rhine, the little forges in which iron was extracted from the ore remained, until the 14th century, very crude and wasteful of labour, fuel, and iron itself: indeed probably not very different from those of a thousand years before. When iron was worked, the local smith, the *Waldschmied*, converted it with the charcoal of the surrounding forest into the wrought iron which he found up. Many farmers had their own little forges or smithies to supply the iron for their tools.

The fuel, wood or charcoal, which served both to heat and to deoxidize the ore, has so strong a carburizing action that it would turn some of the resultant metal into "natural steel," which differs from wrought iron only in containing so much carbon that it is relatively hard and brittle in its natural state, and that it becomes intensely hard when quenched from a red heat in water. Moreover, this same carburizing action of the fuel would at times go so far as to turn part of the metal into a true cast iron, so brittle that it could not be worked at all. In time the smith learnt how to convert this unwelcome product into wrought iron by remelting it in the forge, exposing it to the blast in such a way as to burn out most of its carbon.

7. *Second Period.*—With the second period began, in the 14th century, the gradual displacement of the direct extraction of wrought iron from the ore by the intentional and regular use of this indirect method of first carburizing the metal and then turning it into cast iron, and then converting it into wrought iron by remelting it in the forge. This displacement has been going on ever since, and it is not quite complete even to-day. It is of the familiar type of the replacing of the simple but wasteful by the complex and economical, and it was begun unintentionally in the attempt to save fuel and labour, by increasing the size and especially the height of the forge, and by driving the bellows by means of water-power. Indeed it was the use of water-power that gave the smith pressure strong enough to force his blast up through a longer column of ore and fuel, and thus enabled him to increase the height of his forge, enlarge the scale of his operations, and in turn save fuel and labour. And it was the lengthen-

ing of the forge, and the length and intimacy of contact between ore and fuel to which it led, that carburized the metal and turned it into cast iron. This is so fusible that it melted, and, running together into a single molten mass, freed itself mechanically from the "gangue," as the foreign minerals with which the ore is mixed are called. Finally, the improvement in the quality of the iron which resulted from this completely freeing it from the gangue turned out to be a great and unexpected merit of the indirect process, probably the merit which enabled it, in spite of its complexity, to drive out the direct process. Thus we have here one of these cases common in the evolution both of nature and of art, in which a change, made for a specific purpose, has a wholly unforeseen advantage in another direction, so important as to outweigh that for which it was made and to determine the path of future development.

With this method of making molten cast iron in the hands of a people already familiar with bronze founding, iron founding, i.e. the casting of the molten cast iron into shapes which were useful in spite of its brittleness, naturally followed. Thus ornamental iron castings were made in Sussex in the 14th century, and in the 16th cannons weighing three tons each were cast.

The indirect process once established, the gradual increase in the height and diameter of the high furnace, which has lasted till our own days, naturally went on and developed the gigantic blast furnaces of the present time, still called "high furnaces" in French and German. The impetus which the indirect process and the acceleration of civilization in the 15th and 16th centuries gave to the iron industry was so great that the demands of the iron masters for fuel made serious roads on the forests, and in 1558 an act of Queen Elizabeth forbade the cutting of timber in certain parts of the country for iron-making. Another in 1584 forbade the building of any more iron-works in Surrey, Kent, and Sussex. This increasing scarcity of wood was probably one of the chief causes of the attempts which the iron masters then made to replace charcoal with mineral fuel. In 1611 Simon Sturtevant patented the use of mineral coal for iron-smelting, and in 1619 Dud Dudley made with this coal both cast and wrought iron with technical success, but through the opposition of the charcoal iron-makers all of his many attempts were defeated. In 1625 Stradella's attempts in Hainaut had no better success, and still more than a century later that iron-smelting with mineral fuel was at last fully successful. It was then in 1735, that Abraham Darby showed how to make cast iron with coke in the high furnace, which by this time had become a veritable blast furnace.

The next great improvement in blast-furnace practice came in 1811, when Aubertot in France used for heating steel the furnace gases rich in carbonic oxide which till then had been allowed to burn uselessly at the top of the blast furnace. The next was J. B. Neilson's invention in 1828 of heating the blast, which increased the production of iron from the furnace consumption of fuel and iron waste fully. Very soon after this, in 1831, the work of heating the blast was done by means of the waste gases, at Wasseralfingen in Bavaria.

Meanwhile Henry Cort had in 1784 very greatly simplified the conversion of cast iron into wrought iron. In place of the old forge, in which the actual contact between the iron and the fuel, itself an energetic carburizing agent, made decarburization difficult, he devised the reverberatory puddling furnace (see fig. 14 below), in which the iron lies in a chamber apart from the fire-place, and is thus protected from the carburizing action of the fuel, though heated by the flames which it gives out.

The rapid advance in mechanical engineering in the latter part of this second period stimulated the iron industry greatly, giving it in 1728 Payn and Hanbury's rolling mill for rolling sheet iron, in 1760 John Smeaton's cylindrical cast-iron bellows in place of the wooden and leather ones previously used, in 1783 Cort's grooved rolls for rolling bars and rods of iron, and in 1838 James Nasmyth's steam hammer. But even more important than these were the advent of the steam engine between 1760 and 1770, and of the railroad in 1825, each of which gave the iron industry a great impetus. Both created a great demand for iron, not only for themselves but for the industries which they in turn stimulated; and both directly aided the iron master: the steam engine by giving him powerful and convenient tools; and the railroad by assembling his materials and distributing his products.

About 1740 Benjamin Huntsman introduced the "crucible process" of melting steel in small crucibles, and thus freeing it from the slag, or rich iron silicate, with which it, like wrought iron, was mechanically mixed, whether it was made in the old forge or in the puddling furnace. This removal of the cinder very greatly improved the steel; but the process was and is so costly that it is used only for making the tools for other purposes which need the very best quality.

8. *Third Period.*—The third period has for its great distinction the invention of the Bessemer and open-hearth processes, which are like Huntsman's crucible process in that their essence is their freeing wrought iron and low carbon steel from mechanically entangled cinder, by developing the hitherto unattainable temperature, rising to above 1500° C., needed for melting these relatively infusible products. These processes are incalculably more important than Huntsman's, both because they are incomparably cheaper, and because their products are far more useful than his.

Thus the distinctive work of the second and third periods is freeing

the metal from mechanical impurities by fusion. The second period, by converting the metal into the fusible cast iron and melting this, for the first time removed the gangue of the ore; the third period by giving a temperature high enough to melt the most infusible forms of iron, liberated the slag formed in deriving them from cast iron.

In 1856 Bessemer not only invented his extraordinary process of making the heat developed by the rapid oxidation of the impurities in pig iron raise the temperature above the exalted melting-point of the resultant purified steel, but also made it widely known that this steel was a very valuable substance. Knowing this, and having in the Siemens regenerative gas furnace an independent means of generating this temperature, the Martin brothers of Sireuil in France in 1864 developed the open-hearth process of making steel of any desired carbon-content by melting together in this furnace cast and wrought iron. The great defect of both these processes, that they could not remove the baneful phosphorus with which all the ores of iron are associated, was remedied in 1878 by S. G. Thomas, who showed that, in the presence of a slag rich in lime, the whole of the phosphorus could be removed readily.

After the remarkable development of the blast furnace, the Bessemer, and the open-hearth processes, the most important work of this, the third period of the history of iron, is the birth and growth of the science and art of iron metallurgy. In 1868 Tschernoff enunciated its chief fundamental laws, which were supplemented in 1885 by the laws of Brinell. In 1888 F. Osmond showed that the wonderful changes which thermal treatment and the presence of certain foreign elements cause were due to allotropy, and from these and like teachings have come a rapid growth of the use of the so-called "alloy steels" in which, thanks to special composition and treatment, the iron exists in one or more of its remarkable allotropic states. These include the austenitic or gamma non-magnetic manganese steel, already patented by Robert Hadfield in 1883, the first important known substance which combined great malleableness with great hardness, and the martensitic or beta "high speed tool steel" of White and Taylor, which retains its hardness and cutting power even at a red heat.

10. *Constitution of Iron and Steel.*—The constitution of the various classes of iron and steel as shown by the microscope explains readily the great influence of carbon which was outlined in §§ 2 and 3. The metal in its usual slowly cooled state is a conglomerate like the granitic rocks. Just as a granite is a conglomerate or mechanical mixture of distinct crystalline grains of three perfectly definite minerals, mica, quartz, and feldspar, so iron and steel in their usual slowly cooled state consist of a mixture of microscopic particles of such definite quasi-minerals, diametrically unlike. These are cementite, a definite iron carbide,  $Fe_3C$ , harder than glass and nearly as brittle, but probably very strong under gradually and axially applied stress; and ferrite, pure or nearly pure metallic  $\alpha$ -iron, soft, weak, with high electric conductivity, and in general like copper except in colour. In view of the fact that the presence of 1% of carbon implies that 15% of the soft ductile ferrite is replaced by the glass-hard cementite, it is not surprising that even a little carbon influences the properties of the metal so profoundly.

But carbon affects the properties of iron not only by giving rise to varying proportions of cementite, but also both by itself shifting from one molecular state to another, and by enabling us to hold the iron itself in its unmagnetic allotropic forms,  $\beta$ - and  $\gamma$ -iron, as will be explained below. Thus, sudden cooling from a red heat leaves the carbon not in definite combination as cementite, but actually dissolved in  $\beta$ - and  $\gamma$ -allotropic iron, in the conditions known as martensite and austenite, not granitic but glass-like bodies, of which the "hardened" and "tempered" steel of our cutting tools in large part consists. Again, if more than 2% of carbon is present, it passes readily into the state of pure graphitic carbon, which, in itself soft and weak, weakens and embrittles the metal as any foreign body would, by breaking up its continuity.

11. *The Roberts-Austen or carbon-iron diagram* (fig. 1), in which vertical distances represent temperatures and horizontal ones the percentage of carbon in the iron, aids our study of these constituents of iron. If, ignoring temporarily and for simplicity the fact that part of the carbon may exist in the state of graphite, we consider the behaviour of iron in cooling from the molten state, AB and BC give the temperature at which, for any given percentage of carbon, solidification begins, and Aa, aB, and Bc that at which it ends. But after solidification is complete and the metal has cooled to a much lower range of temperature,

usually between  $900^\circ$  and  $600^\circ$  C., it undergoes a very remarkable series of transformations. GHSa gives the temperature at which, for any given percentage of carbon, these transformations begin, and PS' that at which they end.

These freezing-point curves and transformation curves thus divide the diagram into 8 distinct regions, each with its own specific state or constitution of the metal, the molten state for region 1, a mixture of molten metal and of solid austenite for region 2, austenite alone for region 4 and so on. This will be explained below. If the metal followed the laws of equilibrium, then whenever through change of temperature it entered a new region, it would forthwith adopt the constitution normal to that region. But in fact the change of constitution often lags greatly, so that the metal may have the constitution normal to a region higher than that in which it is, or even a patchwork constitution, representing fragments of those of two or more regions. It is

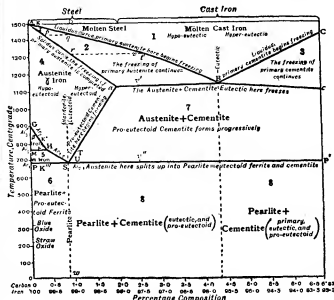

FIG. 1.—Roberts-Austen or Carbon-Iron diagram. The Cementite-Austenite or Metastable form.

by taking advantage of this lagging that thermal treatment causes such wonderful changes in the properties of the cold metal.

12. With these facts in mind we may now study further these different constituents of iron.

*Austenite, gamma ( $\gamma$ ) iron.*—Austenite is the name of the solid solution of an iron carbide in allotropic  $\gamma$ -iron of which the metal normally consists when in region 4. In these solid solutions, as in aqueous ones, the ratios in which the different chemical substances are present are not fixed or definite, but vary from case to case, not *per saltum* as between definite chemical compounds, but by infinitesimal steps. The different substances are as it were dissolved in each other in a state which has the indefiniteness of composition, the absolute merging of identity, and the weakness of reciprocal chemical attraction, characteristic of aqueous solutions.

On cooling into region 6 or 8 austenite should normally split up into ferrite and cementite, after passing through the successive stages of martensite, troostite and sorbite,  $Fe_3C = Fe_3C + Fe(\alpha)$ . But this change may be prevented so as to preserve the austenite in the cold, either very incompletely, as when high-carbon steel is "hardened," i.e. is cooled suddenly by quenching in water, in which case the carbon present seems to act as a brake to retard the change; or completely, by the presence of a large quantity of manganese, nickel, tungsten or molybdenum, which in effect sink the lower boundary GHSa of region 4 to below the atmospheric temperature. The important manganese steels of commerce and certain nickel steels are manganiferous and nictoliferous austenite, unmagnetic and hard but ductile. Austenite may contain carbon in any proportion up to about 2.2%. It is non-magnetic, and, when preserved in the cold either by quenching or by the presence of manganese, nickel, &c., it has a very remarkable combination of great malleability with very marked hardness, though it is less hard than common carbon steel when hardened, and probably less hard than martensite. When of eutectoid composition, it is called "hardening." Suddenly cooled carbon steel,

even if rich in austenite, is strongly magnetic because of the very magnetic  $\alpha$ -iron which inevitably forms even in the most rapid cooling from region 4. Only in the presence of much manganese, nickel, or their equivalent can the true austenite be preserved in the cold so completely that the steel remains non-magnetic.

13. *Beta* ( $\beta$ ) *iron*, an unmagentic, intensely hard and brittle allotropic form of iron, though normal and stable only in the little triangle GHM, is yet a state through which the metal seems always to pass when the austenite of region 4 changes into the ferrite and cementite of regions 6 and 8. Though not normal below MHSP', yet like  $\gamma$ -iron it can be preserved in the cold by the presence of about 5% of manganese, which, though not enough to bring the lower boundary of region 4 below the atmospheric temperature and thus to preserve austenite in the cold, is yet enough to make the transformation of  $\beta$  into  $\alpha$  iron so sluggish that the former remains untransformed even during slow cooling.

Again,  $\beta$ -iron may be preserved completely as in the "hardening of steel," which consists in heating the steel into the austenite state of region 4, and then cooling it so rapidly, e.g. by quenching it in cold water, that, for lack of the time needed for the completion of the change from austenite into ferrite and cementite, much of the iron is caught in transit in the  $\beta$  state. According to our present theory, it is chiefly to beta iron, preserved in one of these ways, that all of our tool steel proper, i.e. steels used for cutting as distinguished from grinding, owe their hardness.

14. *Martensite*, *Troostite* and *Sorbite* are the successive stages through which the metal passes in changing from austenite into ferrite and cementite. *Martensite*, very hard because of its large content of  $\beta$ -iron, is characteristic of hardened steel, but the two others, far from being definite substances, are probably only roughly bounded stages of this transition. *Troostite* and *sorbite*, indeed, seem to be chiefly very finely divided mixtures of ferrite and cementite, and it is probably because of this fineness that sorbite steel has its remarkable combination of strength and elasticity with ductility which fits it for resisting severe vibratory and other dynamic stresses, such as those with which rails and shafting are exposed.

15. *Alpha* ( $\alpha$ ) *iron* is the form normal and stable for regions 5, 6 and 8, i.e. for all temperatures below MHSP'. It is the common, very magnetic form of iron, in itself ductile but relatively soft and weak, as we know it in wrought iron and mild or low-carbon steel.

16. *Ferrite* and *cementite*, already described in § 10, are the final products of the transformation of austenite in slow-cooling.  $\beta$ -ferrite and austenite are the normal constituents for the triangle GHM,  $\alpha$ -ferrite (i.e. nearly pure  $\alpha$ -iron) with austenite for the space MHSP, cementite with austenite for region 7, and  $\alpha$ -ferrite and cementite jointly for regions 6 and 8. Ferrite and cementite are thus the normal and usual constituents of slowly cooled steel, including all structural steels, rail steel, &c., and of white cast iron (see § 18).

17. *Pearlite*.—The ferrite and cementite present interstratified habitually as a "eutectoid" called "pearlite" (see ALLOYS, PL. fig. 11), in the ratio of about 8 parts of ferrite to 1 of cementite, and hence containing about 0.90% of carbon. Slowly cooled steel containing just 0.90% of carbon (S in fig. 1) consists of pearlite alone. Steel and white cast iron with more than this quantity of carbon consist typically of kernels of pearlite surrounded by envelopes of free cementite (see ALLOYS, PL. fig. 13) sufficient in quantity to represent their excess of carbon over the eutectoid ratio; they are called "hyper-eutectoid," and are represented by region 8 of fig. 1. Steel containing less than this quantity of carbon consists typically of kernels of pearlite surrounded by envelopes of ferrite (see ALLOYS, PL. fig. 1) sufficient in quantity to represent their "excess of iron over this eutectoid ratio; is called "hypo-eutectoid"; and is represented by region 6 of fig. 1. This typical "envelope and kernel" structure is often only rudimentary.

A "eutectic" is the last-freezing part of an alloy, and corresponds to what the mother-liquor of a saline solution would become if such a solution, after the excess of saline matter had been crystallized out, were finally completely frozen. It is the mother-liquor or "bittern" frozen. Its striking characteristics are: (1) that for given metals alloyed together its composition is fixed, and does not vary with the proportions in which those metals are present, because any "excess metal," i.e. so much of either metal as is present in excess over the eutectic ratio, remains in the solid parts of the alloy; (2) that thus constant, its composition is not in simple atomic proportions; (3) that it freezing-point is constant; and (4) that, when first formed, it habitually consists of interstratified plates of the metals which compose it. If the alloy has a composition very near that of its own eutectic, then when solidified it of course contains a large proportion of the eutectic, and only a small proportion of the excess metal. If it differs widely from the eutectic in composition, then when solidified it consists of only a small quantity of eutectic and a very large quantity of the excess metal. But far below the freezing-point, transformations may take place in the solid metal, and follow a course quite parallel with that of freezing, though with no suggestion of liquidity. A "eutectoid" is to such a transformation in solid metal what a eutectic is to freezing proper. It is the last part of the metal to undergo this transformation and, when thus transformed, it is of constant though not atomic composition, and habitually consists of inter-stratified plates of its component metals.

The percentage of pearlite and of free ferrite or cementite in these products is shown in fig. 2, in which the ordinates of the line ABC represent the percentage of pearlite corresponding to each percentage of carbon, and the intercept ED, MN or KF, of any point H, P or L,

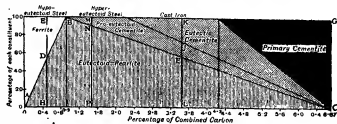

FIG. 2.—Relation between the carbon-content and the percentage of the several constituents of slowly cooled steel and white cast iron.

measures the percentage of the excess of ferrite or cementite for hypo and hyper-eutectic steel and white cast iron respectively.

18. *The Carbon-Content, i.e. the Ratio of Ferrite to Cementite, of certain Typical Steels.*—Fig. 3 shows how, as the carbon-content rises from 0 to 4.5%, the percentage of the glass-hard cementite, which is 15 times that of the carbon itself, rises, and that of the soft copper-like ferrite falls, with consequent continuous increase of hardness and loss of malleableness and ductility. The tenacity or tensile strength increases till the carbon-content reaches about 1.25% and the cementite about 19%, and then in turn falls, a result by no means surprising. The presence of a small quantity of the hard cementite ought naturally to strengthen the mass, by opposing the tendency of the soft ferrite to flow under any stress applied to it; but more cementite by its brittleness naturally weakens the mass, causing it to crack open under the distortion which stress inevitably causes. The fact that this decrease of strength begins shortly after the carbon-content rises above the eutectoid or pearlite ratio of 0.90% is natural, because the brittleness of the cementite which, in hyper-eutectoid steels, forms a more or less continuous skeleton (ALLOYS, PL. fig. 13) should be much more effective in starting cracks under distortion than that of the far more minute particles of cementite which lie embedded, indeed drowned, in the sixfold greater mass of ferrite with which they are associated in the pearlite itself. The large massive plates of cementite which form the network or skeleton in hyper-eutectoid steels should, under distortion, naturally tend to cut, in the softer pearlite, chasms too serious to be healed by the inflowing of the plastic ferrite, though this ferrite flows around and

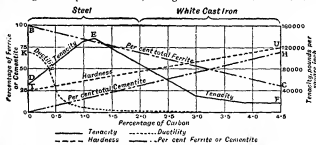

FIG. 3.—Physical properties and assumed microscopic constitution of the pearlite series, graphitised steel slowly cooled and white cast iron. By "total ferrite" is meant both that which forms part of the pearlite and that which is in excess of the pearlite, taken jointly. So with the "total cementite."

immediately heals over any cracks which form in the small quantity of cementite interstratified with it in the pearlite of hypo-eutectoid steels.

As the carbon-content increases the welding power naturally decreases rapidly, because of the rapid fall of the "solidus curve" at which solidification is complete (A $\alpha$  of fig. 1), and hence of the range in which the steel is coherent enough to be manipulated, and, finally, of the attainable pliancy and softness of the metal. Clearly the mushy mixture of solid austenite and molten iron of which the metal in region 2 consists cannot cohere under either the blows or the pressure by means of which welding must be done. Rivet steel, which above all needs extreme ductility to endure the distortion of being driven home, and tube steel which must needs weld easily, no matter at what sacrifice of strength, are made as free from carbon, i.e. of as nearly pure ferrite, as is practicable. The distortion which rails undergo in manufacture and use is incomparably less than that to which rivets are subjected, and thus rail steel may safely be much richer in carbon and hence in cementite, and therefore much stronger and harder, so as to better endure the load and the abrasion of the passing wheels. Indeed, its carbon-content is made small quite as much because of the violence of the shocks from those wheels as because of any actual distortion to be expected, since, within limits, as the

carbon-content increases the shock-resisting power decreases. Here, as in all cases, the carbon-content must be the result of a compromise, neither so small that the rail flattens and wears out like lead, nor so great that it snaps like glass. Boiler plates undergo in shaping and assembling an intermediate degree of distortion, and therefore they must be given an intermediate carbon-content, following the general rule that the carbon-content and hence the strength should be as great as is consistent with retaining the degree of ductility and the shock-resisting power which the object will need in actual use. Thus the typical carbon-content may be taken as about 0.05% for rivets and tubes, 0.20% for boiler plates, and 0.50 to 0.75% for rails, implying the presence of 0.75% of cementite in the first two, 3% in the third and 7.5% to 11.25% in the last.

19. *Carbon-Content of Hardened Steels.*—Turning from these cases in which the steel is used in the slowly cooled state, so that it is a mixture of pearlite with ferrite or cementite, i.e. is pearlitic, to those in which it is used in the hardened or martensitic state, we find that the carbon-content is governed by like considerations. Railway car springs, which are exposed to great shock, have typically about 0.75% of carbon; common tool steel, which is exposed to less severe shock, has usually between 0.75 and 1.25%; file steel, which is subject to but little shock, and has little demand of it but to bite hard and stay hard, has usually from 1.25 to 1.50%. The carbon-content of steel is rarely greater than this, lest the brittleness be excessive. But beyond this are the very useful, because very fusible, cast irons with from 3 to 4% of carbon, the embrittling effect of which is much lessened by its being in the state of graphite.

20. *Slag or Cinder*, a characteristic component of wrought iron, which usually contains from 0.20 to 2.00% of it, is essentially a mixture of iron (ferrous silicate) and iron, and is present in wrought iron simply because this product is made by welding together pasty granules of iron in a molten bath of slag, without ever melting the resultant mass or otherwise giving the envelopes of slag thus imprisoned a chance to escape completely.

21. *Graphite*, nearly pure carbon, is characteristic of "gray cast iron," in which it exists as a nearly continuous skeleton of very thin laminated plates or flakes (fig. 27), usually curved, and forming from 2.50% to 3.50% of the whole. As these flakes readily split open, when a piece of this iron is broken rapidly passing through them, with the result that even the graphite may form only some 3% of the mass by weight (say 10% by volume), practically nothing but graphite is seen in the fracture. Hence the weakness and the dark-grey fracture of this iron, and hence, by brushing this fracture with a wire brush and so detaching these loosely clinging flakes of graphite, the colour can be changed nearly to the very light-grey of pure iron. There is rarely any important quantity of graphite in commercial steels. (See § 26.)

22. *Further Illustration of the Iron-Carbon Diagram.*—In order to illustrate further the meaning of the diagram (fig. 11), let us follow by means of the elements O, Fe, and C the undisturbed cooling of molten hyper-eutectoid steel containing 1% of carbon, for simplicity assuming that no graphite forms and that the several transformations occur promptly as they fall due. When the gradually falling temperature reaches 1430° (g), the mass begins to freeze as  $\gamma$ -iron or austenite, called "primary" to distinguish it from that which forms part of the eutectic. But the freezing, instead of completing itself at a fixed temperature as that of pure water does, continues until the temperature sinks to  $r$  on the line  $A_2$ . Thus the iron has rather a freezing-point than a freezing-point. Moreover, the freezing is "selective." The first particles of austenite to freeze contain about 0.8% of carbon (2). As freezing progresses, at each successive temperature reached the frozen austenite has the carbon-content of the point on  $A_2$  which that temperature abscissa cuts, and the still molten part or "mother-metal" has the carbon-content horizontally opposite this on the line  $AB$ . In other words, the composition of the frozen part and that of the mother-metal respectively are  $p$  and  $q$  at the beginning of the freezing, and  $r$  and  $r'$  at the end; and during freezing they slide along  $A_2$  and  $AB$  from  $p$  to  $r$  and from  $q$  to  $r'$ . This, of course, brings the final composition of the frozen austenite when freezing is complete exactly to that which the molten mass had before freezing began.

The heat evolved by this process of solidification retards the fall of temperature; but after this the rate of cooling remains regular until  $T$  (750°) on the line  $Se$  ( $A_2$ ) is reached, when a second retardation occurs, due to the heat liberated by the passage within the pasty mass of part of the iron and carbon from a state of mere solution to that of definite combination in the ratio  $Fe_3C$ , forming microscopic particles of cementite, while the remainder of the iron and carbon continue dissolved in each other as austenite. This formation of cementite continues as the temperature falls, till at about 690° (U), called  $A_1$ , so much of the carbon (in this case about 0.10%) and of the iron have united in the form of cementite, that the composition of the remaining solid-solution or "mother-metal" of austenite has reached that of the eutectoid, hardenite; i.e. it now contains 0.90% of carbon. The cementite which has thus far been forming may be called "pro-eutectoid" cementite, because it forms before the remaining austenite reaches the eutectoid composition. As the temperature now falls past 690°, this hardenite mother-metal in turn splits up, after the fashion of eutectics, into alternate layers of ferrite and cementite grouped together as pearlite,

so that the mass as a whole now becomes a mixture of pearlite with cementite. The iron thus liberated, as the ferrite of this pearlite, changes simultaneously to  $\alpha$ -ferrite. The passage of this large quantity of carbon and iron, 0.90% of the former and 12.6 of the latter, from a state of mere solution as hardenite to one of definite chemical union as cementite, together with the passage of the iron itself from the  $\gamma$  to the  $\alpha$  state, evolves so much heat as actually to heat the mass up so that it brightens in a striking manner. This phenomenon is called the "recalescence."

This change from austenite to ferrite and cementite, from the  $\gamma$  through the  $\beta$  to the  $\alpha$  state, is of course accompanied by the loss of the "hardening power," i.e. the power of being hardened by sudden cooling, because the essence of this hardening is the retention of the  $\beta$  state. As shown in ALLOYS, Pl., fig. 13, the slowly cooled steel now consists of kernels of pearlite surrounded by envelopes of the cementite which was born of the austenite in cooling from  $T$  to  $U$ .

23. To take a second case, molten hyper-eutectoid steel of 0.20% of carbon on freezing from  $K$  to  $x$  passes in the like manner to the state of solid austenite,  $\gamma$ -iron with this 0.20% of carbon dissolved in it. Its further cooling undergoes three spontaneous retardations, one at  $K'$  ( $A_2$  about 820°), at which part of the iron begins to isolate itself within the austenite mother-metal in the form of envelopes of  $\beta$ -ferrite, i.e. of free iron of the  $\beta$  allotropic modification, which surrounds the kernels or grains of the residual still undecomposed part of the austenite. At the second retardation,  $K''$  ( $A_2$  about 770°) this ferrite changes to the normal magnetic  $\alpha$ -ferrite, so that the mass as a whole becomes magnetic. Moreover, the envelopes of ferrite begin to agglomerate, and the mass begins to coarsen by the accession of more and more ferrite born from the austenite progressively as the temperature sinks, till, by the time when  $Ar_1$  (about 690°) is reached, so much free ferrite has been formed that the remaining mother-metal has been enriched to the composition of hardenite, i.e. it now contains 0.90% of carbon. Again, as the temperature in turn falls past  $Ar_1$ , this hardenite mother-metal splits up into cementite and ferrite grouped together as pearlite, with the resulting recalescence, and the mass, as shown in ALLOYS, Pl., fig. 12, then consists of kernels of pearlite surrounded by envelopes of ferrite. All these phenomena, which are parallel with those of 0.90% carbon steel at their own critical point  $A_1$ . As such steel cools slowly past  $Ar_2$ ,  $Ar_1$  and  $Ar_2$ , it loses its hardening power progressively.

In short, from  $A_2$  to  $Ar_1$  the excess substance ferrite or cementite, in hypo- and hyper-eutectoid steels respectively, progressively crystallizes out as a network or skeleton within the austenite mother-metal, which thus progressively approaches the composition of hardenite, reaching it at  $Ar_1$ , and there splitting up into ferrite and cementite interstratified as pearlite. Further, any ferrite liberated at  $Ar_2$  changes to  $\alpha$  ferrite from  $\beta$ , and any present at  $Ar_2$  changes from  $\beta$  to  $\alpha$ . Beyond  $Ar_1$  there occurs another set of critical points, so that these critical points in these special cases are called  $Ar_{2-1}$ ,  $Ar_{2-2}$  and  $Ar_{2-3}$ , respectively. The corresponding critical points which occur during rise of temperature, with the reverse transformations, are called  $Ac_1$ ,  $Ac_2$ ,  $Ac_3$ , &c. A (Tschernoff) is the generic name,  $r$  refers to falling temperature (refroidissement) and  $c$  to rising temperature (chauffant, Osmond).

24. The freezing of molten cast iron of 2.50% of carbon goes on selectively like that of these steels which we have been studying, till the enrichment of the molten mother-metal in carbon brings its carbon-content to  $B$ , 4.30%, the eutectic<sup>1</sup> carbon-content, i.e. that of the greatest fusibility or lowest melting-point. At this point selection ceases; the remaining molten metal freezes as a whole, and in freezing splits up into a conglomerate eutectic of (1) austenite of about 2.2% of carbon, and therefore saturated with that element, and (2) cementite; and with this eutectic is mixed the "primary" austenite which froze out as the temperature sank from  $v$  to  $v'$ .

The white-hot, solid, but soft mass is now a conglomerate of (1) "primary" austenite, (2) "eutectic" austenite and (3) "eutectic" cementite. As the temperature sinks still farther, pro-eutectoid cementite (see § 22) forms progressively in the austenite both primary and eutectic, and this pro-eutectoid cementite as it comes into existence tends to assemble in the form of a network enveloping the kernels or grains of the austenite from which it springs. The reason for its birth, of course, is that the solubility of carbon in austenite progressively decreases as the temperature falls, from about 2.2% at 1130° (a), to 0.90% at 690° ( $Ar_1$ ), as shown by the line  $aS$ , with the consequence that the austenite keeps rejecting in the form of this pro-eutectoid cementite all carbon in excess of its saturation-point for the existing temperature. Here the eutectic consists of (1) primary austenite, (2) eutectic austenite and cementite interstratified and (3) pro-eutectoid cementite.

This formation of cementite through the rejection of carbon by both the primary and the eutectic austenite continues quite as in the case of 1.00% carbon steel, with impoverishment of the austenite to the hardenite or eutectoid ratio, and the splitting up of that hardenite into pearlite at  $Ar_1$ , so that the mass when cold finally consists of (1)

<sup>1</sup> Note the distinction between the "eutectic" or alloy of lowest freezing-point, 1130°,  $B$ , with 4.30% of carbon, and the "eutectoid," hardenite and pearlite, or alloy of lowest transformation-point, 690°,  $S$ , with 0.90% of carbon. (See § 17.)



the primary austenite now split up into kernels of pearlite surrounded by envelopes of pro-eutectoid cementite, (2) the eutectic of cementite plus austenite, the latter of which has in like manner split up into a mixture of pearlite plus cementite. Such a mass is shown in fig. 4. Here the black bat-like patches are the masses of pearlite plus pro-eutectoid cementite resulting from the splitting up of the primary austenite. The magnification is too small to show the zebra striping of the pearlite. In the black-and-white ground mass the white is the eutectic cementite, and the black the eutectic austenite, now split up into pearlite and pro-eutectoid cementite, which cannot here be distinguished from each other.

25. As we pass to cases with higher and higher carbon-content, the primary austenite which freezes in cooling across region 2 forms a

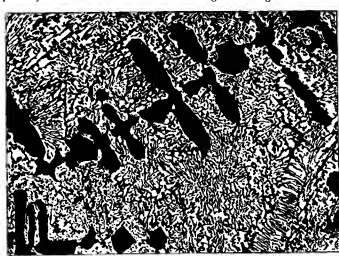

FIG. 4.—The constitution of hypo-eutectic white or cementiferous cast iron (washed metal), W. Campbell. The black bat-like areas are the primary austenite, the zebra-marked ground mass the eutectic, composed of white stripes of cementite and black stripes of austenite. Both the primary and eutectic austenite have changed in cooling into a mixture of pearlite and pro-eutectoid cementite, too fine to be distinguished here.

smaller and smaller proportion of the whole, and the austenite-cementite eutectic which forms at the eutectic freezing-point,  $1130^{\circ}$  ( $\alpha\beta$ ), increases in amount until, when the carbon-content reaches the eutectic ratio, 4.30% there is but a single freezing-point, and the whole mass when solid is made up of this eutectic. If there is more than 4.30% of carbon, then in cooling through region 3 the excess of carbon over this ratio freezes out as "primary" cementite. But in any event the changes which have just been described for cast iron of 2.50% of carbon occur in crossing region 7, and at  $A_1$  ( $PSP$ ).

Just as variations in the carbon-content shift the temperature of the freezing-range and of the various critical points, so do variations in the content of other elements, notably silicon, phosphorus, manganese, chromium, nickel and tungsten. Nickel and manganese lower these critical points, so that with 25% of nickel  $A_1$  lies below the common temperature  $20^{\circ}$  C. With 13% of manganese  $A_1$  is very low, and the austenite decomposes so slowly that it is preserved practically intact by sudden cooling. These steels then normally consist of  $\gamma$ -iron, modified by the large amount of nickel or manganese with which it is alloyed. They are non-magnetic or very feebly magnetic. But the critical points of such nickel steel though thus depressed, are not destroyed; and if it is cooled in liquid air below its  $A_1$ , it passes to the  $\alpha$  state and becomes magnetic.

26. *Double Nature of the Carbon-Iron Diagram.*—The part played by graphite in the constitution of the iron-carbon compounds, hitherto ignored for simplicity, is shown in fig. 5. Looking at the matter in a broad way, in all these carbon-iron alloys, both steel and cast iron, part of the carbon may be dissolved in the iron, *i.e.* the carbon which is not dissolved, or the "undissolved carbon," forms either the definite carbide, cementite,  $Fe_3C$ , or else exists in the free state as graphite. Now, just as fig. 1 shows the constitution of these iron-carbon alloys for all temperatures and all percentages of carbon when the undissolved carbon exists as cementite, so there should be a diagram showing this constitution when all the undissolved carbon exists as graphite. In short, there are two distinct carbon-iron diagrams, the iron-cementite one shown in fig. 1 and studied at length in §§ 22 to 25, and the iron-graphite one shown in fig. 5 in unbroken lines, with the iron-cementite diagram reproduced in broken lines for comparison. What here follows represents our present rather ill-established theory. These two diagrams naturally have much the same general shape, but though the boundaries of the several regions in the iron-cementite diagram are known pretty accurately, and though the relative positions of the boundaries of the

two diagrams are probably about as here shown, the exact topography of the iron-graphite diagram is not yet known. In it the normal constituents are, for region II., molten metal + primary austenite; for region III., molten metal + primary graphite; for region IV., primary austenite; for region VII., eutectic austenite, eutectic graphite, and a quantity of pro-eutectoid graphite which increases as we pass from the upper to the lower part of the region, together with primary austenite at the left of the eutectic point  $B'$  and primary graphite at the right of that point. Thus when iron containing 2.50% of carbon (*v. fig. 1*) solidifies, its carbon may form cementite following the cementite-austenite diagram so that white, *i.e.* cementiferous, cast iron results; or graphite, following the graphite-austenite diagram, so that ultra-grey, *i.e.* typical graphitic cast iron results; or, as usually happens, certain molecules may follow one diagram while the rest follow the other diagram, so that cast iron which has both cementite and graphite results, as in most commercial grey cast iron, and typically in "mottled cast iron," in which there are distinct patches of grey and others of white cast iron.

Though carbon passes far more readily under most conditions into the state of cementite than into that of graphite, yet of the two graphite is the more stable and cementite the less stable, or the "metastable" form. Thus cementite is always tending to change over into graphite by the reaction  $Fe_3C = 3Fe + Gr$ , though this tendency is often held in check by different causes; but graphite never changes back directly into cementite, at least according to our present theory. The fact that graphite may dissolve in the iron as austenite, and that when this latter again breaks up it is more likely to yield cementite than graphite, is only an apparent and not a real exception to this law of the greater stability of graphite than of cementite.

Slow cooling, slow solidification, the presence of an abundance of carbon, and the presence of silicon, all favour the formation of graphite; rapid cooling, the presence of sulphur, and in most cases that of manganese, favour the formation of cementite. For instance, though in cast iron, which is rich in carbon, that carbon passes comparatively easily into the state of graphite, yet in steel, which contains much less carbon, but little graphite forms under most conditions. Indeed, in the common structural steels which contain only very little carbon, hardly any of that carbon exists as graphite.

27. *Thermal Treatment.*—The hardening, tempering and annealing of steel, the chilling and annealing of cast iron, and the annealing of malleable cast iron are explained readily by the facts just set forth. The *hardening of steel* consists in first transforming it into austenite by heating it up into region I, and then quenching it, usually in cold water, so as to cool it very suddenly, and thus to deny the time which the complete transformation of the austenite into ferrite and cementite requires, and thereby to catch much of the iron in transit in the hard brittle  $\beta$  state. In the cold this transformation cannot take place, because of molecular rigidity or some

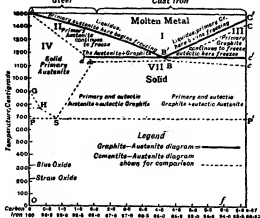

FIG. 5.—Graphite-austenite or stable carbon-iron, diagram.

other impediment. The suddenly cooled metal is hard and brittle, because the cold  $\beta$ -iron which it contains is hard and brittle.

The degree of hardening which the steel undergoes increases with its carbon-content, chiefly because, during sudden cooling, the presence of carbon acts like a brake to impede the transformations, and thus to increase the quantity of  $\beta$ -iron caught in transit, but probably also in part because the hardness of this  $\beta$ -iron increases with its carbon-content. Thus, though sudden cooling has very little effect on steel of 0.10% of carbon, it changes that of 1.50% from a somewhat ductile body to one harder and more brittle than glass.

29. *The Tempering and Annealing of Steel.*—But this sudden cooling goes too far, preserving so much  $\beta$ -iron as to make the steel too brittle for most purposes. This brittleness has therefore in general to be mitigated or "tempered," unfortunately at the cost of losing part of the hardness proper, by reheating the hardened steel slightly,

usually to between 200° and 300° C., so as to relax the molecular rigidity and thereby to allow the arrested transformation to go on a little farther, shifting a little of the  $\beta$ -iron over into the  $\alpha$  state. The higher the tempering-temperature, *i.e.*, that to which the hardened steel is thus reheated, the more is the molecular rigidity relaxed, the farther  $\beta$ -iron does the transformation go, and the softer does the steel become, so that, if the reheating reaches a dull-red heat, the transformation from austenite into ferrite and cementite completes itself slowly, and when now cooled the steel is as soft and ductile as if it had never been hardened. It is now said to be "annealed."

30. *Chilling cast iron, i.e.* hastening its cooling by casting it in a cool mould, favours the formation of cementite rather than of graphite in the freezing of the eutectic at  $\beta$ Fe, and also, in case of hyper-eutectic iron, in the passage through region 3. Like the annealing of steel, it hinders the transformation of the austenite, whether primary or eutectic, into pearlite+cementite, and thus catches part of the iron in transit in the hard  $\beta$ -state. The annealing of such iron may occur in either of two degrees—a small one, as in making common chilled cast iron objects, such as railway car wheels, or a great one, as in making malleable cast iron. In the former case, the objects are heated only to the neighbourhood of  $A_c$ , say to 730° C., so that the  $\beta$ -iron may slip into the  $\alpha$  state, and the transformation of the austenite into pearlite and cementite may complete itself. In the latter case, the objects are heated to make the metal much harder than if slowly cooled, because for each 1% of graphite which the chilling suppresses, 15% of the glass-hard cementite is substituted. Thus a cast iron which, if cooled slowly, would have been "grey," *i.e.* would have consisted chiefly of graphite with pearlite and ferrite (which are all relatively soft bodies), if thus chilled and annealed consists of cementite and pearlite. But in most such cases, in spite of the annealing, this hardness is accompanied by a degree of brittleness too great for most purposes. The process therefore is so managed that only the outer shell of the casting is chilled, and that the interior remains graphitic, *i.e.* grey cast iron, soft and relatively malleable.

31. In making malleable castings the annealing, *i.e.* the change towards the stable state of ferrite+graphite, is carried much farther by means of a much longer and usually a higher heating than in the manufacture of chilled castings. The castings, initially of white cast iron, are heated for about a week, to a temperature usually above 730° C. and often reaching 900° (1345° and 1652°), and for about 90 hours the heat is held at its highest point, at which it descends extremely slowly. The molecular freedom which this high temperature gives enables the cementite to change gradually into a mixture of graphite and austenite with the result that, after the castings have been cooled and their austenite has in cooling past  $A_c$  changed into pearlite and ferrite, the mixture of cementite and pearlite of which they originally consisted has now given place to one of fine or "temper" graphite and ferrite, with more or less pearlite according to the completeness of the transfer of carbon to the state of graphite. When then, is this material malleable, though the common grey cast iron, which is made up of about the same constituents and often in about the same proportion, is brittle? The reason is that the particles of temper graphite which are thus formed within the solid casting in its long annealing are so finely divided that they do not break up the continuity of the mass in a very harmful way; whereas in grey cast iron both the eutectic graphite formed in solidifying, and also the primary graphite which, in case the metal is hyper-eutectic, forms in cooling through region 3 of fig. 1, surrounded as it is by the still more brittle metal out of which it is growing, form a nearly continuous skeleton of very large flakes, which do break up in a most harmful way the continuity of the mass of cast iron in which they are embedded.

In carrying out this process the castings are packed in a mass of iron oxide, which at this temperature gradually removes the fine or "temper" graphite by oxidizing that in the outer crust to carbonic oxide, whereas the carbon farther in begins diffusing outwards by "molecular migration," to be itself oxidized and removed by the crust. The removal of graphite doubtless further stimulates the formation of graphite, by relieving the mechanical and perhaps the osmotic pressure. Thus, first, for the brittle glass-hard cementite there is gradually substituted the relatively harmless temper graphite; and, second, even this is in part removed by surface oxidation.

32. *Fineness of Structure.*—Each of these ancient processes thus consists essentially in so manipulating the temperature that, out of the several possible constituents, the metal shall actually consist of a special set in special proportions. But in addition there is another very important principle underlying many of our thermal processes, *viz.* that the state of aggregation of certain of these constituents, and through it the properties of the metal as a whole, are profoundly affected by temperature manipulations. Thus, prior exposure to a temperature materially above  $A_c$  coarsens the structure of most steel, in the sense of giving it when cold a coarse fracture, and enlarging the grains of pearlite, &c., later found in the slowly cooled metal. This coarsening and the brittleness which accompanies it increase with the temperature to which the metal has been exposed. Steel which after a slow cooling from about 722° C. will break grey before breaking, will, after slow cooling from about 1050° C., bend only 18° before breaking. This injury fortunately can be cured

either by reheating the steel to  $A_c$  when it "refines," *i.e.* returns spontaneously to its fine-grained ductile state (cooling past  $A_c$  does not have this effect); or by breaking up the coarse grains by mechanical distortion, *e.g.* by forging or rolling. For instance, if steel has been coarsened by heating to 1400° C., and if, when it has cooled to a lower temperature, say 850° C. we forge it, its grain-size and ductility when cold will be approximately those which it would have had if heated only to 850°. Hence steel which has been heated very highly, whether for welding, or for greatly softening it so that it can be rolled to the desired shape with but little expenditure of power, ought later to be refined, either by reheating it from below  $A_c$  to slightly above  $A_c$  or by rolling it after it has cooled to a relatively low temperature, *i.e.* by having a low 'finishing temperature.' Steel castings have initially the extremely coarse structure due to cooling without mechanical distortion from their very high temperature of solidification; they are "annealed," *i.e.* this coarseness and the consequent brittleness are removed, by reheating them much above  $A_c$ , which also relieves the internal stresses due to the different rates at which different layers cool, and hence contract, during and after solidification. For steel containing less than about 0.13% of carbon, the embrittling temperature is in a different range, near 700° C., and such steel refines at temperatures above 900° C.

33. *The Possibilities of Thermal Treatment.*—When we consider the great number of different regions in fig. 1, each with its own set of constituents, and remember that by different rates of cooling from different temperatures we can retain in the cold metal these different sets of constituents in widely varying proportions; and when we further reflect that not only the proportion of each constituent present but also its state of aggregation can be controlled by thermal treatment, we see how vast a field is here opened, how great a variety of different properties can be induced in any individual piece of steel, how enormous the variety of properties thus attainable in the different varieties collectively, especially since for each percentage of carbon an incalculable number of varieties of steel may be made by alloying it with different proportions of such elements as nickel, chromium, &c. As yet there has been only the roughest survey of certain limited areas in this great field, the further exploration of which will enormously increase the usefulness of this wonderful metal.

34. *Alloy steels* have come into extensive use for important special purposes, and a very great increase of their use is to be expected. The chief ones are nickel steel, manganese steel, chrome steel and chrome-tungsten steel. The general order of merit of a given variety or specimen of iron or steel may be measured by the degree to which it combines strength and hardness with ductility. These two classes of properties tend to exclude each other, for, as a general rule, whatever tends to make iron and steel hard and strong tends to make it correspondingly brittle, and hence liable to break treacherously, especially under shock. Manganese steel and nickel steel form an important exception to this rule, in being at once very strong and hard and extremely ductile. Nickel steel, which usually contains from 3 to 3.50% of nickel and about 0.25% of carbon, combines very great tensile strength and hardness, and a very high limit of elasticity, with great ductility. Its combination of ductility with strength and hardening power has given it very extended use for the armour of war-vessels. For instance, following Krupp's formula, the side and barbettes armour of war-vessels is now generally if not universally made of nickel steel containing about 3.25% of nickel, 0.40% of carbon, and 1.50% of chromium, deeply carburized on its impact face. Here the merit of nickel steel is not so much that it resists perforation, as that it does not crack even when deeply penetrated by a projectile. The combination of ductility, which lessens the tendency to break when overstrained or distorted, with a very high limit of elasticity, gives it great value for shafting, the merit of which is measured by its endurance of the repeated stresses to which its rotation exposes it whenever its alignment is not mathematically straight. The alignment of marine shafting, changing with every passing wave, is an extreme example. Such an intermittently applied stress is far more destructive to iron than a continuous one, and even if it is only half that of the limit of elasticity, its indefinite repetition eventually causes rupture. In a direct competitive test the presence of 3.25% of nickel increased nearly sixfold the

number of rotations which a steel shaft would endure before breaking.

35. As actually made, *manganese steel* contains about 12% of manganese and 1.50% of carbon. Although the presence of 1.50% of manganese makes steel relatively brittle, and although a further addition at first increases this brittleness, so that steel containing between 4 and 5.5% can be pulverized under the hammer, yet a still further increase gives very great ductility, accompanied by great hardness—a combination of properties which was not possessed by any other known substance when this remarkable alloy, known as Hadfield's manganese steel, was discovered. Its ductility, to which it owes its value, is profoundly affected by the rate of cooling. Sudden cooling makes the metal extremely ductile, and slow cooling makes it brittle. Its behaviour in this respect is thus the opposite of that of carbon steel. But its great hardness is not materially affected by the rate of cooling. It is used extensively for objects which require both hardness and ductility, such as rock-crushing machinery, railway crossings, mine-car wheels and safes. The burglar's blow-pipe locally "draws the temper," i.e. softens a spot on a hardened carbon steel or chrome steel safe by simply heating it, so that as soon as it has again cooled he can drill through it and introduce his charge of dynamite. But neither this nor any other procedure softens manganese steel rapidly. Yet this very fact that it is unalterably hard has limited its use, because of the great difficulty of cutting it to shape, which has in general to be done with emery wheels instead of the usual iron-cutting tools. Another defect is its relatively low elastic limit.

36. *Chrome steel*, which usually contains about 2% of chromium and 0.80 to 2.0% of carbon, owes its value to combining, when in the "hardened" or suddenly cooled state, intense hardness with a high elastic limit, so that it is neither deformed permanently nor cracked by extremely violent shocks. For this reason it is the material generally if not always used for armour-piercing projectiles. It is much used also for certain rock-crushing machinery (the shoes and dies of stamp-mills) and for safes. These are made of alternate layers of soft wrought iron and chrome steel hardened by sudden cooling. The hardness of the hardened chrome steel resists the burglar's drill, and the ductility of the wrought iron the blows of his sledge.

Vanadium in small quantities, 0.15 or 0.20%, is said to improve steel greatly, especially in increasing its resistance to shock and to often-repeated stress. But the improvement may be due wholly to the considerable chromium content of these so-called vanadium steels.

37. *Tungsten steel*, which usually contains from 5 to 10% of tungsten and from 1 to 2% of carbon, is used for magnets, because of its great retentivity.

38. *Chrome-tungsten or High-speed Steel*.—Steel with a large content of both chromium and tungsten has the very valuable property of "red-hardness," i.e. of retaining its hardness and hence its power of cutting iron and other hard substances, even when it is heated to dull redness, say 600° C. (1112° F.) by the friction of the work which it is doing. Hence a machinist can cut steel or iron nearly six times as fast with a lathe tool of this steel as with one of carbon steel, because with the latter the cutting speed must be so slow that the cutting tool is not heated by the friction above say 250° C. (482° F.), lest it be unduly softened or "tempered" (§ 20). This effect of chromium, tungsten and carbon jointly consists essentially in raising the "tempering temperature," i.e. that to which the metal, in which by suitable thermal treatment the iron molecules have been brought to the allotropic  $\gamma$  or  $\beta$  state or a mixture of both, can be heated without losing its hardness through the escape of that iron into the  $\alpha$  state. In short, these elements seem to impede the allotropic change of the iron itself. The composition of this steel is as follows:—

The usual limits. Apparently the best.

Carbon	. . . . .	0.32 to 1.28	0.68 to 0.67
Manganese	. . . . .	0.03 " 0.30	0.07 " 0.11
Chromium	. . . . .	2.23 " 7.02	5.95 " 5.47
Tungsten	. . . . .	9.25 " 25.45	17.81 " 18.19

39. *Impurities*.—The properties of iron and steel, like those of most of the metals, are profoundly influenced by the presence of small and sometimes extremely small quantities of certain impurities, of which the most important are phosphorus and sulphur, the former derived chiefly from apatite (phosphate of lime) and other minerals which accompany the iron ore itself, the latter from the pyrite found not only in most iron ores but in nearly all coal and coke. All commercial iron and steel contain more or less of both these impurities, the influence of which is so strong that a variation of 0.01%, i.e. of one part in 10,000, of either of them has a noticeable effect. The best tool steel should not contain more than 0.02% of either, and in careful practice it is often specified that the phosphorus and sulphur respectively shall not exceed 0.04 and 0.05% in the steel for important bridges, or 0.06 and 0.07% in rail steel, though some very prudent engineers allow as much as 0.85% or even 0.10% of phosphorus in rails.

40. The specific effect of *phosphorus* is to make the metal cold-short, i.e. brittle in the cold, apparently because it increases the size and the sharpness of demarcation of the crystalline grains of which the mass is made up. The specific effect of *sulphur* is to make the metal red-short, i.e. brittle when at a red heat, by forming a network of iron sulphide which encases these crystalline grains and thus plays the part of a weak link in a strong chain.

41. *Oxygen*, probably dissolved in the iron as ferrous oxide FeO, also makes the metal red-short.

42. *Manganese* by itself rather lessens than increases the malleableness and, indeed, the general merit of the metal, but it is added intentionally, in quantities even as large as 1.5% to palliate the effects of sulphur and oxygen. With sulphur it forms a sulphide which draws together into almost harmless drops, instead of encasing the grains of iron. With oxygen it probably forms manganous oxide, which is less harmful than ferrous oxide. (See § 35.)

43. *Ores of Iron*.—Even though the earth seems to be a huge iron meteor with but a thin covering of rocks, the exasperating proneness of iron to oxidize explains readily why this metal is only rarely found native, except in the form of meteorites. They are four important iron ores, magnetite, haematite, limonite and siderite, and one of less but still considerable importance, pyrite or pyrites.

44. *Magnetite*, Fe<sub>3</sub>O<sub>4</sub>, contains 72.41% of iron. It crystallizes in the cubical system, often in beautiful octahedra and rhombic dodecahedra. It is black with a black streak. Its specific gravity is 5.2, and its hardness 5.5 to 6.5. It is very magnetic, and sometimes polar.

45. *Haematite*, or red haematite, Fe<sub>2</sub>O<sub>3</sub>, contains 70% of iron. It crystallizes in the rhombohedral system. Its colour varies from brilliant bluish-grey to deep red. Its streak is always red. Its specific gravity is 5.3 and its hardness 5.5 to 6.5.

46. *Limonite*, 2Fe<sub>2</sub>O<sub>3</sub>·3H<sub>2</sub>O, contains 59.9% of iron. Its colour varies from light brown to black. Its streak is yellowish-black, its specific gravity 3.6 to 4.0, and its hardness 5 to 5.5. Limonite and the related minerals, turgite, 2Fe<sub>2</sub>O<sub>3</sub>·H<sub>2</sub>O, and gothite, Fe<sub>2</sub>O<sub>3</sub>·H<sub>2</sub>O, are grouped together under the term "brown haematite."

47. *Siderite*, or spathic iron ore, FeCO<sub>3</sub>, crystallizes in the rhombohedral system and contains 48.28% of iron. Its colour varies from yellowish-brown to grey. Its specific gravity is 3.7 to 3.9, and its hardness 3.5 to 4.5. The clayey siderite of the British coal measures is called "black band," and that containing bituminous matter is called "clay band."

48. *Pyrite*, FeS<sub>2</sub>, contains 46.7% of iron. It crystallizes in the cubic system, usually in cubes, pentagonal dodecahedra or octahedra, often of great beauty and perfection. It is golden-yellow, with a greenish or brownish-black streak. Its specific gravity is 4.83 to 5.2, its hardness 6 to 6.5. Though it contains far too much sulphur to be used in iron manufacture without first being desulphurized, yet great quantities of slightly cupriferrous pyrite, after yielding nearly all their sulphur in the manufacture of sulphuric acid, and most of the remainder in the wet extraction of their copper, are then used under the name of "blue billy" or "purple ore," as an ore of iron, a use which is likely to increase greatly in importance with the gradual exhaustion of the richest deposits of the oxidized ores.

49. *The Ores actually Impure*.—As these five minerals actually exist in the earth's crust they are usually more or less impure chemically, and they are almost always mechanically mixed with

barren mineral matter, such as quartz, limestone and clay, collectively called "the gangue." In some cases the iron-bearing mineral, such as magnetite or haematite, can be separated from the gangue after crushing, either mechanically or magnetically, so that the part thus enriched or "concentrated" alone need be smelted.

50. *Geological Age.*—The Archaean crystalline rocks abound in deposits of magnetite and red haematite, many of them very large and rich. These of course are the oldest of our ores, and from deposits of like age, especially those of the more readily decomposed silicates, has come the iron which now exists in the siderites and red and brown haematites of the later geological formations.

51. *The World's Supply of Iron Ore.*—The iron ores of the earth's crust will probably suffice to supply our needs for a very long period, perhaps indeed for many thousand years. It is true that an official statement, which is here reproduced,

TABLE II.—*Professor Tornebohm's Estimate of the World's Ore Supply.*

Country.	Workable Deposits.	Annual Output.	Annual Consumption.
	tons.	tons.	tons.
United States . . .	1,100,000,000	35,000,000	35,000,000
Great Britain . . .	1,000,000,000	14,000,000	20,000,000
Germany . . . . .	2,200,000,000	21,000,000	24,000,000
Spain . . . . .	500,000,000	8,000,000	1,000,000
Russia and Finland	1,500,000,000	4,000,000	6,000,000
France . . . . .	1,500,000,000	6,000,000	8,000,000
Sweden . . . . .	1,000,000,000	4,000,000	1,000,000
Austria-Hungary . .	1,200,000,000	3,000,000	4,000,000
Other countries . . .		5,000,000	1,000,000
Total . . . . .	10,000,000,000	100,000,000	100,000,000

*Note to Table.*—Though this estimate seems to be near the truth as regards the British ores, it does not credit the United States with one-tenth, if indeed with one-twentieth, of their true quantity as estimated by that country's Geological Survey in 1907.

given in 1905 by Professor Tornebohm to the Swedish parliament, credited the world with only 10,000,000,000 tons of ore, and that, if the consumption of iron should continue to increase hereafter as it did between 1893 and 1906, this quantity would last only until 1946. How then can it be that there is a supply for thousands of years? The two assertions are not to be reconciled by pointing out that Professor Tornebohm underestimated, for instance crediting the United States with only 1.1 billion tons, whereas the United States Geological Survey's expert credits that country with from ten to twenty times this quantity; nor by pointing out that only certain parts of Europe and a relatively small part of North America have thus far been carefully explored for iron ore, and that the rest of these two continents and South America, Asia and Africa may reasonably be expected to yield very great stores of iron, and that pyrite, one of the richest and most abundant of ores, has not been included. Important as these considerations are, they are much less important than the fact that a very large proportion of the rocks of the earth's crust contain more or less iron, and therefore are potential iron ores.

52. *What Constitutes an Iron Ore.*—Whether a ferruginous rock is or is not ore is purely a question of current demand and supply. That is ore from which there is reasonable hope that metal can be extracted with profit, if not to-day, then within a reasonable length of time. Rock containing  $\frac{2}{3}$  of gold is an extraordinarily rich gold ore; that with  $\frac{2}{3}$  of copper is a profitable one to-day; that containing  $\frac{1}{2}$  of iron is not so to-day, for the sole reason that its iron cannot be extracted with profit in competition with the existing richer ores. But it will become a profitable ore as soon as the richer ore shall have been exhausted. Very few of the ores which are mined to-day contain less than 25% of iron, and some of them contain over 60%. As these richest ores are exhausted, poorer and poorer ones will be used, and the cost of iron will increase progressively if measured either in units of the actual energy used in mining

and smelting it, or in its power of purchasing animal and vegetable products, cotton, wool, corn, &c., the supply of which is renewable and indeed capable of very great increase, but probably not if measured in its power of purchasing the various mineral products, e.g. the other metals, coal, petroleum and the precious stones, of which the supply is limited. This is simply one instance of the inevitable progressive increase in cost of the irreplaceable mineral relatively to the recreatable animal and vegetable. When, in the course of centuries, the exhaustion of richer ores shall have forced us to mine, crush and concentrate mechanically or by magnetism the ores which contain only 2 or 3% of iron, then the cost of iron in the ore, measured in terms of the energy needed to mine and concentrate it, will be comparable with the actual cost of the copper in the ore of the copper-mines of to-day. But, intermediate in richness between two extremes, the iron ores mined to-day and these 2 and 3% ores, there is an incalculably great quantity of ore capable of mechanical concentration, and another perhaps vaster store of ore which we do not yet know how to concentrate mechanically, so that the day when a pound of iron in the ore will cost as much as a pound of copper in the ore costs to-day is immeasurably distant.

53. *Future Cost of Ore.*—The cost of iron ore is likely to rise much less rapidly than that of coal, because the additions to our known supply are likely to be very much greater in the case of ore than in that of coal, for the reason that, while rich and great iron ore beds may exist anywhere, those of coal are confined chiefly to the Carboniferous formation, a fact which has led to the systematic survey and measurement of this formation in most countries. In short, a very large part of the earth's coal supply is known and measured, but its iron ore supply is hardly to be guessed. On the other hand, the cost of iron ore is likely to rise much faster than that of the potential aluminium ores, clay and its derivatives, because of the vast extent and richness of the deposits of this latter class. It is possible that, at some remote day, aluminium, or one of its alloys, may become the great structural material, and iron be used chiefly for those objects for which it is especially fitted, such as magnets, springs and cutting tools.

In passing, it may be noted that the cost of the ore itself forms a relatively small part of the cost even of the crude forms of steel, hardly a quarter of the cost of such simple products as rails, and an insignificant part of the cost of many most important finished objects, such as magnets, cutting tools, springs and wire, for which iron is almost indispensable. Thus, if the use of ores very much poorer than those we now treat, and the need of concentrating them mechanically, were to double the cost of a pound of iron in the concentrated ore ready for smelting, that would increase the cost of rails by only one quarter. Hence the addition to the cost of finished steel objects which is due to our being forced to use progressively poorer and poorer ores is likely to be much less than the addition due to the progressive rise in the cost of coal and in the cost of labour, because of the ever-rising scale of living. The effect of each of these additions will be lessened by the future improvements in processes of manufacture, and more particularly by the progressive replacement of that ephemeral source of energy, coal, by the secular sources, the wind, waves, tides, sunshine, the earth's heat and, greatest of all, its momentum.

54. *Ore Supply of the Chief Iron-making Countries.*—The United States mine nearly all of their iron ores, Austria-Hungary, Russia and France mine the greater part of theirs, but none of these countries exports much ore. Great Britain and Germany, besides mining a great deal of ore, still have to import much from Spain, Sweden and in the case of Germany from Luxemburg, although, because of the customs arrangement between these last two countries, this importation is not usually reported. Belgium imports nearly all of its ore, while Sweden and Spain export most of the ore which they mine.

55. *Great Britain* has many valuable ore beds, some rich in iron, many of them near to beds of coal and to the sea-coast, to canals or to navigable rivers. They extend from Northamptonshire to near Glasgow. About two-thirds of the ore mined is clayey siderite. In 1905 the Cleveland district in North Yorkshire supplied 41% of the total British product of iron ores; Lincolnshire, 14.8%; Northamptonshire, 13.9%; Leicestershire, 4.7%; Cumberland, 8.6%; North Lancashire, 2.7%; Staffordshire, 6.1%; and Scotland, 5.7%. The annual production of British iron ore reached 18,031,957 tons in 1882, but in 1905 it had fallen to 14,590,703 tons,

valued at £3,482,184. In addition 7,344,786 tons, or about half as much as was mined in Great Britain, were imported, 78.5% of it from Spain. The most important British ore deposit is the Lower Cleveland bed of oolitic siderite in the Middle Lias, near Middlesbrough. It is from 10 to 17 ft. thick, and its ore contains about 30% of iron.

56. *Geographical Distribution of the British Works.*—Most of the British iron works lie in and near the important coal-fields in Scotland between the mouth of the Clyde and the Forth, in Cleveland and Durham, in Cumberland and Lancashire, in south Yorkshire, Derbyshire, and Lincolnshire, in Staffordshire and Northamptonshire, and in south Wales in spite of its lack of ore.

The most important group is that of Cleveland and Durham, which makes about one-third of all the British pig iron. It has the great Cleveland ore bed and the excellent Durham coal near Middlesbrough. The most important seat of the manufacture of cutlery and the finer kinds of steel is at Sheffield.

57. *The United States* have great deposits of ore in many different places. The rich beds near Lake Superior, chiefly red haematite, yielding at present about 55% of iron, are brought to contain between 13 and 2 billion tons, and the red and brown haematites of the southern states about 10 billion tons. The middle states, New York, New Jersey and Pennsylvania, are known to have many great deposits of rich magnetite, which supplied a very large proportion of the American ores till the discovery of the very cheaply mined ores of Lake Superior. In 1906 these latter formed 80% of the American production, and the southern states supplied about 13% of it, while the rich deposits of the middle states are hurriedly being abandoned as their ore bodies are drawn on in the order of their apparent profitability.

The most important American iron-making district is in and about Pittsburg, to whose cheap coal the rich Lake Superior ores are brought nearly 1000 m., about four-fifths of the distance in the large ore steamers of the Great Lakes. Chicago, nearer to the Lake ores, though rather far from the Pittsburg coal-field, is a very important centre for rail-making for the railroads of the western states. Ohio, the Erie end of the New York works, eastern Pennsylvania and Maryland have important works, the ore for which comes in part from Lake Superior and in part from Pennsylvania, New York and Cuba, and the fuel from Pennsylvania and its neighbourhood. Tennessee and Alabama in the south rely on southern ore and fuel.

58. *Germany* gets about two-thirds of her total ore supply from the great Jurassic "Minette" ore deposit of Luxemburg and Lorraine, which reaches also into France and Belgium. In spite of its containing only about 36% of iron, it is very great value because of its great size, and of the consequent small cost of mining. It stretches through an area of about 8 m. wide and 40 m. long, and in some places it is nearly 60 ft. thick. There are valuable deposits also in Siegerland and in many other parts of the country.

59. *Sweden* has abundant, rich and very pure iron ores, but her lack of coal has restricted her iron manufacture chiefly to the very purest and best classes of iron and steel, in making which her thrifty and intelligent people have developed very rare skill. The magnetic ore bodies which supply this industry lie in a band about 180 m. long, reaching from a little north of Stockholm westerly toward the Norwegian frontier, between the latitudes 59° and 61° N. In Swedish Lapland, near the Arctic circle, are the great Gellivara, Kirunavara and Luossavara magnetite beds, among the largest in Europe. From these beds, which in some parts are about 300 ft. thick, much ore is sent to Germany and Great Britain.

60. *Other Countries.*—Spain has large, rich and pure iron ore beds, near both her northern and her southern sea coast. She exports about 90% of all the iron ore which she mines, most of it to England. France draws most of her iron ore from her own part of the great Minette ore deposit, and from those parts of it which were taken from her when she lost Alsace and Lorraine. Russia's most valuable ore deposit is the very large and easily mined one of Krivoi Rog in the south, from which comes also the largest Russian iron ore. It is near the Donetz coal-field, the largest in Europe. There are also important ore beds in the Urals, near the border of Finland, and at the south of Moscow. In Austria-Hungary, besides the famous Styrian Erzberg, with its siderite ore bed about 450 ft. thick, there are cheaply mined but poor and impure ores near Prague, and important ore beds in both northern and southern Hungary. Algeria, Canada, Cuba and India have valuable ore bodies.

61. *Richness of Iron Ores.*—The most European ores now mined are decidedly richer than those of most American countries. To make a ton of pig iron needs only about 1.9 tons of ore in the United States, 2 tons in Sweden and Russia, 2.4 tons in Great Britain and Germany, and about 2.7 tons in France and Belgium, while about 3 tons of the native British ores are needed per ton of pig iron.

62. *The general scheme of iron manufacture* is shown diagrammatically in fig. 6. To put the iron contained in iron ore into a state in which it can be used as a metal requires essentially, first its deoxidation, and second its separation from the other mineral matter, such as clay, quartz, &c., with which it is found associated. These two things are done simultaneously by heating

and melting the ore in contact with coke, charcoal or anthracite, in the iron blast furnace, from which issue intermittently two molten streams, the iron now deoxidized and incidentally carburized by the fuel with which it has been in contact, and the mineral matter, now called "slag." This crude cast iron, called "pig iron," may be run from the blast furnace directly

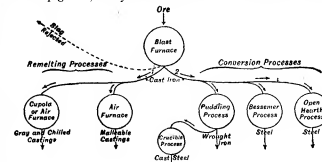

FIG. 6.—General Scheme of Iron Manufacture.

into moulds, which give the metal the final shape in which it is to be used in the arts; but it is almost always either remelted, following path 1 of fig. 6, and then cast into castings of cast iron, or converted into wrought iron or steel by purifying it, following path 2.

If it is to follow path 1, the castings into which it is made may be either (a) grey or (b) chilled or (c) malleable. Grey iron castings are made by remelting the pig iron either in a small shaft or "cupola" furnace, or in a reverberatory or "air" furnace, with very little change of chemical composition, and then casting it directly into suitable moulds, usually of either "baked," i.e. oven-dried, or "green," i.e. moist undried, sand, but sometimes of iron covered with a refractory coating to protect it from being melted or overheated by the molten cast iron. The general procedure in the manufacture of chilled and of malleable castings has been described in §§ 30 and 31.

If the pig iron is to follow path 2, the purification which converts it into wrought iron or steel consists chiefly in oxidizing and thereby removing its carbon, phosphorus and other impurities, while it is molten, either by means of the oxygen of atmospheric air blown through it as in the Bessemer process, or by the oxygen of iron ore stirred into it as in the puddling and Bell-Krupp processes, or by both together as in the open hearth process.

On its way from the blast furnace to the converter or open hearth furnace the pig iron is often passed through a great reservoir called a "mixer," which acts also as an equalizer, to lessen the variation in composition of the cast iron, and as a purifier, removing part of the sulphur and silicon.

63. *Shaping and Adjusting Processes.*—Besides these extraction and purification processes there are those of adjustment and shaping. The *adjusting processes* adjust either the ultimate composition, e.g. carburizing wrought iron by long heating in contact with charcoal (cementation), or the proximate composition or constitution, as in the hardening, tempering and annealing of steel already described (§§ 28, 29), or both, as in the process of making malleable cast iron (§ 31). The *shaping processes* include the *mechanical* ones, such as rolling, forging and wire-drawing, and the *remelting* ones such as the crucible process of melting wrought iron or steel in crucibles and casting it in ingots for the manufacture of the best kinds of tool steel. Indeed, the remelting of cast iron to make grey iron castings belongs here. This classification, though it helps to give a general idea of the subject, yet like most of its kind cannot be applied rigidly. Thus the crucible process in its American form both carburizes and remelts, and the open hearth process is often used rather for remelting than for purifying.

64. *The iron blast furnace*, a crude but very efficient piece of apparatus, is an enormous shaft usually about 80 ft. high and 20 ft. wide at its widest part. It is at all times full from top to bottom, somewhat as sketched in figs. 7 and 8, of a solid column of lumps of fuel, ore and limestone, which are charged through a hopper at the top, and descend slowly as the lower end of the column is eaten off through the burning away of its coke by means of very hot air or "blast" blown through

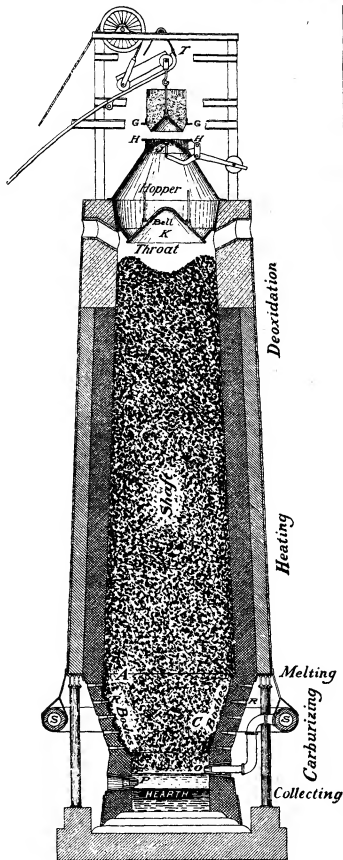

FIG. 7.—Section of Duquesne Blast Furnace.

- |  |   |
|--|---|
| GG, Flanges on the ore bucket;               | P, Cinder notch;  |
| HH, Fixed flanges on the top of the furnace; | RR', Water cooled boxes;                                |
| J, Counterweighted false bell;               | S, Blast pipe;  |
| K, Main bell;                                | T, Cable for allowing conical bottom of bucket to drop. |
| O, Tuyere;                                   |   |

holes or "tuyeres" near the bottom or "hearth," and through the melting away, by the heat thus generated, both of the iron itself which has been deoxidized in its descent, and of the other minerals of the ore, called the "gangue," which unite with the

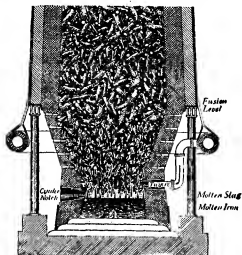

FIG. 8.—Lower Part of the Blast Furnace.

- |                         |                            |
|-------------------------|----------------------------|
| Lumps of Coke .....     | Drops of Slag .....        |
| Lumps of Iron Ore ..... | Drops of Iron .....        |
| Lumps of Lime .....     | Layer of Molten Slag ..... |
|                         | Layer of Molten Iron ..... |

\* The ore and lime actually exist here in powder. They are shown in lump form because of the difficulty of presenting to the eye their powdered state.

lime of the limestone and the ash of the fuel to form a complex molten silicate called the "cinder" or "slag."

Interpenetrating this descending column of solid ore, limestone and coke, there is an upward rushing column of hot gases, the atmospheric nitrogen of the blast from the tuyeres, and the

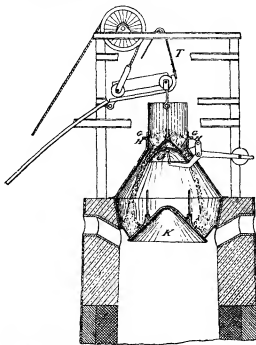

FIG. 9.—Method of transferring charge from bucket to main charging bell, without permitting escape of furnace gas (lettering as in fig. 7).

carbonic oxide from the combustion of the coke by that blast. The upward ascent of the column of gases is as swift as the descent of the solid charge is slow. The former occupies but a very few seconds, the latter from 12 to 15 hours.

In the upper part of the furnace the carbonic oxide deoxidizes the iron oxide of the ore by such reactions as  $xCO + FeO_x = Fe + xCO_2$ . Part of the resultant carbonic acid is again deoxidized to carbonic oxide by the surrounding fuel,  $CO_2 + C = 2CO$ , and the carbonic oxide thus formed deoxidizes more iron oxide, &c. As indicated in fig. 7, before the iron ore has descended very far it has given up nearly the whole of its oxygen, and thus lost its power of oxidizing the rising carbonic oxide, so that from here down the atmosphere of the furnace consists essentially of carbonic oxide and nitrogen.

But the transfer of heat from the rising gases to the sinking solids, which has been going on in the upper part of the furnace, continues as the solid column gradually sinks downward to the hearth, till at the "fusion level" (A in fig. 7) the solid matter has become so hot that the now deoxidized iron melts, as does the slag as fast as it is formed by the union of its three constituents, the gangue, the lime resulting from the decomposition of the limestone and the ash of the fuel. Hence from this level down the only solid matter is the coke, in lumps which are burning rapidly and hence shrinking, while between them the molten iron and slag trickle, somewhat as sketched in fig. 8, to collect in the hearth in two layers as distinct as water and oil, the iron below, the slag above.

As they collect, the molten iron is drawn off at intervals through a hole A (fig. 8), temporarily stopped with clay, at the very bottom, and the slag through another hole a little higher up, called the "cinder notch." Thus the furnace may be said to have four zones, those of (1) deoxidation, (2) heating, (3) melting, and (4) collecting, though of course the heating is really going on in all four of them.

In its slow descent the deoxidized iron nearly saturates itself with carbon, of which it usually contains between 3.5 and 4%, taking it in part from the fuel with which it is in such intimate contact, and in part from the finely divided carbon deposited within the very lumps of ore, by the reaction  $2CO = C + CO_2$ . This carburizing is an indispensable part of the process, because through it alone can the iron be made fusible enough to melt at the temperature which can be generated in the furnace, and only when liquid can it be separated readily and completely from the slag. In fact, the molten iron is heated so far above its melting point that, instead of being run at once into pigs as is usual, it may, without solidifying, be carried even several miles in large clay-lined ladles to the mill where it is to be converted into steel.

65. The *fuel* has, in addition to its duties of deoxidizing and carburizing the iron and yielding the heat needed for melting both the iron and slag, the further task of desulphurizing the iron, probably by the reaction  $FeS + CaO + C = Fe + CaS + CO$ .

The desulphurizing effect of this transfer of the sulphur from union with iron to union with calcium is due to the fact that, whereas iron sulphide dissolves readily in the molten metallic iron, calcium sulphide, in the presence of a slag rich in lime, does not, but by preference enters the slag, which may thus absorb even as much as 3% of sulphur. This action is of great importance whether the metal is to be used as cast iron or is to be converted into wrought iron or steel. In the former case there is no later chance to remove sulphur, a minute quantity of which does great harm by leading to the formation of cementite instead of graphite and ferrite, and thus making the cast-iron castings too hard to be cut to exact shape with steel tools; in the latter case the converting or purifying processes, which are essentially oxidizing ones, though they remove the other impurities, carbon, silicon, phosphorus and manganese, are not well adapted to desulphurizing, which needs rather deoxidizing conditions, so as to cause the formation of calcium sulphide, than oxidizing ones.

66. The *duty of the limestone* ( $CaCO_3$ ) is to furnish enough lime to form with the gangue of the ore and the ash of the fuel a lime silicate or slag of such a composition (1) that it will melt at the temperature which it reaches at about level A, of fig. 7, (2) that it will be fluid enough to run out through the cinder notch, and (3) that it will be rich enough in lime to supply that needed for the desulphurizing reaction  $FeS + CaO + C = Fe + CaS + CO$ . In short, its duty is to "flux" the gangue and ash, and wash out the sulphur.

67. In order that the *slag* shall have these properties its composition usually lies between the following limits: silica, 26 to 35%; lime, plus 1.4 times the magnesia, 45 to 55%; alumina, 5 to 20%. Of these the silica and alumina are chiefly those which the gangue of the ore and the ash of the fuel introduce, whereas the lime is that added intentionally to form with these others a slag of the needed physical properties.

Thus the more gangue the ore contains, *i.e.* the poorer it is in iron, the more limestone must in general be added, and hence the more slag results, though of course an ore the gangue of which initially contains much lime and little silica needs a much smaller addition of limestone than one of which the gangue is chiefly silica. Further, the more sulphur there is to remove, the greater must be the quantity of slag needed to dissolve it as calcium sulphide. In smelting the rich Lake Superior ores the quantity of slag made was formerly as small as 28% of that of the pig iron, whereas in smelting the Cleveland ores of Great Britain it is usually necessary to make as much as 1½ tons of slag for each ton of iron.

68. *Shape and Size of the Blast-Furnace.*—Large size has here, as in most metallurgical operations, not only its usual advantage of economy of installation, labour and administration per unit of product, but the further very important one that it lessens the proportion which the outer heat-radiating and hence heat-wasting surface bears to the whole. The limits set to the furnace builder's natural desire to make his furnace as large as possible, and its present shape (an obtuse inverted cone set below an acute upright one, both of them truncated), have been reached in part empirically, and in part by reasoning which is open to question, as indeed are the reasons which will now be offered reserverly for both size and shape.

First the width at the tuyeres (fig. 7) has generally been limited to about 12½ ft. by the fear that, if it were greater, the blast would penetrate so feebly to the centre that the difference in conditions between centre and circumference would be so great as to cause serious unevenness of working. Of late furnaces have been built even as wide as 17 ft. in the heart, and it may prove that a width materially greater than 12½ ft. can profitably be used. With the width at the bottom thus limited, the furnace builder naturally tries to gain volume as rapidly as possible by flaring or "battering" his walls outwards, *i.e.* by making the "bosh" or lower part of his furnace an inverted cone as obtuse as is consistent with the free descent of the solid charge. In practice a furnace may be made to work regularly if its boshes make an angle of between 73° and 76° with the horizontal, and we may assume that one element of this regularity is the regular easy sliding of the charge over this steep slope. A still steeper one not only gives less available room, but actually leads to irregular working, perhaps because it unduly favours the passage of the rising gas along the walls instead of up and through the charge, and thus causes the deoxidation of the central core to lag behind that of the periphery of the column, with the consequence that this central core arrives at the bottom incompletely deoxidized.

In the very swift-running furnaces of the Pittsburg type this outward flare of the boshes ceases at about 12 ft. above the tuyeres, and is there reversed, as in fig. 7, so that the furnace above this is a very acute upright cone, the walls of which make an angle of about 4° with the vertical, instead of an obtuse inverted cone.

In explanation or justification of this it has been said that a much easier descent must be provided above this level than is needed below it. Below this level the solid charge descends easily, because it consists of coke alone or nearly alone, and this in turn because the temperature here is so high as to melt not only the iron now deoxidized and brought to the metallic state, but also the gangue of the ore and the limestone, which here unite to form the molten slag, and run freely down between the lumps of coke. This coke descends freely even through this fast-narrowing space, because it is perfectly solid and dry without a trace of pastiness. But immediately above this level the charge is relatively viscous, because here the temperature has fallen so far that it is now at the melting or formation point of the slag, which therefore is pasty, liable to weld the whole mass together as so much tar would, and thus to obstruct the descent of the charge, or in short to "scaffold."

The reason why at this level the walls must form an upright instead of an inverted cone, why the furnace must widen downward instead of narrowing, is, according to some metallurgists, that this

shape is needed in order that, in spite of the pastiness of the slag in this formative period of incipient fusion, this layer may descend freely as the lower part of the column is gradually eaten away. To this very plausible theory it may be objected that in many slow-running furnaces, which work very regularly and show no sign of scaffolding, the outward flare of the boshes continues (though steepened) far above this region of pastiness, indeed nearly half-way to the top of the furnace. This proves that the regular descent of the material in its pasty state can take place even in a space which is narrowing downwards. To this objection it may in turn be answered that, though this degree of freedom of descent may suffice for a slow-running furnace, particularly if the slag is given such a composition that it passes quickly from the solid state to one of decided fluidity, yet it is not enough for swift-running ones, especially if the composition of the slag is such that, in melting, it remains long in a very sticky condition. In limiting the diameter at the tuyeres to 124 ft., the height of the boshes to one which will keep their upper end below the region of pastiness, and their slope to one over which the burning coke will descend freely, we limit the width of the furnace at the top of the boshes and thus complete the outline of the lower part of the furnace.

The height of the furnace is rarely as great as 100 ft., and in the belief of many metallurgists it should not be much more than 80 ft. There are some very evident disadvantages of excessive height; for instance, that the weight of an excessively high column of solid coke, ore and limestone tends to crush the coke and jam the charge in the lower and narrowing part of the furnace, and that the frictional resistance of a long column calls for a greater consumption of power for driving the blast up through it. Moreover, this resistance increases much more rapidly than the height of the furnace, even if the rapidity with which the blast is forced through is constant; and it still further increases if the additional space gained by lengthening the furnace is made useful by increasing proportionally the rate of production, as indeed would naturally be done, because the chief motive for gaining this additional space is to increase production.

The reason why the frictional resistance would be further increased is the very simple one that the increase in the rate of production implies directly a corresponding increase in the quantity of blast forced through, and hence in the velocity of the rising gases, because the chemical work of the blast furnace needs a certain quantity of blast for each ton of iron made. In short, to increase the rate of production by lengthening the furnace increases the frictional resistance of the rising gases, both by increasing their quantity and hence their velocity and by lengthening their path.

Indeed, one important reason for the difficulties in working very high furnaces, e.g. those 100 ft. high, may be that this frictional resistance becomes so great as actually to interrupt the even descent of the charge, parts of which are at times suspended like a ball in the rising jet of a fountain, to fall perhaps with destructive violence when some shifting condition momentarily lessens the friction. We see how powerful must be the lifting effect of the rising gases when we reflect that their velocity in a 100 ft. furnace rapidly driven is probably at least as great as 2000 ft. per minute, or that of a "high wind." Conceive these gases passing at this great velocity through the narrow openings between the adjoining lumps of coke and ore. Indeed, the velocity must be far greater than this where the edge or corner of one lump touches the side of another, and the only room for the passage of this enormous quantity of gas is that left by the roughness and irregularity of the individual lumps.

The furnace is made rather narrow at the top or "stock line," in order that the entering ore, fuel and flux may readily be distributed evenly. But extreme narrowness would not only cause the escaping gases to move so swiftly that they would sweep needless work on the blowing engines by throttling back the rising gases, and would lessen unduly the space available for the charge in the upper part of the furnace.

From its top down, the walls of the furnace slope outward at an angle of between 3° and 8°, partly in order to ease the descent of the charge, here impeded by the swelling of the individual particles of ore caused by the deposition within them of great quantities of fine carbon, by the reaction of  $2CO = C + CO_2$ . To widen it more abruptly would indeed increase the volume of the furnace, but would probably lead to grave irregularities in the distribution of the gas and charge, and hence in the working of the furnace.

When we have thus fixed the height of the furnace, its diameter at its ends, and the slope of its upper and lower

parts, we have completed its outline closely enough for our purpose here.

**69. Hot Blast and Dry Blast.**—On its way from the blowing engine to the tuyeres of the blast-furnace, the blast, i.e. the air forced in for the purpose of burning the fuel, is usually pre-heated, and in some of the most progressive works is dried by Gayley's refrigerating process. These steps lead to a saving of fuel so great as to be astonishing at first sight—in case of Gayley's blast-drying process incredible to most writers, who proved easily and promptly to their own satisfaction that the actual saving was impossible. But the explanation is really so very simple that it is rather the incredulity of these writers that is astonishing. In the hearth of the blast furnace the heat made latent by the fusion of the iron and slag must of course be supplied by some body which is itself at a temperature above the melting point of these bodies, which for simplicity of exposition we may call the critical temperature of the blast-furnace process, because heat will flow only from a hotter to a cooler object. Much the same is true of the heat needed for the deoxidation of the silica,  $SiO_2 + 2C = Si + 2CO$ . Now the heat developed by the combustion of coke to carbonic oxide with cold air containing the usual quantity of moisture, develops a temperature only slightly above this critical point; and it is only the heat represented by this narrow temperature-margin that is available for doing this critical work of fusion and deoxidation. That is the crux of the matter. If by pre-heating the blast we add to the sum of the heat available; or if by drying it we subtract from the work to be done by that heat the quantity needed for decomposing the atmospheric moisture; or if by removing part of its nitrogen we lessen the mass over which the heat developed has to be spread—if by any of these means we raise the temperature developed by the combustion of the coke, it is clear that we increase the proportion of the total heat which is available for this critical work in exactly the way in which we should increase the proportion of the water of a stream, initially 100 in. deep, which should flow over a waste weir initially 1 in. beneath the stream's surface, by raising the upper surface of the water 10 in. and thus increasing the depth of the water to 110 in. Clearly this raising the level of the water by 10% increases tenfold, or by 100%, the volume of water which is above the level of the weir.

The special conditions of the blast-furnace actually exaggerate the saving due to this widening of the available temperature-margin, and beyond this drying the blast does great good by preventing the serious irregularities in working the furnace caused by changes in the humidity of the air with varying weather.

**70. Means of Heating the Blast.**—After the ascending column of gases has done its work of heating and deoxidizing the ore, it still necessarily contains so much carbonic oxide, usually between 20 and 26% by weight, that it is a very valuable fuel, part of which is used for raising steam for generating the blast itself and driving the rolling mill engines, &c., or directly in gas engines, and the rest for heating the blast. This heating was formerly done by burning part of the gases, after their escape from the furnace top, in a large combustion chamber, around a series of cast iron pipes through which the blast passed on its way from the blowing engine to the tuyeres. But these "iron pipe stoves" are fast going out of use, chiefly because they are destroyed quickly if an attempt is made to heat the blast above 1000° F. (538° C.), often a very important thing. In their place the regenerative stoves of the Whitwell and Cowper types (figs. 10 and 11) are used. With these the regular temperature of the blast at some works is about 1400° F. (760° C.), and the usual blast temperature lies between 900° and 1200° F. 480° and 650° C.).

Like the Siemens furnace, described in § 99, they have two distinct phases: one, "on gas," during which part of the waste gas of the blast-furnace is burnt within the stove, highly heating the great surface of brickwork which for that purpose is provided within it; the other, "on wind," during which the blast is heated by passing it back over these very surfaces which have thus been heated. They are heat-filters or heat-traps for



impounding the heat developed by the combustion of the furnace gas, and later returning it to the blast. Each blast-furnace is now provided with three or even four of these stoves, which collectively may be nearly thrice as large as the furnace itself. At any given time one of these is "on wind" and the others "on gas."

The Whitwell stove (fig. 10), by means of the surface of several fire-brick walls, catches in one phase the heat evolved by the burning gas as it sweeps through, and in the other phase returns that heat to the entering blast as it sweeps through from left to right. In the original Whitwell stove, which lacks the chimneys shown at the top of fig. 10, both the burning gas and the blast pass up and down repeatedly. In the H. Kennedy modification, shown in fig. 10, the gas and air in one phase enter at the bottom of all three of the large vertical chambers, burn in passing upwards, and escape at once at the top, as shown by the broken arrows. In the other phase the cold blast, forced in at A, passes four times up and down, as shown by the unbroken arrows, and escapes as hot blast at B. This, then, is a "one-pass" stove when on gas but a "four-pass" one when on wind.

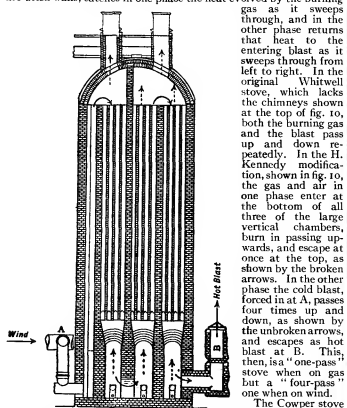

The Cowper stove (fig. 11) differs from the Whitwell (1) in having not a series of flat smooth walls, but a great number of narrow vertical flues, E, for the alternate absorption and emission of the heat, with the consequence that, for given outside dimensions, it offers about one-half more heating surface than the true Whitwell stove; and (2) in that the gas and the blast pass only once up and once down through it, instead of twice up and twice down as in the modern true Whitwell stoves. As regards frictional resistance, this smaller number of reversals of direction compensates in a measure for the smaller area of the Cowper flues. The large combustion chamber B permits thorough combustion of the gas.

71. Preservation of the Furnace Walls.—The combined fluxing and abrading action of the descending charge tends to wear away the lining of the furnace where it is hottest, which of course is near its lower end, thus changing its shape materially, lessening its efficiency, and in particular increasing its consumption of fuel. The walls, therefore, are now made thin, and are thoroughly cooled by water, which circulates through pipes or boxes bedded in them. James Gayley's method of cooling, shown in fig. 7, is to set in the brick-work walls several horizontal rows of flat water-cooled bronze boxes, RR', extending nearly to the interior of the furnace, and tapered so that they can readily be withdrawn and replaced in case they burn through. The brick-work may wear back to the front edges of these boxes, or even, as is shown at R', a little farther. But in the latter case their edges still determine the effective profile of the furnace walls because the depressions at the back of these edges become filled

with carbon and scoriaceous matter when the furnace is in normal working. Each of these rows, of which five are shown in fig. 7, consists of a great number of short segmental boxes.

72. Blast-Furnace Gas Engines.—When the gas which escapes from the furnace top is used in gas engines it generates about four times as much power as when it is used for raising steam. It has been calculated that the gas from a pair of old-fashioned blast-furnaces making 1600 tons of iron per week would in this way yield some 16,000 horse-power in excess of their own needs, and that all the available blast-furnace gas in the United States would develop about 1,500,000 horse-power, to develop which by raising steam would need about 20,000,000 tons of coal a year. Of this power about half would be used at the blast-furnaces themselves, leaving 750,000 horse-power available for driving the machinery of the rolling mills, &c.

This use of the gas engine is likely to have far-reaching results. In order to utilize this power, the converting mill, in which the pig iron is converted into steel, and the rolling mills must adjoin the blast-furnace. The numerous converting mills which treat pig iron made at a distance will now have the crushing burden of providing in other ways the power which their rivals get from the blast-furnace, in addition to the severe disadvantage under which they already suffer, of wasting the initial heat of the molten cast iron as it runs from the blast-furnace. Before its use in the gas engine, the blast-furnace gas has to be freed carefully from the large quantity of fine ore dust which it carries in suspension.

73. Mechanical Appliances.—Moving the raw materials and the products: In order to move economically the great quantity of materials which enter and issue from each furnace daily, mechanical appliances have at many works displaced hand labour wholly, and indeed that any of the materials should be shovelled by hand is not to be thought of in designing new works.

The arrangement at the Carnegie Company's Duquesne works (fig. 12) may serve as an example of modern methods of handling. The standard-gauge cars which bring the ore and coke to Duquesne pass over one of three very long rows of bins, A, B, and C, (fig. 12), of which A and B receive the materials (ore, coke and limestone)

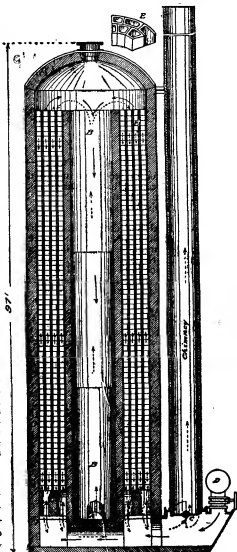

FIG. 11.—Diagram of Cowper Hot-Blast Stove at Duquesne. (After J. Kennedy.) Broken arrows show the path of the gas and air while the stove is "on gas," and solid arrows that of the blast while it is "on wind."

- A, Entrance for blast-furnace gas.
- B, Combustion chamber.
- C, Chimney valve.
- D, Cold blast main.
- E, Hollow bricks.

for immediate use, while C receives those to be stored for winter use. From A and B the materials are drawn as they are needed into large buckets D standing on cars, which carry them to the foot of the hoist track EE, up which they are hoisted to the top of the furnace. Arrived here, the material is introduced into the furnace by an ingenious piece of mechanism which completely prevents the furnace gas from escaping into the air. The hoist-engineer in the house F at the foot of the furnace, when informed by means of an indicator that the bucket has arrived at the top, lowers it so that its flanges GG (fig. 7) rest on the corresponding fixed flanges HH, as shown in fig. 9. The farther descent of the bucket being thus arrested, the special cable T is now slackened, so that the conical bottom of the bucket drops down, pressing down by its weight the

string of moulds, each thus containing a pig, moves slowly forward, the pigs solidify and cool, the more quickly because in transit they are sprayed with water or even submerged in

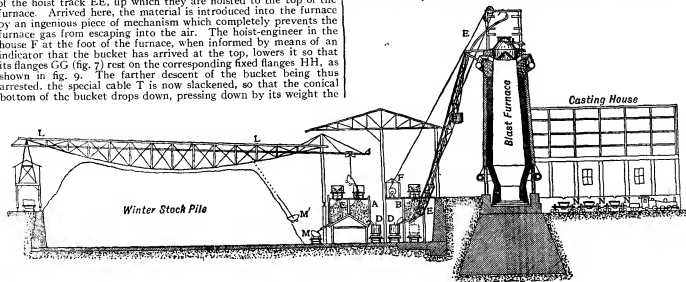

FIG. 12.—Diagram of the Carnegie Blast-Furnace Plant at Duquesne, Pa.

- A and B, Bins for stock for immediate use. F, Hoist-engine house.  
 C, Receiving bin for winter stock pile. LL, Travelling crane commanding stock pile.  
 D, Ore bucket. M, Ore bucket receiving ore for stock pile.  
 EE, Hoist-track. M', Bucket removing ore from stock pile.

N, N, N, Ladles carrying the molten cast iron to the works, where it is converted into steel by the open hearth process.

counter-weighted false cover J of the furnace, so that the contents of the bucket slide down into the space between this false cover and the true charging bell, K. The special cable T is now tightened again, and lifts the bottom of the bucket so as both to close it and to close the space between J and K, by allowing J to rise back to its initial place. The bucket then descends along the hoist-track to make way for the next succeeding one, and K is lowered, dropping the charge into the furnace. Thus some 1700 tons of materials are charged daily into each of these furnaces without being shovelled at all, running by gravity from bin to bucket and from bucket to furnace, and being hoisted and charged into the furnace by a single engineer below, without any assistance or supervision at the furnace-top.

The winter stock of materials is drawn from the left-hand row of bins, and distributed over immense stock piles by means of the

water in the tank EE. Arrived at the farther sheave C, the now cool pigs are dumped into a railway car.

Besides a great saving of labour, only partly offset by the cost of repairs, these machines have the great merit of making the management independent of a very troublesome set of labourers, the hand pig-breakers, who were not only absolutely indispensable for every cast and every day, because the pig iron must be removed promptly to make way for the next succeeding cast of iron, but very difficult to replace because of the great physical endurance which their work requires.

#### 75. Direct Processes for making Wrought Iron and Steel.—The

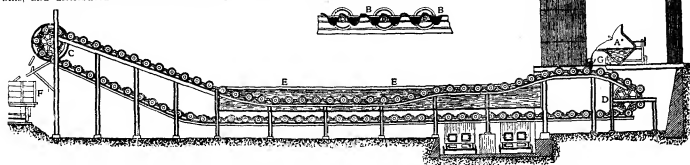

FIG. 13.—Diagram of Pig-Casting Machine.

- A, Ladle bringing the cast iron from the blast-furnace.  
 BB, The moulds.  
 C, D, Sheaves carrying the endless chain of moulds.

- EE, Tank in which the moulds are submerged.  
 F, Car into which the cooled pigs are dropped.  
 G, Distributing funnel.

great crane LL (fig. 12), which transfers it as it is needed to the row A of bins, whence it is carried to the furnace, as already explained.

74. *Casting the Molten Pig Iron.*—The molten pig iron at many works is still run directly from the furnace into sand or iron moulds arranged in a way which suggests a nursing litter of pigs; hence the name "pig iron." These pigs are then usually broken by hand. The Uehling casting machine (fig. 13) has displaced this method in many works. It consists essentially of a series of thin-walled moulds, BB, carried by endless chains past the lip of a great ladle A. This pours into them the molten cast iron which it has just received directly from the blast-furnace. As

present way of getting the iron of the ore into the form of wrought iron and steel by first making cast iron and then purifying it, i.e. by first putting carbon and silicon into the iron and then taking them out again at great expense, at first sight seems so unreasonably roundabout that many "direct" processes of extracting the iron without thus charging it with carbon and silicon have been proposed, and some of them have at times been important. But to-day they have almost ceased to exist.

That the blast-furnace process must be followed by a purifying one, that carburization must at once be undone by decarburization, is clearly a disadvantage, but it is one which is far outweighed by five important incidental advantages. (1) The strong deoxidizing

action incidental to this carburizing removes the sulphur easily and cheaply, a thing hardly to be expected of any direct process so far as we can see. (2) The carburizing incidentally carburizes the brickwork of the furnace, and thus protects it against corrosion by the molten slag. (3) It protects the molten iron against reoxidation, the greatest stumbling block in the way of the direct processes hitherto. (4) This same strong deoxidizing action leads to the practically complete deoxidation and hence extraction of the iron. (5) In that carburizing lowers the melting point of the iron greatly, it lowers somewhat the temperature to which the mineral matter of the ore has to be raised in order that the iron may be separated from it, because this separation requires that both iron and slag shall be very fluid. Indeed, few if any of the direct processes have attempted to make this separation, or to make it complete, leaving it for some subsequent operation, such as the open hearth process.

In addition, the blast-furnace uses a very cheap source of energy, coke, anthracite, charcoal, and even certain kinds of raw bituminous coal, and owing first to the intimacy of contact between this fuel and the ore on which it works, and second to the thoroughness of the transfer of heat from the products of that fuel's combustion in their long upward journey through the descending charge, even this cheap energy is used most effectively.

Thus we have reasons enough why the blast-furnace has displaced all competing processes, without taking into account its further advantage in lending itself easily to working on an enormous scale and with trifling consumption of labour, still further lessened by the general practice of transferring the molten cast iron in enormous ladles into the vessels in which its conversion into steel takes place. Nevertheless, a direct process may yet be made profitable under conditions which specially favour it, such as the lack of any fuel suitable for the blast-furnace, coupled with an abundance of cheap fuel suitable for a direct process and of cheap rich ore nearly free from sulphur.

76. The chief difficulty in the way of modifying the blast-furnace process itself so as to make it accomplish what the direct processes aim at, by giving its product less carbon and silicon than pig iron as now made contains, is the removal of the sulphur. The processes for converting cast iron into steel can now remove phosphorus easily, but the removal of sulphur in them is so difficult that it has to be accomplished for the most part in the blast-furnace itself. As desulphurizing seems to need the direct and energetic action of carbon on the molten iron itself, and as molten iron absorbs carbon most greedily, it is hard to see how the blast-furnace is to desulphurize without carburizing almost to saturation, *i.e.* without making cast iron.

77. *Direct Metal and the Mixer.*—Until relatively lately the cast iron for the Bessemer and open-hearth processes was nearly always allowed to solidify in pigs, which were next broken up by hand and remelted at great cost. It has long been seen that there would be a great saving if this remelting could be avoided and "direct metal," *i.e.* the molten cast iron direct from the blast-furnace, could be treated in the conversion process. The obstacle is that, owing to unavoidable irregularities in the blast-furnace process, the silicon- and sulphur-content of the cast iron vary to a degree and with an abruptness which are inconvenient for any conversion process and intolerable for the Bessemer process. For the acid variety of this process, which does not remove sulphur, this most harmful element must be held below a limit which is always low, though it varies somewhat with the use to which the steel is to be put. Further, the point at which the process should be arrested is recognized by the appearance of the flame which issues from the converter's mouth, and variations in the silicon-content of the cast iron treated alter this appearance, so that the indications of the flame become confusing, and control over the process is lost. Moreover, the quality of the resultant steel depends upon the temperature of the process, and this in turn depends upon the proportion of silicon, the combustion of which is the chief source of the heat developed. Hence the importance of having the silicon-content constant. In the basic Bessemer process, also, unforeseen variations in the silicon-content are harmful, because the quantity of lime added should be just that needed to neutralize the resultant silica and the phosphoric acid and no more. Hence the importance of having the silicon-content uniform. This uniformity is now given by the use of the "mixer" invented by Captain W. R. Jones.

This "mixer" is a great reservoir into which successive lots of molten cast iron from all the blast-furnaces available are poured, forming a great molten mass of from 200 to 750 tons.

This is kept molten by a flame playing above it, and successive lots of the cast iron thus mixed are drawn off, as they are needed, for conversion into steel by the Bessemer or open-hearth process. An excess of silicon or sulphur in the cast iron from one blast-furnace is diluted by thus mixing this iron with that from the other furnaces. Should several furnaces simultaneously make iron too rich in silicon, this may be diluted by pouring into the mixer some low-silicon iron melted for this purpose in a cupola furnace. This device not only makes the cast iron much more uniform, but also removes much of its sulphur by a curious slow reaction. Many metals have the power of dissolving their own oxides and sulphides, but not those of other metals. Thus iron, at least highly carburized, *i.e.* cast iron, dissolves its own sulphide freely, but not that of either calcium or manganese. Consequently, when we deoxidize calcium in the iron blast-furnace, it greedily absorbs the sulphur which has been dissolved in the iron as iron sulphide, and the sulphide of calcium thus formed separates from the iron. In like manner, if the molten iron in the mixer contains manganese, this metal unites with the sulphur present, and the manganese sulphide, insoluble in the iron, slowly rises to the surface, and as it reaches the air, its sulphur oxidizes to sulphurous acid, which escapes. Further, an important part of the silicon may be removed in the mixer by keeping it very hot and covering the metal with a rather basic slag. This is very useful if the iron is intended for either the basic Bessemer or the basic open-hearth process, for both of which this silicon is harmful.

78. *Conversion or Purifying Processes for converting Cast Iron into Steel or Wrought Iron.*—As the essential difference between cast iron on one hand and wrought iron and steel on the other is that the former contains necessarily much more carbon, usually more silicon, and often more phosphorus that are suitable or indeed permissible in the latter two, the chief work of all these conversion processes is to remove the excess of these several foreign elements by oxidizing them to carbonic oxide CO, silica SiO<sub>2</sub>, and phosphoric acid P<sub>2</sub>O<sub>5</sub>, respectively. Of these the first escapes immediately as a gas, and the others unite with iron oxide, lime, or other strong base present to form a molten silicate or silico-phosphate called "cinder" or "slag," which floats on the molten or paste metal. The ultimate source of the oxygen may be the air, as in the Bessemer process, or rich iron oxide as in the puddling process, or both as in the open-hearth process; but in any case iron oxide is the chief immediate source, as is to be expected, because the oxygen of the air would naturally unite in much greater proportion with some of the great quantity of iron offered to it than with the small quantity of these impurities. The iron oxide thus formed immediately oxidizes these foreign elements, so that the iron is really a carrier of oxygen from air to impurity. The typical reactions are something like the following:  $Fe_2O_3 + 4C = 4CO + 3Fe$ ;  $Fe_2O_3 + C = 3FeO + CO$ ;  $2P + 5Fe_2O_3 = 12FeO + 3FeO_3P_2O_5$ ;  $Si + 2Fe_2O_3 = 3FeO + SiO_2 + 3FeO$ . Beside this their chief and easy work of oxidizing carbon, silicon and phosphorus, the conversion processes have the harder task of removing sulphur, chiefly by converting it into calcium sulphide, CaS, or manganese sulphide, MnS, which rise to the top of the molten metal and there enter the overlying slag, from which the sulphur may escape by oxidizing to the gaseous compound, sulphurous acid, SO<sub>2</sub>.

79. In the *puddling process* molten cast iron is converted into wrought iron, *i.e.* low-carbon slag-bearing iron, by oxidizing its carbon, silicon and phosphorus, by means of iron oxide stirred into it as it lies in a thin shallow layer in the "hearth" or flat basin of a reverberatory furnace (fig. 14), itself lined with iron ore. As the iron oxide is stirred into the molten metal laboriously by the workman or "puddler" with his hook or "rabble," it oxidizes the silicon to silica and the phosphorus to phosphoric acid, and unites with both these products, forming with them a basic iron silicate rich in phosphorus, called "puddling" or "tap cinder." It oxidizes the carbon also, which escapes in purple jets of burning carbonic oxide. As the melting point of the metal is gradually raised by the progressive decarburization, it at length passes above the temperature of the furnace, about

1400° C., with the consequence that the metal, now below its melting point, solidifies in pasty grains, or "comes to nature." These grains the puddler welds together by means of his rabble

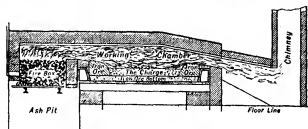

FIG. 14.—Puddling Furnace.

into rough 80-lb balls, each like a sponge of metallic iron particles with its pores filled with the still molten cinder. These balls are next worked into merchantable shape, and the cinder is simultaneously expelled in large part, first by hammering them one at a time under a steam hammer (fig. 37) or by squeezing them, and next by rolling them. The squeezing is usually done in the way shown in fig. 15.

Here BB is a large fixed iron cylinder, corrugated within, and C an excentric cylinder, also corrugated, which, in turning to the right, by the friction of its corrugated surface rotates the puddled ball D which has just entered at A, so that, turning around its own axis, it travels to the right and is gradually changed from a ball into a bloom, a rough cylindrical mass of white hot iron, still dripping with cinder. This bloom is immediately rolled down into a long flat bar, called "muck bar," and this in turn is cut into short lengths which, piled one on another, are reheated and again rolled down, sometimes with repeated cutting,

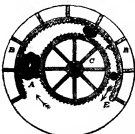

FIG. 15.—Plan of Burden's Excentric Revolving Squeezer for Puddled Balls.

and re-rolling, into the final shape in which it is actually to be used. But, roll and re-roll as often as we like, much cinder remains imbedded in the iron, in the form of threads and rods drawn out in the direction of rolling, and of course weakening the metal in the transverse direction.

80. *Machine Puddling.*—The few men who have, and are willing to exercise, the great strength and endurance which the puddler needs when he is stirring the pasty iron and balling it up, command such high wages, and with their little 500-lb charges turn out their iron so slowly, that many ways of puddling by machinery have been tried. None has succeeded permanently, though indeed one offered by J. P. Roe is not without promise. The essential difficulty has been that none of them could subdivide the rapidly solidifying charge into the small balls which the workman dexterously forms by hand, and that if the charge is not thus subdivided but drawn as a single ball, the cinder cannot be squeezed out of it thoroughly enough.

81. *Direct Puddling.*—In common practice the cast iron as it runs from the blast-furnace is allowed to solidify and cool completely in the form of pigs, which are then graded by their fracture, and remelted in the puddling furnace itself. At Hourpes, in order to save the expense of this remelting, the molten cast iron as it comes from the blast-furnace is poured directly into the puddling furnace, in large charges of about 2200 lb. which are thus about four times as large as those of common puddling furnaces. These large charges are puddled by two gangs of four men each, and a great saving in fuel and labour is effected.

Attractive as are these advances in puddling, they have not been widely adopted, for two chief reasons: First, owners of puddling works have been reluctant to spend money freely in plant for a process of which the future is so uncertain, and this unwillingness has been the more natural because these very men are in large part the more conservative fraction, which has resisted the temptation to abandon puddling and adopt the steel-making processes. Second, in puddling iron which is to be used as a raw material for making very fine steel by the crucible process, quality is the thing

of first importance. Now in the series of operations, the blast-furnace, puddling and crucible processes, through which the iron passes from the state of ore to that of crucible tool steel, it is so difficult to detect just which are the conditions essential to excellence in the final product that, once a given procedure has been found to yield excellent steel, every one of its details is adhered to by the more cautious ironmasters, often with surprising conservatism. Buyers of certain excellent classes of Swedish iron have been said to object even to the substitution of electricity for water-power as a means of driving the machinery of the forge. In case of direct puddling and the use of larger charges this conservatism has some foundation, because the established custom of allowing the cast iron to solidify gives a better opportunity of examining its fracture, and thus of rejecting unsuitable iron, than is afforded in direct puddling. So, too, when several puddlers are jointly responsible for the thoroughness of their work, as happens in puddling large charges, they will not exercise such care (nor indeed will a given degree of care be so effective) as when responsibility for each charge rests on one man.

82. *The removal of phosphorus*, a very important duty of the puddling process, requires that the cinder shall be "basic," i.e. that it shall have a great excess of the strong base, ferrous oxide, FeO, for the phosphoric acid to unite with, lest it be deoxidized by the carbon of the iron as fast as it forms, and so return to the iron, following the general rule that oxidized bodies enter the slag and unoxidized ones the metallic iron. But this basicity implies that for each part of the silica or silicic acid which inevitably results from the oxidation of the silicon of the pig iron, the cinder shall contain some three parts of iron oxide, itself a valuable and expensive substance. Hence, in order to save iron oxide the pig iron used should be nearly free from silicon. It should also be nearly free from sulphur, because of the great difficulty of removing this element in the puddling process. But the strong deoxidizing conditions needed in the blast-furnace to remove sulphur tend strongly to deoxidize silica and thus to make the pig iron rich in silicon.

83. *The "refinery process"* of fitting pig iron for the puddling process by removing the silicon without the carbon, is sometimes used because of this difficulty in making a pig iron initially low in both sulphur and silicon. In this process molten pig iron with much silicon but little sulphur has its silicon oxidized to silica and thus slagged off, by means of a blast of air playing on the iron through a blanket of burning coke which covers it. The coke thus at once supplies by its combustion the heat needed for melting the iron and keeping it hot, and by itself dissolving in the molten metal returns carbon to it as fast as this element is burnt out by the blast, so that the "refined" cast iron which results, though still rich in carbon and therefore easy to melt in the puddling process, has relatively little silicon.

84. In the *Bessemer* or "*pneumatic*" process, which indeed might be called the "fuel-less" process, molten pig iron is converted into steel by having its carbon, silicon and manganese, and often its phosphorus and sulphur, oxidized and thus removed by air forced through it in so many fine streams and hence so rapidly that the heat generated by the oxidation of these impurities suffices in and by itself, unaided by burning any other fuel, not only to keep the iron molten, but even to raise its temperature from a point initially but little above the melting point of cast iron, say 1150° to 1250° C., to one well above the melting point of the resultant steel, say 1500° C. The "Bessemer converter" or "vessel" (fig. 16) in which this wonderful process is carried out is a huge retort, lined with clay, dolomite or other refractory material, hung aloft and turned on trunnions, DD, through the right-hand one of which the blast is carried to the goose-neck E, which in turn delivers it to the tuyeres Q at the bottom.

There are two distinct varieties of this process, the original unde-phosphorizing or "acid" Bessemer process, so called because the converter is lined with acid materials, i.e. those rich in silicic acid, such as quartz and clay, and because the slag is consequently acid, i.e. siliceous; and the dephosphorizing or "Thomas" or "basic Bessemer" process, so called because the converter is lined with basic materials, usually calcined dolomite, a mixture of lime and magnesia, bound together with tar, and because the slag is made very basic by adding much

lime to it. In the basic Bessemer process phosphorus is readily removed by oxidation, because the product of its oxidation, phosphoric acid,  $P_2O_5$ , in the presence of an excess of base forms stable phosphates of lime and iron which pass into the slag, making it valuable as an artificial manure. But this dephosphorization by oxidation can be carried out only in the case slag is basic. If it is acid, *i.e.* if it holds much more than 20% of,

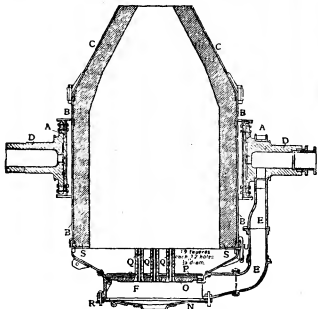

FIG. 16.—12-15 ton Bessemer Converter.

- A, Trunnion-ring.
- B, Main shell.
- C, Upper part of shell.
- D, Trunnions.
- E, Goose-neck.
- F, Tyure-box.
- N, Lid of tyure-box.
- O, Tyure-plate.
- P, False plate.
- Q, Tyures.
- R, Keys holding lid of tyure-box.
- S, Refractory lining.
- U, Key-link holding bottom.

so powerful an acid as silica, then the phosphoric acid has so feeble a hold on the base in the slag that it is immediately re-oxidized by the carbon of the metal, or even by the iron itself,  $P_2O_5 + 5Fe = 2P + 5FeO$ , and the resultant deoxidized phosphorus immediately recombines with the iron. Now in an acid-lined converter the slag is necessarily acid, because even an initially basic slag would immediately corrode away enough of the acid lining to make itself acid. Hence phosphorus cannot be removed in an acid-lined converter. Thoughall this is elementary to-day, not only was it unknown, indeed unguessed, at the time of the invention of the Bessemer process, but even when, nearly a quarter of a century later, a young English metallurgical chemist, Sidney Gilchrist Thomas (1850-1885), offered to the British Iron and Steel Institute a paper describing his success in dephosphorizing



FIG. 17.—Bessemer Converter, turned down in position to receive and discharge the molten metal.

by the Bessemer process with a basic-lined converter and a basic slag, that body rejected it.

85. In carrying out the acid Bessemer process, the converter, preheated to about  $1200^{\circ}C$ . by burning coke in it, is turned into the position shown in fig. 17, and the charge of molten pig iron, which sometimes weighs as much as 20 tons, is poured into it through its mouth. The converter is then turned upright into the position shown in fig. 16, so that the blast, which has been let on just before this, entering through the great number of tyure holes in the bottom, forces its way up through the relatively shallow layer of iron, throwing it up within the converter as a boiling foam, and oxidizing the foreign elements so

rapidly that in some cases their removal is complete after 5 minutes. The oxygen of the blast having been thus taken up by the molten metal, its nitrogen issues from the mouth of the converter as a pale spark-bearing cone. Under normal conditions the silicon oxidizes first. Later, when most of it has been oxidized, the carbon begins to oxidize to carbonic oxide, which in turn burns to carbonic acid as it meets the outer air on escaping from the mouth of the converter, and generates a true flame which grows bright, then brilliant, then almost blinding, as it rushes and roars, then "drops," *i.e.* shortens and suddenly grows quiet when the last of the carbon has burnt away, and no flame-forming substance remains. Thus may a 20-ton charge of cast iron be converted into steel in ten minutes.<sup>1</sup> It is by the appearance of the flame that the operator or "blower" knows when to end the process, judging by its brilliancy, colour, sound, sparks, smoke and other indications.

86. *Recarburizing.*—The process may be interrupted as soon as the carbon-content has fallen to that which the final product is to have, or it may be continued till nearly the whole of the carbon has been burned out, and then the needed carbon may be added by "recarburizing." The former of these ways is followed by the very skillful and intelligent blowers in Sweden, who, with the temperature and all other conditions well under control, and with their minds set on the quality rather than on the quantity of their product, can thus make steel of any desired carbon-content from 0.10 to 1.25%. But even with all their skill and care, while the carbon-content is still high the indications of the flame are not so decisive as to justify them in omitting to test the steel before removing it from the converter, as a check on the accuracy of their blowing. The delay which this test causes is so unwelcome that in all other countries the blower continues the blow until decarburization is nearly complete, because of the very great accuracy with which he can then read the indications of the flame, an accuracy which leaves little to be desired. Then, without waiting to test the product, he "recarburizes" it, *i.e.* adds enough carbon to give it the content desired, and then immediately pours the steel into a great clay-lined casting ladle by turning the converter over, and through a nozzle in the bottom of this ladle pours the steel into its ingot moulds. In making very low-carbon steel this recarburizing proper is not needed; but in any event a considerable quantity of manganese must be added unless the pig iron initially contains much of that metal, in order to remove from the molten steel the oxygen which it has absorbed from the blast, lest this make it redshot. If the carbon-content is not to be raised materially, this manganese is added in the form of preheated lumps of "ferro-manganese," which contains about 80% of manganese, 5% of carbon and 15% of iron, with a little silicon and other impurities. If, on the other hand, the carbon-content is to be raised, then carbon and manganese are usually added together in the form of a manganeseiferous molten pig iron, called spiegel-eisen, *i.e.* "mirror-iron," from the brilliancy of its facets, and usually containing somewhere about 12% of manganese and 4% of carbon, though the proportion between these two elements has to be adjusted so as to introduce the desired quantity of each into the molten steel. Part of the carbon of this spiegel-eisen unites with the oxygen occluded in the molten iron to form carbonic oxide, and again a bright flame, greenish with manganese, escapes from the converter.

87. *Darby's Process.*—Another way of introducing the carbon is Darby's process of throwing large paper bags filled with anthracite, coke or gas-carbon into the casting ladle as the molten steel is pouring into it. The steel dissolves the carbon of this fuel even more quickly than water would dissolve salt under like conditions.

88. *Bessemer and Mushet.*—Bessemer had no very wide knowledge of metallurgy, and after overcoming many stupendous

<sup>1</sup> The length of the blow varies very greatly, in general increasing with the proportion of silicon and with the size of charge. Thus the small Swedish charges with but little silicon may be blown in 5 minutes, but for a 20-ton charge the time is more likely to reach or exceed 10 minutes, and sometimes reaches 20 minutes or even more.

difficulties he was greatly embarrassed by the brittleness or "redshortness" of his steel, which he did not know how to cure. But two remedies were quickly offered, one by the skillful Swede, Göransson, who used a pig iron initially rich in manganese and stopped his blow before much oxygen had been taken up; and the other by a British steel maker, Robert Mushet, who proposed the use of the manganeseiferous cast iron called spiegeleisen, and thereby removed the only remaining serious obstacle to the rapid spread of the process.

From this many have claimed for Mushet a part almost or even quite equal to Bessemer's in the development of the Bessemer process, even calling it the "Bessemer-Mushet process." But this seems most unjust. Mushet had no such exclusive knowledge of the effects of manganese that he alone could have helped Bessemer; and even if nobody had then proposed the use of spiegeleisen, the development of the Swedish Bessemer practice would have gone on, and the process thus established and its value and great economy thus shown in Sweden, it would have been only a question of time how soon somebody would have proposed the addition of manganese. Mushet's aid was certainly valuable, but not more than Göransson's, who, besides thus offering a preventive of redshortness, further helped the process on by raising its temperature by the simple expedient of further subdividing the blast, thus increasing the surface of contact between blast and metal, and thus in turn hastening the oxidation. The two great essential discoveries were first that the rapid passage of air through molten cast iron raised its temperature above the melting point of low-carbon steel, or as it was then called "malleable iron," and second that this low-carbon steel, which Bessemer was the first to make in important quantities, was in fact an extraordinarily valuable substance when made under proper conditions.

80. *Source of Heat.*—The carbon of the pig iron, burning as it does only to carbonic oxide within the converter, does not by itself generate a temperature high enough for the needs of the process. The oxidation of manganese is capable of generating a very high temperature, but it has the very serious disadvantage of causing such thick clouds of smoky oxide of manganese as to hide the flame from the blower, and prevent him from recognizing the moment when the blow should be ended. Thus it comes about that the temperature is regulated primarily by adjusting the quantity of silicon in the pig iron treated, 1% of this element usually sufficing. If any individual blow proves to be too hot, it may be cooled by throwing cold "scrap" steel such as the waste ends of rails and other pieces, into the converter, or by injecting with the blast a little steam, which is decomposed by the iron by the endothermic reaction  $H_2O + Fe = 2H + FeO$ . If the temperature is not high enough, it is raised by managing the blast in such a way as to oxidize some of the iron itself permanently, and thus to generate much heat.

90. The basic or dephosphorizing variety of the Bessemer process, called in Germany the "Thomas" process, differs from the acid process in four chief points: (1) that its slag is made very basic and hence dephosphorizing by adding much lime to it; (2) that the lining is basic, because an acid lining would quickly be destroyed by such a basic slag; (3) that the process is arrested not at the "drop of the flame" (§85) but at a predetermined length of time after it; and (4) that phosphorus instead of silicon is the chief source of heat. Let us consider these in turn.

91. The slag, in order that it may have such an excess of base that this will retain the phosphoric acid as fast as it is formed by the oxidation of the phosphorus of the pig iron, and prevent it from being re-deoxidized and re-absorbed by the iron, should, according to von Ehrenwerth's rule which is generally followed, contain enough lime to form approximately a tetra-calcic silicate,  $4CaO \cdot SiO_2$  with the silica which results from the oxidation of the silicon of the pig iron and tri-calcic phosphate,  $3CaO \cdot P_2O_5$ , with the phosphoric acid which forms. The danger of this "rephosphorization" is greatest at the end of the blow, when the recarburizing additions are made. This lime is charged in the form of common quicklime, CaO, resulting from the calcination of a pure limestone,  $CaCO_3$ , which should be as free as possible from silica. The usual composition of this slag is iron oxide, 10 to 16%; lime, 40 to 50%; magnesia, 5%; silica, 6 to 9%; phosphoric acid, 16 to 20%. Its phosphoric acid makes it so valuable as a fertilizer that it is a most important

by-product. In order that the phosphoric acid may be the more fully liberated by the humic acid, &c., of the earth, a little silicious sand is mixed with the still molten slag after it has been poured off from the molten steel. The slag is used in agriculture with no further preparation, save very fine grinding.

92. The lining of the converter is made of 90% of the mixture of lime and magnesia which results from calcining dolomite,  $(Ca, Mg)CO_3$ , at a very high temperature, and 10% of coal tar freed from its water by heating. This mixture may be rammed in place, or baked blocks of it may be laid up like a masonry wall. In either case such a lining is expensive, and has but a short life, in few works more than 200 charges, and in some only 100, though the silicious lining of the acid converter lasts thousands of charges. Hence, for the basic process, spare converters must be provided, so that there may always be some of them re-lining, either while standing in the same place as when in use, or, as in Holley's arrangement, in a separate repair house, to which these gigantic vessels are removed bodily.

93. *Control of the Basic Bessemer Process.*—The removal of the greater part of the phosphorus takes place after the carbon has been oxidized and the flame has consequently "dropped," probably because the lime, which is charged in solid lumps, is taken up by the slag so slowly that not until late in the operation does the slag become so basic as to be retentive of phosphoric acid. Hence in making steel rich in carbon it is not possible, as in the acid Bessemer process, to end the operation as soon as the carbon in the metal has fallen to the point sought, but it is necessary to remove practically all of the carbon, then the phosphorus, and then "recarburize," i.e. add whatever carbon the steel is to contain. The quantity of phosphorus in the pig iron is usually known accurately, and the dephosphorization takes place so regularly that the quantity of air which it needs can be foretold closely. The blower therefore stops the process when he has blown a predetermined quantity of air through, counting from the drop of the flame; but as a check on his forecast he usually tests the blown metal before recarburizing it.

94. *Source of Heat.*—Silicon cannot here be used as the chief source of heat as it is in the acid Bessemer process, because most of the heat which its oxidation generates is consumed in heating the great quantities of lime needed for neutralizing the resultant silica. Fortunately the phosphorus, turned from a curse into a blessing, develops by its oxidation the needed temperature, though the fact that this requires at least 1-80% of phosphorus limits the use of the process, because there are few ores which can be made to yield so phosphoric a pig iron. Further objections to the presence of silicon are that the resultant silicea (1) corrodes the lining of the converter, (2) makes the slag froth so that it both throws much of the charge out and blocks up the nose of the converter, and (3) leads to rephosphorization. These effects are so serious that until very lately it was thought that the silicon could not safely be much in excess of 1%. But Massenez and Richards, following the plan outlined by Pourcel in 1879, have found that even 3% of silicon is permissible if, by adding iron ore, the resultant silicea is made into a fluid slag, and if this is removed in the early cool part of the process, when it attacks the lining of the converter but slightly. Manganese to the extent of 1-80% is desired as a means of preventing the resultant steel from being redshort, i.e. brittle at a red or forging heat. The pig iron should be as nearly free as possible from sulphur, because the removal of any large quantity of this injurious element in the process itself is both difficult and expensive.

95. The *car casting* system deserves description chiefly because it shows how, when the scale of operations is as enormous as it is in the Bessemer process, even a slight simplification and a slight heat-saving may be of great economic importance.

Whatever be the form into which the steel is to be rolled, it must in general first be poured from the Bessemer converter in which it is made into a large clay-lined ladle, and thence cast in vertical pyramidal ingots. To bring them to a temperature suitable for rolling, these ingots must be set in heating or soaking furnaces (§ 125), and this should be done as soon as possible after they are cast, both to lessen the loss of their initial heat, and to make way

for the next succeeding lot of ingots, a matter of great importance, because the charges of steel follow each other at such very brief intervals. A pair of working converters has made 4958 charges of 10 tons each, or a total of 50,547 tons, in one month, or at an average rate of a charge every seven minutes and twenty-four seconds throughout every working day. It is this extraordinary rapidity that makes the process so economical and determines the way in which its details must be carried out. Moreover, since the moulds from the ingot until just before the latter is to be placed in its soaking furnace. These conditions are fulfilled by the car casting system of F. W. Wood, of Sparrows Point, Md., in which the moulds, while receiving the steel, stand on a train of cars, which are immediately run to the side of the soaking furnace. Here, as soon as the ingots have so far solidified that they can be lifted without breaking, their moulds are removed and set on an adjoining train of cars, and the ingots are charged directly into the soaking furnace. The mould-train now carries its empty moulds to a cooling yard, and, as soon as they are cool enough to be used again, carries them back to the neighbourhood of the converters to receive a new lot of steel. In this system there is for each ingot and each mould only one handling in which it is moved as a separate unit, the mould from one train to the other, the ingot from its train into the furnace. In the other movements, all the moulds and ingots of a given charge of steel are grouped as a train, which is moved as a unit by a locomotive. The difficulty in the way of this system was that, in pouring the steel from ladle to mould, more or less of it occasionally splatters, and these splatters, if they strike the rails or the running gear of the cars, obstruct and foul them, preventing the movement of the train, because the solidified steel is extremely tenacious. But this cannot be tolerated, because the economy of the process requires extreme promptness in each of its steps. On account of this difficulty the moulds formerly stood, not on cars, but directly on the floor of a casting pit while receiving the molten steel. When the ingots had so far solidified that they could be handled, the moulds were removed and set on the floor to cool, the ingots were set on a car and carried to the soaking furnace, and the moulds were then replaced in the casting pit. Here each mould and each ingot was handled as a separate unit twice, instead of only once as in the car casting system; the ingots radiated away great quantities of heat in passing naked from the converting mill to the soaking furnaces, and the heat which they and the moulds radiated while in the converting mill was not only wasted, but made this mill, open-doored as it was, so intolerably hot, that the cost of labour there was materially increased. Mr Wood met this difficulty by the simple device of so shaping the cars that they completely protect both their own running gear and the track from all possible splattering, a device which, simple as it is, has materially lessened the cost of the steel and greatly increased the production. How great the increase has been, from this and many other causes, is shown in Table III.

TABLE III.—Maximum Production of Ingots by a Pair of American Converters.

	Gross Tons per Week.
1870 . . . . .	254
1880 . . . . .	3,433
1889 . . . . .	8,549
1899 (average for a month) . . . . .	11,233
1903 . . . . .	15,704

Thus in thirty-three years the rate of production per pair of vessels increased more than sixty-fold. The production of European Bessemer works is very much less than that of American. Indeed, the whole German production of acid Bessemer steel in 1899 was at a rate but slightly greater than that here given for one pair of American converters; and three pairs, if this rate were continued, would make most exactly as much steel as all the sixty-five active British Bessemer converters, acid and basic together, made in 1899.

**96. Range in Size of Converters.**—In the Bessemer process, and indeed in most high-temperature processes, to operate on a large scale has, in addition to the usual economies which it offers in other industries, a special one, arising from the fact that from a large hot furnace or hot mass in general a very much smaller proportion of its heat dissipates through radiation and like causes than from a smaller body, just as a thin red-hot wire coils in the air much faster than a thick bar equally hot. Hence the progressive increase which has occurred in the size of converters, until now some of them can treat a 20-ton charge, is not surprising. But, on the other hand, when only a relatively small quantity of a special kind of steel is needed, very much smaller charges, in some cases weighing even less than half a ton, have been treated with technical success.

**97. The Bessemer Process for making Steel Castings.**—This has been particularly true in the manufacture of steel castings, i.e. objects usually of more or less intricate shape, which are cast initially in the form in which they are to be used, instead of being forged or rolled to that form from steel cast originally in ingots. For making castings, especially of the kind that are so thick and intricate that, in order that the molten steel may remain molten long enough to run into the thin parts of the mould, it must be heated initially very far above its melting-point, the Bessemer process has a very great

advantage in that it can develop a much higher temperature than is attainable in either of its competitors, the crucible and the open-hearth processes. Indeed, no limit has yet been found to the temperature which can be reached, if matters are so arranged that not only the carbon and silicon of the pig iron, but also a considerable part of the metallic iron which is the iron itself, are oxidized by the blast; or if, as in the Walrand-Lorenzen modification, after the combustion of the initial carbon and silicon of the pig iron has already raised the charge to a very high temperature, a still further rise of temperature is brought about by adding more silicon in the form of ferro-silicon, and oxidizing it by further blowing. But in the crucible and the open-hearth processes the temperature attainable is limited by the danger of melting the furnace itself, both because some essential parts of it, which, unfortunately, are of a destructible shape, are placed most unfavourably in that they are surrounded by the heat on all sides, and because the furnace is necessarily hotter than the steel made within it. But no part of the Bessemer converter is of a shape easily affected by the heat, so that it is exposed to the heat on more than one side, and the converter itself is necessarily cooler than the metal within it, because the heat is generated within the metal itself by the combustion of its silicon and other calorific elements. In it the steel heats the converter, whereas in the open-hearth and crucible processes the furnace heats the steel.

**98. The open-hearth process** consists in making molten steel out of pig or cast iron and "scrap," i.e. waste pieces of steel and iron melted together on the "open hearth," i.e. the uncovered basin-like bottom of a reverberatory furnace, under conditions of which fig. 18 may give a general idea. The con-



FIG. 18.—Open-Hearth Process.

Half Section showing condition of charge when boiling very gently. Half Section showing condition of charge when boiling violently during oreing.

version of cast iron into steel, of course, consists in lessening its content of the several foreign elements, carbon, silicon, phosphorus, &c. The open-hearth process does this by two distinct steps: (1) by oxidizing and removing these elements by means of the flame of the furnace, usually aided by the oxygen of light charges of iron ore, and (2) by diluting them with scrap steel or its equivalent. The "pig and ore" or "Siemens" variety of the process works chiefly by oxidation, the "pig and scrap" or "Siemens-Martin" variety chiefly by dilution, sometimes indeed by extreme dilution, as when 10 parts of cast iron are diluted with 90 parts of scrap. Both varieties may be carried out in the basic and dephosphorizing way, i.e. in presence of a basic slag and in a basic or neutral-lined furnace; or in the acid and undephosphorizing way, in presence of an acid, i.e. silicious slag, and in a furnace with a silicious lining.

The charge may be melted down on the "open hearth" itself, or, as in the more advanced practice, the pig iron may be brought in the molten state from the blast furnace in which it is made. Then the furnaceman, controlling the decarburization and purification of the molten charge by his examination of test ingots taken from time to time, gradually oxidizes and so removes the foreign elements, and thus brings the metal simultaneously to approximately the composition needed and to a temperature far enough above its present melting-point to permit of its being cast into ingots or other castings. He then pours or taps the molten charge from the furnace into a large clay-lined casting ladle, giving it the final additions of manganese, usually with carbon and often with silicon, needed to give it exactly the desired composition. He then casts it into its final form through a nozzle in the bottom of the casting ladle, as in the Bessemer process.

The oxidation of the foreign elements must be very slow, lest the effervescence due to the escape of carbonic oxide from the carbon of the metal throw the charge out of the doors and

ports of the furnace, which itself must be shallow in order to hold the flame down close to the charge. It is in large part because of this shallowness, which contrasts so strongly with the height and roominess of the Bessemer converter, that the process lasts hours where the Bessemer process lasts minutes, though there is the further difference that in the open-hearth process the transfer of heat from flame to charge through the intervening layer of slag is necessarily slow, whereas in the Bessemer process the heat, generated as it is in and by the metallic bath itself, raises the temperature very rapidly. The slowness of this rise of the temperature compels us to make the removal of the carbon slow for a very simple reason. That removal progressively raises the melting-point of the metal, after line *aa* of fig. 1, *i. e.* makes the charge more and more infusible; and this progressive rise of the melting-point of the charge must not be allowed to outrun the actual rise of temperature, or in other words the charge must always be kept molten, because once solidified it is very hard to remelt. Thus the necessary slowness of the heating up of the molten charge would compel us to make the removal of the carbon slow, even if this slowness were not already forced on us by the danger of having the charge froth so much as to run out of the furnace.

The general plan of the open-hearth process was certainly conceived by Josiah Marshall Heath in 1845, if not indeed by Réaumur in 1722, but for lack of a furnace in which a high enough temperature could be generated it could not be carried out until the development of the Siemens regenerative gas furnace about 1860. It was in large part through the efforts of Le Chatelier that this process, so long conceived, was at last, in 1864, put into actual use by the brothers Martin, of Sireuil in France.

**99. Siemens Open-Hearth Furnace.**—These furnaces are usually stationary, but in that shown in figs. 19 to 22 the working chamber or furnace body, *G*, of fig. 22, rotates about its own axis, rolling on the rollers *M* shown in fig. 21. In this working chamber, a long quasi-cylindrical vessel of brickwork, heated by burning within it pre-heated gas with pre-heated air, the charge is melted and brought to the desired composition and temperature. The working chamber indeed is the furnace proper, in which the whole of the open-hearth process is carried out, and the function of all the rest of the apparatus, apart from the tilting mechanism, is simply to pre-heat the air and gas, and to lead them to the furnace proper and thence to the chimney. How this is done may be understood more easily if figs. 19 and 20 are regarded for a moment as forming a single diagrammatic figure instead of sections in different planes. The unbroken arrows show the direction of the incoming gas and air, the broken ones the direction of the escaping products of their combustion. The air and gas, the latter coming from the gas producers or other source, arrive through *H* and *J* respectively, and their path thence is determined by the position of the reversing valves *K* and *K'*. In the position shown in solid lines, these valves deflect the air and gas into the left-hand pair of "regenerators" or spacious heat-transferring chambers. In these, bricks in great numbers are piled loosely, in such a way that, while they leave ample passage for the gas and air, yet they offer to them a very great extent of surface, and therefore readily transfer to them the heat which they have as readily sucked out of the escaping products of combustion in the last preceding phase. The gas and air thus separately pre-heated to about 1300° F. (2012° F.) rise thence, as two separate streams through the uptakes (fig. 22), and first mix at the moment of entering the working chamber through the ports *L* and *L'* (fig. 19). As they are so hot at starting, their combustion of course yields a very much higher temperature than if they had been cold before burning, and they form an enormous flame, which fills the great working chamber. The products of combustion are sucked by the pull of the chimney through the farther or right-hand end of this chamber, out through the exit ports, as shown by the dotted arrows, down through the right-hand pair of regenerators, heating to perhaps 1300° C. the upper part of the loosely-piled masses of brickwork within them, and thence past the valves *K* and *K'* to the chimney-flue *O*. During this phase the incoming gas and air have been withdrawing heat from the left-hand regenerators, which have thus been cooling down, while the escaping products of combustion have been depositing heat in the right-hand pair of regenerators, which have thus been heating up. After some thirty minutes this condition of things is reversed by turning the valves *K* and *K'* 90° into the positions shown in dotted lines, when they deflect the incoming gas and air into the right-hand regenerators, so that they may absorb in passing the heat which has just been stored there; thence they pass up through the right-hand uptakes and ports into the working chamber, where as before they mix, burn and heat the charge. Thence they are sucked out by the chimney-draught through the left-hand ports,

down through the uptakes and regenerators, here again meeting and heating the loose mass of "regenerator" brickwork, and finally escape by the chimney-flue *O*. After another thirty minutes the

FIG. 19.—Section on EF through Furnace and Port Ends.

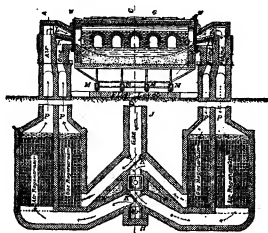

FIG. 20.—Plan through Regenerators, Flues and Reversing Valves.

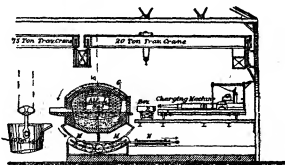

FIG. 21.—Section on CD through Body of Furnace.

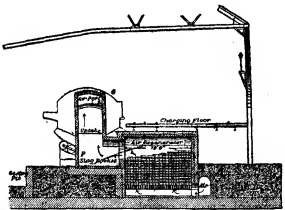

FIG. 22.—Section on AB through Uptake, Slag Pocket and Regenerator.

- FIGS. 19 TO 22.—Diagrammatic Sections of Tilting Siemens Furnace.
- |  |  |
|--|--|
| G, Furnace body.                       | N, Hydraulic cylinder for tilting the furnace.                     |
| H, Air supply.                         | O, Flue leading to chimney.  |
| J, Gas supply.                         | P, Slag pockets.   |
| K, Air reversing valve.                | R, Charging boxes.   |
| K', Gas reversing valve.               | W, Water-cooled joints between furnace proper, G, and ports L, L'. |
| L, Gas port.                           |  |
| M, Rollers on which the furnace tilts. |  |

current is again reversed to its initial direction, and so on. These regenerators are the essence of the Siemens or "regenerative furnace"; they are heat-traps, catching and storing by their



enormous surface of brickwork the heat of the escaping products of combustion, and in the following phase restoring the heat to the entering air and gas. At any given moment one pair of regenerators is storing heat, while the other is restoring it.

The tilting working chamber is connected with the stationary ports L and L' by means of the loose water-cooled joint W in Campbell's system, which is here shown. The furnace, resting on the rollers M, is tilted by the hydraulic cylinder N, and the pockets P (Fig. 2), below the upper rollers, are provided to catch the dust carried out by the furnace proper by the escaping products of combustion, lest it enter and choke the regenerators. Wellman's tilting furnace rolls on a fixed rack instead of on rollers. By his charging system a charge of as much as fifty tons is quickly introduced. The metal is packed by unskilled labourers in iron boxes, R (Fig. 21), standing on cars in the stock-yard. A locomotive carries a train of these cars to the track running beside a long line of open-heart furnaces. Here the charging machine lifts one box at a time from its car, pushes it through the momentarily opened furnace door, and empties the metal upon the hearth of the furnace by inverting the box, which it then replaces on its car.

100. The proportion of pig to scrap used depends chiefly on the relative cost of these two materials, but sometimes in part also on the carbon-content which the resultant steel is to have. Thus part at least of the carbon which a high-carbon steel is to contain may be supplied by the pig iron from which it is made. The length of the process increases with the proportion of pig used. Thus in the Westphalian pig and scrap practice the usual forms are of even weight, and the charge is made up only from 20 to 25%, indeed only enough to supply the carbon inevitably burnt out in melting the charge and heating it up to a proper casting temperature; and here the charge lasts only about 6 hours. In some British and Swedish "pig and ore" practice (§ 98), on the other hand, little or no scrap is used, and here the removal of the large quantity of carbon, silicon and phosphorus prolongs the process to 17 hours. The common practice in the United States is to use about equal parts of pig and scrap, and here the usual length of a charge is about 11½ hours. The pig and scrap process is held back first by the large quantity of carbon, and usually of silicon and phosphorus, to be removed, and second by the necessary slowness of their removal. The gangue of the ore increases the quantity of slag, which separates the metal from the source of its heat, the flame, and thus delays the rise of temperature; and the purification by "oreing," i. e. by means of the oxygen of the large lumps of cold iron ore thrown in by hand, is extremely slow, because the ore must be fed in very slowly, lest it chill the metal both directly and indirectly. For iron and steel it removes the heat from the metal,  $FeO + C = 2FeO + CO$ , itself absorbs heat. Indeed, this local cooling aggravates the frothing. A cold lump of ore chills the slag immediately around it, just where its oxygen, reacting on the carbon of the metal, generates carbonic oxide; the slag becomes cool, viscous, and hence easily made to froth, just where the froth-causing gas is evolved.

The length of these varieties of the process just given refers to the basic procedure. The acid process goes on much faster, because in it the heat insulating layer of slag is much thinner. For instance, it lasts only about 8½ hours when equal parts of pig and scrap are used, instead of the 11½ hours of the basic process. Thus the actual cost of conversion by the acid process is materially less than by the basic, but this difference is more than outweighed in most places by the greater cost of pig and scrap free enough from phosphorus to be used in the unphosphorizing acid process.

101. Three special varieties of the open-heart process, the Bertrand-Thiel, the Talbot and the Monell, deserve notice. Bertrand and Thiel oxidize the carbon of molten cast iron by pouring it into a bath of molten iron which has first been oxygenated and charged with oxygen, and superheated in an open-heart furnace. The two metallic masses coalesce, and the reaction between the oxygen of one and the carbon of the other is therefore extremely rapid because it occurs throughout their depth, whereas in common procedure oxidation occurs only at the upper surface of the bath of cast iron at its contact with the overlying slag. Moreover, since local cooling, with its consequent viscosity and tendency to froth, are avoided, the frothing is not excessive in spite of the rapidity of the reaction. The oxygenated metal is prepared by melting cast iron diluted with as much scrap steel as is desirable, and oxidizing it with the flame and with the oxygen which lies in this molten layer on the hearth of an open-heart furnace; and the large size of the furnace permits considerable frothing. But the oxygenated metal might be prepared easily in a Bessemer converter.

To enlarge the scale of operations makes strongly for economy in the open-heart process as in other high temperature ones. Yet the use of an open-heart furnace of very great capacity, say of 200 tons per charge, has the disadvantage that such very large lots of steel, delivered at relatively long intervals, are less readily managed in the subsequent operations of soaking, rolling down to the final shape, the smaller lots delivered at shorter intervals. To meet this difficulty Mr B. Talbot carries on the process as a quasi-continuous instead of an intermittent one, operating on 100-ton or 200-ton lots of cast iron in such a way as to draw off his steel in 20-ton lots at relatively short intervals, charging a fresh 20-ton lot

of cast iron to replace each lot of steel thus drawn off, and thus keeping the furnace full of metal from Monday morning till Saturday night. Besides minor advantages, this plan has the merit of avoiding an ineffective period which occurs in common open-heart procedure just after the charge of cast iron has been melted down. At this time the slag is temporarily rich in iron oxide and silica, resulting from the oxidation of the iron and the silicon as the charge slowly melts and trickles down. Such a slag not only corrodes the furnace lining, but also impedes dephosphorization, because it is irrelative of phosphorus. Further, the relatively low temperature impedes decarburization. Clearly, no such period can exist in the continuous process.

At a relatively low temperature, say 1300° C., the phosphorus of cast iron oxidizes and is removed much faster than its carbon, while at a higher temperature, say 1500° C., carbon oxidizes in preference to phosphorus. It is well to remove this latter element early, so that when the carbon shall have fallen to the proportion which the steel is to contain, the steel shall already be free from phosphorus, and so ready to cast. In common open-heart procedure, although the temperature is low early in the process, viz. at the end of the melting down, dephosphorization is then impeded by the temporary acidity of the slag, as just explained. At the Carnegie works Mr Monell gets the two dephosphorizing conditions, low temperature and basicity of slag, early in the process, by pouring his molten but relatively cool cast iron upon a layer of pre-heated lime and iron oxide on the bottom of the open-heart furnace. The heat of the iron oxide melt, and in passing up through the overlying metal, the iron oxide very rapidly oxidizes its phosphorus and thus drags it into the slag as phosphoric acid. The ebullition from the formation of carbonic oxide puffs up the resultant phosphoric slag enough to make most of it run out of the furnace, thus both removing the phosphorus permanently from danger of being later deoxidized and returned to the steel, and partly freeing the bath of metal from the heat-insulating blanket of slag. Yet frothing is not excessive, because the slag is not, as in common practice, locally chilled and made viscous by cold lumps of ore. In the duplex process the conversion of the cast iron into steel is begun in the Bessemer converter and finished in the open-heart furnace. In the most promising form of this process an acid converter and a basic open-heart furnace are used. In the former the silicon and part of the carbon are moved rapidly, in the latter the rest of the carbon and the phosphorus are removed slowly, and the metal is brought accurately to the proper temperature and composition. The advantage of this combination is that, by simplifying the conditions with which the composition of the pig iron has to conform at its melting, the management of the blast furnace is easier and thus lessens the danger of making "misfit" pig iron, i. e. that which, because it is not accurately suited to the process for which it is intended, offers us the dilemma of using it in that process at poor advantage or of putting it to some other use, a step which often implies serious loss.

For the acid Bessemer process the sulphur-content must be small and the silicon-content should be constant; for the basic open-heart process the content of both silicon and sulphur should be small, a thing difficult to bring about, because in the blast furnace most of the conditions which make for small sulphur-content make also for large silicon-content. In the acid Bessemer process the reason why the sulphur-content must be small is that the process removes no sulphur; and the reason why the silicon-content should be constant is that, because silicon is here the chief source of heat, variations in its content cause corresponding variations in the temperature, a most harmful thing because it is essential to the good quality of the steel that it shall be finished and cast at the proper temperature. It is true that the use of the mixer (§ 77) lessens these variations, and the management of the converter ways of mixing lessens their effects. Nevertheless, their harm is not completely done away with. But if the conversion is only begun in the converter and finished on the open-heart, then there is no need of regulating the temperature in the converter closely, and variations in the silicon-content of the pig iron thus become almost harmless in this respect. In the basic open-heart process, on the other hand, silicon is harmful because the silica which results from its oxidation not only corrodes the lining of the furnace but interferes with the removal of the phosphorus, an essential part of the process. The sulphur-content should be small, because the removal of this element is likewise difficult. But if the silicon of the pig iron is removed by a preliminary treatment in the Bessemer converter, then its presence in the pig iron is harmless as regards the open-heart process. Hence the blast furnace process, thus freed from the hampering need of controlling accurately the silicon-content, can be much more effectively guided so as to prevent the sulphur from entering the pig iron.

Looking at the duplex process in another way, the preliminary desilicizing in the Bessemer converter should be certainly an advantage; but whether it is really profitable to give this treatment in the converter than in the mixer remains to be seen.

103. In the cementation process bars of wrought iron about 1 in. thick are carburized and so converted into high carbon "blister steel," by heating them in contact with charcoal in

a closed chamber to about  $1000^{\circ}$  C. ( $1832^{\circ}$  F.) for from 8 to 11 days. Low-carbon steel might thus be converted into high-carbon steel, but this is not customary. The carbon dissolves in the hot but distinctly solid  $\gamma$ -iron (compare fig. 1) as salt dissolves in water, and works its way towards the centre of the bar by diffusion. When the mass is cooled, the carbon changes over into the condition of cementite as usual, partly interstratified with ferrite in the form of pearlite, partly in the form of envelopes enclosing kernels of this pearlite (see ALLOYS, Pl. fig. 13). Where the carbon, in thus diffusing inwards, meets particles of the slag, a basic ferrous silicate which is always present in wrought iron, it forms carbonic oxide,  $\text{FeO} + \text{C} = \text{Fe} + \text{CO}$ , which puffs the pliant metal up and forms blisters. Hence the name "blister steel." It was formerly sheared to short lengths and formed into piles, which were then rolled out, perhaps to be resheared and rerolled into bars, known as "single shear" or "double shear" steel according to the number of shearings. But now the chief use for blister steel is for remelting in the crucible process, yielding a product which is asserted so positively, so universally and by such competent witnesses to be not only better but very much better than that made from any other material, that we must believe that it is so, though no clear reason can yet be given why it should be. For long all the best high-carbon steel was made by remelting this blister steel in crucibles (§ 106), but in the last few years the electric processes have begun to make this steel (§ 108).

**104. Case Hardening.**—The many steel objects which need an extremely hard outer surface but a softer and more malleable interior may be carburized superficially by heating them in contact with charcoal or other carbonaceous matter, for instance for between 5 and 48 hours at a temperature of  $800^{\circ}$  to  $900^{\circ}$  C. This is known as "case hardening." After this carburizing these objects are usually hardened by quenching in cold water (see § 28).

**105. Deep Carburizing; Harvey and Krupp Processes.**—Much of the heavy side armour of war-vessels (see ARMOUR-PLATE) is made of nickel steel initially containing so little carbon that it cannot be hardened, *i. e.* that it remains very ductile even after sudden cooling. The impact face of these plates is given the intense hardness needed by being converted into high-carbon steel, and then hardened by sudden cooling. The impact face is thus carburized to a depth of about  $\frac{1}{4}$  in. by being held at a temperature of  $1100^{\circ}$  for about a week, pressed strongly against a bed of charcoal (Harvey process). The plate is then by Krupp's process heated so that its impact face is above while its rear is below the hardening temperature, and the whole is then cooled suddenly with sprays of cold water. Under these conditions the hardness, which is very extreme at the impact face, shades off toward the back, till at about quarter way from face to back all hardening ceases, and the rest of the plate is in a very strong, shock-resisting state. Thanks to the glass-hardness of this face, the projectile is arrested so abruptly that it is shattered, and its energy is delivered piecemeal by its fragments; but as the face is integrally united with the unhardened, ductile and slightly yielding interior and back, the plate, even if it is locally bent backwards somewhat by the blow, neither cracks nor flakes.

**106. The crucible process** consists essentially in melting one or another variety of iron or steel in small 80-lb. charges in closed crucibles, and then casting it into ingots or other castings, though in addition the metal while melting may be carburized. Its chief, indeed almost its sole use, is for making tool steel, the best kinds of spring steel and other very excellent kinds of high-carbon and alloy steel. After the charge has been fully melted, it is held in the molten state from 30 to 60 minutes. This enables it to take up enough silicon from the walls of the crucible to prevent the evolution of gas during solidification, and the consequent formation of blowholes or internal gas bubbles. In Great Britain the charge usually consists of blister steel, and is therefore high in carbon, so that the crucible process has very little to do except to melt the charge. In the

United States the charge usually consists chiefly of wrought iron, and in melting in the crucible it is carburized by mixing with it either charcoal or "washed metal," a very pure cast iron made by the Bell-Krupp process (§ 107).

Compared with the Bessemer process, which converts a charge of even as much as 20 tons of pig iron into steel in a few minutes, and the open-hearth process which easily treats charges of 75 tons, the crucible process is, of course, a most expensive one, with its little 80-lb. charges, melted with great consumption of fuel because the heat is kept away from the metal by the walls of the crucible, themselves excellent heat insulators. But it survives simply because crucible steel is very much better than either Bessemer or open-hearth steel. This in turn is in part because of the greater care which can be used in making these small lots, but probably in chief part because the crucible process excludes the atmospheric nitrogen, which injures the metal, and because it gives a good opportunity for the suspended slag and iron oxide to rise to the surface. Till Huntsman developed the crucible process in 1740, the only kinds of steel of commercial importance were blister steel made by carburizing wrought iron without fusion, and others which like it were greatly injured by the presence of particles of slag. Huntsman showed that the mere act of freeing these slag-bearing steels from their slag by melting them in closed crucibles greatly improved them. It is true that Réaumur in 1722 described his method of making molten steel in crucibles, and that the Hindus have for centuries done this on a small scale, though they let the molten steel resolidify in the crucible. Nevertheless, it is to Huntsman that the world is immediately indebted for the crucible process. He could make only high-carbon steel, because he could not develop within his closed crucibles the temperature needed for melting low-carbon steel. The crucible process remained the only one by which slagless steel could be made, till Bessemer, by his astonishing invention, discovered at once low-carbon steel and a process for making both it and high-carbon steel extremely cheaply.

**107. In the Bell-Krupp** or "pig-washing" process, invented independently by the famous British iron-master, Sir Lowthian Bell, and Krupp of Essen, advantage is taken of the fact that, at a relatively low temperature, probably a little above  $1200^{\circ}$  C., the phosphorus and silicon of molten cast iron are quickly oxidized and removed by contact with molten iron oxide, though carbon is thus oxidized but slowly. By rapidly stirring molten iron oxide into molten pig iron in a furnace shaped like a saucer, slightly inclined and turning around its axis, at a temperature but little above the melting-point of the metal itself, the phosphorus and silicon are removed rapidly, without removing much of the carbon, and by this means an extremely pure cast iron is made. This is used in the crucible process as a convenient source of the carbon needed for high-carbon steel.

**108. Electric steel-making processes**, or more accurately processes in which electrically heated furnaces are used, have developed very rapidly. In steel-making, electric furnaces are used for two distinct purposes, first for making steel sufficiently better than Bessemer and open-hearth steels to replace these for certain important purposes, and second for replacing the very expensive crucible process for making the very best steel. The advantages of the electric furnaces for these purposes can best be understood after examining the furnaces themselves and the way in which they are used. The most important ones are either "arc" furnaces, *i. e.* those heated by electric arcs, or "induction" ones, *i. e.* those in which the metal under treatment is heated by its own resistance to a current of electricity induced in it from without. The Heroult furnace, the best known in the arc class, and the Kjellin and Roehling-Rodenhauser furnaces, the best known of the induction class, will serve as examples.

The Heroult furnace (fig. 23) is practically a large closed crucible, ABCA, with two carbon electrodes, E and F, "in series" with the bath, H, of molten steel. A pair of electric arcs pass between these electrodes and the molten steel, passing through the layer of slag, G, and generating much heat. The lining of the crucible may be of either magnesite ( $\text{MgO}$ ) or chromite ( $\text{FeO} \cdot \text{Cr}_2\text{O}_3$ ). The whole furnace, electrodes and all, rotates about the line KL for the purpose of pouring out the molten

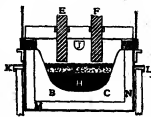

FIG. 23.—Heroult Double-Arc Electric Steel Purifying Furnace.

slag and purified metal through the spout J at the end of the process. This spout and the charging doors A, A are kept closed except when in actual use for pouring or charging.

The Kjellin furnace consists essentially of an annular trough, AA (fig. 24), which contains the molten charge. This charge is heated, like the filaments of a common household electric lamp, by the passage of a current of electricity induced in it by means of the core C and the frame EEE.

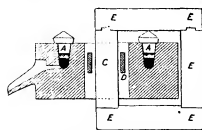

FIG. 24.—Kjellin Induction Electric Steel Melting Furnace.

The ends of this core are connected above, below and at the right of the trough A, by means of that frame, so that the trough and this core and frame stand to each other in a position like that of two successive links of a common oval-linked chain. A current of great electromotive force (intensity or voltage) passed through the coil D, induces, by means of the core and frame, a current of enormous quantity (volume or amperage), but very small electromotive force, in the metal in the trough. Thus the apparatus is analogous to the common transformers used for inducing from currents of great electromotive force and small quantity, which carry energy through long distances, currents of great quantity and small electromotive force for incandescent lights and for welding. The molten metal in the Kjellin trough forms the "secondary" circuit. Like the Heroult furnace, the Kjellin furnace may be lined with either magnesite or chromite, and it may be tilted for the purpose of pouring off slag and metal.

The shape which the molten metal under treatment has in the Kjellin furnace, a thin ring of large diameter, is evidently hard, inconvenient for manipulation any with excessive heat-radiating surface. In the Roehling-Rodenhauser induction furnace (fig. 25),

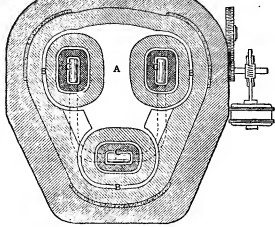

FIG. 25.—Plan of Roehling-Rodenhauser Induction Electric Furnace.

the molten metal lies chiefly in a large compact mass A, heated at three places on its periphery by the current induced in it there by means of the three coils and cores CCC. The molten metal also extends round each of these three coils, in the narrow channels B. It is in the metal in these channels and in that part of the main mass of metal which immediately adjoins the coils that the current is induced by means of the coils and cores, as in the Kjellin furnace.

When the Heroult furnace is used for completing the purification of molten steel begun in the Bessemer or open-hearth process, and this is its most appropriate use, the process carried out in it may be divided into two stages, first dephosphorization, and second deoxidation and desulphurization.

In the first stage the phosphorus is removed from the molten steel by oxidizing it to phosphoric acid,  $P_2O_5$ , by means of iron oxide contained in a molten slag very rich in lime, and hence very basic and retentive of that phosphoric acid. This slag is formed by melting lime and iron oxide, with a little silica sand if need be. Floating on top of the molten metal, it rapidly oxidizes its phosphorus, and the resultant phosphoric acid combines with the lime in the overlying slag as phosphate of lime. When the removal of the phosphorus is sufficiently complete, this slag is withdrawn from the furnace.

Next comes the deoxidizing and desulphurizing stage, of which the first step is to throw some strongly deoxidizing substance, such

as coke or ferro-silicon, upon the molten metal, in order to remove thus the chief part of the oxygen which it has taken up during the oxidation of the phosphorus in the preceding stage. Next the metal is covered with a very basic slag, made by melting lime with a little silica and fluor spar. Coke now charged into this slag first deoxidizes any iron oxide contained in either slag or metal, and next deoxidizes part of the lime of the slag and thus forms calcium, which, uniting with the sulphur present in the molten metal, forms calcium sulphide,  $CaO + FeS + C = CaS + Fe + CO$ . This sulphide is nearly insoluble in the metal, but is readily soluble in the overlying basic slag, into which it therefore passes. The thorough removal of the sulphur is thus brought about by the deoxidation of the calcium. It is by forming calcium sulphide that sulphur is removed in the manufacture of pig iron in the iron blast furnace, in the crucible of which, as in the electric furnaces, the conditions are strongly deoxidizing. But in the Bessemer and open-hearth processes this means of removing sulphur cannot be used, because in each of them there is always enough oxygen in the atmosphere to re-oxidize any calcium as fast as it is deoxidized. Here sulphur may indeed be removed to a very important degree in the form of manganese sulphide, which distributes itself between metal and slag in rough accord with the laws of equilibrium. But if we rely on this means we have difficulty in reducing the sulphur content of the metal to 0.03%, and very great difficulty in reducing it to 0.02%, whereas with the calcium sulphide of the electric furnaces we can easily reduce it to less than 0.1%.

When the desulphurization is sufficiently complete, the sulphur-bearing slag is removed, the final additions needed to give the metal exactly the composition aimed at are made, and the molten steel is tapped out of the furnace into its moulds. If the initial quantity of phosphorus or sulphur is large, or if the removal of these impurities is to be made very thorough, the dephosphorizing or the desulphurizing slagging off may be repeated. While the metal lies tranquilly on the bottom of the furnace, any slag mechanically suspended in it has a chance to rise to the surface and unite with the slag layer above.

In addition to this work of purification, the furnace may be used for melting down the initial charge of cold metal, and for beginning the purification—in short not only for finishing but also for roughing. But this is rarely expedient, because electricity is so expensive that it should be used for doing only those things which cannot be accomplished by any other and cheaper means. The melting can be done much more cheaply in a cupola or open-hearth furnace, and the first part of the purification much more cheaply in a Bessemer converter or open-hearth furnace.

The normal use of the Kjellin induction furnace is to do the work usually done in the crucible process, i.e. to melt down very pure iron for the manufacture of the best kinds of steel, such as fine tool and spring steel, and to bring the molten metal simultaneously to the exact composition and temperature at which it should be cast into its moulds. This furnace may be used also for purifying the molten metal, but it is not so well suited as the arc furnaces for dephosphorizing. The reason for this is that in it the slag, by means of which all the purification must needs be done, is not heated effectively; that hence it is not readily made thoroughly liquid; that hence the removal of the phosphoric slag made in the early dephosphorizing stage of the process is liable to be incomplete; and that hence, finally, the phosphorus of any of this slag which is left in the furnace becomes deoxidized during the second or deoxidizing stage, and is thereby returned to be foul the underlying steel. The reason why the slag is not heated effectively is that the heat is developed only in the layer of metal itself, by its resistance to the induced current, and hence the only heat which the slag receives is that supplied to its lower surface by the metal, while its upper side is constantly radiating heat away towards the relatively cool roof above.

The Roehling-Rodenhauser furnace is unfitted, by the vulnerability of its interior walls, for receiving charges of cold metal to be melted down, but it is used to good advantage for purifying molten basic Bessemer steel sufficiently to fit it for use in the form of railway rails.

We are now in a position to understand why electricity should be used as a source of heat in making molten steel. Electric furnaces are at an advantage over others as regards the removal of sulphur and of iron oxide from the molten steel, because their atmosphere is free from the sulphur always present in the flame of coal-fired furnaces, and almost free from oxygen, because this element is quickly absorbed by the carbon and silicon of the steel, and in the case of arc furnaces by the carbon of the electrodes themselves, and is replaced only very slowly by leakage, whereas through the Bessemer converter and the open-hearth furnace a torrent of air is always rushing. As we have seen, the removal of sulphur can be made complete only by deoxidizing calcium, and this cannot be done if much oxygen is present. Indeed, the freedom of the atmosphere of the electric furnaces from oxygen is also the reason indirectly

why the molten metal can be freed from mechanically suspended slag more perfectly in them than in the Bessemer converter or the open-hearth furnace. In order that this finely divided slag shall rise to the surface and there coalesce with the overlying layer, the metal must be tranquil. But tranquillity is clearly impossible in the Bessemer converter, in which the metal can be kept hot only by being torn into a spray by the blast. It is practically unattainable in the open-hearth furnace, because here the oxygen of the furnace atmosphere indirectly oxidizes the carbon of the metal which is kept boiling by the escape of the resultant carbonic oxide. In short the electric furnaces can be used to improve the molten product of the Bessemer converter and open-hearth furnace, essentially because their atmosphere is free from sulphur and oxygen, and because they can therefore remove sulphur, iron oxide and mechanically suspended slag, more thoroughly than is possible in these older furnaces. They make a better though a dearer steel.

Further, the electric furnaces, e.g. the Kjellin, can be used to replace the crucible melting process (§ 106), chiefly because their work is cheaper for two reasons. First, they treat a larger charge, a ton or more, whereas the charge of each crucible is only about 80 pounds. Second, their heat is applied far more economically, directly to the metal itself, whereas in the crucible process the heat is applied most wastefully to the outside of the non-conducting walls of a closed crucible within which the charge to be heated lies. Beyond this sulphur and phosphorus can be removed in the electric furnace, whereas in the crucible process they cannot. In short electric furnaces replace the old crucible furnace primarily because they work more cheaply, though in addition they may be made to yield a better steel than it can.

Thus we see that the purification in these electric furnaces has nothing to do with electricity. We still use the old familiar purifying agents, iron oxide, lime and nascent calcium. The electricity is solely a source of heat, free from the faults of the older sources which for certain purposes it now replaces. The electric furnaces are likely to displace the crucible furnaces completely, because they work both more cheaply and better. They are not likely to displace either the open-hearth furnace or the Bessemer converter, because their normal work is only to improve the product of these older furnaces. Here their use is likely to be limited by its costliness, because for the great majority of purposes the superiority of the electrically purified steel is not worth the cost of the electric purification.

109. *Electric Ore-smelting Processes.*—Though the electric processes which have been proposed for extracting the iron from iron ore, with the purpose of displacing the iron blast furnace, have not become important enough to deserve description here, yet it should be possible to devise one which would be useful in a place (if there is one) which has an abundance of water power and iron ore and a local demand for iron, but has not coke, charcoal or bituminous coal suitable for the blast furnace. But this ancient furnace does its fourfold work of deoxidizing, melting, removing the gangue and desulphurizing, so very economically that it is not likely to be driven out in other places until the exhaustion of our coal-fields shall have gone so far as to increase the cost of coke greatly.

110. *Comparison of Steel-making Processes.*—When Bessemer discovered that by simply blowing air through molten cast iron rapidly he could make low-carbon steel, which is essentially wrought iron greatly improved by being freed from its essential defect, its necessarily weakening and embrittling slag, the very expensive and exhausting puddling process seemed doomed, unable to survive the time when men should have familiarized themselves with the use of Bessemer steel, and should have developed the evident possibilities of cheapness of the Bessemer process. Nevertheless the use of wrought iron actually continued to increase. The first of the United States decennial censuses to show a decrease in the production of wrought iron was that in 1890, 35 years after the invention of the Bessemer process. It is still in great demand for certain normal purposes for which either great ease in welding or resistance to corrosion by rusting is of great importance; for purposes requiring special forms of extreme ductility which are not so confidently expected in steel; for miscellaneous needs of many users, some ignorant, some

very conservative; and for remelting in the crucible process. All the best cutlery and tool steel is made either by the crucible process or in electric furnaces, and indeed all for which any considerable excellence is claimed is supposed to be so made, though often incorrectly. But the great mass of the steel of commerce is made by the Bessemer and the open-hearth processes. Open-hearth steel is generally thought to be better than Bessemer, and the acid variety of each of these two processes is thought to yield a better product than the basic variety. This may not necessarily be true, but the acid variety lends itself more readily to excellence than the basic. A very large proportion of ores cannot be made to yield cast iron either free enough from phosphorus for the acid Bessemer or the acid open-hearth process, neither of which removes that most injurious element, or rich enough in phosphorus for the basic Bessemer process, which must rely on that element as its source of heat. But cast iron for the basic open-hearth process can be made from almost any ore, because its requirements, comparative freedom from silicon and sulphur, depend on the management of the blast-furnace rather than on the composition of the ore, whereas the phosphorus-content of the cast iron depends solely on that of the ore, because nearly all the phosphorus of the ore necessarily passes into the cast iron. Thus the basic open-hearth process is the only one which can make steel from cast iron containing more than 0.10% but less than 1.80% of phosphorus.

The restriction of the basic Bessemer process to pig iron containing at least 1.80% of phosphorus has prevented it from getting a foothold in the United States; the restriction of the acid Bessemer process to pig iron very low in phosphorus, usually to that containing less than 0.10% of that element, has almost driven it out of Germany, has of late retarded, indeed almost stopped, the growth of its use in the United States, and has even caused it to be displaced at the great Duquesne works of the Carnegie Steel Company by the omnivorous basic open-hearth process, the use of which has increased very rapidly. Under most conditions the acid Bessemer process is the cheapest in cost of conversion, the basic Bessemer next, and the acid open-hearth next, though the difference between them is not great. But the crucible process is very much more expensive than any of the others.

Until very lately the Bessemer process, in either its acid or its basic form, made all of the world's rail steel; but even for this work it has now begun to be displaced by the basic open-hearth process, partly because of the fast-increasing scarcity of ores which yield pig iron low enough in phosphorus for the acid Bessemer process, and partly because the increase in the speed of trains and in the loads on the individual engines and car-wheels has made a demand for rails of a material better than Bessemer steel.

111. *Iron foundling, i.e. the manufacture of castings of cast iron, consists essentially in pouring the molten cast iron into moulds, and, as preparatory steps, melting the cast iron itself and preparing the moulds. These are usually made of sand containing enough clay to give it the needed coherence, but of late promising attempts have been made to use permanent iron moulds. In a very few places the molten cast iron as it issues from the blast furnace is cast directly in these moulds, but in general it is allowed to solidify in pigs, and then remelted either in cupola furnaces or in air furnaces. The cupola furnace (fig. 26) is a shaft much like a miniature blast furnace, filled from top to bottom by a column of lumps of coke and of iron. The blast of air forced in through the tuyeres near the bottom of the furnace burns the coke there, and the intense heat thus caused melts away the surrounding iron, so that this column of coke and iron gradually descends; but it is kept at its full height by feeding more coke and iron at its top, until all the iron needed for the day's work has thus been charged. As the iron melts it runs out through a tap hole and spout at the bottom of the furnace, to be poured into the moulds by means of clay-lined ladles. The air furnace is a reverberatory furnace like that used for puddling (fig. 14), but larger, and in it the pigs of iron, lying on the bottom or hearth, are melted down by the flame from the coal which burns in the firebox. The iron is then held molten till it has grown hot enough for casting and till enough of its*

carbon has been burnt away to leave just the carbon-content desired, and it is then tapped out and poured into the moulds.

Of the two the cupola is very much the more economical of fuel, thanks to the direct transfer of heat from the burning coke to the pig iron with which it is in contact. But this contact both causes the iron to absorb sulphur from the coke to its great harm, and prevents it from having any large part of its carbon burnt away, which in many cases would improve it very greatly by strengthening it. Thus it comes about that the cupola, because it is so economical, is used for all but the relatively few cases in which the strengthening of the iron by the removal of part of its carbon and the prevention of the absorption of sulphur are so important as to compensate for the greater cost of the air-furnace melting.

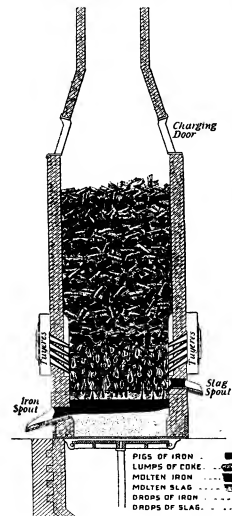

FIG. 26.—Cupola Furnace for Remelting Pig Iron.

useful. Because of the ease and cheapness with which, thanks to its fluidity and fusibility (fig. 1), it can be melted and run even into narrow and intricate moulds, castings made of it are very often more economical. *i.e.* they serve a given purpose more cheaply, in the long run, than either rolled or cast steel, in spite of their need of being so massive that the brittleness of the material itself shall be endurable. Indeed this high carbon-content, 3 to 4%, in practice actually leads to less brittleness than can readily be had with somewhat less carbon, because with it much of the carbon can easily be thrown into the relatively harmless state of graphite, whereas if the carbon amounts to less than 3% it can be brought to this state only with difficulty. For crushing certain kinds of rock, the hardness of which cast iron is capable really makes it more valuable, pound for pound, than steel.

113. *Qualities needed in Cast Iron Castings.*—Different kinds of castings need very different sets of qualities, and the composition of the cast iron itself must vary from case to case so as to give each the qualities needed. The iron for a statuette must first of all be very fluid, so that it will run into every crevice in its mould, and it must expand in solidifying, so that it shall reproduce accurately every detail of that mould. The iron for most engineering purposes needs chiefly to be strong and not excessively brittle. That for the thin-walled water mains must combine strength with the fluidity needed to enable it to run

freely into its narrow moulds; that for most machinery must be soft enough to be cut easily to an exact shape; that for hydraulic cylinders must combine strength with density lest the water leak through; and that for car-wheels must be intensely hard in its wearing parts, but in its other parts it must have that shock-resisting power which can be had only along with great softness. Though all true cast iron is brittle, in the sense that it is not usefully malleable, *i.e.* that it cannot be hammered from one shape into another, yet its degree of brittleness differs as that of soapstone does from that of glass, so that there are the intensely hard and brittle cast irons, and the less brittle ones, softer and unhard by a shock which would shiver the former.

Of these several qualities which cast iron may have, fluidity is given by keeping the sulphur-content low and phosphorus-content high; and this latter element must be kept low if shock is to be resisted; but strength, hardness, endurance of shock, density and expansion in solidifying are controlled essentially by the distribution of the carbon between the states of graphite and cementite, and this in turn is controlled chiefly by the proportion of silicon, manganese and sulphur present, and in many cases by the rate of cooling.

114. *Constitution of Cast Iron.*—Cast iron naturally has a high carbon-content, usually between 3 and 4%, because while molten it absorbs carbon greedily from the coke with which it is in contact in the iron blast furnace in which it is made, and in the cupola furnace in which it is remelted for making most castings. This carbon may all be present as graphite, as in typical grey cast iron; or all present as cementite,  $Fe_3C$ , as in typical white cast iron; or, as is far more usual, part of it may be present as graphite and part as cementite. Now how does it come about that the distribution of the carbon between these very unlike states determines the strength, hardness and many other valuable properties of the metal as a whole? The answer to this is made easy by a careful study of the effect of this same distribution on the constitution of the metal, because it is through controlling this constitution that the condition of the carbon controls these useful properties. To fix our ideas let us assume that the iron contains 4% of carbon. If this carbon is all present as graphite, so that in cooling the graphite-austenite diagram has been followed strictly (§ 26), the constitution is extremely simple; clearly the mass consists first of a metallic matrix, the carbonless iron itself with whatever silicon, manganese, phosphorus and sulphur happen to be present, in short an impure ferrite, encased in which as a wholly distinct foreign body is the graphite. The primary graphite (§ 26) generally forms a coarse, nearly continuous skeleton of curved black plates, like those shown in fig. 27; the eutectic graphite is much



FIG. 27.—Graphite in Grey Cast Iron.

finer; while the pro-eutectoid and eutectoid graphite, if they exist, are probably in very fine particles. We must grasp clearly this conception of metallic matrix and encased graphite skeleton if we are to understand this subject.

Now this matrix itself is equivalent to a very low-carbon steel, strictly speaking to a carbonless steel, because it consists of pure ferrite, which is just what such a steel consists of; and the cast iron as a whole is therefore equivalent to a matrix of very low-carbon

steel in which is encased a skeleton of graphite plates, besides some very fine scattered particles of graphite.

Next let us imagine that, in a series of cast irons all containing 4% of carbon, the graphite of the initial skeleton changes gradually into cementite and thereby becomes part of the matrix, a change which of course has two aspects, first, a gradual thinning of the graphite skeleton and a decrease of its continuity, and second, a gradual introduction of cementite into the originally pure ferrite matrix. By the time that 0.4% of graphite has thus changed, and in changing has united with  $0.4 \times 14 = 5.6\%$  of the iron of the original ferrite matrix, it will have changed this matrix from pure ferrite into a mixture of

Cementite . . . . .	0.4 + 5.6 =	6.0
Ferrite . . . . .	96.0 - 5.6 =	90.4
		96.4
The residual graphite skeleton forms	4 - 0.4 =	3.6
		100.0

But this matrix is itself equivalent to a steel of about 0.40% of carbon (more accurately  $0.40 \times 100 \div 96.4 = 0.415\%$ ), a rail steel, because it is of just such a mixture of ferrite and cementite in the ratio of 90.4:6 or 94% and 6%, that such a rail steel consists. The mass as a whole, then, consists of 96.4 parts of metallic matrix, which itself is in effect a 0.415% carbon rail steel, weakened and embrittled by having its continuity broken up by this skeleton of graphite forming 3.6% of the whole mass by weight, or say 12% by volume.

As, in succeeding members of this same series of cast irons, more of the graphite of the initial skeleton changes into cementite and thereby becomes part of the metallic matrix, so the graphite skeleton becomes progressively thinner and more discontinuous, and the matrix richer in cementite and hence in carbon and hence equivalent first to higher and higher carbon steel, such as tool steel of 1% carbon, file steel of 1.50% wire-die steel of 2% carbon and then to white cast iron which consists essentially of much cementite with little ferrite. Eventually, when the whole of the graphite of the skeleton has changed into cementite, the mass as a whole becomes typical or ultra white cast iron, consisting of nothing but ferrite and cementite, distributed as follows (see fig. 2):—

Eutectoid ferrite . . . . .	40.0
„ cementite . . . . .	6.7
„ Interstratified as pearlite . . . . .	46.7
„ Cementite, primary, eutectoid and pro-eutectoid . . . . .	53.3
„ Total ferrite . . . . .	100.0
„ Total cementite . . . . .	40.0
	60.0
	100.0

The constitution and properties of such a series of cast irons, all containing 4% of carbon but with that carbon shifting pro-

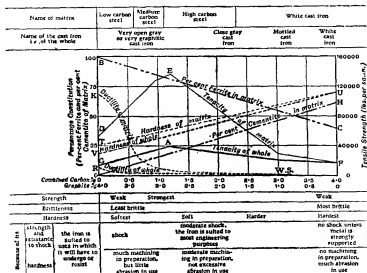

FIG. 28.—Physical Properties and assumed Microscopic Constitution of Cast Iron containing 4% of carbon, as affected by the distribution of that carbon between the combined and graphitic states.

gressively from the state of graphite to that of cementite as we pass from specimen to specimen, may, with the foregoing picture of a skeleton-holding matrix clearly in our minds be traced by means of fig. 28. The change from graphite into cementite is supposed to take place as we pass from left to right. BC and OH give the pro-

portion of ferrite and cementite respectively in the matrix, DEF, KS and TU reproduced from fig. 3 give the consequent properties of the matrix, and GAF, RS and VU give, partly from conjecture, the properties of the cast iron as a whole. Above the diagram are given the names of the different classes of cast iron to which different stages in the change from graphite to cementite correspond, and above these the names of kinds of steel or cast iron to which at the corresponding stages the constitution of the matrix corresponds, while below the diagram are given the properties of the cast iron as a whole corresponding to these stages, and still lower the purposes for which these stages fit the cast iron, first because of its strength and shock-resisting power, and second because of its hardness.

115. *Influence of the Constitution of Cast Iron on its Properties.*—How should the hardness, strength and ductility, or rather shock-resisting power, of the cast iron be affected by this progressive change from graphite into cementite? First, the hardness (VU) should increase progressively as the soft ferrite and graphite are replaced by the glass-hard cementite. Second, though the brittleness should be lessened somewhat by the decrease in the extent to which the continuity of the strong matrix is broken up by the graphite skeleton, yet this effect is outweighed greatly by that of the rapid substitution in the matrix of the brittle cementite for the very ductile copper-like ferrite, so that the brittleness increases continuously (RS), from that of the very grey graphitic cast irons, which, like that of soapstone, is so slight that the metal can endure severe shock and even indentation without breaking, to that of the pure white cast iron, which is so brittle that it shatters. Here let us recognize that what gives this transfer of carbon from graphite skeleton to metallic matrix such very great influence on the properties of the metal is the fact that the transfer of each 1% of carbon means substituting in the matrix no less than 15% of the brittle, glass-hard cementite for the soft, very ductile ferrite. Third, the tensile strength of steel proper, of which the matrix consists, as we have already seen (fig. 3), increases with the carbon-content till this reaches about 1.25%, and then in turn decreases (fig. 28, DEF). Hence, as with the progressive transfer of the carbon from the graphitic to the cementitic state in our imaginary series of cast irons, the combined carbon present in the matrix increases, so does the tensile strength of the mass as a whole for two reasons; first, because the strength of the matrix itself is increasing (DE), and second, because the discontinuity is decreasing with the decreasing proportion of graphite. With further transfer of the carbon from the graphitic to the combined state, the matrix itself grows weaker (EF); but this weakening is offset in a measure by the continuing decrease of discontinuity due to the decreasing proportion of graphite. The result of these two effects has not yet been well established; but it is probable that the strongest cast iron has a little more than 1% of carbon combined as cementite, so that its matrix is nearly equivalent to the strongest of the steels. As regards both tensile strength and ductility not only the quantity but the distribution of the graphite is of great importance. Thus it is extremely probable that the primary graphite, which forms large sheets, is much more weakening and embrittling than the eutectic and other forms, and therefore that, if either strength or ductility is sought, the metal should be free from primary graphite, i.e. that it should not be hyper-eutectic.

The presence of graphite has two further and very natural effects. First, if the skeleton which it forms is continuous, then its planes of junction with the metallic matrix offer a path of low resistance to the passage of liquids or gases, or in short they make the metal so porous as to unfit it for objects like the cylinders of hydraulic presses, which ought to be gas-tight and water-tight. For such purposes the graphite-content should be low. Second, the very great bulk of graphite (the quantity of primary and eutectic graphite while the metal is solidifying (fig. 5) causes a sudden and permanent expansion, which forces the metal into even the finest crevices in its mould, a fact which is taken advantage of in making ornamental castings and others in which need great sharpness of detail, by making them rich in graphite.

To sum this up, as graphite is replaced by carbon combined as cementite, the hardness, brittleness and density increase, and the expansion in solidification decreases, in both cases continuously, while the tensile strength increases till the combined carbon-content rises a little above 1%, and then in turn decreases. That strength is good and brittleness bad goes without saying; but here a word is needed about hardness. The expense of cutting castings accurately to shape, cutting on them screw threads and what not, called "machining" in trade parlance, is often a very large part of their total cost; and it increases rapidly with the hardness of the metal. On the other hand, the extreme hardness of nearly graphiteless cast iron is of great value for objects of which the chief duty is to resist abrasion, such as parts of cranes and mill-work. Hence objects which need much machining are made rich in graphite, so that they may be cut easily, and those of the latter class rich in cementite so that they may not wear out.

116. *Means of controlling the Constitution of Cast Iron.*—The distribution of the carbon between these two states, so as to give the cast iron the properties needed, is brought about chiefly by



silicon equals 1.66, there will be no blowholes; if this sum is less, blowholes will occur, and will be injuriously near the surface unless this sum is reduced to 0.28. He thus finds that this sum should be either as great as 1.66, so that blowholes shall be absent; or as low as 0.28, so that they shall be harmlessly deep-seated. These numbers must be varied with the variations in other conditions, such as casting temperature, rapidity of solidification, &c.

123. *Segregation*.—The solidification of an ingot of steel takes place gradually from without inwards, and each layer in solidifying tends to expel into the still molten interior the impurities which it contains, especially the carbon, phosphorus, and sulphur, which by this process are in part concentrated or segregated in the last-freezing part of the ingot. This is in general around the lower part of the pipe, so that here is a second motive for rejecting the piped part of the ingot. While segregation injures the metal here, often fatally, by giving it an indeterminate excess of phosphorus and sulphur, it clearly purifies the remainder of the ingot, and on this account it ought, under certain conditions, to be promoted rather than restrained. The following is an extreme case:—

	Carbon.	Silicon.	Manganese.	Phosphorus.	Sulphur.
Composition of the initial metal per cent	0.24	0.336	0.97	0.089	0.074
Composition of the segregate	1.27	0.41	1.08	0.753	0.418

The surprising fact that the degree of segregation does not increase greatly either with the slowness of solidification or with the size of the ingot, at least between the limits of 5 in. sq. and 16 in. sq., has been explained by the theory that the relative quiet due to the gentleness of the convection currents in a slowly cooling mass favours the formation of far outshooting pine-tree crystals, and that the tangled branches of these crystals landlock much of the littoral molten mother metal, and thus mechanically impede that centward diffusion and convection of the impurities which is the essence of segregation.

124. *Castings and Forgings*.—There are two distinct ways of making the steel objects actually used in the arts, such as rails, gear wheels, guns, beams, &c., out of the molten steel made by the Bessemer, open hearth, or crucible process, or in an electric furnace. The first is by "steel founding," i.e. casting the steel as a "steel casting" in a mould which has the exact shape of the object to be made, e.g. a gear wheel, and letting it solidify there. The second is by casting it into a large rough block called an "ingot," and rolling or hammering this out into the desired shape. Though the former certainly seems the simpler way, yet its technical difficulties are so great that it is in fact much the more expensive, and therefore it is in general used only in making objects of a shape hard to give by forging or rolling. These technical difficulties are due chiefly to the very high melting point of the metal, nearly 1500° C. (2732° F.), and to the consequent great contraction which it undergoes in cooling through the long range between this temperature and that of the room. The cooling of the thinner, the outer, and in general the more exposed parts of the casting outruns that of the thicker and less exposed parts, with the consequence that, at any given instant, the different parts are contracting at very different rates, i.e. aeolotachically; and this aeolotachic contraction is very likely to concentrate severe stress on the slowest cooling parts at the time when they are passing from the molten to the solid state, when the steel is mushy, with neither the fluidity of a liquid nor the strength and ductility of a solid, and thus to tear it apart. Aeolotachic contraction further leads to the "pipes" or contraction cavities already described in § 121, and the procedure must be carefully planned first so as to reduce these to a minimum, and second so as to induce them to form either in those parts of the casting which are going to be cut off and re-melted, or where they will do little harm. These and kindred difficulties make each new shape or size a new problem, and in particular they require that for each and every individual casting a new sand or clay mould shall be made with care by a skilled workman. If a thousand like gears are to be cast, a thousand moulds must be made up, at least to an important extent by hand, for even machine moulding leaves something for careful manipulation by the moulder. It is a detail, one is tempted to say a retail, manufacture.

In strong contrast with this is the procedure in making rolled

products such as rails and plates. The steel is cast in lots, weighing in some cases as much as 75 tons, in enduring cast iron moulds into very large ingots, which with their initial heat are immediately rolled down by a series of powerful roll trains into their final shape with but slight wear and tear of the moulds and the machinery. But in addition to the greater cost of steel founding as compared with rolling there are two facts which limit the use of steel castings: (1) they are not so good as rolled products, because the kneading which the metal undergoes in rolling improves its quality, and closes up its cavities; and (2) it would be extremely difficult and in most cases impracticable to cast the metal directly into any of the forms in which the great bulk of the steel of commerce is needed, such as rails, plates, beams, angles, rods, bars, and wire, because the metal would become so cool as to solidify before running far in such thin sections, and because even the short pieces which could thus be made would pucker or warp on account of their aeolotachic contraction.

125. *Heating Furnaces* are used in iron manufacture chiefly for bringing masses of steel or wrought iron to a temperature proper for rolling or forging. In order to economize power in these operations, the metal should in general be as soft and hence as hot as is consistent with its reaching a low temperature before the rolling or forging is finished, because, as explained in § 32, undisturbed cooling from a high temperature injures the metal. Many of the furnaces used for this heating are in a general way like the puddling furnace shown in fig. 14, except that they are heated by gas, that the hearth or bottom of the chamber in which they are heated is nearly flat, and that it is usually very much larger than that of a puddling furnace. But in addition there are many special kinds of furnaces arranged to meet the needs of each case. Of these two will be shown here, the Gjers soaking pit for steel ingots, and the Eckman or continuous furnace, as modified by C. H. Morgan for heating billets.

126. *Gjers Soaking Pit*.—When the outer crust of a large ingot in which a lot of molten steel has been cast has so far cooled that it can be moved without breaking, the temperature of the interior is still far above that suitable for rolling or hammering—so far above that the surplus heat of the interior would more than suffice to reheat the now cool crust to the rolling temperature, if we could only arrest or even greatly retard the further escape of heat from that crust. Bringing such an ingot, then, to the rolling temperature is not really an operation of heating, because its average temperature is already above the rolling temperature, but one of equalizing the temperature, by allowing the internal excess of heat to "soak" through the mass. Gjers did this by setting the partly-solidified ingot in a well-closed "pit" of brickwork, preheated by the excess heat of previous lots of ingots. The arrangement, shown in fig. 31, has three advantages—(1) that the temperature is adjusted with absolutely no consumption of fuel; (2) that the waste of iron due to the oxidation of the outer crust of the ingot is very slight, because the little atmospheric oxygen initially in the pit is not renewed, whereas in a common heating furnace the flame brings a constant fresh supply of oxygen; and (3) that the ingot remains upright during solidification, so that its pipe is concentrated at one end and is thus removable. (See § 121.) In this form the system is rather inflexible, for if the supply of ingots is delayed the pits grow unduly cool, so that the next ensuing lot of ingots either is not heated hot enough or is delayed too long in soaking. This defect is usually remedied by heating the pits by the Siemens regenerative system (see § 99); the greater

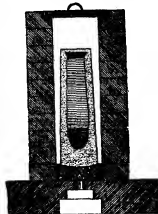

FIG. 31.—Section of Gjers Soaking Pit.



flexibility thus gained outweighs the cost of the fuel used and the increased loss of iron by oxidation by the Siemens gas flame.

127. *Continuous Heating Furnace.*—The Gjers system is not applicable to small ingots or "billets,"<sup>1</sup> because they lack the inner surplus heat of large ingots; indeed, they are now allowed to cool completely. To heat these on the intermittent plan for further rolling, *i.e.* to charge a lot of them as a whole in a heating furnace, bring them as a whole to rolling temperature, and then withdraw them as a whole for rolling, is very wasteful of heat, because it is only in the first part of the heating that the outside of the ingots is cool enough to abstract thoroughly the heat from the flame. During all the latter part of the heating, when the temperature of the ingot has approached that of the flame, only an ever smaller and smaller part of the heat of that flame can be absorbed by the ingots. Hence in the intermittent system most of the heat generated within the furnace escapes from it with the products of combustion. The continuous heating system (fig. 32) recovers this heat by bringing the flame into contact

the metal into the desired shape. In forging, whether under a hammer or under a press, the action is evidently a squeeze, however skillfully guided. In drawing, the pull of the pincers (fig. 33) upon the protruding end, F, of the rod, transmitted to the still undrawn part, E, squeezes the yielding metal of the rod against the hard unyielding die, C. As when a half-opened umbrella is thrust ferrule-foremost between the balusters of a staircase, so when the rod is drawn forward, its yielding metal is folded and forced backwards and centrewards by the resistance of the unyielding die, and thus it is reduced in diameter and simultaneously lengthened proportionally, without material change of volume or density.

Fig. 33.—Wire undergoing Reduction in the Die.

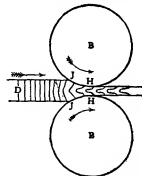

129. *Methods of Rolling.*—Of rolling much the same is true. The rolling mill in its simplest form is a pair of cylindrical rollers, BB (figs. 34 and 35) turning about their axes in opposite directions as shown by the arrows, and supported at their ends in strong frames called " housings," CC (fig. 35). The skin of the object, D, which is undergoing rolling, technically called "the piece," is drawn forward powerfully by the friction of the revolving rolls, and especially of that part of their surface which at any given instant is moving horizontally (HH in fig. 34), much as, the rod is drawn through the die in fig. 33, while the vertical component of the motion of the rear part JJ of the rolls forces the plastic metal of that part of "the piece" with which they are in contact backwards and centrewards, reducing its area and simultaneously lengthening it proportionally, here again as in drawing through a die. The rolls thus both draw the piece forward like the pincers of a wire die, and themselves are a die which like a river ever renews or rather maintains its fixed shape and position, though its particles themselves are moving constantly forward with "the piece" which is passing between them.

Fig. 34.—Two-high Rolling Mill.

After the piece has been reduced in thickness by its first passage or "pass" between the rolls, it may be given a second reduction and then a third and so on, either by bringing the two rolls nearer together, as in case of the plain rolls BB at the left in fig. 35; or by passing the piece through an aperture, F', smaller than the first F, as in case of the grooved rolls, AA, shown at the right, or by both means jointly. If, as sketched in fig. 34, the direction in which each of the rolls turns is constant, then after the piece has passed once through the rolls to the right, it cannot undergo a second pass till it has been brought back to its initial position at the left. But bringing it back

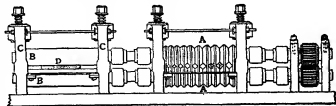

Fig. 35.—Two-high Rolling Mill.

wastes power and, still worse, time, heat, and metal, because the yellow- or even white-hot piece is rapidly cooling down and oxidizing. In order to prevent this waste the direction in which the rolls move may be reversed, so that the piece may be reduced a second time in passing to the left, in which case the rolls are usually driven by a pair of reversing engines; or the rolls may

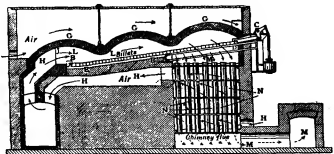

Fig. 32.—Diagram of C. H. Morgan's Continuous Heating Furnace for 2-inch billets 30 ft. long.

- A, Hottest billet ready for rolling.
- B, Exit door.
- C, Pusher, for forcing billets forward.
- D, Water-cooled pipe on which billets are pushed forward.
- E, Magnesite bricks on which the hot billets slide forward.
- F, The billet last entered.
- G, The suspended roof.
- H, The incoming air preheated by G and by the pipes N and brought from above G to between N by a flue not shown.
- J, The incoming gas.
- L, The flame.
- M, The escaping products of combustion.
- N, Pipes through which the products of combustion pass.

with successively cooler and cooler billets, A-F, and finally with quite cold ones, of consequently great heat-absorbing capacity.

As soon as a hot billet A is withdrawn by pushing it endwise out of the exit door B, the whole row is pushed forward by a set of mechanical pushers C, the billets sliding on the raised water-cooled pipes D, and, in the hotter part of the furnace, on the magnesite bricks E, on which iron slides easily when red-hot. A new cold billet is then charged at the upper end of the hearth, and the new cycle begins by pushing out through B a second billet, and so forth. To lessen the loss in shape of "crop ends," and for general economy, these billets are in some cases 30 ft. long as in the furnace shown in fig. 32. It is to make it wide enough to receive such long billets that its roof is suspended, as here shown, by two sets of iron tie-rods. As the foremost end of the billet emerges from the furnace it enters the first of a series of roll-trains, and passes immediately thence to others, so that before half of the billet has emerged from the furnace its front end has already been reduced by rolling to its final shape, that of merchant-bars, which are relatively thin, round or square rods, in lengths of 300 ft. In the intermittent system the waste heat can, it is true, be utilized either for raising steam (but inefficiently and inconveniently, because of the intermittency), or by a regenerative method like the Siemens, Fig. 10; but this would probably recover less heat than the continuous system, first, because it transfers the heat from flame to metal indirectly instead of directly; and, second, because the brick-work of the Siemens system is probably a poorer heat-catcher than the iron billets of the continuous system, because its disadvantages of low conductivity and low specific heat probably outweigh its advantages of roughness and porosity.

128. *Rolling, Forging, and Drawing.*—The three chief processes for shaping iron and steel, rolling, forging (*i.e.* hammering, pressing or stamping) and drawing, all really proceed by squeezing

<sup>1</sup> A "billet" is a bar, 5 in. sq. or smaller, drawn down from a bloom, ingot, or pile for further manufacture.

be "three high," as shown in fig. 36, with the upper and the lower roll moving constantly to the right and the middle roll constantly to the left, so that the piece first passes to the right between the middle and lower rolls, and then to the left between the middle and upper rolls. The advantage of the



FIG. 36.—Three-high Rolling Mill.

"reversing" system is that it avoids lifting the piece from below to above the middle roll, and again lowering it, which is rather difficult because the white-hot piece cannot be guided directly by hand, but must be moved by means of hooks, tongs, or even complex mechanism. The advantage of the three-high mill is that, because each of its moving parts is always moving in the same direction, it may be driven by a relatively small and hence cheap engine, the power delivered by which between the passes is taken up by a powerful fly-wheel, to be given up to the rolls during the next pass. (See also ROLLING MILL.)

130. *Advantages and Applicability of Rolling.*—Rolling uses very much less power than drawing, because the friction against the fixed die in the latter process is very great. For much the same reason rolling proceeds much faster than drawing, and on both these accounts it is incomparably the cheaper of the two. It is also very much cheaper than forging, in large part because it works so quickly. The piece travels through the rolls very rapidly, so that the reduction takes place over its whole length in a very few seconds, whereas in forging, whether under hammer or press, after one part of the piece has been compressed the piece must next be raised, moved forward, and placed so that the hammer or press may compress the next part of its length. This moving is expensive, because it has to be done, or at least guided, by hand, and it takes up much time, during which both heat and iron are wasting. Thus it comes about that rolling is so very much cheaper than either forging or drawing that these latter processes are used only when rolling is impracticable. The conditions under which it is impracticable are (1) when the piece has either an extremely large or an extremely small cross section, and (2) when its cross section varies materially in different parts of its length. The number of great shafts for marine engines, reaching a diameter of 22½ in. in the case of the "Lusitania," is so small that it would be wasteful to install for their manufacture the great and costly rolling mill needed to reduce them from the gigantic ingots from which they must be made, with its succession of decreasing passes, and its mechanism for rotating the piece between passes and for transferring it from pass to pass. Great armour plates can indeed be made by rolling, because in making such flat plates the ingot is simply rolled back and forth between a pair of plain cylindrical rolls, like BB of fig. 35, instead of being transferred from one grooved pass to another and smaller one. Moreover, a single pair of rolls suffices for armour plates of any width or thickness, whereas if shafts of different diameters were to be rolled, a special final groove would be needed for each different diameter, and, as there is room for only a few large grooves in a single set of rolls, this would imply not only providing but installing a separate set of rolls for almost every diameter of shaft. Finally the quantity of armour plate needed is so enormous that it justifies the expense of installing a great rolling mill. Krupp's armour-plate mill, with rolls 4 ft. in diameter and 12 ft. long, can roll an ingot 4 ft. thick.

Pieces of very small cross section, like wire, are more conveniently made by drawing through a die than by rolling, essentially because a single draft reduces the cross section of a wire much more than a single pass between rolls can. This in turn is because the direct pull of the pincers on the protruding end of the wire is much stronger than the forward-drawing pull due to the friction of the cold rolls on the wire, which is necessarily cold because of its small section.

Pieces which vary materially in cross section from point to point in their length cannot well be made by rolling, because the cross section of the piece as it emerges from the rolls is

necessarily that of the aperture between the rolls from which it is emerging, and this aperture is naturally of constant size because the rolls are cylindrical. Of course, by making the rolls eccentric, and by varying the depth and shape of the different parts of a given groove cut in their surface, the cross section of the piece made in this groove may vary somewhat from point to point. But this and other methods of varying the cross section have been used but little, and they do not seem capable of wide application.

The fact that rolling is so much cheaper than forging has led engineers to design their pieces so that they can be made by rolling, *i. e.* to make them straight and of uniform cross section. It is for this reason, for instance, that railroad rails are of constant uniform section throughout their length, instead of having those parts of their length which come between the supporting ties deeper and stronger than the parts which rest on the ties. When, as in the case of eye bars, it is imperative that one part should differ materially in section from the rest, this part may be locally thickened or thinned, or a special part may here be welded on. When we come to pieces of very irregular shape, such as crank-shafts, anchors, trunnions, &c., we must resort to forging, except for purposes for which unforced castings are good enough.

131. *Forging* proceeds by beating or squeezing the piece under treatment from its initial into its final shape, as for instance by hammering a square ingot or bloom first on one corner and then on another until it is

reduced to a cylindrical shape as shown at A in fig. 37. As the ingot is reduced in section, it is of course lengthened proportionally. Much as in the smith's forge the object forged rests on a massive anvil and anvil block, B and C, and is struck by the tup D of the hammer. This tup is raised and driven down by steam pressure applied below or above the piston E of the steam cylinder mounted aloft and connected with the tup by means of the strong piston-rod F. The demand for very large forgings, especially for guns and armour plate, led to the building of enormous steam hammers.

The falling parts of the largest of these, that at Bethlehem, Pa., weigh 125 tons. The first cost of a hammer of moderate size is much less than that of a hydraulic press of like capacity, as is readily understood when we stop to reflect what powerful pressure, if gradually applied, would be needed to drive the nail which a light blow from our hand hammer forces easily into the woodwork. Nevertheless the press uses much less power than the hammer, because much of the force of the latter is dissipated in setting up useless—indeed harmful, and at times destructive—vibrations in the foundations and the surrounding earth and buildings. Moreover, the effect of the sharp blow of the hammer is relatively superficial, and does not penetrate to the interior of a large piece as the slowly applied pressure of the hydraulic press does. Because of these facts the great hammers have given place to enormous forging presses, the 125-ton Bethlehem hammer, for instance, to a 14,000-ton hydraulic press, moved by water under a pressure of

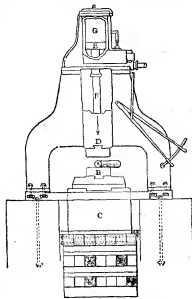

FIG. 37.—Steam Hammer.

- A, Round bar to be hammered.
- B, Anvil.
- C, Anvil block or foundation.
- D, Falling tup.
- E, Steam piston.
- F, Piston-rod for lifting tup and driving it down.
- G, Steam cylinder.

1,000 lb per square inch, supplied by pumps of 16,000 horse power.

132. *Statistics.*—The cheapening of manufacture by improvements in processes and machinery, and by the increase in the scale of operations, has been very great. The striking examples of it shown in Table IV. are only typical of what has been going on continuously

In this same period the production of Great Britain increased 28%, and that of the world more than tripled. The corresponding changes in the case of steel are even more striking. The United States production in 1907 was 1714 times that of 1865, and the proportion which it formed of the world's steel rose from 3% in 1865 to 10% in 1870, 30% in 1880; 36% in 1890, 40% in 1899 and 46% in 1907. In 1907 the British steel production was nearly five times, that of the

TABLE IV.—Reduction in Cost of Iron Manufacture in America—C. Kirchoff.

Place represented.	Operation represented.	Period covered.		Cost, Profit and Production at End of Period in Percentage of that at Beginning of Period.						
		From	To	Cost.				Profit per Ton.	Production per Furnace, &c., per Day.	
				Ore.	Fuel.	Labour.	Total.			
A large Southern Establishment	Manufacture of Pig Iron	1889	1898	79	64.1	51.9	63.4	..	47.9	167.7
North-eastern District . . . . .	" "	1890	1898	103.7	97	61.1	65.8	..	33.9	163.3
Pittsburg District . . . . .	" "	1887	1897	..	..	46	..	44	..	..
Eastern District . . . . .	Manufacture of Bessemer Steel Ingots	1891	1898	..	..	75	64.39	..	..	107
Pittsburg . . . . .	" "	1887	1897	..	..	..	..	52	..	..
Not stated . . . . .	Rolling Wire Rods	1888	1898	..	..	..	63.6	..	..	325

since 1868. Note, for instance, a reduction of some 35% in the total cost, and an even greater reduction in the cost of labour, reaching in one case 54%, in a period of between seven and ten years. This great economy is not due to reduction in wages. According to Mr Carnegie, in one of the largest American steel works the average wages in 1900 for all persons paid by the day, including labourers, mechanics and boys, were more than \$4 (say, 16s. 6d.) a day for the 311 working days. How economical the methods of mining, transportation and manufacture have become is shown by the fact that steel billets have been sold at \$13.96 (£2, 17s. 8d.) per ton, and in very large quantities at \$15 (£3, 2s.) per ton in the latter case, according to Mr Carnegie, without further loss than that represented by interest, although the cost of each ton includes that of mining 2 tons of ore and carrying them 100 miles, mining and coking 1.3 tons of coal and carrying its coke 50 m., and quarrying one-third of a ton of limestone and carrying it 140 m., besides the cost of smelting the ore, converting the resultant cast iron into steel, and rolling that steel into rails.

TABLE V.—Reduction in Price of Certain Products.

Date.	Yearly average Price in Pennsylvania, gross tons.			
	Bar (Wrought) Iron.	Wrought Iron Rails.	Steel Rails.	No. 1 Foundry Pig Iron.
1800	\$100.50			
1815	144.50			
1824	82.50			
1837	111.00			
1850	59.54	\$47.88		\$20.88
1865	106.46	98.62	\$158.46 <sup>1</sup>	46.08
1870	78.96	72.25	106.79	33.23
1880	62.04	49.25	67.52	28.48
1890	45.83	25.18 <sup>2</sup>	31.78	18.41
1898	28.65	12.39 <sup>2</sup>	17.62	11.66
1900	44.00	19.51 <sup>2</sup>	32.29	19.98
1906	..	23.03 <sup>2</sup>	28.00	20.98
1908 <sup>1</sup>	31.00	18.25 <sup>2</sup>	28.00	17.65

<sup>1</sup> July 1st. <sup>2</sup> Old, i.e. second-hand wrought iron rails. <sup>3</sup> 1868.

Table V. shows the reduction in prices. The price of wrought iron in Philadelphia reached \$155 (£32, os. 8d.) in 1815, and, after declining to \$80 (£16, 10s. 8d.), again reached \$115 (£23, 15s. 4d.) in 1837. Bessemer steel rails sold at \$174 in the depreciated currency of 1868 (equivalent to about £25, 17s. 4d. in gold), and at \$17 (£3, 10s. 3d.) in 1898.

133. *Increase in Production.*—In 1810 the United States made about 7%, and in 1830, 1850 and 1860 not far from 10% of the world's production of pig iron, though, indeed, in 1820 their production was only about one-third as great as in 1810. But after the close of the Civil War the production increased by leaps and bounds, till in 1907 it was thirty-one times as great as in 1865; and the percentage which it formed of the world's production rose to some 14% in 1870, 21% in 1880, 35% in 1900 and 43% in 1907. In this last year the United States production of pig iron was nearly 7 times, and that of Germany and Luxemburg nearly 5 times, that of 1880.

United States nearly nineteen times, as great as in 1880. Of the combined wrought iron and steel of the United States, steel formed only 2% in 1865, but 37% in 1880, 85% in 1899 and 91% in 1907. Thus in the nineteen years between 1880 and 1899 the age of iron gave place to that of steel.

The *per capita* consumption of iron in Great Britain, excluding exports, has been calculated as 144 lb in 1855 and 250 lb in 1890, that of the United States as 117 lb for 1855, 300 lb for 1890 and some 378 lb for 1899, and that of the United Kingdom, the United States and Germany for 1906 as about a quarter of a ton, so that the British *per capita* consumption is about four-fold and the American about five-fold that of 1855. This great increase in the *per capita* consumption of iron by the human race is of course but part of the general advance in wealth and civilization. Among the prominent causes of this increase is the diversion of mankind from agricultural to manufacturing, i.e. machinery-using work, nearly all machinery being necessarily made of iron. This diversion may be unwelcome, but it is inevitable for the two simple reasons that the wonderful improvements in agriculture decrease the number of men needed to raise a given quantity of food, i.e. to feed the rest of the race; and that with every decade our food forms a smaller proportion of our needs, so rapidly do these multiply and diversify. Among the other causes of the increase of the *per capita* consumption of iron are the displacement of wood by iron for ships and bridge-building; the great extension of the use of iron beams, columns and other pieces in constructing buildings of various kinds; the growth of steam and electric railways; and the introduction of iron fencing. The increased importance of Germany and Luxemburg may be referred in large part to the invention of the basic Bessemer and open-hearth processes by Thomas, who by them gave an inestimable value to the phosphoric ores of these countries. That of the United States is due in part to the growth of its population; to the introduction of labour-saving machinery in iron manufacture; to the grand scale on which this manufacture is carried on; and to the discovery of the cheap and rich ores of the Mesabi region of Lake Superior. But, given all these, the 1000 m. which separate the ore fields of Lake Superior from the cheap coal of Pennsylvania would have handicapped the American iron industry most seriously but for the remarkable cheapening of transportation which has occurred. As this in turn has been due to the very men who have developed the iron industry, it can hardly be questioned that, on further analysis, this development must in considerable part be referred to racial qualities. The same is true of the German iron development. We may note with interest that the three great iron producers so closely related by blood—Great Britain, the United States and Germany and Luxemburg—made in 1907 81% of the world's pig iron and 83% of its steel; and that the four great processes by which nearly all steel and wrought iron are made—the puddling, crucible and both the acid and basic varieties of the Bessemer and open-hearth processes, as well as the steam-hammer and grooved rolls for rolling iron and steel—were invented by Britons, though in the case of the open-hearth process Great Britain must share with France the credit of the invention.

Tables VI., VII., VIII. and IX. are compiled mainly from figures given in J. M. Swank's *Reports* (American Iron and Steel Association). Other authorities are indicated as follows: <sup>a</sup> *The Mineral Industry* (1892); <sup>b</sup> *Idem* (1899); <sup>c</sup> *Idem* (1907); <sup>d</sup> *Journal Iron and Steel Institute* (1881); <sup>e</sup> <sup>f</sup> *Eckel in Mineral Resources of the United States*, (published by the United States Geological Survey, (1906), pp. 92-93.

TABLE VI.—Production of Pig Iron (in thousands of long tons).

Year.	United States.	Great Britain.	Germany and Luxemburg.	The World.
1800	..	..	..	825
1810	54	..	..	1,825
1820	165	677	..	4,750
1850	565	..	..	9,250
1865	832	4825	972	11,900
1870	1,665	5964	1,369	17,950
1880	3,835	7749	2,685	27,157
1890	9,203	7904	4,583	38,973 <sup>a</sup>
1900	13,789	8960	8,386	59,721 <sup>a</sup>
1907	25,781	9924	12,672	..

TABLE VII.—Production of Pig Iron in the United States (in thousands of long tons).

Year.	Anthracite.	Charcoal.	Coke and Bituminous.	Total.
1880	1614	480	1,741	3,835
1885	1299	357	2,389	4,045
1890	2186	628	6,388	9,203
1895	1271	225	7,950	9,446
1900	1677	384	11,728	13,789
1907	1372	437	23,972	25,781

<sup>a</sup> Anthracite " here includes iron made with anthracite and coke mixed, " Bituminous " includes iron made with coke, with raw bituminous coal, or with both, and " Charcoal " in 1900 and 1907 includes iron made either with charcoal alone or with charcoal mixed with coke.

TABLE VIII.—Production of Wrought Iron, also that of Bloomy Iron (in thousands of long tons).

	Wrought Iron.	Bloomy Iron direct from the Ore.
1870.	..	..
United States	1153	..
Great Britain	..	..
1880.	..	..
United States	2083 <sup>(1)</sup>	36
Great Britain	..	..
1890.	..	..
United States	2518 <sup>(1)</sup>	7
Great Britain	1894	..
1899.	..	..
United States	..	3
Great Britain	1202 <sup>a</sup>	..
1900.	..	..
United States	..	4
Great Britain	..	..
1907.	..	..
United States	2200	..
Great Britain	975	..

<sup>1</sup> Hammered products are excluded.

TABLE IX.—Production of Steel (in thousands of long tons).

	Bessemer.	Open-Hearth.	Crucible and Miscellaneous.	Total.
1870.	..	..	..	..
United States	37	1	31	69
Great Britain	215	78	..	292 <sup>a</sup>
The World	(for 1873)	..	..	692 <sup>a</sup>
1880.	..	..	..	..
United States	1,074	101	72	1,247
Great Britain	1,044	251	80	1,375
Germany and Luxemburg	608 <sup>a</sup>	87 <sup>a</sup>	33	728
The World	..	..	..	4,205 <sup>a</sup>
1890.	..	..	..	..
United States	3,689	513	75	4,277
Great Britain	2,015	1,564	100	3,679
Germany and Luxemburg	..	..	..	2,127
The World	..	..	..	11,902 <sup>a</sup>
1900.	..	..	..	..
United States	{Acid 6,685 Basic 0	{853 2,545}	105	10,188
Great Britain	{Acid 1,254 Basic 491}	3,156	149	5,050
Germany and Luxemburg	..	..	..	6,541
The World	..	..	..	28,273
1907.	..	..	..	..
United States	{Acid 11,668 Basic 0	{1,270 10,279}	145	23,363
Great Britain	{Acid 1,280 Basic 579	{3,385 1,270}	..	6,523 <sup>a</sup>
Germany and Luxemburg	{Acid 381 <sup>1</sup> Basic 7,098 <sup>1</sup>	{209 <sup>1</sup> 3,976 <sup>1</sup> }	208 <sup>1</sup>	11,873
The World	..	..	..	50,375

<sup>1</sup> Ingots only. <sup>2</sup> Bessemer and open hearth only. <sup>3</sup> Castings.

TABLE X.—Tonnage (gross register) of Iron and Steel Vessels built under Survey of Lloyd's Registry (in thousands of tons).

	1877.	1880.	1885.	1890.	1895.	1900.	1906.
Wrought Iron	443	460	304	50	8	14	0
Steel	0	35	162	1079	863	1305	1492

TABLE XI.—Production of Iron Ore (in thousands of long tons).

	1905.		1906.		1907.
	Thousands of Long Tons.	Per Cent.	Thousands of Long Tons.	Per Cent.	Thousands of Long Tons.
United States	42,526	37.4	47,750	38.6	51,721
Germany and Luxemburg	23,074	20.3	26,312	21.3	27,260
Great Britain	14,591	12.8	15,500	12.5	15,732
Spain	8,334	7.9	9,209	7.5	..
France	7,279	6.4	8,347	6.7	..
Russia	5,954 <sup>1</sup>	5.2	3,812	3.1	4,330 <sup>2</sup>
Sweden	4,297	3.8	4,431	3.6	..
Austria-Hungary	3,639	3.2	4,024	3.3	..
Other Countries	3,457	3.0	4,297	3.5	..
Total	113,751	100.0	123,773	100.1	..

<sup>1</sup> Calculated from the production of pig iron

<sup>2</sup> Approximately.

(H. M. H.)

**IRON MASK** (*masque de fer*). The identity of the "man in the iron mask" is a famous historical mystery. The person so called was a political prisoner under Louis XIV., who died in the Bastille in 1703. To the mask itself no real importance attaches, though that feature of the story gave it a romantic

interest; there is no historical evidence that the mask he was said always to wear was made of anything but black velvet (*velours*), and it was only afterwards that legend converted its material into iron. As regards the "man," we have the contemporary official journals of Étienne du Junca (d. 1706), the

king's lieutenant at the Bastille, from which we learn that on the 18th of September 1698 a new governor, Bénigne D'Auvergne de Saint-Mars, arrived from the fortress of the Isles Ste Marguerite (in the bay of Cannes), bringing with him "un ancien prisonnier qu'il avait à Pignerol" (Pincero, in Piedmont), whom he kept always masked and whose name remained untold. (Saint-Mars, it may here be noted, had been commandant at Pignerol from the end of 1664 till 1681; he was in charge there of such important prisoners as Fouquet, from 1665 to his death in 1680, and Lauzun, from 1671 till his release in 1681; he was then in authority at Exiles from 1681 to 1687, and at Ste Marguerite from 1687 to 1698). Du Juncu subsequently records that "on Monday the 19th of November 1703, the unknown prisoner, always masked with a black velvet mask, whom M. de Saint-Mars had brought with him from the islands of Ste Marguerite, and had kept for a long time, . . . died at about ten o'clock in the evening." He adds that "this unknown prisoner was buried on the 20th in the parish cemetery of Saint Paul, and was registered under a name also unknown"—noting in the margin that he has since learnt that the name in the register was "M. de Marchiel." The actual name in the register of the parish cemetery of Saint Paul (now destroyed, but a facsimile is still in existence) was "Marchioly"; and the age of the deceased was there given as "about 45."

The identity of this prisoner was already, it will be observed, a mystery before he died in 1703, and soon afterwards we begin to see the fruit of the various legends concerning him which presumably started as early as 1670, when Saint-Mars himself (see below) found it necessary to circulate "fairy tales" (*contes jaunes*). In 1711 the Princess Palatine wrote to the Electress Sophia of Hanover, and suggested that he was an English nobleman who had taken part in a plot of the duke of Berwick against William III. Voltaire, in his *Siècle de Louis XIV* (1751), told the story of the mysterious masked prisoner with many graphic details; and, under the heading of "Ana" in the *Questions sur l'encyclopédie* (Geneva, 1771), he asserted that he was a bastard brother of Louis XIV., son of Mazarin and Anne of Austria. Voltaire's influence in creating public interest in the "man in the mask" was indeed enormous; he had himself been imprisoned in the Bastille in 1717 and again in 1726; as early as 1745 he is found hinting that he knows something; in the *Siècle de Louis XIV* he justifies his account on the score of conversations with de Bernaville, who succeeded Saint-Mars (d. 1708) as governor of the Bastille, and others; and after Heiss in 1770 had identified the "mask" with Mattioli (see below), Voltaire was not above suggesting that he really knew more than he had said, but thought it sufficient to have given the clue to the enigma. According to the Abbé Soulaivre, the duke of Richelieu's advice was to reflect on Voltaire's "last utterances" on the subject. In Soulaivre's *Mémoires* of Richelieu (London, 1790) the masked man becomes (on the authority of an apocryphal note by Saint-Mars himself) the legitimate twin brother of Louis XIV. In 1801 the story went that this scion of the royal house of France had a son born to him in prison, who settled in Corsica under the name of "De Buona Parte," and became the ancestor of Napoleon! Dumas's *Vicomte de Bragelonne* afterwards did much to popularize the theory that he was the king's brother. Meanwhile other identifications, earlier or later, were also supported, in whose case the facts are a sufficient refutation. He was Louis, count of Vermandois, son of Louise de la Vallière (*Mémoires secrets pour servir à l'histoire de Perse*, Amsterdam, 1745); Vermandois, however, died in 1683. He was the duke of Monmouth (*Lettre de Sainte Foy* . . . Amsterdam, 1768), although Monmouth was beheaded in 1685. He was François de Vendôme, duke of Beaufort, who disappeared (and pretty certainly died) at the siege of Candia (1669); Avedick, an Armenian patriarch seized by the Jesuits, who was not imprisoned till 1706 and died in 1711; Fouquet, who undoubtedly died at Pignerol in 1680; and even, according to A. Loquin (1883), Molière!

Modern criticism, however, has narrowed the issue. The "man in the mask" was either (1) Count Mattioli, who became

the prisoner of Saint-Mars at Pignerol in 1679, or (2) the person called Eustache Dauger, who was imprisoned in July 1669 in the same fortress. The evidence shows conclusively that these two were the only prisoners under Saint-Mars at Pignerol who could have been taken by him to the Bastille in 1698. The arguments in favour of Mattioli (first suggested by Heiss, and strongly supported by Topin in 1870) are summed up, with much weight of critical authority, by F. Funck-Brentano in vol. lvi. of the *Revue historique* (1894); the claims of Eustache Dauger were no less ably advocated by J. Lair in vol. ii. of his *Nicolas Fouquet* (1890). But while we know who Mattioli was, and why he was imprisoned, a further question still remains for supporters of Dauger, because his identity and the reason for his incarceration are quite obscure.

It need only be added, so far as other modern theories are concerned, that in 1875 M. Jung (*La Vérité sur le masque de fer*) had brought forward another candidate, with the attractive name of "Marchiel," a soldier of Lorraine who had taken part in a poisoning plot against Louis XIV., and was arrested at Peronne by Louvois in 1673, and said to be lodged in the Bastille and then sent to Pignerol. But Jung's arguments, though strong destructively against the Mattioli theory, break down as regards any valid proof either that the prisoner arrested at Peronne was a Bastille prisoner in 1673 or that he was ever at Pignerol, where indeed we find no trace of him. Another theory, propounded by Captain Baerles (*La Mousquet*, 1883), identified the prisoner with General du Bulonde, punished for cowardice at the siege of Cuneo; but Bulonde only went to Pignerol in 1691, and has been proved to be living in 1705.

*The Mattioli Theory*.—Erocle Antonio Mattioli (born at Bologna on the 1st of December 1640) was minister of Charles IV., duke of Mantua, who as marquis of Montferrat was in possession of the frontier fortress of Casale, which was coveted by Louis XIV. He negotiated the sale of Casale to the French king for 100,000 crowns, and himself received valuable presents from Louis. But on the eve of the occupation of Casale by the French, Mattioli—actuated by a tardy sense of patriotism or by the hope of further gain—betrayed the transaction to the governments of Austria, Spain, Venice and Savoy. Louis, in revenge, had him kidnapped (1679) by the French envoy, J. F. d'Estrades, abbé of Moissac, and Mattioli was promptly lodged in the fortress of Pignerol. This kidnapping of Mattioli, however, was no secret, and it was openly discussed in *La Prudence triomphante de Casale* (Cologne, 1682), where it was stated that Mattioli was masked when he was arrested. In February 1680 he is described as nearly mad, no doubt from the effects of solitary confinement. When Saint-Mars was made governor of Exiles in 1681 we know from one of his letters that Mattioli was left at Pignerol; but in March 1694, Pignerol being about to be given up by France to Savoy, he and two other prisoners were removed with much secrecy to Ste Marguerite, where Saint-Mars had been governor since 1687. Funck-Brentano emphasizes the fact that, although Eustache Dauger was then at Ste Marguerite, the king's minister Barbezieux, writing to Saint-Mars (March 20, 1694) about the transfer of these prisoners, says: "You know that they are of more consequence (*plus de conséquence*), at least one" (presumably Mattioli), "than those who are at present at the island." From this point, however, the record is puzzling. A month after his arrival at Ste Marguerite, a prisoner who had a valet died there.<sup>1</sup> Now Mattioli undoubtedly had a valet at Pignerol, and nobody else at Ste Marguerite is known at this time to have had one; so that he may well have been the prisoner who died. In that case he was clearly not "the mask" of 1698 and 1703. Funck-Brentano's attempt to prove that Mattioli did not die in 1694 is far from convincing; but the assumption that he did is inferential, and to that extent arguable. "Marchioly" in the burial register of Saint Paul naturally suggests indeed at first that the "ancien prisonnier" taken by Saint-Mars to the Bastille in 1698 was Mattioli, Saint-Mars himself sometimes

<sup>1</sup> Barbezieux to Saint-Mars, May 10, 1694: "J'ai reçu la lettre que vous avez pris la peine de m'écrire le 20 du mois passé; vous pouvez, suivant que vous le proposez, faire mettre dans la prison votre le valet du prisonnier qui est mort." It may be noted that Barbezieux had recently told Saint-Mars to designate his prisoners by circumlocutions in his correspondence, and not by name.

writing the name "Marthioly" in his letters; but further consideration leaves this argument decidedly weak. In any case the age stated in the burial register, "about 45," was fictitious, whether for Mattioli (63) or Dauger (at least 53); and, as Lair points out, Saint-Mars is known to have given false names at the burial of other prisoners. Monsignor Barnes, in *The Man of the Mask* (1908), takes the entry "Marchioly" as making it certain that the prisoner was not Mattioli, on the ground (1) that the law<sup>1</sup> explicitly ordered a false name to be given, and (2) that after hiding his identity so carefully the authorities were not likely to give away the secret by means of a burial register.

In spite of Funck-Brentano it appears practically certain that Mattioli must be ruled out. If he was the individual who died in 1703 at the Bastille, the obscurity which gathered round the nameless masked prisoner is almost incomprehensible, for there was no real secret about Mattioli's incarceration. The existence of a "legend" as to Dauger can, however, be traced, as will be seen below, from the first. Any one who accepts the Mattioli theory must be driven, as Lang suggests, to suppose that the mystery which grew up about the unknown prisoner was somehow transferred to Mattioli from Dauger.

*The Dauger Theory.*—What then was Dauger's history? Unfortunately it is only in his capacity as a prisoner that we can trace it. On the 10th of July 1669 Louvois, Louis XIV.'s minister, writes to Saint-Mars at Pignerol that he is sending him "le nommè Eustache Dauger" (Dauger, D'Angers—the spelling is doubtful);<sup>2</sup> whom it is of the last importance to keep with special closeness; Saint-Mars is to threaten him with death if he speaks about anything except his actual needs. On the same day Louvois orders Vauroy, major of the citadel of Dunkirk, to seize Dauger and conduct him to Pignerol. Saint-Mars writes to Louvois (Aug. 21) that Vauroy had brought Dauger, and that people "believe him to be a marshal of France." Louvois (March 26, 1670) refers to a report that one of Fouquet's valets—there was constant trouble about them—had spoken to Dauger, who asked to be left in peace, and he emphasizes the importance of there being no communication. Saint-Mars (April 12, 1670) reports Dauger as "resigné à la volonté de Dieu et du Roy," and (again the legend grows) says that "there are persons who are inquisitive about my prisoner, and I am obliged to tell *contes jaunes pour me moquer d'eux*." In 1672 Saint-Mars proposes—the significance of this action is discussed later—to allow Dauger to act as "valet" to Lauzun; Louvois firmly refuses, but in 1675 allows him to be employed as valet to Fouquet, and he impresses upon Saint-Mars the importance of nobody learning about Dauger's "past." After Fouquet's death (1680) Dauger and Fouquet's other (old-standing) valet La Rivière are put together, by Louvois's special orders, in one lower dungeon; Louvois evidently fears their knowledge of things heard from Fouquet, and he orders Lauzun (who had recently been allowed to converse freely with Fouquet) to be told that they are released. When Saint-Mars is transferred to Exiles, he is ordered to take these two with him, as too important to be in other hands; Mattioli is left behind. At Exiles they are separated and guarded with special precautions; and in January 1687 one of them (all the evidence admittedly pointing to La Rivière) dies. When Saint-Mars is again transferred, in May 1687, to St Marguerite, he takes his "prisoner" (apparently he now has only one—Dauger) with great show of caution; and next year (Jan. 8, 1688) he writes to Louvois that "mon prisonnier" is believed "in all this province" to be a son of Oliver Cromwell, or else the duke of Beaufort (a point which at once rules out Beaufort). In 1691 Louvois's successor, Barbezieux, writes to him about his "prisonnier de vingt ans" (Dauger was first imprisoned in 1669, Mattioli in 1679), and Saint-Mars replies that "nobody has seen him but by myself." Subsequently Barbezieux and the governor continue to write to one another about their "ancien prisonnier"

(Jan. 6, 1696; Nov. 17, 1697). When, therefore, we come to Saint-Mars's appointment to the Bastille in 1698, Dauger appears almost certainly to be the "ancien prisonnier" he took with him.<sup>3</sup> There is at least good ground for supposing Mattioli's death to have been indicated in 1694, but nothing is known that would imply Dauger's, unless it was he who died in 1703.

*Theories as to Dauger's Identity.*—Here we find not only sufficient indication of the growth of a legend as to Dauger, but also the existence in fact of a real mystery as to who he was and what he had done, two things both absent in Mattioli's case. The only "missing link" is the want of any precise allusion to a mask in the references to Dauger. But in spite of du Junca's emphasis on the mask, it is in reality very questionable whether the wearing of a mask was an unusual practice. It was one obvious way of enabling a prisoner to appear in public (for exercise or in travelling) without betrayal of identity. Indeed three years before the arrival of Saint-Mars we hear (*Gazette d'Amsterdam*, March 14, 1695) of another masked man being brought to the Bastille, who eventually was known to be the son of a Lyons banker.

Who then was Dauger, and what was his "past"? We will take first a theory propounded by Andrew Lang in *The Vale's Tragedy* (1903). As the result of research in the diplomatic correspondence at the Record Office in London Mr Lang finds a clue in the affairs of the French Huguenot, Roux de Marsilly, the secret agent for a Protestant league against France between Sweden, Holland, England and the Protestant cantons of Switzerland, who in February 1660 left London, where he had been negotiating with Arlington (apparently with Charles II.'s knowledge), for Switzerland, his confidential valet Martin remaining behind. On the 14th of April 1660 Marsilly was kidnapped for Louis XIV. in Switzerland, in defiance of international right, taken to Paris and on the 22nd of June tortured to death on a trumped-up charge of rape. The duke of York is said to have betrayed him to Colbert, the French ambassador in London. The English intrigue was undoubtedly a serious matter, because the shifty Charles II. was at the same time negotiating with Louis XIV. a secret alliance against Holland, in support of the restoration of Roman Catholicism in England. It would therefore be desirable for both parties to remove anybody who was cognizant of the double dealing. Now Louvois's original letter to Saint-Mars concerning Dauger (July 10, 1669), after dealing with the importance of his being guarded with special closeness, and of Saint-Mars personally taking him food and threatening him with death if he speaks, proceeds as follows (in a second paragraph, as printed in Delort, i. 155, 156):—

"Je mande au Sieur Poupart de faire incessamment travailler à ce que vous désirez, et vous priez préparer les meubles qui sont nécessaires pour la vie de celui que l'on vous amènera, observant que comme ce n'est qu'un valet, il ne lui en faut pas de bien considérables, et je vous ferai rembourser tant de la dépenses des meubles, que de ce que vous désirez pour sa nourriture."

Assuming the words here, "as he is only a valet," to refer to Dauger, and taking into account the employment of Dauger from 1675 to 1680 as Fouquet's valet, Mr Lang now obtains a solution of the problem of why a mere valet should be a political

<sup>2</sup> Funck-Brentano argues that "un ancien prisonnier qu'il avait à Pignerol" (du Junca's words) cannot apply to Dauger, because then du Junca would have added "et à Exiles." But this is decidedly far-fetched; du Junca would naturally refer specially to Pignerol, the fortress with which Saint-Mars had been originally and particularly associated. Funck-Brentano also insists that the references to the "ancien prisonnier" in 1696 and 1697 must be to Mattioli, giving *ancien* the meaning of "late" or "former" (as in the phrase "ancien ministre"), and regarding it as an expression pertinent to Mattioli, who had been at Pignerol with Saint-Mars but not at Exiles, and not to Dauger, who had always been with Saint-Mars. But when he attempts to force du Junca's phrase "un ancien prisonnier qu'il avait à Pignerol" into this sense, he is straining language. The natural interpretation of the word *ancien* is simply "of old standing," and Barbezieux's use of it, coming after Louvois's phrase in 1691, clearly points to Dauger being meant.

<sup>3</sup> This identification had been previously suggested by H. Montaudou in *Revue de la société des études historiques* for 1888, p. 452, and by A. le Grain in *L'Intermédiaire des chercheurs* for 1891, col. 227-228.

<sup>1</sup> He cites Bingham's *Bastille*, i. 27.

<sup>2</sup> It was the common practice to give pseudonyms to prisoners, and this is clearly such a case. Mattioli's prison name was Lestang.

prisoner of so much concern to Louis XIV. at this time. He points out that Colbert, on the 3rd, 10th and 24th of June, writes from London to Louis XIV. about his efforts to get Martin, Roux de Marsilly's valet, to go to France, and on the 1st of July expresses a hope that Charles II. will surrender "the valet." Then, on the 19th of July, Dauger is arrested at Dunkirk, the regular port from England. Mr Lang regards his conclusion as to the identity between these valets as irresistible. It is true that what is certainly known about Martin hardly seems to provide sufficient reason for Eustache Dauger being regarded for so long a time as a specially dangerous person. But Mr Lang's answer on that point is that this humble supernumerary in Roux de Marsilly's conspiracy simply became one more wretched victim of the "red tape" of the old French absolute monarchy.

Unfortunately for this identification, it encounters at once a formidable, if not fatal, objection. Martin, the Huguenot conspirator Marsilly's valet, must surely have been himself a Huguenot. Dauger, on the other hand, was certainly a Catholic; indeed Louvois's second letter to Saint-Mars allowed him (Sept. 10, 1669) gives precise directions as to his being allowed to attend mass at the same time as Fouquet. It may perhaps be argued that Dauger (if Martin) simply did not make bad worse by proclaiming his creed; but against this, Louvois must have known that Martin was a Huguenot. Apart from that, it will be observed that the substantial reason for connecting the two men is simply that both were "valets." The identification is inspired by the apparent necessity of an explanation why Dauger, being a valet, should be a political prisoner of importance. The assumption, however, that Dauger was a valet when he was arrested is itself as unnecessary as the fact is intrinsically improbable. Neither Louvois's letter of July 19, 1669, nor Dauger's employment as valet to Fouquet in 1675 (six years later)—and these are the only grounds on which the assumption rests—prove anything of the sort.

Was Dauger a valet? If Dauger was the "mask," it is just as well to remove a misunderstanding which has misled too many commentators.

1. If Louvois's letter of July 19 be read in connexion with the preceding correspondence it will be seen that ever since Fouquet's incarceration in 1665 Saint-Mars had had trouble over his valets. They fall ill, and there is difficulty in replacing them, or they play the traitor. At last, on the 12th of March 1669, Louvois writes to Saint-Mars to say (evidently in answer to some suggestion from Saint-Mars in a letter which is not preserved): "It is annoying that both Fouquet's valets should have fallen ill at the same time, but you have so far taken such good measures for avoiding inconvenience that I leave it to you to adopt whatever course is necessary." There are then no letters in existence from Saint-Mars to Louvois up to Louvois's letter of July 19, in which he first refers to Dauger; and for three months (from April 22 to July 19) there is a gap in the correspondence, so that the sequence is obscure. The portion, however, of the letter of the 19th of July, cited above, in which Louvois uses the words "ce n'est qu'un valet," does not, in the present writer's judgment, refer to Dauger at all, but to something which had been mooted in the meanwhile with a view to obtaining a valet for Fouquet. This is indeed the natural reading of the letter as a whole. If Louvois had meant to write that Dauger was "only a valet" he would have started by saying so. On the contrary, he gives precise and apparently comprehensive directions in the first part of the letter about how he is to be treated: "Je vous en donne avis par avance, afin que vous puissiez faire accommoder un cachot où vous le mettrez sûrement, observant de faire en sorte que les jours qu'aura le lieu où il sera ne donnent point sur les lieux qui puissent estre abordez de personne, et qu'il y ait assez de portes fermées, les unes sur les autres, pour que vos sentinelles ne puissent bien entendre," &c. Having finished his instructions about Dauger, he then proceeds in a fresh paragraph to tell Saint-Mars that orders have been given to "Sieur Poupart" to do "whatever you shall desire." He is here dealing with a different question; and it is unreasonable to suppose,

and indeed contrary to the style in which Louvois corresponds with Saint-Mars, that he devotes the whole letter to the one subject with which he started. The words "et vous ferez préparer les meubles qui sont nécessaires pour la vie de celui que l'on vous amènera" are not at all those which Louvois would use with regard to Dauger, after what he has just said about him. Why "celui que l'on vous amènera," instead of simply "Dauger," who was being brought, as he has said, by Vauroy? The clue to the interpretation of this phrase may be found in another letter from Louvois not six months later (Jan. 1, 1670), when he writes: "Le roy se remet à vous d'en user comme vous le jugerez à propos à l'égard des valets de Monsieur Fouquet; il faut seulement observer que si vous luy donnez des valets que l'on vous amènera d'icy, il pourra bien arriver qu'ils seront gaignez par avance, et qu'ainsy ils feroient pis que ceux que vous en osteriez présentement." Here we have the identical phrase used of valets whom it is contemplated to bring in from outside for Fouquet; though it does not follow that any such valet was in fact brought in. The whole previous correspondence (as well as a good deal afterwards) is full of the valet difficulty; and it is surely more reasonable to suppose that when Louvois writes to Saint-Mars on the 19th of July that he is sending Dauger, a new prisoner of importance, as to whom "il est de la dernière importance qu'il soit gardé avec une grande sureté," his second paragraph as regards the instructions to "Sieur Poupart" refers to something which Saint-Mars had suggested about getting a valet from outside, and simply points out that in preparing furniture for "celui que l'on vous amènera" he need not do much, "comme ce n'est qu'un valet."

2. But this is not all. If Dauger had been originally a valet, he might as well have been used as such at once, when one was particularly wanted. On the contrary, Louvois flatly refused Saint-Mars's request in 1672 to be allowed to do so, and was exceedingly chary of allowing it in 1675 (only "en cas de nécessité," and "vous pouvez donner le dit prisonnier à M. Fouquet, si son valet venoit à luy manquer et non autrement"). The words used by Saint-Mars in asking Louvois in 1672 if he might use Dauger as Lauzun's valet are themselves significant to the point of conclusiveness: "Il ferait, ce me semble, un bon valet." Saint-Mars could not have said this if Dauger had all along been known to be a valet. The terms of his letter to Louvois (Feb 20, 1672) show that Saint-Mars wanted to use Dauger as a valet simply because he was not a valet. That a person might be used as a valet who was not really a valet is shown by Louvois having told Saint-Mars in 1666 (June 4) that Fouquet's old doctor, Pecquet, was not to be allowed to serve him "soit dans sa profession, soit dans le mestier d'un simple valet." The fact was that Saint-Mars was hard put to it in the prison for anybody who could be trusted, and that he had convinced himself by this time that Dauger (who had proved a quiet harmless fellow) would give no trouble. Probably he wanted to give him some easy employment, and save him from going mad in confinement. It is worth noting that up to 1672 (when Saint-Mars suggested utilizing Dauger as valet to Lauzun) none of the references to Dauger in letters after that of July 19, 1669, suggests his being a valet; and their contrary character makes it all the more clear that the second part of the letter of July 19 does not refer to Dauger.

In this connexion it may be remarked (and this is a point on which Funck-Brentano entirely misinterprets the allusion) that, even in his capacity as valet to Fouquet, Dauger was still regarded as an exceptional sort of prisoner; for in 1679 when Fouquet and Lauzun were afterwards allowed to walk freely all over the citadel, Louvois impresses on Saint-Mars that "le nommé Eustache" is never to be allowed to be in Fouquet's room when Lauzun or any other stranger, or anybody but Fouquet and the "ancien valet," La Rivière, is there, and that he is to stay in Fouquet's room when the latter goes out to walk in the citadel, and is only to go out walking with Fouquet and La Rivière when they promenade in the special part of the fortress previously set apart for them (Louvois's letter to Saint-Mars, Jan. 30, 1670).

Was *Danger James de la Cloche*? In *The Man of the Mask* (1908) Monsignor Barnes, while briefly dismissing Mr Lang's identification with Martin, and apparently not realizing the possibility of reading Louvois's letter of July 19, 1669, as indicated above<sup>1</sup> deals in detail with the history of James de la Cloche, the natural son of Charles II. (acknowledged privately as such by the king) in whom he attempts to unmask the personality of Dauger. Mr Lang, in *The Valet's Tragedy*, had some years earlier ironically wondered why nobody made this suggestion, which, however, he regarded as untenable. The story of James de la Cloche is indeed itself another historical mystery; he abruptly vanishes as such at Rome at the end of 1668, and thus provides a disappearance of convenient date; but the question concerning him is complicated by the fact that a James Henry de Bovere Roano Stuardo, who married at Naples early in 1669 and undoubtedly died in the following August, claiming to be a son of Charles II., makes just afterwards an equally abrupt appearance; in many respects the two men seem to be the same, but Monsignor Barnes, following Lord Acton, here regards James Stuardo as an impostor who traded on a knowledge of James de la Cloche's secret. If the latter then *did not die* in 1669, what became of him? According to Monsignor Barnes's theory, James de la Cloche, who had been brought up to be a Jesuit and knew his royal father's secret profession of Roman Catholicism, was being employed by Charles II. as an intermediary with the Catholic Church and with the object of making him his own private confessor; he returned from Rome at the beginning of 1666, and is then identified by Monsignor Barnes with a certain Abbé Pregnani, an "astrologer" sent by Louis in February 1669 to influence Charles II. towards the French alliance. Pregnani, however, made a bad start by "tipping winners" at Newmarket with disastrous results, and was quickly recalled to France, actually departing on July 5th (French 15th). But he too now disappears, though a letter from Lionne (the French foreign secretary) to Colbert of July 17 (two days before Louvois's letter to Saint-Mars about Dauger) says that he is expected in Paris. Monsignor Barnes's theory is that Pregnani *alias* James de la Cloche, without the knowledge of Charles II., was arrested by order of Louis and imprisoned as Dauger on account of his knowing too much about the French schemes in regard to Charles II. This identification of Pregnani with James de la Cloche is, however, intrinsically incredible. We are asked to read into the Pregnani story a deliberate intrigue on Charles's part for an excuse for having James de la Cloche in England. But this does not at all seem to square with the facts given in the correspondence, and it is hard to understand why Charles should have allowed Pregnani to depart, and should not have taken any notice of his son's "disappearance." There would still remain, no doubt, the possibility that Pregnani, though not James de la Cloche, was nevertheless the "man in the mask." But even then the dates will not suit; for Lionne wrote to Colbert on July 27, saying, "Pregnani has been so slow on his voyage that he has only given me (*m'a rendu*) your despatch of July 4 several days after I had already received those of the 8th and the 11th." Allowing for the French style of dating this means that instead of arriving in Paris by July 18, Pregnani only saw Lionne there at earliest on July 25. This seems to dispose of his being sent to Pignerol on the 19th. Apart altogether, however, from such considerations, it now seems fairly certain, from Mr Lang's further research into the problem of James de la Cloche (see LA CLOCHE), that the latter was identical with the "Prince" James Stuardo who died in Naples in 1669, and that he hoaxed the general of the Jesuits and forged a number of letters purporting to be from Charles II. which were relied on in Monsignor Barnes's book; so that the theory breaks down at all points.

<sup>1</sup> The view taken by Monsignor Barnes of the phrase "*Ce n'est qu'un valet*" in Louvois's letter of July 19, is that (reading this part of the letter as a continuation of what precedes) the mere fact of Louvois's saying that Dauger is only a valet means that that was just what he was not! Monsignor Barnes is rather too apt to employ the method of interpretation by contrastes, on the ground that in such letters the writer always concealed the real facts.

The identification of Dauger thus still remains the historical problem behind the mystery of the "man in the mask." He was not the valet Martin; he was not a valet at all when he was sent to Pignerol; he was not James de la Cloche. The fact nevertheless that he was employed as a valet, even in special circumstances, for Fouquet, makes it difficult to believe that Dauger was a man of any particular social standing. We may be forced to conclude that the interest of the whole affair, so far as authentic history is concerned, is really nugatory, and that the romantic imagination has created a mystery in a fact of no importance.

**AUTHORITIES.**—The correspondence between Saint-Mars and Louvois is printed by J. Delort in *Histoire de la détention des philosophes* (1829). Apart from the modern studies by Lair, Funck-Brentano, Lang and Barnes, referred to above, there is valuable historical matter in the work of Roux-Fazailiac, *Recherches historiques sur l'homme au masque de fer* (1801); see also Marius Topin, *L'Homme au masque de fer* (Paris, 1870), and Loiseleur, *Trois Enigmes historiques* (1882). (H. CH.)

**IRON MOUNTAIN**, a city and the county-seat of Dickinson county, Michigan, U.S.A., about 50 m. W. by N. of Escanaba, in the S.W. part of the Upper Peninsula. Pop. (1900) 9242, of whom 4376 were foreign-born; (1904) 8585; (1910) 9216. It is served by the Chicago & North Western and the Chicago, Milwaukee & Saint Paul railways. The city is situated about 1160 ft. above sea-level in an iron-mining district, and the mining of iron ore (especially at the Great Chapin Iron Mine) is its principal industry. Iron Mountain was settled in 1879, and was chartered in 1880.

**IRONSIDES**, a nickname given to one of great bravery, strength or endurance, particularly as exhibited in a soldier. In English history Ironside or Ironsides first appears as the name of Edmund II., king of the English. In the Great Rebellion it was first given by Prince Rupert to Cromwell, after the battle of Marston Moor in 1644 (see S. R. Gardiner's *History of the Great Civil War*, 1803, vol. ii. p. 1, and *Mercurius civicus*, September 10-26, 1644, quoted there). From Cromwell it was transferred to the troopers of his cavalry, those "God-fearing men," raised and trained by him in an iron discipline, who were the main instrument of the parliamentary victories in the field. This (see S. R. Gardiner, *op. cit.* iv. 179) was first given at the raising of the siege of Pontefract 1648, but did not become general till later.

**IRONTON**, a city and the county-seat of Lawrence county, Ohio, U.S.A., on the Ohio river, about 142 m. E.S.E. of Cincinnati. Pop. (1890) 10,939; (1900) 11,868, of whom 924 were negroes and 714 foreign-born; (1910 census) 13,147. It is served by the Chesapeake and Ohio, the Cincinnati, Hamilton and Dayton, the Norfolk and Western, and the Detroit, Toledo and Ironton railways, and by river steamboats. The city is built on a plain at the base of hills rising from the river bottom and abounding in iron ore and bituminous coal; fire and pottery clay also occur in the vicinity. Besides mining, Ironton has important lumber interests, considerable river traffic, and numerous manufactures, among which are iron, wire, nails, machinery, stoves, fire-brick, pressed brick, terra-cotta, cement, carriages and wagons, and furniture. The total value of its factory product in 1905 was \$4,755,304; in 1900, \$5,410,528. The municipality owns and operates its water-works. Ironton was first settled in 1848, and in 1851 was incorporated.

**IRONWOOD**, a city of Gogebic county, Michigan, U.S.A., on the Montreal river, in the N.W. part of the upper peninsula. Pop. (1890) 7745; (1900) 9705, of whom 4615 were foreign-born; (1910 census) 12,821. It is served by the Chicago and North-Western and the Wisconsin Central railways. The city is situated about 1500 ft. above sea-level in the Gogebic iron-district, and is principally a mining town; some of the largest iron mines in the United States are within the city limits. Ironwood was settled in 1884, and was chartered as a city in 1880.

**IRON-WOOD**, the name applied to several kinds of timber, the produce of trees from different parts of the tropics, and belonging to very different natural families. Usually the wood is extremely hard, dense and dark-coloured, and sink



in water. Several species of *Sideroxylon* (*Sapotaceae*) yield iron-wood, *Sideroxylon cinereum* or *Bojerianum* being the *bois de fer blanc* of Africa and Mauritius, and the name is also given to species of *Metrosideros* (*Myrtaceae*) and *Diospyros* (*Ebenaceae*).

West Indian iron-wood is the produce of *Colubrina reclinata* (and *C. ferruginosa* (*Rhamnaceae*), and of *Aegiphila martinicensis* (*Verbenaceae*). *Ixora* (*Siderodendron*) *triflorum* (*Rubiaceae*) is the *bois de fer* of Martinique, and *Zanthoxylum Pterocarp* (*Rutaceae*) is the iron-wood of Jamaica, while *Robinia Peruvaca* (*Leguminosae*) is described as the iron-wood of Guiana. The iron-wood of India and Ceylon is the produce of *Mesua ferrea* (*Guttiferaceae*). The iron-wood tree of Pegu and Arracan is *Xylia dolabriformis* (*Leguminosae*), described as the most important timber-tree of Burma after teak, and known as *pyingado*. The endemic *bois de fer* of Mauritius, once frequent in the primeval woods, but now becoming very scarce, is *Stadmannia Sideroxylon* (*Sapindaceae*), while *Cosignya pinnata* is known as the *bois de fer* of Judas. In Australia species of *Acacia*, *Casuarina*, *Eucalyptus*, *Melaleuca*, *Myrtus*, and other genera are known more or less widely as iron-wood. Tasmanian iron-wood is the produce of *Notelaea ligustrina* (*Oleaceae*), and is chiefly used for making ships' blocks. The iron-wood or lever-wood of North America is the timber of the American hornbeam, *Ostrya virginica* (*Cupuliferaceae*). In Brazil *Apuleia ferrea* and *Caesalpinia ferrea* yield a kind of iron-wood, called, however, the *Pao ferro* or false iron-wood.

**IRON-WORK**, as an ornament in medieval architecture, is chiefly confined to the hinges, &c., of doors and of church chests, &c. Specimens of Norman iron-work are very rare. Early English specimens are numerous and very elaborate. In some instances not only do the hinges become a mass of scroll work, but the surface of the doors is covered by similar ornaments. In both these periods the design evidently partakes of the feeling exhibited in the stone or wood carving. In the Decorated period the scroll work is more graceful, and, like the foliage of the time, more natural. As styles progressed, there was a greater desire that the framing of the doors should be richer, and the ledges were chamfered or raised, then panelled, and at last the doors became a mass of scroll panelling. This, of course, interfered with the design of the hinges, the ornamentation of which gradually became unusual. In almost all styles the smaller and less important doors had merely plain strap-hinges, terminating in a few bent scrolls, and latterly in *fleurs-de-lis*. Escutcheon and ring handles, and the other furniture, partook more or less of the character of the time. On the continent of Europe the knockers are very elaborate. At all periods doors have been ornamented with nails having projecting heads, sometimes square, sometimes polygonal, and sometimes ornamented with roses, &c. The iron work of windows is generally plain, and the ornament confined to simple *fleur-de-lis* heads to the stanchions. For the iron-work of screens enclosing tombs and chapels see GRILLE; and generally see METAL-WORK.

**IRONY** (*Gr.* ἰρωνεία, from ἴρων, one who says less than he means, ἔπειν, to speak), a form of speech in which the real meaning is concealed or contradicted by the words used; it is particularly employed for the purpose of ridicule, mockery or contempt, frequently taking the form of sarcastic phrase. The word is frequently used figuratively, especially in such phrases as "the irony of fate," of an issue or result that seems to contradict the previous state or condition. The Greek word was particularly used of an under-statement in the nature of dissimulation. It is especially exemplified in the assumed ignorance which Socrates adopted as a method of dialectic, the "Socratic irony" (see SOCRATES). In tragedy, what is called "tragic irony" is a device for heightening the intensity of a dramatic situation. Its use is particularly characteristic of the drama of ancient Greece, owing to the familiarity of the spectators with the legends on which so many of the plays were based. In this form of irony the words and actions of the characters belie the real situation, which the spectators fully realize. It may take several forms; the character speaking may be con-

scious of the irony of his words while the rest of the actors may not, or he may be unconscious and the actors share the knowledge with the spectators, or the spectators may alone realize irony. The *Oedipus Tyrannus* of Sophocles is the classic example of tragic irony at its fullest and finest.

**IROQUOIS**, or SIX NATIONS, a celebrated confederation of North American Indians. The name is that given them by the French. It is suggested that it was formed of two ceremonial words constantly used by the tribesmen, meaning "real adders," with the French addition of *ois*. The league was originally composed of five tribes or nations, viz. Mohawks, Oneidas, Onondagas, Senecas and Cayugas. The confederation probably took place towards the close of the 16th century and in 1722 the Tuscaroras were admitted, the league being then called that of "the Six Nations." At that time their total number was estimated at 11,650, including 2150 warriors. They were unquestionably the most powerful confederation of Indians on the continent. Their home was the central and western parts of New York state. In the American War of Independence they fought on the English side, and in the repeated battles their power was nearly destroyed. They are now to the number of 17,000 or more scattered about on various reservations in New York state, Oklahoma, Wisconsin and Canada. The *Iroquoian stock*, the larger group of kindred tribes, of which the five nations were the most powerful, had their early home in the St. Lawrence region. Besides the five nations, the Neutral nation, Huron, Erie, Conestoga, Nottoway, Meherrin, Tuscarora and Cherokee were the most important tribes of the stock. The hostility of the Algonquian tribes seems to have been the cause of the southward migration of the Iroquoian peoples. In 1535 Jacques Cartier found an Iroquoian tribe in possession of the land upon which now stand Montreal and Quebec; but seventy years later it was in the hands of Algonquians.

See L. H. Morgan, *League of the Hodeno Swanee or Iroquois* (Rochester, N.Y., 1854); *Handbook of American Indians* (Washington, 1907). ALSO INDIANS, NORTH AMERICAN.

**IRRAWADDY**, or IRRAWADI, the principal river in the province of Burma, traversing the centre of the country, and practically running throughout its entire course in British territory. It is formed by the confluence of the Mali and N'mai rivers (usually called Mali-kha and N'mai-kha, the *kha* being the Kachin word for river) in 25° 45' N. The N'mai is the eastern branch. The definite position of its source is still uncertain, and it seems to be made up of a number of considerable streams, all rising within a short distance of each other in about 28° 30' N. It is shown on some maps as the Lu river of Tibet; but it is now quite certain that the Tibetan Lu river is the Salween, and that the N'mai has its source or sources near the southern boundary of Tibet, to the north-east or east of the source of the Mali. At the confluence the N'mai is larger than the Mali. The general width of its channel seems to be 350 or 400 yds. during this part of its course. In the rains this channel is filled up, but in the cold weather the average breadth is from 150 to 200 yds. The N'mai is practically unnavigable. The Mali is the western branch. Like the main river, it is called Nam Kiu by the Shans. It rises in the hills to the north of the Hkamti country, probably in about 28° 30' N. Between Hkamti and the country comparatively close to the confluence little or nothing is known of it, but it seems to run in a narrow channel through continuous hills. The highest point on the Mali reached from the south by Major Hobday in 1891 was Ting Sa, a village a little off the river, in 26° 15' N. About 1 m. above the confluence it is 150 yds. wide in January and 17 ft. deep, with a current of 34 m. an hour. Steam launches can only ascend from Myitkyina to the confluence in the height of the rains. Native boats ascend to Laikaw or Sawan 26° 2' N., all the year around, but can get no farther at any season. From the confluence the river flows in a southerly direction as far as Bhamo, then turns west as far as the confluence of the Kawkwe stream, a little above Katha, where it again turns in a southerly direction, and maintains this in its general course through Upper and

Lower Burma, though it is somewhat tortuous immediately below Mandalay. Just below the confluence of the Mali and N'mai rivers the Irrawaddy is from 420 to 450 yds. wide and about 30 ft. deep in January at its deepest point. Here it flows between hills, and after passing the Manse and Mawkan rapids, reaches plain country and expands to nearly 500 yds. at Sakap. At Myitkyina it is split into two channels by Naung-talaw island, the western channel being 600 yds. wide and the eastern 200. The latter is quite dry in the hot season. At Kat-kyo, 5 or 6 m. below Myitkyina, the width is 1000 yds., and below this it varies from 600 yds. to  $\frac{1}{2}$  m. at different points. Three miles below Sinbo the third defile is entered by a channel not more than 50 yds. wide, and below this, throughout the defile, it is never wider than 250 yds., and averages about 100. At the "Gates of the Irrawaddy" at Poshaw two prism-shaped rocks narrow the river to 50 yds., and the water banks up in the middle with a whirlpool on each side of the raised pathway. All navigation ceases here in the floods. The defile ends at Hpatin, and below this the river widens out to a wet-season channel of 2 m., and a breadth in the dry season of about 1 m. At Sinkan, below Bhamo, the second defile begins. It is not so narrow nor is the current so strong as in the third defile. The narrowest place is more than 100 yds. wide. The hills are higher, but the defile is much shorter. At Shwegu the river leaves the hills and becomes a broad stream, flowing through a wide plain. The first defile is tame compared with the others. The river merely flows between low hills or high wooded banks. The banks are covered at this point with dense vegetation, and slope down to the water's edge. Here and there are places which are almost perpendicular, but are covered with forest growth. The course of the Irrawaddy after receiving the waters of the Myit-nge at Sagaing, as far as  $17^{\circ}$  N. lat., is exceedingly tortuous; the line of Lower Burma is crossed in  $10^{\circ} 20' 3''$  N. lat.,  $95^{\circ} 15'$  E. long., the breadth of the river here being  $\frac{1}{2}$  m.; about 11 m. lower down it is nearly 3 m. broad. At Akauk-taung, where a spur of the Arakan hills end in a precipice 300 ft. high, the river enters the delta, the hills giving place to low alluvial plains, now protected on the west by embankments. From  $17^{\circ}$  N. lat. the Irrawaddy divides and subdivides, converting the lower portion of its valley into a network of intercommunicating tidal creeks. It reaches the sea in  $15^{\circ} 50'$  N. lat. and  $95^{\circ} 8'$  E. long., by nine principal mouths. The only ones used by sea-going ships are the Bassin and Rangoon mouths. The area of the catchment basin of the Irrawaddy is 158,000 sq. m.; its total length from its known source to the sea is about 1300 m. As far down as Akauk-taung in Henzada district its bed is rocky, but below this sandy and muddy. It is full of islands and sandbanks; its waters are extremely muddy, and the mud is carried far out to sea. The river commences to rise in March; about June it rises rapidly, and attains its maximum height about September. The total flood discharge is between four and five hundred million metre tons of 37 cub. ft. From Mandalay up to Bhamo the river is navigable a distance of nearly 1000 m. for large steamers all the year round; but small launches and steamers with weak engines are often unable to get up the second defile in the months of July, August and September, owing to the strong current. The Irrawaddy Flotilla Company's steamers go up and down twice a week all through the rains, and the mails are carried to Bhamo on intermediate days by a ferry-boat from the railway terminus at Katha. During the dry season the larger boats are always liable to run on sandbanks, more especially in November and December, when new channels are forming after the river has been in flood. From Bhamo up to Sinbo no steamers can ply during the rains, that is to say, usually from June to November. From November to June small steamers can pass through the third defile from Bhamo to Sinbo. Between Sinbo and Myitkyina small launches can run all the year round. Above Myitkyina small steamers can reach the confluence at the height of the flood with some difficulty, but when the water is lower they cannot pass the Mawkan rapid, just above Mawme, and the navigation of the river above Myitkyina is always difficult. The journey

from Bhamo to Sinbo can be made during the rains in native boats, but it is always difficult and sometimes dangerous. It is never done in less than five days and often takes twelve or more. As a natural source of irrigation the value of the Irrawaddy is enormous, but the river supplies no artificial systems of irrigation. It is nowhere bridged, though crossed by two steam ferries to connect the railway system on either bank.

(J. G. Sc.)

**IRREDENTISTS**, an Italian patriotic and political party, which was of importance in the last quarter of the 19th century. The name was formed from the words *Italia Irredenta*—Unredeemed Italy—and the party had for its avowed object the emancipation of all Italian lands still subject to foreign rule. The Irredentists took language as the test of the alleged Italian nationality of the countries they proposed to emancipate, which were South Tirol (Trentino), Görz, Istria, Trieste, Tessino, Nice, Corsica and Malta. The test was applied in the most arbitrary manner, and in some cases was not applicable at all. Italian is not universally spoken in South Tirol, Görz or Istria. Malta has a dialect of its own though Italian is used for literary and judicial purposes, while Dalmatia is thoroughly non-Italian though it was once under the political dominion of the ancient Republic of Venice. The party was of little note before 1878. In that year it sprang into prominence because the Italians were disappointed by the result of the conference at Berlin summoned to make a European settlement after the Russo-Turkish War of 1877. The Italians had hoped to share in the plunder of Turkey, but they gained nothing, while Austria was endowed with the protectorate of Bosnia, and the Herzegovina, the vitally important hinterland of her possessions on the Adriatic. Under the sting of this disappointment the cry of *Italia Irredenta* became for a time loud and apparently popular. It was in fact directed almost wholly against Austria, and was also used as a stalking-horse by discontented parties in Italian domestic politics—the Radicals, Republicans and Socialists. In addition to the overworked argument from language, the Irredentists made much of an unfounded claim that the Trentino had been conquered by Giuseppe Garibaldi during the war of 1866, and they insisted that the district was an "enclave" in Italian territory which would give Austria a dangerous advantage in a war of aggression. It would be equally easy and no less accurate to call the Trentino an exposed and weak spot of the frontier of Austria. On the 21st of July 1878 a noisy public meeting was held at Rome with Menotti Garibaldi, the son of the famous Giuseppe, in the chair, and a clamour was raised for the formation of volunteer battalions to conquer the Trentino. Signor Cairoli, then prime minister of Italy, treated the agitation with tolerance. It was, however, mainly superficial, for the mass of the Italians had no wish to launch on a dangerous policy of adventure against Austria, and still less to attack France for the sake of Nice and Corsica, or Great Britain for Malta. The only practical consequences of the Irredentist agitation outside of Italy were such things as the assassination plot organized against the emperor Francis Joseph in Trieste in 1882 by Oberdank, which was detected and punished. When the Irredentist movement became troublesome to Italy through the activity of Republicans and Socialists, it was subject to effective police control by Signor Depretis. It sank into insignificance when the French occupation of Tunis in 1881 offended the Italians deeply, and their government entered into those relations with Austria and Germany which took shape by the formation of the Triple Alliance. In its final stages it provided a way in which Italian—who sympathized with French republicanism, and who disliked the monarchical governments of Central Europe, could agitate against their own government. It also manifested itself in periodical war scares based on affected fears of Austrian aggression in northern Italy. Within the dominions of Austria Irredentism has been one form of the complicated language question which has disturbed every portion of the Austro-Hungarian empire.

See Colonel von Haymerle, *Italica res* (Vienna, 1879) for the early history of the Irredentists.

**IRRIGATION** (Lat. *in*, and *rigare*, to water or wet), the artificial application of water to land in order to promote vegetation; it is therefore the converse of "drainage" (*q.v.*), which is the artificial withdrawal of water from lands that are oversaturated. In both cases the object is to promote vegetation.

I. *General*.—Where there is abundance of rainfall, and when it falls at the required season, there is in general no need for irrigation. But it often happens that, although there is sufficient rainfall to raise an inferior crop, there is not enough to raise a more valuable one.

Irrigation is an art that has been practised from very early times. Year after year fresh discoveries are made that carry back our knowledge of the early history of Egypt. It is certain that, until the cultivator availed himself of the natural overflow of the Nile to saturate the soil, Egypt must have been a desert, and it is a very small step from that to baling up the water from the river and pouring it over lands which the natural flood has not touched. The sculptures and paintings of ancient Egypt bear no trace of anything approaching scientific irrigation, but they often show the peasant baling up the water at least as early as 2000 B.C. By means of this simple plan of raising water and pouring it over the fields thousands of acres are watered every year in India, and the system has many advantages in the eyes of the peasant. Though there is great waste of labour, he can apply his labour when he likes; no permission is required from a government official; no one has to be bribed. The simplest and earliest form of water-raising machinery is the pole with a bucket suspended from one end of a crossbeam and a counterpoise at the other. In India this is known as the *denkli* or *paccotah*; in Egypt it is called the *shadûf*. All along the Nile banks from morning to night may be seen brown-skinned peasants working these *shadûfs*, tier above tier, so as to raise the water 15 or 16 ft. on to their lands. With a *shadûf* it is only possible to keep about 4 acres watered, so that a great number of hands are required to irrigate a large surface. Another method largely used is the shallow basket or bucket suspended to strings between two men, who thus bail up the water. A step higher than these is the rude water-wheel, with earthen pots on an endless chain running round it, worked by one or two bullocks. This is used everywhere in Egypt, where it is known as the *sakya*. In Northern India it is termed the *harat*, or Persian wheel. With one such water-wheel a pair of oxen can raise water any height up to 18 ft., and keep from 5 to 12 acres irrigated throughout an Egyptian summer. A very familiar means in India of raising water from wells in places where the spring level is as much sometimes as 100 ft. below the surface of the field is the *churras*, or large leather bag, suspended to a rope passing over a pulley, and raised by a pair of bullocks which go up and down a slope as long as the depth of the well. All these primitive contrivances are still in full use throughout India.

It is not improbable that Assyria and Babylon, with their splendid rivers, the Euphrates and Tigris, may have taken the idea from the Nile, and that Carthage and Phœnicia as well as Greece and Italy may have followed the same example. In spite of a certain amount of investigation, the early history of irrigation in Persia and China remains imperfectly known. In Spain irrigation may be traced directly to the Moorish occupation, and almost everywhere throughout Asia and Africa where the Moslem penetrated it is to be found some knowledge of irrigation.

Reservoirs are familiar everywhere for the water-supply of towns, but as the volume necessary, even for a large town, does not go far in irrigating land, many sites which would do admirably for the former would not contain water sufficient to be worth applying to the latter purpose. In the Mediterranean provinces of Spain there are some very remarkable irrigation dams. The great masonry dam of Alicante on the river Monegre, which dates from 1579, is situated in a narrow gorge, so that while 140 ft. high, it is only 190 ft. long at the crest. The reservoir is said to contain 1300 million cub. ft. of water, and to serve for the irrigation of 9000 acres, but unless it refills several times a year, it is hardly possible that so much land can be watered in any one season. The Elche reservoir,

in the same province, has a similar dam 55 ft. high. In neither case is there a waste-weir, the surplus water being allowed to pour over the crest of the dam. South of Elche is the province of Murcia, watered by the river Segura, on which there is a dam 25 ft. high, said to be 800 years old, and to serve for the irrigation of 25,000 acres. The Lorca dam in the same neighbourhood irrigates 27,000 acres. In the jungles of Ceylon are to be found remains of gigantic irrigation dams, and on the neighbouring mainland of Southern India, throughout the provinces India. of Madras and Mysore, the country is covered with irrigation reservoirs, or, as they are locally termed, tanks. These vary from village ponds to lakes 14 or 15 m. long. Most of them are of old native construction, but they have been greatly improved and enlarged within the last half century. The casual traveller in southern India constantly remarks the ruins of old dams, and the impression is conveyed that at one time, before British rule prevailed, the irrigation of the country was much more perfect than it is now. That idea, however, is mistaken. An irrigation reservoir, like a human being, has a certain life. Quicker or slower, the water that fills it will wash in sand and mud, and year by year this process will go on till ultimately the whole reservoir is filled up. The embankment is raised, and raised again, but at last it is better to abandon it and make a new tank elsewhere, for it would never pay to dig out the silt by manual labour. It may safely be said that at no time in history were there more tanks in operation than at present. The ruins which are seen are the ruins of long centuries of tanks that once flourished and became silted up. But they did not all flourish at once.

In the countries now being considered, the test of an irrigation work is how it serves in a season of drought and famine. It is evident that if there is a long cessation of rain, there can be none to fill the reservoirs. In September 1877 there were very few in all southern India that were not dry. But even so, they helped to shorten the famine period; they stored up the rain after it had ceased to fall, and they caught up and husbanded the first drops when it began again.

Irrigation effected by river-fed canals naturally depends on the regimen of the rivers. Some rivers vary much in their discharge at different seasons. In some cases this variation is comparatively little. Sometimes the flood season recurs regularly at the same time of the year; sometimes it is uncertain. In some rivers the water is generally pure; in others it is highly charged with fertilizing alluvium, or, it may be, with barren silt. In countries nearly rainless, such as Egypt or Sind, there can be no cultivation without irrigation. Elsewhere the rainfall may be sufficient for ordinary crops, but not for the more valuable kinds. In ordinary years in southern India the maize and the millet, which form so large a portion of the peasants' food, can be raised without irrigation, but it is required for the more valuable rice or sugar-cane. Elsewhere in India the rainfall is usually sufficient for all the cultivation of the district, but about every eleven years comes a season of drought, during which canal water is so precious as to make it worth while to construct costly canals merely to serve as a protection against famine. When a river partakes of the nature of a torrent, dwindling to a paltry stream at one season and swelling into an enormous flood at another, it is impossible to construct a system of irrigation canals without very costly engineering works, sluices, dams, waste-weirs, &c., so as to give the engineer entire control of the water. Such may be seen on the canals of Cuttack, derived from the Mahanadi, a river of which the discharge does not exceed 400 cub. ft. per second in the dry season, and rises to 1,600,000 cub. ft. per second in the rainy season.

Very differently situated are the great canals of Lombardy, drawn from the Ticino and Adda rivers, flowing from the Maggiore and Como lakes. The severest drought never exhausts these reservoirs, and the heaviest rain can never convert these rivers into the resistless floods which they would be but for the moderating influence of the great lakes. The Ticino and Adda do not rise in floods more than 6 or 7 ft. above their ordinary level,

Irrigation  
canals.

or fall in droughts more than 4 or 5 ft. below it, and their water is at all seasons very free from silt or mud. Irrigation cannot be practised in more favourable circumstances than these. The great lakes of Central Africa, Victoria and Albert Nyanza, and the vast swamp tract of the Sudan, do for the Nile on a gigantic scale what Lakes Maggiore and Como do for the rivers Ticino and Adda. But for these great reservoirs the Nile would decrease in summer to quite an insignificant stream. India possesses no great lakes from which to draw rivers and canals, but through the plains of northern India flow rivers which are fed from the glaciers of the Himalaya; and the Ganges, the Indus, and their tributaries are thus prevented from diminishing very much in volume. The greater the heat, the more rapidly melts the ice, and the larger the quantity of water available for irrigation. The canal system of northern India is the most perfect the world has yet seen, and contains works of hydraulic engineering which can be equalled in no other country. In the deltas of southern India irrigation is only practised during the monsoon season. The Godavari, Kistna and Kaveri all take their rise on the Western Ghats, a region where the rainfall is never known to fail in the monsoon season. Across the apex of the deltas are built great weirs (that of the Godavari being  $2\frac{1}{2}$  m. long), at the ends and centre of which is a system of sluices feeding a network of canals. For this monsoon irrigation there is always abundance of water, and so long as the canals and sluices are kept in repair, there is little trouble in distributing it over the fields. Similar in character was the ancient irrigation of Egypt practised merely during the Nile flood—a system which still prevails in part of Upper Egypt. A detailed description of it will be found below.

Where irrigation is carried on throughout the whole year, even when the supply of the river is at its lowest, the distribution of the water becomes a very delicate operation. It is generally considered sufficient in such cases if during any one crop one-third of the area that can be commanded is actually supplied with water. This encourages a rotation of crops and enables the precious liquid to be carried over a larger area than could be done otherwise. It becomes then the duty of the engineer in charge to use every effort to get its full value out of every cubic foot of water. Some crops of course require water much oftener than others, and much depends on the temperature at the time of irrigation. During the winter months in northern India magnificent wheat crops can be produced that have been watered only twice or thrice. But to keep sugar-cane, or indigo, or cotton alive in summer before the monsoon sets in in India or the Nile rises in Egypt the field should be watered every ten days or fortnight, while rice requires a constant supply of water passing over it.

Experience in these sub-tropical countries shows the absolute necessity of having, for successful irrigation, also a system of thorough drainage. It was some time before this was discovered in India, and the result has been the deterioration of much good land.

In Egypt, prior to the British occupation in 1883, no attempt had been made to take the water off the land. The first impression of a great alluvial plain is that it is absolutely flat, with no drainage at all. Closer examination, however, shows that if the prevailing slopes are not more than a few inches in the mile, yet they do exist, and scientific irrigation requires that the canals should be taken along the crests and drains along the hollows. In the diagram (fig. 1) is shown to the right of the river a system of canals branching out and afterwards rejoining one another so as to allow of no means for the water that passes off the field to escape into the sea. Hence it must either evaporate or sink into the soil. Now nearly all rivers contain some small percentage of salt, which forms a distinct ingredient in alluvial plains. The result of this drainless irrigation is an efflorescence of salt on the surface of the field. The spring level rises, so that water can be reached by digging only a few feet, and the land, soured and water-logged, relapses into barrenness. Of this description was the irrigation of Lower Egypt previous to 1883. To the left of the diagram is shown (by firm lines) a system of canals

laid out scientifically, and of drains (by dotted lines) flowing between them. It is the effort of the British engineers in Egypt to remodel the surface of the fields to this type.

Further information may be found in Sir C. C. Scott-Moncrieff, *Irrigation in Southern Europe* (London, 1868); Moncrieff, "Lectures on Irrigation in Egypt," *Professional Papers of the Corps of Royal Engineers*, vol. xix. (London, 1893); W. Willcocks, *Egyptian Irrigation* (2nd ed., London, 1899).

II. *Water Meadows*.—Nowhere in England can it be said that irrigation is necessary to ordinary agriculture, but it is occasionally employed in stimulating the growth of grass and meadow herbage in what are known as water-meadows. These are in some instances of very early origin. On the Avon in Wiltshire and the Churn in Gloucestershire they may be traced back to Roman times. This irrigation is not practised in the drought of summer, but in the coldest and wettest months of the year,

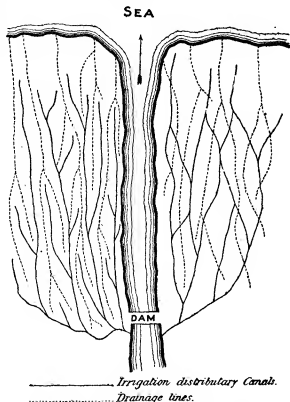

FIG. 1.—Diagram showing irrigation properly combined with drainage (to left), and laid out regardless of drainage required later (to right).

the water employed being warmer than the natural moisture of the soil and proving a valuable protection against frost.

Before the systematic conversion of a tract into water-meadows can be safely determined on, care must be taken to have good drainage, natural or artificial, a sufficient supply of water, and water of good quality. It might indeed have been thought that thorough drainage would be unnecessary, but it must be noted that porous subsoils or efficient drains do not act merely by carrying away stagnant water which would otherwise cool the earth, incrust the surface, and retard plant growth. They cause the soil to perform the office of a filter. Thus the earth and the roots of grasses absorb the useful matters not only from the water that passes over it, but from that which passes through it. These fertilizing materials are found stored up in the soil ready for the use of the roots of the plants. Stagnation of water is inimical to the action of the roots, and does away with the advantageous processes of flowing and percolating currents. Some of the best water-meadows in England have but a thin soil resting on gravel and flints, this constituting a most effectual system of natural drainage. The fall of the water supply must suffice for a fairly rapid current, say 10 in. or 1 ft. in from 100 to

200 yds. If possible the water should be taken so far above the meadows as to have sufficient fall without damming up the river. If a dam be absolutely necessary, care must be taken so to build it as to secure the fields on both sides from possible inundation; and it should be constructed substantially, for the cost of repairing accidents to a weak dam is very serious.

Even were the objects of irrigation always identical, the conditions under which it is carried on are so variable as to preclude calculations of quantity. Mere making up of necessary water in droughty seasons is one thing, protection against frost is another, while the addition of soil material is a third. Amongst causes of variation in the quantity of water needed will be its quality and temperature and rate of flow, the climate, the season, the soil, the subsoil, the artificial drainage, the slope, the aspect and the crop. In actual practice the amount of water varies from 300 gallons per acre in the hour to no less than 28,000 gallons. Where water is used, as in dry and hot countries, simply as water, less is generally needed than in cold, damp and northerly climates, where the higher temperature and the action of the water as manure are of more consequence. But it is necessary to be thoroughly assured of a good supply of water before laying out a water-meadow. Except in a few places where unusual dryness of soil and climate indicate the employment of water, even in small quantity, merely to avoid the consequences of drought, irrigation works are not to be commenced upon a large area, if only a part can ever be efficiently watered. The engineer must not decide upon the plan till he has gauged at different seasons the stream which has to supply the water, and has ascertained the rain-collecting area available, and the rainfall of the district, as well as the proportion of storage to percolating and evaporating water. Reservoirs for storage, or for equalizing the flow, are rarely resorted to in England; but they are of absolute necessity in those countries in which it is just when there is least water that it is most wanted. It is by no means an injudicious plan before laying out a system of water-meadows, which is intended to be at all extensive, to prepare a small trial plot, to aid in determining a number of questions relating to the nature and quantity of the water, the porosity of the soil, &c.

The quality of the water employed for any of the purposes of irrigation is of much importance. Its dissolved and its suspended matters must both be taken into account. Clear water is usually preferable for grass land, thick for arable land. If it is to be used for warping, or in any way for adding to the solid material of the irrigated land, then the nature and amount of the suspended material are necessarily of more importance than the character of the dissolved substances, provided the latter are not positively injurious. For use on ordinary water-meadows, however, not only is very clear water often found to be perfectly efficient, but water having no more than a few grains of dissolved matter per gallon answers the purposes in view satisfactorily. Water from moors and peat-bogs or from gravel or ferruginous sandstone is generally of small utility so far as plant food is concerned. River water, especially that which has received town sewage, or the drainage of highly manured land, would naturally be considered most suitable for irrigation, but excellent results are obtained also with waters which are uncontaminated with manurial matters, and which contain but 3 or 10 grains per gallon of the usual dissolved constituents of spring water. Experienced English irrigators generally commend as suitable for water-meadows those streams in which fish and waterweeds abound. But the particular plants present in or near the water-supply afford further indications of quality. Water-cress, sweet flag, flowering rush, several potamogetons, water milfoil, water ranunculus, and the reedy sweet watergrass (*Glyceria aquatica*) rank among the criteria of excellence. Less favourable signs are furnished by such plants as *Arundo Domax* (in Germany), *Cicuta virosa* and *Typha latifolia*, which are found in stagnant and torpid waters. Water when it has been used for irrigation generally becomes of less value for the same purpose. This occurs with clear water as well as with turbid, and obviously arises mainly from the

loss of plant food which occurs when water filters through or trickles over poor soil. By passing over or through rich soil the water may, however, actually be enriched, just as clear water passed through a charcoal filter which has been long used becomes impure. It has been contended that irrigation water suffers no change in composition by use, since by evaporation of a part of the pure water the dissolved matters in the remainder would be so increased as to make up for any matters removed. But it is forgotten that both  $H_2O$  plant and the soil enjoy special powers of selective absorption, which remove and fix the better constituents of the water and leave the less valuable.

Of the few leguminous plants which are in any degree suitable for water-meadows, *Lotus corniculatus major*, *Trifolium hybridum*, and *T. pratense* are those which generally flourish best; *T. repens* is less successful. Amongst grasses the highest place must be assigned to ryegrass, especially to the Italian variety, commonly called *Lolium italicum*. The mixture of seeds for sowing a water-meadow demands much consideration, and must be modified according to local circumstances of soil, aspect, climate and drainage. From the peculiar use which is made of the produce of an irrigated meadow, and from the conditions to which it is subjected, it is necessary to include in our mixture of seeds some that produce an early crop, some that give an abundant growth, and some that impart sweetness and good flavour, while all the kinds sown must be capable of flourishing on irrigated soil.

The following mixtures of seeds (stated in pounds per acre) have been recommended for sowing on water-meadows, Messrs Sutton of Reading, after considerable experience, regarding No. I. as the more suitable:

	I. II.		I. II.
<i>Lolium perenne</i> . . . . .	8 12	<i>Festuca pratensis</i> . . . . .	0 2
<i>Lolium italicum</i> . . . . .	0 8	<i>Festuca lolacea</i> . . . . .	3 2
<i>Poa trivialis</i> . . . . .	6 3	<i>Anthoxanthum odoratum</i> 0 1	
<i>Glyceria fluitans</i> . . . . .	6 2	<i>Phleum pratense</i> . . . . .	4 2
<i>Glyceria aquatica</i> . . . . .	4 1	<i>Phalaris arundinacea</i> . . . . .	3 2
<i>Agrostis alba</i> . . . . .	0 1	<i>Lotus corniculatus major</i> 3 2	
<i>Agrostis stolonifera</i> . . . . .	6 2	<i>Trifolium hybridum</i> . . . . .	0 1
<i>Alopecurus pratensis</i> . . . . .	0 2	<i>Trifolium pratense</i> . . . . .	0 1
<i>Festuca elatior</i> . . . . .	3 2		

In irrigated meadows, though in a less degree than on sewage land, the reduction of the amount or even the actual suspension of certain species of plants is occasionally well marked. Sometimes this action is exerted upon the finer grasses, but happily also upon some of the less profitable constituents of the miscellaneous herbage. Thus *Ranunculus bulbosus* has been observed to become quite rare after a few years' watering of a meadow in which it had been most abundant, *R. acris* rather increasing by the same treatment; *Plantago media* was extinguished and *P. lanceolata* reduced 70%. Amongst the grasses which may be spared, *Aira caespitosa*, *Brisa media* and *Cynosurus cristatus* are generally much reduced by irrigation. Useful grasses which are increased are *Lolium perenne* and *Alopecurus pratensis*, and among those of less value *Avena foveicensis*, *Dactylis glomerata* and *Poa pratensis*.

Four ways of irrigating land with water are practised in England: (1) bedwork irrigation, which is the most efficient although it is also the most costly method by which currents of water can be applied to level land; (2) catchwork irrigation, in which the same water is caught and used repeatedly; (3) subterraneous or rather upward irrigation, in which the water in the drains is sent upwards through the soil towards the surface; and (4) warping, in which the water is allowed to stand over a level field until it has deposited the mud suspended in it.

There are two things to be attended to most carefully in the construction of a water-meadow on the first or second of these plans. First, no portion of them whatever should be on a dead level, but every part should belong to one or other of a series of true inclined planes. The second point of primary importance is the size and slope of the main conductor, which brings the water from the river to the meadow. The size of this depends

Quantity of water.

Seeds for water-meadows.

Changes in irrigated herbage.

Methods.

upon the quantity of water required, but whatever its size its bottom at its origin should be as low as the bed of the river, in order that it may carry down as much as possible of the river mud. Its course should be as straight and as near a true inclined plane as possible. The stuff taken out of the conductor should be employed in making up its banks or correcting inequalities in the meadow.

In bedwork irrigation, which is eminently applicable to level ground, the ground is thrown into beds or ridges. Here the conductor should be led along the highest end or side of the meadow. In a meadow in an inclined plane; should it terminate in the meadow, its end should be made to taper when there are no feeders, or to terminate in a feeder. The main drain to carry off the water from the meadow should next be formed. It should be cut in the lowest part of the ground at the lower end or side of the meadow. Its dimensions should be capable of carrying off the whole water used so quickly as to prevent the least stagnation, and discharge it into the river. The next process is the forming of the ground intended for a water-meadow into beds or ridges. That portion of the ground which is to be watered by one conductor should be made into beds to suit the circumstances of that conductor; that is, instead of the beds over the meadow being all reduced to one common level, they should be formed to suit the different swells in the ground, and, should any of these swells be considerable, it will be necessary to have a feeder in its own respective conductor. The beds should run at or nearly at right angles to the line of the conductor. The breadth of the beds is regulated by the nature of the soil and the supply of water. Tenacious soils and subsoils, with a small supply of water, require beds as narrow as 30 ft. Porous soils and a large supply of water may have beds of 40 ft. The length of the beds is regulated by the supply of water and the fall from the conductor to the main drain. If the beds fall only in one direction longitudinally, their crowns should be made in the middle; but, should they fall laterally as well as longitudinally, as is usually the case, then the crowns should be made towards the upper sides, more or less according to the lateral slope of the ground. The crowns should rise 1 ft. above the adjoining furrows. The beds thus formed should slope in an inclined plane from the conductor to the main drain, that the water may flow equally over them.

The beds are watered by "feeders," that is, channels gradually tapering to the lower extremities, and their crowns cut down, wherever these are placed. The depth of the feeders depends on their width, and the width on their length. The length of the length depends on the width of the junction with the conductor, and it should taper gradually to the extremity, which should be 1 ft. in width. The taper retards the motion of the water, which constantly decreases by overflow as it proceeds, whilst it continues to fill the feeder to the brim. The water overflowing from the feeders down the sides of the beds is received into small drains formed in the furrows between the beds. These small drains discharge themselves into the main drain, and are in every respect the reverse of the feeders. The depth of the small drain at the junction is made about as great as that of the main drain, and it gradually lessens towards the taper to 6 in. in tenacious and to less in porous soils. The depth of the feeders is the same in relation to the conductor. For the more equal distribution of the water over the surface of the beds from the conductor and feeders, small masses, such as stones or solid portions of earth or turf fastened with pins, are placed in them, in order to retard the momentum which the water may have acquired. These "stops," as they are termed, are generally placed at regular intervals, or rather they should be left where any inequality of the current is observed. Heaps of stones answer very well for stops in the conductors, particularly immediately below the points of junction with the feeders. The small or main drains require no stops. The descent of the water in the feeders will no doubt necessarily increase in rapidity, but the inclination of the beds and the tapering of the feeders should be so adjusted as to counteract the increasing rapidity. The distribution of the water over the whole meadow is regulated by the sluices, which should be placed at the origin of every conductor. By means of these sluices any portion of the meadow that is desired can be watered, whilst the rest remains dry; and alternate watering must be adopted in order to prevent the scarcity of water. The sluices should be substantially built at first with stones and mortar, to prevent the leakage of water; for, should water from a leak be permitted to find its way into the meadow, that portion of it will stagnate and produce coarse grasses. In a well-formed water-meadow it is as necessary to keep it perfectly dry at one time as it is to place it under water at another. A small sluice placed in the side of the conductor opposite to the meadow, and at the upper end of it, will drain away the leakage that may have escaped from the head sluice.

To obtain a complete water-meadow, the ground will often require to be broken up and remodelled. This will no doubt be attended with cost; but it should be considered that the first cost is the least, and remodelled the only way of having a complete water-meadow which will continue for years to give satisfaction. To effect a remodelling when the ground is in stubble, let it be ploughed up, harrowed, and cleaned as in a summer fallow, the leveling-box

employed when required, the stuff from the conductors and main drains spread abroad, and the beds ploughed into shape—all operations that can be performed at little expense. The meadow should be ready by August for sowing with one of the mixtures of grass-seeds already given. But though this plan is ultimately better, it is attended with the one great disadvantage that the soft ground cannot be irrigated for two or three years after it is sown with grass-seeds. This can only be avoided where the ground is covered with old turf which will bear to be lifted. On ground in that state a water-meadow may be most perfectly formed. Let the turf be taken off with the spade, and laid carefully aside for relaying. Let the strip ground then be neatly formed with the spade and barrow, into beds varying in breadth and shape according to the nature of the soil and the dip of the ground—the feeders from the conductor and the small drains to the main drain being formed at the same time. Then let the turf be laid down again and beaten firm, when the meadow will be complete at once, and ready for irrigation. This is the most beautiful and most expeditious method of making a complete water-meadow where the ground is not naturally sufficiently level to begin with.

The water should be let on, and trial made of the work, whenever it is finished, and the motion of the water regulated by the introduction of a stop in the conductors and feeders where a change in the motion of the current is observed, beginning at the upper end of the meadow. Should the work be finished as directed by August, a good crop of hay may be reaped the following autumn. There are, however, a few other natural defects, the ground will not admit of the water being collected a second time, and applied to the irrigation of a second and lower meadow. In such a case the main drain of a watered meadow may form the conductor of the one to be watered, or a new conductor may be formed by a prolongation of the main drain; but either expedient is only advisable where water is scarce. Where it is plentiful, it is better to supply the second meadow directly from the river, or by a continuation of the first main drain conductor.

In the ordinary catchwork water-meadow, the water is used over and over again. On the steep sides of valleys the plan is easily and cheaply carried out, and where the whole course of the water is not long the peculiar properties which give it value, though lessened, are not exhausted when it reaches **Catchwork.** that part of the meadow which it irrigates last. The design of any piece of catchwork will vary with local conditions, but generally it may be stated that it consists in putting each conduit save the first to the double use of a feeder or distributor and of a drain or collector.

In upward or subterranean irrigation the water used rises upward through the soil, and thus, under ordinary circumstances, would be carried off by the drains. The system has received considerable development in Germany, where the **Upward or subterranean.** elaborate method invented by Petersen is recommended by many agricultural authorities. In this system the well-fitting earthenware drain-pipes are furnished at intervals with vertical shafts terminating at the surface of the ground in movable caps. Beneath each cap, and near the upper end of the shaft, are a number of vertical slits through which the drainage water which rises passes out into the conduit or trench from which the irrigating streams originate. In the vertical shaft there is first of all a grating which intercepts solid matters, and then, lower down, a central valve which can be opened and closed at pleasure from the top of the shaft. In the ordinary English system of upward or drainage irrigation, ditches are dug all round the field. They act the part of conductors when the land is to be flooded, and of main drains when it is to be laid dry. The water flows from the ditches as conductors into built conduits formed at right angles to them in parallel lines through the fields; it rises upwards in them as high as the surface of the ground, and again subsides through the soil and the conduits into the ditches as main drains, and thence it passes at a lower level either into a stream or other suitable outfall. The ditches may be filled in one or other of several different ways. The water may be drainage-water from lands at a higher level; or it may be water from a neighbouring river; or it may be drainage-water accumulated from a farm and pumped up to the necessary level. But it may also be the drainage-water of the field itself. In this case the mouths of the underground main pipe-drains are stopped up, and the water in them and the secondary drains are caused to stand back until it has risen sufficiently near the surface. Of course it is necessary to build the mouths of such main drains of very solid masonry, and to construct efficient sluices for the retention of the water in the drains. Irrigation of the kind now under discussion may be practised wherever a command of water can be secured, but the ground must be level. It has been successfully employed in recently drained morasses, which are apt to become too dry in summer. It is suitable for stiffish soils where the subsoil is fairly open, but is less successful in soils the water used may be used to clear, and, in fact, not only for moistening the soil, but for manure. For, if, as commonly the case, the water employed be drainage-water from cultivated lands, it is sure to contain a considerable quantity of nitrates, which, not being subject to retention by the soil, would otherwise escape. These coming into contact with the roots of plants during their season of active growth, are utilized as direct nourishment for the vegetation. It is necessary

in upward or subterranean irrigation to send the water on and to take it off very gently, in order to avoid the displacement and loss of the finer particles of the soil which a forcible current would cause.

In warping the suspended solid matters are of importance, not merely for any value they may have as manure, but also as a material addition to the ground to be irrigated. The warping which is practised in England is almost exclusively confined to the overflowing of level ground within tide mark, and is conducted mostly within the districts commanded by estuaries or tidal rivers. The best notion of the process of warping may be gained by sailing up the Trent from the Humber to Gainsborough. Here the banks of the river were constrained centuries ago to protect the land within them from the encroachments of the tide. A great tract of country was thus laid comparatively dry. But while the wisdom of one age thus succeeded in restricting within bounds the tidal water of the river, it was left to the greater wisdom of a succeeding age to improve upon this arrangement by admitting these muddy waters to lay a fresh coat of rich silt on the exhausted soils. The process began more than a century ago, but has become a system in recent times. Large sluices of stone, with strong doors, to be shut when it is wished to exclude the tide, may be seen on both banks of the river, and from these great conduits are carried miles inward through the flat country to the point previously prepared by embankment over which the muddy waters are allowed to spread. These main conduits, being very costly, are constructed for the warping of large adjoining districts; and openings are made at such points as are then undergoing the operation. The mud is deposited and the waters return to the falling tide to the river, the upper rivers are preferred, and so great is the quantity of mud in these rivers that from 10 to 15 acres have been known to be covered with silt from 1 to 3 ft. in thickness during one spring of ten or twelve tides. Peat-moss of the most sterile character has been by this process covered with soil of the greatest fertility, and swamps which used to be resorted to for leeches are now, by the effects of warping, converted into firm and fertile fields. The art is now so well understood that, by careful attention to the current, the silt may be deposited in any soil as he places. When the tide is first admitted the heavier particles, which are pure sand, are first deposited; the second deposit is a mixture of sand and fine mud, which, from its friable texture, forms the most valuable soil; while lastly the pure mud subsides, containing the finest particles of all, and forms a rich but very tenacious soil. The great effort, therefore, of the warp farmer is to get the second or mixed deposit as equally over the whole surface as he can and to prevent the tide from returning to the river by stopping the water in constant motion, as the last deposit can only take place when the water is suffered to be still. Three years may be said to be spent in the process, one year warping, one year drying and consolidating, and one year growing the first crop, which is generally seed-hoeed in by hand, as the mud at this time is too soft to admit of horse labour.

The immediate effect, which is highly beneficial, is the deposition of silt from the tide. To ensure this deposition, it is necessary to surround the field to be warped with a strong embankment, in order to retain the water as the tide recedes. The water is admitted by valved sluices, which open as the tide flows into the field and shut by the pressure of the confined water when the tide recedes. These sluices are placed on as low a level as possible to permit the most turbid water at the bottom of the tide to pass through a channel in the base of the embankment. The silt deposited after warping is exceedingly rich and capable of carrying any species of crop. It may be admitted in so small a quantity as only to act as manure to arable soil, or in such a large quantity as to form a new soil. This latter acquisition is the principal object of warping, and it excites astonishment to witness how soon a new soil may be formed. From June to September a soil of 3 ft. in depth may be formed under the favourable circumstances of a very dry season and long drought. In winter and in floods warping ceases to be beyond the same effect. Circumstances on the Trent and Humber a soil from 6 to 16 in. in depth may be obtained and inequalities of 3 ft. filled up. But every tide generally leaves only  $\frac{1}{2}$  in. of silt, and the field which has only one sluice can only be warped every other tide. The silt, as deposited in each tide, does not mix into a uniform mass, but remains in distinct layers. The water should be made to run completely off and the ditches should become dry before the influx of the next tide, otherwise the silt will increase and the tide no longer have the same effect. Warp soil is of surpassing fertility. The expense of forming canals, embankments and sluices for warping land is from £10 to £20 an acre. A sluice of 6 ft. in height and 8 ft. wide will warp from 60 to 80 acres, according to the distance of the field from the river. The embankments may be from 3 to 7 ft. in height, as the field may stand in regard to the level of the highest tides. After the new land has been left for a year or two in seeds and clover, it produces great crops of wheat and potatoes.

Warping is practised only in Lincolnshire and Yorkshire, on the estuary of the Humber, and in the neighbourhood of the rivers which flow into it—the Trent, the Ouse and the Don. The silt and mud brought down by these rivers is rich in clay and organic matter, and sometimes when dry contains as much as 1% of nitrogen.

Constant care is required if a water-meadow is to yield quite satisfactory results. The earliness of the feed, its quantity and its quality will all depend in very great measure upon the proper management of the irrigation. The points which require constant attention are—the perfect freedom of all carriers, feeders and drains from every kind of obstruction, however minute; the state and amount of water in the river or stream, whether it be sufficient to irrigate the whole area properly or only a part of it; the length of time the water should be allowed to remain on the meadow at different periods of the season; the regulation of the depth of the water, its quantity and its rate of flow, in accordance with the temperature and the condition of the herbage; the proper times for the commencing and ending of pasturing and of shutting up for hay; the mechanical condition of the surface of the ground; the cutting out of any very large and coarse plants, as docks; and the improvement of the physical and chemical conditions of the soil by additions to it of sand, silt, loam, chalk, &c.

Whatever may be the command of water, it is unwise to attempt to irrigate too large a surface at once. Even with a river supply fairly constant in level and always abundant, no attempt should be made to force on a larger volume of water than the feeders can properly distribute and the drains adequately remove, or one part of the meadow will be deluged and another stinted. When this inequality of irrigation once occurs, it is likely to increase from the consequent derangement of the feeders and drains. And one result on the herbage will be an irregularity of composition and growth, seriously detrimental to its food-value. The adjustment of the water by means of the sluices is a delicate operation when there is little water and also when there is much; in the latter case the fine earth may be washed away from some parts of the meadow; in the former case, by attempting too much with a limited water current, one may permit the languid streams to deposit their valuable suspended matters instead of carrying them forward to enrich the soil. The water is not to be allowed to remain too long on the ground at a time. The soil must get dry at stated intervals in order that the atmospheric air may come in contact with it and penetrate it. In this way as the water sinks down through the porous subsoil or into the subterranean drains oxygen enters and supplies an element which is needed, not only for the oxidation of organic matters in the earth, but also for the direct and indirect nutrition of the roots. Without this occasional drying of the soil the finer grasses and the leguminous plants will infallibly be lost; while a scum of confervae and other algae will collect upon the surface and choke the higher forms of vegetation. The water should be run off thoroughly, for a little stagnant water lying in places upon the surface does much injury. The practice of irrigating differs in different places with differences in the quality of the water, the soil, the drainage, &c. As a general rule, when the irrigating season begins in November the water may flow for a fortnight continuously, but subsequent waterings, especially after December, should be shortened gradually in duration till the first week in April, when irrigation should cease. It is necessary to be very careful in irrigating during frosty weather. For, though grass will grow even under ice, yet if ice be formed under and around the roots of the grasses the plants may be thrown out by the expansion of the water at the moment of its conversion into ice. The water should be let off on the morning of a dry day, and thus the land will be dry enough at night not to suffer from the frost;—or the water may be taken off in the morning and let on again at night. In spring the newly grown and tender grass will be easily destroyed by frost if it be not protected by water, or if the ground be not made thoroughly dry.

Although in many cases it is easy to explain the reasons why water artificially applied to land brings crops or increases their yield, the theory of our ordinary water-meadow irrigation is rather obscure. For we are not dealing in these grass lands with a semi-aquatic plant like rice, nor are

**Management and Advantages.**

**Theory.**

we supplying any lack of water in the soil, nor are we restoring the moisture which the earth cannot retain under a burning sun. We irrigate chiefly in the colder and wetter half of the year, and we "saturate" with water the soil in which are growing such plants as are perfectly content with earth not containing more than one-fifth of its weight of moisture. We must look in fact to a number of small advantages and not to any one striking beneficial process in explaining the aggregate utility of water-meadow irrigation. We attribute the usefulness of water-meadow irrigation, then, to the following causes: (1) the temperature of the water being rarely less than  $10^{\circ}$  Fahr. above freezing, the severity of frosts in winter is thus obviated, and the growth, especially of the roots of grasses, is encouraged; (2) nourishment or plant food is actually brought on to the soil, by which it is absorbed and retained, both for the immediate and for the future use of the vegetation, which also itself obtains some nutrient material directly; (3) solution and redistribution of the plant food already present in the soil occur mainly through the solvent action of the carbonic acid gas present in a dissolved state in the irrigation-water; (4) oxidation of any excess of organic matter in the soil, with consequent production of useful carbonic acid and nitrogen compounds, takes place through the dissolved oxygen in the water sent on and through the soil where the drainage is good; and (5) improvement of the grasses, and especially of the miscellaneous herbage, of the meadow is promoted through the encouragement of some at least of the better species and the extinction or reduction of mosses and of the innutritious weeds.

To the united agency of the above-named causes may safely be attributed the benefits arising from the special form of water-irrigation which is practised in England. Should it be thought that the traces of the more valuable sorts of plant food (such as compounds of nitrogen, phosphates, and potash salts) existing in ordinary brook or river water can never bring an appreciable amount of manurial matter to the soil, or exert an appreciable effect upon the vegetation, yet the quantity of water used during the season must be taken into account. If but 3000 gallons hourly trickle over and through an acre, and if we assume each gallon to contain no more than one-tenth of a grain of plant food of the three sorts just named taken together, still the total, during a season including ninety days of actual irrigation, will not be less than 0 lb per acre. It appears, however, that a very large share of the benefits of water-irrigation is attributable to the mere contact of abundance of moving water, of an even temperature, with the roots of the grass. The growth is less checked by early frosts; and whatever advantages to the vegetation may accrue by occasional excessive warmth in the atmosphere in the early months of the year are experienced more by the irrigated than by the ordinary meadow grasses by reason of the abundant development of roots which the water has encouraged.

III. *Italian Irrigation.*—The most highly developed irrigation in the world is probably that practised in the plains of Piedmont and Lombardy, where every variety of condition is to be found. The engineering works are of a very high class, and from long generations of experience the farmer knows how best to use his water. The principal river of northern Italy is the Po, which rises to the west of Piedmont and is fed not from glaciers like the Swiss torrents, but by rain and snow, so that the water has a somewhat higher temperature, a point to which much importance is attached for the valuable meadow irrigation known as *marcite*. This is only practised in winter when there is abundance of water available, and it much resembles the water-meadow irrigation of England. The great Cavour canal is drawn from the left bank of the Po a few miles below Turin, and it is carried right across the drainage of the country. Its full discharge is 3800 cub. ft. per second, but it is only from October to May, when the water is least required, that it carries anything like this amount. For the summer irrigation Italy depends on the glaciers of the Alps; and the great torrents of the Dora Baltea and Sesia can be counted on for a volume exceeding 6000 cub. ft. per second. Lombardy is quite as well

off as Piedmont for the means of irrigation and, as already said, its canals have the advantage that being drawn from the lakes Maggiore and Como they exercise a moderating influence on the Ticino and Adda rivers, which is much wanted in the Dora Baltea. The Naviglio Grande of Lombardy is a very fine work drawn from the left bank of the Ticino and useful for navigation as well as irrigation. It discharges between 3000 and 4000 cub. ft. per second, and probably nowhere is irrigation carried on with less expense. Another canal, the Villorosi, drawn from the same bank of the Ticino farther upstream, is capable of carrying 6700 cub. ft. per second. Like the Cavour canal, the Villorosi is taken across the drainage of the country, entailing a number of very bold and costly works.

Interesting as these Italian works are, the administration and distribution of the water is hardly less so. The system is due to the ability of the great Count Cavour; what he originated in Piedmont has been also carried out in Lombardy. The Piedmontese company takes over from the government the control of all the irrigation within a triangle between the left bank of the Po and the right bank of the Sesia. It purchases from government about 1250 cub. ft. per second, and has also obtained the control of all private canals. Altogether it distributes about 2275 cub. ft. of water and irrigates about 141,000 acres, on which rice is the most important crop. The association has 14,000 members and controls nearly 10,000 m. of distributary channels. In each parish is a council composed of all land-owners who irrigate. Each council sends two deputies to what may be called a water parliament. This assembly elects three small committees, and with them rests the whole management of the irrigation. An appeal may be made to the civil courts from the decision of these committees, but so popular are they that such appeals are never made. The irrigated area is divided into districts, in each of which is an overseer and a staff of watchmen to see to the opening and shutting of the *modules* (see HYDRAULICS, §§ 54 to 56) which deliver the water into the minor channels. In the November of each year it is decided how much water is to be given to each parish in the year following, and this depends largely on the number of acres of each crop proposed to be watered. In Lombardy the irrigation is conducted on similar principles. Throughout, the Italian farmer sets a very high example in the loyal way he submits to regulations which there must be sometimes a strong temptation to break. A sluice surreptitiously opened during a dark night and allowed to run for six hours may quite possibly double the value of his crop, but apparently the law is not often broken.

IV. *Egypt.*—The very life of Egypt depends on its irrigation, and, ancient as the irrigation is, it was never practised on a really scientific system till after the British occupation. As every one knows, the valley of the Nile outside of the tropics is practically devoid of rainfall. Yet it was the produce of this valley that formed the chief granary of the Roman Empire. Probably nowhere in the world is there so large a population per square mile depending solely on the produce of the soil. Probably nowhere is there an agricultural population so prosperous, and so free from the risks attending seasons of drought or of flood. This wealth and prosperity are due to two very remarkable properties of the Nile. First, the regimen of the river is nearly constant. The season of its rise and its fall, and the height attained by its waters during the highest flood and at lowest Nile vary to a comparatively small extent. Year after year the Nile rises at the same period, it attains its maximum in September and begins to diminish first rapidly till about the end of December, and then more slowly and more steadily until the following June. A late rise is not more than about three weeks behind an early rise. From the lowest to the highest gauge of water-surface the rise is on an average 25.5 ft. at the First Cataract. The highest flood is 3.5 ft. above this average, and this means peril, if not disaster, in Lower Egypt. The lowest flood on record has risen only to 5.5 ft. below the average, or to 20 ft. above the mean water-surface of low Nile. Such a feeble Nile flood has occurred only

*Characteristics of the Nile Valley and flood.*



four times in modern history: in 1877, when it caused widespread famine and death throughout Upper Egypt, 947,000 acres remained barren, and the land revenue lost £1,112,000; in 1899 and again in 1902 and 1907, when by the thorough remodelling of the whole system of canals since 1883 all famine and disaster were avoided and the loss of revenue was comparatively slight. In 1907, for instance, when the flood was nearly as low as in 1877, the area left unwatered was little more than 10% of the area affected in 1877.

This regularity of flow is the first exceptional excellence of the river Nile. The second is hardly less valuable, and consists in the remarkable richness of the alluvium brought down the river year after year during the flood. The object of the engineer is so to utilize this flood-water that as little as possible of the alluvium may escape into the sea, and as much as possible may be deposited on the fields. It is the possession of these two properties that imparts to the Nile a value quite unique among rivers, and gives to the farmers of the Nile Valley advantages over those of any rain-watered land in the world.

Until the 19th century irrigation in Egypt on a large scale was practised merely during the Nile flood. Along each edge

*Irrigation during high Nile.* of the river and following its course has been erected an earthen embankment high enough not to be topped by the highest floods. In Upper Egypt, the valley of which rarely exceeds 6 m. in width, a series of cross embankments have been constructed, abutting at the inner ends on those along the Nile, and at the outer ends on the ascending sides of the valley. The whole country has thus been divided into a series of oblongs, surrounded by embankments on three sides and by the desert slopes on the fourth. These oblong areas vary from 60,000 to 1500 or 2000 acres in extent. Throughout all Egypt the Nile is deltaic in character; that is, the slope of the country in the valley is away from the river and not towards it. It is easy, then, when the Nile is low, to cut short, deep canals in the river banks, which fill as the flood rises, and carry the precious mud-charged water into these great flats. There the water remains for a month or more, some 3 ft. deep, depositing its mud, and thence at the end of the flood the almost clear water may either be run off directly into the receding river, or cuts may be made in the cross embankments, and it may be allowed to flow from one flat to another and ultimately into the river. In November the waters have passed off; and whenever a man can walk over the mud with a pair of bullocks, it is roughly turned over with a wooden plough, or merely the branch of a tree, and the wheat or barley crop is immediately sown. So soaked is the soil after the flood, that the grain germinates, sprouts, and ripens in April, without a shower of rain or any other watering.

In Lower Egypt this system was somewhat modified, but it was the same in principle. No other was known in the Nile Valley until the country fell, early in the 10th century, under the vigorous rule of Mehemet Ali Pasha. He soon recognized that with such a climate and soil, with a teeming population, and with the markets of Europe so near they might produce in Egypt something more profitable than wheat and maize. Cotton and sugar-cane would fetch far higher prices, but they could only be grown while the Nile was low, and they required water at all seasons.

It has already been said that the rise of the Nile is about 25½ ft., so that a canal constructed to draw water out of the river while at its lowest must be 25½ ft. deeper than if it is intended to draw off only during the highest floods. Mehemet Ali began by deepening the canals of Lower Egypt by this amount, a gigantic and futile task; for as they had been laid out on no scientific principles, the deep channels became filled with mud during the first flood, and all the excavation had to be done over again, year after year. With a serf population even this was not impossible; but as the beds of the canals were graded to no even slope, it did not follow that if water entered the head it would flow

*Irrigation during low Nile.*

evenly on. As the river daily fell, of course the water in the canals fell too, and since they were never dug deep enough to draw water from the very bottom of the river, they occasionally ran dry altogether in the month of June, when the river was at its lowest, and when, being the month of greatest heat, water was more than ever necessary for the cotton crop. Thus large tracts which had been sown, irrigated, weeded and nurtured for perhaps three months perished in the fourth, while all the time the precious Nile water was flowing useless to the sea. The obvious remedy was to throw a weir across each branch of the river to control the water and force it into canals taken from above it. The task of constructing this great work was committed to Mougél Bey, a French engineer of ability, who designed and constructed the great barrage across the two branches of the Nile at the apex of the delta, about 12 m. north of Cairo (fig. 2). It was built to consist of two bridges—one over the eastern or Damietta branch of the river having 71 arches, the other, over the Rosetta branch, having 61 arches, each arch being of 5 metres or 16·4 ft. span. The building was all of stone, the floors of the arches were inverted. The height of pier from edge of flooring to spring of arch, was 28·7 ft., the spring of the arch being about the surface-level of maximum flood. The arches were designed to be fitted with self-acting drop gates; but they were not a success, and were only put into place on the Rosetta branch. The gates were intended to hold up the water 4·5 metres,

or 14·76 ft., and to divert it into three main canals—the Behera on the west, the Menufia in the centre and the Tewfikia on the east. The river was thus to be emptied, and to flow through a whole network of canals, watering all Lower Egypt. Each barrage was provided with locks to pass Nile boats 160 by 28 ft. in area.

Mougél's barrage, as it may now be seen, is a very imposing and stately work. Considering his want of experience of such rivers as the Nile, and the great difficulties he had to contend with under a succession of ignorant Turkish rulers, it would be unfair to blame him because, until it fell into the hands of British engineers in 1884, the work was condemned as a hopeless failure. It took long years to complete, at a cost which can never be estimated, since much of it was done by serf labour. In 1861 it was at length said to be finished; but it was not until 1863 that the gates of the Rosetta branch were closed, and they were reopened again immediately, as a settlement of the masonry took place. The experiment was repeated year after year till 1867, when the barrage cracked right across from foundation to top. A massive coffer-dam was then erected, covering the eleven arches nearest the crack; but the work was never trusted again, nor the water-surface raised more than about 3 ft.

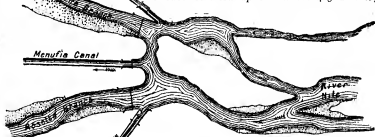

FIG. 2.—Map showing the Damietta and Rosetta dams on the Nile.

An essential part of the barrage project was the three canals, taking their water from just above it, as shown in fig. 2. The heads of the existing old canals, taken out of the river at intervals throughout the delta, were to be closed, and the canals themselves all put into connexion with the three high-level trunk lines taken from above the barrage. The central canal, or Menufia, was more or less finished, and, although full of defects, has done good service. The eastern canal was never dug at all until

*The Nile Barrage.*

the British occupation. The western, or Behera, canal was dug, but within its first 50 m. it passes through desert, and sand drifted into it. *Corvées* of 20,000 men used to be forced to clear it out year after year, but at last it was abandoned. Thus the whole system broke down, the barrage was pronounced a failure, and attention was turned to watering Lower Egypt by a system of gigantic pumps, to raise the water from the river and discharge it into a system of shallow surface-canal, at an annual cost of about £250,000, while the cost of the pumps was estimated at £700,000. Negotiations were on foot for carrying out this system when the British engineers arrived in Egypt. They soon resolved that it would be very much better if the original scheme of using the barrage could be carried out, and after a careful examination of the work they were satisfied that this could be done. The barrage rests entirely on the alluvial bed of the Nile. Nothing more solid than strata of sand and mud is to be found for more than 200 ft. below the river. It was out of the question, therefore, to think of founding on solid material, and yet it was desired to have a head of water of 13 or 14 ft. upon the work. Of course, with such a pressure as this, there was likely to be percolation under the foundations and a washing-out of the soil. It had to be considered whether this percolation could best be checked by laying a solid wall across the river, going down 10 or 60 ft. below its bed, or by spreading out the foundations above and below the bridge, so as to form one broad water-tight flooring—a system practised with eminent success by Sir Arthur Cotton in Southern India. It was decided to adopt the latter system. As originally designed, the flooring of the barrage from up-stream to down-stream face was 111.50 ft. wide, the distance which had to be travelled by water percolating under the foundations. This width of flooring was doubled to 223 ft., and along the up-stream face a line of sheet piling was driven 16 ft. deep. Over the old flooring was superposed 15 in. of the best rubble masonry, an ashlar floor of blocks of close-grained trachyte being laid directly under the bridge, where the action was severest. The working season lasted only from the end of November to the end of June, while the Nile was low; and the difficulty of getting in the foundations was increased, as, in the interests of irrigation and to supply the Menufia canal, water was held up every season while the work was in progress to as much as 10 ft. The work was begun in 1886, and completed in June 1890. Moreover, in the meantime the eastern, or Tewfikia, canal was dug and supplied with the necessary masonry works for a distance of 23 m., to where it fed the network of old canals. The western, or Behera, canal was thoroughly cleared out and remodelled; and thus the whole delta irrigation was supplied from above the barrage.

The outlay on the barrage between 1883 and 1891 amounted to about £460,000. The average cotton crop for the 5 years preceding 1884 amounted to 123,000 tons, for the 5 years ending 1898 it amounted to 251,200 tons. At the low rate of £40 per ton, this means an annual increase to the wealth of Lower Egypt of £5,128,000. Since 1890 the barrage has done its duty without accident, but a work of such vast importance to Lower Egypt required to be placed beyond all risk. It having been found that considerable hollow spaces existed below the foundations of some of the piers, five bore-holes from the top of the roadway were pierced vertically through each pier of both barrages, and similar holes were drilled at intervals along all the lock walls. Down these holes cement grout was injected under high pressure on the system of Mr Kinipple. The work was successfully carried out during the seasons 1896 to 1898. During the summer of 1898 the Rosetta barrage was worked under a pressure of 14 ft. But this was looked on as too near the limit of safety to be relied on, and in 1899 subsidiary weirs were started across both branches of the river a short distance below the two barrages. These were estimated to cost £530,000 altogether, and were to stand 10-8 ft. above the river's bed, allowing the water-surface up-stream of the barrage to be raised 7.2 ft., while the pressure on that work itself would not exceed 10 ft. These weirs were satisfactorily completed in 1901.

The barrage is the greatest, but by no means the only important masonry work in Lower Egypt. Numerous regulating bridges and locks have been built to give absolute control of the water and facilities for navigation; and since 1901 a second weir has been constructed opposite Zifta, across the Damietta branch of the Nile, to improve the irrigation of the Dakkhila province.

In the earlier section of this article it is explained how necessary it is that irrigation should always be accompanied by drainage. This had been totally neglected in Egypt; but very large sums have been spent on it, and the country is now covered with a network of drains nearly as complete as that of the canals.

The ancient system of basin irrigation is still pursued in Upper Egypt, though by the end of 1907 over 320,000 feddans of land formerly under basin irrigation had been given, at a cost of over £E3,000,000, perennial irrigation. This conversion work was carried out in the provinces situated between Cairo and Assiut, a region sometimes designated Middle Egypt. The ancient system seems simple enough; but in order really to flood the whole Nile Valley during seasons of defective as well as favourable floods, a system of regulating sluices, culverts and syphons is necessary; and for want of such a system it was found, in the feeble flood of 1888, that there was an area of 260,000 acres over which the water never flowed. This cost a loss of land revenue of about £300,000, while the loss of the whole season's crop to the farmer was of course much greater. The attention of the British engineers was then called to this serious calamity; and fortunately for Egypt there was serving in the country Col. J. C. Ross, R.E., an officer who had devoted many years of hard work to the irrigation of the North-West Provinces of India, and who possessed quite a special knowledge as well as a glowing enthusiasm for the subject. Fortunately, too, it was possible to supply him with the necessary funds to complete and remodel the canal system. When the surface-water of a river is higher than the fields right and left, there is nothing easier than to breach the embankments and flood the fields—in fact, it may be more difficult to prevent their being flooded than to flood them—but in ordinary floods the Nile is never higher than all the bordering lands, and in years of feeble flood it is higher than none of them. To water the valley, therefore, it is necessary to construct canals having bed-slopes less than that of the river, along which the water flows until its surface is higher than that of the fields. If, for instance, the slope of the river be 4 in. per mile, and that of the canal 2 in. it is evident that at the end of a mile the water in the canal will be 2 in. higher than in the river; and if the surface of the land is 3 ft. higher than that of the river, the canal, gaining on it at 2 in. per mile, will reach the surface in 18 m., and from thence onwards will be above the adjoining fields. But to irrigate this upper 18 m., water must either be raised artificially, or supplied from another canal taking its source 18 m. farther up. This would, however, involve the country in great lengths of canal between the river and the field, and circumstances are not so unfavourable as this. Owing to the deltaic nature of the Nile Valley, the fields on the banks are 3 ft. above the flood, at 2 m. away from the banks they may not be more than 1 ft. above that level, so that the canal, gaining 2 in. per mile and receding from the river, will command the country in 6 m. The slope of the river, moreover, is taken in its winding course; and if it is 4 in. per mile, the slope of the axis of the valley parallel to which the canals may be made to flow is at least 6 in. per mile, so that a canal with a slope of 2 in. gains 4 in. per mile.

The system of having one canal overlapping another has one difficulty to contend with. Occasionally the desert cliffs and slopes come right down to the river, and it is difficult, if not impossible, to carry the higher-level canals past these obstructions. It should also be noticed that on the higher strip bordering the river it is the custom to take advantage of its nearness to raise water by pumps, or other machinery, and thereby to grow valuable crops of sugar-cane, maize or vegetables. When the

Basin  
irrigation  
of Upper  
Egypt.

river rises, these crops, which often form a very important part of the year's produce and are termed *Nabâri*, are still in the ground, and they require water in moderate and regulated quantities, in contradistinction to the wholesale flooding of the flats beyond. Fig. 3 will serve to explain this system of irrigation, the firm lines representing canals, the dotted lines embankments. It will be seen, beginning on the east or right bank of the river, that a high-level canal from an upper system is carried past a steep slope, where perhaps it is cut entirely out of rock, and it divides into two. The right branch waters all the desert slopes within its reach and level. The left branch passes, by a syphon aqueduct, under what is the main canal of the system, taken from the river close at hand (and therefore at a lower level). This left branch irrigates the *Nabâri* on the high lands bordering the river. In years of very favourable flood this high-level canal would not be wanted at all: the irrigation could be done from the main canal, and with this great advantage, that the main canal water would carry with it much more fertilizing matter than would be got from the tail of the high-level canal, which left the river perhaps 25 m. up. The main canal flows freely over the flats C and D, and, if the flood is good, over B and part of A. It is carried round the next desert point, and to the north becomes the high-level canal. The masonry

remained. There being at its head no weir across the Nile, the water in the Ibrahimia canal used to rise and fall with that of the river, and so the supply was apt to run short during the hottest months, as was the case with the canals of Lower Egypt before the barrage was built. To supply the Ibrahimia canal at all during low Nile, it had been necessary to carry on dredging operations at an annual cost of about £12,000. This has now been rectified, in the same way as in Lower Egypt, by the construction of a weir across the Nile, intended to give complete control over the river and to raise the water-surface 8.2 ft. The Assiut weir is constructed on a design very similar to that of the barrage in Lower Egypt. It consists of a bridge of 111 arches, each 5 metres span, with piers of 2 metres thickness. In each arch are fitted two gates. There is a lock 80 metres long and 16 metres wide at the left or western end of the weir, and adjoining it are the regulating sluices of the Ibrahimia canal. The Assiut weir across the Nile is just about half a mile long. The work was begun at the end of 1898 and finished early in 1902—in time to avert over a large area the disastrous effects which would otherwise have resulted from the low Nile of that year. The money value of the crops saved by the closing of the weir was not less than £660,000. The conversion of the lands north of Assiut from basin to perennial irrigation began immediately after the completion of the Assiut weir and was finished by the end of 1908. To render the basin lands of the Kena province independent of the flood being bad or good, another barrage was built across the Nile at Esna at a cost of £1,000,000. This work was begun in 1906 and completed in 1909.

These works, as well as that in Lower Egypt, are intended to raise the water-surface above it, and to control the distribution of its supply, but in no way to store that supply. The idea of ponding up the superfluous flood discharge of the river is not a new one, and if Herodotus is to be believed, it was a system actually pursued at a very early period of Egyptian history, when Lake Moeris in the Fayûm was filled at each Nile flood, and drawn upon as the river ran down. When British engineers first undertook the management of Egyptian irrigation many representations were made to them of the advantage of storing the Nile water; but they consistently maintained that before entering on that subject it was their duty to utilize every drop of the water at their disposal. This seemed all the more evident, as at that time financial reasons made the construction of a costly Nile dam out of the question. Every year, however, between 1800 and 1902 the supply of the Nile during May and June was actually exhausted, no water at all flowing then out into the sea. In these years, too, owing to the extension of drainage works, the irrigable area of Egypt was greatly enlarged, so that if perennial cultivation was at all to be increased, it was necessary to increase the volume of the river, and this could only be done by storing up the flood supply. The first difficulty that presented itself in carrying this out, was that during the months of highest flood the Nile is so charged with alluvial matter that to pond it up then would inevitably lead to a deposit of silt in the reservoir, which would in no great number of years fill it up. It was found, however, that the flood water was comparatively free from deposit by the middle of November, while the river was still so high that, without injuring the irrigation, water might go on being stored up until March. Accordingly, when it was determined to construct a dam, it was decided that it should be supplied with sluices large enough to discharge unchecked the whole volume of the river as it comes down until the middle of November, and then to begin the storage.

The site selected for the great Nile dam was at the head of the First Cataract above Assuan. A dyke of syenite granite here crosses the valley, so hard that the river had nowhere scoured a deep channel through it, and so it was found possible to construct the dam entirely in the open air, without the

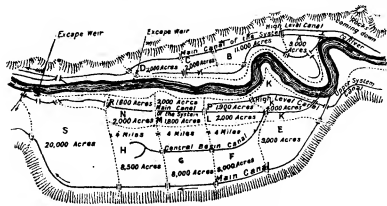

FIG. 3.—Map of the Basin System of Irrigation.

works required for this system are a syphon to pass the high level under the main canal near its head, bridges fitted with sluices where each canal passes under an embankment, and an escape weir at the tail of the system, just south of the desert point, to return surplus water to the river. Turning to the left bank, there is the same high-level canal from the upper system irrigating the basins K, P and L, as well as the large basin E in such years as it cannot be irrigated from the main canal. Here there are two main canals—one following the river, irrigating a series of smaller basins, and throwing out a branch to its left, the other passing under the desert slopes and supplying the basins F, G, H and S. For this system two syphons will be required near the head, regulating bridges under all the embankments, and an escape weir back into the river.

In the years following 1888 about 100 new masonry works of this kind were built in Upper Egypt, nearly 400 m. of new canal were dug, and nearly 300 m. of old canal were enlarged and deepened. The result has been, as already stated, that with a complete failure of the Nile flood the loss to the country has been trifling compared with that of 1877.

The first exception in Upper Egypt to the basin system of irrigation was due to the Khedive Ismail. The khedive, having acquired vast estates in the provinces of Assiut, Miniah, Beni-Suef and the Fayûm, resolved to grow sugar-cane on a very large scale, and with this object constructed a very important perennial canal, named the Ibrahimia, taking out of the left bank of the Nile at the town of Assiut, and flowing parallel to the river for about 200 m., with an important branch which irrigates the Fayûm. This canal was badly constructed, and by entirely blocking the drainage of the valley did a great deal of harm to the lands. Most of its defects had been remedied, but one

necessity of laying under-water foundations. The length of the dam is about 6400 ft.—nearly  $1\frac{1}{4}$  m. The greatest head of water in it is 65 ft. It is pierced by 140 under-sluices of 150 sq. ft. each, and by 40 upper-sluices, each of 75 sq. ft. These, when fully open, are capable of discharging the ordinary maximum Nile flood of 350,000 cub. ft. per second, with a velocity of 15.6 ft. per second and a head of 6.6 ft. The top width of the dam is 23 ft., the bottom width at the deepest part about 82 ft. On the left flank of the dam there is a canal, provided with four locks, each 262 by 31 ft. in area, so that navigation is possible at all seasons. The storage capacity of the reservoir is about 3,750,000 millions of cub. ft., which creates a lake extending up the Nile Valley for about 200 m. The reservoir is filled yearly by March; after that the volume reaching the reservoir from the south is passed on through the sluices. In May, or earlier when the river is late in rising, when the demand for water increases, first the upper and then the under sluices are gradually opened, so as to increase the river supply, until July, when all the gates are open, to allow of the free passage of the flood. On the 10th of December 1902 this magnificent work was completed. The engineer who designed it was Sir W. Willcocks. The contractors were Messrs John Aird & Co., the contract price being £2,600,000. The financial treaties in which the Egyptian government were bound up prevented their ever paying so large a sum as this within five years; but a company was formed in London to advance periodically the sum due to the contractors, on receipt from the government of Egypt of promissory notes to pay sixty half-yearly instalments of £78,613, beginning on the 1st of July 1903. Protective works downstream of the dam were completed in 1906 at a cost of about £3,304,000. It had been at first intended to raise the dam to a height which would have involved the submergence, for some months of every year, of the Philæ temples, situated on an island just upstream of the dam. Had the natives of Egypt been asked to choose between the preservation of Ptolemy's famed temple and the benefit to be derived from a considerable additional depth of water storage, there can be no question that they would have preferred the latter; but they were not consulted, and the classical sentiment and artistic beauty of the place, skillfully pleaded by archaeologists and artists, prevailed. In 1907, however, it was decided to carry out the plan as originally proposed and raise the dam 26 ft. higher. This would increase the storage capacity  $2\frac{1}{2}$  times, or to about 9,375,000 millions of cubic feet.

There is no middle course of farming in Egypt between irrigation and desert. No assessment can be levied on lands which have not been watered, and the law of Egypt requires that in order to render land liable to taxation the water during the Nile flood must have flowed naturally over it. It is not enough that it should be pumped on to the land at the expense of the landowner. The tax usually levied is from £1 to £2 per acre.

See Sir W. Willcocks, *Egyptian Irrigation* (2nd ed., 1899); Sir C. C. Scott-Moncrieff, *Lectures on Irrigation in Egypt. Professional Papers on the Corps of Royal Engineers*, vol. xix. (London, 1893); Sir W. Garstin, *Report upon the Basin of the Upper Nile*. Egypt No. 2 (1904).

V. India.—Allusion has already been made to the irrigation of India. The year 1878, which saw the end of a most disastrous famine, may be considered as the commencement of a new era as regards irrigation. It had at last been recognized that such famines must be expected to occur at no very long intervals of time, and that the cost of relief operations must not be met by increasing the permanent debt on the country, but by the creation of a famine relief and a famine insurance fund. For this purpose it was fixed that there should be an annual provision of Rs. 1,500,000, to be spent on: (1) relief, (2) protective works, (3) reduction of debt. Among protective works the first place was given to works of irrigation. These works were divided into three classes: (i.) productive works; (ii.) protective works; (iii.) minor works.

Productive works, as their name implies, are such as may

reasonably be expected to be remunerative, and they include all the larger irrigation systems. Their capital cost is provided from loan funds, and not from the relief funds mentioned above. In the seventeen years ending 1896-1897 the capital expenditure on such works was Rs. 10,954,948, including a sum of Rs. 1,742,246 paid to the Madras Irrigation Company as the price of the Kurnool-Cuddapah canal, a work which can never be financially productive, but which nevertheless did good service in the famine of 1896-1897 by irrigating 87,226 acres. In the famine year 1877-1878 the area irrigated by productive canals was 5,171,497 acres. In the famine year 1896-1897 the area was 9,571,779 acres, including an area of 123,087 acres irrigated on the Swat river canal in the Punjab. The revenue of the year 1879-1880 was nearly 6% on the capital outlay. In 1897-1898 it was 7½%. In the same seventeen years Rs. 2,099,253 were spent on the construction of protective irrigation works, not expected to be directly remunerative, but of great value during famine years. On four works of this class were spent Rs. 1,649,823, which in 1896-1897 irrigated 200,733 acres, a valuable return then, although in an ordinary year their gross revenue does not cover their working expenses. Minor works may be divided into those for which capital accounts have been kept and those where they have not. In the seventeen years ending 1896-1897, Rs. 827,214 were spent on the former, and during that year they yielded a return of 9.13%. In the same year the irrigation effected by minor works of all sorts showed the large area of 7,442,990 acres. Such are the general statistics of outlay, revenue and irrigated area up to the end of 1896-1897. The government might well be congratulated on having through artificial means ensured in that year of widespread drought and famine the cultivation of 27,326 sq. m., a large tract even in so large a country as India. And progress has been steadily made in subsequent years.

Some description will now be given of the chief of these irrigation works. Beginning with the Punjab, the province in which most progress has been made, the great Sutlej canal, which irrigates the country to the left of that river, was opened in 1882, and the Western Jumna canal (perhaps the oldest in India) was extended into the dry Hissar and Sirsa districts, and generally improved so as to increase by nearly 50% its area of irrigation between 1878 and 1897. Perhaps this is as much as can well be done with the water at command for the country between the Sutlej and the Jumna, and it is enough to secure it for ever from famine. The Bari Doab canal, which irrigates the Gurdaspur, Amritsar and Lahore districts, has been enlarged and extended so as to double its irrigation since it was projected in 1877-1878. The Chenab canal, the largest in India and the most profitable, was only begun in 1880. It was designed to command an area of about 2½ million acres, and to irrigate annually rather less than half that area. This canal flows through land that in 1880 was practically desert. From the first arrangements were made for bringing colonists in from the more congested parts of India. The colonization began in 1892. Nine years later this canal watered 1,830,525 acres. The population of the immigrant colony was 792,666, consisting mainly of thriving and prosperous peasants with occupancy rights in holdings of about 28 acres each. The direct revenue of this canal in 1906 was 26% on the capital outlay. The Jhelum canal was opened on the 30th of October 1901. It is a smaller work than the Chenab, but it is calculated to command 1,130,000 acres, of which at least half will be watered annually. A much smaller work, but one of great interest, is the Swat-tribe canal in the Peshawar valley. It was never expected that this would be a remunerative work, but it was thought for political reasons expedient to construct it in order to induce turbulent frontier tribes to settle down into peaceful agriculture. This has had a great measure of success, and the canal itself has proved remunerative, irrigating 123,000 acres in 1896-1897. A much greater scheme than any of the above is that of the Sind Sagar canal, projected from the left bank of the Indus opposite Kalabagh, to irrigate 1,750,000 acres at a cost of Rs. 6,000,000. Another great canal scheme for the Punjab

proposed to take off from the right bank of the Sutlej, and to irrigate about 600,000 acres in the Montgomery and Multan districts, at a cost of Rs. 2,500,000. These three last projects would add 2,774,000 acres to the irrigated area of the province, and as they would flow through tracts almost unpeopled, they would afford a most valuable outlet for the congested districts of northern India. In addition to these great perennial canals, much has been done since 1878 in enlarging and extending what are known as the "inundation canals" of the Punjab, which utilize the flood waters in the rivers during the monsoon season and are dry at other times. By these canals large portions of country throughout most of the Punjab are brought under cultivation, and the area thus watered has increased from about 180,000 to 500,000 acres since 1878.

It is on inundation canals such as these that the whole cultivation of Sind depends. In 1878 the area was about 1,500,000 acres; in 1896-1897 it had increased to 2,484,000 acres. This increase was not due to famine in Sind, for that rainless province depends always on the Indus, as Egypt does on the Nile, and where there is no rainfall there can be no drought. But the famine prices obtained for agricultural produce doubtless gave an impetus to cultivation. In Sind, too, there is room for much increase of irrigation. It has been proposed to construct two new canals, the Jamrao and the Shikārpur, and to improve and extend three existing canals—Nasrat, Naulakhi and Dad. The total cost of these five projects, some of which are now in progress, was estimated at Rs. 1,506,682, and the extension of irrigation at 660,563 acres.

Turning from the basin of the Indus to that of the Ganges, the commissioners appointed to report on the famine of 1896-1897 found that in the country between the Ganges and the Jumna little was left to be done beyond the completion of some distributary channels. The East India Company's great work, the Ganges canal, constructed between 1840 and 1854 before there was a mile of railway open in India, still holds its place unsurpassed among later irrigation work for boldness of design and completeness of execution, a lasting monument to the genius of Sir Proby Cautley, an officer of the Bengal Artillery, but a born engineer. Ever since 1870 consideration has been given to projects for irrigating the fertile province of Oudh by means of a great canal to be drawn from the river Sarda. The water is there in abundance, the land is well adapted for irrigation, but as there is a considerable rainfall, it is doubtful whether the scheme would prove remunerative, and a large section of the landowners have hitherto opposed it, as likely to waterlog the country. Among the four protective works of irrigation which were said above to have irrigated 200,733 acres in 1896-1897, one of the most important is the Betwa canal, in the parched district of Bundelkhand. This canal has cost Rs. 428,086, and causes an annual loss to the state in interest and working expenses of about Rs. 20,000. It irrigated, however, in 1896-1897 an area of 87,306 acres, raising crops valued at Rs. 231,081, or half the cost of the canal, so it may be said to have justified its construction. A similar canal from the river Ken in the same district has been constructed. Proceeding farther east, we find very satisfactory progress in the irrigation of southern Behar, effected by the costly system of canals drawn from the river Soné. In 1877-1878 these canals irrigated 241,700 acres. Rapid progress was not expected here, and 702,000 acres was calculated as being the maximum area that could be covered with the water supply available.

In the five years preceding 1901-1902 the average irrigated area was 463,181 acres, and during that year the area was 555,156 acres, the maximum ever attained.

The canal system of Orissa was never expected to be remunerative, since in five years out of six the local rainfall is sufficient for the rice crop. In 1878-1879 the area irrigated was 111,250 acres, and the outlay up to date was Rs. 1,750,000. In 1900-1901 the area was 203,540 acres, the highest ever attained, and the capital outlay amounted to Rs. 2,623,703. It should be mentioned in favour of these canals that although the irrigation is not of yearly value, they supply very important water communication through a province which, from its natural configuration, is not likely to be soon intersected by railways. If, moreover, such a famine were again to occur in Orissa as that of 1866-1867, there would be no doubt of the value of these fine canals.

In the Madras presidency and in Mysore irrigation has long assumed a great importance, and the engineering works of the three great deltas of the Godavari, Kistna and Cauvery, the outcome of the genius and indefatigable enthusiasm of Sir Arthur Cotton, have always been quoted as showing what a boon irrigation is to a country. In 1878 the total area of irrigation in the Madras presidency amounted to about 5,000,000 acres. The irrigation of the eight productive systems was 1,680,178 acres, and the revenue Rs. 730,778. In 1898 there were ten of these systems, with an irrigation area, as shown by the accompanying table, of 2,685,915 acres, and a revenue of Rs. 1,163,268:

Irrigation.	Area Watered.	Total Revenue.	Total Expenditure.	Net Revenue.	Capital and Indirect Charges.	Percentage of Net Revenue to Capital.
	Acres.	Rs.	Rs.	Rs.	Rs.	
<i>Major Works.</i>						
1. Godavari Delta . . . . .	779,435	328,443	68,376	260,067	1,297,807	19.15
2. Kistna Delta . . . . .	520,373	254,579	74,142	180,437	1,319,166	13.18
3. Pennar Weir System . . . . .	70,464	28,160	5,037	23,123	189,919	7.59
4. Sangam System . . . . .	76,277	32,627	7,037	25,590	385,601	3.68
5. Kurnool Canal . . . . .	47,008	15,622	12,404	3,218	2,171,740	.15
6. Barur Tank System . . . . .	4,421	1,162	385	777	4,250	1.39
7. Cauvery Delta . . . . .	989,808	434,346	43,464	390,882	199,458	44.87
8. Srivaikuntam System . . . . .	41,668	19,349	4,580	14,669	147,192	5.48
9. Periyar Project . . . . .	89,143	37,526	10,751	26,775	852,914	.27
10. Rushikulya Canal . . . . .	67,318	11,454	3,678	7,776	464,423	.54
<b>Total . . . . .</b>	<b>2,685,915</b>	<b>1,163,268</b>	<b>229,954</b>	<b>933,314</b>	<b>7,032,470</b>	<b>7.88</b>
<i>Minor Works.</i>						
23 Works for which Capital and Revenue Accounts are kept . . . . .	535,813	200,558	34,655	165,903	1,693,878	4.44
Minor Works for which such Accounts are not kept . . . . .	3,131,009	830,175	193,295	636,880	..	..
<b>Grand Total . . . . .</b>	<b>6,352,737</b>	<b>2,194,001</b>	<b>457,904</b>	<b>1,736,097</b>	..	..

In the three great deltas, and the small southern one that depends on the Srivaikuntam weir over the river Tumbarnapi, extension and improvement works have been carried on. The Sangam and Pennar systems depend on two weirs on the river Pennar in the Nellore district, the former about 18 m. above and the latter just below the town of Nellore. The former irrigates on the left, the latter on the right bank of the river. This district suffered severely in the famine of 1877-1878, and the irrigation works were started in consequence. The Barur tank system in the Salem district was also constructed after the famine of 1877-1878. As yet it has not fulfilled expectations. The Periyar scheme has for its object both the addition of new irrigation and the safeguarding of that which exists in the district of Madura, a plain watered by means of a great number of shallow tanks drawing their supply from a very uncertain river, the Vaigai. This river takes its rise on the eastern slopes of the Ghat range of mountains, and just opposite to it, on the western face of the range, is the source of the river Periyar. The rainfall on the west very much exceeds that on the east, and the Periyar used to find its way by a short torrent

course to the sea, rendering no service to mankind. Its upper waters are now stemmed by a masonry dam 178 ft. high, forming a large lake, at the eastern end of which is a tunnel 5700 ft. long, piercing the watershed and discharging 1600 cub. ft. per second down the eastern side of the mountains into the river Vaigai. No bolder or more original work of irrigation has been carried out in India, and the credit of it is due to Colonel J. Pennycuik, C.S.I. The dam and tunnel were works of unusual difficulty. The country was roadless and uninhabited save by wild beasts, and fever and cholera made sad havoc of the working parties; but it was successfully accomplished. The last of those given in the table above was not expected to be remunerative, but it should prove a valuable protective against famine. The system consists of weirs over the rivers Gulleri, Mahanadi and Rushikulya in the backward province of Ganjam, south of Orissa. From these weirs flow canals altogether about 127 m. long, which, in connexion with two large reservoirs, are capable of irrigating 120,000 acres. In 1901 the works, though incomplete, already irrigated 67,318 acres.

In addition to all these great engineering systems, southern India is covered with minor works of irrigation, some drawn from springs in the sandy beds of rivers, some from the rainfall of  $\frac{1}{2}$  sq. m. ponded up in a valley. In other cases tanks are fed from neighbouring streams, and the greatest ingenuity is displayed in preventing the precious water from going to waste.

Allusion has been already made to the canals of Sind. Elsewhere in the Bombay presidency, in the Deccan and Gujarat, there are fewer facilities for irrigation than in other parts of India. The rivers are generally of uncertain volume. The cost of storage works is very great. The population is backward, and the black soil is of a nature that in ordinary years can raise fair crops of cotton, millet and maize without artificial watering. Up to the end of 1896-1897 the capital spent on the irrigation works of the Deccan and Gujarat was Rs. 2,616,959. The area irrigated that year was 262,830 acres. The most important works are the Mutha and Nira canals in the Poona district.

In Upper Burma three productive irrigation works were planned at the opening of the century—the Mandalay, the Shebo, and the Mon canals, of which the first was estimated to cost Rs. 323,280, and to irrigate 72,000 acres. The area estimated from the whole three projects is 262,000 acres, situated in the only part of Burma that is considered liable to famine.

In 1901, after years of disastrous drought and famine, the government of India appointed a commission to examine throughout all India what could be done by irrigation to alleviate the horrors of famine. Up to that time it had been the principle of the government not to borrow money for the execution of irrigation works unless there was a reasonable expectation that within a few years they would give a return of 4 or 5% on the capital outlay. In 1901 the government took larger views. It was found that although some irrigation works (especially in the Bombay Deccan) would never yield a direct return of 4 or 5%, still in a famine year they might be the means of producing a crop which would go far to do away with the necessity for spending enormous sums on famine relief. In the Sholapur district of Bombay, for instance, about three years' revenue was spent on relief during the famine of 1901. An expenditure of ten years' revenue on irrigation works might have done away for all future time with the necessity for the greater part of this outlay. The Irrigation Commission of 1901-1903 published a very exhaustive report after a careful study of every part of India. While emphatically asserting that irrigation alone could never prevent famine, they recommended an outlay of £45,000,000 spread over a period of 25 years.

See also *Annual Reports Irrigation Department Local Governments of India; Reports of the Indian Famine Commissions of 1878, 1898 and 1901; Sir Hanbury Brown, Irrigation, its Principles and Practice* (London, 1907).

VI. *United States*.—At the opening of the 20th century, during Mr Roosevelt's presidency, the new "Conservation"

policy (*i.e.* conservation of natural resources by federal initiative and control), to which he gave so much impetus and encouragement, brought the extension of irrigation works in the United States to the front in American statecraft (see Vrooman, *Mr Roosevelt, Dynamic Geographer*, 1909). Though the carrying out of this policy on a large scale was hampered by many difficulties, the subject was made definitely one of national importance.

On account of the aridity of the climate throughout the greater part of the western third of the United States, the practice of agriculture is dependent upon an artificial supply of water. On most of the country west of the 97th meridian and extending to the Pacific Ocean less than 20 in. of rain falls each year. The most notable exceptions are in the case of a narrow strip west of the Cascade Range and of some of the higher mountain masses. In ordinary years the climate is too dry for successful cultivation of the field crops, although under favourable conditions of soil and cultivation there are certain areas where cereals are grown by what is known as "dry farming." The progress in irrigation up to the end of the 19th century was spasmodic but on the whole steady. The eleventh census of the United States, 1890, showed that 3,564,416 acres were irrigated in 1889. This included only the lands from which crops were produced. Besides this, there were probably 10 million acres under irrigation systems constructed in whole or in part. In 1899 the irrigated area in the arid states and territories was more than twice as great as in 1889, the acreage being as follows:—

Arizona	185,936
California	1,445,872
Colorado	1,611,271
Idaho	602,568
Montana	951,154
Nevada	504,168
New Mexico	203,893
Oregon	388,310
Utah	629,393
Washington	135,470
Wyoming	605,878
Total	7,263,813

In addition to the area above given, in 1899, 273,117 acres were under irrigation in the semi-arid region, east of the states above mentioned and including portions of the states of North and South Dakota, Nebraska, Kansas, Texas and Oklahoma. The greater part of these lands was irrigated by canals or ditches built by individuals acting singly or in co-operation with their neighbours, or by corporations. The national and state governments had not built any works of reclamation excepting where the federal government, through the Indian department, had constructed irrigation ditches for Indian tribes, notably the Crow Indians of Montana. A few of the state governments, such, for example, as Colorado, had built small reservoirs or portions of canals from internal improvement funds.

The construction of irrigation canals and ditches was for the most part brought about by farmers joining to plough out or dig ditches from the rivers, descending on a gentle grade. Some of the corporations constructing works for the sale of water built structures of notable size, such, for example, as the Sweet-water and Hemet dams of southern California, the Bear river canal of Utah, and the Arizona canal, taking water from Salt river, Arizona. The cost of bringing water to the land averaged about \$8 per acre where the ordinary ditches were built. The owners of extensive works were charged from \$12 to \$20 per acre and upwards for so-called "water rights," or the privilege to take water from the canal, this covering cost of construction. Besides the first cost of construction, the irrigator was usually called upon to pay annually a certain amount for maintenance, which might often be worked out by labour on the canal. The cost ranged from 50 cents to \$1 per acre; or, with incorporated companies, from \$1.50 to \$2.50 per acre and upwards. The largest expense for water rights and for annual maintenance was incurred in southern California, where the character of the crops, such as citrus fruits, and the scarcity of the water make possible

expensive construction and heavy charges. The legal expense for the maintenance of water rights was often large because of the interminable suits brought during the times of water scarcity. The laws regarding water in most of the arid states were indefinite or contradictory, being based partly on the common law regarding riparian rights, and partly upon the Spanish law allowing diversion of water from natural streams. Few fundamental principles were established, except in the case of the state of Wyoming, where an official was charged with the duty of ascertaining the amount of water in the streams and apportioning this to the claimants in the order of their priority of appropriation for beneficial use.

It may be said that, up to the year 1900, irrigation progressed to such an extent that there remained few ordinary localities where water could not be easily or cheaply diverted from creeks and rivers for the cultivation of farms. The claims for the available supply from small streams, however, exceeded the water to be had in the latter part of the irrigating season. There remained large rivers and opportunities for water storage which could be brought under irrigation at considerable expense. The large canals and reservoirs built by corporations had rarely been successful from a financial standpoint, and irrigation construction during the latter part of the decade 1890-1899 was relatively small. Owing to the difficulty and expense of securing water from running streams by gravity systems, a great variety of methods were developed of pumping water by windmills, gasoline or hot-air engines, and steam. Ordinary reciprocating pumps were commonly employed, and also air lifts and similar devices for raising great quantities of water to a height of from 20 to 50 ft. For greater depths the cost was usually prohibitive. Throughout the Great Plains region, east of the Rocky Mountains, and in the broad valleys to the west, windmills were extensively used, each pumping water for from 1 to 5 acres of cultivated ground. In a few localities, notably in South Dakota, the Yakima valley of Washington, San Joaquin, and San Bernardino valleys of California, San Luis valley of Colorado, and Utah valley of Utah, water from artesian wells was also used for the irrigation of from 1 to 160 acres. The total acreage supplied by such means was probably less than 1% of that watered by gravity systems.

The development of irrigation was in part retarded by the improper or wasteful use of water. On permeable soils, especially those of the terrace lands along the valleys, the soluble salts commonly known as alkali were gradually leached out and carried by the percolating waters towards the lower lands, where, reaching the surface, the alkali was left as a glistening crust or as pools of inky blackness. Farms adjacent to the rivers were for a time increased in richness by the alkaline salts, which in diffuse form might be valuable plant foods, and then suddenly become valueless when the concentration of alkali had reached a degree beyond that which the ordinary plants would endure.

The situation as regards the further progress of irrigation on a large scale was however dominated in the early years of the 20th century by the new Conservation policy. Mr Roosevelt brought the whole subject before Congress in his message of the 3rd of December 1901, and thereby started what seemed likely to be a new sphere of Federal initiative and control. After referring to the effects of forests (see FORESTS and FORESTRY) on water-supply, he went on as follows:—

"The forests alone cannot fully regulate and conserve the waters of the arid regions. Great storage works are necessary to equalize the flow of the streams and to save the flood waters. Their construction has been conclusively shown to be an undertaking too vast for private effort. Nor can it be best accomplished by the individual states acting alone.

"Far-reaching interstate problems are involved, and the resources of single states would often be inadequate. It is properly a national function, at least in some of its features. It is as right for the National Government to make the streams and rivers of the arid regions useful by engineering works for water storage, as to make useful the rivers and harbours of the humid regions by engineering works of another kind. The storing of the floods in reservoirs at the headquarters of our rivers is but an enlargement of our present policy

of river control, under which levees are built on the lower reaches of the same streams.

"The government should construct and maintain these reservoirs as it does other public works. Where their purpose is to regulate the flow of streams, the water should be turned freely into the channels in the dry season, to take the same course under the same laws as the natural flow.

"The reclamation of the unsettled arid public lands presents a different problem. Here it is not enough to regulate the flow of streams. The object of the government is to dispose of the land to settlers who will build homes upon it. To accomplish the object water must be brought within their reach.

"The construction and settlement of the arid lands will enrich every portion of our country, just as the settlement of the Ohio and Mississippi valleys brought prosperity to the Atlantic States. The increased demand for manufactured articles will stimulate industrial production, while wider home markets and the trade of Asia will consume the larger food supplies and effectually prevent Western competition with Eastern agriculture. Indeed, the products of irrigation will be consumed chiefly in upbuilding local centres of mining and other industries, which would otherwise not come into existence at all. Our people as a whole will profit, for successful home-making is but another name for the upbuilding of the nation."

In 1902, by Act of Congress, a "reclamation fund" was created from moneys received from the sale of public lands; it was to be used under a "Reclamation Service" (part of the Department of the Interior) for the reclamation of arid lands. The "Truckee-Carson project" for irrigation in Nevada was immediately begun. About thirty other government projects were taken in hand under the new Reclamation Service, in some cases involving highly interesting engineering problems, as in the Uncompahgre Project in Colorado. Here the Uncompahgre and Gunnison rivers flowed parallel, about 10 m. apart, with a mountain range 2000 ft. high between them. The Uncompahgre, with only a small amount of water, flowed through a broad and fertile valley containing several hundred thousand acres of cultivable soil. The Gunnison, with far more water, flowed through a canyon with very little land. The problem was to get the water from the Gunnison over the mountain range into the Uncompahgre valley; and a tunnel, 6 m. long, was cut through, resulting in 1909 in 148,000 acres of land being irrigated and thrown open to settlers. Similarly, near Yuma in Arizona, a project was undertaken for carrying the waters of the main canal on the California side under the Colorado river by a siphon. In the report for 1907 of the Reclamation Service it was stated that it had dug 1881 m. of canals, some carrying whole rivers, like the Truckee river in Nevada and the North Platte in Wyoming, and had erected 281 large structures, including the great dams in Nevada and the Minidoka dam (80 ft. high and 650 ft. long) in Idaho. As the result of the operations eight new towns had been established. 100 m. of branch railroads constructed, and 14,000 people settled in what had been the desert.

A White House conference of governors of states was held at Washington in May 1909, when was drawn up a "declaration of principles" for the conservation of natural resources, recommending the appointment of a commission by each state to co-operate with one another and with the Federal government; and by the end of the year thirty-six states had appointed Conservation committees. Thus, in the first decade of the 20th century a great advance had been made in the way in which the whole problem was being viewed in America, though the very immensity of the problem of bringing the Federal power to bear on operations on so vast a scale, involving the limitation of private land speculation in important areas, still presented political difficulties of considerable magnitude.

**IRULAS** ("Benighted ones," from Tamil, *iral*, "darkness"), a semi-Hinduized forest-tribe of southern India, who are found mainly in North Arcot, Chingleput, South Arcot, Trichinopoly, and the Malabar Wynaad. The typical Irulas of the Nilgiris live a wild life on the lower slopes of those hills. At the 1901 census this branch of the Irulas numbered 1015, while the total of so-called Irulas was returned at 86,087.

See J. W. Brecks, *Primitive Tribes of the Nilgiris* (1873); *Nilgiri Manual*, i. 214-217; *North Arcot Manual*, i. 248-249.

**IRUN**, a frontier town of northern Spain, in the province of Guipúzcoa, on the left bank of the river Bidassoa, opposite the French village of Hendaye. Pop. (1900) 9012. Irun is the northern terminus of the Spanish Northern railway, and a

thuring industrial town, with ironworks, tan-yards, potteries and paper mills. Its principal buildings are the fine Renaissance parish church and the fortress-like 17th-century town hall. It derives its prosperity from the fact that it is the most important custom-house in Spain for the overland trade with the rest of Europe. Irún is also on the chief highway for travellers and mails. It is the terminus of some important narrow-gauge mining railways and steam tramways, which place it in communication with the mining districts of Guipúzcoa and Navarre, and with the valuable oak, pine and beech forests of both provinces. There are hot mineral springs in the town.

**IRVINE**, a royal, municipal and police burgh, and seaport of Ayrshire, Scotland. Pop. (1901) 9607. It is situated on the north bank of the estuary of the Irvine, 29½ m. S.W. of Glasgow by the Caledonian railway, with a station also on the Glasgow & South Western railway. It is connected with the suburb of Fullarton on the south side of the river by a stone bridge, which was built in 1746 and widened in 1827. Alexander II. granted it a charter, which was confirmed by Robert Bruce. Towards the end of the 17th century it was reckoned the third shipping port in Scotland (Port Glasgow and Leith being the leaders), and though its importance in this respect declined owing to the partial silting-up of the harbour, its water-borne trade revived after 1875, the sandy bar having been removed and the wharfe extended and improved. The public buildings include the town hall, academy (1814) and fever hospital. The principal historical remains are the square tower of Stanecastle and the ancient Seagate Castle, which contains some good specimens of Norman architecture. The industries include engine-making, shipbuilding, iron- and brass-founding, the manufacture of chemicals, brewing and soap-making. Irvine unites with Ayr, Campbeltown, Inveraray and Oban in sending one member to parliament. The exports consist principally of coal, iron and chemical products, and the imports of grain, timber, limestone, ores and general produce. At DREGHORN, 2 m. to the S.E. (pop. 1155) coal and iron are worked.

**IRVING, EDWARD** (1792-1834), Scottish church divine, generally regarded as the founder of the "Catholic Apostolic Church" (q.v.), was born at Annan, Dumfriesshire, on the 4th of August 1792. By his father's side, who followed the occupation of a tanner, he was descended from a family long known in the district, and the purity of whose Scottish lineage had been tinged by alliance with French Protestant refugees; but it was from his mother's race, the Lowthers, farmers or small proprietors in Annandale, that he seems to have derived the most distinctive features of his personality. The first stage of his education was passed at a school kept by "Peggy Paine," a relation of the well-known author of the *Age of Reason*, after which he entered the Annan academy, taught by Mr Adam Hope, of whom there is a graphic sketch in the *Reminiscences* of Thomas Carlyle. At the age of thirteen he entered the university of Edinburgh. In 1809 he graduated M.A.; and in 1810, on the recommendation of Sir John Leslie, he was chosen master of an academy newly established at Haddington, where he became the tutor of Jane Welsh, afterwards famous as Mrs Carlyle. He became engaged in 1812 to Isabella Martin, whom in 1823 he married; but it may be at once stated here that meanwhile he gradually fell in love with Jane Welsh, and she with him. He tried to get out of his engagement with Miss Martin, but was prevented by her family. If he had married Miss Welsh, his life, as well as hers, would have been very different. It was Irving who in 1821 introduced Carlyle to her.

His appointment at Haddington he exchanged for a similar one at Kirkcaldy in 1812. Completing his divinity studies by a series of partial sessions, he was "licensed" to preach in June 1815, but continued to discharge his scholastic duties for three years. He devoted his leisure, not only to mathematical and physical science, but to a course of reading in English literature, his bias towards the antique in sentiment and style being strengthened by a perusal of the older classics, among whom Richard Hooker was his favourite author. At the same time his love of the marvellous found gratification in the wonders

of the *Arabian Nights*, and it is further characteristically related of him that he used to carry continually in his waistcoat pocket a miniature copy of *Ossian*, passages from which he frequently recited with "sonorous elocution and vehement gesticulation."

In the summer of 1818 he resigned his mastership, and, in order to increase the probability of obtaining a permanent appointment in the church, took up his residence in Edinburgh. Although his exceptional method of address seems to have gained him the qualified approval of certain dignitaries of the church, the prospect of his obtaining a settled charge seemed as remote as ever, and he was meditating a missionary tour in Persia when his departure was arrested by steps taken by Dr Chalmers, which, after considerable delay, resulted, in October 1819, in Irving being appointed his assistant and missionary in St John's parish, Glasgow. Except in the case of a select few, Irving's preaching awakened little interest among the congregation of Chalmers, Chalmers himself, with no partiality for its bravuras and flourishes, comparing it to "Italian music, appreciated only by connoisseurs"; but as a missionary among the poorer classes he wielded an influence that was altogether unique. The benediction "Peace be to this house," with which, in accordance with apostolic usage, he greeted every dwelling he entered, was not inappropriate to his figure and aspect, and it is said "took the people's attention wonderfully," the more especially after the magic of his personality found opportunity to reveal itself in close and homely intercourse. This half-success in a subordinate sphere was, however, so far from coinciding with his aspirations that he had again, in the winter of 1821, begun to turn his attention towards missionary labour in the East, when the possibility of fulfilling the dream of his life was suddenly revealed to him by an invitation from the Caledonian church, Hatton Garden, London, to "make trial and proof" of his gifts before the "remnant of the congregation which held together." Over that charge he was ordained in July 1822. Some years previously he had expressed his conviction that "one of the chief needs of the age was to make inroad after the alien, to bring in the votaries of fashion, of literature, of sentiment, of policy and of rank, who are content in their several idolatries to do without piety to God and love to Him whom He hath sent"; and, with an abruptness which must have produced on him at first an effect almost astounding, he now had the satisfaction of beholding these various votaries thronging to hear from his lips the words of wisdom which would deliver them from their several idolatries and remodel their lives according to the fashion of apostolic times.

This sudden leap into popularity seems to have been occasioned in connexion with a veiled allusion to Irving's striking eloquence made in the House of Commons by Canning, who had been induced to attend his church from admiration of an expression in one of his prayers, quoted to him by Sir James Mackintosh. His commanding stature, the symmetry of his form, the dark and melancholy beauty of his countenance, rather rendered piquant than impaired by an obliquity of vision, produced an imposing impression even before his deep and powerful voice had given utterance to its melodious thunders; and harsh and superficial half-truths enunciated with surpassing ease and grace of gesture, and not only with an air of absolute conviction but with the authority of a prophetic messenger, in tones whose magical fascination was inspired by an earnestness beyond all imitation of art, acquired a plausibility and importance which, at least while the orator spoke, made his audience entirely forgetful of their preconceived objections against them. The subject-matter of his orations, and his peculiar treatment of his themes, no doubt also, at least at first, constituted a considerable part of his attractive influence. He had specially prepared himself, as he thought, for "teaching imaginative men, and political men, and legal men, and scientific men who bear the world in hand"; and he did not attempt to win their attention to abstract and worn-out theological arguments, but discussed the opinions, the poetry, the politics, the manners and customs of the time, and this not with philosophical comprehensiveness, not in terms of warm eulogy or measured blame,



but of severe satire varied by fierce denunciation, and with a specific minuteness which was concerned primarily with individuals. A fire of criticism from pamphlets, newspapers and reviews opened on his volume of *Orations*, published in 1823; but the excitement produced was merely superficial and essentially evanescent. Though cherishing a strong antipathy to the received ecclesiastical formulas, Irving's great aim was to revive the antique style of thought and sentiment which had hardened into these formulas, and by this means to supplant the new influences, the accidental and temporary moral shortcomings of which he detected with instinctive certainty, but whose profound and real tendencies were utterly beyond the reach of his conjecture. Being thus radically at variance with the main current of the thought of his time, the failure of the commission he had undertaken was sooner or later inevitable; and shortly after the opening of his new church in Regent Square in 1827, he found that "fashion had taken its departure," and the church, "though always well filled," was "no longer crowded." By this desertion his self-esteem, one of his strongest passions, though curiously united with singular sincerity and humility, was doubtless hurt to the quick; but the wound inflicted was of a deeper and deadlier kind, for it confirmed him finally in his despair of the world's gradual amelioration, and established his tendency towards supernaturalism.

For years the subject of prophecy had occupied much of his thoughts, and his belief in the near approach of the second advent had received such wonderful corroboration by the perusal of the work of a Jesuit priest, writing under the assumed Jewish name of Juan Josafat Ben-Ezra, that in 1827 he published a translation of it, accompanied with an eloquent preface. Probably the religious opinions of Irving, originally in some respects more catholic and truer to human nature than generally prevailed in ecclesiastical circles, had gained breadth and comprehensiveness from his intercourse with Coleridge, but gradually his chief interest in Coleridge's philosophy centred round that which was mystical and obscure, and to it in all likelihood may be traced his initiation into the doctrine of millenarianism. The first stage of his later development, which resulted in the establishment of the "Irvingite" or "Holy Catholic Apostolic Church," in 1832, was associated with conferences at his friend Henry Drummond's seat at Albury concerning unfulfilled prophecy, followed by an almost exclusive study of the prophetic books and especially of the Apocalypse, and by several series of sermons on prophecy both in London and the provinces, his apocalyptic lectures in 1828 more than crowding the largest churches of Edinburgh in the early summer mornings. In 1830, however, there was opened up to his ardent imagination a new vista into spiritual things, a new hope for the age in which he lived, by the seeming actual revival in a remote corner of Scotland of those apostolic gifts of prophecy and healing which he had already in 1828 persuaded himself had only been kept in abeyance by the absence of faith. At once he welcomed the new "power" with an unquestioning evidence which could be shaken by neither the remonstrances or desertion of his dearest friends, the recantation of some of the principal agents of the "gifts," his own declension into a comparatively subordinate position, the meagre and barren results of the manifestations, nor their general rejection both by the church and the world. His excommunication by the presbytery of London, in 1830, for publishing his doctrines regarding the humanity of Jesus Christ, and the condemnation of these opinions by the General Assembly of the Church of Scotland in the following year, were secondary episodes which only affected the main issue of his career in so far as they tended still further to isolate him from the sympathy of the church; but the "irregularities" connected with the manifestation of the "gifts" gradually estranged the majority of his own congregation, and on the complaint of the trustees to the presbytery of London, whose authority they had formerly rejected, he was declared unfit to remain the minister of the National Scotch Church of Regent Square. After he and those who adhered to him (describing themselves as of the Holy Catholic Apostolic

Church) had in 1832 removed to a new building in Newman Street, he was in March 1833 deposed from the ministry of the Church of Scotland by the presbytery of Annan on the original charge of heresy. With the sanction of the "power" he was now after some delay reordained "chief pastor of the church assembled in Newman Street," but unremitting labours and ceaseless spiritual excitement soon completely exhausted the springs of his vital energy. He died, worn out and wasted with labour and absorbing care, while still in the prime of life, on the 7th of December 1834.

The writings of Edward Irving published during his lifetime were *For the Oracles of God*, *Four Orations* (1823); *For Judgment to come* (1823); *Babylon and Its Iniquity foredoomed* (1828); *Sermons*, &c. (3 vols., 1828); *Exposition of the Book of Revelation* (1831); an introduction to a translation of Ben-Ezra; and an introduction to Horne's *Commentary on the Psalms*. His collected works were published in 5 volumes, edited by Gavin Carlyle. See also the article CATHOLIC APOSTOLIC CHURCH.

*The Life of Edward Irving*, by Mrs Oliphant, appeared in 1862 in 2 vols. Among a large number of biographies published previously, that by Washington Wills (1854) has some merit. See also Hazlitt's *Spirit of the Age*; Coleridge's *Notes on English Divines*; Carlyle's *Miscellanies*, and Carlyle's *Reminiscences*, vol. I. (1881).

**IRVING, SIR HENRY** (1838-1905), English actor, whose original name was John Brodribb, was born at Keinton-Mandeville, Somerset, on the 6th of February 1838. After a few years' schooling he became a clerk to a firm of East India merchants in London, but he soon gave up a commercial career and started as an actor. On the 29th of September 1856 he made his first appearance at Sunderland as Gaston, duke of Orleans, in Bulwer Lytton's *Richelieu*, billed as Henry Irving. This name he eventually assumed by royal licence. For ten years he went through an arduous training in various provincial stock companies, acting in more than five hundred parts. By degrees his ability gained recognition, and in 1866 he obtained an engagement at the St James's Theatre, London, to play Doricourt in *The Belle's Stratagem*. A year later he joined the company of the newly-opened Queen's Theatre, where he acted with Charles Wyndham, J. L. Toole, Lionel Brough, John Clayton, Mr and Mrs Alfred Wigan, Ellen Terry and Nelly Farren. This was followed by short engagements at the Haymarket, Drury Lane and Gaiety. At last he made his first conspicuous success as Dighy Grant in James Albery's *The Two Roses*, which was produced at the Vaudeville on the 4th of June 1870 and ran for 300 nights. In 1871 he began his association with the Lyceum Theatre by an engagement under Bateman's management. The fortunes of the house were at a low ebb when the tide was turned by Irving's immediate success as Mathias in *The Bells*, a version of Erckmann-Chatrian's *Le Juif Polonais* by Leopold Lewis. The play ran for 150 nights. With Miss Bateman, Irving was seen in W. G. Wills's *Charles I.* and *Eugene Aram*, in *Richelieu*, and in 1874 in *Hamlet*. The unconventionality of this last performance, during a run of 200 nights, aroused keen discussion, and singled him out as the most interesting English actor of his day. In 1875, still with Miss Bateman, he was seen as Macbeth; in 1876 as Othello, and as Philip in Tennyson's *Queen Mary*; in 1877 in *Richard III.* and *The Lyons Mail*.

In 1878 Irving opened the Lyceum under his own management. With Ellen Terry as Ophelia and Portia, he revived *Hamlet* and produced *The Merchant of Venice* (1879). His Shylock was as much discussed as his Hamlet had been, the dignity with which he invested the Jew marking a departure from the traditional interpretation of the rôle, and pleasing some as much as it offended others. After the production of Tennyson's *The Cup*, a revival of *Othello* (in which Irving playing Iago to the Othello of Edwin Booth) and of *Romeo and Juliet*, there began a period at the Lyceum which had a potent effect on the English stage. The Lyceum stage management, and the brilliancy of its productions in scenery, dressing and accessories, were revelations in the art of *mise-en-scène*. *Much Ado about Nothing* (1882) was followed by *Twelfth Night* (1884), *Olivia*—an adaptation of Goldsmith's *Vicar of Wakefield* by W. G. Wills (1885); *Faust* (1886); *Macbeth* (1888); *The Dead Heart*, by Watts Phillips

(1889); and *Ravenwood*—Herman Merivale's dramatic version of Scott's *Bride of Lammermoor* (1890). Fine assumptions in 1892 of the characters of Wolsey in *Henry VIII.* and of King Lear were followed in 1893 by a striking and dignified performance of Becket in Tennyson's play of that name. During these years too, Irving, with the whole Lyceum company, paid several visits to America, which met with conspicuous success, and were repeated in succeeding years. The chief remaining novelties at the Lyceum during Irving's sole management (the theatre passed, at the beginning of 1890, into the hands of a limited liability company) were Comyns Carr's *King Arthur* in 1895; *Cymbeline*, in which Irving played Iachimo, in 1896; Sardou's *Madame Sans-Gêne* in 1897; *Peter the Great*, a play by Laurence Irving, the actor's second son, in 1898; and Conan Doyle's *Waterloo* (1894). The new régime at the Lyceum was signalized by the production of Sardou's *Robespierre* in 1899, in which Irving reappeared after a serious illness, and in 1901 by an elaborate revival of *Coriolanus*. Irving's only subsequent production in London was Sardou's *Dante* (1903), a vast spectacular drama, staged at Drury Lane. He died "on tour" at Bradford on the 13th of October 1905, and was buried in Westminster Abbey.

Both on and off the stage Irving always maintained a high ideal of his profession, and in 1895 he received the honour of knighthood, the first ever accorded an actor. He was also the recipient of honorary degrees from the universities of Dublin, Cambridge and Glasgow. His acting, apart from his genius as a presenter of plays, divided criticism, opinions differing as to the extent to which his mannerisms of voice and deportment interfered with or assisted the expression of his ideas. So strongly marked a personality as his could not help giving its own colouring to whatever part he might assume, but the richness and originality of this colouring at its best cannot be denied, any more than the spirit and intellect which characterized his renderings. At the least, extraordinary versatility must be conceded to an actor who could satisfy exacting audiences in rôles so widely different as Digby Grant and Louis XI., Richard III. and Becket. Benedict and Shylock, Mathias and Dr Primrose.

Sir Henry Irving had two sons, Harry Brodribb (b. 1870) and Laurence (b. 1872). They were educated for other walks of life, the former for the bar, and the latter for the diplomatic service; but both turned to the stage, and the elder, who had already established himself as the most prominent of the younger English actors at the time of his father's death, went into management on his own account.

**IRVING, WASHINGTON** (1783-1859), American man of letters, was born at New York on the 3rd of April 1783. Both his parents were immigrants from Great Britain, his father, originally an officer in the merchant service, but at the time of Irving's birth a considerable merchant, having come from the Orkneys, and his mother from Falmouth. Irving was intended for the legal profession, but his studies were interrupted by an illness necessitating a voyage to Europe, in the course of which he proceeded as far as Rome, and made the acquaintance of Washington Allston. He was called to the bar upon his return, but made little effort to practise, preferring to amuse himself with literary ventures. The first of these of any importance, a satirical miscellany entitled *Salmagundi, or the Whim-Whams and Opinions of Launcelot Langstaff and others*, written in conjunction with his brother William and J. K. Paulding, gave ample proof of his talents as a humorist. These were still more conspicuously displayed in his next attempt, *A History of New York from the Beginning of the World to the End of the Dutch Dynasty*, by "Diedrich Knickerbocker" (2 vols., New York, 1809). The satire of *Salmagundi* had been principally local, and the original design of "Knickerbocker's" *History* was only to burlesque a pretentious disquisition on the history of the city in a guide-book by Dr Samuel Mitchell. The idea expanded as Irving proceeded, and he ended by not merely satirizing the pedantry of local antiquaries, but by creating a distinct literary type out of the solid Dutch burgher whose phlegm had long been an object of ridicule to the mercurial Americans. Though far from the most finished of Irving's productions, "Knickerbocker"

manifests the most original power, and is the most genuinely national in its quaintness and drollery. The very tardiness and prolixity of the story are skillfully made to heighten the humorous effect.

Upon the death of his father, Irving had become a sleeping partner in his brother's commercial house, a branch of which was established at Liverpool. This, combined with the restoration of peace, induced him to visit England in 1815, when he found the stability of the firm seriously compromised. After some years of ineffectual struggle it became bankrupt. This misfortune compelled Irving to resume his pen as a means of subsistence. His reputation had preceded him to England, and the curiosity naturally excited by the then unwonted apparition of a successful American author procured him admission into the highest literary circles, where his popularity was ensured by his amiable temper and polished manners. As an American, moreover, he stood aloof from the political and literary disputes which then divided England. Campbell, Jeffrey, Moore, Scott, were counted among his friends, and the last-named zealously recommended him to the publisher Murray, who, after at first refusing, consented (1820) to bring out *The Sketch Book of Geoffrey Crayon, Gent.* (7 pts., New York, 1819-1820). The most interesting part of this work is the description of an English Christmas, which displays a delicate humour not unworthy of the writer's evident model Addison. Some stories and sketches on American themes contribute to give it variety; of these Rip van Winkle is the most remarkable. It speedily obtained the greatest success on both sides of the Atlantic. *Bracebridge Hall, or the Humourists* (2 vols., New York), a work purely English in subject, followed in 1822, and showed to what account the American observer had turned his experience of English country life. The humour is, nevertheless, much more English than American. *Tales of a Traveller* (4 pts.) appeared in 1824 at Philadelphia, and Irving, now in comfortable circumstances, determined to enlarge his sphere of observation by a journey on the continent. After a long course of travel he settled down at Madrid in the house of the American consul Rich. His intention at the time was to translate the *Coleccion de los Viajes y Descubrimientos* (Madrid, 1825-1837) of Martin Fernandez de Navarrete; finding, however, that this was rather a collection of valuable materials than a systematic biography, he determined to compose a biography of his own by its assistance, supplemented by independent researches in the Spanish archives. His *History of the Life and Voyages of Christopher Columbus* (London, 4 vols.) appeared in 1828, and obtained a merited success. *The Voyages and Discoveries of the Companions of Columbus* (Philadelphia, 1831) followed; and a prolonged residence in the south of Spain gave Irving materials for two highly picturesque books. *A Chronicle of the Conquest of Granada from the MSS.* of [an imaginary] Fray Antonio Agapida (2 vols., Philadelphia, 1829), and *The Alhambra: a series of tales and sketches of the Moors and Spaniards* (2 vols., Philadelphia, 1832). Previous to their appearance he had been appointed secretary to the embassy at London, an office as purely complimentary to his literary ability as the legal degree which he about the same time received from the university of Oxford.

Returning to the United States in 1832, after seventeen years' absence, he found his name a household word, and himself universally honoured as the first American who had won for his country recognition on equal terms in the literary republic. After the rush of fêtes and public compliments had subsided, he undertook a tour in the western prairies, and returning to the neighbourhood of New York built for himself a delightful retreat on the Hudson, to which he gave the name of "Sunshine." His acquaintance with the New York millionaire John Jacob Astor prompted his next important work—*Astoria* (2 vols., Philadelphia, 1836), a history of the fur-trading settlement founded by Astor in Oregon, deduced with singular literary ability from dry commercial records, and, without laboured attempts at word-painting, evincing a remarkable faculty for bringing scenes and incidents vividly before the eye. *The*

*Adventures of Captain Bonneville* (London and Philadelphia, 1837), based upon the unpublished memoirs of a veteran explorer, was another work of the same class. In 1842 Irving was appointed ambassador to Spain. He spent four years in the country, without this time turning his residence to literary account; and it was not until two years after his return that Forster's life of Goldsmith, by reminding him of a slight essay of his own which he now thought too imperfect by comparison to be included among his collected writings, stimulated him to the production of his *Life of Oliver Goldsmith, with Selections from his Writings* (2 vols., New York, 1849). Without pretensions to original research, the book displays an admirable talent for employing existing material to the best effect. The same may be said of *The Lives of Mahomet and his Successors* (New York, 2 vols., 1849-1850). Here as elsewhere Irving correctly discriminated the biographer's province from the historian's, and leaving the philosophical investigation of cause and effect to writers of Gibbon's calibre, applied himself to represent the picturesque features of the age as embodied in the actions and utterances of its most characteristic representatives. His last days were devoted to his *Life of George Washington* (5 vols., 1855-1850, New York and London), undertaken in an enthusiastic spirit, but which the author found exhausting and his readers tame. His genius required a more poetical theme, and indeed the biographer of Washington must be at least a potential soldier and statesman. Irving just lived to complete this work, dying of heart disease at Sunnyside, on the 28th of November 1859.

Although one of the chief ornaments of American literature, Irving is not characteristically American. But he is one of the few authors of his period who really manifest traces of a vein of national peculiarity which might under other circumstances have been productive. "Knickerbocker's" *History of New York*, although the air of mock solemnity which constitutes the staple of its humour is peculiar to no literature, manifests nevertheless a power of reproducing a distinct national type. Had circumstances taken Irving to the West, and placed him amid a society teeming with quaint and genial eccentricity, he might possibly have been the first Western humorist, and his humour might have gained in depth and richness. In England, on the other hand, everything encouraged his natural fastidiousness; he became a refined writer, but by no means a robust one. His biographies bear the stamp of genuine artistic intelligence, equally remote from compilation and disquisition. In execution they are almost faultless; the narrative is easy, the style pellucid, and the writer's judgment nearly always in accordance with the general verdict of history. Without ostentation or affectation, he was exquisite in all things, a mirror of loyalty, courtesy and good taste in all his literary connexions, and exemplary in all the relations of domestic life. He never married, remaining true to the memory of an early attachment blighted by death.

The principal edition of Irving's works is the "Geoffrey Crayon," published at New York in 1880 in 26 vols. His *Life and Letters* was published by his nephew Pierre M. Irving (London, 1862-1864, 4 vols.; German abridgment by Adolf Laun, Berlin, 1870, 2 vols.). There is a good deal of miscellaneous information in a compilation entitled *Irvingiana* (New York, 1860) and W. C. Bryant's memorial oration, though somewhat too uniformly laudatory, may be consulted with advantage. It was republished in *Studies of Irving* (1869) along with C. Dudley Warner's introduction to the "Geoffrey Crayon" edition, and Mr G. P. Putnam's personal reminiscences of Irving, which originally appeared in the *Atlantic Monthly*. See also *Washington Irving* (1881), by C. D. Warner, in the "American Men of Letters" series; H. R. Haweis, *American Humorists* (London, 1883). (R. G.)

**IRVINGTON**, a town of Essex county, New Jersey, U.S.A., bordering on the S.W. side of Newark. Pop. (1900) 5255, of whom 993 were foreign-born; (1905) 7180; (1910) 11,877. Irvington is served by the Lehigh Valley railroad and by electric railway to Newark. It is principally a residential suburb of Newark, but it has a small smelter (for gold and silver), and various manufactures, including textile working machinery, measuring rules and artisans' tools. There are large strawberry

farms here. Irvington was settled near the close of the 17th century, and was called Camptown until 1852, when the present name was adopted in honour of Washington Irving. It was incorporated as a village in 1874, and as a town in 1898.

**ISAAC** (Hebrew for "he laughs," on explanatory references to the name, see ABRAHAM), the only child of Abraham and Sarah, was born when his parents were respectively a hundred and ninety years of age (Gen. xvii. 17). Like his father, Isaac lived a nomadic pastoral life, but within much narrower local limits, south of Beersheba (Gen. xxvi., on the incidents here recorded, see ABIMELECH). After the death of his mother, when he was forty years old, he married Rebekah the Aramaean, by whom after twenty years of married life he became the father of Esau and Jacob. He died at the age of one hundred and eighty.<sup>1</sup> "Isaac" is used as a synonym for "Israel" by Amos (vii. 9, 16), who also bears witness to the importance of Beersheba as a sanctuary. It was in this district, at the well Beer-Lahai-roi, that Isaac dwelt (Gen. xxiv. 62, xxv. 11), and the place was famous for an incident in the life of Hagar (xvi. 14). This was perhaps the original scene of the striking episode "in the land of Moriah," when at the last moment he was by angelic interposition released from the altar on which he was about to be sacrificed by his father in obedience to a divine command (Gen. xxii).<sup>2</sup> The narrative (which must be judged with due regard to the conditions of the age) shows that the sacrifice of the first-born, though not inconsistent with Yahweh's claims (Ex. xxii. 29), was neither required nor tolerated (cp. Micah vi. 6-8). See MOLOCH.

Isaac is by general consent of the Christian church taken as a representative of the unobtrusive, restless, piously contemplative type of human character. By later Judaism, which fixed its attention chiefly on the altar scene, he was regarded as the pattern and prototype of all martyrs. The Mohammedan legends pertaining him are curious, but trifling.

The resemblance between incidents in the lives of Isaac and Abraham is noteworthy; in each case Isaac appears to be the more original. See further ISHMAEL, and note that the pair Isaac and Ishmael correspond to Abraham and Lot, Jacob and Esau. On general questions, see E. Meyer, *Israelitische Geschichte*, s.v. For attempts to find a mythological interpretation of Isaac's life, see Goldzher, *Mythology of the Hebrews*; Winckler, *Gesch. Israels* (vol. ii.).

**ISAAC I.** (COMNENUS), emperor of the East (1057-1059), was the son of an officer of Basil II. named Manuel Comnenus, who on his deathbed commended his two sons Isaac and John to the emperor's care. Basil had them carefully educated at the monastery of Studion, and afterwards advanced them to high official positions. During the disturbed reigns of Basil's seven immediate successors, Isaac by his prudent conduct won the confidence of the army; in 1057 he joined with the nobles of the capital in a conspiracy against Michael VI., and after the latter's deposition was invested with the crown, thus founding the new dynasty of the Comneni. The first care of the new emperor was to reward his noble partisans with appointments that removed them from Constantinople, and his next was to repair the beggared finances of the empire. He revoked numerous pensions and grants conferred by his predecessors upon idle courtiers, and, meeting the reproach of sacrilege made by the patriarch of Constantinople by a decree of exile, resumed a proportion of the revenues of the wealthy monasteries. Isaac's only military expedition was against the Hungarians and Petchenegs, who began to ravage the northern frontiers in 1059. Shortly after this successful campaign he was seized with an illness, and believing it mortal appointed as his successor Constantine Ducas, to the exclusion of his own brother John. Although he recovered Isaac did not resume the purple, but retired to the monastery of Studion and spent the remaining two years of his life as a monk, alternating menial offices with literary studies. His *Scholion*

<sup>1</sup> The stories, including the delightful history of the courting of Rebekah by proxy, are due to the oldest narrators. The jarring chronological notices belong to the post-exilic framework of the book (see GENESIS).

<sup>2</sup> The name is hopelessly obscure, and the identification with the mountain of the temple in Jerusalem rests upon a late view (2 Chron. iii. 1). It is otherwise called "Yahweh-yir'eh" ("Y. sees") which is analogous to "El-roi" ("a God of Seeing") in xvi. 13. See further the commentaries.

the *Iliad* and other works on the Homeric poems are still extant in MS. He died in the year 1061. Isaac's great aim was to restore the former strict organization of the government, and his reforms, though unpopular with the aristocracy and the clergy, and not understood by the people, certainly contributed to stave off for a while the final ruin of the Byzantine empire.

See E. Gibbon, *The Decline and Fall of the Roman Empire* (ed. J. Bury, London, 1896, vol. v.); G. Finlay, *History of Greece* (ed. 1877, Oxford, vols. ii. and iii.).

**ISAAC II. (ANGELUS)**, emperor of the East 1185-1195, and again 1203-1204, was the successor of Andronicus I. He inaugurated his reign by a decisive victory over the Normans in Sicily, but elsewhere his policy was less successful. He failed in an attempt to recover Cyprus from a rebellious noble, and by the oppressiveness of his taxes drove the Bulgarians and Vlachs to revolt (1186). In 1187 Alexis Branas, the general sent against the rebels, treacherously turned his arms against his master, and attempted to seize Constantinople, but was defeated and slain. The emperor's attention was next demanded in the east, where several claimants to the throne successively rose and fell. In 1189 Frederick Barbarossa of Germany sought and obtained leave to lead his troops on the third crusade through the Byzantine territory; but he had no sooner crossed the border than Isaac, who had meanwhile sought an alliance with Saladin, threw every impediment in his way, and was only compelled by force of arms to fulfil his engagements. The next five years were disturbed by fresh rebellions of the Vlachs, against whom Isaac led several expeditions in person. During one of these, in 1195, Alexis, the emperor's brother, taking advantage of the latter's absence from camp on a hunting expedition, proclaimed himself emperor, and was readily recognised by the soldiers. Isaac was blinded and imprisoned in Constantinople. After eight years he was raised for six months from his dungeon to his throne once more (see *CRUSADES*). But both mind and body had been enfeebled by captivity, and his son Alexis IV. was the actual monarch. Isaac died in 1204, shortly after the usurpation of his general, Mourzouphes. He was one of the weakest and most vicious princes that occupied the Byzantine throne. Surrounded by a crowd of slaves, mistresses and flatterers, he permitted his empire to be administered by unworthy favourites, while he squandered the money wrung from his provinces on costly buildings and expensive gifts to the churches of his metropolis.

See Gibbon, *Decline and Fall* (ed. J. Bury, London, 1896, vol. vi.); G. Finlay, *History of Greece* (ed. 1877, Oxford, vols. iii. and iv.).

**ISAAC OF ANTIOCH**, "one of the stars of Syriac literature,"<sup>1</sup> the reputed author of a large number of metrical homilies,<sup>2</sup> many of which are distinguished by an originality and acumen rare among Syriac writers. As to the identity and history of the author considerable difficulty has arisen. The statements of ancient writers, Eastern and Western, were collected by Assemani (*B.O. i. 207-214*). According to these accounts Isaac flourished under Theodosius II. (408-450),<sup>3</sup> and was a native either of Amid (Diarbekr) or of Edessa. Several writers identify him with Isaac, the disciple of S. Ephraim, who is mentioned in the anonymous *Life of that father*; but according to the patriarch Bar Shūshan (d. 1073), who made a collection of his homilies, his master was Ephraim's disciple Zenobius. He is supposed to have migrated to Antioch, and to have become abbot of one of the convents in its neighbourhood. According to Zacharias Rhetor he visited Rome and other cities, and the chronicle of Pseudo-Dionysius of Tell-Mahré informs us that he composed poems on the secular games of 404, and wrote on the destruction of Rome by Alaric in 410. He also commemorated the destruction of Antioch by an earthquake in 459, so that he must have lived till about 460. Unfortunately these poems have perished. He is of course to be

<sup>1</sup> W. Wright, *Short Hist. of Syr. Lit. p. 51*.

<sup>2</sup> The fullest list, by G. Bickell, contains 191 which are extant in MSS.

<sup>3</sup> The trustworthy *Chronicle of Edessa* gives his date as 451-452 (Hallier, No. lxvii.); and the recently published *Chronicle of Michael the Syrian* makes him contemporary with Nonus, who became the 31st bishop of Edessa in 449.

distinguished from Isaac of Nineveh, a Nestorian writer on the ascetic life who belongs to the second half of the 7th century.<sup>4</sup>

When we examine the collection of homilies attributed to Isaac, a difficulty arises on two grounds. (1) The author of some of the poems is fervently orthodox or Catholic (see especially Nos. 1-3 in Bickell's edition—62-64 in Bedjan), in other and more important homilies (such as Bickell 6, 8—Bedjan 59, 61, and especially Bedjan 60) the doctrine is monophysite, even though Eutyches and Nestorius are equally condemned. (2) One of the monophysite homilies, the famous poem of 2136 lines on the parrot which uttered the Trisagion in the streets of Antioch (Bickell, 8=Bedjan 61), appears to have been written at Antioch after Peter the Fuller (patriarch 471-488) raised the dispute about the addition to the doxology of the words *qui crucifixus es pro nobis*. It is therefore scarcely possible that the author of this homily should be the same who composed the lost poems on the secular games in 404 and on the sack of Rome.

Moreover, Lamy (*S. Ephraemi hymni et sermones*, iv. 361-364) and Bedjan (*Homiliae S. Isaaci*, i. pp. ix-ix) have recently called attention to statements made by Jacob of Edessa (708) in a letter to John the Stylite. He says there were three Isaacs who wrote in Syriac—two orthodox (i.e. monophysite), and one a Chalcedonian heretic (i.e. orthodox or Catholic). (a) The first, he says, a native of Amid, and pupil of S. Ephraim, visited Rome in the time of Arcadius (395-408), on his return journey suffered imprisonment at Byzantium, and afterwards became a priest in the church of Amid. (b) The second was a priest of Edessa, and flourished in the reign of Zeno (474-491). He went up to Antioch in the time of Peter the Fuller. Jacob then tells the story of the parrot (see above). (c) The third was also an Edessene. At first in the days of Bishop Paul (510-522) he was orthodox (monophysite); but afterwards in the time of the Chalcedonian (Catholic) bishop Asclepius he became Nestorian (Catholic) and wrote poems setting forth Nestorian doctrine.

With such conflicting evidence it is impossible to arrive at a certain result. But Jacob is an early witness: and on the whole it seems safe to conclude with Bedjan (p. ix) that works by at least two authors have been included in the collection attributed to Isaac of Antioch. Still the majority of the poems are the work of one hand—the student, monophysite who wrote the poem on the parrot. 5. A full list of the 191 poems existing in European MSS. is given by Bickell, who copied out 181 with a view to publishing them all; the other 10 had been previously copied by Zingerle. But the two volumes published by Bickell in his lifetime (Giessen, 1873 and 1877) contain only 37 homilies. Bedjan's edition, of which the first volume has alone appeared (Paris, 1903) contains 67 poems, viz. 24 previously published (18 by Bickell), and 43 that are new, though their titles are all included in Bickell's list.

The writer's main interest lies in the application of religion to the practical duties of life, whether in the church or in the world. He has a great command of forcible language and considerable skill in apt illustration. The zeal with which he denounces the abuses prevalent in the church of his day, and particularly in the monastic orders, is not unlike that of the Protestant reformers. He shows acquaintance with many phases of life. He describes the corruption of judges, the prevalence of usury and avarice, the unchastity which especially characterized the upper classes, and the general hypocrisy of so-called Christians. His doctrinal discussions are apt to be diffuse; but he seldom loses sight of the bearing of doctrine on practical life. He judges with extreme severity those who argue about religion while neglecting its practice, and those who though stupid and ignorant dare to pry into mysteries which are sealed to the angels. "Not newly have we found Him, that we should search and pry into God. As He was He is: He changeth not with the times. . . . Confess that He formed thee of dust: search not the mode of His being: Worship Him that He redeemed thee by His only Son: inquire not the manner of His birth."<sup>5</sup>

Some of Isaac's works have an interest for the historian of the 5th century. In two poems (Bickell 11, 12=Bedjan 48, 49), written probably at Edessa, he commemorates the capture of Bēth-Hūr ʿa

<sup>4</sup> The date of Isaac of Nineveh is now known from the *Liber fundationum* of Ishō'dénah, an 8th-century writer; see Bedjan's edition, and Chabot, *Libre de la chasteté*, p. 63. Assemani (*B.O. i. 445*) had placed him late in the 6th century, and Chabot (*De S. Isaaci Ninivite vita, &c.*) in the second half of the 5th.

<sup>5</sup> Lamy (*op. cit.* iv. 364-366) has pointed out that several of the poems are in certain MSS. attributed to Ephraim. Possibly the author of the orthodox poems was not named Isaac at all.

<sup>6</sup> Assemani's list of 104 poems (*B.O. i. 214-234*) is completely covered by Bickell's.

<sup>7</sup> From a really noble poem (Bedjan 60) on the problem whether God suffered and died on the cross.

city near Nisibis) by the Arabs. Although the historical allusions are far from clear, we gather that Beth-Hür, which in zealous paganism had been a successor to Haran, had been in earlier days devastated by the Persians;<sup>1</sup> but for the last 34 years the Persians had themselves suffered subjection.<sup>2</sup> And now had come a flood of Arab invaders, "sons of Hagar," who had swept away the city and carried all its inhabitants captive. From these two poems, and from the 2d homily on Fasting (Bickell 14 = Bedjan 17) we gain a vivid picture of the miseries borne by the inhabitants of that frontier region during the wars between Persia and the Romano-Greek empire. There are also instructive references to the heathen practices and the worship of pagan deities (such as Baalti, Uzzi, Gedlath and the planet Venus) prevalent in Mesopotamia. Two other poems (Bickell 35 = Bedjan 66, 67), written probably at Antioch,<sup>3</sup> describe the prevalence of sorcery and the extraordinary influence possessed by "Chaldeans" and enchanters over women who were nominally Christians.

The metre of all the published homilies is heptasyllabic. (N. M.)

**ISABELLA** (1451-1504), surnamed *la Católica*, "the Catholic," queen of Castile, was the second child and only daughter of John II. of Castile by his second wife Isabella, granddaughter of John I. of Portugal (thus being through both parents a descendant of John of Gaunt), and was born at Madrigal on the 22nd of April 1451. On the death of her father, who was succeeded by her brother Henry IV. (1454), she was withdrawn by her mother to Arevalo, where her early education was conducted in the deepest seclusion; in 1462, however, along with her uterine brother Alphonso, she was removed by Henry to the court, where she showed a remarkable example of staidness and sobriety. Already more than one suitor had made application for her hand, Ferdinand of Aragon, who ultimately became her husband, being among the number; for some little time she was engaged to his elder brother Charles, who died in 1461. In her thirteenth year her brother promised her in marriage to Alphonso of Portugal, but she firmly refused to consent; her resistance seemed less likely to be effectual in the case of Pedro Giron, grand master of the order of Calatrava and brother of the marquis of Villena, to whom she was next affianced, when she was delivered from her fears by the sudden death of the bridegroom while on his way to the nuptials in 1466. After an offer of the crown of Castile, made by the revolutionary leaders in the civil war, had been declined by her, she was in 1468 formally recognized by her brother as lawful heir, after himself, to the united crowns of Castile and Leon. New candidates for her hand now appeared in the persons of a brother of Edward IV. of England (probably Richard, duke of Gloucester), and the duke of Guienne, brother of Louis XI., and heir presumptive of the French monarchy. Finally however, in face of very great difficulties, she was married to Ferdinand of Aragon at Valladolid on the 19th of October 1469. Thence forward the fortunes of Ferdinand and Isabella were inseparably blended. For some time they held a humble court at Dueñas, and afterwards they resided at Segovia, where, on the death of Henry, she was proclaimed queen of Castile and Leon (December 13, 1474). Spain undoubtedly owed to Isabella's clear intellect, resolute energy and unselfish patriotism much of that greatness which for the first time it acquired under "the Catholic sovereigns." The moral influence of the queen's personal character over the Castilian court was incalculably great; from the debasement and degradation of the preceding reign she raised it to being "the nursery of virtue and of generous ambition." She did much for letters in Spain by founding the palace school and by her protection of Peter Martyr d'Anghiera. The very sincerity of her piety and strength of her religious convictions led her more than once, however, into great errors of state policy, and into more than one act which offends the moral sense of a more refined age; her efforts for the introduction of the Inquisition into Castile, and for the proscription of the Jews, are outstanding evidences of what can only be called her bigotry. But not even

the briefest sketch of her life can omit to notice that happy instinct or intuition which led her, when all others had heard with incredulity the scheme of Columbus, to recall the wanderer to her presence with the words, "I will assume the undertaking for my own crown of Castile, and am ready to pawn my jewels to defray the expenses of it, if the funds in the treasury should be found inadequate." She died at Medina del Campo on the 24th of November 1504, and was succeeded by her daughter Joanna "la loca" (the "Crazy") and her husband, Philip of Habsburg.

See W. H. Prescott, *History of the Reign of Ferdinand and Isabella* (1837), where the original authorities are exhaustively enumerated; and for later researches, Baron de Nervo, *Isabella the Catholic*, translated by Lieut.-Col. Temple-West (1897).

**ISABELLA II.** (1830-1904), queen of Spain, was born in Madrid on the 10th of October 1830. She was the eldest daughter of Ferdinand VII., king of Spain, and of his fourth wife, Maria Christina, a Neapolitan Bourbon, who became queen-regent on 20th September 1833, when her daughter, at the age of three years, was proclaimed on the death of the king. Queen Isabella succeeded to the throne because Ferdinand VII. induced the Cortes to assist him in setting aside the Salic law, which the Bourbons had introduced since the beginning of the 18th century, and to re-establish the older succession law of Spain. The brother of Ferdinand, Don Carlos, the first pretender, fought seven years, during the minority of Isabella, to dispute her title, and her rights were only maintained through the gallant support of the army, the Cortes and the Liberals and Progressists, who at the same time established constitutional and parliamentary government, dissolved the religious orders, confiscated the property of the orders and of the Jesuits, disestablished the Church property, and attempted to restore order in finances. After the Carlist war the queen-regent, Christina, resigned to make way for Espartero, the most successful and most popular general of the Isabelline armies, who only remained regent two years. He was turned out in 1843 by a military and political *pronunciamento*, led by Generals O'Donnell and Narvaez, who formed a cabinet, presided over by Joaquín María López, and this government induced the Cortes to declare Isabella of age at thirteen. Three years later the Moderado party or Castilian Conservatives made their queen marry, at sixteen, her cousin, Prince Francisco de Assisi de Bourbon (1842-1902), on the same day (10th October 1846) on which her younger sister married the duke of Montpensier. These marriages suited the views of France and Louis Philippe, who nearly quarrelled in consequence with Great Britain; but both matches were anything but happy. Queen Isabella reigned from 1843 to 1868, and that period was one long succession of palace intrigues, back-stairs and ante-chamber influences, barrack conspiracies, military *pronunciamentos* to further the ends of the political parties—Moderados, who ruled from 1846 to 1854, Progressists from 1854 to 1856, Union Liberal from 1856 to 1863; Moderados and Union Liberal quickly succeeding each other and keeping out the Progressists so steadily that the seeds were sown which budded into the revolution of 1868. Queen Isabella II. often interfered in politics in a wayward, unscrupulous manner that made her very unpopular. She showed most favour to her reactionary generals and statesmen, to the Church and religious orders, and was constantly the tool of corrupt and profligate courtiers and favourites who gave her court a deservedly bad name. She went into exile at the end of September 1868, after her Moderado generals had made a slight show of resistance that was crushed at the battle of Alcolea by Marshals Serrano and Prim. The only redeeming traits of Queen Isabella's reign were a war against Morocco, which ended in an advantageous treaty and some cession of territory; some progress in public works, especially railways; a slight improvement in commerce and finance. Isabella was induced to abdicate in Paris on 25th June 1870 in favour of her son, Alphonso XII., and the cause of the restoration was thus much furthered. She had separated from her husband in the previous March. She continued to live in France after the restoration in 1874. On the occasion of one of her visits to Madrid during Alphonso XII.'s reign she began to intrigue with the

<sup>1</sup> Possibly in the war at the beginning of the reign of Bahārm V.: but on the uncertainty see Nöldeke, *Gesch. d. Perser und Araber*, 117.

<sup>2</sup> Probably at the hands of the Hephthalites or White Huns of Kúshan: cf. Isaac's mention of the Huns in I. 420 of the 1st poem.

<sup>3</sup> The author refers to the weeping for Tamuz (I. 125 of the 1st poem), and speaks of his city as illustrious throughout the world (ib. l. 132).

politicians of the capital, and was peremptorily requested to go abroad again. She died on the 10th of April 1904.

**ISABELLA, ISABEAU, or ELIZABETH OF BAVARIA** (1370-1435), wife of Charles VI. of France, was the daughter of Stephen II., duke of Bavaria. She was born in 1370, was married to Charles VI. on the 17th of July 1385, and crowned at Paris on the 22nd of August 1389. After some years of happy married life she fell under the influence of the dissolute court in which she lived, and the king having become insane (August 1392) she consorted chiefly with Louis of Orleans. Frivolous, selfish, avaricious and fond of luxury, she used her influence, during the different periods when she was invested with the regency, not for the public welfare, but mainly in her own personal interest. After the assassination of the duke of Orleans (November 23, 1407) she attached herself sometimes to the Armagnacs, sometimes to the Burgundians, and led a scandalous life. Louis de Borseton, the captain of her guards, was executed for complicity in her excesses; and Isabella herself was imprisoned at Blois and afterwards at Tours (1417). Having been set free towards the end of that year by John the Fearless, duke of Burgundy, whom she had called to her assistance, she went to Troyes and established her government there, returning afterwards to Paris when that city had capitulated to the Burgundians in July 1418. Once more in power, she now took up arms against her son, the dauphin Charles; and after the murder of John the Fearless she went over to the side of the English, into whose hands she surrendered France by the treaty of Troyes (May 21, 1420), at the same time giving her daughter Catherine in marriage to the king of England, Henry V. After her triumphal entry into Paris with the latter she soon became an object of loathing to the whole French nation. She survived her husband, her son-in-law, and eight out of her twelve children, and she passed the last miserable years of her life in poverty, solitude and ill-health. She died at the end of September 1435, and was interred without funeral honours in the abbey of St Denis, by the side of her husband, Charles VI.

See Vallet de Viriville, *Isabeau de Bavière* (1859); Marcel Thibault, *Isabeau de Bavière, Reine de France, La Jeunesse, 1370-1405* (1903). (J. V.\*)

**ISABELLA OF HAINAUT** (1170-1190), queen of France, was the daughter of Baldwin V., count of Hainaut, and Margaret, sister of Philip of Alsace, and was born in 1170 at Lille. She was married to Philip Augustus, and brought to him as her dowry the province of Artois. She was crowned at St Denis on the 29th of May 1180. As Baldwin V. claimed to be a descendant of Charlemagne, the chroniclers of the time saw in this marriage a union of the Carolingian and Capetian dynasties. Though she received extravagant praise from certain annalists, she failed to win the affections of Philip, who, in 1184, waging war against Flanders, was angered at seeing Baldwin support his enemies, and called a council at Sens for the purpose of repudiating her. Robert, the king's uncle, successfully interposed. She died in childbirth in 1190, and was buried in the church of Notre Dame in Paris. Her son became Louis VIII. of France.

See Cartellieri, "L'Avènement de Phil. Aug." in *Rev. hist.* liii. 262 et seq.

**ISABEY, JEAN BAPTISTE** (1767-1855), French painter, was born at Nancy on the 11th of April 1767. At nineteen, after some lessons from Dumont, miniature painter to Marie Antoinette, he became a pupil of David. Employed at Versailles on portraits of the dukes of Angoulême and Berry, he was given a commission by the queen, which opens the long list of those which he received, up to the date of his death in 1855, from the successive rulers of France. Patronized by Josephine and Napoleon, he arranged the ceremonies of their coronation and prepared drawings for the publication intended as its official commemoration, a work for which he was paid by Louis XVIII., whose portrait (enlarged, Debucourt) he executed in 1814. Although Isabey did homage to Napoleon on his return from Elba, he continued to enjoy the favour of the Restoration, and took part in arrangements for the coronation of Charles X. The monarchy of July conferred on him an important post in connexion with the royal

collections, and Napoleon III. granted him a pension, and the cross of commander of the Legion of Honour. "Review of Troops by the First Consul" was one of his most important compositions, and "Isabey's Boat,"—a charming drawing of himself and family—produced at a time when he was much occupied with lithography—had an immense success at the Salon of 1820 (enlarged, Landon, *Annales*, i. 125). His portrait of "Napoleon at Malmaison" is held to be the best ever executed, and even his tiny head of the king of Rome, painted for a breast-pin, is distinguished by a decision and breadth which evidence the hand of a master.

A biography of Isabey was published by M. E. Taigny in 1859, and M. C. Lenormant's article, written for Michaud's *Biog. univ.*, is founded on facts furnished by Isabey's family.

**ISABNORMAL** (or **ISANOMALOUS**) **LINES**, in physical geography, lines upon a map or chart connecting places having an abnormal temperature. Each place has, theoretically, a proper temperature due to its latitude, and modified by its configuration. Its mean temperature for a particular period is decided by observation and called its normal temperature. Isabnormal lines may be used to denote the variations due to warm winds or currents, great altitudes or depressions, or great land masses as compared with sea. Or they may be used to indicate the abnormal result of weather observations made in an area such as the British Isles for a particular period.

**ISAEUS** (c. 420 B.C.—c. 350 B.C.), Attic orator, the chronological limits of whose extant work fall between the years 390 and 353 B.C., is described in the Plutarchic life as a Chalcidian; by Suidas, whom Dionysius follows, as an Athenian. The accounts have been reconciled by supposing that his family sprang from the settlement (*κληρουχία*) of Athenian citizens among whom the lands of the Chalcidian *hippobotae* (knights) had been divided about 509 B.C. In 411 B.C. Euboea (except Oreos) revolted from Athens; and it would not have been strange if residents of Athenian origin had then migrated from the hostile island to Attica. Such a connexion with Euboea would explain the non-Athenian name *Diagoras* which is borne by the father of Isaeus, while the latter is said to have been "an Athenian by descent" (*Ἀθηναῖος τὸ γένος*). So far as we know, Isaeus took no part in the public affairs of Athens. "I cannot tell," says Dionysius, "what were the politics of Isaeus—or whether he had any politics at all." Those words strikingly attest the profound change which was passing over the life of the Greek cities. It would have been scarcely possible, fifty years earlier, that an eminent Athenian with the powers of Isaeus should have failed to leave on record some proof of his interest in the political concerns of Athens or of Greece. But now, with the decline of personal devotion to the state, the life of an active citizen had ceased to have any necessary contact with political affairs. Already we are at the beginning of that transition which is to lead from the old life of Hellenic citizenship to that Hellenism whose children are citizens of the world.

Isaeus (who was born probably about 420 B.C.) is believed to have been an early pupil of Isocrates, and he certainly was a student of Lysias. A passage of Photius has been understood as meaning that personal relations had existed between Isaeus and Plato, but this view appears erroneous.<sup>1</sup> The profession of Isaeus was that of which Antiphon had been the first representative at Athens—that of a *λογογράφος*, who composed speeches which his clients were to deliver in the law-courts. But, while Antiphon had written such speeches chiefly (as Lysias frequently) for public causes, it was with private causes that Isaeus was almost exclusively concerned. The fact marks the progressive subdivision of labour in his calling, and the extent to which the smaller interests of private life now absorbed the attention of the citizen.

The most interesting recorded event in the career of Isaeus is one which belongs to its middle period—his connexion with Demosthenes. Born in 384 B.C., Demosthenes attained his civic majority in 366. At this time he had already resolved to

<sup>1</sup> See further Jebb's *Attic Orators from Antiphon to Isaeus*, (ii. 264).

prosecute the fraudulent guardians who had stripped him of his patrimony. In prospect of such a legal contest, he could have found no better ally than Isaeus. That the young Demosthenes actually resorted to his aid is beyond reasonable doubt. But the pseudo-Plutarch embellishes the story after his fashion. He says that Demosthenes, on coming of age, took Isaeus into his house, and studied with him for four years—paying him the sum of 10,000 drachmas (about £400), on condition that Isaeus should withdraw from a school of rhetoric which he had opened, and devote himself wholly to his new pupil. The real Plutarch gives us a more sober and a more probable version. He simply states that Demosthenes "employed Isaeus as his master in rhetoric, though Isocrates was then teaching, either (as some say) because he could not pay Isocrates the prescribed fee of ten minae, or because he preferred the style of Isaeus for his purpose, as being *vigorous and astute*" (*ῥαστήριον καὶ παισιώρητον*). It may be observed that, except by the pseudo-Plutarch, a school of Isaeus is not mentioned,—for a notice in Plutarch need mean no more than that he had written a textbook, or that his speeches were read in schools;<sup>1</sup> nor is any other pupil named. As to Demosthenes, his own speeches against Aphobus and Onetor (363–362 B.C.) afford the best possible gauge of the sense and the measure in which he was the disciple of Isaeus; the intercourse between them can scarcely have been either very close or very long. The date at which Isaeus died can only be conjectured from his work; it may be placed about 350 B.C.

Isaeus has a double claim on the student of Greek literature. He is the first Greek writer who comes before us as a consummate master of strict forensic controversy. He also holds a most important place in the general development of practical oratory, and therefore in the history of Attic prose. Antiphon marks the beginning of that development, Demosthenes its consummation. Between them stand Lysias and Isaeus. The open, even ostentatious, art of Antiphon had been austere and rigid. The concealed art of Lysias had charmed and persuaded by a versatile semblance of natural grace and simplicity. Isaeus brings us to a final stage of transition, in which the strictness of Lysias was to be fused into a flexibility which was that masterly art which receives its most powerful expression in Demosthenes. Here, then, are the two cardinal points by which the place of Isaeus must be determined. We must consider, first, his relation to Lysias; secondly, his relation to Demosthenes.

A comparison of Isaeus and Lysias must set out from the distinction between choice of words (*λέξεις*) and mode of putting words together (*σύνθεσις*). In choice of words, *diction*, Lysias and Isaeus are closely alike. Both are clear, pure, simple, concise; both have the stamp of persuasive plainness (*ἀόλιετα*), and both combine it with graphic power (*ἀνάρτυα*). In mode of putting words together, *composition*, there is, however a striking difference. Lysias threes off the stiff restraints of the earlier periodic style, with its wondrous monotony; he is too fond indeed of antithesis always to avoid a rigid effect; but, on the whole, his style is easy, flexible and various; above all, its subtle art usually succeeds in appearing natural. Now this is just what the art of Isaeus does not achieve. With less love of antithesis than Lysias, and with a diction almost equally natural and plain, he yet habitually conveys the impression of conscious and confident art. Hence he is least effective in adapting his style to those characters in which Lysias peculiarly excelled—the ingenious youth, the homely and peace-loving citizen. On the other hand, his more open and vigorous art does not interfere with his moral persuasiveness where there is scope for reasoned remonstrance, for keen argument or for powerful denunciation. Passing from the formal to the real side of his work, from diction and composition to the treatment of subject-matter, we find the divergence wider still. Lysias usually adheres to a simple four-fold division—proem, narrative, proof, epilogue. Isaeus frequently interweaves the narrative with the proof.<sup>2</sup> He shows the most dexterous ingenuity in adapting his manifold tactics to the case in hand, and often "out-generals" (*καταστραγγίζει*) his adversary by some novel and daring disposition of his forces. Lysias, again, usually contents himself with a merely rhetorical or sketchy proof; Isaeus insists on strict logical demonstration, worked out through all its steps. As

Sir William Jones well remarks, Isaeus lays close siege to the understandings of the jury.<sup>3</sup>

Such is the general relation of Isaeus to Lysias. What, we must next ask, is the relation of Isaeus to Demosthenes? The Greek critic who had so carefully studied both authors states his own view in broad terms when he declares that "the power of Demosthenes took its seeds and its beginnings from Isaeus" (*Diorn. Haec. Isaeus, 20*). A closer examination will show that within certain limits the statement may be allowed. Attic prose expression had been continuously developed as an art; the true link between Isaeus and Demosthenes is technical, depending on their continuity. Isaeus had made some original contributions to the resources of the art; and Demosthenes had not failed to profit by these. The *composition* of Demosthenes resembles that of Isaeus in blending terse and vigorous periods with passages of more lax and fluent ease, as well as in that dramatic vivacity which is given by rhetorical question and answer. In the versatile disposition of subject-matter, the divisions of "narrative" and "proof" being shifted and interwoven according to circumstances, Demosthenes has clearly been instructed by the example of Isaeus. Still more plainly and strikingly is this so in regard to the elaboration of systematic proof; here Demosthenes invites direct and close comparison with Isaeus by his method of drawing out a chain of arguments, or enforcing a proposition by strict legal argument. And, more generally, Demosthenes is the pupil of Isaeus in that faculty here the normal because not greater than that the master, in that faculty of grappling with an adversary's case point by point, in that aptitude for close and strenuous conflict which is expressed by the words *ἀγών, ἐπαγώνια*.<sup>4</sup>

The pseudo-Plutarch, in his life of Isaeus, mentions an *Art of Rhetoric* and sixty-four speeches, of which fifty were accounted genuine. From a passage of Photius it appears that at least<sup>5</sup> the fifty speeches of recognized authenticity were extant as late as A.D. 850. Only eleven, with a large part of a twelfth, have come down to us; but the titles of forty-two<sup>6</sup> others are known.<sup>7</sup>

The titles of the lost speeches confirm the statement of Dionysius that the speeches of Isaeus were exclusively forensic; and only three titles indicate speeches made in public causes. The remainder, concerned with private causes, may be classed under six heads:—(1) *κληρονομ*—cases of claim to an inheritance; (2) *ἐπικληρονομ*—cases of claim to the *ἀποστρασίον*—cases; (3) *διαδοχασίας*—cases of claim of property; (4) *ἰσχυρισμῶν*—cases of claim to the ownership of a slave; (5) *ἐγγύθιον*—action brought against a surety whose principal had made default; (6) *ἀδελφῶν ἰσχυρ* (*ἀσ*—*ἀσπυρογράφῃ*)—a special plea; (7) *ἐπιδικασίας*—appal from other jurisdiction to another.

Eleven of the twelve extant speeches belong to class (1), the *κληρονομ*, or claims to an inheritance. This was probably the branch of practice in which Isaeus had done his most important and most characteristic work. And, according to the ancient custom, this class of speeches would therefore stand first in the manuscript collections of his writings. The case of Antiphon is parallel; his speeches in cases of homicide (*φόνων*) were those on which his reputation mainly depended, and these stand first in the manuscripts. Their exclusive preservation, like that of the speeches made by Isaeus in will-cases, is thus primarily an accident of manuscript tradition, but partly also the result of the writer's special prestige.

Six of the twelve extant speeches are directly concerned with claims to an estate; five others are connected with legal proceedings arising out of such a claim. They may be classified thus (the name given in each case being that of the person whose estate is in dispute):

1. *Trials of Claim to an Inheritance (διαδοχασίας)*.
1. Or. i., Cleonymus. Date between 360 and 353 B.C.
1. Or. ii., Nicostratus. Date uncertain.
3. Or. vii., Apollodoros. 353 B.C.
4. Or. viii., Ciron. 375 B.C.
5. Or. ix., Astypphilus. 369 B.C. (c. 390–384, Schömann).
6. Or. x., Aristarchus. 377–371 B.C. (386–384, Schömann).

<sup>1</sup> This is what Dionysius means when he says (*Isaeus, 61*) that Isaeus differs from Lysias—*τῷ κατ' ἐπιθυμία τὴ λέξι ἀλλά κατ' ἐπιχρησῆμα*. Here the "euthymema" means a rhetorical syllogism with one premiss suppressed (*curtum*, Juv. vi. 449): "epicheirema," such a syllogism stated in full. Cf. K. Volkmann, *Rhetorik der Griechen und Römer*, 1872, pp. 153 f.

<sup>2</sup> Cleon's speech in Thuc. iii. 37, 38, works out its case with remarkable force; within a short space we have *ἐπινοεῖται ἀγών—τὴν τοῦδε ἀγῶνα—ἀγωνιστῆς—ἀγωνιστοῦ—ἀγωνιστοῦ ἰσχυρῶν—ἀγῶνα—ἀγῶνα—ἀγῶνα*. See *Attic Orators*, vol. I, pp. 1, 39, 304.

<sup>3</sup> For the words of Photius (cod. 265), *τοῦτον δὲ οὐ τὸ γένος μαρτυροῦντες ἢ καταλειπόμενον μόνον*, might be so rendered as to imply that, besides these fifty, others also were extant. See *Att. Orat.* ii. 311, note 2.

<sup>4</sup> Forty-four are given in Thalheim's ed. <sup>5</sup> The second of our speeches (the Meneclean) was discovered in the Laurentian Library in 1785, and was edited in that year by Tyrwhitt. In editions previous to that date, Oration i. is made to conclude with a few lines which really belong to the end of Orat. ii. (§ 47, ἀλλ' ἐπειθὶ τὸ πρῶμα... ἀφθόραστε), and this arrangement is followed in the translation by Isidore by Sir William Jones, who, in his second oration, was, of course, then (1779) unknown. In Oration i. all that follows the words *μὴ καθήκοντες* in § 22 was first published in 1815 by Mai, from a MS. in the Ambrosian Library at Milan.

<sup>1</sup> Plut. *De glor. Athen.* p. 350 c, where he mentions τὸν Ἰσακράτους καὶ Ἀντιφῶντος καὶ Λυσίου, among τῶν ἐν ταῖς σχολαῖς τὰ μέρητα προβάλλοντων.

<sup>2</sup> Here he was probably influenced by the teaching of Isocrates. The forensic speech of Isocrates known as the *Aegineticus* (Or. xix.), which belongs to the peculiar province of Isaeus, as dealing with a claim to property (*ἐπιδικασίας*), affords perhaps the earliest example of narrative and proof thus interwoven. Earlier forensic writers had kept the *ἀγῶνιστος* and *πίστεως* distinct, as Lysias does.

11. *Actions for False Witness* (δικα φευδομαρτυριῶν).  
 1. Or. ii., Menecles. 354 B.C.  
 2. Or. iii., Pyrrhus. Date uncertain, but comparatively late.  
 3. Or. vi., Philoetemon. 364-363 B.C.
111. *Action to Compel the Discharge of a Suretyship* (εγγυῶς δίκη).  
 Or. v., Dicaeogenes. 399 B.C.
- IV. *Indictment of a Guardian for Mis-treatment of a Ward* (δικαγγελία κακώσεως ἀφαισίου).  
 Or. xi., Hagnias. 359 B.C.
- V. *Appeal from Arbitration to a Dicastery* (ἀφαισι).  
 Or. xii., For Euphiletus. (Incomplete.) Date uncertain.

The speeches of Isaeus supply valuable illustrations to the early history of testamentary law. They show us the faculty of adoption, still, indeed, associated with the religious motive in which it originated, as a mode of securing that the sacred rites of the family shall continue to be discharged by one who can call himself the son of the deceased. But practically the civil aspect of adoption is, for the Athenian citizen, predominant over the religious; he adopts a son in order to bestow property on a person to whom he wishes to bequeath it. The Athenian system, as interpreted by Isaeus, is thus intermediate, at least in spirit, between the purely religious standpoint of the Hindu and the maturer form which Roman testamentary law had reached before the time of Cicero.<sup>1</sup> As to the form of the speeches, it is remarkable for its variety. There are three which, taken together, may be considered as best representing the diversity and range of their author's power. The fifth, with its simple but lively diction, its graceful and persuasive narrative, recalls the qualities of Lysias. The eleventh, with its sustained and impetuous power, has no slight resemblance to the manner of Demosthenes. The eighth is, of all, the most characteristic, alike in narrative and in argument. Isaeus is here seen at his best. No reader who is interested in the social life of ancient Greece need find Isaeus dull. If the glimpses of Greek society which he gives us are seldom so gay and picturesque as those which enliven the pages of Lysias, they are certainly not less suggestive. Here, where the innermost relations and central interests of the family are in question, we touch the springs of social life; we are not merely presented with scenic details of dress and furniture, but are enabled in no small degree to conceive the feelings of the actors.

The best manuscript of Isaeus is in the British Museum.—Crippianus A (= Burneianus 95, 13th century), which contains also Antiphon, Andocides, Lycurgus and Dinarchus. The next best is Bekker's Laurentianus B (Florence), of the 15th century. Besides these, he used Marcianus L (Venice), saec. 14, Vratilaviensis Z saec. 14<sup>7</sup> and two very inferior MSS. Ambrosianus A. 99, P (which he dismissed after Or. 1, ii.) and Ambrosianus L. 42, Q (which contains only Or. 1, ii.). Schömann in his edition of 1831 generally followed Bekker's text; he had no fresh apparatus beyond a collation of a Paris MS. R in part of Or. 1; but he had sifted the Aldine more carefully. Baiter and Sauppe (1850) had a new collation of A, and also used a collation of Burneianus 96, M, given by Dobson in vol. iv. of his edition (1828). C. Scheibe (Teubner, 1860) made it his especial aim to complete the work of his predecessors by restoring the correct Attic forms of words; thus (e.g.) he gives ἡγῶν for ἡγεῖν, δίκην for δίκην, and the like,—following the consent of the MSS., however, in such forms as the accusative of proper names in -ῶ rather than -ῶ, or (e.g.) the future φησῶν rather than φησῆναι, &c., and on such doubtful points as ἀφαισι rather than ἀφαισι, or εὐδαιμονία instead of εὐδαιμῆς.

EDITIONS.—*Editio princeps* (Aldus, Venice, 1513); in *Oratores Attici*, by I. Bekker (1823-1828); W. S. Dobson (1828); J. G. Baier and Hermann Sauppe (1850); separately, by G. F. Schömann, with commentary (1831); C. Scheibe (1860) (Teubner series, new ed. by T. Thalheim, 1903); H. Buermann (1883); W. Wyse (1904). English translation by Sir William Jones, 1779.

On Isaeus generally see Wyse's edition; K. C. Jebb, *Attic Orators*; F. Blaus, *Die attische Beredsamkeit* (2nd ed., 1887-1893); and L. Moy, *Étude sur les plaideurs d'Isée* (1876).

**ISAIAH.** I. *Life and Period.*—Isaiah is the name of the greatest, and both in life and in death the most influential of the Old Testament prophets. We do not forget Jeremiah, but Jeremiah's literary and religious influence is secondary compared with that of Isaiah. Unfortunately we are reduced to inference and conjecture with regard both to his life and to the extent of his literary activity. In the heading (i. 1) of what we may call the occasional prophecies of Isaiah (i.e. those which were called forth by passing events), the author is called "the son of Amoz" and Rabbinical legend identifies this Amoz with a brother of Amaziah, king of Judah; but this is evidently based on a mere etymological fancy. We know from his works that (unlike Jeremiah) he was married (viii. 3), and that he had at least two

sons, whose names he regarded as, together with his own, symbolic by divine appointment of certain decisive events or religious truths—Isaiah (Yesh'a-yāhū), meaning "Salvation—Yahweh"; Shear-Yāshūb, "a remnant shall return"; and Maher-shal-hash-baz, "swift (swiftly cometh) spoil, speedy (speedily cometh) prey" (vii. 3, viii. 3, 4, 18). He lived at Jerusalem, perhaps in the "middle" or "lower city" (2 Kings xx. 4), exercised at one time great influence at court (chap. xxxvii.), and could venture to address a king unbidden (vii. 4), and utter the most unpleasant truths, unassailed, in the plainest fashion. Presumably therefore his social rank was far above that of Amos and Micah; certainly the high degree of rhetorical skill displayed in his discourses implies a long course of literary discipline, not improbably in the school of some older prophet (Amos vii. 14 suggests that "schools" or companies "of the prophets" existed in the southern kingdom). We know but little of Isaiah's predecessors and models in the prophetic art (it were fanaticism to exclude the element of human preparation); but certainly even the acknowledged prophecies of Isaiah (and much more the disputed ones) could no more have come into existence suddenly and without warning than the masterpieces of Shakespeare. In the more recent commentaries (e.g. Cheyne's *Prophecies of Isaiah*, ii. 218) lists are generally given of the points of contact both in phraseology and in ideas between Isaiah and the prophets nearly contemporary with him. For Isaiah cannot be studied by himself.

The same heading already referred to gives us our only traditional information as to the period during which Isaiah prophesied; it refers to Uzziah, Jotham, Ahaz and Hezekiah as the contemporary kings. It is, however, to say the least, doubtful whether any of the extant prophecies are as early as the reign of Uzziah. Exegesis, the only safe basis of criticism for the prophetic literature, is unfavourable to the view that even chap. i. belongs to the reign of this king, and we must therefore regard it as most probable that the heading in i. 1 is (like those of the Psalms) the work of one or more of the Sopherim (or students and editors of Scripture) in post-exilic times, apparently the same writer (or company of writers) who prefixed the headings of Hosea and Micah, and perhaps of some of the other books. Chronological study had already begun in his time. But he would be a bold man who would profess to give trustworthy dates either for the kings of Israel or for the prophetic writers. (See BIBLE, *Old Testament*, Chronology; the article "Chronology" in the *Encyclopaedia Biblica*; and cf. H. P. Smith, *Old Testament History*, Edin., 1903, p. 202, note 2.)

II. *Chronological Arrangement, how far possible.*—Let us now briefly sketch the progress of Isaiah's prophesying on the basis of philological exegesis, and a comparison of the sound results of the study of the inscriptions. If our results are imperfect and liable to correction, that is only to be expected in the present position of the historical study of the Bible. Chap. vi., which describes a vision of Isaiah "in the death-year of King Uzziah" (740 or 734 B.C.?) may possibly have arisen out of notes put down in the reign of Jotham; but for several reasons it is not an acceptable view that, in its present form, this striking chapter is earlier than the reign of Ahaz. It seems, in short, to have originally formed the preface to the small group of prophecies which now follows it, viz. vii. i.-ix. 7. The portions which may represent discourses of Jotham's reign are chap. ii. and chap. ix. 8-x. 4—stern denunciations which remind us somewhat of Amos. But the allusions in the greater part of chaps. ii.-v. correspond to no period so closely as the reign of Ahaz, and the same remark applies still more self-evidently to vii. 1-ix. 7.<sup>3</sup> Chap. xvii. 1-11 ought undoubtedly to be read in immediate connexion with chap. vii.; it presupposes the alliance of Syria and northern Israel, whose destruction it predicts, though opening a door of hope for a remnant of Israel. The fatal siege of Samaria (724-722 B.C.) seems to have given occasion to chap. xxviii.; but the following

<sup>3</sup> On the question of the Isaianic origin of the prophecy, ix. 1-6, and the companion passage, xi. 1-8, see Cheyne *Introd. to the Book of Isaiah*, 1895, pp. 44, 45 and 62-66. Cf., however, J. Skinner "Isaiah i.-xxxix." in *Cambridge Bible*.

<sup>1</sup> Cf. Maine's *Ancient Law*, ch. vi., and the *Tagore Law Lectures* (1870) by Herbert Cowell, lect. ix. "On the Rite of Adoption," pp. 208 f.

<sup>2</sup> The date of L and Z is given as the end of the 15th century in the introduction to Wyse's edition.



prophecies (chaps. xxix.-xxxiii.) point in the main to Sennacherib's invasion, 701 B.C., which evidently stirred Isaiah's deepest feelings and was the occasion of some of his greatest prophecies. It is, however, the vengeance taken by Sargon upon Ashdod (711) which seems to be preserved in chap. xx., and the striking little prophecy in xxi. 1-10, sometimes referred to late to a supposed invasion of Judah by Sargon, rather belongs to some one of the many prophetic personages who wrote, but did not speak like the greater prophets, during and after the Exile. It is also an opinion largely held that the prophetic epilogue in xvi. 13, 14, was attached by Isaiah to an oracle on archaic style by another prophet (Isaiah's hand has, however, been traced by some in xvi. 4b, 5). In fact no progress can be expected in the accurate study of the prophets until the editorial activity both of the great prophets themselves and of their more reflective and studious successors is fully recognized.

Thus there were two great political events (the Syro-Israelitish invasion under Ahaz, and the great Assyrian invasion of Sennacherib) which called forth the spiritual and oratorical faculties of our prophet, and quickened his faculty of insight into the future. The Sennacherib prophecies must be taken in connexion with the historical appendix, chaps. xxxvi.-xxxix. The beauty and incisivness of the poetic prophecy in xxxvii. 21-32 have, by some critics, been regarded as evidence for its authenticity. This, however, is, on critical grounds, most questionable.

A special reference seems needed at this point to the oracle on Egypt, chap. xix. The comparative feebleness of the style has led to the conjecture that, even if the basis of the prophecy be Isaianic, yet in its present form it must have undergone the manipulation of a scribe. More probably, however, it belongs to the early Persian period. It should be added that the Isaianic origin of the appendix in xix. 18-24 is, if possible, even more doubtful, because of the precise, circumstantial details of the prophecy which are not like Isaiah's work. It is plausible to regard v. 18 as a fictitious prophecy in the interests of Onias, the founder of the rival Egyptian temple to Yahweh at Leontopolis in the name of Heliopolis (Josephus, *Ant. xii. 9, 7*).

III. *Disintegration Theories.*—We must now enter more fully into the question whether the whole of the so-called Book of Isaiah was really written by that prophet. The question relates, at any rate, to xiii.-xiv. 23, xxi. 1-10, xxiv.-xxvii., xxviii., xxxv. and xl.-lxvi. The father of the controversy may be said to be the Jewish rabbi, Aben Ezra, who died A.D. 1167. We need not, however, spend much time on the well-worn but inconclusive arguments of the older critics. The existence of a tradition in the last three centuries before Christ as to the authorship of any book is (to those acquainted with the habits of thought of that age) of but little critical moment; the *Sopherim*, i.e. students of Scripture, in those times were simply anxious for the authority of the Scriptures, not for the ascertainment of their precise historical origin. It was of the utmost importance to declare that (especially) Isaiah xl.-lxvi. was a prophetic work of the highest order; this was reason sufficient (apart from any presumed phraseological affinities in xl.-lxvi.) for ascribing them to the royal prophet Isaiah. When the view had once obtained currency, it would naturally become a tradition. The question of the Isaianic or non-Isaianic origin of the disputed prophecies (especially xl.-lxvi.) must be decided on grounds of exegesis alone. It matters little, therefore, when the older critics appeal to Ezra i. 2 (interpreted by Josephus, *Ant. xi. 1, 1-2*), to the Septuagint version of the book (produced between 260 and 130 B.C.), in which the disputed prophecies are already found, and to the Greek translation of the Wisdom of Jesus, the son of Sirach, which distinctly refers to Isaiah as the comforter of those that mourned in Zion (*Eccles. xlvi. 24, 25*).

The fault of the controversialists on both sides has been that each party has only seen "one side of the shield." It will be admitted by philological students that the exegetical data supplied by (at any rate) Isa. xl.-lxvi. are conflicting, and therefore susceptible of no simple solution. This remark applies, it is true, chiefly to the portion which begins at lii. 13. The earlier part of Isa. xl.-lxvi. admits of a perfectly consistent

interpretation from first to last. There is nothing in it to indicate that the author's standing-point is earlier than the Babylonian captivity. His object is (as most scholars, probably, believe) to warn, stimulate or console the captive Jews, some full believers, some semi-believers, some unbelievers or idolaters. The development of the prophet's message is full of contrasts and surprises: the vanity of the idol-gods and the omnipotence of Israel's helper, the sinfulness and infirmity of Israel and her high spiritual destiny, and the selection (so offensive to patriotic Jews, xlv. 9, 10) of the heathen Cyrus as the instrument of Yahweh's purposes, as in fact his Messiah or Anointed One (xlv. 1), are brought successively before us. Hence the semi-dramatic character of the style. Already in the opening passage mysterious voices are heard crying, "Comfort ye, comfort ye my people"; the plural indicates that there were other prophets among the exiles besides the author of Isa. xl.-lxviii. Then the Jews and the Asiatic nations in general are introduced trembling at the imminent downfall of the Babylonian empire. The former are reasoned with and exhorted to believe; the latter are contemptuously silenced by an exhibition of the futility of their religion. Then another mysterious form appears on the scene, bearing the honourable title of "Servant of Yahweh," through whom God's gracious purposes for Israel and the world are to be realized. The cycle of poetic passages on the character and work of this "Servant," or commissioned agent of the Most High, may have formed originally a separate collation which was somewhat later inserted in the Prophecy of Restoration (i.e. chaps. xl.-lxviii., and its appendix chaps. xlix.-lv.).

The new section which begins at chap. xlix. is written in much the same delightfully flowing style. We are still among the exiles at the close of the captivity, or, as others think, amidst a poor community in Jerusalem, whose members have now been dispersed among the Gentiles. The latter view is not so strange as it may at first appear, for the new book has this peculiarity, that Babylon and Cyrus are not mentioned in it at all. [True, there was not so much said about Babylon as we should have expected even in the first book; the paucity of references to the local characteristics of Babylonia is in fact one of the negative arguments urged by older scholars in favour of the Isaianic origin of the prophecy.] Israel himself, with all his inconsistent qualities, becomes the absorbing subject of the prophet's meditations. The section opens with a soliloquy of the "Servant of Yahweh," which leads on to a glorious comforting discourse, "Can a woman forget her sucking child," &c. (xlix. 1, comp. li. 12, 13). Then his tone rises, Jerusalem can and must be redeemed; he even seems to see the great divine act in process of accomplishment. Is it possible, one cannot help asking, that the abrupt description of the strange fortunes of the "Servant"—by this time entirely personalized—was written to follow chap. lii. 1-12?

The whole difficulty seems to arise from the long prevalent assumption that chaps. xl.-lxvi. form a whole in themselves. Natural as the feeling against disintegration may be, the difficulties in the way of admitting the unity of chaps. xl.-lxvi. are insurmountable. Even if, by a bold assumption, we grant the unity of authorship, it is plain upon the face of it that the chapters in question cannot have been composed at the same time or under the same circumstances; literary and artistic unity is wholly wanting. But once admit (as it is only reasonable to do) the extension of Jewish editorial activity to the prophetic books and all becomes clear. The record before us gives no information as to its origin. It is without a heading, and by its abrupt transitions, and honestly preserved variations of style, invites us to such a theory as we are now indicating. It is only the inveterate habit of reading Isa. xlix.-lxvi. as a part of a work relating to the close of the Exile that prevents us from seeing how inconsistent are the tone and details with this supposition.

The present article in its original form introduced here a survey of the portions of Isa. xl.-lxvi. which were plainly of Palestinian origin. It is needless to reproduce this here, because the information is now readily accessible elsewhere; in 1887 there was an originality in this survey, which gave promise of a still more radical treatment

such as that of Bernhard Duhm, a fascinating commentary published in 1892. See also Cheyne, *Jewish Quarterly Review*, July and October 1891; *Introd. to Book of Isaiah* (1895), which also point forward, like Stade's *Geschichte* in Germany, to a bolder criticism of Isaiah.

IV. *Non-Isaianic Elements in Chaps. i.-xxxix.*—We have said nothing hitherto, except by way of allusion, of the disputed prophecies scattered up and down the first half of the book of Isaiah. There is only one of these prophecies which may, with any degree of apparent plausibility, be referred to the age of Isaiah, and that is chaps. xxiv.-xxvii. The grounds are (1) that according to xxv. 6 the author dwells on Mount Zion; (2) that Moab is referred to as an enemy (xxv. 10); and (3) that at the close of the prophecy, Assyria and Egypt are apparently mentioned as the principal foes of Israel (xxvii. 12, 13). A careful and thorough exegesis will show the hollowness of this justification. The tone and spirit of the prophecy as a whole point to the same late apocalyptic period to which chap. xxxiv. and the book of Joel; and also the last chapter (especially) of the book of Zechariah, may unhesitatingly be referred.

A word or two may perhaps be expected on Isa. xiii., xiv. and xxiv., xxv. These two oracles agree in the elaborateness of their description of the fearful fate of the enemies of Yahweh (Babylon and Edom are merely representatives of a class), and also in their view of the deliverance and restoration of Israel as an epoch for the whole human race. There is also an unrelieved sternness, which pains us by its contrast with Isa. xl.-lxvi. (except those passages of this portion which are probably not homogeneous with the bulk of the prophecy). They have also affinities with Jer. i. li., a prophecy (as most now agree) of post-exilic origin.

There is only one passage which seems in some degree to make up for the aesthetic drawbacks of the greater part of these late compositions. It is the ode on the fall of the king of Babylon in chap. xiv. 4-21, which is as brilliant with the glow of lyric enthusiasm as the stern prophecy which precedes it, from the same point of view, dull and uninspiring. It is in fact worthy to be put by the side of the finest passages of chaps. xl.-lxvi.—of those passages which irresistibly rise in the memory when we think of "Isaiah."

V. *Prophetic Contrasts in Isaiah.*—From a religious point of view there is a wide difference, not only between the acknowledged and the disputed prophecies of the book of Isaiah, but also between those of the latter which occur in chaps. i.-xxxix., on the one hand, and the greater and more striking part of chaps. xl.-lxvi. on the other. We may say, upon the whole, with Duhm, that Isaiah represents a synthesis of Amos and Hosea, though not without important additions of his own. And if we cannot without much hesitation admit that Isaiah was really the first preacher of a personal Messiah whose record has come down to us, yet his editors certainly had good reason for thinking him capable of such a lofty height of prophecy. It is not because Isaiah could not have conceived of a personal Messiah, but because the Messiah-passages are not plainly Isaiah's either in style or in thought. If Isaiah had had those bright visions, they would have affected him more.

Perhaps the most characteristic religious peculiarities of the various disputed prophecies are—(1) the emphasis laid on the uniqueness, eternity, creatorship and predictive power of Yahweh (xl. 18, 25, xli. 4, xlv. 6, xlvi. 12, xlv. 5, 6, 18, 22, xlv. 9, xlii. 5, xlv. 18, xli. 26, xliii. 9, xlv. 7, xlv. 21, xlvi. 14); (2) the conception of the "Servant of Yahweh"; (3) the ironical descriptions of idolatry (Isaiah in the acknowledged prophecies only refers incidentally to idolatry) xl. 19, 20, xlv. 7, xlv. 9-17, xlvi. 6; (4) the personality of the Spirit of Yahweh (mentioned no less than seven times, see especially xl. 3, xlviii. 16, xlii. 10, 14); (5) the influence of the angelic powers (xxiv. 21); (6) the resurrection of the body (xxvi. 10); (7) the everlasting punishment of the wicked (lxvi. 24); (8) vicarious atonement (chap. liii.).

We cannot here do more than chronicle the attempts of a Jewish scholar, the late Dr Kohut, in the *Z.D.M.G.* for 1876 to prove a Zoroastrian influence on chaps. xl.-lxvi. The idea is

not in itself inadmissible, at least for post-exilic portions, for Zoroastrian ideas were in the intellectual atmosphere of Jewish writers in the Persian age.

There is an equally striking difference among the disputed prophecies themselves, and one of no small moment as a subsidiary indication of their origin. We have already spoken of the difference of tone between parts of the latter half of the book; and, when we compare the disputed prophecies of the former half with the Prophecy of Israel's Restoration, how inferior (with all reverence be it said) do they appear! Truly "in many parts and many manners did God speak" in this composite book of Isaiah! To the Prophecy of Restoration we may fitly apply the words, too gracious and too subtly chosen to be translated, of Renan, "ce second Isaie, dont l'âme lumineuse semble comme imprégnée, six cent ans d'avance, de toutes les rosées, de tous les parfums de l'avenir" (*L'Antichrist*, p. 464); though, indeed, the common verdict of sympathetic readers sums up the sentence in a single phrase—"the Evangelical Prophet." The freedom and the inexhaustibility of the undeserved grace of God is a subject to which this gifted son constantly returns with "a monotony which is never monotonous." The defect of the disputed prophecies in the former part of the book (a defect, as long as we regard them in isolation, and not as supplemented by those which come after) is that they emphasize too much for the Christian sentiment the stern, destructive side of the series of divine interpositions in the latter days.

VI. *The Cyrus Inscriptions.*—Perhaps one of the most important contributions to the study of II. Isaiah has been the discovery of two cuneiform texts relative to the fall of Babylon and the religious policy of Cyrus. The results are not favourable to a mechanical view of prophecy as involving absolute accuracy of statement. Cyrus appears in the unassailably authentic cylinder inscription "as a complete religious indifferentist, willing to go through any amount of ceremonies to soothe the prejudices of a susceptible population." He preserves a strange and significant silence with regard to Ahura-mazda, the supreme God of Zoroastrianism, and in fact can hardly have been a Zoroastrian believer at all. On the historical and religious bearings of these two inscriptions the reader may be referred to the article "Cyrus" in the *Encyclopaedia Biblica* and the essay on "II. Isaiah and the Inscriptions" in Cheyne's *Prophecies of Isaiah*, vol. ii. It may, with all reverence, be added that our estimate of prophecy must be brought into harmony with facts, not facts with our preconceived theory of inspiration.

AUTHORITIES.—Loth, *Isaiah: a new translation, with a preliminary dissertation and notes* (1778); Gesenius, *Der Proph. Jes.* (1821); Hitzig, *Der Proph. Jes.* (1833); Delitzsch, *Der Pr. Jes.* (4th ed., 1890); Ellmann-Kittel, *Isaiah* (1898); Duhm (1892; 2d ed., 1902); Marti (1900); Cheyne, *The Prophecies of Isaiah* (2 vols., 1880-1881); *Introd. to Book of Isaiah* (1898); "The Book of the Prophet Isaiah," in Paul Haupt's *Polykrome Bible* (1898); S. R. Driver, *Isaiah, his life and times* (1888); J. Skinner, "The Book of Isaiah," in *Cambridge Bible* (2 vols., 1896, 1898); G. A. Smith, in *Expositor's Bible* (2 vols., 1888, 1890); Condamine (Rom. Cath.) (1905); G. H. Box (1908); Article on Isaiah in *Ency. Bib.* by Cheyne; in Hastings' *Dict. of the Bible* by Prof. G. A. Smith. R. H. Kennett's *Schweich Lecture* (1909), *The Composition of the Book of Isaiah in the Light of Archaeology and History*, an interesting attempt at a synthesis of results, is a brightly written but scholarly sketch of the growth of the book of Isaiah, which went on till the great success of the Jews under Judas Maccabaeus. The outbursts of triumph (e.g. Isa. ix. 2-7) are assigned to this period. The most original statement is perhaps the view that the words of Isaiah were preserved orally by his disciples, and did not see the light (in a revised form) till a considerable time after the crystallization of the reforms of Isaiah into laws. (T. K. C.)

ISAIAH, ASCENSION OF, an apocryphal book of the Old Testament. The *Ascension of Isaiah* is a composite work of very great interest. In its present form it is probably not older than the latter half of the 2nd century of our era. Its various constituents, however, and of these there were three—the *Martyrdom of Isaiah*, the *Testament of Hesechiah* and the *Vision of Isaiah*—circulated independently as early as the 1st century. The first of these was of Jewish origin, and is of less interest than the other two, which were the work of Christian writers. The *Vision of Isaiah* is important for the knowledge it affords us of

rst-century beliefs in certain circles as to the doctrines of the Trinity, the Incarnation, the Resurrection, the Seven Heavens, &c. The long lost *Testament of Hesechiah*, which is, in the opinion of R. H. Charles, to be identified with iii. 13b-iv. 18, of our present work, is unquestionably of great value owing to the insight it gives us into the history of the Christian Church at the close of the 1st century. Its descriptions of the worldliness and lawlessness which prevailed among the elders and pastors, i.e. the bishops and priests, of the wide-spread covetousness and vainglory as well as the growing heresies among Christians generally, agree with similar accounts in 2 Peter, 2 Timothy and Clement of Rome.

*Various Titles.*—Origin in his commentary on Matt. xiii. 57 (Lommattsch III. 4, 9) calls it *Apocryph of Isaiiah*—*Ἀποκρυφὸν Ἰσαίου*, Epiphanius (*Haer.* c. 2) terms it the *Ascension of Isaiiah*—*Ἀνορθωσὶς Ἰσαίου*, and similarly Jerome—*Ascensio Isaiæ*. It was also known as the *Vision of Isaiiah* and finally as the *Testament of Hesechiah* (see Charles, *The Ascension of Isaiiah*, pp. xii-xv.).

*The Greek Original and the Latin Version.*—The book was written in Greek, though not improbably the middle portion, the *Testament of Hesechiah*, was originally composed in Semitic. The Greek in its original form, which we may denote by G, is lost. It has, however, been in part preserved to us in two of its recensions, G<sup>1</sup> and G<sup>2</sup>. From G<sup>1</sup> the Ethiopic Version and the first Latin Version (consisting of ii. 14-iii. 13, vii. 1-19) were translated, and of this recension the actual Greek has survived in a multitude of phrases in the *Greek Legend*. G<sup>2</sup> denotes the Greek text from which the Slavonic and the second Latin Version (consisting of vi.-xi.) were translated. Of this recension ii. 4-iv. 2 have been discovered by Grenfell and Hunt.<sup>1</sup> For complete details see Charles, *op. cit.* pp. xviii-xxiii.; also Flemming in Hennecke's *NTliche Apok.*

*Latin Version.*—The first Latin Version (L<sup>1</sup>) is fragmentary (=ii. 14-iii. 13, vii. 1-19). It was discovered and edited by Mätzner in 1828 (*Script. vet. nova collectio III.* ii. 238), and reprinted by Dillmann in his edition of 1877, and subsequently in a more correct form by Charles in his edition of 1900. The second version (L<sup>2</sup>), which consists of vi.-xi., was first printed at Venice in 1522, by Geseler in 1832, Dillmann in 1877 and Charles in 1900.

*Ethiopic Version.*—There are three MSS. This version is on the whole a faithful reproduction of G<sup>1</sup>. These were used by Dillmann and subsequently by Charles in their editions.

*Different Elements in the Book.*—The compositeness of this work is universally recognized. Dillmann's analysis is as follows. (i.) *Martyrdom of Isaiiah*, of Jewish origin; ii. 1-13, 12, v. 2-14. (ii.) *The Vision of Isaiiah*, of Christian origin, vi. 1-xi., 23-40. (iii.) The above two constituents were put together by a Christian writer, who prefixed i. 1, 2, 4b-13 and appended xi. 42, 43. (iv.) Finally a later Christian editor incorporated the two sections iii. 13-v. 1 and xi. 2-22, and added i. 3, 4a, v. 15, 16, xi. 41.

This analysis has on the whole been accepted by Harnack, Schürer, Deane and Beer. These scholars have been influenced by Gebhardt's statement that in the *Greek Legend* there is not a trace of iii. 13-v. 1, xi. 2-22, and that accordingly these sections were absent from the text when the *Greek Legend* was composed. But this statement is wrong, for at least five phrases or clauses in the *Greek Legend* are derived from the sections in question. Hence R. H. Charles has examined (*op. cit.* pp. xxxviii.-lxvii.) the problem *de novo*, and arrived at the following conclusions. The book is highly composite, and arbitrariness and disorder are found in every section. There are three original documents at its base. (i.) *The Martyrdom of Isaiiah* = i. 1, 2a, 6b-13a, ii. 1-8, 10-13, 12, v. 1b-14. This is but an imperfect survival of the original work. Part of the original work omitted by the final editor of our book is preserved in the *Opus Imperfectum*, which goes back not to our text, but to the original *Martyrdom*. (ii.) *The Testament of Hesechiah* = iii. 13b-iv. 18. This work is mutilated and without beginning or end. (iii.) *The Vision of Isaiiah* = vi.-xi., 1-40. The archetype of this section existed independently in Greek; for the second Latin and the Slavonic Versions presuppose an independent circulation of their Greek archetype in western and Slavonic countries. This archetype differs in many respects from the form in which it was published by the editor of the entire work.

We may, in short, put this complex matter as follows: The conditions of the problem are sufficiently satisfied by supposing a single editor, who had three works at his disposal, the *Martyrdom of Isaiiah*, of Jewish origin, and the *Testament of Hesechiah* and the *Vision of Isaiiah*, of Christian origin. These he reduced or enlarged as it suited his purpose, and put them together as they stand in our text. Some of the editorial additions are obvious, as i. 2b-6a, 13a, 41, 9, iii. 13a, iv. 1a, 19-v. 1a, 15, 16, xi. 41-43.

*Dates of the Various Constituents of the Ascension.*—(a) *The Martyrdom* is quoted by the *Opus Imperfectum*, Ambrose, Jerome,

Origen, Tertullian and by Justin Martyr. It was probably known to the writer of the Epistle to the Hebrews. Thus we are brought back to the 1st century A.D. if the last reference is trustworthy. And this is no doubt the right date, for works written by Jews in the 2nd century would not be likely to become current in the Christian Church. (b) *The Testament of Hesechiah* was written between A.D. 88-100. The grounds for this date will be found in Charles, *op. cit.* pp. lxxi-lxxii. and 30-31. (c) *The Vision of Isaiiah*. The later recension of this Vision was used by Jerome, and a more primitive form of the text by the Archontici according to Epiphanius. It is still earlier attested by the *Actus Petri Vercellenses*. Since the Protevangelium of James was apparently acquainted with it, and likewise Ignatius (*ad Eph.* xix.), the composition of the primitive form of the Vision goes back to the close of the 1st century.

The work of combining and editing these three independent writings may go back to early in the 3rd or even to the 2nd century.

*LITERATURE.*—Editions of the *Ethiopic Text*: Laurence, *Ascensio Isaiæ vatis* (1819); Dillmann, *Ascensio Isaiæ Aethiopicæ et Latine, cum prolegomenis, adnotationibus criticis et exegeticis, additis versionum Latinarum reliquias edita* (1877); Charles, *Ascension of Isaiiah, translated from the Ethiopic Version, which, together with the new Greek Fragment, the Latin Versions and the Latin translation of the Slavonic, is here published in full, edited with Introduction, Notes and Indices* (1900); Flemming, in Hennecke's *NTliche Apok.* 202-305; *NTliche Apok.-Handbuch*, 325-331. This translation is made from Charles's text, and his analysis of the text is in the main accepted by this scholar. *Translations*: In addition to the translations given in the preceding editions, Bassett, *Les Apocryphes éthiopiens*, iii. 'L'Ascension d'Isaïe' (1894); Beer, *Apok. und Pseud.* (1900), 124-127. The latter is a German rendering of ii.-iii. 1-12, v. 2-14, of Dillmann's text. *Critical Inquiries*: Stokes, art. "Isaiah, Ascension of," in Smith's *Dict. of Christian Biography* (1882), iii. 298-301; Robinson, "The Ascension of Isaiiah" in Hastings' *Bible Dict.* ii. 499-501. For complete bibliography see Schürer's *Gesch. des jüd. Volks*, iii. 280-285; Charles, *op. cit.* (R. H. C.)

**ISANDHLWANA**, an isolated hill in Zululand, 8 m. S.E. of Rorke's Drift across the Tugela river, and 105 m. N. by W. of Durban. On the 22nd of January 1879 a British force encamped at the foot of the hill was attacked by about 10,000 Zulus, the flower of Cetewayo's army, and destroyed. Of eight hundred Europeans engaged about forty escaped (see ZULULAND: *History*).

**ISAR** (identical with *Isère*, in Celtic "the rapid"), a river of Bavaria. It rises in the Tirolese Alps N.E. from Innsbruck, at an altitude of 5840 ft. It first winds in deep, narrow gorges and gorges through the Alps, and at Tölz (2100 ft.), due north from its source, enters the Bavarian plain, which it traverses in a generally north and north-east direction, and pours its waters into the Danube immediately below Deggendorf after a course of 219 m. The area of its drainage basin is 38,200 sq. m. Below Munich the stream is 140 to 350 yards wide, and is studded with islands. It is not navigable, except for rafts. The total fall of the river is 4816 ft. The Isar is essentially the national stream of the Bavarians. It has belonged from the earliest times to the Bavarian people and traverses the finest corn land in the kingdom. On its banks lie the cities of Munich and Landshut, and the venerable episcopal see of Freising, and the inhabitants of the district it waters are reckoned the core of the Bavarian race.

See C. Gruber, *Die Isar nach ihrer Entwicklung und ihrem hydrologischen Verhältnissen* (Munich, 1889); and *Die Bedeutung der Isar als Verkehrsstrasse* (Munich, 1890).

**ISATIN**, C<sub>12</sub>H<sub>10</sub>N<sub>2</sub>O<sub>2</sub>, in chemistry, a derivative of indol, interesting on account of its relation to indigo; it may be regarded as the anhydride of ortho-aminobenzoylformic or isatinic acid. It crystallizes in orange red prisms which melt at 200-201° C. It may be prepared by oxidizing indigo with nitric or chromic acid (O. L. Erdmann, *Jour. prak. Chem.*, 1847, 24, p. 11); by boiling ortho-nitrophenylpropionic acid with alkalis (A. Baeyer, *Ber.*, 1880, 13, p. 2259), or by oxidizing carbostyryl with alkaline potassium permanganate (P. Friedlander and H. Ostermayer, *Ber.*, 1881, 14, p. 1921). P. J. Meyer (German Patent 26736 (1883)) obtains substituted isatins by condensing para-toluidine with dichloroacetic acid, oxidizing the product with air and then hydrolysing the oxidized product with hydrochloric acid. T. Sandmeyer (German Patents 113081 and 110831 (1890)) obtained isatin-*α*-anilide by condensing aniline with chloral hydrate and hydroxylamine, an intermediate product isonitrosodiphenylacetamide being obtained, which is converted into isatin-*α*-anilide by sulphuric acid. This can be converted into indigo

<sup>1</sup> Published by them in the *Amherst Papyrus*, an account of the Greek papyrus in the collection of Lord Amherst (1900), and by Charles in his edition.

by reduction with ammonium sulphide. Isatin dissolved in concentrated sulphuric acid gives a blue coloration with thiophene, due to the formation of indophenin (see *Abst. J.C.S.*, 1907). Concentrated nitric acid oxidizes it to oxalic acid, and alkali fusion yields aniline. It dissolves in soda forming a violet solution, which soon becomes yellow, a change due to the transformation of sodium *N*-isatin into sodium isatate, the acisatin salt being probably formed intermediately (Heller, *Abst. J.C.S.*, 1907, i. p. 442). Most metallic salts are *N*-derivatives yielding *N*-methyl ethers; the silver salt is, however, an *O*-derivative, yielding an *O*-methyl ether (A. v. Baeyer, 1883; W. Peters, *Abst. J.C.S.*, 1907, i. p. 239).

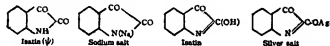

**ISAURIA**, in ancient geography, a district in the interior of Asia Minor, of very different extent at different periods. The permanent nucleus of it was that section of the Taurus which lies directly to south of Iconium and Lystra. Lycaonia had all the Iconian plain; but Isauria began as soon as the foothills were reached. Its two original towns, Isaura Nea and Isaura Palaea, lay, one among these foothills (*Doria*) and the other on the watershed (Zengibar Kalé). When the Romans first encountered the Isaaurians (early in the 1st century B.C.), they regarded Cilicia Trachea as part of Isauria, which thus extended to the sea; and this extension of the name continued to be in common use for two centuries. The whole basin of the Calycadnus was reckoned Isaurian, and the cities in the valley of its northern branch formed what was known as the Isaurian Decapolis. Towards the end of the 3rd century A.D., however, all Cilicia was detached for administrative purposes from the northern slope of Taurus, and we find a province called at first Isauria-Lycaonia, and later Isauria alone, extending up to the limits of Galatia, but not passing Taurus on the south. Pisidia, part of which had hitherto been included in one province with Isauria, was also detached, and made to include Iconium. In compensation Isauria received the eastern part of Pamphylia. Restricted again in the 4th century, Isauria ended as it began by being just the wild district about Isaura Palaea and the heads of the Calycadnus. Isaura Palaea was besieged by Perdiccas, the Macedonian regent after Alexander's death; and to avoid capture its citizens set the place alight and perished in the flames. During the war of the Cilician and other pirates against Rome, the Isaaurians took so active a part that the proconsul P. Servilius deemed it necessary to follow them into their fastnesses, and compel the whole people to submission, an exploit for which he received the title of Isauricus (75 B.C.). The Isaaurians were afterwards placed for a time under the rule of Amyntas, king of Galatia; but it is evident that they continued to retain their predatory habits and virtual independence. In the 3rd century they sheltered the rebel emperor, Trebellianus. In the 4th century they are still described by Ammianus Marcellinus as the scourge of the neighbouring provinces of Asia Minor; but they are said to have been effectually subdued in the reign of Justinian. In common with all the eastern Taurus, Isauria passed into the hands of Turcomans and Yuruks with the Seljuk conquest. Many of these have now coalesced with the aboriginal population and form a settled element: but the district is still lawless.

This comparatively obscure people had the honour of producing two Byzantine emperors, Zeno, whose native name was Traskalisseus Rousoumbadeotes, and Leo III., who ascended the throne of Constantinople in 718, reigned till 741, and became the founder of a dynasty of three generations. The ruins of Isaura Palaea are mainly remarkable for their fine situation and their fortifications and tombs. Those of Isaura Nea have disappeared, but numerous inscriptions and many sculptured *stelae*, built into the houses of *Doria*, prove the site. It was the latter, and not the former town, that Servilius reduced by cutting off the water supply. The site was identified by W. M.

Ramsay in 1901. The only modern exploration of highland Isauria was that made by J. S. Sterrett in 1885; but it was not exhaustive.

**BIBLIOGRAPHY.**—W. M. Ramsay, *Historical Geography of Asia Minor* (1890), and article "Nova Isauria" in *Journ. Hell. Studies* (1905); A. M. Ramsay, *ibid.* (1904); J. R. S. Sterrett, "Wolfe Expedition to Asia Minor," *Papers Amer. Inst. of Arch.* iii. (1888); C. Ritter, *Erskunde*, xix. (1859); E. J. Davis, *Life in A. Turkey* (1879). (D. G. H.)

**ISCHIA** (Gr. Πιθηκῶσα, Lat. *Aenaria*, in poetry *Inghine*), an island off the coast of Campania, Italy, 16 m. S.W. of Naples, to the province of which it belongs, and 7 m. S.W. of the Capo Miseno, the nearest point of the mainland. Pop. about 20,000. It is situated at the W. extremity of the Gulf of Naples, and is the largest island near Naples, measuring about 19 m. in circumference and 26 sq. m. in area. It belongs to the same volcanic system as the mainland near it, and the Monte Epomeo (anc. Ἐρωεῖς, viewpoint), the highest point of the island (2588 ft.), lies on the N. edge of the principal crater, which is surrounded by twelve smaller cones. The island was perhaps occupied by Greek settlers even before Cumae; its Etrurian and Chalcidian inhabitants abandoned it about 500 B.C. owing to an eruption, and it is said to have been deserted almost at once by the greater part of the garrison which Hiero I. of Syracuse had placed there about 470 B.C., owing to the same cause. Later on it came into the possession of Naples, but passed into Roman hands in 326, when Naples herself lost her independence. The ancient town, traces of the fortifications of which still exist, was situated near Lacco, at the N.W. corner of the island. Augustus gave it back to Naples in exchange for Capri. After the fall of Rome it suffered attacks and devastations from the successive masters of Italy, until it was finally taken by the Neapolitans in 1209.

Several eruptions are recorded in Roman times. The last of which we have any knowledge occurred in 1301, but the island was visited by earthquakes in 1881 and 1883, 1700 lives being lost in the latter year, when the town of Casamicciola on the north side of the island was almost entirely destroyed. The hot springs here, which still survive from the period of volcanic activity, rise at a temperature of 147° Fahr. and are alkaline and saline; they are much visited by bathers, especially in summer. They were known in Roman times, and many votive altars dedicated to Apollo and the nymphs have been found. The whole island is mountainous, and is remarkable for its beautiful scenery and its fertility. Wine, corn, oil and fruit are produced, especially the former, while the mountain slopes are clothed with woods. Tiles and pottery are made in the island. Straw-plaiting is a considerable industry at Lacco; and a certain amount of fishing is also done. The potter's clay of Ischia served for the potteries of Cumae and Puteoli in ancient times, and was indeed in considerable demand until the catastrophe at Casamicciola in 1883.

The chief towns are Ischia on the E. coast, the capital and the seat of a bishop (pop. in 1901, town, 2756; commune, 7012), with a 15th-century castle, to which Vittoria Colonna retired after the death of her husband in 1525; Casamicciola (pop. in 1901, town, 1085; commune, 3731) on the north, and Forio on the west coast (pop. in 1901, town, 3640; commune, 7197). There is regular communication with Naples, both by steamer direct, and also by steamer to Torregaveta, 2 m. W.S.W. of Baiae and 12½ m. W.S.W. of Naples, and thence by rail.

See J. Beloch, *Campanien* (Breslau, 1890), 202 sqq. (T. As.) 7  
**ISCHL**, a market-town and watering-place of Austria, in Upper Austria, 55 m. S.S.W. of Linz by rail. Pop. (1900) 9646. It is beautifully situated on the peninsula formed by the junction of the rivers Ischl and Traun and is surrounded by high mountains, presenting scenery of the finest description. To the S. is the Siruskogel or Hundskogel (1060 ft.), and to the W. the Schafberg (5837 ft.), which is ascended from St Wolfgang by a rack-and-pinion railway, built in 1893. It possesses a fine parish church, built by Maria Theresa and renovated in 1877-1880, and the Imperial Villa is surrounded by a magnificent park. Ischl is one of the most fashionable spas of Europe, being the favourite

summer residence of the Austrian Imperial family and of the Austrian nobility since 1822. It has saline and sulphurous drinking springs and numerous brine and brine-vapour baths. The brine used at Ischl contains about 25% of salt and there are also mud, sulphur and pine-cone baths. Ischl is situated at an altitude of 1533 ft. above sea-level and has a very mild climate. Its mean annual temperature is 49.4° F. and its mean summer temperature is 63.5° F. Ischl is an important centre of the salt industry and 4 m. to its W. is a celebrated salt mine, which has been worked as early as the 12th century.

**ISEO, LAKE OF** (the *Lacus Sebimus* of the Romans), a lake in Lombardy, N. Italy, situated at the southern foot of the Alps, and between the provinces of Bergamo and Brescia. It is formed by the Oglio river, which enters the northern extremity of the lake of Lovere, and issues from the southern end at Sarnico, on its way to join the Po. The area of the lake is about 24 sq. m., it is 1½ m. in length, and 3 m. wide in the broadest portion, while the greatest depth is said to be about 984 ft. and the height of its surface above sea-level 607 ft. It contains one large island, that of Siviano, which culminates in the Monte Isola (1965 ft.) that is crowned by a chapel, while to the south is the islet of San Paolo, occupied by the buildings of a small Franciscan convent now abandoned, and to the north the equally tiny island of Loreto, with a ruined chapel containing frescoes. At the southern end of the lake are the small towns of Iseo (15 m. by rail N.W. of Brescia) and of Sarnico. From Paratico, opposite Sarnico, on the other or left bank of the Oglio, a railway runs in 6½ m. to Palazzolo, on the main Brescia-Bergamo line. Towards the head of the lake, the deep wide valley of the Oglio is seen, dominated by the glittering snows of the Adamello (11,661 ft.), a glorious prospect. Along the east shore (the west shore is far more rugged) a fine carriage road runs from Iseo to the considerable town of Pisogne (13½ m.), situated at the northern end of the lake, and nearly opposite that of Lovere, on the right bank of the Oglio. The portion of this road some way S. of Pisogne is cleverly engineered, and is carried through several tunnels. The lake's charms were celebrated by Lady Mary Wortley-Montagu, who spent ten summers (1747-1757) in a villa at Lovere, then much frequented by reason of an iron spring. The lake has several sardine and eel fisheries. (W. A. B. C.)

**ISÈRE** [anc. *Isara*], one of the chief rivers in France as well as of those flowing down on the French side of the Alpine chain. Its total length from its source to its junction with the Rhône is about 180 m., during which it descends a height of about 7550 ft. Its drainage area is about 4725 sq. m. It flows through the departments of Savoie, Isère and Drôme. This river rises in the Galise glaciers in the French Graian Alps and flows, as a mountain torrent, through a narrow valley past Tignes in a north-westerly direction to Bourg St Maurice, at the western foot of the Little St Bernard Pass. It now bends S.W., as far as Moutiers, the chief town of the Tarentaise, as the upper course of the Isère is named. Here it again turns N.W. as far as Albertville, where after receiving the Arly (right) it once more takes a south-westerly direction, and near St Pierre d'Albigny receives its first important tributary, the Arc (left), a wild mountain stream flowing through the Maurienne and past the foot of the Mont Cenis Pass. A little way below, at Montméan, it becomes officially navigable (for about half of its course), though it is but little used for that purpose owing to the irregular depth of its bed and the rapidity of its current. Very probably, in ancient days, it flowed from Montméan N.W. and, after passing through or forming the Lac du Bourget, joined the Rhône. But at present it continues from Montméan in a south-westerly direction, flowing through the broad and fertile valley of the Graisivaudan, though receiving but a single affluent of any importance, the Bréda (left). At Grenoble, the most important town on its banks, it bends for a short distance again N.W. But just below that town it receives by far its most important affluent (left) the Drac, which itself drains the entire S. slope of the lofty snow-clad Dauphiné Alps, and which, 11 m. above Grenoble, had received the Romanche (right), a mountain stream which drains the entire central and N. portion of the same

Alps. Hence the Drac is, at its junction with the Isère, a stream of nearly the same volume, while these two rivers, with the Durance, drain practically the entire French slope of the Alpine chain, the basins of the Arve and of the Var forming the sole exceptions. A short distance below Moirans the Isère changes its direction for the last time and now flows S.W. past Romans before joining the Rhône on the left, as its principal affluent after the Saône and the Durance, between Tournon and Valence. The Isère is remarkable for the way in which it changes its direction, forming three great loops of which the apex is respectively at Bourg St Maurice, Albertville and Moirans. For some way after its junction with the Rhône the grey troubled current of the Isère can be distinguished in the broad and peaceful stream of the Rhône. (W. A. B. C.)

**ISÈRE**, a department of S.E. France, formed in 1790 out of the northern part of the old province of Dauphiné. Pop. (1906) 562,315. It is bounded N. by the department of the Ain, E. by that of Savoie, S. by those of the Hautes Alpes and the Drôme and W. by those of the Loire and the Rhône. Its area is 3179 sq. m. (surpassed only by 7 other departments), while its greatest length is 93 m. and its greatest breadth 53 m. The river Isère runs for nearly half its course through this department, to which it gives its name. The southern portion of the department is very mountainous, the loftiest summit being the Pic Lory (13,306 ft.) in the extensive snow-clad Oisans group (drained by the Drac and Romanche, two mighty mountain torrents), while minor groups are those of Belledonne, of Allevard, of the Grandes Rousses, of the Dévoluy, of the Trièves, of the Royannais, of the Vercors and, slightly to the north of the rest, that of the Grande Chartreuse. The northern portion of the department is composed of plateaux, low hills and plains, while on every side but the south it is bounded by the course of the Rhône. It forms the bishopric of Grenoble (dating from the 4th century), till 1790 in the ecclesiastical province of Vienne, and now in that of Lyons. The department is divided into four arrondissements (Grenoble, St Marcellin, La Tour du Pin and Vienne), 45 cantons and 563 communes. Its capital is Grenoble, while other important towns in it are the towns of Vienne, St Marcellin and La Tour du Pin. It is well supplied with railways (total length 342 m.), which give access to Gap, to Chambéry, to Lyons, to St Rambert and to Valence, while it also possesses many tramways (total length over 200 m.). It contains silver, lead, coal and iron mines, as well as extensive slate, stone and marble quarries, besides several mineral springs (Allevard, Uriage and La Motte). The forests cover much ground, while among the most flourishing industries are those of glove making, cement, silk weaving and paper making. The area devoted to agriculture (largely in the fertile valley of the Graisivaudan, or Isère, N.E. of Grenoble) is about 1211 sq. m. (W. A. B. C.)

**ISERLOHN**, a town in the Prussian province of Westphalia, on the Baar, in a bleak and hilly region, 17 m. W. of Arnsberg, and 30 m. E.N.E. from Barmen by rail. Pop. (1900) 27,265. Iserlohn is one of the most important manufacturing towns in Westphalia. Both in the town and neighbourhood there are numerous foundries and works for iron, brass, steel and bronze goods, while other manufactures include wire, needles and pins, fish-hooks, machinery, umbrella-frames, thimbles, bits, furniture, chemicals, coffee-mills, and pinchbeck and britannia-metal goods. Iserlohn is a very old town, its guild of armourers being referred to as "an ancient" in 1443.

**ISFAHĀN** (older form "Isfahān"), the name of a Persian province and town. The province is situated in the centre of the country, and bounded S. by Fars, E. by Yazd, N. by Kashān, Natanz and Irāk, and W. by the Bakhtiārī district and Arabistān. It pays a yearly revenue of about £100,000, and its population exceeds 500,000. It is divided into twenty-five districts, its capital, the town of Isfahān, forming one of them. These twenty-five districts, some very small and consisting of only a little township and a few hamlets, are Isfahān, Jāi, Barkhār, Kahāb, Kararāj, Barān, Rūdasht, Marbin, Lenjān, Kerven, Rār, Kiar, Mizdej, Ganduman, Somairam, Jarkūyeh, Ardistan, Kūhpayeh, Najafabad, Komisheh, Chadugan, Varzek, Tokhmaku,

Gurji, Chinarūd. Most of these districts are very fertile, and produce great quantities of wheat, barley, rice, cotton, tobacco and opium. Lenjān, west of the city of Isfahān, is the greatest rice-producing district; the finest cotton comes from Jarkūyeh; the best opium and tobacco from the villages in the vicinity of the city.

The town of Isfahān or Spahān, formerly the capital of Persia, now the capital of the province, is situated on the Zayendeh river in  $32^{\circ} 39' N.$  and  $51^{\circ} 40' E.$  at an elevation of 5370 ft. Its population, excluding that of the Armenian colony of Julfa on the right or south bank of the river (about 4000), is estimated at 100,000 (73,654, including 5883 Jews, in 1882). The town is divided into thirty-seven *mahallehs* (parishes) and has 210 mosques and colleges (many half ruined), 84 caravanserais, 150 public baths and 68 flour mills. The water supply is principally from open canals led off from the river and from several streams and canals which come down from the hills in the north-west. The name of the Isfahān river was originally Zende (Pahlavi *zende*) rūd, "the great river"; it was then modernized into Zindeh-rūd, "the living river," and is now called Zayendeh rūd, "the life-giving river." Its principal source is the Jarāneh rūd which rises on the eastern slope of the Zardeh Kuh about 90 to 100 m. W. of Isfahān. After receiving the Khursang river from Feridan on the north and the Zarīn rūd from Chaharmahal on the south it is called Zendeh rūd. It then waters the Lenjan and Marbin districts, passes Isfahān as Zayendeh-rūd and 70 m. farther E. ends in the Gavkhani depression. From its entrance into Lenjan to its end 103 canals are led off from it for purposes of irrigation and 14 bridges cross it (5 at Isfahān). Its volume of water at Isfahān during the spring season has been estimated at 60,000 cub. ft. per second; in autumn the quantity is reduced to one-third, but nearly all of it being then used for feeding the irrigation canals very little is left for the river bed. The town covers about 20 sq. m., but many parts of it are in ruins. The old city walls—a ruined mud curtain—are about 5 m. in circumference.

Of the many fine public buildings constructed by the Sefavids and during the reign of the present dynasty very little remains. There are still standing in fairly good repair the two palaces named respectively Chehel Sitūn, "the forty pillars," and Hasht Behesht, "the eight paradises," the former constructed by Shah Abbas I. (1578-1629), the latter by Shah Soliman in 1670, and restored and renovated by Fath Ali Shah (1797-1834). They are ornamented with gilding and mirrors in every possible variety of Arabesque decoration, and large and brilliant pictures, representing scenes of Persian history, cover the walls of their principal apartments and have been ascribed in many instances to Italian and Dutch artists who are known to have been in the service of the Sefavids. Attached to these palaces were many other buildings such as the Imaretino built by Amīn ed-Dowleh (or Addaula) for Fath Ali Shah, the Imaret i Ashref built by Ashraf Khan, the Afghan ushper, the Talār Tavleh, Guldaste, Sarpushdeh, &c., erected in the early part of the 19th century by wealthy courtiers for the convenience of the sovereign and often occupied as residences of European ministers travelling between Bushire and Teheran and by other distinguished travellers. Perhaps the most agreeable residence of all was the Hayt Dast, "the seven courts," in the beautiful garden of Saadetabad on the southern bank of the river, and 2 or 3 m. from the centre of the city. This palace was built by Shah Abbas II. (1642-1667), and Fath Ali Shah Kājār died there in 1834. Close to it was the Aineh Khaneh, "hall of mirrors" and other elegant buildings in the Ilazzerjerib (1000-acre) garden. All these palaces and buildings on both sides of the river were surrounded by extensive gardens, traversed by avenues of tall

trees, principally planes, and intersected by paved canals of running water with tanks and fountains. Since Fath Ali Shah's death, palaces and gardens have been neglected. In 1902 an official was sent from Teheran to inspect the crown buildings, to report on their condition, and repair and renovate some, &c. The result was that all the above-mentioned buildings, excepting the Chehel Sitūn and Hasht Behesht, were demolished and their timber, bricks, stone, &c., sold to local builders. The gardens are wildernesses. The garden of the Chehel Sitūn palace opens out through the Alā Kapū ("highest gate, sublime port") to the Maidān-i-Shah, which is one of the most imposing piazzas in the world, a parallelogram of 560 yds. (N.-S.) by 174 yds. (E.-W.) surrounded by brick buildings divided into two storeys of recessed arches, or arcades, one above the other. In front of these arcades grow a few stunted planes and poplars. On the south side of the maidan is the famous Masjed i Shah (the shah's mosque) erected by Shah Abbas I. in 1612-1613. It is covered with glazed tiles of great brilliancy and richly decorated with gold and silver ornaments and cost over £175,000. It is in good repair, and plans of it were published by C. Texier (*L'Arménie, la Perse*, &c., vol. i. pls. 70-72) and P. Coste (*Monuments de la Perse*). On the eastern side of the maidan stands the Masjed i Lutf Ullah with beautiful enamelled tiles and in good repair. Opposite to it on the western side of the maidan is the Alā Kapū, a lofty building in the form of an archway overlooking the maidan and crowned in the fore part by an immense open throne-room supported by wooden columns, while the hinder part is elevated three storeys higher. On the north side of the maidan is the entrance gate to the main bazaar surmounted by the Nekkāreh-Khaneh, or drumhouse, where is blared forth the appalling music saluting the rising and setting sun, said to have been instituted by Jamshīd many thousand years ago. West of the Chehel Sitūn palace and conducting N.-S. from the centre of the city to the great bridge of Allah Verdi Khan is the great avenue nearly a mile in length called Chahār Bagh, "the four gardens," recalling the fact that it was originally occupied by four vineyards which Shah Abbas I. rented at £360 a year and converted into a splendid approach to his capital.

It was thus described by Lord Curzon of Kedleston in 1880: "Of all the sights of Isfahān, this in its present state is the most pathetic in the utter and pitiless decay of its beauty. Let me indicate what it was and what it is. At the upper extremity a two-storied pavilion,<sup>2</sup> connected by a corridor with the Seraglio of the palace, so as to enable the ladies of the harem to gaze unobserved upon the merry scene below, looked out upon the centre of the avenue. Water, conducted in stone channels, ran down the centre, falling in miniature cascades from terrace to terrace, and was occasionally collected in great square or octagonal basins where cross roads cut the avenue. On either side of the central channel was a row of oriental planes and a paved pathway for pedestrians. Then occurred a succession of open *parterres*, usually planted or sown. Next on either side was a second row of planes, between which and the flanking walls was a raised causeway for horsemen. The total breadth is now fifty-two yards. At intervals corresponding with the successive terraces and basins, arched doorways with recessed open chambers overhead conducted through these walls into the various royal or noble gardens that stretched on either side, and were known as the Gardens of the Throne, of the Nightingale, of Vines, of Mulberries, Dervishes, &c. Some of these pavilions were places of public resort and were used as coffee-houses, where when the business of the day was over, the good burghers of Isfahān assembled to sip that beverage and inhale their *kalyans* the while; as Fryer puts it: 'Night drawing on, all the pride of Spahān was met in the Chaurbaug and the Grandes were Airing themselves, prancing about with their numerous Trains, striving to outvie each other in Pomp and Generosity.' At the bottom, quays lined the banks of the river, and were bordered with the mansions of the nobility."

Such was the Chahār Bagh in the plenitude of its fame. But now what a tragical contrast! The channels are empty, their stone borders crumbled and shattered, the terraces are broken down, the *parterres* are unsightly bare patches, the trees, all lopped and pollarded, have been chipped and hollowed out or cut down for fuel by the soldiery of the Zil, the side pavilions are abandoned and tumbling to pieces and the gardens are wildernesses. Two centuries of decay could never make the Champs Elysées in Paris, the Unter

<sup>1</sup> These figures are approximate for the centre of the town north of the river. The result of astronomical observations taken by the German expedition for observing the transit of Venus in 1874 and by Sir O. S. John in 1870 on the south bank of the river near, and in Julfa respectively was  $51^{\circ} 40' 34.5'' E.$ ,  $32^{\circ} 37' 30'' N.$  The stone slab commemorating the work of the expedition and placed on the spot where the observations were taken has been carried off and now serves as a door plinth of an Armenian house.

<sup>2</sup> This pavilion was the Persian telegraph office of Isfahān for nearly forty years and was demolished in 1903.

den Linden in Berlin, or Rotten Row in London, look one half as miserable as does the ruined avenue of Shah Abbas. It is in itself an epitome of modern Iran."

Towards the upper end of the avenue on its eastern side stands the medresseh (college) which Shah Hosain built in 1710. It still has a few students, but is very much out of repair; Lord Curzon spoke of it in 1838 as "one of the stateliest ruins that he saw in Persia." South of this college the avenue is altogether without trees, and the gardens on both sides have been turned into barley fields. Among the other notable buildings of Isfahān must be reckoned its five bridges, all fine structures, and one of them, the bridge of Allah Verdi Kahn, 388 yds. in length with a paved roadway of 30 ft. in breadth, is one of the stateliest bridges in the world, and has suffered little by the march of decay.

Another striking feature of Isfahān is the line of covered bazaars, which extends for nearly 3 m. and divides the city from south to north. The confluence of people in these bazaars is certainly very great, and gives an exaggerated idea of the populousness of the city, the truth being that while the inhabitants congregate for business in the bazaars, the rest of the city is comparatively deserted. When surveyed from a commanding height within the city, or in the immediate environs, the enormous extent of mingled garden and building, about 30 m. in circuit, gives an impression of populousness and busy life, but a closer scrutiny reveals that the whole scene is nothing more than a gigantic sham. With the exception of the bazaars and a few parishes there is really no continuous inhabited area. Whole streets, whole quarters of the city have fallen into utter ruin and are absolutely deserted, and the traveller who is bent on visiting some of the remarkable sites in the northern part of the city or in the western suburbs, such as the minarets dating from the 12th century, the remains of the famous castle of Tabarrak built by the Buyid Rukn-addaula (d. 976), the ruins of the old fire temple, the shaking minarets of Guladān, &c., has to pass through miles of crumbling mud walls and roofless houses. It is believed indeed that not a twentieth part of the area of the old city is at present peopled, and the million or 600,000 inhabitants of Chardin's time (middle of the 17th century) have now dwindled to about 85,000. The Armenian suburb of Julfa, at any rate, which contained a population of 30,000 souls in the 17th century, has now only 4,000, and the Christian churches, which numbered thirteen and were maintained with splendour, are now reduced to half a dozen edifices with bare walls and empty benches. Much improvement has recently taken place in the education of the young and also in their religious teaching, the wealthy Armenians of India and Java having liberally contributed to the national schools, and the Church Missionary Society of London having a church, schools and hospitals there since 1869.

The people of Isfahān have a very poor reputation in Persia either for courage or morals. They are regarded as a clever but at the same time dissolute and disorderly community, whose government requires a strong hand. The *lutis* (hooligans) of Isfahān are proverbial as the most turbulent and rowdy set of vagabonds in Persia. The priesthood of Isfahān are much respected for their learning and high character, and the merchants are a very respectable class. The commerce of Isfahān has greatly fallen off from its former flourishing condition, and it is doubtful whether the trade of former days can ever be restored. (A. H.-S.)

**History.**—The natural advantages of Isfahān—a genial climate, a fertile soil and abundance of water for irrigation—must have always made it a place of importance. In the most ancient cuneiform documents, referring to a period between 3000 and 2000 B.C., the province of *Anshan*, which certainly included Isfahān, was the limit of the geographical knowledge of the Babylonians, typifying the extreme east, as Syria (or *Maria-ki*) typified the west. The two provinces of *Anshan* and *Subaria*, by which we must understand the country from Isfahān to Shuster, were ruled in those remote ages by the same king, who undoubtedly belonged to the great Turanian family; and from this first notice of *Anshan* down to the 7th century B.C. the region seems to have remained, more or less, dependent on the paramount power of Susa. With regard to the eastern frontier of *Anshan*, however, ethnographical names were probably in extensive operation during this interval of twenty centuries. The western Iranians,

for instance, after separating from their eastern brethren on the Oxus, as early perhaps as 3000 B.C., must have followed the line of the Elburz mountains, and then bifurcating into two branches must have scattered, westward into Media and southward towards Persia. The first substantial settlement of the southern branch would seem then to have been at Isfahān, where *Jem*, the eponym of the Persian race, is said to have founded a famous castle, the remains of which are visible to the 19th century A.D. This name is known in the Zoroastrian writings as *Jemshid*, its proper name was *Sarū* or *Sarāk* (given in the Bundahish as *Sruva* or *Srohak*), and it was especially famous in early Mahomedan history as the building where the ancient records and tables of the Persians were discovered which proved so much use to Albunazar and his contemporaries. A valuable tradition, proceeding from quite a different source, has also been preserved to the effect that *Jem*, who invented the original Persian character, dwelt in Isfahān, a district of Shuster (see Flügel's *Fihrist*, p. 12, l. 21), which exactly accords with the Assyrian notices of Assan or Anshan classed as a dependency of Elymais. Now, it is well known that native legend represented the Persian race to have been held in bondage for a thousand years, after the reign of *Jem*, by the foreign usurper *Zohāk* or *Biverasp*, a period which may well represent the duration of Elymaean supremacy over the Aryans of Anshan. At the commencement of the 7th century B.C. Persia and Anshan are still found in the annals of Senacherib amongst the nations which he costerated against Assyria; but shortly afterwards the great Sasanian monarchy, which had lasted for (full 2000 years, crumbled away under continued pressure from the west, and the Aryans of Anshan recovered their independence, founding for the first time a national dynasty, and establishing their seat of government at Gabae on the site of the modern city of Isfahān.

The royal city of Gabae was known as a foundation of the Achaemenidae as late as the time of Strabo, and the inscriptions show that Achaemenes and his successors did actually rule at Anshan until the great Cyrus set out on his career of western victory. Whether the *Kābi* or *Kāvi* of tradition, the blacksmith of Isfahān, who is said to have headed the revolt against *Zohāk*, took his name from the town of Gabae may be open to question; but it is at any rate remarkable that the national standard of the Persian race, named after the blacksmith, and supposed to have been first unfurled at this epoch, retained the title of *Darōshah* or *Kāshin* (the banner of *Kāvi*) to the time of the Arab conquest, and that the men of Isfahān were, moreover, throughout this long period, always especially charged with its protection. The provincial name of Anshan or Assan seems to have been disused in the country after the age of Cyrus, and to have been replaced by that of Gabene or Gabiane, which alone appears in the Greek accounts of the wars of Alexander and his successors, and in the geographical descriptions of Strabo. Gabae or *Kāvi* became gradually corrupted to *Jai* during the Sassanian period, and it was this name which the men of Isfahān were, moreover, generally known by at the time of the Arab invasion. Subsequently the title of *Jai* became replaced by *Sheheristān* or *Medīneh*, "the city" *par excellence*, while a suburb which had been founded in the immediate vicinity, and which took the name of *Yahudeh*, or the "Jews' town," from its original Jewish inhabitants, gradually rose into notice and superseded the old capital.<sup>1</sup>

*Sheheristān* and *Yahudeh* are thus in the early ages of Islam described as independent cities, the former being the capital, and the latter the western division of the capital, each surrounded by a separate wall; but about the middle of the 10th century the famous Buyid king, known as the *Rukn-addaula* (*al-Dowleh*), united the two suburbs and many of the adjoining villages in one general enclosure which was about 10 m. in circumference. The city, which had now resumed its old name of Isfahān, continued to flourish till the time of Timur (A.D. 1387), when in common with so many other cities of the empire he was almost universally destroyed by the Tartar invaders. Timur indeed is said to have erected a *Kaleh* (Mehmet's "bell tower" of 70,000 heads at the gate of the city, as a warning to deter other communities from resisting his arms. The place, however, owing to its natural advantages, gradually recovered from the effects of this terrible visitation, and when the Safavid dynasty, who succeeded to power in the 16th century, transferred their place of residence to it from Kazvin, it rose rapidly in populousness and wealth, and the Shah Abbas, who reigned in the 17th century, the most illustrious sovereign of this house, that Isfahān attained its greatest prosperity. This monarch adopted every possible expedient, by instituting

<sup>1</sup> The name of *Yahudeh* or "Jews' town" is derived by the early Arab geographers from a colony of Jews who are said to have migrated from Babylonia to Isfahān shortly after the Nebuchadrezzar's capture of Jerusalem, but this is purely a tradition. The oldest mention really dates from the 3rd century A.D. as is shown by a notice in the Armenian history of Moses of Chorene, lib. iii. cap. 35. The name *Isfahān* has been generally compared with the *Aspadana* of Ptolemy in the extreme north of Persia, and the identification is probably correct. At any rate the title is of great antiquity being found in the Bundahish, and being derived in all likelihood from the family name of the race of *Pēriān*, the *Adhviān* of romance, who were a branch of the *Aspīyān* in Pahlavi, according to the phonetic rules of that language.





We may reasonably assume that the analogy drawn from the process of reproduction among men and animals led to the conception of a female deity presiding over the life of the universe. The extension of the scope of this goddess to life in general—to the growth of plants and trees from the fruitifying seed—was a natural outcome of a fundamental idea; and so, whether we turn to incantations or hymns, in myths and in epics, in votive inscriptions and in historical annals, Ishtar is celebrated and invoked as the great mother, as the mistress of lands, as clothed in splendour and power—one might almost say as the personification of life itself.

But there are two aspects to this goddess of life. She brings forth, she fertilizes the fields, she clothes nature in joy and gladness, but she also withdraws her favours and when she does so the fields wither, and men and animals cease to reproduce. In place of life, barrenness and death ensue. She is thus also a grim goddess, at once cruel and destructive. We can, therefore, understand that she was also invoked as a goddess of war and battles and of the chase; and more particularly among the warlike Assyrians she assumes this aspect. Before the battle she appears to the army, clad in battle array and armed with bow and arrow. In myths symbolizing the change of seasons she is portrayed in this double character, as the life-giving and the life-depriving power. The most noteworthy of these myths describes her as passing through seven gates into the nether world. At each gate some of her clothing and her ornaments are removed until at the last gate she is entirely naked. While she remains in the nether world as a prisoner—whether voluntary or involuntary it is hard to say—all fertility ceases on earth, but the time comes when she again returns to earth, and as she passes each gate the watchman restores to her what she had left there until she is again clad in her full splendour, to the joy of mankind and of all nature. Closely allied with this myth and personifying another view of the change of seasons is the story of Ishtar's love for Tammuz—symbolizing the spring time—but as midsummer approaches her husband is slain and, according to one version, it is for the purpose of saving Tammuz from the clutches of the goddess of the nether world that she enters upon her journey to that region.

In all the great centres Ishtar had her temples, bearing such names as E-anna, "heavenly house," in Erech; E-makh, "great house," in Babylon; E-mash-mash, "house of offerings," in Nineveh. Of the details of her cult we as yet know little, but there is no evidence that there were obscene rites connected with it, though there may have been certain mysteries introduced at certain centres which might easily impress the uninitiated as having obscene aspects. She was served by priestesses as well as by priests, and it would appear that the votaries of Ishtar were in all cases virgins who, as long as they remained in the service of Ishtar, were not permitted to marry.

In the astral-theological system, Ishtar becomes the planet Venus, and the double aspect of the goddess is made to correspond to the strikingly different phases of Venus in the summer and winter seasons. On monuments and seal-cylinders she appears frequently with bow and arrow, though also simply clad in long robes with a crown on her head and an eight-rayed star as her symbol. Statuettes have been found in large numbers representing her as naked with her arms folded across her breast or holding a child. The art thus reflects the popular conceptions formed of the goddess. Together with Sin, the moon-god, and Shamash, the sun-god, she is the third figure in a triad, a product of theological speculation—no thought of any particular locality for her cult is present. It is because her cult, like that of Sin (q.v.) and Shamash (q.v.), is spread over all Babylonia and Assyria, that she becomes available for purposes of theological speculation.

Cf. ASTARTE, ATARGATIS, GREAT MOTHER OF THE GODS, and especially BABYLONIAN AND ASSYRIAN RELIGION. (M. JA.)

**ISHTIB**, or **ISTIB** (anc. *Asitbon*, Slav. *Shtiplye* or *Shtip*), a town of Macedonia, European Turkey, in the vilayet of

Kosovo; 45 m. E.S.E. of Uskub. Pop. (1905) about 10,000. Ishtib is built on a hill at the confluence of the small river Ishtib with the Bregalnitzza, a tributary of the Vardar. It has a thriving agricultural trade, and possesses several fine mosques, a number of fountains and a large bazaar. A hill on the north-west is crowned by the ruins of an old castle.

**ISIDORE OF ALEXANDRIA**,<sup>1</sup> Greek philosopher and one of the last of the Neoplatonists, lived in Athens and Alexandria towards the end of the 5th century A.D. He became head of the school in Athens in succession to Marinus who followed Proclus. His views alienated the chief members of the school and he was compelled to resign his position to Hegias. He is known principally as the preceptor of Damascius whose testimony to him in the *Life of Isidorus* presents him in a very favourable light as a man and a thinker. It is generally admitted, however, that he was rather an enthusiast than a thinker; reasoning with him was subsidiary to inspiration, and he preferred the theories of Pythagoras and Plato to the unimagined logic and the practical ethics of the Stoics and the Aristotelians. He seems to have given loose rein to a sort of theosophical speculation and attached great importance to dreams and waking visions on which he used to expatiate in his public discourses.

Damascius' *Life* is preserved by Photius in the *Bibliotheca*, and the fragments are found in the Didot edition of Diogenes Laërtius. See Agathias, *Hist.* ii. 30; Photius, *Bibliotheca*, 181; and histories of Neoplatonism.

**ISIDORE OF SEVILLE**, or **ISIDORUS HISPALENSIS** (c. 560–636), Spanish encyclopaedist and historian, was the son of Severianus, a distinguished native of Cartagena, who came to Seville about the time of the birth of Isidore. Leander, bishop of Seville, was his elder brother. Left an orphan while still young, Isidore was educated in a monastery, and soon distinguished himself in controversies with the Arians. In 599, on the death of his brother, he was chosen archbishop of Seville, and acquired high renown by his successful administration of the episcopal office, as well as by his numerous theological, historical and scientific works. He founded a school at Seville, and taught in it himself. In the provincial and national councils he played an important part, notably at Toledo in 610, at Seville in 619 and in 633 at Toledo, which profoundly modified the organization of the church in Spain. His great work, however, was in another line. Profoundly versed in the Latin as well as in the Christian literature, his indefatigable intellectual curiosity led him to condense and reproduce in encyclopaedic form the fruit of his wide reading. His works, which include all topics—science, canon law, history or theology—are unsystematic and largely uncritical, merely reproducing at second hand the substance of such sources as were available. Yet in their inadequate way they served to keep alive throughout the dark ages some little knowledge of the antique culture and learning. The most elaborate of his writings is the *Originum sive etymologiarum libri XX*. It was the last of his works, written between 622 and 633, and was corrected by his friend and disciple Braulion. It is an encyclopaedia of all the sciences, under the form of an explanation of the terms proper to each of them. It was one of the capital books of the middle ages.

On the *Libri differentiarum sive de proprietate sermonum*—of which the first book is a collection of synonyms, and the second of explanations of metaphysical and religious ideas—see A. Macé's *Historical Dissertation*, Rennes, 1900. Mommsen has edited the *Chronica majora* or *Chronicon de rege aethiopia* (from the creation to A.D. 615) and the "Historia Gothorum, Wandalorum, Sueborum;" in the *Monumenta Germaniae historica, auctores inaequissimi*; *Chronica minor II*. The history of the Goths is a historical source of the first order. The *De scriptoribus ecclesiasticis* or better *De viris illustribus*, was a continuation of the work of St. Jerome and of Genadius (cf. G. von Dzialowski in *Kirchengeschichtliche Studien*, iv. (1899)). Especially interesting is the *De natura rerum ad Sisibutum*.

<sup>1</sup> With Isidore of Alexandria has been confused an Isidore of Gaza, mentioned by Photius. Little is known of him except that he was one of those who accompanied Damascius to the Persian court when Justinian closed the schools in Athens in 529. Suidas, in speaking of Isidore of Alexandria, says that Hypatia was his wife, but there is no means of approximating the dates (see HYPATIA). Suetonius, in his *Life of Nero*, refers to a Cynic philosopher named Isidore, who is said to have jested publicly at the expense of Nero.

regem, a treatise on astronomy and meteorology, which contained the sum of physical philosophy during the early middle ages. The *Regula monachorum* of Isidore was adopted by many of the monasteries in Spain during the 7th and 8th centuries. The collection of canons known as the *Isidoriana* or *Hispalensis* is not by him, and the following, attributed to him, are of doubtful authenticity: *De ortu ac obitu patrum qui in Scriptura laudibus efferuntur; Allegoriae scripturae sacrae et liber numerorum; De ordine creaturarum.*

The edition of all of Isidore's works by F. Orevalo (Rome, 1797-1803, 7 vols.), reproduced in Migne, *Patrologia Latina*, 81-84, is carefully edited. See also C. Canal, *San Isidoro, exposicion de sus obras e indicaciones a cerca de la influencia que han ejercido en la civilizacion española* (Seville, 1897). A list of monographs is in the *Bibliographie* of Ulysse Chevalier.

**ISINGLASS** (probably a corruption of the Dutch *huisenblas*, Ger. *Hausenblase*, literally "sturgeon's bladder"), a pure form of commercial gelatin obtained from the swimming bladder or sound of several species of fish. The sturgeon is the most valuable, various species of which, especially *Acipenser stellatus* (the seauraga), *A. ruthenus* (the sterlet) and *A. güldenstädtii* (the ossétr), flourish in the Volga and other Russian rivers, in the Caspian and Black Seas, and in the Arctic Ocean, and yield the "Russian isinglass"; a large fish, *Silurus parkerii*, and probably some other fish, yield the "Brazilian isinglass"; other less definitely characterized fish yield the "Penang" product; while the common cod, the hake and other *Gadidae* also yield a variety of isinglass. The sounds, having been removed from the fish and cleansed, undergo no other preparation than desiccation or drying, an operation needing much care; but in this process the sounds are subjected to several different treatments. If the sound be unopened the product appears in commerce as "pipe," "purse" or "lump isinglass"; if opened and unfolded, as "leaf" or "honeycomb"; if folded and dried, as "book," and if rolled out, as "ribbon isinglass." Russian isinglass generally appears in commerce as leaf, book, and long and short staple; Brazilian isinglass, from Para and Maranham, as pipe, lump and honeycomb; the latter product, and also the isinglass of Hudson's Bay, Penang, Manila, &c., is darker in colour and less soluble than the Russian product.

The finest isinglass, which comes from the Russian ports of Astrakhan and Taganrog, is prepared by steeping the sounds in hot water in order to remove mucus, &c.; they are then cut open and the inner membrane exposed to the air; after drying, the outer membrane is removed by rubbing and beating. As imported, isinglass is usually too tough and hard to be directly soaked. To increase its availability, the raw material is sorted, soaked in water till it becomes flexible and then trimmed; the trimmings are sold as a lower grade. The trimmed sheets are sometimes passed between steel rollers, which reduce them to the thickness of paper; it then appears as a transparent ribbon, "shot" like watered silk. The ribbon is dried, and, if necessary, cut into strips.

The principal use of isinglass is for clarifying wines, beers and other liquids. This property is the more remarkable since it is not possessed by ordinary gelatin; it has been ascribed to its fibrous structure, which forms, as it were, a fine network in the liquid in which it is disseminated, and thereby mechanically carries down all the minute particles which occasion the turbidity. The cheaper varieties are more commonly used; many brewers prefer the Penang product; Russian leaf, however, is used by some Scottish brewers; and Russian long staple is used in the Worcestershire cider industry. Of secondary importance is its use for culinary and confectionery purposes, for example, in making jellies, stiffening jams, &c. Here it is often replaced by the so-called "patent isinglass," which is a very pure gelatin, and differs from natural isinglass by being useless for clarifying liquids. It has few other applications in the arts. Mixed with gum, it is employed to give a lustre to ribbons and silk; incorporated with water, Spanish liquorice and lamp black it forms an Indian ink; a solution, mixed with a little tincture of benzoin, brushed over sarsenet and allowed to dry, forms the well-known "court plaster." Another plaster is obtained by adding acetic acid and a little otto of roses to the solution; it also has valuable agglutinating properties; by

dissolving in two parts of pure alcohol it forms a diamond cement, the solution cooling to a white, opaque, hard solid; it also dissolves in strong acetic acid to form a powerful cement, which is especially useful for repairing glass, pottery and like substances.

**ISIS** (Egyptian *Ëse*), the most famous of the Egyptian goddesses. She was of human form, in early times distinguished

only by the hieroglyph of her name  upon her head. Later she commonly wore the horns of a cow, and the cow was sacred to her; it is doubtful, however, whether she had any animal representation in early times, nor had she possession of any considerable locality until a late period, when Philae, Behbët and other large temples were dedicated to her worship. Yet she was of great importance in mythology, religion and magic, appearing constantly in the very ancient Pyramid texts as the devoted sister-wife of Osiris and mother of Horus. In the divine genealogies she is daughter of Keb and Nut (earth and sky). She was supreme in magical power, cunning and knowledge. A legend of the New Kingdom tells how she contrived to learn the all-powerful hidden name of Re' which he had confided to no one. A snake which she had fashioned for the purpose stung the god, who sent for her as a last resort in his unendurable agony; whereupon she represented to him that nothing but his own mysterious name could overcome the venom of the snake. Much Egyptian magic turns on the healing or protection of Horus by Isis, and it is chiefly from magical texts that the myth of Isis and Osiris as given by Plutarch can be illustrated. The Metternich stela (XXXth Dynasty), the finest example of a class of prophylactic stelae generally known by the name of "Horus on the crocodiles," is inscribed with a long text relating the adventures of Isis and Horus in the marshes of the Delta. With her sister Nephthis, Isis is frequently represented as watching the body of Osiris or mourning his death.

Isis was identified with Demeter by Herodotus, and described as the goddess who was held to be the greatest by the Egyptians; he states that she and Osiris, unlike other deities, were worshipped throughout the land. The importance of Isis had increased greatly since the end of the New Kingdom. The great temple of Philae was begun under the XXXth Dynasty; that of Behbët seems to have been built by Ptolemy II. The cult of Isis spread into Greece with that of Serapis early in the 3rd century B.C. In Egypt itself Isea, or shrines of Isis, swarmed. At Coptos Isis became a leading divinity on a par with the early god Min. About 80 B.C. Sulla founded an Isiac college in Rome, but their altars within the city were overthrown by the consuls no less than four times in the decade from 58 to 48 B.C., and the worship of Isis at Rome continued to be limited or suppressed by a succession of enactments which were enforced until the reign of Caligula. The Isiac mysteries were a representation of the chief events in the myth of Isis and Osiris—the murder of Osiris, the lamentations of Isis and her wanderings, followed by the triumph of Horus over Seth and the resurrection of the slain god—accompanied by music and an exposition of the inner meaning of the spectacle. These were traditional in ancient Egypt, and in their later development were no doubt affected by the Eleusinian mysteries of Demeter. They appealed powerfully to the imagination and the religious sense. The initiated went through rites of purification, and practised a degree of asceticism; but for many the festival was believed to be an occasion for dark orgies. Isis nursing the child Horus (*Harpokhrates*) was a very common figure in the Deltaic period, and in these later days was still a favourite representation. The Isis temples discovered at Pompeii and in Rome show that ancient monuments as well as objects of small size were brought from Egypt to Italy for dedication to her worship, but the goddess absorbed the attributes of all female divinities; she was goddess of the earth and its fruits, of the Nile, of the sea, of the underworld, of love, healing and magic. From the time of Vespasian onwards the worship of Isis, always popular with some sections, had a great vogue throughout the western world, and is not without traces in Britain. It proved the most successful

of the pagan cults in maintaining itself against Christianity, with which it had not a little in common, both in doctrine and in emblems. But the destruction of the Serapeum at Alexandria in A.D. 397 was a fatal blow to the prestige of the Graeco-Egyptian divinities. The worship of Isis, however, survived in Italy into the 5th century. At Philae her temple was frequented by the barbarous Nobatae and Blemmyes until the middle of the 6th century, when the last remaining shrine of Isis was finally closed.

See G. Lafaye, art. "Isis" in Daremberg et Saglio, *Dictionnaire des antiquités* (1909); id. *Hist. du culte des divinités d'Alexandrie hors de l'Égypte* (1883); Meyer and Drexler, art. "Isis" in *Röscher's Lexikon der griech. und röm. Mythologie* (1891-1892) (very elaborate); E. A. W. Budge, *Gods of the Egyptians*, vol. II, ch. xiii.; Ad. Rusch, *De Serapide et Iside in Graecia cultis* (dissertation) (Berlin, 1906). (The author especially collects the evidence from Greek inscriptions earlier than the Roman conquest; he contends that the mysteries of Isis were not equated with the Eleusinian mysteries.) (F. L. G.)

**ISKELIB**, the chief town of a *Casa* (governed by a *hakimam*) in the vilayet of Angora in Asia Minor, altitude 2460 ft., near the left bank of the Kizil Irmak (anc. *Halyis*), 100 m. in an air-line N.E. of Angora and 60 S.E. of Kastamuni (to which vilayet it belonged till 1894). Pop. 10,600 (Cuinet, *La Turquie d'Asie*, 1894). It lies several miles off the road, now abandoned by wheeled traffic, between Changra and Amasia in a picturesque *cul de sac* amongst wooded hills, at the foot of a limestone rock crowned by the ruins of an ancient fortress now filled with houses (photograph in Anderson, *Studia Pontica*, p. 4). Its ancient name is uncertain. Near the town (on S.) are saline springs, whence salt is extracted.

**ISLA, JOSÉ FRANCISCO DE** (1703-1781), Spanish satirist, was born at Villavides (León) on the 24th of March 1703. He joined the Jesuits in 1719, was banished from Spain with his brethren in 1767, and settled at Bologna, where he died on the 2nd of November 1781. His earliest publication, a *Carta de un residente en Roma* (1725), is a panegyric of trifling interest, and *La Juventud triunfante* (1727) was written in collaboration with Luis de Lovada. Isla's gifts were first shown in his *Triunfo del amor y de la lealtad: dia Grande de Navarra*, a satirical description of the ceremonies at Pamplona in honour of Ferdinand VI.'s accession; its sly humour so far escaped the victims that they thanked the writer for his appreciation of their local efforts, but the true significance of the work was discovered shortly afterwards, and the protests were so violent that Isla was transferred by his superiors to another district. He gained a great reputation as an effective preacher, and his posthumous *Sermones morales* (1792-1793) justify his fame in this respect. But his position in the history of Spanish literature is due to his *Historia del famoso predicador fray Gerundio de Campazas, alias Zotes* (1758), a novel which wittily caricatures the bombastic eloquence of pulpit orators in Spain. Owing to the protests of the Dominicans and other regulars, the book was prohibited in 1760, but the second part was issued surreptitiously in 1768. He translated *Gil Blas*, adopting more or less seriously Voltaire's unfounded suggestion that Le Sage plagiarized from Espinel's *Marcos de Obregón*, and other Spanish books; the text appeared in 1783, and in 1828 was greatly modified by Evaristo Peña y Martín, whose arrangement is still widely read.

See Policarpo Mingote y Tarrazona, *Varones ilustres de la provincia de León* (León, 1880), pp. 185-215; Bernard Gaudau, *Les Prêcheurs bordelais en Espagne au XVIII<sup>e</sup> siècle* (Paris, 1891); V. Cian, *L'Immigrazione dei Gesuiti spagnuoli letterati in Italia* (Torino, 1895). (J. F.-K.)

**ISLAM**, an Arabic word meaning "pious submission to the will of God," the name of the religion of the orthodox Mahomedans, and hence used, generically, for the whole body of Mahomedan peoples. *Salaam*, from which the word is derived appears in *salaam*, "peace be with you," the greeting of the East, and in Moslem, and means to be "free" or "secure." (See MAHOMMEDAN RELIGION, &c.)

**ISLAMABAD**, a town of India in the state of Kashmir, on the north bank of the Jhelum. Pop. (1901) 9390. The town crowns the summit of a long low ridge, extending from the mountains eastward. It is the second town in Kashmir, and

was originally the capital of the valley, but is now decaying. It contains an old summer palace, overshadowed by plane trees, with numerous springs, and a fine mosque and shrine. Below the town is a reservoir containing a spring of clear water called the *Anant Nag*, slightly sulphurous, from which volumes of gas continually arise; the water swarms with sacred fish. There are manufactures of Kashmir shawls, also of chintzes, cotton and woollen goods.

**ISLAND** (O.E. *ieg* = isle, +land<sup>1</sup>), in physical geography a term generally definable as a piece of land surrounded by water. Islands may be divided into two main classes, continental and oceanic. The former are such as would result from the submergence of a coastal range, or a coastal highland, until the mountain bases were cut off from the mainland while their summits remained above water. The island may have been formed by the sea cutting through the landward end of a peninsula, or by the eating back of a bay or estuary until a portion of the mainland is detached and becomes surrounded by water. In all cases where the continental islands occur, they are connected with the mainland by a continental shelf, and their structure is essentially that of the mainland. The islands off the west coast of Scotland and the Isles of Man and Wight have this relation to Britain, while Britain and Ireland have a similar relation to the continent of Europe. The north-east coast of Australia furnishes similar examples, but in addition to these in that locality there are true oceanic islands near the mainland, formed by the growth of the Great Barrier coral reef. Oceanic islands are due to various causes. It is a question whether the numberless islands of the Malay Archipelago should be regarded as continental or oceanic, but there is no doubt that the South Sea islands scattered over a portion of the Pacific belong to the oceanic group. The ocean floor is by no means a level plain, but rises and falls in mounds, eminences and basins towards the surface. When this configuration is emphasized in any particular oceanic area, so that a peak rises above the surface, an oceanic island is produced. Submarine volcanic activity may also raise material above sea-level, or the buckling of the ocean-bed by earth movements may have a similar result. Coral islands (see ATOLL) are oceanic islands, and are frequently clustered upon plateaux where the sea is of no great depth, or appear singly as the crown of some isolated peak that rises from deep water.

Island life contains many features of peculiar interest. The sea forms a barrier to some forms of life but acts as a carrier to other colonizing forms that frequently develop new features in their isolated surroundings where the struggle for existence is greater or less than before. When a sea barrier has existed for a very long time there is a marked difference between the fauna and flora even of adjacent islands. In Bali and Borneo, for example, the flora and fauna are Asiatic, while in Lombok and Celebes they are Australian, though the Bali Straits are very narrow. In Java and Sumatra, though belonging to the same group, there are marked developments of bird life, the peacock being found in Java and the Argus pheasant in Sumatra, having become too specialized to migrate. The Cocos, Keeling Islands and Christmas Island in the Indian Ocean have been colonized by few animal forms, chiefly sea-birds and insects, while they are clothed with abundant vegetation, and the seeds of which have been carried by currents and by other means, but the variety of plants is by no means so great as on the mainland. Island life, therefore, is a sure indication of the origin of the island, which may be one of the remnants of a shattered or dissected continent, or may have arisen independently from the sea and become afterwards colonized by drift.

The word "island" is sometimes used for a piece of land cut off by the tide or surrounded by marsh (e.g. Hayling Island).

<sup>1</sup> The O.E. *ieg*, *ig*, still appearing in local names, e.g. Anglesey, Batterssea, is cognate with Norw. *øy*, Icel. *ey*, and the first part of Ger. *Eiland*, &c.; it is referred to the original Teut. *ahwaga*, a place in water, *ahwa*, water, cf. Lat. *agua*; the same word is seen in English "eyes," "ait," an islet in a river. The spelling "island," accepted before 1700, is due to a false connexion with "isle," Fr. *île*, Lat. *insula*.

**ISLAY**, the southernmost island of the Inner Hebrides, Argyllshire, Scotland, 16 m. W. of Kintyre and  $\frac{1}{2}$  m. S.W. of Jura, from which it is separated by the Sound of Islay. Pop. (1901) 6857; area, 150,400 acres; maximum breadth 19 m. and maximum length 25 m. The sea-lochs Gruinart and Inaal cut into it so deeply as almost to convert the western portion into a separate island. It is rich and productive, and has been called the "Queen of the Hebrides." The surface generally is regular, the highest summits being Ben Bheigeir (1600 ft.) and Sgorr nam Faoileann (1407 ft.). There are several freshwater lakes and streams, which provide good fishing. Islay was the ancient seat of the "lord of the Isles," the first to adopt that title being John Macdonald of Isle of Islay, who died about 1386; but the Macdonalds were ultimately ousted by their rivals, the Campbells, about 1616. Islay House, the ancient seat of the Campbells of Islay, stands at the head of Loch Inaal. The island was formerly occupied by small crofters and tacksmen, but since 1831 it has been gradually developed into large sheep and arable farms and considerable business is done in stock-raising. Dairy-farming is largely followed, and oats, barley and various green crops are raised. The chief difficulty in the way of reclamation is the great area of peat (60 sq. m.), which, at its present rate of consumption, is calculated to last 1500 years. The island contains several whisky distilleries, producing about 400,000 gallons annually. Slate and marble are quarried, and there is a little mining of iron, lead and silver. At Bowmore, the chief town, there is a considerable shipping trade. Port Ellen, the principal village, has a quay with lighthouse, a fishery and a golf-course. Port Askaig is the ferry station for Faolin on Jura. Regular communication with the Clyde is maintained by steamers, and a cable was laid between Lagavulin and Kintyre in 1871.

**ISLES OF THE BLEST, or FORTUNATE ISLANDS** (Gr. *ai tōn μακάρων νήσοι*: Lat., Fortunatæ Insulæ), in Greek mythology a group of islands near the edge of the Western Ocean, peopled not by the dead, but by mortals upon whom the gods had conferred immortality. Like the islands of the Phæacians in Homer (*Od.* viii.) or the Celtic Avalon and St Brendan's island, the Isles of the Blest are represented as a land of perpetual summer and abundance of all good things. No reference is made to them by Homer, who speaks instead of the Elysian Plain (*Od.* iv. and ix.), but they are mentioned by Hesiod (*Works and Days*, 168) and Pindar (*Ol.* ii.). A very old tradition suggests that the idea of such an earthly paradise was a reminiscence of some unrecorded voyage to Madeira and the Canaries, which are sometimes named Fortunatæ Insulæ by medieval map-makers. (See ATLANTIS.)

**ISLINGTON** (in Domesday and later documents *Iseldon, Isendon* and in the 16th century *Hisselton*), a northern metropolitan borough of London, England, bounded E. by Stoke Newington and Hackney, S. by Shoreditch and Finsbury, and W. by St Pancras, and extending N. to the boundary of the county of London. Pop. (1901) 334,991. The name is commonly applied to the southern part of the borough, which, however, includes the districts of Holloway in the north, Highbury in the east, part of Kingsland in the south-east, and Barnsbury and Canonbury in the south-central portion. The districts included preserve the names of ancient manors, and in Canonbury, which belonged as early as the 13th century to the priory of St Bartholomew, Smithfield, traces of the old manor house remain. The fields and places of entertainment in Islington were favourite places of resort for the citizens of London in the 17th century and later; the modern Ball's Pond Road recalls the sport of duck-hunting practised here and on other ponds in the parish, and the popularity of the place was increased by the discovery of chalybeate wells. At Copenhagen Fields, now covered by the great cattle market (1855) adjoining Caledonian Road, a great meeting of labourers was held in 1834. They were suspected of intending to impose their views on parliament by violence, but a display of military force held them in check. The most noteworthy modern institutions in Islington are the Agricultural Hall, Liverpool Road, erected in 1862, and used for cattle and horse shows and other exhibitions; Pentonville

Prison, Caledonian Road (1842), a vast pile of buildings radiating from a centre, and Holloway Prison. The borough has only some 40 acres of public grounds, the principal of which is Highbury Fields. Among its institutions are the Great Northern Central Hospital, Holloway, the London Fever Hospital, the Northern Polytechnic, and the London School of Divinity, St John's Hall, Highbury. Islington is a suffragan bishopric in the diocese of London. The parliamentary borough of Islington has north, south, east and west divisions, each returning one member. The borough council consists of a mayor, 10 aldermen and 60 councillors. Area, 3091.5 acres.

**ISLIP**, a township of Suffolk county, New York, U.S.A., in the central part of the S. side of Long Island. Pop. (1905, state census) 13,721; (1910) 18,346. The township is 16 m. long from E. to W., and 8 m. wide in its widest part. It is bounded on the S. by the Atlantic Ocean; between the ocean and the Great South Bay, here 5.7 m. wide, is a long narrow strip of beach, called Fire Island, at the W. end of which is Fire Island Inlet. The "Island" beach and the Inlet, both very dangerous for shipping, are protected by the Fire Island Lighthouse, the Fire Island Lightship, and a Life Saving Station near the Lighthouse and another at Point o' Woods. Near the Lighthouse there are a United States Wireless Telegraph Station and a station of the Western Union Telegraph Company, which announces to New York incoming steamships; and a little farther E., on the site formerly occupied by the Surf House, a well-known resort for hay-fever patients, is a state park. Along the "Island" beach there is excellent surf-bathing. The township is served by two parallel branches of the Long Island railroad about 4 m. apart. On the main (northern) division are the villages of Brentwood (first settled as Modern Times, a quasi free-love community), which now has the Convent and School of St Joseph and a large private sanitarium; Central Islip, the seat of the Central Islip State Hospital for the Insane; and Ronkonkoma, on the edge of a lake of the same name (with no visible outlet or inlet and suffering remarkable changes in area). On the S. division of the Long Island railroad are the villages of Bay Shore (to the W. of which is West Islip); Oakdale; West Sayville, originally a Dutch settlement; Sayville and Bayport. The "South Country Road" of crushed clam or oyster shells runs through these villages, which are famous for oyster and clam fisheries. About one-half of the present township was patented in 1684, 1686, 1688 and 1697 by William Nicolls (1657-1723), the son of Matthias Nicolls, who came from Islip in Oxfordshire, England; this large estate (on either side of the Connetquot or Great river) was kept intact until 1786; the W. part of Islip was mostly included in the Moubray patent of 1708; and the township was incorporated in 1710.

**ISLY**, the name of a small river on the Moroccan-Algerian frontier, a sub-tributary of the Tafna, famous as the scene of the greatest victory of the French army in the Algerian wars. The intervention of Morocco on the side of Abd-el-Kader led at once to the bombardment of Tangier by the French fleet under the prince de Joinville, and the advance of the French army of General Bugeaud (1844). The enemy, 45,000 strong, was found to be encamped on the Isly river near Kudiat-el-Khodra. Bugeaud disposed of some 6500 infantry and 1500 cavalry, with a few pieces of artillery. In his own words, the formation adopted was "a boar's head." With the army were Lamoricière, Péliissier and other officers destined to achieve distinction. On the 14th of August the "boar's head" crossed the river about 9 m. to the N.W. of Kudiat and advanced upon the Moorish camp; it was immediately attacked on all sides by great masses of cavalry; but the volleys of the steady French infantry broke the force of every charge, and at the right moment the French cavalry in two bodies, each of the strength of a brigade, broke out and charged. One brigade stormed the Moorish camp (near Kudiat) in the face of artillery fire, the other sustained a desperate conflict on the right wing with a large body of Moorish horse which had not charged; and only the arrival of infantry put an end to the resistance in this quarter. A general rally of the Moorish forces was followed by another action in which

they endeavoured to retake the camp. Bugeaud's forces, which had originally faced S. when crossing the river, had now changed direction until they faced almost W. Near Kudiat-el-Khodra the Moors had rallied in considerable force, and prepared to retake their camp. The French, however, continued to attack in perfect combination, and after a stubborn resistance the Moors once more gave way. For this great victory, which was quickly followed by proposals of peace, Bugeaud was made duc d'Isly.

**ISMAIL** (1830-1895), khedive of Egypt, was born at Cairo on the 31st of December 1830, being the second of the three sons of Ibrahim and grandson of Mehemet Ali. After receiving a European education at Paris, where he attended the *École d'État-Major*, he returned home, and on the death of his elder brother became heir to his uncle, Saïd Mohammed, the Vali of Egypt. Saïd, who apparently conceived his own safety to lie in ridding himself as much as possible of the presence of his nephew, employed him in the next few years on missions abroad, notably to the pope, the emperor Napoleon III. and the sultan of Turkey. In 1861 he was despatched at the head of an army of 14,000 to quell an insurrection in the Sudan, and this he successfully accomplished. On the death of Saïd, on 18th January 1863, Ismail was proclaimed viceroy without opposition. Being of an Orientaly extravagant disposition, he found with considerable gratification that the Egyptian revenue was vastly increased by the rise in the value of cotton which resulted from the American Civil War, the Egyptian crop being worth about £25,000,000 instead of £5,000,000. Besides acquiring luxurious tastes in his sojourns abroad, Ismail had discovered that the civilized nations of Europe made a free use of their credit for raising loans. He proceeded at once to apply this idea to his own country by transferring his private debts to the state and launching out on a grand scale of expenditure. Egypt was in his eyes the ruler's estate which was to be exploited for his benefit and his renown. His own position had to be strengthened, and the country provided with institutions after European models. To these objects Ismail applied himself with energy and cleverness, but without any stint of expense. During the 'sixties and 'seventies Egypt became the happy hunting-ground of self-seeking financiers, to whose schemes Ismail fell an easy and a willing prey. In 1866-1867 he obtained from the sultan of Turkey, in exchange for an increase in the tribute, firms giving him the title of khedive, and changing the law of succession to direct descent from father to son; and in 1873 he obtained a new firman making him to a large extent independent. He projected vast schemes of internal reform, remodelling the customs system and the post office, stimulating commercial progress, creating a sugar industry, introducing European improvements into Cairo and Alexandria, building palaces, entertaining lavishly and maintaining an opera and a theatre. It has been calculated that, of the total amount of debt incurred by Ismail for his projects, about 10% may have been sunk in works of permanent utility—always excluding the Suez Canal. Meanwhile the opening of the Canal had given him opportunities for asserting himself in foreign courts. On his accession he refused to ratify the concessions to the Canal company made by Saïd, and the question was referred in 1864 to the arbitration of Napoleon III., who awarded £3,800,000 to the company as compensation for the losses they would incur by the changes which Ismail insisted upon in the original grant. Ismail then used every available means, by his own undoubted powers of fascination and by judicious expenditure, to bring his personality before the foreign sovereigns and public, and he had no little success. He was made G.C.B. in 1867, and in the same year visited Paris and London, where he was received by Queen Victoria and welcomed by the lord mayor; and in 1869 he again paid a visit to England. The result was that the opening of the Canal in November 1869 enabled him to claim to rank among European sovereigns, and to give and receive royal honours: this excited the jealousy of the sultan, but Ismail was clever enough to pacify his overlord. In 1876 the old system of consular jurisdiction for foreigners was modified, and the system of mixed courts introduced, by which European and native judges sat together to try all civil

cases without respect of nationality. In all these years Ismail had governed with *éclat* and profusion, spending, borrowing, raising the taxes on the fellahin and combining his policy of independence with dazzling visions of Egyptian aggrandizement. In 1874 he annexed Darfur, and was only prevented from extending his dominion into Abyssinia by the superior fighting power of the Abyssinians. But at length the inevitable financial crisis came. A national debt of over one hundred millions sterling (as opposed to three millions when he became viceroy) had been incurred by the khedive, whose fundamental idea of liquidating his borrowings was to borrow at increased interest. The bond-holders became restive. Judgments were given against the khedive in the international tribunals. When he could raise no more loans he sold his Suez Canal shares (in 1875) to Great Britain for £3,976,582; and this was immediately followed by the beginning of foreign intervention. In December 1875 Mr Stephen Cave was sent out by the British government to inquire into the finances of Egypt, and in April 1876 his report was published, advising that in view of the waste and extravagance it was necessary for foreign Powers to interfere in order to restore credit. The result was the establishment of the *Caisse de la Dette*. In October Mr (afterwards Lord) Goschen and M. Joubert made a further investigation, which resulted in the establishment of Anglo-French control. A further commission of inquiry by Major Baring (afterwards Lord Cromer) and others in 1878 culminated in Ismail making over his estates to the nation and accepting the position of a constitutional sovereign, with Nubar as premier, Mr (afterwards Sir Charles) Rivers Wilson as finance minister, and M. de Blignières as minister of public works. Ismail professed to be quite pleased. "Egypt," he said, "is no longer in Africa; it is part of Europe." The new régime, however, only lasted six months, and then Ismail dismissed his ministers, an occasion being deliberately prepared by his getting Arabi (*q.v.*) to foment a military *pronunciamento*. England and France took the matter seriously, and insisted (May 1879) on the reinstatement of the British and French ministers; but the situation was no longer a possible one; the tribunals were still giving judgments for debt against the government, and when Germany and Austria showed signs of intending to enforce execution, the governments of Great Britain and France perceived that the only chance of setting matters straight was to get rid of Ismail altogether. He was first advised to abdicate, and a few days afterwards (26th June), as he did not take the hint, he received a telegram from the sultan (who had not forgotten the earlier history of Mehemet Ali's dynasty), addressed to him as ex-khedive, and informing him that his son Tewfik was his successor. He at once left Egypt for Naples, but eventually was permitted by the sultan to retire to his palace of Emirghian on the Bosphorus. There he remained, more or less a state prisoner, till his death on the 2nd of March 1895. Ismail was a man of undoubted ability and remarkable powers. But beneath a veneer of French manners and education he remained throughout a thorough Oriental, though without any of the moral earnestness which characterizes the better side of Mahomedanism. Some of his ambitions were not unworthy, and though his attitude towards western civilization was essentially cynical, he undoubtedly helped to make the Egyptian upper classes realize the value of European education. Moreover, spendthrift as he was, it needed—as is pointed out in Milner's *England in Egypt*—a series of unfortunate conditions to render his personality as pernicious to his country as it actually became. "It needed a nation of submissive slaves, not only bereft of any vestige of liberal institutions, but devoid of the slightest spark of the spirit of liberty. It needed a bureaucracy which it would have been hard to equal for its combination of cowardice and corruption. It needed the whole gang of swindlers—mostly European—by whom Ismail was surrounded." It was his early encouragement of Arabi, and his introduction of swarms of foreign concession-hunters, which precipitated the "national movement" that led to British occupation. His greatest title to remembrance in history must be that he made European intervention in Egypt compulsory.

**ISMAIL HADJI MAULVI-MOHAMMED** (1781-1831), Mussulman reformer, was born at Pholah near Delhi. In co-operation with Syed Ahmed he attempted to free Indian Mahomedanism from the influence of the native early Indian faiths. The two men travelled extensively for many years and visited Mecca. In the Wahhabite movement they found much that was akin to their own views, and on returning to India preached the new doctrine of a pure Islam, and gathered many adherents. The official Mahomedan leaders, however, regarded their propaganda with disfavour, and the dispute led to the reformers being interdicted by the British government in 1827. The little company then moved to Punjab where, aided by an Afghan chief, they declared war on the Sikhs and made Peshawar the capital of the theocratic community which they wished to establish (1829). Deserted by the Afghans they had to leave Peshawar, and Ismail Hadji fell in battle against the Sikhs amid the Pakhli mountains (1831). The movement survived him, and some adherents are still found in the mountains of the north-west frontier.

Ismail's book *Taqauyat el Imān* was published in Hindustani and translated in the *Journal of the Royal Asiatic Society*, xiii. 1852.

**ISMAILIA**, a town of Lower Egypt, the central station on the Suez Canal, on the N.W. shore of Lake Timsa, about 50 m. from the Mediterranean and the Red Sea, and 93 m. N.E. of Cairo by rail. Pop. (1907) 10,373. It was laid out in 1863, in connexion with the construction of the canal, and is named after the khedive Ismail. It is divided into two quarters by the road leading from the landing-place to the railway station, and has numerous public offices, warehouses and other buildings, including a palace of the khedive, used as a hospital during the British military operations in 1882, but subsequently allowed to fall into a dilapidated condition. The broad macadamized streets and regular squares bordered with trees give the town an attractive appearance; and it has the advantage, a rare one in Egypt, of being surrounded on three sides by flourishing gardens. The Quai Mehemet Ali, which lies along the canal for upwards of a mile, contains the châlet occupied by Ferdinand de Lesseps during the building of the canal. At the end of the quay are the works for supplying Port Said with water. On the other side of the lake are the so-called Quarries of the Hyenas, from which the building material for the town was obtained.

**ISMAÏ, THOMAS HENRY** (1837-1899), British shipowner, was born at Maryport, Cumberland, on the 7th of January 1837. He received his education at Croft House School, Carlisle, and at the age of sixteen was apprenticed to Messrs Imrie & Tomlinson, shipowners and brokers, of Liverpool. He then travelled for a time, visiting the ports of South America, and on returning to Liverpool started in business for himself. In 1867 he took over the White Star line of Australian clippers, and in 1868, perceiving the great future which was open to steam navigation, established, in conjunction with William Imrie, the Oceanic Steam Navigation Company, which has since become famous as the White Star Line. While continuing the Australian service, the firm determined to engage in the American trade, and to that end ordered from Messrs Harland & Wolff, of Belfast, their *Oceanic* (3807 tons), which was launched in 1870. This vessel may fairly be said to have marked an era in North Atlantic travel. The same is true of the successive types of steamer which Ismay, with the co-operation of the Belfast shipbuilding firm, subsequently provided for the American trade. To Ismay is mainly due the credit of the arrangement by which some of the fastest ships of the British mercantile marine are held at the disposal of the government in case of war. The origin of this plan dates from the Russo-Turkish war, when there seemed a likelihood of England being involved in hostilities with Russia, and when, therefore, Ismay offered the admiralty the use of the White Star fleet. In 1892 he retired from partnership in the firm of Ismay, Imrie and Co., though he retained the chairmanship of the White Star Company. He served on several important committees and was a member of the royal commission in 1888 on army and navy administration. He was always most generous

in his contributions to charities for the relief of sailors, and in 1887 he contributed £20,000 towards a pension fund for Liverpool sailors. He died at Birkenhead on the 23rd of November 1899.

**ISMID**, or **ISNIKIMID** (anc. *Nicomedia*), the chief town of the Khoja Ili sanjak of Constantinople, in Asia Minor, situated on rising ground near the head of the gulf of Ismid. The sanjak has an area of 4650 sq. m. and a population of 225,000 (Moslems 131,000). It is an agricultural district, producing cocoons and tobacco, and there are large forests of oak, beech and fir. Near Yalova there are hot mineral springs, much frequented in summer. The town is connected by the lines of the Anatolian railway company with Haidar Pasha, the western terminus, and with Angora, Konja and Smyrna. It contains a fine 16th-century mosque, built by the celebrated architect Sinan. Pop. 20,000 (Moslems 9500, Christians 8000, Jews, 2500). As the seat of a mutessarif, a Greek metropolitan and an Armenian archbishop, Ismid retains somewhat of its ancient dignity, but the material condition of the town is little in keeping with its rank. The head of the gulf of Ismid is gradually silting up. The dockyard was closed in 1879, and the port of Ismid is now at Darinje, 3½ m. distant, where the Anatolian Railway Company have established their workshops and have built docks and a quay.

**ISNARD, MAXIMIN** (1758-1825), French revolutionist, was a dealer in perfumery at Draguignan when he was elected deputy for the department of the Var to the Legislative Assembly, where he joined the Girondists. Attacking the court, and the "Austrian committee" in the Tuileries, he demanded the disbandment of the king's bodyguard, and reproached Louis XVI. for infidelity to the constitution. But on the 20th of June 1792, when the crowd invaded the palace, he was one of the deputies who went to place themselves beside the king to protect him. After the 10th of August 1792 he was sent to the army of the North to justify the insurrection. Re-elected to the Convention, he voted the death of Louis XVI. and was a member of the Committee of General Defence when it was organized on the 4th of January 1793. The committee, consisting of 25 members, proved unwieldy, and on the 4th of April Isnard presented, on behalf of the Girondist majority, the report recommending a smaller committee of nine, which two days later was established as the Committee of Public Safety. On the 25th of May, Isnard was presiding at the Convention when a deputation of the commune of Paris came to demand that J. R. Hébert should be set at liberty, and he made the famous reply: "If by these insurrections, continually renewed, it should happen that the principle of national representation should suffer, I declare to you in the name of France that soon people will search the banks of the Seine to see if Paris has ever existed." On the 2nd of June 1793 he offered his resignation as representative of the people, but was not comprised in the decree by which the Convention determined upon the arrest of twenty-nine Girondists. On the 3rd of October, however, his arrest was decreed along with that of several other Girondist deputies who had left the Convention and were fomenting civil war in the departments. He escaped, and on the 8th of March 1795 was recalled to the Convention, where he supported all the measures of reaction. He was elected deputy for the Var to the Council of Five Hundred, where he played a very insignificant rôle. In 1797 he retired to Draguignan. In 1800 he published a pamphlet *De l'immortalité de l'âme*, in which he praised Catholicism; in 1804 *Réflexions relatives au sénatus-consulte du 28 floréal an XII.*, which is an enthusiastic apology for the Empire. Upon the restoration he professed such royalist sentiments that he was not disturbed, in spite of the law of 1816 proscribing regicide ex-members of the Convention.

See F. A. Aulard, *Les Orateurs de la Législative et de la Convention* (Paris, 2nd ed., 1906).

**ISOBAR** (from Gr. *isos*, equal, and *βάρος*, weight), a line upon a meteorological map or pressure chart connecting points where the atmospheric pressure is the same at sea-level, or upon the earth's surface. A general pressure map will indicate, by these

lines, the average pressure for any month or season over large areas. The daily weather charts for more confined regions indicate the presence of a cyclonic or anticyclonic system by means of lines, which connect all places having the same barometric pressure at the same time. It is to be noted that isobaric lines are the intersections of inclined isobaric surfaces with the surface of the earth.

**ISOCLINIC LINES** (Gr. *isos*, equal, and *κλίσεις*, to bend), lines connecting those parts of the earth's surface where the magnetic inclination is the same in amount. (See **MAGNETISM, TERRESTRIAL.**)

**ISOCRATES** (436-338 B.C.), Attic orator, was the son of Theodoros, an Athenian citizen of the deme of Erchia—the same in which, about 431 B.C., Xenophon was born—who was sufficiently wealthy to have served the state as choregus. The fact that he possessed slaves skilled in the trade of flute-making perhaps lends point to a passage in which his son is mentioned by the comic poet Strattis.<sup>1</sup> Several popular "sophists" are named as teachers of the young Isocrates. Like other sons of prosperous parents, he may have been trained in such grammatical subtleties as were taught by Protagoras or Prodicus, and initiated by Theramenes into the florid rhetoric of Gorgias, with whom at a later time (about 390 B.C.) he was in personal intercourse. He tells us that his father had been careful to provide for him the best education which Athens could afford. A fact of greater interest is disclosed by Plato's *Phaedrus* (278 E). "Isocrates is still young, Phaedrus," says the Socrates of that dialogue, "but I do not mind telling you what I prophesy of him. . . . It would not surprise me if, as years go on, he should make all his predecessors seem like children in the kind of oratory to which he is now addressing himself, or if—supposing this should not content him—some divine impulse should lead him to greater things. My dear Phaedrus, a certain philosophy is inborn in him." This conversation is dramatically supposed to take place about 410 B.C. It is unnecessary to discuss here the date at which the *Phaedrus* was actually composed. From the passage just cited it is at least clear that there had been a time—while Isocrates could still be called "young"—at which Plato had formed a high estimate of his powers.

Isocrates took no active part in the public life of Athens; he was not fitted, as he tells us, for the contests of the popular assembly or of the law-courts. He lacked strength of voice—a fatal defect in the ecclesia, when an audience of many thousands was to be addressed in the open air; he was also deficient in "boldness." He was, in short, the physical opposite of the successful Athenian demagogue in the generation after that of Pericles; by temperament as well as taste he was more in sympathy with the sedate decorum of an older school. Two ancient biographers have, however, preserved a story which, if true, would show that this lack of voice and nerve did not involve any want of moral courage. During the rule of the Thirty Tyrants, Critias denounced Theramenes, who sprang for safety to the sacred hearth of the council chamber. Isocrates alone, it is said, dared at that moment to plead for the life of his friend.<sup>2</sup> Whatever may be the worth of the story, it would scarcely have connected itself with the name of a man to whose traditional character it was repugnant. While the Thirty were still in power, Isocrates withdrew from Athens to Chios.<sup>3</sup> He has mentioned that, in the course of the Peloponnesian War—doubtless in the troubles which attended on its close—he lost the whole of that private fortune which had enabled his father to serve the state, and that he then adopted the profession of a teacher. The proscription of the "art of words" by the Thirty would thus have given him a special motive for withdrawing

from Athens. He returned thither, apparently, either soon before or soon after the restoration of the democracy in 403 B.C. \* For ten years from this date he was occupied—at least occasionally—as a writer of speeches for the Athenian law-courts. Six of these speeches are extant. The earliest (*Or. xxi.*) may be referred to 403 B.C.; the latest (*Or. xix.*) to 394-393 B.C. This was a department of his own work which Isocrates afterwards preferred to ignore. Nowhere, indeed, does he say that he had not written forensic speeches. But he frequently uses a tone from which that inference might be drawn. He loves to contrast such petty concerns as engage the forensic writer with those larger and nobler themes which are treated by the politician. This helps to explain how it could be asserted—by his adopted son, Aphareus—that he had written nothing for the law-courts. Whether the assertion was due to false shame or merely to ignorance, Dionysius of Halicarnassus decisively disposes of it. Aristotle had, indeed, he says, exaggerated the number of forensic speeches written by Isocrates; but some of those which bore his name were unquestionably genuine, as was attested by one of the orator's own pupils, Cephisodoros. The real vocation of Isocrates was discovered from the moment that he devoted himself to the work of teaching and writing. The instruction which Isocrates undertook to impart was based on rhetorical composition, but it was by no means merely rhetorical. That "inborn philosophy," of which Plato recognized the germ, still shows itself. In many of his works—notably in the *Panegyricus*—we see a really remarkable power of grasping a complex subject, of articulating it distinctly, of treating it, not merely with effect but luminously, at once in its widest bearings and in its most intricate details. Young men could learn more from Isocrates than the graces of style; nor would his success have been what it was if his skill had been confined to the art of expression.

It was about 392 B.C.—when he was forty-four—that he opened his school at Athens near the Lyceum. In 339 B.C. he describes himself as revising the *Panathenaiscus* with some of his pupils; he was then ninety-seven. The celebrity enjoyed by the school of Isocrates is strikingly attested by ancient writers. Cicero describes it as that school in which the eloquence of all Greece was trained and perfected; its disciples were "brilliant in pageant or in battle,"<sup>4</sup> foremost among the accomplished writers or powerful debaters of their time. The phrase of Cicero is neither vague nor exaggerated. Among the literary pupils of Isocrates might be named the historians Ephorus and Theopompus, the Attic archaeologist Androton, and Isocrates of Apollonia, who succeeded his master in the school. Among the practical orators we have, in the forensic kind, Iseus; in the political, Leodamas of Acharnae, Lycurgus and Hyperides. Hermippus of Smyrna (mentioned by Athenaeus) wrote a monograph on the "Disciples of Isocrates." And scanty as are now the sources for such a catalogue, a modern scholar<sup>5</sup> has still been able to recover forty-one names. At the time when the school of Isocrates was in the zenith of its fame it drew disciples, not only from the shores and islands of the Aegean, but from the cities of Sicily and the distant colonies of the Euxine. As became the image of its master's spirit, it was truly Panhellenic. When Mausolus, prince of Caria, died in 351 B.C., his widow Artemisia instituted a contest of panegyrical eloquence in honour of his memory. Among all the competitors there was not one—if tradition may be trusted—who had not been the pupil of Isocrates.

Meanwhile the teacher who had won this great reputation had also been active as a public writer. The most interesting and most characteristic works of Isocrates are those in which he deals with the public questions of his own day. The influence which he thus exercised throughout Hellas might be compared to that of an earnest political essayist gifted with a popular and attractive style. And Isocrates had a dominant idea which gained strength with his years, until its realization had become, we might say, the main purpose of his life. This idea was

<sup>1</sup> *Ἀνακρίων*, fr. 1, Meineke, *Poëtarum comicorum Graecorum frag.* (1853), p. 202.

<sup>2</sup> [Plut.] *Vita Isocr.*, and the anonymous biographer. Dionysius does not mention the story, though he makes Isocrates a pupil of Theramenes.

<sup>3</sup> Some would refer to the sojourn of Isocrates at Chios to the years 398-395 B.C., others to 393-388 B.C. The reasons which support the view given in the text will be found in Jebb's *Attic Orators*, vol. ii. (1893), p. 6, note 2.

<sup>4</sup> *Partim in pompa, partim in acie illustres* (*De orat.* ii. 24).

<sup>5</sup> P. Sanneg, *De schola Isocratea* (Halle, 1867).

the invasion of Asia by the united forces of Greece. The Greek cities were at feud with each other, and were severally torn by intestine faction. Political morality was become a rare and a somewhat despised distinction. Men who were notoriously ready to sell their cities for their private gain were, as Demosthenes says, rather admired than otherwise.<sup>1</sup> The social condition of Greece was becoming very unhappy. The wealth of the country had ceased to grow; the gulf between rich and poor was becoming wider; party strife was constantly adding to the number of homeless paupers; and Greece was full of men who were ready to take service with any captain of mercenaries, or, failing that, with any leader of desperadoes. Isocrates draws a vivid and terrible picture of these evils. The cure for them, he firmly believed, was to unite the Greeks in a cause which would excite a generous enthusiasm. Now was the time, he thought, for that enterprise in which Xenophon's comrades had virtually succeeded, when the headlong rashness of young Cyrus threw away their reward with his own life.<sup>2</sup> The Persian empire was unsound to the core—witness the retreat of the Ten Thousand: let united Greece attack it and it must go down at the first onset. Then new wealth would flow into Greece; and the hungry pariahs of Greek society would be drafted into fertile homes beyond the Aegean.

A bright vision; but where was the power whose spell was first to unite discordant Greece, and, having united it, to direct its strength against Asia? That was the problem. The first attempt of Isocrates to solve it is set forth in his splendid *Panegyricus* (380 B.C.). Let Athens and Sparta lay aside their jealousies. Let them assume, jointly, a leadership which might be difficult for either, but which would be assured to both. That eloquent pleading failed. The next hope was to find some one man equal to the task. Jason of Pherae, Dionysius I. of Syracuse, Archidamus III., son of Agesilaus—each in turn rose as a possible leader of Greece before the imagination of the old man who was still young in his enthusiastic hope, and one after another they failed him. But now a greater than any of these was appearing on the Hellenic horizon, and to this new luminary the eyes of Isocrates were turned with eager anticipation. Who could lead united Greece against Asia so fitly as the veritable representative of the Heracleidae, the royal descendant of the Argive line—a king of half-barbarians it is true, but by race, as in spirit, a pure Hellenic—Philip of Macedon? We can still read the words in which this fond faith clothed itself; the ardent appeal of Isocrates to Philip is extant; and another letter shows that the belief of Isocrates in Philip lasted at any rate down to the eve of Chaeronea.<sup>3</sup> Whether it survived that event is a doubtful point. The popular account of the orator's death ascribed it to the mental shock which he received from the news of Philip's victory. He was at Athens, in the palaestra of Hippocrates, when the tidings came. He repeated three verses in which Euripides names three foreign conquerors of Greece—Danaus, Pelops, Cadmus—and four days later he died of voluntary starvation. Milton (perhaps thinking of Eli) seems to conceive the death of Isocrates as instantaneous:—

"As that dishonest victory  
At Chaeronea, fatal to liberty,  
Killed with report that old man eloquent."

Now the third of the letters which bears the name of Isocrates is addressed to Philip, and appears to congratulate him on his victory at Chaeronea, as being an event which will enable him to assume the leadership of Greece in a war against Persia. Is the letter genuine? There is no evidence, external or internal, against its authenticity, except its supposed inconsistency with the views of Isocrates and with the tradition of his suicide. As to his views, those who have studied them in his own writings will be disposed to question whether he would have regarded

Philip's victory at Chaeronea as an irreparable disaster for Greece. Undoubtedly he would have deplored the conflict between Philip and Athens; but he would have divided the blame between the combatants. And, with his old belief in Philip, he would probably have hoped, even after Chaeronea, that the new position won by Philip would eventually prove compatible with the independence of the Greek cities, while it would certainly promote the project on which, as he was profoundly convinced, the ultimate welfare of Greece depended,—a Panhellenic expedition against Persia. As to the tradition of his suicide, the only rational mode of reconciling it with that letter is to suppose that Isocrates destroyed himself, not because Philip had conquered, but because, after that event, he saw Athens still resolved to resist. We should be rather disposed to ask how much weight is to be given to the tradition. The earliest authority for it—Dionysius of Halicarnassus in the age of Augustus—may have had older sources; granting, however, that these may have remounted even to the end of the 4th century B.C., that would not prove much. Suppose that Isocrates—being then ninety-eight and an invalid—had happened to die from natural causes a few days after the battle of Chaeronea. Nothing could have originated more easily than a story that he killed himself from intense chagrin. Every one knew that Isocrates had believed in Philip; and most people would have thought that Chaeronea was a crushing refutation of that belief. Once started, the legend would have been sure to live, not merely because it was picturesque, but also because it served to accentuate the contrast between the false prophet and the true—between Isocrates and Demosthenes; and Demosthenes was very justly the national idol of the age which followed the loss of Greek independence.<sup>4</sup>

Isocrates is said to have taught his Athenian pupils gratuitously, and to have taken money only from aliens; but, as might have been expected, the fame of his school exposed him to attacks on the ground of his gains, which his enemies studiously exaggerated. After the financial reform of 378 B.C. he was one of those 1200 richest citizens who constituted the twenty unions (*συμμορία*) for the assessment of the war-tax (*ελεφορὰ*). He had discharged several public services (*ἀετιοργίαι*); in particular, he had thrice served as trierarch. He married Plathane, the widow of the "sophist" Hippias of Elis, and then adopted her son Aphareus, afterwards eminent as a rhetorician and a tragic poet. In 355 B.C. he had his first and only lawsuit. A certain Megacides (introduced into the speech under the fictitious name of Lysimachus) challenged him to undertake the trierarchy or exchange properties. This was the lawsuit which suggested the form of the discourse which he calls the *Antidosis* ("exchange of properties"—353 B.C.)—his defence of his professional life.

He was buried on a rising ground near the Cynosarges—a temenos of Heracles, with a gymnasium, on the east side of Athens, outside the Diomeian gate. His tomb was surmounted by a column some 45 ft. high, crowned with the figure of a siren, the symbol of persuasion and of death. A tablet of stone, near the column, represented a group of which Gorgias was the centre; his pupil Isocrates stood at his side. Aphareus erected a statue to his adopted father near the Olympieum. Timotheus, the illustrious son of Conon, dedicated another in the temple of Eleusis.

It was a wonderful century which the life of one man had thus all but spanned. Isocrates had reached early manhood when the long struggle of the Peloponnesian War—begun in his childhood—ended with the overthrow of Athens. The middle period of his career was passed under the supremacy of Sparta. His more advanced age saw that brief ascendancy which the genius of Epameinondas secured to Thebes. And he lived to urge on Philip of Macedon a greater enterprise than any which the Hellenic world could offer. His early promise had won a glowing tribute from Plato, and the rhetoric of his maturity furnished matter to the analysis of Aristotle; he had composed his imaginary

<sup>1</sup> *De falsa legat.* p. 426 *ὅτι εἰως ἀργίοντο ἡ πόλις καὶ ἦσαν τοὺς ταῖς πόλιντας, ἀλλ' ἀντιθέτως, ἰσθλόνον, ἰσθλόνον, ἄνδρας ἡρόδοντο.*

<sup>2</sup> *Ἰσικριτοῦ πρὸς ἡλικίαν . . . ἦν ἰσικριτοῦ δουλόντας εἶναι τῶν πραγμάτων διὰ τὴν Κέρου προπέταν ἀνυψίαν (Philippus, 90; cp. *Panegy.* 149).*

<sup>3</sup> *Philippus*, 346 B.C.; *Epist.* ii. end of 342 B.C. (?).

<sup>4</sup> The views of several modern critics on the tradition of the suicide are brought together in the *Attic Orators*, ii. (1893) p. 31, note 1.



picture of that Hellenic host which should move through Asia in a pageant of sacred triumph, just as Xenophon was publishing his plain narrative of the retreat of the Ten Thousand; and, in the next generation, his literary eloquence was still demonstrating the weakness of Persia when Demosthenes was striving to make men feel the deadly peril of Greece. This long life has an element of pathos not unlike that of Greek tragedy; a power above man was compelling events in a direction which Isocrates could not see; but his own agency was the ally of that power, though in a sense which he knew not; his vision was of Greece triumphant over Asia, while he was the unconscious prophet of an age in which Asia should be transformed by the diffusion of Hellenism.<sup>1</sup>

His character should be viewed in both its main aspects—how political and the literary.

With regard to the first, two questions have to be asked: (1) How far were the political views of Isocrates peculiar to himself, and different from those of the clearest minds contemporary with him? (2) How far were those views falsified by the event?

1. The whole tone of Greek thought in that age had taken a bent towards monarchy in some form. This tendency may be traced alike in the practical common sense of Xenophon and in the lofty idealism of Plato. There could be no better instance of it than a well-known passage in the *Politics* of Aristotle. He is speaking of the gifts which men in the Grecian world brought to the Hellenic, but more subtly keen, like the Asiatics, but braver. "Hence," he says, "a race which might rule all men, if it were brought under a single government."<sup>2</sup> It is unnecessary to suppose a special allusion to Alexander; but it is probable that Aristotle had in his mind a possible union of the Greek cities under a strong constitutional monarchy. His advice to Alexander (as reported by Plutarch) was to treat the Greeks in the spirit of a leader (*ἀρχηγός*) and the barbarians in the spirit of a master (*δεσποτικός*). Aristotle conceived the central power as political and permanent; Isocrates conceived it as, in the first place, military, having for its immediate aim the conduct of an expedition against Asia. The general views of Isocrates as to the largest good possible for the Greek race were thus in accord with the prevailing tendency of the best Greek thought in that age.

2. The vision of the Greek race "brought under one polity" was not, indeed, fulfilled in the sense of Aristotle or of Isocrates. But the invasion of Asia by Alexander, as captain-general of Greece, became the event which actually opened new and larger destinies to the Greek race. The old political life of the Greek cities was worn out; in the new fields which were now opened, the empire of Greek civilization entered on a career of world-wide conquest, until Greece became to East and West more than all that Athens had been to Greece. Athens, Sparta, Thebes, ceased indeed to be the chief centres of Greek life; but the mission of the Greek mind could scarcely have been accomplished with such expansive and penetrating power if its influence had not radiated over the East from Pergamum, Antioch and Alexandria.

Panhellenic politics had the foremost interest for Isocrates. But in two of his works—the oration *On the Peace* and the *Areopagitica* (both of 355 B.C.)—he deals specially with the politics of Athens. The speech *On the Peace* relates chiefly to foreign affairs. It is an eloquent appeal to his fellow-citizens to abandon the dream of supremacy, and to treat their allies as equals, not as subjects. The fervid orator personifies that empire, that false mistress which has lured Athens, Sparta, Thebes, then Athens once more, to the verge of destruction. "Is she not worthy of detestation?" Leadership passes into empire; empire begets insolence; insolence brings ruin. The *Areopagitica* breathes a kindred spirit in regard to home policy. Athenian life had lost its old tone. Apathy to public interests, dissolute frivolity, tawdry display and real poverty—these are the features on which Isocrates dwells. With this picture he contrasts the elder democracy of Solon and Cleisthenes, and, as a first step towards reform, he would restore to the Areopagus its general censorship of morals. It is here, and here alone in his comments on Athenian affairs at home and abroad—that we can distinctly recognize the man to whom the Athens of Pericles was something more than a tradition. We are carried back to the age in which his long life began. We find it difficult to realize that the voice to which we listen is the same which we hear in the letter to Philip.

Turning from the political to the literary aspect of his work, we see at once upon whom there the reputation of his merits will now provoke comparative little controversy. Perhaps the most serious prejudice with which his reputation has had to contend in

modern times has been due to an accident of verbal usage. He repeatedly describes that art which he professed to teach as his *φιλοσοφία*. His use of this word—joined to the fact that in a few passages he appears to allude slightly to Plato or to the Socratics—has exposed him to a groundless imputation. It cannot be too distinctly stated, that, while the speakers of his *φιλοσοφία*, he means simply his theory or method of "culture"—to use the only modern term which is really equivalent in latitude to the Greek word as then current.<sup>3</sup>

The *φιλοσοφία*, or practical culture, of Isocrates was not in conflict, because it had nothing in common, with the Socratic or Platonic philosophy. The personal influence of Socrates may, indeed, be traced in his Essay. He constantly desires to make his teaching best of the practical life. His maxims of books are not, however, frequently recalled in *Memorabilia*. But there the relation ends. Plato alludes to Isocrates in perhaps three places. The glowing prophecy in the *Phaedrus* has been quoted; in the *Gorgias* a phrase of Isocrates is wittily parodied; and in the *Euthydemus* Isocrates is probably meant by the person who dwells "on the borderland between philosophy and statesmanship."<sup>4</sup> The writings of Isocrates contain a few more or less distinct allusions to Plato's doctrines or works, to the general effect that they are barren of practical results. Isocrates, however, assumes the rank of a philosopher as such. When he declares "knowledge" (*ἐπιστήμη*) to be unattainable, he means an exact "knowledge" of the contingencies which may arise in practical life. "Since it is impossible for human nature to acquire any science (*ἐπιστήμη*) by which we should know what to do or to say, in the next resort I deem those wise who, as a rule, can hit what is best by their opinions" (*δόξαι*).<sup>5</sup>

Isocrates should be compared with the practical teachers of his day. In his essay *Against the Sophists*, and in his speech on the *Antidosis*, which belong respectively to the beginning and the close of his professional career, he has clearly marked the points which distinguish him from "the sophists of the herd" (*ἀρχαίοι σοφισταί*). First, then, he claims, and justly, greater breadth of view. The ordinary teacher confined himself to the narrow scope of local interests—training the young citizen to plead in the Athenian law courts, or to speak on Athenian affairs in the ecclesia. Isocrates sought, or to enlarge the mental horizon of his disciples by acquainting them to deal with subjects which were not merely Athenian, but, in his own phrase, Hellenic. Secondly, though he did not claim to have found a philosophical basis for morals, it has been well said of him that "he reflects the human spirit always on its nobler side,"<sup>6</sup> and that, in an age of corrupt and impudent selfishness, he always strove to raise the minds of his hearers into a higher and purer air. Thirdly, his method of teaching was thorough. Technical exposition came first. The learner was then required to apply the rules in actual composition, in which the master assisted him. The ordinary teachers of rhetoric (as Aristotle says) employed their pupils in committing model pieces to memory, but neglected to train the learner's own faculty through his own efforts. Lastly, Isocrates stands apart from most writers of that day in his steady effort to produce results of permanent value. While rhetorical skill was largely engaged in the intermittent journalism of political pamphlets, Isocrates set a higher ambition before his school. His own essays on contemporary questions received that finished form which has preserved them to this day. The impulse to solid and lasting work, communicated by the example of the master, was seen in such monuments as the *Atthis* of Andron, the *Hellenics* of Theopompus and the *Philippica* of Ephorus.

In one of his letters to Atticus, Cicero says that he has used "all the fragrant essences of Isocrates, and all the little stores of his disciples."<sup>7</sup> The phrase has a point of which the writer himself was perhaps afterwards conscious: the style of Isocrates was not confined to Cicero, but throughout the school of Rhodes, and the Rhodian imitators had more of Asiatic splendour than of Attic elegance. But, with this allowance made, the passage may serve to indicate the real place of Isocrates in the history of literary style. The old Greek critics consider him as representing what they call the "smooth" or "florid" mode of composition (*πλαστική, ἀσπρά, ἁμιλία*) as distinguished from the "harsh" (*ἀσπρά, ἄσπρη*) style of Antiphon and the perfect "mean" (*μέση*) of Demosthenes. "Judged by modern standards, the language of Isocrates is certainly no model."<sup>8</sup> The only sense in which he merits the epithet is that (especially in his

<sup>1</sup> The word *φιλοσοφία* seems to have come into Athenian use not much before the time of Socrates; and, till long after the time of Isocrates, it was commonly used, not in the sense of the philosophy, but in that of "literary taste and study—culture generally." See Thompson on *Phaedrus*, 278 D. Aristides, ii. 407 *φιλοσοφία τῆς καὶ διατριβῆς περὶ λόγου, καὶ οὐχ ὡς πύθονος ὄρους, ἀλλὰ ταῖς αἰσῶν καὶ ἐπιπέδων*. And so writers of the 4th century B.C. use *φιλοσοφίαν* as simply "to study"; as e.g. an invalid "studies" the means of relief from pain, *Lys. Or. xv. 10*; cf. *Isoc. Or. iv. 6*, &c.

<sup>2</sup> Plato, *Gorg.* p. 463; *Euthyd.* 304-306.

<sup>3</sup> These allusions are discussed in the *Attic Orators*, vol. ii. ch. 13.

<sup>4</sup> *Isoc.* xv. 10.

<sup>5</sup> A. Cartellieri, *Les Discours d'Isocrate sur lui-même*, p. lxxi. (1862).

<sup>6</sup> Totum Isocrati *μυροῦσθαι* atque omnes ejus discipulorum *arculas* (*Ad Att.* ii. 1).

<sup>1</sup> Isocrates, a loyal and genuine Hellenic, can yet conceive of Hellenic culture as earned by men not of Hellenic blood. (*Panegy.* 50). He is thus, as Ernst Curtius has ably shown, a forerunner of Hellenism—analogous, in the literary province, to Epameinondas and Timotheus in the political. (*History of Greece*, v. 116, 204, tr. Ward).

<sup>2</sup> *Ἡ δὲ τῶν Ἑλλήνων φιλοσοφία ἀπὸ τῶν ἀναγμένων ἀρχῶν πάντων, μὴ τυχόντων πύθωνος*. (*Polit. iv.* [vil. 6].)

<sup>3</sup> *De Alex. virt.* i. 6.

earlier work) he delights in elaborate antitheses. Isocrates is an "orator" in the larger sense of the Greek word *rhetor*; but his real distinction consists in the fact that he was the first Greek who gave an artistic finish to literary rhetoric. The practical oratory of the day had already two clearly separated branches—the forensic, represented by Isaeus, and the deliberative, in which Callistratus was the forerunner of Demosthenes. Meanwhile Isocrates was giving form and rhythm to a standard literary prose. Through the influence of his school, this normal prose style was transmitted—without the addition of some florid embellishments—to the first generation of Romans who studied rhetoric in the Greek schools. The distinctive feature in the composition of Isocrates is his structure of the periodic sentence. This, with him, is no longer rigid or monotonous, as with Antiphon—no longer terse and compact, as with Lysias—but ample, luxuriant, unfolding itself (to use a Greek critic's image) like the soft beauties of a winding river. Isocrates was the first Greek who worked out the idea of a prose rhythm. He saw clearly both its powers and its limits; poetry has its strict rhythms and precise metres; prose has its metres and rhythms, not bound by a rigid framework, yet capable of being brought under certain general laws which a good ear can recognize, and which a speaker or writer may apply in the most various combinations. This fundamental idea of prose rhythm, or number, is that which the style of Isocrates has imparted to the style of Cicero. When Quintilian (x. 1. 108) says, somewhat hyperbolically, that Cicero has artistically reproduced (*effinxisse*) "the force of Demosthenes, the wealth of Plato, the charm of Isocrates," he means principally this smooth and harmonious rhythm. Cicero himself expressly recognizes this original and distinctive merit of Isocrates.<sup>1</sup> Thus, through Rome, and especially through Cicero, the influence of Isocrates, as the founder of the literary prose style of the literate world, may be traced. It is to the eloquence of the preacher that we may perhaps look for the nearest modern analogue of that kind in which Isocrates excelled—especially, perhaps, to that of the great French preachers. Isocrates was one of the three Greek authors, Demosthenes and Plato being the others, who contributed most to form the style of Bossuet.

WORKS.—The extant works of Isocrates consist of twenty-one speeches or discourses and nine letters.<sup>2</sup> Among these, the six forensic speeches represent the first period of his literary life—belonging to the years 403–393 B.C. All six concern private causes. They may be classed for *loisir* value as *Actio in Asinam (Inverianus)*, Or. xv; *Actio in Lochites*, 2. 394 B.C.; 2. *Claim to an Inheritance (ἰσχυρισμὸς)*, Or. xix; *Aegineticus*, end of 394 or early in 393 B.C.; 3. *Actions to Recover a Deposit*: (1) Or. xxi, *Against Euthymus*, 403 B.C.; (2) Or. xvii, *Trapēsiticus*, end of 394 or early in 393 B.C.; 4. *Action for Damage (δίκη βλάβης)*, Or. xvi, *Concerning the Team of Horses*, 397 B.C.; 5. *Special Plea (ὑπεράσπασις)*, Or. xviii, *Against Callimachus*, 402 B.C. Two of these have been regarded as spurious by G. E. Benseler, viz. Or. xxi, on account of the frequent hiatus and the short compact periods, and Or. xvii, on the first of these grounds. But we are not warranted in applying to the early work of Isocrates those canons which his mature style observed. The genuineness of the speech against Euthymus is recognized by Philostratus; while the *Trapēsiticus*—thrice named without suspicion by Harpocration—is treated by Dionysius, not only as authentic, but as the typical forensic work of its author. The speech against Lochites—where "a man of the people" (τοῦ πλοῦτος εἶς) is the speaker—exhibits much rhetorical skill. The speech *Περὶ τοῦ ἔργου* ("concerning the team of horses") has a curious interest. An Athenian citizen had complained that Alcibiades had robbed him of a team of four horses, and sues the statesman's son and namesake who is the speaker for *loisir* value. This is not the only place in which Isocrates has marked his admiration for the genius of Alcibiades; it appears also in the *Philippus* and in the *Besiris*. But, among the forensic speeches, we must, on the whole, give the palm to the *Aegineticus*—a graphic picture of ordinary Greek life in the islands of the Aegean. Here—especially in the narrative—Isocrates makes a near approach to the best manner of Lysias.

The remaining fifteen orations or discourses do not easily lend themselves to the ordinary classification under the heads of "deliberative" and "epideictic." Both terms must be strained; and neither is strictly applicable to all the pieces which it is required to cover. The work of Isocrates that travels out of the groove is his rhetorical industry of the age had hitherto moved. His position among contemporary writers was determined by ideas peculiar to himself; and his compositions, besides having a style of their own, are in several instances of a new kind. The only adequate principle of classification is one which considers them in respect to their subject-matter. Thus viewed, they form two clearly separated groups—the scholastic and the political.

*Scholastic Writings*.—Under this head we have, first, three letters or essays of a hortatory character, (1) The letter to the young Democritus—once a favourite subject in the schools—contains

a series of precepts neither below nor much above the average practical morality of Greece. (2) The letter to Nicoteles—the young king of the Cyprian Salamis—sets forth the duty of a monarch to his subjects. (3) In the third piece, it is Nicoteles who speaks, and impresses on the Salaminians their duty to their king—a piece remarkable as containing a popular plea for monarchy, composed by a citizen of Athens. These three letters may be referred to the years 374–372 B.C.

Next may be placed four pieces which are "displays" (ἰσχυρισμὸς) in the proper Greek sense. The *Besiris* (Or. xi., 390–391 B.C.) is an attempt to show how the ill-famed king of Egypt might be praised. The *Encomium on Helen* (Or. x., 370 B.C.), a piece greatly superior to the last, contains the celebrated passage on the power of beauty. These two compositions serve to illustrate their author's view that "encomia" of the hackneyed type might be elevated by combining the mythical matter with some topic of practical interest—as, in the case of *Besiris*, with the institutions of Egypt, or, in that of Helen, with the reforms of Theseus. The *Evagrus* (Or. ix., 365 B.C.), the earliest known biography, is a laudatory epitaph on a really able man—the Greek king of the Cyprian Salamis. A passage of singular interest describes how, under his rule, the influences of Hellenic civilization had prevailed over the surrounding barbarism. The *Panathenaeus* (Or. xii.), intended for the great Panathenaea of 342 B.C., but not completed till 339 B.C., contains a recital of the services rendered by Athens to Greece, but digresses into personal defence against critics; his last work, written in extreme old age, it bears the plainest marks of falling powers.

The final subdivision of the scholastic writings is formed by two most interesting essays on education—that entitled *Against the Sophists* (Or. xiii., 391–390 B.C.), and the *Antidosis* (Or. xv., 353 B.C.). The first of these is a manifesto put forth by Isocrates at the outset of his professional career of teaching, in which he seeks to distinguish his aims from those of other "sophists." These "sophists" are (1) the "erotics" (οἱ περὶ τὰς ἐρώδων), by whom he seems to intend the minor Socrates, especially Euclides; (2) the teachers of practical rhetoric, who had made exaggerated claims for the efficacy of mere instruction, independently of natural faculty or experience; (3) the writers of "arts of rhetoric, who virtually devoted the education (as Aristotle so comely) to the lowest or forensic branch of their subject (see also H. Holzner, *Platons Platon und die Sophistenrede des Isokrates*, Prague, 1894). As this piece is the prelude to his career, its epilogue is the speech on the "Antidosis"—so called because it has the form of a speech made in court in answer to a challenge to undertake the burden of the trierarchy, or else exchange properties with the challenger. The discourse "Against the Sophists" had stated what his art was not; this speech defines what it is. His own *τακτικὴ* of his φιλοσοφία—"the discipline of discourse" (ἡ τῶν λόγων παιδεία)—has been embodied in the sketch of his life given above.

*Political Writings*.—These, again, fall into two classes—those which concern (1) the relations of Greece with Persia, (2) the internal affairs of Greece. The first class consists of the *Panegyricus* (Or. iv., 380 B.C.) and the *Philippus* (Or. v., 346 B.C.). The *Panegyricus* takes its name from the fact that it was given to the Greek public at the time of the Olympic festivals—probably by means of copies circulated there. The orator urges that Athens and Sparta should unite in leading the Greeks against Persia. The feeling of antiquity that this noble discourse is a masterpiece of careful work finds expression in the tradition that he had occupied its author for more than ten years. Its excellence is not more that of language, but also—and perhaps even more conspicuously—that of lucid arrangement. The *Philippus* is an appeal to the king of Macedonia to assume that initiative in the war on Persia which Isocrates had ceased to expect from any Greek city. In the view of Demosthenes, Philip was the representative barbarian; in that of Isocrates, he is the first of Hellenes, and the natural champion of their cause.

Of those discourses which concern the internal affairs of Greece, two have already been noticed,—that *On the Peace* (Or. viii.), and the *Areopagiticus* (Or. vii.)—both of 355 B.C.—dealing respectively with the foreign and the home affairs of Athens. The *Platonicus* (Or. xiv.) is supposed to be spoken by a Plataean before the Athenian ecclesia in 373 B.C. In that year Plataea had for the second time in its history been destroyed by Thebes. The oration—an appeal to Athens to restore the unhappy town—is remarkable both for the power with which Theban cruelty is denounced, and for the genuine pathos of the peroration. The *Archidamus* (Or. vi.) is a speech purporting to be delivered by Archidamus III., son of Agesilaus, in a debate at Sparta on conditions of peace offered by Thebes in 366 B.C. It was demanded that Sparta should recognize the independence of Messene, which had lately been restored by Epameinondas (370 B.C.). The oration gives a brilliant expression to the feeling which such a demand was calculated to excite in Spartans who knew the history of their own city. Xenophon witnesses that the attitude of Sparta on this occasion was actually such as the *Archidamus* assumes (*Hellen*. vii. 4. 8–11).

*Letters*.—The first letter—to Dionysius I.—is fragmentary; but a passage in the *Philippus* leaves no doubt as to its object. Isocrates was anxious that the ruler of Syracuse should undertake the command of Greece against Persia. The date is probably 368 B.C.

<sup>1</sup> *Idque principis Isocrates instituisse fertur, . . . ut inconditum antiquorum dicendi consuetudinem . . . numeris arstringeret (De or. iii. 4d. 173).*

<sup>2</sup> The dates here given differ to some extent from those in F. Blass, *Die attische Beredsamkeit* (2nd ed., 1887–1898).

<sup>3</sup> Some authorities consider the *Ad Demonicum* spurious.

Next in chronological order stands the letter "To the Children of Jason" (vi.). Jason, tyrant of Phœria, had been assassinated in 370 B.C.; and no fewer than three of his successors had shared the same fate. Isocrates now urges Thebe, the daughter of Jason, and her half-brothers to set up a popular government. The date is 359 B.C.<sup>1</sup> The letter to Archidamus II. (ix.)—the same person who is the imaginary speaker of Oration vi.—urges him to execute the writer's favorite idea,— "to deliver the Greeks from their feuds, and to crush barbarian insolence." It is remarkable for a vivid picture of the state of Greece; the date is about 356 B.C. The letter to Timotheus (vii., 345 B.C.), ruler of Heraclea on the Euxine, introduces an Athenian friend who is going thither, and at the same time offers some good counsels to the benevolent despot. The letter "to the government of Mytilene" (viii., 350 B.C.) is a petition to a newly established oligarchy, begging them to permit the return of a democratic exile, a distinguished musician named Agenor. The first of the two letters to Philip of Macedonia (ii.) remonstrates with him on the personal danger to which he had recklessly exposed himself, and alludes to his beneficent intervention in the affairs of Thessaly; the date is probably the end of 342 B.C. The letter to Alexander (v.), then a boy of fourteen, is a brief greeting sent along with the last, and congratulates him on preferring "practical" to "eristic" studies—a distinction which is explained by the sketch of the author's φιλοσοφία, and of his essay "Against the Sophists," given above. It was just at this time, probably, that Alexander was beginning to receive the lessons of Aristotle (342 B.C.). The letter to Antipater (iv.) introduces a friend who wished to enter the military service of Philip. Antipater was then acting as regent in Macedonia during Philip's absence in Thrace (340-339 B.C.). The latter of the two letters (iii.) appears to have been written shortly after the battle of Chaeronea in 338 B.C. The questions raised by it have already been discussed.

No lost work of Isocrates is known from a definite quotation, except an "Art of Rhetoric," from which some scattered precepts are cited. Quintilian, indeed, and Photius, who had seen this "Art," felt a doubt as to whether it was genuine. Only twenty-five discourses—out of an ascriptive total of some sixty—were admitted as authentic by Dionysius; Photius (*circ. A.D. 850*) knew only the number now extant—twenty-one.

With the exception of extracts at the end of Or. xiii., at the beginning of Or. vi. and probably at the end of Letters ii., vi., ix., the existing text is free from serious mutilations. It is also unusually pure. The smooth and clear style of Isocrates gave few opportunities for the mistakes of copyists. On the other hand, he was a favourite author of the schools. Numerous glosses crept into his text through the comments or conjectures of rhetoricians. This was already the case before the 6th century, as is attested by the citations of Priscian and Stobæus. Jerome Wolf and Koræa successively accomplished much for the text. But a more decided advance was made by Immanuel Bekker. He used five MSS., viz. (1) Codex Urbina III.; (2) the best, with the principal guide; (3) Vaticanus 936, A.; (4) Laurentianus 87, 14; (5) third century; (6) Vaticanus 65, A.; and (5) Marcianus 415, E. The first three, of the same family, have Or. xv. entire; the last two arc from the same original, and have Or. xv. incomplete.

J. G. Baiter and H. Sauppe in their edition (1850) follow Γ "even more constantly than Bekker." Their apparatus is enriched, however, by a MS. to which he had not access—Ambrosianus O. 144, E, which in some cases, as they recognize, has alone preserved the true reading. The readings of this MS. were given in full by G. E. Benseler in his second edition (1854-1855). The distinctive characteristic of Benseler's textual criticism was a tendency to correct the text against even the best MSS., where the MS. conflicted with the usage of Isocrates as inferred from his recorded precepts or from the statements of ancient writers. Thus, on the strength of the rule ascribed to Isocrates—*σοφία ἢ οὐκ ἔστιν*—Benseler would remove from the text every example of hiatus (on the MSS. of Isocrates, see H. Bürmann, *Die handschriftliche Überlieferung des Isocrates*, Berlin, 1885-1886, and E. Drerup, in *Leipzig Studien*, VIII., 1895).

Editions.—In *Oratores Attici*, ed. Imm. Bekker (1823, 1828); W. Dobson (1828); J. G. Baiter and Hermann Sauppe (1850). Separately *Asgeschalt*, *Reden*, *Panegyriks* and *Antropologien*, by Rudolf Rauchenstein, 6th ed., Karl Münchser (1908); in Teubner's series, by G. E. Benseler (new ed.), by F. Blass, 1886-1895) and by E. Drerup (1906); *Ad Demonicum at Panegyricus*, ed. J. E. Sandys (1868); *Evagoras*, ed. H. Clarke (1885). Extracts from Orations iii., iv., vi., vii., viii., ix., xiii., xiv., xv., xix., and Letters iii., v., edited with revised text and commentary, in *Selections from the Attic Orators*, by R. C. Jebb (1880); vol. i. of an English prose translation, with introduction and notes by J. H. Freese, has been published in Bohn's *Classical Library* (1894). See generally Jebb's

*Attic Orators* (where a list of authorities is given) and F. Blass, *Die attische Beredsamkeit* (2nd ed., 1887-1898), and the latter's *Die Rhythmen der attischen Kunstprosa* (1901). There is a special lexicon by S. Preuss (1904). On the philology of Isocrates and his relation to the Socratic schools, see Thompson's ed. of Plato's *Phædrus*, Appendix 2.

**ISODYNAMIC LINES** (Gr. *ισοδυναμιας*, equal in power), lines connecting those parts of the earth's surface where the magnetic force has the same intensity (see MAGNETISM, TERRESTRIAL).

**ISOGENIC LINES** (Gr. *ισογενιας*, equiangular), lines connecting those parts of the earth's surface where the magnetic declination is the same in amount (see MAGNETISM, TERRESTRIAL).

**ISOLA DEL LIRI**, a town of Campania, in the province of Caserta, Italy, 15 m. by rail N.N.W. of Roccaseca, which is on the main line from Rome to Naples, 10 m. N.W. of Cassino. Pop. (1901), town, 2384; commune, 8244. The town consists of two parts, Isola Superiore and Isola Inferiore; as its name implies it is situated between two arms of the Liri. The many waterfalls of this river and of the Fibreno afford motive power for several important paper-mills. Two of the falls, 80 ft. in height, are especially fine. About 1 m. to the N. is the church of San Domenico, erected in the 12th century, which probably marks the site of the villa of Cicero (see ARPINO).

**ISOMERISM**, in chemistry. When Wöhler, in 1825, analysed his cyanic acid, and Liebig his quite different fulminic acid in 1824, the composition of both compounds proved to be absolutely the same, containing each in round numbers 28% of carbon, 33% of nitrogen, 37% of oxygen and 2% of hydrogen. This fact, inconsistent with the then dominating conception that difference in qualities was due to difference in chemical composition, was soon corroborated by others of analogous nature, and so Berzelius introduced the term *isomerism* (Gr. *ισομερης*, composed of equal parts) to denominate the existence of the property of substances having different qualities, in chemical behaviour as well as physical, notwithstanding identity in chemical composition. These phenomena were quite in accordance with the atomic conception of matter, since a compound containing the same number of atoms of carbon, nitrogen, oxygen and hydrogen as another in the same weight might differ in internal structure by different arrangements of those atoms. Even in the time of Berzelius the newly introduced conception proved to include two different groups of facts. The one group included those isomers where the identity in composition was accompanied by identity in molecular weight, *i.e.* the vapour densities of the isomers were the same, as in butylene and isobutylene, to take the most simple case; here the molecular conception admits that the isolated groups in which the atoms are united, *i.e.* the molecules, are identical, and so the molecule of both butylene and isobutylene is indicated by the same chemical symbol C<sub>4</sub>H<sub>8</sub>, expressing that each molecule contains, in both cases, four atoms of carbon (C) and eight of hydrogen (H). This group of isomers was denominated *metamers* by Berzelius, and now often "isomers" (in the restricted sense), whereas the term *polymerism* (Gr. *πολυς*, many) was chosen for compounds like butylene, C<sub>4</sub>H<sub>8</sub>, and ethylene, C<sub>2</sub>H<sub>4</sub>, corresponding to the same composition in weight but differing in molecular formula, and having different densities in gas or vapour, a litre of butylene and isobutylene weighing, for instance, under ordinary temperature and pressure, about 2.5 gr.; ethylene only one-half as much, since density is proportional to molecular weight.

A further distinction is necessary to a survey of the subdivisions of isomerism regarded in its widest sense. There are subtle and more subtle differences causing isomerism. In the case of metamerism we can imagine that the atoms are differently linked, say in the case of butylene that the atoms of carbon are joined together as a continuous chain, expressed by —C—C—C—C—, normally as it is called, whereas in isobutylene the fourth atom of carbon is not attached to the third but to the second carbon atom, *i.e.* —C—C—C—C—. Now there are cases in which analogy of internal structure goes so far as to exclude even that difference in linking, the only remaining possibility

<sup>1</sup> This was shown by R. C. Jebb in a paper on "The Sixth Letter of Isocrates," *Journal of Philology*, v. 266 (1874). The fact that Thebe, widow of Alexander of Phœria, was the daughter of Jason is incidentally noticed by Plutarch in his life of Pelopidas, c. 28. It is this fact which gives the clue to the occasion of the letter; cf. Diod. Sic. xvi. 14.

then being the difference in relative position. This kind of isomerism has been denominated *stereoisomerism* (g.v.) often stereomerism. But there is a last group belonging here in which identity of structure goes farthest. There are substances such as sulphur, showing difference of modification in crystalline state—the ordinary rhombic form in which sulphur occurs as a mineral, while, after melting and cooling, long needles appear which belong to the monosymmetric system. These differences, which go hand in hand with those in other properties, e.g. specific heat and specific gravity, are absolutely confined to the crystalline state, disappearing with it when both modifications of sulphur are melted, or dissolved in carbon disulphide or evaporated. So it is natural to admit that here we have to deal with identical molecules, but that only the internal arrangement differs from case to case as identical balls may be grouped in different ways. This case of difference in properties combined with identical composition is therefore called *polymorphism*.

To summarize, we have to deal with polymerism, metamorphism, stereoisomerism, polymorphism; whereas phenomena denominated tautomerism, pseudomerism and desmotropism form different particular features of metamorphism, as well as the phenomena of allotropy, which is merely the difference of properties which an element may show, and can be due to polymerism, as in oxygen, where by the side of the ordinary form with molecules  $O_2$ , we have the more active ozone with  $O_3$ . Polymorphism in the case of an element is illustrated in the case of sulphur, whereas metamorphism in the case of elements has so far as yet not been observed; and is hardly probable, as most elements are built up, like the metals, from molecules containing only one atom per molecule; here metamorphism is absolutely excluded, and a considerable number of the rest, having diatomic molecules, are about in the same condition. It is only in cases like sulphur with octatomic molecules, where a difference of internal structure might play a part.

Before entering into detail it may be useful to consider the nature of isomerism from a general standpoint. It is probable that the whole phenomenon of isomerism is due to the possibility that compounds or systems which in reality are unstable yet persist, or so slowly change that practically one can speak of their stability; for instance, such systems as explosives and a mixture of hydrogen and oxygen, where the stable form is water, and in which, according to some, a slow but until now undetected change takes place even at ordinary temperatures. Consequently, of each pair of isomers we may establish beforehand which is the more stable; either in particular circumstances, a direct change taking place, as, for instance, with maleic acid, which when exposed to sunlight in presence of a trace of bromine, yields the isomeric fumaric acid almost at once, or, indirectly, one may conclude that the isomer which forms under greater heat-development is the more stable, at least at lower temperatures. Now, whether a real, though undetected, change occurs is a question to be determined from case to case; it is certain, however, that a substance like aragonite (a mineral form of calcium carbonate) has sensibly persisted in geological periods, though the polymorphous calcite is the more stable form. Nevertheless, the theoretical possibility, and its realization in many cases, has brought considerations to the front which have recently become of predominant interest; consequently the possible transformations of isomers and polymers will be considered later under the denomination of reversible or dynamical isomerisms.

Especially prominent is the fact that polymerism and metamorphism are mainly reserved to the domain of organic chemistry, or the chemistry of carbon, both being discovered there; and, more especially, the phenomenon of metamorphism in organic chemistry has largely developed our notions concerning the structure of matter. That this particular feature belongs to carbon compounds is due to a property of carbon which characterizes the whole of organic chemistry, i.e. that atoms attached to carbon, to express it in the atomic style, cling more intensely to it than, for instance, when combined with oxygen. This

explains a good deal of the possible instability; and, from a practical point of view, it coincides with the fact that such a large amount of energy can be stored in our most intense explosives such as dynamite, the explanation being that hydrogen is attached to carbon distant from oxygen in the same molecule, and that only the characteristic resistance of the carbon linkage prevents the hydrogen from burning, which is the main occurrence in the explosion of dynamite. The possession of this peculiar property by carbon seems to be related to its high valency, amounting to four; and, generally, when we consider the most primitive expression of isomerism, viz. the allotropy of elements, we meet this increasing resistance with increasing valency. The monovalent iodine, for instance, is transformed by heating into an allotropic form, corresponding to the formula I, whereas ordinary iodine answers to  $I_2$ . Now these modifications show hardly any tendency to persist, the one stable at high temperatures being formed at elevated temperatures, but changing in the reverse sense on cooling. In the divalent oxygen we meet with the modification called ozone, which, although unstable, changes but slowly into oxygen. Similarly the trivalent phosphorus in the ordinary white form shows such resistance as if it were practically stable; on the other hand the red modification is in reality also stable, being formed, for instance, under the influence of light. In the case of the quadrivalent carbon, diamond seems to be the stable form at ordinary temperatures, but one may wait long for it is formed from graphite.

This connexion of isomerism with resistant linking, and of this with high valency, explains, in considerable measure, why inorganic compounds afforded, as a rule, no phenomena of this kind until the systematic investigation of metallic compounds by Werner brought to light many instances of isomerism in inorganic compounds. Whereas carbon renders isomerism possible in organic compounds, cobalt and platinum are the determining elements in inorganic chemistry, the phenomena being exhibited especially by complex ammoniacal derivatives. The constitution of these inorganic isomers is still somewhat questionable; and in addition it seems that polymerism, metamorphism and stereoisomerism play a part here, but the general feature is that cobalt and platinum act in them with high valency, probably exceeding four. The most simple case is presented by the two platinum compounds  $PtCl_2(NH_3)_2$ , the platosemidiammine chloride of Peyrone, and the platossamine chloride of Jules Reiset, the first formed according to the equation  $PtCl_4K_2 + 2NH_3 = PtCl_2(NH_3)_2 + 2KCl$ , the second according to  $Pt(NH_3)_4Cl_2 = PtCl_2(NH_3)_2 + 2NH_3$ , these compounds differing in solubility, the one dissolving in 33, the other in 160 parts of boiling water. With cobalt the most simple case was discovered in 1892 by S. Jørgensen in the second dinitrotetramminecobalt chloride,  $[Co(NO_2)_2(NH_3)_4]Cl$ , designated as flavo—whereas the older isomer of Gibbs was distinguished as croce-salt. An interesting lecture on the subject was delivered by A. Werner before the German chemical society (*Ber.*, 1907, 40, p. 15). (See COBALT; PLATINUM.)

Dealing with organic compounds, it is metamorphism that deserves chief attention, as it has largely developed our notions as to molecular structure. Polymerism required no particular explanation, since this was given by the difference in molecular magnitude. One general remark, however, may be made here. There are polymers which have hardly any inter-relations other than identity in composition; on the other hand, there are others which are related by the possibility of mutual transformation; examples of this kind are cyanic acid (CNOH) and cyanuric acid (CNOH)<sub>3</sub>, the latter being a solid which readily transforms into the former on heating as an easily condensable vapour; the reverse transformation may also be realized; and the polymers methylene oxide (CH<sub>2</sub>O) and trioxymethylene (CH<sub>2</sub>O)<sub>3</sub>. In the first group we may mention the homologous series of hydrocarbons derived from ethylene, given by the general formula  $C_nH_{2n}$ , and the two compounds methylene-oxide and honey-sugar  $C_6H_{12}O_6$ . The cases of mutual transformation are generally characterized by the fact

that in the compound of higher molecular weight no new links of carbon with carbon are introduced, the trioxymethylene being probably  $O \begin{array}{c} \diagup \\ \text{CH}_2 \\ \diagdown \\ \text{O} \end{array} \text{CH}_2$ , whereas honey-sugar corresponds to  $\text{CH}_2\text{OH}\cdot\text{CHOH}\cdot\text{CHOH}\cdot\text{CHOH}\cdot\text{CHOH}\cdot\text{CHO}$ , each point representing a linking of the carbon atom to the next. This observation is closely related to the above-mentioned resistivity of the carbon-link, and corroborates it in a special case. As carbon tends to hold the atom attached to it, one may presume that this property expresses itself in a predominant way where the other element is carbon also, and so the linkage represented by  $-\text{C}-\text{C}-$  is one of the most difficult to loosen.

The conception of metamorphism, or isomerism in restricted sense, has been of the highest value for the development of our notions concerning molecular structure, *i.e.* the conception as to the order in which the atoms composing a molecule are linked together. In this article we shall confine ourselves to the fatty compounds, from which the fundamental notions were first obtained; reference may be made to the article **CHEMISTRY: Organic**, for the general structural relations of organic compounds, both fatty and aromatic.

A general philosophical interest is attached to the phenomena of isomerism. By Wilhelm Ostwald especially, attempts have been made to substitute the notion of atoms and molecular structure by less hypothetical conceptions; these ideas may some day receive thorough confirmation, and when this occurs science will receive a striking impetus. The phenomenon of isomerism will probably supply the crucial test, at least for the chemist, and the question will be whether the Ostwaldian conception, while substituting the Daltonian hypothesis, will also explain isomerism. An early step accomplished by Ostwald in this direction is to define ozone in its relation to oxygen, considering the former as differing from the latter by an excess of energy, measurable as heat of transformation, instead of defining the difference as diatomic molecules in oxygen, and triatomic in ozone. Now, in this case, the first definition expresses much better the whole chemical behaviour of ozone, which is that of "energetic" oxygen, while the second only includes the fact of higher vapour-density; but in applying the first definition to organic compounds and calling isobutylene "butylene with somewhat more energy" hardly anything is indicated, and all the advantages of the atomic conception—the possibility of exactly predicting how many isomers a given formula includes and how you may get them—are lost.

To Kekulé is due the credit of taking the decisive step in introducing the notion of tetravalent carbon in a clear way, *i.e.* in the property of carbon to combine with four different monatomic elements at once, whereas nitrogen can only hold three (or in some cases five), oxygen two (in some cases four), hydrogen one. This conception has rendered possible a clear idea of the linking or internal structure of the molecule, for example, in the most simple case, methane,  $\text{CH}_4$ , is expressed by



It is by this conception that possible and impossible compounds are at once fixed. Considering the hydrocarbons given by the general formula  $\text{C}_x\text{H}_y$ , the internal linkages of the carbon atoms need at least  $x-1$  bonds, using up  $2(x-1)$  valencies of the  $4x$  to be accounted for, and thus leaving no more than  $2(x+1)$  for binding hydrogen: a compound  $\text{C}_x\text{H}_y$  is therefore impossible, and indeed has never been met. The second prediction is the possibility of metamorphism, and the number of metamers, in a given case among compounds, which are realizable. Considering the predicted series of compounds  $\text{C}_x\text{H}_{2x+2}$ , which is the well-known homologous series of methane, the first member, the possible of isomerism lies in that of a different linking of the carbon atoms. This first presents itself when

four are present, *i.e.* in the difference between  $\text{C}-\text{C}-\text{C}-\text{C}$  and  $\begin{array}{c} \text{C}-\text{C} \\ | \\ \text{C} \end{array}$ . With this compound  $\text{C}_4\text{H}_{10}$ , named butane,

isomerism is actually observed, being limited to a pair, whereas the former members ethane,  $\text{C}_2\text{H}_6$ , and propane,  $\text{C}_3\text{H}_8$ , showed no isomerism. Similarly, pentane,  $\text{C}_5\text{H}_{12}$ , and hexane,  $\text{C}_6\text{H}_{14}$ , may exist in three and five theoretically isomeric forms respectively; confirmation of this theory is supplied by the fact that all these compounds have been obtained, but no more. The third most valuable indication which molecular structure gives about these isomers is how to prepare them, for instance, that normal hexane, represented by  $\text{CH}_3\cdot\text{CH}_2\cdot\text{CH}_2\cdot\text{CH}_2\cdot\text{CH}_2\cdot\text{CH}_3$ , may be obtained by action of sodium on propyl iodide,  $\text{CH}_3\cdot\text{CH}_2\cdot\text{CH}_2\cdot\text{I}$ , the atoms of iodine being removed from two molecules of propyl iodide, with the resulting fusion of the two systems of three carbon atoms into a chain of six carbon atoms. But it is not only the formation of different isomers which is included in their constitution, but also the different ways in which they will decompose or give other products. As an example another series of organic compounds may be taken, *viz.* that of the alcohols, which only differ from the hydrocarbons by having a group OH, called hydroxyl, instead of H, hydrogen; these compounds, when derived from the above methane series of hydrocarbons, are expressed by the general formula  $\text{C}_x\text{H}_{2x+1}\text{OH}$ . In this case it is readily seen that isomerism introduces itself in the three carbon atom derivative: the propyl alcohols, expressed by the formulae  $\text{CH}_3\cdot\text{CH}_2\cdot\text{CH}_2\text{OH}$  and  $\text{CH}_3\cdot\text{CHOH}\cdot\text{CH}_3$ , are known as propyl and isopropyl alcohol respectively. Now in oxidizing, or introducing more oxygen, for instance, by means of a mixture of sulphuric acid and potassium bichromate, and admitting that oxygen acts on both compounds in analogous ways, the two alcohols may give (as they lose two atoms of hydrogen)  $\text{CH}_3\cdot\text{CH}_2\cdot\text{COH}$  and  $\text{CH}_3\text{CO}\cdot\text{CH}_3$ . The first compound, containing a group COH, or more explicitly  $\text{O}=\text{C}-\text{H}$ , is an aldehyde, having a pronounced reducing power, producing silver from the oxide, and is therefore called propylaldehyde; the second compound containing the group  $-\text{C}\cdot\text{CO}\cdot\text{C}-$  behaves differently but just as characteristically, and is a ketone, it is therefore denominated propylketone (also acetone or dimethyl ketone). And so, as a rule, from isomeric alcohols, those containing a group  $-\text{CH}_2\text{OH}$ , yield by oxidation aldehydes and are distinguished by the name primary; whereas those containing  $\text{CH}\cdot\text{OH}$ , called secondary, produce ketones. (Compare **CHEMISTRY: Organic**.)

The above examples may illustrate how, in a general way, chemical properties of isomers, their formation as well as transformation, may be read in the structure formula. It is different, however, with physical properties, density, &c.; at present we have no fixed rules which enable us to predict quantitatively the differences in physical properties corresponding to a given difference in structure, the only general rule being that those differences are not large.

Perhaps a satisfactory point of view may be here obtained by applying the van der Waals' equation  $\bar{A}(P+a/V^2)(V-b)=RT$ , which connects volume  $V$ , pressure  $P$  and temperature  $T$  (see **CONDENSATION OF GASES**). In this equation  $a$  relates to molecular attraction; and it is not improbable that in isomeric molecules, containing in sum the same amount of the same atoms, those mutual attractions are approximately the same, whereas the chief difference lies in the value of  $b$ , that is, the volume occupied by the molecule itself. For what reason this volume may differ from case to case lies close at hand; in connexion with the notion of negative and positive atoms, like chlorine and hydrogen, experience tends to show that the former, as well as the latter, have a mutual repulsive power, but the former acts on the latter in the opposite sense; the necessary consequence is that, when those negative and positive groups are distributed in the molecule, its volume will be smaller than if the negative elements are heaped together. An example may prove this, but before quoting it, the question of determining  $b$  must be decided; this results immediately from the above quotation  $b$  being the volume  $V$  at the absolute zero ( $T=0$ ); so the volume of isomers ought to be compared at the absolute zero. Since this has not been done we must adopt the approximate rule that the volume at absolute zero is proportional to that at the boiling-point. Now taking the isomers  $\text{H}_3\text{C}\cdot\text{C}\cdot\text{Cl}_2$  ( $M_2 = 108$ ) and  $\text{H}_2\text{C}\cdot\text{C}\cdot\text{HCl}$  ( $M_2 = 103$ ), we see the negative chlorine atoms heaped up in the left hand

formula, but distributed in the second; the former therefore may be presumed to occupy a larger space, the molecular volume, that is, the volume in cubic centimetres occupied by the molecular weight in grams, actually being 108 in the former, and 103 in the latter case (compare CHEMISTRY: *Physical*). An analogous remark applies to the boiling-point of isomers. According to the above formula the critical temperature is given by  $86AN/54b$ , and as the critical temperature is approximately proportional to the boiling-point, both being estimated on the absolute scale of temperature, we may conclude that the larger value of  $b$  corresponds to the lower boiling-point, and indeed the isomer corresponding to the left-hand formula boils at  $74^\circ$ , the other at  $114^\circ$ . Other physical properties might be considered; as a general rule they depend upon the distribution of negative and positive elements in the molecule.

**Reversible (dynamical) Isomerism.**—Certain investigations on isomerism which have become especially prominent in recent times bear on the possibility of the mutual transformation of isomers. As soon as this reversibility is introduced, general laws related to thermodynamics are applicable (see CHEMICAL ACTION; ENERGETICS). These laws have the advantage of being applicable to the mutual transformations of isomers, whatever be the nature of the deeper origin, and so bring polymerism, metamerism and polymorphism together. As they are pursued furthest in the last case, this may be used as an example. The study of polymorphism has been especially pursued by Otto Lehmann, who proved that it is an almost general property; the variety of forms which a given substance may show is often great, ammonium nitrate, for instance, showing at least four of them before melting. The general rule which correlates this polymorphic change is that its direction changes at a given temperature. For example, sulphur is stable in the rhombic form till  $95.4^\circ$ , from then upwards it tends to change over into the prismatic form. The phenomenon absolutely corresponds to that of fusion and solidification, only that it generally takes place less quickly; consequently we may have prismatic sulphur at ordinary temperature for some time, as well as rhombic sulphur at  $100^\circ$ . This may be expressed in the chosen case by a symbol: "rhombic sulphur  $95.4^\circ$   $\rightleftharpoons$  prismatic sulphur," indicating that there is equilibrium at the so-called "transition-point,"  $95.4^\circ$ , and opposite change below and above.

This comparison with fusion introduces a second notion, that of the "triple-point," this being in the melting-phenomenon the only temperature at which solid, liquid and vapour are in equilibrium, in other words, where three phases of one substance are co-existent. This temperature is somewhat different from the ordinary melting-point, the latter corresponding to atmospheric pressure, the former to the maximum vapour-pressure; and so we come to a third relation for polymorphism. Just as the melting-point changes with pressure, the transition-point also changes; even the same quantitative relation holds for both, as L. J. Reicher proved with sulphur:  $\alpha T/\alpha P = \Delta T/g$ ,  $\alpha$  being the change in volume which accompanies the change from rhombic to prismatic sulphur, and  $g$  the heat absorbed. Both formula and experiment proved that an increase of pressure of one atmosphere elevated the transition point for about  $0.04^\circ$ . The same laws apply to cases of more complicated nature, and one of them, which deserves to be pursued further, is the mutual transformation of cyanuric acid,  $C_3H_3N_3O_3$ , cyanic acid,  $CHNO$ , and cyamelide  $(CHNO)_2$ ; the first corresponding to prismatic sulphur, stable at higher temperatures, the last to rhombic, the equilibrium-symbol being: cyamelide  $150^\circ$   $\rightleftharpoons$  cyanuric acid; the cyanic acid corresponds to sulphur vapour, being in equilibrium with either cyamelide or cyanuric acid at a maximum pressure, definite for each temperature.

A second law for these mutual transformations is that when they take place without loss of homogeneity, for example, in the liquid state, the definite transition point disappears and the change is gradual. This seems to be the case with molten sulphur, which, when heated, becomes dark-coloured and plastic; and also in the case of metals, which obtain or lose magnetic properties without loss of continuous structure. At the same time, however, the transition point sometimes reappears even in the liquid

state; in such cases two layers are formed, as has been recently observed with sulphur, and by F. M. Jäger in complicated organic compounds. Thus the introduction of heterogeneity, or the appearance of a new phase, demands the existence of a fixed temperature of transformation.

On the basis of the relation between physical phenomena and thermodynamical laws, properties of the polymorphous compounds may be predicted. The chief consideration here is that the stable form must have the lower vapour pressure, otherwise, by distillation, it would transform in opposite sense. From this it follows that the stable form must have the higher melting-point, since at the melting-point the vapour of the solid and of the liquid have the same pressure. Thus prismatic sulphur has a higher melting-point ( $120^\circ$ ) than the rhombic form ( $116^\circ$ ), and it is even possible to calculate the difference theoretically from the thermodynamic relations. A third consequence is that the stable form must have the smaller solubility: J. Meyer and J. N. Brönsted found that at  $25^\circ$ , 10 c.c. of benzene dissolved 0.25 and 0.18 gr. of prismatic and rhombic sulphur respectively. It can be easily seen that this ratio, according to Henry's law, must correspond to that of vapour-pressures, and so be independent of the solvent; in fact, in alcohol the figures are 0.0066 and 0.0052. Recently Hermann Walther Nernst has been able to deduce the transition-point in the case of sulphur from the specific heat and the heat developed in the transition only. This best studied case shows that a number of mutual relations are to be found between the properties of two modifications when once the phenomenon of mutual transformation is accessible.

In ordinary isomers indications of mutual transformation often occur; and among these the predominant fact is that denoted as tautomerism or pseudomerism. It exhibits itself in the peculiar behaviour of some organic compounds containing the group  $-C-CO-C-$ , e.g.  $CH_3CO-CHX-CO_2C_2H_5$ , derivatives of acetoacetic ester. These compounds generally behave as ketones; but at the same time they may act as alcohols, i.e. as if containing the OH group; this leads to the formula  $H_2C-C(OH):CX-CO_2C_2H_5$ . In reality such tautomeric compounds are apparently a mixture of two isomers in equilibrium, and indeed in some cases both forms have been isolated; then one speaks of *desmotropy* (Gr. *desmōs*, a bond or link, and *τροπή*, a turn or change). Nevertheless, the relations obtained in reversible cases such as sulphur have not yet found application in the highly interesting cases of ordinary irreversible isomerism.

A further step in this direction has been effected by the introduction of reversibility into a non-reversible case by means of a catalytic agent. The substance investigated was acetaldehyde,  $C_2H_4O$ , in its relation to paraldehyde, a polymeric modification. The phenomena were first observed without mutual transformation, aldehyde melting at  $-118^\circ$ , paraldehyde at  $13^\circ$ , the only mutual influence being a lowering of melting-point, with a minimum at  $-120^\circ$  in the eutectic point. When a catalytic agent, such as sulphurous acid, is added, which produces a mutual change, the whole behaviour is different; only one melting-point, viz.  $7^\circ$ , is observed for all mixtures; this has been called the "natural melting-point." It corresponds to one of the melting-points in the series without catalytic agents, viz. in that mixture which contains 88% of paraldehyde and 12% of acetaldehyde, which the catalytic agent leaves unaffected. Such an introduction of reversibility is also possible by allowing sufficient time to permit the transformation to be produced by itself. By R. Rothe and Alexander Smith's interesting observations on sulphur, results have been obtained which tend to prove that the melting-point, as well as the appearance of two layers in the liquid state, correspond to unstable conditions. (J. H. VAN'T H.)

**ISOTHERM** (Gr. *isos*, equal, and *θερμη*, heat), a line upon a map connecting places where the temperature is the same at sea-level on the earth's surface. These isothermal lines will be found to vary from month to month over the two hemispheres, or over local areas, during summer and winter, and their position is modified by continental or oceanic conditions.

**ISOXAZOLES**, monazole chemical compounds corresponding to furfuran, in which the  $\text{=CH}$  group adjacent to the oxygen atom is replaced by a nitrogen atom, and therefore they contain the ring system

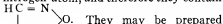

They may be prepared by the elimination of water from the monoximes of  $\beta$ -diketones,  $\beta$ -ketone aldehydes or oxymethylene ketones (L. Claisen, *Ber.*, 1891, 24, p. 3006), the general reaction proceeding according to the equation

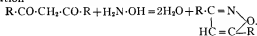

W. Dunstan and T. S. Dymond (*Jour. Chem. Soc.*, 1891, 49, p. 410) have also prepared isoxazoles by the action of alkalis on nitroparaffins, but have not been able to obtain the parent substance. Those isoxazoles in which the carbon atom adjacent to nitrogen is substituted are stable compounds, but if this is not the case, rearrangement of the molecule takes place and nitriles are formed. The isoxazoles are feebly basic.

The *isoxazolones* are the keto derivatives of the as yet unknown dihydroisoxazole, and are compounds of strongly acid nature, decomposing the carbonates of the alkaline earth metals and forming salts with metals and with ammonia. Their constitution is not yet definitely fixed and they may be regarded as derived from one of the three types

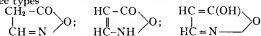

By the action of nitrous acid on the oxime of *o*-aminobenzophenone as a *p*-phenyl indoxazene,  $\text{C}_6\text{H}_4-\text{C}(\text{O})=\text{N}\cdot\text{N}=\text{C}_6\text{H}_5$ , is obtained; this is a derivative of benzisoxazole.

**ISRAEL** (Hebrew for "God strives" or "rules"; see Gen. xxxii. 28; and the allusion in Hosea xii. 4), the national designation of the Jews. Israel was a name borne by their ancestor Jacob the father of the twelve tribes. For some centuries the term was applied to the northern kingdom, as distinct from Judah, although the feeling of national unity extended it so as to include both. It emphasizes more particularly the position of the Hebrews as a religious community, bound together by common aims and by their covenant-relation with the national God, Yahweh.

See further JACOB, HEBREW LANGUAGE, HEBREW RELIGION, JEWS: *History and Palestine*.

**ISRAELI, ISAAC BEN SOLOMON** (9th–10th centuries), Jewish physician and philosopher. A contemporary of Seadiah (*q.v.*), he was born and passed his life in North Africa. He died c. 950. At Kairawan, Israeli was court physician; he wrote several medical works in Arabic, and these were afterwards translated into Latin. Similarly his philosophical writings were translated, but his chief renown was in the circle of Moslem authors.

**ISRAËLS, JOSEF** (1824– ), Dutch painter, was born at Groningen, of Hebrew parents, on the 27th of January 1824. His father intended him to be a man of business, and it was only after a determined struggle that he was allowed to enter on an artistic career. However, the attempts he made under the guidance of two second-rate painters in his native town—Buyfs and van Wicheren—while still working under his father as a stockbroker's clerk, led to his being sent to Amsterdam, where he became a pupil of Jan Kruseman and attended the drawing class at the academy. He then spent two years in Paris, working in Picot's studio, and returned to Amsterdam. There he remained till 1870, when he moved to The Hague for good. Israëls is justly regarded as one of the greatest of Dutch painters. He has often been compared to J. F. Millet. As artists, even more than as painters in the strict sense of the word, they both, in fact, saw in the life of the poor and humble a motive for expressing with peculiar intensity their wide human sympathy; but Millet was the poet of placid rural life, while in almost all Israëls' pictures we find some piercing note of woe. Duranty said of them that "they were painted with gloom and suffering."

He began with historical and dramatic subjects in the romantic style of the day. By chance, after an illness, he went to recruit his strength at the fishing-town of Zandvoort near Haarlem, and there he was struck by the daily tragedy of life. Thenceforth he was possessed by a new vein of artistic expression, sincerely realistic, full of emotion and pity. Among his more important subsequent works are "The Zandvoort Fisherman" (in the Amsterdam gallery), "The Silent House" (which gained a gold medal at the Brussels Salon, 1858) and "Village Poor" (a prize at Manchester). In 1862 he achieved great success in London with his "Shipwrecked," purchased by Mr Young, and "The Cradle," two pictures of which the *Athenaeum* spoke as "the most touching pictures of the exhibition." We may also mention among his mature works "The Widower" (in the Mesdag collection), "When we grow Old" and "Alone in the World" (Amsterdam gallery), "An Interior" (Dordrecht gallery), "A Frugal Meal" (Glasgow museum), "Toilers of the Sea," "A Speechless Dialogue," "Between the Fields and the Seashore," "The Bric-à-brac Seller" (which gained medals of honour at the great Paris Exhibition of 1900). "David Singing before Saul," one of his latest works, seems to hint at a return on the part of the venerable artist to the Rembrandtesque note of his youth. As a water-colour painter and etcher he produced a vast number of works, which, like his oil paintings, are full of deep feeling. They are generally treated in broad masses of light and shade, which give prominence to the principal subject without any neglect of detail.

See Jan Veth, *Mannen of Betekenis: Jozef Israëls; Chesneau, Peintres français et étrangers; Ph. Zilcken, Peintres hollandais modernes* (1893); Dumas, *Illustrated Biographies of Modern Artists* (1882–1884); J. de Meester, in Max Rooses' *Dutch Painters of the Nineteenth Century* (1898); Jozef Israëls, *Spain: the Story of a Journey* (1900).

**ISSACHAR** (a Hebrew name meaning apparently "there is a hire," or "reward"; Jacob's ninth "son," his fifth by Leah; also the name of a tribe of Israel. Slightly differing explanations of the reference in the name are given in Gen. xxx. 16 (J) and v. 18 (E)). The territory of the tribe (Joshua xix. 17–23) lay to the south of that allotted to Zebulun, Naphtali, Asher and Dan, and included the whole of the great plain of Esdraelon, and the hills to the east of it, the boundary in that direction extending from Tabor to the Jordan, apparently along the deep gorge of Wadi el Bireh. In the rich territory of Issachar, traversed by the great commercial highway from the Mediterranean and Egypt to Bethshean and the Jordan, were several important towns which remained in the hands of the Canaanites for some time (Judges i. 27), separating the tribe from Manasseh. Although Issachar is mentioned as having taken some part in the war of freedom under Deborah (Judges v. 15), it is impossible to misunderstand the reference to its tributary condition in the blessing of Jacob (Gen. xlix. 14 seq.), or the fact that the name of this tribe is omitted from the list given in Judges i. of those who bestirred themselves against the earlier inhabitants of the country. In the "blessing upon Zebulun and Issachar" in Deut. xxxiii. 18 seq., reference is made to its agricultural life in terms suggesting that along with its younger, but more successful "brother," it was the guardian of a sacred mountain (Carmel, Tabor?) visited periodically for sacrificial feasts.

**ISSEDONES**, an ancient people of Central Asia at the end of the trade route leading north-east from Scythia (*q.v.*), described by Herodotus (iv. 26). The position of their country is fixed as the Tarym basin by the more precise indications of Ptolemy, who tells how a Syrian merchant penetrated as far as Issedon. They had their wives in common and were accustomed to slay the old people, eat their flesh and make cups of their skulls. Such usages survived among Tibetan tribes and make it likely that the Issedones were of Tibetan race. Some of the Issedones seem to have invaded the country of the Massagetae to the west, and similar customs are assigned to a section of these. (E. H. M.)

<sup>1</sup> On the origin of the name, see the article by H. W. Hogg, *Ency. Bib.* col. 2290; E. Meyer, *Israeliten*, p. 536 seq.

**ISSERLEIN, ISRAEL** (d. 1460), German Talmudist. His fame attracted many students to Neustadt, and his profound learning did much to revive the study of the original Rabbinic authorities. After the publication of the Code of Joseph Caro (*g.e.*) the decisions of Isserlein in legal matters were added in notes to that code by Moses Isserles. His chief works were *Terumat ha-Deshen* (354 decisions) and *Peasqim u-kethaḥim* (267 decisions) largely on points of the marriage law.

**ISSERLES, MOSES BEN ISRAEL** (c. 1520–1572), known as **REMA**, was born at Cracow and died there in 1572. He wrote commentaries on the *Zohar*, the "Bible of the Kabbalists," but is best known as the critic and expander of the *Shulhan Aruch* of Joseph Caro (*Caro*) (*g.e.*). His chief halakhic (*legal*) works were *Darke Moshé* and *Mappah*. *Caro*, a Sephardic (Spanish) Jew, in his Code neglected Ashkenazic (German) customs. These deficiencies Isserles supplied, and the notes of *Rema* are now included in all editions of *Caro's* Code.

**ISSOIRE**, a town of central France, capital of an *arrondissement* in the department of Puy-de-Dôme, on the Couze, near its junction with the Allier, 22 m. S.E. of Clermont-Ferrand on the Paris-Lyon-Méditerranée railway to Nîmes. Pop. (1906) 5274. Issoire is situated in the fertile plain of Limagne. The streets in the older part of the town are narrow and crooked, but in the newer part there are several fine tree-shaded promenades, while a handsome boulevard encircles the town. The church of St Paul or St Austremonie built on the site of an older chapel raised over the tomb of St Austremonie (Stremonius) affords an excellent specimen of the Romanesque architecture of Auvergne. Issoire is the seat of a sub-prefect; its public institutions include tribunals of first instance and commerce and a communal college. Brewing, wool-carding and the manufacture of passementerie, candles, straw hats and woollen goods are carried on. There is trade in lentils and other agricultural products, in fruit and in wine.

Issoire (*Isiodurum*) is said to have been founded by the Arverni, and in Roman times rose to some reputation for its schools. In the 5th century the Christian community established there by Stremonius in the 3rd century was overthrown by the fury of the Vandals. During the religious wars of the Reformation, Issoire suffered very severely. Merle, the leader of the Protestants, captured the town in 1574, and treated the inhabitants with great cruelty. The Roman Catholics retook it in 1577, and the ferocity of their retaliation may be inferred from the inscription " *Ici fut Issoire "* carved on a pillar which was raised on the site of the town. In the contest between the Leaguers and Henry IV., Issoire sustained further sieges, and never wholly regained its early prosperity.

**ISSOUDUN**, a town of central France, capital of an *arrondissement* in the department of Indre, on the right bank of the Théols, 17 m. N.E. of Châteauroux by rail. Pop. (1906) 10,566. Among the interesting buildings are the church of St Cyr, combining various architectural styles, with a fine porch and window, and the chapel of the Hôtel Dieu of the early 16th century. Of the fortifications with which the town was formerly surrounded, a town-gate of the 16th century and the White Tower, a lofty cylindrical building of the reign of Philip Augustus, survive. Issoudun is the seat of a sub-prefecture, and has tribunals of first instance and of commerce, a chamber of arts and manufactures and a communal college. The industries, of which the most important is leather-dressing, also include malting and brewing and the manufacture of bristles for brushes and parchment. Trade is in grain, live-stock, leather and wine.

Issoudun, in Latin *Exoldunum* or *Uxellodunum*, existed in and before Roman times. In 1195 it was stoutly and successfully defended by the partisans of Richard Cœur-de-Lion against Philip Augustus, king of France. It has suffered severely from fires. A very destructive one in 1651 was the result of an attack on the town in the war of Fronde; Louis XIV. rewarded its fidelity to him during that struggle by the grant of several privileges.

**ISSYK-KUL**, also called **TUZ-KUL**, and by the Mongols *Temurtu-nor*, a lake of Central Asia, lying in a deep basin (5,400 ft.

above sea-level), between the Kunghei Ala-tau and the Terskei Ala-tau, westward continuations of the Tian-shan mountains, and extending from 76° 10' to 78° 20' E. The length from W.S.W. to E.N.E. is 115 m., and the breadth 38 m., the area being estimated at 2230 sq. m. The name is Kirghiz for "warm lake," and, like the Chinese synonym *She-hai*, has reference to the fact that the lake is never entirely frozen over. On the south the Terskei Ala-tau do not come down so close to the shore as the mountains on the north, but leave a strip 5 to 13 m. broad. The margins of the lake are overgrown with reeds. The water is brackish. Fish are remarkably abundant, the principal species being carp.

It was by the route beside this lake that the tribes (*e.g.* Yue-chi) driven from China by the Huns found their way into the Aralo-Caspian basin in the end of the 2nd century. The Ussuns or Uzuns settled on the lake and built the town of Chi-gu, which still existed in the 5th century. It is to Hsüan-tsang, the Chinese Buddhist pilgrim, that we are indebted for the first account of Issyk-kul based on personal observation. In the beginning of the 14th century Nestorian Christians reached the lake and founded a monastery on the northern shore, indicated on the Catalan map of 1374. It was not till 1856 that the Russians made acquaintance with the district.

**ISTAHBANĀT**, a town and district of Persia in the province of Fars. The district, which is very fertile, extends for nearly 50 m. east and west along the southern shore of the Bakhtegan lake and produces much grain, cotton, good tobacco and excellent fruit, particularly pomegranates and grapes, walnuts and figs. The town is situated in the midst of a plain 12 m. from the eastern corner of the lake and about 100 m. S.E. of Shiraz, and has a population of about 10,000. It occupies the site of the ancient city of Jj, the capital of the old province of Shabānkāreh, which was captured and partly destroyed by Mubariz ed-din, the founder of the Muzaffarid dynasty, in 1355. When rebuilt it became known by its present name. Of the old period a ruined mosque and two colleges remain; other mosques and colleges are of recent construction. At the entrance of the town stands a noble chinar (oriental plane), measuring 45 ft. in circumference at 2 ft. from the ground.

**ISTHMUS** (*Gr.* ἰσθμὸς, neck), a narrow neck of land connecting two larger portions of land that are otherwise separated by the sea.

**ISTRIA** (*Ger.* *Istrien*), a margraviate and crownland of Austria, bounded N. by the Trieste territory, Görz and Gradisca, and Carniola, E. by Croatia and S. and W. by the Adriatic; area 1908 sq. m. It comprises the peninsula of the same name (area 1545 sq. m.), which stretches into the Adriatic Sea between the Gulf of Trieste and the Gulf of Quarnero, and the islands of Veglia, Cherso, Lussino and others. The coast line of Istria extends for 267 m., including Trieste, and presents many good bays and harbours. Besides the great Gulf of Trieste, the coast is indented on the W. by the bays of Muggia, Capodistria, Pirano, Porto Quieto and Pola, and on the E. by those of Medolino, Arsa, Fianona and Volosca. A great portion of Istria belongs to the Karst region, and is occupied by the so-called Istrian plateau, flanked on the north and east by high mountains, which attain in the Monte Maggiore an altitude of 4573 ft. In the south and west the surface gradually slopes down in undulating terraces towards the Adriatic. The Quieto in the west and the Arsa in the east, neither navigable, are the principal streams. The climate of Istria, although it varies with the varieties of surface, is on the whole warm and dry. The coasts are exposed to the prevailing winds, namely the *Sirocco* from the south-south-east, and the *Bora* from the north-east. Of the total area 33.21% is occupied by forests, 32.09% by pastures, 11.2% by arable land, 9.5% by vineyards, 7.21% by meadows and 3.26% by gardens. The principal agricultural products are wheat, maize, rye, oats and fruit, namely olives, figs and melons. Viticulture is well developed, and the best sorts of wine are produced near Capodistria, Muggia, Isola, Parenzo and Dignano, while well-known red wines are made near Refosco and Terrano. The oil of Istria was already famous in Roman times. Cattle-



breeding is another great source of revenue, and the exploitation of the forests gives beech and oak timber (good for shipbuilding), gall-nuts, oak-bark and cork. Fishing, the recovery of salt from the sea-water, and shipbuilding constitute the other principal occupations of the population. Istria had in 1900 a population of 344,173, equivalent to 180 inhabitants per square mile. Two-thirds of the population were Slavs and the remainder Italians, while nearly the whole of the inhabitants (99.6%) were Roman Catholics, under the ecclesiastical jurisdiction of three bishops. The local Diet, which meets at Parenzo, and of which the three bishops are members *ex-officio*, is composed of 33 members, and Istria sends 5 deputies to the Reichsrat at Vienna. For administrative purposes the province is divided into 6 districts and an autonomous municipality, Rovigno (pop. 10,205). Other important places are Pola (45,052), Capodistria (10,711), Pinguente (15,827), Albona (10,968), Isola (7,500), Parenzo (9,962), Dignano (9684), Castua (17,988), Pirano (13,330) and Mitterburg (16,056).

The modern Istria occupies the same position as the ancient Istria or Histria, known to the Romans as the abode of a fierce tribe of Illyrian pirates. It owed its name to an old belief that the Danube (Ister, in Greek) discharged some of its water by an arm entering the Adriatic in that region. The Istrians, protected by the difficult navigation of their rocky coasts, were only subdued by the Romans in 177 B.C. after two wars. Under Augustus the greater part of the peninsula was added to Italy, and, when the seat of empire was removed to Ravenna, Istria reaped many benefits from the proximity of the capital. After the fall of the Western empire it was pillaged by the Longobardi and the Goths; it was annexed to the Frankish kingdom by Pippin in 789; and about the middle of the 10th century it fell into the hands of the dukes of Carinthia. Fortune after that, however, led it successively through the hands of the dukes of Meran, the duke of Bavaria and the patriarch of Aquileia, to the republic of Venice. Under this rule it remained till the peace of Campo Formio in 1797, when Austria acquired it, and added it to the north-eastern part which had fallen to her share so early as 1374. By the peace of Pressburg, Austria was in 1805 compelled to cede Istria to France, and the department of Istria was formed; but in 1813 Austria again seized it, and has retained it ever since.

See T. G. Jackson, *Dalmatia, the Quarnero and Istria* (Oxford, 1887).

**ISYLLUS**, a Greek poet, whose name was rediscovered in the course of excavations on the site of the temple of Asclepius at Epidaurus. An inscription was found engraved on stone, consisting of 72 lines of verse (trochaic tetrameters, hexameters, ionics), mainly in the Doric dialect. It is preceded by two lines of prose stating that the author was Isyllus, an Epidaurian, and that it was dedicated to Asclepius and Apollo of Malea. It contains a few political remarks, showing general sympathy with an aristocratic form of government; a self-congratulatory notice of the resolution, passed at the poet's instigation, to arrange a solemn procession in honour of the two gods; a paean (no doubt for use in the procession), chiefly occupied with the genealogical relations of Apollo and Asclepius; a poem of thanks for the assistance rendered to Sparta by Asclepius against Philip, when he led an army against Sparta to put down the monarchy. The offer of assistance was made by the god himself to the youthful poet, who had entered the Asclepium to pray for recovery from illness, and communicated the good news to the Spartans. The Philip referred to is identified with (a) Philip II. of Macedon, who invaded Peloponnesus after the battle of Chaeronea in 338, or (b) with Philip III., who undertook a similar campaign in 218.

Wilamowitz-Möllendorff, who characterizes Isyllus as a "poetaster without talent and a farcical politician," has written an elaborate treatise on him (Kießling and Möllendorff, *Philologische Untersuchungen*, Heft 9, 1886), containing the text with notes, and essays on the political condition of Peloponnesus and the cult of Asclepius. The inscription was first edited by P. Kavvadias (1885), and by J. F. Baunack in *Studien auf dem Gebiete der griechischen und der arischen Sprachen* (1886).

**ITACOLUMITE**, the name given to a variety of porous yellow sandstone or quartzose schist, which occurs at Itacolumi, in the

southern portion of Minas Geraes, Brazil. This rock is of interest for two reasons; it is believed to be the source of the diamonds which are found in great numbers in the district, and it is the best and most widely known example of a flexible sandstone. Itacolumite is yellow or pale-brown, and splits readily into thin flat slabs. It is a member of a metamorphic series, being accompanied by clay-slate, mica schist, hornblende schist and various types of ferrous schists. In many places itacolumite is really a coarse grit or fine conglomerate. Other quartzites occur in the district, and there is some doubt whether the diamantiferous sandstones are always itacolumites and also as to the exact manner in which the presence of diamond in these rocks is to be accounted for. Some authorities hold that the diamond has been formed in certain quartz veins which traverse the itacolumite. It is clear, however, that the diamonds are found only in those streams which contain the detritus of this rock.

On the split faces of the slabs, scales of greenish mica are visible, but in other respects the rock seems to be remarkably pure. If a piece which is a foot or two long and half an inch thick is supported at its ends it will gradually bend by its own weight. If it then be turned over it will straighten and bend in the opposite direction. Flakes a millimetre or two thick can be bent between the fingers and are said to give out a creaking sound. It should be noted that specimens showing this property form only a small part of the whole mass of the rock. Flexible rocks have also been reported and described from North and South Carolina, Georgia, Delhi, and from the north of England (Durham). They are mostly sandstones or quartzites, but the Durham rock is a variety of the magnesian limestone of that district.

Some discussion has taken place regarding the cause of the flexibility. At one time it was ascribed to the presence of thin scales of mica which were believed to permit a certain amount of motion between adjacent grains of quartz. Flexible rocks have also been said to be due to the porous character of the rock together with the interlocking junctions between the sand grains. The porosity allows interstitial movement, while the hinge-like joints by which the particles are connected hold them together in spite of the displacement. These features are dependent to some extent on weathering, as the rocks contain perishable constituents which are removed and leave open cavities in their place, while at the same time additional silica may have been deposited on the quartz grains fitting their irregular surfaces more perfectly together. Most of the known flexible rocks are also fine-grained; in some cases they are said to lose their flexibility after being dried for some time, probably because of the hardening of some interstitial substance, but many specimens kept in a dry atmosphere for years retain this property in a high degree. (J. S. F.)

**ITAGAKI, TAISUKE**, COUNT (1837- ), Japanese statesman, was born in Tosa in 1837. He distinguished himself originally as one of the soldier politicians who contributed so much to the overthrow of feudalism and the restoration of the administrative power to the throne. After taking a prominent part in subduing the resistance offered by a section of the *shogun's* feudatories to those changes, he received cabinet rank in the newly organized system. But in 1873 he resigned his portfolio as a protest against the ministry's resolve to refrain from warlike action against Korea. This incident inspired Itagaki with an apprehension that the country was about to pass under the yoke of a bureaucratic government. He became thenceforth a warm advocate of constitutional systems, though at the outset he does not seem to have contemplated anything like a popular assembly in the English sense of the term, his ideas being limited to the enfranchisement of the *samurai* class. Failing to obtain currency for his radical propaganda, he retired to his native province, and there established a school (the *Risshi-sha*) for teaching the principles of government by the people, thus earning for himself the epithet of "the Rousseau of Japan." His example found imitators. Not only did pupils flock to Tosa from many quarters, attracted alike by the novelty of Itagaki's doctrines, by his eloquence and by his transparent sincerity, but also similar schools sprang up among the former vassals of other fiefs, who saw themselves excluded from the government. In 1875 no less than seven of these schools sent deputies to hold a convention in Osaka, and for a moment an appeal to force seemed possible. But the statesmen in power were not less favourable to constitutional institutions than the members of the *Aikoku Ka-iō* (public party of patriots), as Itagaki and his followers called themselves. A conference attended by Kido, Okubo, Inouye, Ito, Itagaki and others

entered into an agreement by which they pledged themselves to the principle of a constitutional monarchy and a legislative assembly. Itagaki now accepted office once more. Finding, however, that his colleagues in the administration favoured a much more leisurely rate of progress than he himself advocated, he once more retired into private life (1876) and renewed his liberal propagandism. It is in the nature of such movements to develop violent phases, and the leaders of the *Aikoku-sha* (patriotic association), as the agitators now called themselves, not infrequently showed disregard for the preservation of peace and order. Itagaki made the mistake of memorializing the government at the moment when its very existence was imperilled by the Satsuma rebellion (1877), and this evident disposition to take advantage of a great public peril went far to alienate the sympathies of the cabinet. Recourse was had to legislation in restraint of free speech and public meeting. But repression served only to provoke opposition. Throughout 1879 and 1880 Itagaki's followers evinced no little skill in employing the weapons of local association, public meetings and platform tours, and in November 1881 the first genuine political party was formed in Japan under the name of *Jiyū-to*, with Itagaki for declared leader. A year later the emperor announced that a parliamentary system should be inaugurated in 1891, and Itagaki's task might be said to have been accomplished. Thereafter he devoted himself to consolidating his party. In the spring of 1882, he was stabbed by a fanatic during the reception given in the public park at Gifu. The words he addressed to his would-be assassin were: "Itagaki may perish, but liberty will survive." Once afterwards (1898) he held office as minister of home affairs, and in 1900 he stepped down from the leadership of the *Jiyū-to* in order that the latter might form the nucleus of the *Seiyū-kai* organized by Count Ito. Itagaki was raised to the nobility with the title of "count" in 1887. From the year 1900 he retired into private life, devoting himself to the solution of socialistic problems. His countrymen justly ascribe to him the fame of having been the first to organize and lead a political party in Japan.

**ITALIAN LANGUAGE.** The Italian language is the language of culture in the whole of the present kingdom of Italy, in some parts of Switzerland (the canton of Ticino and part of the Grisons), in some parts of the Austrian territory (the districts of Trent and Görz, Istria along with Trieste, and the Dalmatian coast), and in the islands of Corsica<sup>1</sup> and Malta. In the Ionian Islands, likewise, in the maritime cities of the Levant, in Egypt, and more particularly in Tunis, this literary language is extensively maintained through the numerous Italian colonies and the ancient traditions of trade.

The Italian language has its native seat and living source in Middle Italy, or more precisely Tuscany and indeed Florence. For real linguistic unity is far from existing in Italy; in some respects the variety is less, in others more observable than in other countries which equally boast a political and literary unity. Thus, for example, Italy affords no linguistic contrast so violent as that presented by Great Britain with its English dialects alongside of the Celtic dialects of Ireland, Scotland and Wales, or by France with the French dialects alongside of the Celtic dialects of Brittany, not to speak of the Basque of the Pyrenees

<sup>1</sup> The article by G. I. Ascoli in the 9th edition of the *Encyclopaedia Britannica*, which has been recognized as a classic account of the Italian language, was reproduced by him, with slight modifications, in *Arch. glott.* viii. 98-128. The author proposed to revise his article for the present edition of the *Encyclopaedia*, but his death on the 21st of January 1907 prevented his carrying out this work, and the task was undertaken by Professor C. Salvioni. In the circumstances it was considered best to confine the revision to bringing Ascoli's article up to date, while preserving its form and main ideas, together with the addition of bibliographical notes, and occasional corrections and substitutions, in order that the results of more recent research might be embodied. The new matter is principally in the form of notes or insertions within square brackets.

<sup>2</sup> In Corsica the present position of Italian as a language of culture is as follows. Italian is only used for preaching in the country churches. In all the other relations of public and civil life (schools, law courts, meetings, newspapers, correspondence, &c.), its place is taken by French. As the elementary schools no longer reach Italian but French, an educated Corsican nowadays knows only his own dialect for everyday use, and French for public occasions.]

and other heterogeneous elements. The presence of not a few Slavs stretching into the district of Udine (Friuli), of Albanian, Greek and Slav settlers in the southern provinces, with the Catalans of Alghero (Sardinia, v. *Arch. glott.* ix. 261 et seq.), a few Germans at Monte Rosa and in some corners of Venetia, and a remnant or two of other comparatively modern immigrations is not sufficient to produce any such strong contrast in the conditions of the national speech. But, on the other hand, the Neo-Latin dialects which live on side by side in Italy differ from each other much more markedly than, for example, the English dialects or the Spanish; and it must be added that, in Upper Italy especially, the familiar use of the dialects is tenaciously retained even by the most cultivated classes of the population.

In the present rapid sketch of the forms of speech which occur in modern Italy, before considering the Tuscan or Italian *par excellence*, the language which has come to be the noble organ of modern national culture, it will be convenient to discuss (A) dialects connected in a greater or less degree with Neo-Latin systems that are not peculiar to Italy;<sup>3</sup> (B) dialects which are detached from the true and proper Italian system, but form no integral part of any foreign Neo-Latin system; and (C) dialects which diverge more or less from the true Italian and Tuscan type, but which at the same time can be conjoined with the Tuscan as forming part of a special system of Neo-Latin dialects.

**A. Dialects which depend in a greater or less degree on Neo-Latin systems not peculiar to Italy.**

1. **Franco-Provençal and Provençal Dialects.**—(a) **Franco-Provençal** (see Ascoli, *Arch. glott.* iii. 61-120; Suchier, in *Grundriss der romanischen Philologie*, 2nd ed., i. 755, &c.; Nigra, *Arch. glott.* iii. 1 sqq.; Salvioni, *Rendic. istit. lomb.*, s. ii. vol. xxxvii. 1043 sqq.; Cerlogne, *Dictionnaire des patois valldâin* (Aosta, 1907). These occupy at the present time very limited areas at the extreme north-west of the kingdom of Italy. The system stretches from the borders of Savoy and Valais into the upper basin of the Dora Baltea and into the head-valleys of the Orco, of the northern Stura, and of the Dora Riparia. As this portion of the kingdom of Italy forms the rest of the system, the type is badly preserved; in the valleys of the Stura and the Dora Riparia, indeed, it is passing away and everywhere yielding to the Piedmontese. The most salient characteristic of the Franco-Provençal is the phonetic phenomenon by which the Latin *a*, whether as an accented or as an unaccented final, is reduced to a thin vowel (*e*, *i*) when it follows a sound which is or has been palatal, but on the contrary is kept intact when it follows a sound of another sort. The following are examples from the Italian side of these Alps: AOSTA: *travajâ*, Fr. *travailler*; *zarfâ*, Fr. *charger*; *enterâ*, Fr. *interrogier*; *agra*, Fr. *chèvre*; *zar*, Fr. *chêne*; *grâ*, Fr. *glace*; *vâze*, Fr. *vache*; *alongside of sa*, Fr. *sel*; *man*, Fr. *main*; *épûsa*, Fr. *épouse*; *erba*, Fr. *herbe*. VAL SOANA: *tajjâr*, Fr. *tailleur*; *coûsse*, Fr. *soi coucher*; *chi*, Fr. *chien*; *liera*, Fr. *chèvre*; *vaccî*, Fr. *vache*; *mânçi*, Fr. *manche*; *alongside of alâr*, Fr. *aller*; *portâ*, Fr. *porté*; *amâra*, Fr. *amère*; *nêva*, Fr. *neuve*. CHIAMORIO (Val di Lanzo): *la spranssi dia vendeta*, *sperantia de illa vindicta*. VIÛ: *pansci*, *pancia*. USSEGLIO: *la mûragli*, *muraille*. A morphological characteristic is the preservation of that paradigm which is legitimately traced back to the Latin pluperfect indicative, although possibly it may arise from a fusion of this pluperfect with the imperfect subjunctive (*amaram*, *amarem*, *alongside of habueram*, *haberem*), having in Franco-Provençal as well as in Provençal and in the continental Italian dialects in which it will be met with further on (C. 3, b; cf. B. 2) the function of the conditional. VAL SOANA: *portâro*, *portârê*, *portârê*; *portârônt*; AOSTA: *vare* = Prov. *agra*, *haberet* (see *Arch.* iii. 31 n.). The final *t* in the third persons of this paradigm in the Val Soana dialect is, or was, constant in the whole conjugation, and becomes in its turn a particular characteristic in this section of the Franco-Provençal. VAL SOANA: *trê*, *lat. erat*; *sejâ*, *lat. pœnit*; *portârâ*, *portârê*; *portârônt*; CHIAMORIO: *jetet*; *erâ*; *ant d'êt*, *habent dictum*; *sijsont fêt*, *habuisse factum*; VIÛ: *c' s'mînget*, *Ital. che si mangi*; GRAVERA (Val di Susa): *at pensâ*, *ha pensato*; *amâ*, *habebat*; GIAGLIONE (sources of the Dora Riparia): *maciônôn*, *mangia-vano*.—From the valleys, where, as has just been said, the type is disappearing, a few examples of what is still genuine Franco-Provençal may be subjoined: *Civerri* (the name of a mountain between the Stura and the Dora Riparia), which, according to the regular course of evolution, presupposes a Latin *Cararâ* (cf. *maneri*, *maniera*, even in the Chiamorio dialect); *Caprâth* (*ciararâth*), *carestia*, in the Viù dialect; and *stûnd*, *cantare*, in that of Usseglio. From CHIAMORIO, *is lèms*, *testis*, *art. cheghes*, *alme*, *alcune* (*qualche*) *birbe*, are worthy of mention on account of the

<sup>3</sup> [It may be asked whether we ought not to include under this section the Vegliote dialect (Veglioto), since under the name of Dalmatian dialect (Dalmatic) is spoken in Italy. But it should be remembered that in the present generation the Dalmatian dialect has only been heard as a living language at Veglia.]

final *s*. [In this connexion should also be mentioned the Franco-Provençal colonies of Transalpine origin, Faeto and Celle, in Apulia (v. Morosi, *Archivio glottologico*, xii, 33-75), the linguistic relations of which are clearly shown by such examples as *lalij*, Ital. tagliare; *bañij*, Ital. bagnare; side by side with *canà*, Ital. cantare; *tud*, Ital. levare.]

(b) *Provençal* (see *La Lettura* i, 716-717, *Romanische Forschungen* xiv, 52-539).—Further south, but still in the same western extreme of Piedmont, phenomena continuous with those of the Maritime Alps supply the means of passing from the Franco-Provençal to the Provençal proper, precisely as the same transition takes place beyond the Cottian Alps in Dauphiné almost in the same latitude. On the Italian side of the Cottian and the Maritime Alps the Franco-Provençal and the Provençal are connected with each other by the continuity of the phenomenon *é* (a pure explosive) from the Latin *c* before *a*. At OULX (sources of the Dora Riparia), which seems, however, to have a rather more dialect, there also occurs the important Franco-Provençal phenomenon of the surd interdental (English *th* in *thief*) instead of the surd sibilant (for example *thi* = Fr. *ici*). At the same time *agù* = *avuto*, takes us to the Provençal. [If, in addition to the Provençal characteristic of which *agù* is an example, we consider those characteristics also Provençal, such as *o* for *a* final unaccented, the preservation of the Latin diphthong *au*, *p* between vowels preserved as *b*, we shall find that they occur, together or separately, in all the Alpine varieties of Piedmont, from the upper valleys of the Dora Riparia and the Isone to the Colle di Tenda. Thus at FENESTRAT (upper valley of the Clus) we have: *agù*, *vengù*, Ital. venuto; *pauc*, Lat. *paucus*, Ital. poco; *aribà* (Lat. *ripa*), Ital. arrivare; *trubà*, Ital. trovare; *ciabrin*, Ital. capretto; at OULX (source of the Dora Riparia): *agù*, *vengù*; *ano gran jamino è venio*, Ital. un gran fiamma è venuta; at GIAGLIONE: *auovo*, Ital. *odo* (Lat. *audio*); *arribà*, *resubù*, Ital. ricevuto (Lat. *recipere*). At ONCINO (source of the Po): *agù*, *vengù*; *ero en campagno*, Ital. "era in campagna"; *donavo*, Ital. dava; *paure*, Lat. *pauper*, Ital. povero; *trubà*, *ciabrin*; at SANPEYRE (valley of the Varaita): *agù*, *vengù*, Ital. voluto; *pressiono*, Ital. preziosa; *fasio*, Ital. faceva; *trobar*; at ACEGLIO (valley of the Macra): *venghess*, Ital. venisse; *tirno*, Ital. ghiera; *chesto allegrio*, Ital. questa allegria; Ital. venisse; *ar*; *trobà*; at CASTELMAGNO (valley of the Alagna): *gù*, *vengù*; *rabbio*, Ital. rabbia; *trubar*; at VINADIO (valley of the southern Stura): *agù*, *beigù*, Ital. bevuto; *cadeno*, Ital. catena; *mango*, Ital. manica; *canà*, Ital. canta; *pauc*, *avù*, Ital. udito; *fabè*, Ital. sapete; *trobar*; at VALDIERI and ROASCHIA (valley of the Gesso): *pargù*, Ital. potuto; *pijagù*, Ital. piaciuto; *corrogù*, Ital. corso; *arribà*, *ciabrin*; at LIMCÒ (Colle di Tenda): *agù*, *vengù*; *zaber*, Ital. zibere; *arribà*, *trubano*. In the basal part of the system of a character rather Transalpine (like that of Dauphiné) than native, are the dialects of the Vaudois population above Pinerolo (v. Morosi, *Arch. glott.* xi, 309-416), and their colonies of Guardia in Calabria (ib. xi, 381-393) and of Neu-Hengstler and Pinache-Serres in Württemberg (ib. xi, 393-398). The Vaudois literary language, in which is written the *Nobla Leycion*, has, however, no direct connexion with any of the spoken dialects; it is a literary language, and is connected with literary Provençal, the language of the *troubadours*; see W. Foerster, *Göttische gelehrte Anzeigen* (1888) Nos. 20-21.]

2. *Ladin Dialects* (Ascoli, *Arch. glott.* i, iv, 342 sqq., iv, 406 sqq.; Gardner, *Rätomanische Grammatik* (Heilbronn, 1883), and in *Grundriss der romanischen Philologie*, 2nd ed., i, 608 sqq.; Salvini, *Arch. glott.* xvi, 219 sqq.).—The purest of the Ladin dialects occur on the northern versant of the Alps in the Grisons (Switzerland), and they form the western section of the system. To this section also belongs both politically and in the matter of dialect the valley of Münster (Monastero); it sends its waters to the Adige, and might naturally be considered geographically as belonging to the section it slopes towards the north. In the central section of the Ladin zone there are two other valleys which likewise drain into tributaries of the Adige, but are also turned towards the north,—the valleys of the Gardena and Gadera, in which occurs the purest Ladin now extant in the central section. The valleys of Münster, the Gardena and the Gadera may thus be regarded as inter-Alpine, and the question may be left open whether or not they should be included even geographically in Italy. There remain, however, within what are strictly Italian limits, the dialects of the Neveglia, the Cordevole, and the Boite, and the upper basin of the Piave (Comelico), in which are preserved Ladin dialects, more or less pure, belonging to the central section of the Ladin zone or belt. To Italy belongs, further, the whole eastern section of the zone composed of the Friulian territories. It is by far the most populous, containing about 500,000 inhabitants. The Friulian region is bounded on the north by the Carnic Alps, south by the Adriatic, and west by the eastern rim of the upper basin of the Piave and the Livenza; while on the east it stretches into the eastern versant of the basin of the Isonezo, and further the ancient dialect of Trieste was fixed in Ladin (*Arch. glott.* x, 447 et seq.). The Ladin element is further found in greater or less degree throughout an altogether Cis-Alpine "amphizione," which begins at the western slopes of Monte Rosa, and is to be noticed more particularly in the upper valley of the Ticino and the upper valley of the Liro and of the Mera on the Lombardy versant, and in the Val Fiorentina and central Cadore on the Venetian versant.

The Ladin element is clearly observable in the most ancient examples of the dialects of the Venetian estuary (*Arch.* i, 448-473). The main characteristics by which the Ladin type is determined may be summarized as follows: (1) the guttural of the formulae *c + a* and *g + a* passes into a palatal; (2) the *l* of the formulae *pl, cl, &c.*, is preserved; (3) the *s* of the ancient terminations is preserved; (4) the accented *e* position breaks into a diphthong; (5) the accented *o* in position breaks into a diphthong; (6) the accented *u* in position which comes from short accented *o* or from the *o* of position is *ue* (whence *ùe, ò*); (7) long accented *e* and short accented *i* break into a diphthong, the purest form of which is sounded *ei*; (8) the accented *a* tends, within certain limits, to change into *e*, especially if preceded by a palatal sound; (9) the long accented *u* is represented by *ù*. These characteristics are all foreign to true and genuine Italian. *Sfern*, carne; *spelnùca*, spelunca; *clefs*, claves; *fuormas*, formae; *infern*, inferni; *ordà*, hordeum; *mod*, modus; *plavn*, plenu; *patù*, patu; *quàl*, quale; *piùr*, puru—may be taken as examples from the Upper Engadine (western section of the zone). The following are examples from the central and eastern sections on the Italian versant—

a. *Central Section*.—BASIN OF THE NOCE: examples of the dialect of Fondo: *lavèl*, capillu; *pestadòr*, piscatore; *pluvèia*, pluvia (plovía); *pluma* (dial. of Val de Rumo: *plovìa*, *plümü*); *vècia*, vetula; *lávtes*, cantas. The dialects of this basin are disappearing.—BASIN OF THE AVISIO: examples of the dialect of the Val di Fassa: *clav*, arris; *èèer*, cadere (cad-jere); *vadà*, vacca; *forjà*, furca; *glifà* (dial.), ecclesia; *oridit* (s. oculi), fons; *canis*; *rdem*, rami; *veia*, telca; *néf*, nive; *vegessa*, coctus. The dialects of this basin which are farther west than Fassa are gradually being merged in the Veneto-Tridentine dialects.—BASIN OF THE CORDEVOLE: here the district of Livinal-Lungo (Buchenstein) is Austrian politically, and that of Rocca d'Agordo and Laste is Italian. Examples of the dialect of Livinal-Lungo: *larie*, Ital. larice; *canù*, cantatus; *ogel*, oculu; *canis*, canes; *carévis*, capilli; *vièrm*, verum; *fuóc*, focu; *avèl*, habere; *néi*, nive.—BASIN OF THE BOITE: here the district of Ampezzo (Heiden) is politically Austrian, that of Otterchiusa Italian. Examples of the dialect of Ampezzo are: *cas*, casa; *èandèr*, candela; *forècs*, furcae, pal; *sénates*, sentis. It is a decadent form.—UPPER BASIN OF THE PIAVE: dialect of the Comelico: *léva*, casa; *fen* (can), cane; *caljé*, caligarius; *bos*, boves; *noevo*, novu; *loego*, locu.

b. *Eastern Section or Friulian Region*.—Here there still exists a flourishing "Ladinity," but at the same time it tends towards Italian, particularly in the want both of the *e* from *d* and of the *i* (and consequently of the *o*). Examples of the Udine variety: *car*, carne; *clav*, clavis; *clav*, clavis; *for*, furca; *glav*, gladius; *glav*, gladius; *plan*, planus; *color*, color; *long*, longi; *cl*, dicit; *debcs*; *vicièl*, vitello; *fieste*, festa; *puès*, passus; *cuat*, cœtu; *urdi*, hordeu.—The most ancient specimens of the Friulian dialect belong to the 14th century (see *Arch.* iv, 188 sqq.).

B. *Dialects which are detached from the true and proper Italian system, but form no integral part of any foreign Neo-Latin system.*

1. Here first of all is the extensive system of the dialects usually called *Gallo-Italian*, although that designation cannot be considered sufficiently distinctive, since it would be equally applicable to the Franco-Provençal (A. 1) and the Ladin (A. 2). The system is subdivided into four great groups—(a) the *Ligurian*, (b) the *Piedmontese*, (c) the *Lombard* and (d) the *Emilian*—the name furnishing on the whole sufficient indication of the localization and limits.—These groups, considered more particularly in their more pronounced varieties, differ greatly from each other; and, in regard to the Ligurian, it was even denied that it belongs to this system at all (see *Arch.* ii, 111 sqq.).—Characteristic of the Piedmontese, the Lombard and the Emilian is the presence of the unaccented final vowels except *è*, e.g. Turinese *ve* oculu; Milanese *ve* oculu; Bolognese *vd*, Ital. vite), but the Ligurian does not keep them company (e.g. Genoese *oggu*, oculu; *spè*, voce). In the Piedmontese and Emilian there is further a tendency to eliminate the protonic vowels—a tendency much more pronounced in the second of these groups than in the first (e.g. Pied. *dné*, danaro; *vin*, vicino; *fuòb*, finocchio; Bolognese *èprà*, disperato). This phenomenon involves in large measure that of the prothesis of *a*, *av*, e.g. in Piedmontese and Genoese *arumor*, rumore; Emilian *avar*, levas, &c. U for the long accented *u* and *ù* for the short accented *u* is also common, even within certain limits the short Latin *u* of position) are common to the Piedmontese, the Ligurian, the Lombard and the northernmost section of the Emilian: e.g., Turinese, Milanese and Piacentine *dür*, and Genoese *düu*, duro; Turinese and Genoese *möve*, Parmigiana *möver*, and Milanese *möf*, muovere; Piedmontese *dörm*, dorme; Milanese *völla*, volta. *Ei* for the long accented Latin *e* and for the short accented Latin *i* is common to the Piedmontese and the Ligurian, and even extends over a large part of Emilia: e.g., Turinese and Genoese *malabere*, nevens; Emilian *malabere* and *malabere*; biber, Bolognese *beiv*, nevens. In Emilia and part of Piedmont *e* occurs also in the formulae *ent*, *emp*; e.g. Bolognese and Modenese *bolè*, solamint. In connexion with these examples, there is also the Bolognese *feiv*, Ital. fine, representing the series in which *e* is derived from an *i* followed by *n*, a phenomenon which occurs, to a greater or less extent throughout the Emilian dialects; in them

also is found, parallel with the *ci* from *ç*, the *ou* from *ø*: Bolognese *udùur*, Ital. odore; *famùus*, Ital. famoso; *lòuu*, lòpu. The system shows a regular throughout to *te* for the short accented Latin *e* (as it occurs in Italian *piède*, &c.); in other words, this diphthong has died out, but in various fashions; Piedmontese and Lombard *deç*, *deç*; Genoese *dèçe* (in some corners of Liguria, however, occurs *dieçe*); Bolognese *dèç*, old Bolognese, *dèçe*. The greater part of the phenomena indicated above have "Gallic" counterparts. It is required to refer to *lae* especially pointed out. One of the most important traces of Gallic or Celtic reaction is the reduction of the Latin accented *a* into *e* (*à*, &c.), of which phenomenon, however, no certain indications have as yet been found in the Ligurian group. On the other hand it remains, in the case of very many of the Piedmontese dialects, in the *é* of the infinitives of the first conjugation: *porté*, portare, &c.; and numerous vestiges of it are still found in Lombardy (e.g. in Bassa Brianza: *andàe*, andare; *guardàe*, guardare; *pacé*, pace; see *Arch.* i. 296-298, 536). Emilia also preserves it in very extensive use: Modenese *andàe*, andare; *arriàe*, arrivare; *pacé*, pace; Faenza *parlé*, parlare and *parlató*; *parlàda*, parlata; *ches*, caso; &c. The phenomenon, in company with other Gallo-Italian and more specially Emilian characteristics extends to the valley of the Metauro, and even passes to the opposite side of the Apennines, spreading on both banks of the head stream of the Tiber and through the valley of the Chiane: hence the types *artròer*, ritrovare, *portióto*, portato, &c., of the Perugian and Aretine dialects (see *infra* C. 3, b). In the phenomenon of *d* passing into *e* (as indeed, with the Gallo-Italian mutation in vowel lengthening, it would require to be drawn between bases in which *a* (not standing in position) precedes a non-nasal consonant (e.g. *amàdo*), and those which have *a* before a nasal: and in the latter case there would be a non-positional subdivision (e.g. *fàme*, fame) and a positional one (e.g. *quànto*, *amàndo*, *càmpo*): see *Arch.* i. 293 seq. This leads us to the nasals, a category of sounds comprising other Gallo-Italian characteristics. There occurs more or less widely, throughout all the sections of the system, and in different gradations, that "velar" nasal in the end of a syllable (*paç*, *maç*; *fàtta*, *maçta*) which may be weakened into a simple nasalizing of a vowel (*pà*, &c.) or even gone completely inaudible (Bergamese *pa*, *pàe*; *padrà*, padre; *lep*, tempo; *met*, mente; *mat*, monte; *pà*, ponte; *pùta*, punta, i.e. "puncta"), where Celtic and especially Irish analogies and even the frequent use of *t* for *m*, &c., in ancient Umbrian orthography occur to the mind. Then we have the faucal *n* by which the Ligurian and the Piedmontese (*aba lùga*, &c.) are connected with the group which we call Franco-Provençal (A. 1).—We pass on to the Gallic resolution of the nasal *ç* (e.g. *fact*, *fàct*; *factu*, *fàct*; *teit*, *teit*; *teit*, *teit*; *teit*, *teit*), which occurs in the Piedmontese, the Ligurian and the Lombard: Pied. *fàct*, *lit*, *fajtu*, *factu*, Lombard *fuc*; Pied. *tit*, *lit*, *tig*, *tétu*, *lom*. *te*, &c. Here it is to be observed that besides the Celtic analogy the Umbrian also helps us (*adveit* = ad-vecto; &c.). The Piedmontese and Ligurian come close to each other, more especially by a curious resolution of the secondary hiatus (Gen. *reize*, Piedm. *rejis* = *ra*-ice, Ital. radice) by the regular dropping of the *d* both primary and secondary, a phenomenon common in French (as Piedmontese and Ligurian *rie*, ridere; Piedmontese *pié*, potare; Genoese *naghe* = *nàghe*, *nàtiche*, &c.). The Lombard type, or more correctly the type which has become the dominant one in Lombardy (*Arch.* i. 305-306, 310-311), is more sparing in this respect; and still more so is the Emilian. In the Piedmontese and in the Alpine dialects of Lombardy is also found that other purely Gallic resolution of the guttural between two vowels by which we have the types *brója*, *mánia*, over against the Ligurian *bráa*, *mánega*, *braca*, *manica*. Among the phonetic phenomena peculiar to the Ligurian is a continual reduction of *ç* into *r* (comparably and for the most part) to the bilabial vowel *u*, and the subsequent dropping of this *r* at the end of words in the modern Genoese; just as happens also with the Ligurian *r*; thus *dù* = durùr = dolore, &c. Characteristic of the Ligurian, but not without analogies in Upper Italy even (*Arch.*, ii. 157-158, ix. 209, 255), is the resolution of *þj*, *þj*, into *č*, *ğ*, *š*: *čù*, *pù*, plus; *raggà*, rabbia, rabies; *šù*, fiore. Finally, the sounds *š* and *č* have a very wide range in Ligurian (*Arch.* ii. 158-159), but are, however, etymologically, of different origin from the sounds *š* and *č* in Lombard. The reduction of *ç* into *r* occurs in the Bergamo dialects *lira*, *lira*, *lira*, *lira*, *lira*, *lira*, *lira*, *lira*.

A general phenomenon in Gallo-Italian phonetics which also comes to have an inflexional importance is that by which the unaccented final *t* has an influence on the accented vowel. This enters into a series of phenomena which even extends into southern Italy; but in the Gallo-Italian there are particular resolutions which agree well with the general connexions of this system. [We may briefly recall

the following forms in the plural and 2nd person singular: old Piedmontese *drapp* pl. of *drap*, Ital. drappo; *man*, *meyn*, Ital. mano, -i; *long*, *loyng*, Ital. lungo, -ghi; Genoese, *kàh*, *kèh*, Ital. cane, -i; *bùh*, *bùh*, Ital. buono, -i; Bolognese, *fir*, *fir*, Ital. ferro, -i; *peir*, *peir*, Ital. pero, -i; *sòp*, *sòp*, Ital. zoppo, -i; *lowe*, *lèro*, Ital. lupo, -i; *vedù*, *vù*, Ital. io vedo, tu vedi; *vòj*, *vù*, Ital. io voglio, tu vuoi; Milanese *quest*, *quest*, Ital. questo, -i, and, in the Alps, Lombardy, *pai*, *pai*, Ital. paio, -i; *red*, *red*, Ital. rete, -i; *cor*, *còr*, Ital. cuore, -i; *grs*, *grs*, Ital. orso, -i; *law*, *lew*, Ital. io lavo, tu lavi; *met*, *met*, Ital. io metto, tu metti; *mow*, *mow*, Ital. io muovo, tu muovi; *cor*, *cùr*, Ital. io corro, tu corri. (Vicentine *pomo*, *pomo*, Ital. pomo, -i; *pero*, *pièri* = *piro*, Ital. pero, -i; v. *Arch.* i. 540-541; ix. 235 et seq.,xiv. 329-330).—Among morphological peculiarities the first place may be given to the Bolognese *sipa* (*seppa*), because, thanks to Dante and others, it has acquired great literary celebrity. It really signifies "sia" (sim, sit), and is an analogical form fashioned on the other auxiliary (*habere*, *habeat*), which is still heard in *ch'è me aepa purtate*, *ch'lu aepa purtate*, *ch'io abbia portato*, *ch'egli abbia portato*. Next may be noted the 3rd person singular in *-p* of the perfect of *esse* and of the first conjugation in the Forlì dialect (*fop*, fu; *mandép*, mandò; &c.). This also must be analogical, and due to a legitimate *ep* (*ep*, *ep*) continuation of the corresponding forms of the other auxiliary (*habere*, *habeat*), which is still heard in *ch'è me aepa purtate*, *ch'lu aepa purtate*, *ch'io abbia portato*, *ch'egli abbia portato*. Next may be noted the 3rd person singular in *-p* of the perfect of *esse* and of the first conjugation in the Forlì dialect (*fop*, fu; *mandép*, mandò; &c.). This also must be analogical, and due to a legitimate *ep* (*ep*, *ep*) continuation of the corresponding forms of the other auxiliary (*habere*, *habeat*), which is still heard in *ch'è me aepa purtate*, *ch'lu aepa purtate*, *ch'io abbia portato*, *ch'egli abbia portato*. Next may be noted the 3rd person singular in *-p* of the perfect of *esse* and of the first conjugation in the Forlì dialect (*fop*, fu; *mandép*, mandò; &c.). This also must be analogical, and due to a legitimate *ep* (*ep*, *ep*) continuation of the corresponding forms of the other auxiliary (*habere*, *habeat*), which is still heard in *ch'è me aepa purtate*, *ch'lu aepa purtate*, *ch'io abbia portato*, *ch'egli abbia portato*. Next may be noted the 3rd person singular in *-p* of the perfect of *esse* and of the first conjugation in the Forlì dialect (*fop*, fu; *mandép*, mandò; &c.). This also must be analogical, and due to a legitimate *ep* (*ep*, *ep*) continuation of the corresponding forms of the other auxiliary (*habere*, *habeat*), which is still heard in *ch'è me aepa purtate*, *ch'lu aepa purtate*, *ch'io abbia portato*, *ch'egli abbia portato*. Next may be noted the 3rd person singular in *-p* of the perfect of *esse* and of the first conjugation in the Forlì dialect (*fop*, fu; *mandép*, mandò; &c.). This also must be analogical, and due to a legitimate *ep* (*ep*, *ep*) continuation of the corresponding forms of the other auxiliary (*habere*, *habeat*), which is still heard in *ch'è me aepa purtate*, *ch'lu aepa purtate*, *ch'io abbia portato*, *ch'egli abbia portato*. Next may be noted the 3rd person singular in *-p* of the perfect of *esse* and of the first conjugation in the Forlì dialect (*fop*, fu; *mandép*, mandò; &c.). This also must be analogical, and due to a legitimate *ep* (*ep*, *ep*) continuation of the corresponding forms of the other auxiliary (*habere*, *habeat*), which is still heard in *ch'è me aepa purtate*, *ch'lu aepa purtate*, *ch'io abbia portato*, *ch'egli abbia portato*. Next may be noted the 3rd person singular in *-p* of the perfect of *esse* and of the first conjugation in the Forlì dialect (*fop*, fu; *mandép*, mandò; &c.). This also must be analogical, and due to a legitimate *ep* (*ep*, *ep*) continuation of the corresponding forms of the other auxiliary (*habere*, *habeat*), which is still heard in *ch'è me aepa purtate*, *ch'lu aepa purtate*, *ch'io abbia portato*, *ch'egli abbia portato*. Next may be noted the 3rd person singular in *-p* of the perfect of *esse* and of the first conjugation in the Forlì dialect (*fop*, fu; *mandép*, mandò; &c.). This also must be analogical, and due to a legitimate *ep* (*ep*, *ep*) continuation of the corresponding forms of the other auxiliary (*habere*, *habeat*), which is still heard in *ch'è me aepa purtate*, *ch'lu aepa purtate*, *ch'io abbia portato*, *ch'egli abbia portato*. Next may be noted the 3rd person singular in *-p* of the perfect of *esse* and of the first conjugation in the Forlì dialect (*fop*, fu; *mandép*, mandò; &c.). This also must be analogical, and due to a legitimate *ep* (*ep*, *ep*) continuation of the corresponding forms of the other auxiliary (*habere*, *habeat*), which is still heard in *ch'è me aepa purtate*, *ch'lu aepa purtate*, *ch'io abbia portato*, *ch'egli abbia portato*. Next may be noted the 3rd person singular in *-p* of the perfect of *esse* and of the first conjugation in the Forlì dialect (*fop*, fu; *mandép*, mandò; &c.). This also must be analogical, and due to a legitimate *ep* (*ep*, *ep*) continuation of the corresponding forms of the other auxiliary (*habere*, *habeat*), which is still heard in *ch'è me aepa purtate*, *ch'lu aepa purtate*, *ch'io abbia portato*, *ch'egli abbia portato*. Next may be noted the 3rd person singular in *-p* of the perfect of *esse* and of the first conjugation in the Forlì dialect (*fop*, fu; *mandép*, mandò; &c.). This also must be analogical, and due to a legitimate *ep* (*ep*, *ep*) continuation of the corresponding forms of the other auxiliary (*habere*, *habeat*), which is still heard in *ch'è me aepa purtate*, *ch'lu aepa purtate*, *ch'io abbia portato*, *ch'egli abbia portato*. Next may be noted the 3rd person singular in *-p* of the perfect of *esse* and of the first conjugation in the Forlì dialect (*fop*, fu; *mandép*, mandò; &c.). This also must be analogical, and due to a legitimate *ep* (*ep*, *ep*) continuation of the corresponding forms of the other auxiliary (*habere*, *habeat*), which is still heard in *ch'è me aepa purtate*, *ch'lu aepa purtate*, *ch'io abbia portato*, *ch'egli abbia portato*. Next may be noted the 3rd person singular in *-p* of the perfect of *esse* and of the first conjugation in the Forlì dialect (*fop*, fu; *mandép*, mandò; &c.). This also must be analogical, and due to a legitimate *ep* (*ep*, *ep*) continuation of the corresponding forms of the other auxiliary (*habere*, *habeat*), which is still heard in *ch'è me aepa purtate*, *ch'lu aepa purtate*, *ch'io abbia portato*, *ch'egli abbia portato*. Next may be noted the 3rd person singular in *-p* of the perfect of *esse* and of the first conjugation in the Forlì dialect (*fop*, fu; *mandép*, mandò; &c.). This also must be analogical, and due to a legitimate *ep* (*ep*, *ep*) continuation of the corresponding forms of the other auxiliary (*habere*, *habeat*), which is still heard in *ch'è me aepa purtate*, *ch'lu aepa purtate*, *ch'io abbia portato*, *ch'egli abbia portato*. Next may be noted the 3rd person singular in *-p* of the perfect of *esse* and of the first conjugation in the Forlì dialect (*fop*, fu; *mandép*, mandò; &c.). This also must be analogical, and due to a legitimate *ep* (*ep*, *ep*) continuation of the corresponding forms of the other auxiliary (*habere*, *habeat*), which is still heard in *ch'è me aepa purtate*, *ch'lu aepa purtate*, *ch'io abbia portato*, *ch'egli abbia portato*. Next may be noted the 3rd person singular in *-p* of the perfect of *esse* and of the first conjugation in the Forlì dialect (*fop*, fu; *mandép*, mandò; &c.). This also must be analogical, and due to a legitimate *ep* (*ep*, *ep*) continuation of the corresponding forms of the other auxiliary (*habere*, *habeat*), which is still heard in *ch'è me aepa purtate*, *ch'lu aepa purtate*, *ch'io abbia portato*, *ch'egli abbia portato*. Next may be noted the 3rd person singular in *-p* of the perfect of *esse* and of the first conjugation in the Forlì dialect (*fop*, fu; *mandép*, mandò; &c.). This also must be analogical, and due to a legitimate *ep* (*ep*, *ep*) continuation of the corresponding forms of the other auxiliary (*habere*, *habeat*), which is still heard in *ch'è me aepa purtate*, *ch'lu aepa purtate*, *ch'io abbia portato*, *ch'egli abbia portato*. Next may be noted the 3rd person singular in *-p* of the perfect of *esse* and of the first conjugation in the Forlì dialect (*fop*, fu; *mandép*, mandò; &c.). This also must be analogical, and due to a legitimate *ep* (*ep*, *ep*) continuation of the corresponding forms of the other auxiliary (*habere*, *habeat*), which is still heard in *ch'è me aepa purtate*, *ch'lu aepa purtate*, *ch'io abbia portato*, *ch'egli abbia portato*. Next may be noted the 3rd person singular in *-p* of the perfect of *esse* and of the first conjugation in the Forlì dialect (*fop*, fu; *mandép*, mandò; &c.). This also must be analogical, and due to a legitimate *ep* (*ep*, *ep*) continuation of the corresponding forms of the other auxiliary (*habere*, *habeat*), which is still heard in *ch'è me aepa purtate*, *ch'lu aepa purtate*, *ch'io abbia portato*, *ch'egli abbia portato*. Next may be noted the 3rd person singular in *-p* of the perfect of *esse* and of the first conjugation in the Forlì dialect (*fop*, fu; *mandép*, mandò; &c.). This also must be analogical, and due to a legitimate *ep* (*ep*, *ep*) continuation of the corresponding forms of the other auxiliary (*habere*, *habeat*), which is still heard in *ch'è me aepa purtate*, *ch'lu aepa purtate*, *ch'io abbia portato*, *ch'egli abbia portato*. Next may be noted the 3rd person singular in *-p* of the perfect of *esse* and of the first conjugation in the Forlì dialect (*fop*, fu; *mandép*, mandò; &c.). This also must be analogical, and due to a legitimate *ep* (*ep*, *ep*) continuation of the corresponding forms of the other auxiliary (*habere*, *habeat*), which is still heard in *ch'è me aepa purtate*, *ch'lu aepa purtate*, *ch'io abbia portato*, *ch'egli abbia portato*. Next may be noted the 3rd person singular in *-p* of the perfect of *esse* and of the first conjugation in the Forlì dialect (*fop*, fu; *mandép*, mandò; &c.). This also must be analogical, and due to a legitimate *ep* (*ep*, *ep*) continuation of the corresponding forms of the other auxiliary (*habere*, *habeat*), which is still heard in *ch'è me aepa purtate*, *ch'lu aepa purtate*, *ch'io abbia portato*, *ch'egli abbia portato*. Next may be noted the 3rd person singular in *-p* of the perfect of *esse* and of the first conjugation in the Forlì dialect (*fop*, fu; *mandép*, mandò; &c.). This also must be analogical, and due to a legitimate *ep* (*ep*, *ep*) continuation of the corresponding forms of the other auxiliary (*habere*, *habeat*), which is still heard in *ch'è me aepa purtate*, *ch'lu aepa purtate*, *ch'io abbia portato*, *ch'egli abbia portato*. Next may be noted the 3rd person singular in *-p* of the perfect of *esse* and of the first conjugation in the Forlì dialect (*fop*, fu; *mandép*, mandò; &c.). This also must be analogical, and due to a legitimate *ep* (*ep*, *ep*) continuation of the corresponding forms of the other auxiliary (*habere*, *habeat*), which is still heard in *ch'è me aepa purtate*, *ch'lu aepa purtate*, *ch'io abbia portato*, *ch'egli abbia portato*. Next may be noted the 3rd person singular in *-p* of the perfect of *esse* and of the first conjugation in the Forlì dialect (*fop*, fu; *mandép*, mandò; &c.). This also must be analogical, and due to a legitimate *ep* (*ep*, *ep*) continuation of the corresponding forms of the other auxiliary (*habere*, *habeat*), which is still heard in *ch'è me aepa purtate*, *ch'lu aepa purtate*, *ch'io abbia portato*, *ch'egli abbia portato*. Next may be noted the 3rd person singular in *-p* of the perfect of *esse* and of the first conjugation in the Forlì dialect (*fop*, fu; *mandép*, mandò; &c.). This also must be analogical, and due to a legitimate *ep* (*ep*, *ep*) continuation of the corresponding forms of the other auxiliary (*habere*, *habeat*), which is still heard in *ch'è me aepa purtate*, *ch'lu aepa purtate*, *ch'io abbia portato*, *ch'egli abbia portato*. Next may be noted the 3rd person singular in *-p* of the perfect of *esse* and of the first conjugation in the Forlì dialect (*fop*, fu; *mandép*, mandò; &c.). This also must be analogical, and due to a legitimate *ep* (*ep*, *ep*) continuation of the corresponding forms of the other auxiliary (*habere*, *habeat*), which is still heard in *ch'è me aepa purtate*, *ch'lu aepa purtate*, *ch'io abbia portato*, *ch'egli abbia portato*. Next may be noted the 3rd person singular in *-p* of the perfect of *esse* and of the first conjugation in the Forlì dialect (*fop*, fu; *mandép*, mandò; &c.). This also must be analogical, and due to a legitimate *ep* (*ep*, *ep*) continuation of the corresponding forms of the other auxiliary (*habere*, *habeat*), which is still heard in *ch'è me aepa purtate*, *ch'lu aepa purtate*, *ch'io abbia portato*, *ch'egli abbia portato*. Next may be noted the 3rd person singular in *-p* of the perfect of *esse* and of the first conjugation in the Forlì dialect (*fop*, fu; *mandép*, mandò; &c.). This also must be analogical, and due to a legitimate *ep* (*ep*, *ep*) continuation of the corresponding forms of the other auxiliary (*habere*, *habeat*), which is still heard in *ch'è me aepa purtate*, *ch'lu aepa purtate*, *ch'io abbia portato*, *ch'egli abbia portato*. Next may be noted the 3rd person singular in *-p* of the perfect of *esse* and of the first conjugation in the Forlì dialect (*fop*, fu; *mandép*, mandò; &c.). This also must be analogical, and due to a legitimate *ep* (*ep*, *ep*) continuation of the corresponding forms of the other auxiliary (*habere*, *habeat*), which is still heard in *ch'è me aepa purtate*, *ch'lu aepa purtate*, *ch'io abbia portato*, *ch'egli abbia portato*. Next may be noted the 3rd person singular in *-p* of the perfect of *esse* and of the first conjugation in the Forlì dialect (*fop*, fu; *mandép*, mandò; &c.). This also must be analogical, and due to a legitimate *ep* (*ep*, *ep*) continuation of the corresponding forms of the other auxiliary (*habere*, *habeat*), which is still heard in *ch'è me aepa purtate*, *ch'lu aepa purtate*, *ch'io abbia portato*, *ch'egli abbia portato*. Next may be noted the 3rd person singular in *-p* of the perfect of *esse* and of the first conjugation in the Forlì dialect (*fop*, fu; *mandép*, mandò; &c.). This also must be analogical, and due to a legitimate *ep* (*ep*, *ep*) continuation of the corresponding forms of the other auxiliary (*habere*, *habeat*), which is still heard in *ch'è me aepa purtate*, *ch'lu aepa purtate*, *ch'io abbia portato*, *ch'egli abbia portato*. Next may be noted the 3rd person singular in *-p* of the perfect of *esse* and of the first conjugation in the Forlì dialect (*fop*, fu; *mandép*, mandò; &c.). This also must be analogical, and due to a legitimate *ep* (*ep*, *ep*) continuation of the corresponding forms of the other auxiliary (*habere*, *habeat*), which is still heard in *ch'è me aepa purtate*, *ch'lu aepa purtate*, *ch'io abbia portato*, *ch'egli abbia portato*. Next may be noted the 3rd person singular in *-p* of the perfect of *esse* and of the first conjugation in the Forlì dialect (*fop*, fu; *mandép*, mandò; &c.). This also must be analogical, and due to a legitimate *ep* (*ep*, *ep*) continuation of the corresponding forms of the other auxiliary (*habere*, *habeat*), which is still heard in *ch'è me aepa purtate*, *ch'lu aepa purtate*, *ch'io abbia portato*, *ch'egli abbia portato*. Next may be noted the 3rd person singular in *-p* of the perfect of *esse* and of the first conjugation in the Forlì dialect (*fop*, fu; *mandép*, mandò; &c.). This also must be analogical, and due to a legitimate *ep* (*ep*, *ep*) continuation of the corresponding forms of the other auxiliary (*habere*, *habeat*), which is still heard in *ch'è me aepa purtate*, *ch'lu aepa purtate*, *ch'io abbia portato*, *ch'egli abbia portato*. Next may be noted the 3rd person singular in *-p* of the perfect of *esse* and of the first conjugation in the Forlì dialect (*fop*, fu; *mandép*, mandò; &c.). This also must be analogical, and due to a legitimate *ep* (*ep*, *ep*) continuation of the corresponding forms of the other auxiliary (*habere*, *habeat*), which is still heard in *ch'è me aepa purtate*, *ch'lu aepa purtate*, *ch'io abbia portato*, *ch'egli abbia portato*. Next may be noted the 3rd person singular in *-p* of the perfect of *esse* and of the first conjugation in the Forlì dialect (*fop*, fu; *mandép*, mandò; &c.). This also must be analogical, and due to a legitimate *ep* (*ep*, *ep*) continuation of the corresponding forms of the other auxiliary (*habere*, *habeat*), which is still heard in *ch'è me aepa purtate*, *ch'lu aepa purtate*, *ch'io abbia portato*, *ch'egli abbia portato*. Next may be noted the 3rd person singular in *-p* of the perfect of *esse* and of the first conjugation in the Forlì dialect (*fop*, fu; *mandép*, mandò; &c.). This also must be analogical, and due to a legitimate *ep* (*ep*, *ep*) continuation of the corresponding forms of the other auxiliary (*habere*, *habeat*), which is still heard in *ch'è me aepa purtate*, *ch'lu aepa purtate*, *ch'io abbia portato*, *ch'egli abbia portato*. Next may be noted the 3rd person singular in *-p* of the perfect of *esse* and of the first conjugation in the Forlì dialect (*fop*, fu; *mandép*, mandò; &c.). This also must be analogical, and due to a legitimate *ep* (*ep*, *ep*) continuation of the corresponding forms of the other auxiliary (*habere*, *habeat*), which is still heard in *ch'è me aepa purtate*, *ch'lu aepa purtate*, *ch'io abbia portato*, *ch'egli abbia portato*. Next may be noted the 3rd person singular in *-p* of the perfect of *esse* and of the first conjugation in the Forlì dialect (*fop*, fu; *mandép*, mandò; &c.). This also must be analogical, and due to a legitimate *ep* (*ep*, *ep*) continuation of the corresponding forms of the other auxiliary (*habere*, *habeat*), which is still heard in *ch'è me aepa purtate*, *ch'lu aepa purtate*, *ch'io abbia portato*, *ch'egli abbia portato*. Next may be noted the 3rd person singular in *-p* of the perfect of *esse* and of the first conjugation in the Forlì dialect (*fop*, fu; *mandép*, mandò; &c.). This also must be analogical, and due to a legitimate *ep* (*ep*, *ep*) continuation of the corresponding forms of the other auxiliary (*habere*, *habeat*), which is still heard in *ch'è me aepa purtate*, *ch'lu aepa purtate*, *ch'io abbia portato*, *ch'egli abbia portato*. Next may be noted the 3rd person singular in *-p* of the perfect of *esse* and of the first conjugation in the Forlì dialect (*fop*, fu; *mandép*, mandò; &c.). This also must be analogical, and due to a legitimate *ep* (*ep*, *ep*) continuation of the corresponding forms of the other auxiliary (*habere*, *habeat*), which is still heard in *ch'è me aepa purtate*, *ch'lu aepa purtate*, *ch'io abbia portato*, *ch'egli abbia portato*. Next may be noted the 3rd person singular in *-p* of the perfect of *esse* and of the first conjugation in the Forlì dialect (*fop*, fu; *mandép*, mandò; &c.). This also must be analogical, and due to a legitimate *ep* (*ep*, *ep*) continuation of the corresponding forms of the other auxiliary (*habere*, *habeat*), which is still heard in *ch'è me aepa purtate*, *ch'lu aepa purtate*, *ch'io abbia portato*, *ch'egli abbia portato*. Next may be noted the 3rd person singular in *-p* of the perfect of *esse* and of the first conjugation in the Forlì dialect (*fop*, fu; *mandép*, mandò; &c.). This also must be analogical, and due to a legitimate *ep* (*ep*, *ep*) continuation of the corresponding forms of the other auxiliary (*habere*, *habeat*), which is still heard in *ch'è me aepa purtate*, *ch'lu aepa purtate*, *ch'io abbia portato*, *ch'egli abbia portato*. Next may be noted the 3rd person singular in *-p* of the perfect of *esse* and of the first conjugation in the Forlì dialect (*fop*, fu; *mandép*, mandò; &c.). This also must be analogical, and due to a legitimate *ep* (*ep*, *ep*) continuation of the corresponding forms of the other auxiliary (*habere*, *habeat*), which is still heard in *ch'è me aepa purtate*, *ch'lu aepa purtate*, *ch'io abbia portato*, *ch'egli abbia portato*. Next may be noted the 3rd person singular in *-p* of the perfect of *esse* and of the first conjugation in the Forlì dialect (*fop*, fu; *mandép*, mandò; &c.). This also must be analogical, and due to a legitimate *ep* (*ep*, *ep*) continuation of the corresponding forms of the other auxiliary (*habere*, *habeat*), which is still heard in *ch'è me aepa purtate*, *ch'lu aepa purtate*, *ch'io abbia portato*, *ch'egli abbia portato*. Next may be noted the 3rd person singular in *-p* of the perfect of *esse* and of the first conjugation in the Forlì dialect (*fop*, fu; *mandép*, mandò; &c.). This also must be analogical, and due to a legitimate *ep* (*ep*, *ep*) continuation of the corresponding forms of the other auxiliary (*habere*, *habeat*), which is still heard in *ch'è me aepa purtate*, *ch'lu aepa purtate*, *ch'io abbia portato*, *ch'egli abbia portato*. Next may be noted the 3rd person singular in *-p* of the perfect of *esse* and of the first conjugation in the Forlì dialect (*fop*, fu; *mandép*, mandò; &c.). This also must be analogical, and due to a legitimate *ep* (*ep*, *ep*) continuation of the corresponding forms of the other auxiliary (*habere*, *habeat*), which is still heard in *ch'è me aepa purtate*, *ch'lu aepa purtate*, *ch'io abbia portato*, *ch'egli abbia portato*. Next may be noted the 3rd person singular in *-p* of the perfect of *esse* and of the first conjugation in the Forlì dialect (*fop*, fu; *mandép*, mandò; &c.). This also must be analogical, and due to a legitimate *ep* (*ep*, *ep*) continuation of the corresponding forms of the other auxiliary (*habere*, *habeat*), which is still heard in *ch'è me aepa purtate*, *ch'lu aepa purtate*, *ch'io abbia portato*, *ch'egli abbia portato*. Next may be noted the 3rd person singular in *-p* of the perfect of *esse* and of the first conjugation in the Forlì dialect (*fop*, fu; *mandép*, mandò; &c.). This also must be analogical, and due to a legitimate *ep* (*ep*, *ep*) continuation of the corresponding forms of the other auxiliary (*habere*, *habeat*), which is still heard in *ch'è me aepa purtate*, *ch'lu aepa purtate*, *ch'io abbia portato*, *ch'egli abbia portato*. Next may be noted the 3rd person singular in *-p* of the perfect of *esse* and of the first conjugation in the Forlì dialect (*fop*, fu; *mandép*, mandò; &c.). This also must be analogical, and due to a legitimate *ep* (*ep*, *ep*) continuation of the corresponding forms of the other auxiliary (*habere*, *hab*

central, the Campidanese or southern and the Gallurese or northern. The third certainly indicates a Sardinian basis, but is strangely disturbed by the intrusion of other elements, among which the Southern Corsican (Sartene) is by far the most copious. The other two are homogeneous, and have great affinity with each other; the Logudorese comes more particularly under consideration here.—The pure Sardinian vocalism has this peculiarity that each accented vowel of the Latin appears to be reduced without alteration. Consequently there are no diphthongs representing simple Latin vowels; nor does the rule hold good which is true for so great a proportion of the Romance languages, that the representatives of the *e* and the *i* on the one hand and those of the *o* and the *u* on the other are normally combined. Hence *plenu* (*è*); *dege*, decem (*è*); *binu*, vino (*ì*); *più* (*ì*); *fiore* (*ò*); *roda*, rota (*ò*); *duru* (*ù*); *nughe*, nucis (*ù*). The unaccented vowels keep their ground well, as has already been seen in the case of the finals by the examples adduced.—The *s* and *f* of the ancient termination are preserved, though not constantly: *tres, onus, passados annos, plantas, faghes, facis, lenemus; mughet, muglietta*.—The formulae *ce, et, ge, gi* may be represented by *che* (*ke*), &c.; but this appearance of special antiquity is really illusory (see *Arch.* ii. 143-144). The nexus *d, &c.*, may be maintained in the beginning of words (*claru, plus*); but if they are in the body of the word they usually undergo resolutions which, closely related though they be to those of Italian, sometimes bring about very singular results (e.g. *usare*, which by the intermediate forms *uscare, usjare* leads back to *uscare = usitare = ustulare*). *Nè* is the representative of *nj* (*testimòntu, &c.*); and *lj* is reduced to *l* alone (e.g. *mètus, messis; Campidanese mèltus*). For *ll* a frequent substitute is *dè*; *maissida, maxilla, &c.* Quite characteristic is the continual labialization of the formulae *puu, guu, cu, gu, &c.* (e.g. *bu, equu; uerene, sanguine* (see *Arch.* ii. 143)). The dropping the primary *d* (*roere, rodere, &c.*) is not of the secondary (*finidu, sanidade, maduru*) is frequent. Characteristic also is the Logudorese prothesis of *s* before the initial *s* followed by a consonant (*iscammu, istella, ispada*), like the prothesis of *e* in Spain and in France (see *Arch.* iii. 447 sqq.).—In the order of the present discussion it is in connexion with this territory that we are for the first time led to consider those phonetic changes in words of which the cause is merely syntactical of transitory, and chiefly those passing accidents which occur to the initial consonant through the historically legitimate or the merely antinomical action of the final consonant. The general explanation of such phenomena reduces itself to this, that, given the intimate syntactical relation of two words, the initial consonant of the second retains or modifies its character as it would retain or modify it if the two words were one. The Celtic languages are especially distinguished by this peculiarity; and among the dialects of Upper Italy the Bergamasc offers a clear example. This dialect is accustomed to drop the *v*, whether primary or secondary, between vowels in the individual vocables (*caà, cavare; fàa, fava, &c.*), but to preserve it if it is preceded by a consonant (*sera, &c.*)—And similarly in syntactical combination we have, for example, *de, f, di, vino*; but *u, il, vino*. Insofar as southern and central Italy furnish a large number of such phenomena; for Sardinia we shall simply cite a single class, which is at once obvious and easily explained, viz. that represented by *su oe*, its above, alongside of *sos boes, i buoi* (cf. *biera, bibere; erba*).—The article is derived from *ipse* instead of from *sile*: *su sos, sa sas*,—again a geographical anticipation of Spain, which in the Catalan of the Balearic islands still preserves the article from *ipse*.—A special connexion with Spain exists besides in the *nominis* type of inflexion, which is constant among the Sardinians (Span. *nomne, &c.* whence *nombre, &c.*), *nomen, nomen, rãmine, aearmine, legumene, &c.* (see *Arch.* ii. 429 sqq.). Especially noteworthy is the conjunction of the final *s* with the paradigm *canidus, canibus, &c.* *timere, timères, &c.*, precisely in the sense of the imperfect subjunctive (cf. *A.* i. cf. *C.* 3 b). Next comes the analogical and almost corrupt diffusion of the *-si* of the ancient strong perfects (such as *posi, rosi*)

by which *cantesi, timesi* (cantavi, timui), *dolgesi, dolui*, are reached. Proof of the use and even the abuse of the strong perfects is afforded, however, by the participles and the infinitives of the category to which belong the following examples: *tennidu, tenuto; pãrdidu, parso; bãfidu, vaisto; tennere, bãlere, &c.* (*Arch.* ii. 432-433). The future, finally, shows the unagglutinated periphrasis: *hãpo a mangiãre* (ho a mangiare = manger-ò); as indeed the unagglutinated forms of the future and the conditional occur in ancient vernacular texts of other Italian districts. (The Campidanese manuscript, in Greek characters, published by Blancard and Wescher (*Bibliothèque de l'École des Chartes*, xxxv. 256-257), goes back as far as the last years of the 11th century. Next come the Cagliari MSS. published by Solmi (*Le Carte volgari dell' Archivio arcivescovile di Cagliari*, Florence, 1905; cf. Guarnerio in *Studi romansi*, fascicolo iv. 189 et seq.), the most ancient of which in its original form dates from 1114-1120. For Loguduro, the *Condaghe di S. Pietro di Silihi* (§§ 211-212), published by G. Bonazzi (Sassari-Cagliari, 1902; cf. Meyer-Lübke, *Zur Kenntnis des Altlogudoreschen*, Vienna, 1900), is of the highest importance.)

3. *Vegliote* (*Vegliote*).—Perhaps we may not be considered to be departing from Ascoli's original plan if we insert here as a third member of the group *B* the neo-Latin dialect which found its last refuge in the island of Veglia (Gulf of Quarnero), where it came definitively to an end in 1898. The Vegliote dialect is the last remnant of a language which some long time ago extended from thence along the Dalmatian coast, whence it gained the name of *Dalmatico*, a language which should be carefully distinguished from the Venetian dialect spoken to this day in the towns of the Dalmatian littoral. It has not been mentioned in any of the surveys of Rumanian, and of that type of Romano-Balkan dialect which is represented by the Latin elements of Albanian, but to a certain extent also, and especially with regard to the vowel sounds, of the south-eastern dialects of Italy, while it has also affinities with Friuli, Istria and Venetia. These characteristics taken altogether seem to suggest that *Dalmatico* differs as much as does Sardinian from the purely Italian type. It rejects the *-s*, it is true, retaining instead the nominative form in the plural; but here these facts are no longer a criterion, since in this point Italian and Rumanian are in agreement. A tendency which we have already noted, and shall have further cause to note hereafter, is that of the *ai* which connects in a striking way the Vegliote and Abruzzo-Apulian dialects, consists in reducing the accented vowels to diphthongs: examples of this are: *spuata*, Ital. *spada*; *buarka*, Ital. *barca*; *fiar*, Ital. *ferro*; *naat*, Ital. *notte*; *katatna*, Ital. *catena*; *paiza*, Ital. *perce*; Lat. *piru*; *jaura*, Ital. *ora*; *nash*, Ital. *noce*; Lat. *nico*; *orlatka*, Ital. *ortica*; *joiva*, Ital. *uova*. Other vowel phenomena should also be noted, for example those exemplified in *prut*, Ital. *prato*; *dik*, Ital. *dici*; Lat. *dècem*; *luk*, Ital. *luogo*; Lat. *lècu*; *krask*, Ital. *creocere*; *cenk*, Ital. *cinque*; Lat. *gũnque*; *bũka*, Ital. *bocca*; Lat. *dũca*. With regard to the consonants, it would not be surprising to notice the invariability of the explosive surds as in Rumanian and the southern dialects (for which several of the words just cited will serve as examples, with the addition of *kuosa*, Ital. *casa*; *praisa*, Ital. *presa*; *struata*, Ital. *strada*; *rosuata*, Ital. *rugada*; *latri*, Ital. *ladro*; *raipa*, Ital. *riwa*). The *c* in the formula *ce*, whether primary or secondary, is represented by *k*: *kaina*, Ital. *cena*; *kanaisia*, Ital. *cinigia*; *abait*, Ital. *aceto*; *plakãr*, Ital. *piacere*; *dik*, Ital. *dici*; *mũkna*, Ital. *macina*; *doitko*, Ital. *dodici*; and similarly the *g* in the formula *ge* is represented by the corresponding guttural: *ghelũt*, Ital. *gelato*; *jonãr*, Ital. *giungere*; *piãngre*, Ital. *piangere*, &c. On the contrary, the guttural *g* of the primary formula in *ai* becomes *ç* (cf. *Ita.* *çai*); this phenomenon is also noteworthy as seeming to justify the inference that the *ai* was pronounced *ai*. *Pi* is preserved, as in Rumanian (*sopio*, Lat. *septem*), and often, again as in Rumanian, *ç* is also reduced to *pi* (*septem*, Lat. *ocio*). As to morphology, a characteristic point is the preservation of the Lat. *cantaturo*, Ital. *avro cantato*, in the function of a simple future. *Cantaturo* also occurs as a conditional. For Vegliote and Dalmatico in general, see M. G. Bartoli's fundamental work, *Das Dalmatische* (2 vols., Vienna, 1906), and *Zeitschrift für roman. Philologie*, xxxii. 1 sqq.; Merlo, *Rivista di filologia e d'istruzione class.*, xxxv. 472 sqq. A short document written about 1280 in the Dalmatian dialect of Ragusa is to be found in *Archeografo Triestino*, new series, vol. i. pp. 85-86.)

C. *Dialects which diverge more or less from the genuine Italian or Tuscan type, but which at the same time can be conjoined with the Tuscan as forming part of a special system of Neo-Latin dialects.*

1. *Venetian*.—Between "Venetian" and "Venetic" several distinctions must be drawn (*Arch.* i. 391 sqq.). At the present day the population of the Venetian cities is "Venetian" in language, but the country districts are in various ways Venetic.<sup>1</sup> The ancient language of Venice itself and of its estuary was not a little different from that of the present time; and the Latin vein was particularly

<sup>1</sup> On this point see the chapter, "La terra ferma veneta considerata in ispecie nei suoi rapporti con la sezione centrale della zona ladina," in *Arch.* i. 406-447.



and *mp* are concerned; and it may even be said to go counter to this tendency by reducing *ng* and *nd* to *ni*, *ni* (e.g. *pàncri*, *pungere*; *menzu*, *Ital. mežo*; *sponza*, *Ital. spugna*, *Ven. sponža*).<sup>1</sup> Nay, even in the passing of the sonant into the surd, the Neapolitan dialects would yield special and important contributions (nor is even the Sicilian limited to the case just specified), among which we will only mention the change of *d* between vowels into *l* in the last syllable of proparoxytones (e.g. *simmo*, *Sicil. simmù*, *midò*, and in the formula *giacchio, braccio, &c.*). There is a quadrato, *quadrato*. From these series of sonants changing into surds comes a peculiar feature of the southern dialects—A pretty common characteristic is the regular progressive assimilation by which *nd* is reduced to *nn*, *ng* to *nn*, *mò* to *mm*, and even *nv* also to *mm* (*nn*, *nb*, *mò*, *mm*), e.g. Sicil. *innirri*, Neap. *innèrre*, scendere; Sicil. *chimmuu*, Neap. *chimmme*, piombo; Sicil. and Neap. *mmidia*, invidia; Sicil. *sànnu*, sangue. As belonging to this class of phenomena the Palaeo-Italic analogy (*nd* into *nn*, *n*), of which the Umbrian furnishes special evidence, readily suggests itself. Another important common characteristic is the reduction of secondary *pf* into *f* (*chizzu*, *ff*, Sicil. Neap. *cc.*, Ital. piano), *š* (Sicil. *šimmu*, Neap. *šimme*, fumes of secondary *pf* to *j* (which may be strengthened to *ghj*) if initial (Sicil. *januu*, Neap. *januche*, bianco; Sicil. *aghianchiarri*, imbiancare), to *l* if between vowels (Neap. *neghia*, nebbia, Sicil. *niglu*, nibbio); of primary *pf* and *bj* into *f* (Sicil. *sèlla*, Neap. *sèlta*, seppia) or *gh* respectively (Sicil. *ragga*, Neap. *aragga*, rabia), for which phenomena see also Genoué (B. 1). Further is to be noted the tendency to the sibilation of *çj*, for which Sicil. *jazzu*, ghiaccio, may serve as an example (Arch. II. 149)—a tendency more particularly betrayed in Upper Italy, but also in the *de* variety (cf. Abr. *ciacchio*, *ciacchio*, *ciacchio*, &c.). There is a common inclination also to elide the initial unaccented palatal vowel, and to prefix *a*, especially before *r* (this second tendency is found likewise in Southern Sardinian, &c.; see Arch. II. 138); e.g. Sicil. *nènniri*, Neap. *nènnere*, intendere; Sicil. *arriccamàri*, Neap. *arragamarè*, ricamare (see Arch. II. 150). Throughout the whole district, and the adjacent territories in Central Italy, a tendency also prevails towards resolving certain combinations of consonants by the insertion of a vowel; thus combinations in which occur *r* or *l*, *w* or *j* (Sicil. *šrccu*, Ital. Abr. *šrccu*, Ital. flauto, *šaltaru*, *šaltaru*, *šaltaru*, Ital. barba; *fruce*, Ital. *fruce*, Ital. *erba*, &c.); Avellinese *garamega*, gramigna; Neap. *švotro* = *švotro*, Ital. *štro*, *štro* = *štro*, Ital. gelso, *ajèd* side by side with *ajid*, Ital. età, *šaje* = *šaje*, Ital. odio, &c.); Abr. *niteije*, indiva, *nèbbje*, nebbia, &c.); *catàjeve* = *catàjeve*, cattivo, *gouèle*, = *gouèle*, gola, &c. &c., are examples from Molèffa, where is also normal the resolution of *šk* by *šek* (*mèšeker*, maschera, *šekètte*, scatola, &c.); cf. *šeddegno*, *šdegno*, in some dialects of the province of Avellino. In complete contrast to the tendency to get rid of double consonants which has been particularly noted in Southern (C. 1), we here come to the great reduction of *nd* into *n*, the tendency growing strong to gemination (the doubling of consonants), especially in proparoxytones; and the Neapolitan in this respect goes farther than the Sicilian (e.g. Sicil. *šoggiu*, suocero, *šimiri*, cenere, *doppu*, dopo; *šimmmula*, insieme, in-simul; Neap. *delleccato*, dilicito; *šmmeto*, umido; *šbbòle*).—As to the phonetic phenomena connected with the syntax (see B. 2), it is sufficient to cite such Sicilian examples as *nìsuna ronna*, *nesuna donna*, alongside of *ciù š donni*, *c'è donne*; *šincu jorna*, cinque giorni, alongside of *ciù š ghiorna*, più giorni; and the Neapolitan *la vocca*, la bocca, alongside of *a bocca*, ad buccan, &c.

(b) *Dialects of the Neapolitan Mainland*.—The Calabrian (by which is to be understood more particularly the vernacular group of the two Further Calabria) may be fairly considered as a continuation of the Sicilian type, as is seen from the following examples:—*cori*, scanty until we come to the 14th century.

(c) *Dialects of the Neapolitan Mainland*.—The Calabrian (by which is to be understood more particularly the vernacular group of the two Further Calabria) may be fairly considered as a continuation of the Sicilian type, as is seen from the following examples:—*cori*,

<sup>1</sup>[Traces are not lacking on the mainland of *ng* becoming *ni*, not only in Calabria, where at Cosenza are found, e.g. *chincèrre*, Ital. piangere, *manciare*, but also in Sannio and Apulia: *chiance*, *monce*, Ital. mungere, in the province of Avellino, *pàncri*, Ital. (T) pungi, at Brindisi. In Sicily, on the other hand, can be traced examples of *nc* *nh* *ni* *mp* becoming *ng* *nd* *mb*.]

cuore; *petra*; *fimmina*, femina; *tuce*, voce; *unure*, onore; *figghiu*, figlio; *spade*, spalle; *trizza*, treccia. Both Sicilian and Calabrian is the reducing of *ri* to *rr* (Sicil. *parrari*, Cal. *parrare*, parlare, &c.). The final vowel *-e* is reduced to *-i*, but is preserved in the more southern part, as is seen from the above examples. Even the *h* for *š* = *ff*, *asin'urr* (Sicil. *šuri*, fiore), which is characteristic in Calabria, has its forerunners in the island (see Arch. II. 456). And, in the same way, though the dominant varieties of Calabria seem to cling to the *m*, (it sometimes happens that *mm* takes the form of *mb*: *imbiscare* = Sicil. *mmiscari* 'immischiare', &c.) and *nd*, as opposed to the *mm*, *nn*, of the whole of Southern Italy and Sicily, we must remember, firstly, that certain other varieties have, e.g. *granne*, Ital. grande, and *chimmuu*, Ital. piombo; and secondly, that even in Sicily (at Milazzo, Barcelona, and as far as Messina) districts are to be found in which *nd* is used. Along the coast of the extreme south of Italy, when once we have passed the interruptions caused by the Basiliaco type (so called from the Basiliata), the Sicilian vocalism again presents itself in the Otrantine, especially in the seaboard of Capo di Leuca. In the Lecce variety of the Otrantine the vocalism which has just been described as Sicilian also keeps its ground in the main (cf. Morosi, Arch. iv.); *sira*, sera; *leitu*, oliveto; *pš*; *ura*, ora; *dulure*. Nay more, the Sicilian phenomenon of *ll* into *ghj* (*figghiu*, figlio, &c.) is well marked in Terra d'Otranto and also in Terra di Bari, and even extends through the Capitanata and the Basiliata (cf. D' Ovidio, Arch. iv. 159-160). As strongly marked in the Terra d'Otranto is the insular phenomenon of *ll* into *đđ* (*đr*), which is also very widely distributed through the Neapolitan territories on the eastern side of the Apennines, sending outshoots even to the Abruzzo. But in Terra d'Otranto we are already in the midst of the diaphanous of *oi* and *ai*, both non-positional and positional, the development or permanence of which is determined by the quality of the unaccented final vowel,—as generally happens in the dialects of the south. The diphthongs of *š* and *đ*, determined by final *-i* and *-u*, are also characteristic of central and northern Calabria (*viecciu* *ai*, *vecchio -a*, *vecchia -e*, *vuonu -i*, *bona -e*, &c. &c.). Thus there comes to be a treatment of the vowels, peculiar to the two peninsulas of Calabria and Salent. The diphthongal product of the *oi* is here *se*. The following are examples from the Lecce variety of the dialect: *core*, *pl. cuore*; *matu*, *matu*; *miciu*, *miciu*; *miciu*, *miciu*; *šenti*, *šenti*; *šente*; *olu*, *uèli*, *olu*, *voli*, *vola*; *mordu*, *murdù*; *morde*. The *ue* recalls the fundamental reduction which belongs to the Gallic (not to speak of the Spanish) regions, and stretches through the north of the Terra di Bari, where there are other diphthongs curiously suggestiv of the Gallic: e.g. at Bitonto alongside of *luèche*, *luogo*, *šugne*, *šonne*, we have the *oi* and the *ai* from *o* or *š* of the previous phase (*vegne*, vicino), and the *au* from *o* of the previous phase (*anare*, onore), besides a diphthongal disturbance of the *d*. Here also occurs the change of *š* into *e* more or less as in the Abruzzo, as in *šmà*, *šmà*, *šmà*, *šmà*. The following are pure Puglia, *arràdie*, arrivata; *n-šèpè*, "in capa," that is, in capo; to which may be added the continual weakening or elision of the unaccented vowels not only at the end but in the body of the word (thus, at Bitonto, *švendeti*, *špranzi*). A similar type meets us as we cross into Capitanata (Cerinola: *gràje* and *grèi*, *cruti* (but also *ppite*, *piède*, &c.), *coùe*, *coùe* (but also *fourè*, *fourè*, &c.); *špime*, vino, and similarly *ppite*, *pelo* (Neap. *pilo*), &c.; *šuke*, fuoco; *carelâte*, carità, *parlà*, parlare, &c.) such forms being apparently the outposts of the Abruzzan, which, however, is only reached through the Molise—a district not very populous even now, and still thinly peopled in bygone days—whose prevailing forms of speech in some measure interrupt the historical continuity of the dialects of the Adriatic versant, presenting, as it were, an irruption from the other side of the Apennines. In the head valley of the Molise, at Agnone, the legitimate precursors of the Abruzzan vernaculars reappear (*šedfa*, *fava*, *šufedde* and *-ute*, *štufe*, annoiato, *šed*, fare; *chiazza*, piazza, *chiegne*, piangere, *cuene*, cane; *puole*, palo, *prato*, prato, *cuone*, cane; *veire* and *vatre*, *voro*, *moile*, melo, and similarly *voive* and *veive*, *voive*; *šenne*, dono, *šenna*, dogà; *šinnare*, minore; *cuèrpe*, corpo, but *cuèrpe*, *cuèrpe*). The following are pure Abruzzan examples. (1) From Buccianico (Abruzzo Citeriore): *veire*, vivo; *traje*, *re*, *allure*, allora; *cravone*, corona; *šircù*, *šircù*, *šircù*; *mèle*, male; *gràme*, grande; *gùème*; but *šmulate*, *šmulate*; *štrade*, strada (where again it is seen that the reduction of the *d* depends on the quality of the final unaccented vowel, and that it is not produced exclusively by *i*, which would give rise to a further reduction: *šcellarite*, *šcellarite*; *šmpire*, *šmpiri*). (2) From Pratola Peliccia (Abruzzo Ulteriore II.): *maje*, *maje*; *šure*, onore; *šnrjùdite*, ingiuriata; *šperšite*, disperata (alongside of *veneddè*, *vendicare*). It almost appears that a continuity with Emilian <sup>1</sup> ought to be established across the Marches (where another irruption of greater

<sup>1</sup> It should, however, be noticed that there seem to be examples of the *š* from *d* in the southern dialects on the Tyrrhenian side; texts of Serrara d'Ischia give: *mancele*, mangiata, *marcelite*, maritata, *manneto*, mandato; also *lenno* = Neap. *ianno*, allora. As to the diphthongs, we should not omit to mention that some of them are obviously of comparatively recent formation. Thus, examples from Cerignola, such as *šppite*, oliveto, come from *\*špšitu* (cf. Lec. *šèu*, &c.), that is to say, they are posterior to the phenomenon of

"Italianness" has taken place; a third of more dubious origin has been indicated for Venice, C. 1); see *Arch.* ii, 445. A negative characteristic for Abruzzan is the absence of the change in the third syllable of the combinations *bi, bi, fi* (into *hij, j-, j-*) and the reason seems evident. Here the *pf, bj* and *fj* themselves appear to be modern or of recent reduction—the ancient formulae sometimes occurring intact (as in the Bergamasco for Upper Italy), e.g. *piánje* and *pránje* alongside of *piánje*, *piagnerè*, *branghe* alongside of *bianghe*, bianco (Fr. *blanc*), *fume* and *frume* alongside *fume*, *fume*. To the south of the Abruzzi begins and in the Abruzzi grows prominent that contrast in regard to the formulae *ald ad* (resolved in the Neapolitan and Sicilian *int ad*, &c., just as in the Piedmontese, &c.), by which the types *aldare*, *altare*, and *calde*, *caldo*, are reached.<sup>2</sup> For the rest, when the condition and connexions of the vowel system<sup>3</sup> still retained by so large a proportion of the dialects of the eastern versant of the Neapolitan Apennines, and the difference which exists in regard to the preservation of the unaccented vowels between the Ligurian and the Gallo-Italic forms of speech on the other versant of the northern Apennines, are considered, one cannot fail to see how much justice there is in the longitudinal or Apenninian partition of the Italian dialects indicated by Dante.—But, to continue, in the Basilicata, which drains into the Gulf of Taranto, and may still be said to remain the same, not only is the elision of final unaccented vowels a prevailing characteristic, there are also frequent elisions of the unaccented vowels within the word. Thus at Matera: *sintenn la femm chessa còs*, *sentendo la femina questa cosa*; *dispràrd*, *disperata*; at Sapónara di Grumento: *uomnn scirlat*, *uomini scellerati*; *metta*, *vendetta*.—But even if we return to the Mediterranean versant and, leaving the Sicilian type of the Calabrias, retrace our steps till we pass into the Neapolitan pure and simple, we find that even in Naples the unaccented final vowels behave badly, the labial turning to *e* (*bielle*, *bello*) and even the *a* (*bèllid*) being greatly weakened. And here occurs a Palaeo-Italic intrusion which is worth mention: while Latin was accustomed to drop the *u* of its nominative only in presence of *r* (*gener* from *\*genor-*), *vir* from *\*vir-u-*, cf. the Tuscan or Italian apocopated forms *gener* = *vénere*, *benner* = *vennero*, &c.), Oscean and Umbrian go much farther: *Oscean*, *hurz* = *\*hort-u-s*, Lat. *hortus*; *Umb.* *piháx*, *piatus*; *emps*, *emptus*, &c. In Umbrian inscriptions we find *u* alternating with the *a* of the nom. sing. fem. and plur. neut. In complete contrast with the Sicilian vocalism is the Neapolitan *e* for unaccented and particularly final *i* of the Latin and Neo-Latin or Italian phrases (e.g. *viene*, *viene*; cf. *infra*), to say nothing further of the regular diphthongization, within certain limits, of accented *e* or *o* in position (*aperite*, *aperto*, fem. *aperis*; *nuorite*, *morto*, fem. *moris*, &c.).—In the quasi-morphological domain it is to be noted how the Sicilian *o* for the ancient *ā*, *ā*, also still found in the Neapolitan, and, in particular, that they alternate with *a* and *e* in a manner that is determined by the difference of termination. Thus *cosetore*, *cutore*, *pl. coseture* (i.e. *coseturi*, the *-i* passing into *e* in keeping with the Neapolitan characteristic already mentioned); *ruse*, Ital. rosso; *i. r. rossa* - *z*, Ital. *rossa* - *e*; *noce*, *noce*, *pl. nuce*; *crude*, *ital. orosso*; *cride* ("criidi"), *tu credi*; *crede*, *egli crede*; *nigrè*, *tu negra*.

Passing now to a cursory mention of purely morphological phenomena, we begin with that form which is referred to the Latin pluperfect (see A. 1. B. 2), but which here too performs the functions of the conditional. Examples from the living dialects of (1) Calabria Calciore are *accuro*, *daci* (Castrovillari); *tu te calderi*, *tu te l'accolleresti* (Cosenza); *l'accetterà*, *l'accetterebbe* (Grimaldi); and from those of (2) the Abruzzi, *vuler*, *vorrei* (Castelli); *dere*, *darei* (Atessa); *candere*, *canterei*. For the dialects of the Abruzzi, we can check our observations by examples from the oldest chronicle of Aquila, as *non habera lassato*, *non avrebbe lasciato* (str. 180) (cf. *negara*, Ital. *negheri*, in old MS. of the Marches). There are some interesting remains (more or less corrupted both in form and usage) of ancient consonantal terminations which have not yet been sufficiently studied: *s' incaricaviti*, *s' incaricava*, *abat* (Basilicata, Senise); *ebbiti*, *ebbe* (*ib*); *aviadi*, *aveva* (Calabria, Grimaldi); *arrivadi*, *arrivò* (*ib*). The last example also gives the *-au* of the 3rd pers. sing. perf. of the 3rd conjugation which still occurs in Sicily and between the horns of the Neapolitan mainland. In the Abruzzi (and in the Ascolan district) the 3rd person of the plural is in process of disappearing (the *-no* having fallen away and the preceding vowel being obscured), and its function is assumed by the 3rd person singular; cf. C. 1.<sup>3</sup> The explanation of the Neo-vowel change by which the formula *e-u* became *i-u*. And, still in the same dialect, in an example like *grèje*, *creta*, the *ej* seems perhaps to be recent, for the reason that another *ej*, derived from an original *e* (Lat. *z*), is treated in the same way (*pèje*, *stede*, &c.). As to examples from Agnone like *puole*, *palo*, there still exists a plural *pèje* which points to the phrase *\*palo*.

<sup>2</sup> We should here mention that *callu* is also found in the *Vocabolario Siciliano*, and further occurs in Capitanata.

<sup>3</sup> This is derived in reality from the Latin termination *-unt*, which is reduced phonetically to *-u*, a phenomenon not confined to the Abruzzi; cf. *facere*, Ital. *facere*, Lat. *faciunt*, as *Norcia*; *criscit*, Ital. *crեսcunt*, Lat. *crեսcunt*, &c., at *Rieti*. And examples are also to be found in ancient Tuscan.

politan forms *songhe*, *io sono*, *essi sono*, *donghè*, *io do*, *stonghe*, *io sto*, as also of the enclitic of the 2nd person plural which exists, e.g. in the Sicil. *arissivu*, Neap. *aristèste*, *aveste*, has been correctly given more than once. It may be remarked in conclusion that this Neo-Latin region keeps company with the Rumanian in maintaining in large use the *-ora* derived from the ancient neuter plurals of the type *tempora*; Sicil. *jócura*, *giuochi*; Calabr. *niàura*, Abruzz. *nigrè*, *nidi*, Neap. *ortola* (= *-ra*), *orti*, Capitanata *àcure*, *aghi*, Apulian *accèdere* (Tarantine *accèddiri*), *uccelli*, &c. It is in this region, and more particularly in *Capua*, that we have the first appearance of what can definitely be called Italian, as shown in a Latin legal document of the year 960 (*suo co helle terre per helle fini qui hi contene trenta anni le possètte parie Sancti Benedicti*, Ital. "so che quelle terre per quei confini che qui contiene trent' anni le possedette la parte di S. Benedetto"), and belongs more precisely to Capua. The so-called *Carla Rossanese* (Calabria), written in a mixture of Latin and vulgar tongue, belongs to the first decades of the 12th century; while a document of Fondi (Campania) in the vulgar tongue goes back to the last decades of the same century. Neapolitan documents do not become abundant till the 14th century. The same is true of the Abruzzi and of Apulia; in the case of the latter the date may perhaps be put even later.

*Dialects of Umbria, the Marches and the Province of Rome.*—The phenomena characteristic of the Gallo-Italic dialects can be traced in the northern Marches in the dialects not only of the provinces of Pesaro and Urbino (*Arch. glott.* ii, 444), where we note also the constant dropping of the final vowels, strong elisions of accented and unaccented vowels, the suffix *-arius* becoming *-èr*, &c., but also as far as Ancona and beyond. As in Ancona, the double consonants are reduced to single ones; there are strong elisions (*bereta*, Ital. *berretta*; *blin*, Ital. *bellino*; *figurate*, Ital. "figurat"); *verme*, Ital. *verme*, "vermine"; &c.); the *-k-* becomes *g*, the *s*, *z*. At Jesi *-l-* and *-k-* become *d* and *g*, and the *g* is also found at Fabriano, though here it is modified in the Southern fashion (*spio*, *spiga*, Ital. *spicci*). Examples are also found of the dropping of *-d-* primary between vowels: *Pesaran*, *Italia*, *radica*; *Fabr. pedo*, *Ital. pedo*, which are noteworthy in that they indicate an isolated Gallo-Italic phenomenon, which is further traceable in Umbria (*peaccia* = *ped*, *Ital. orma*; *ràica* and *ràice*, *Ital. radice*; *trúbio*, *Ital. torbido*; *fràcio*, *Ital. fracido*; at *Rieti* also the dropping of the *-d-* is normal: *veo*, *Ital. vedo*; *fiàtu*, *Ital. fidato*, &c.); and here too is found the dropping of initial *d* for syntactical reasons: *ente*, *Ital. dente*, from *lu [d]ente*). According to some scholars of the Marches, the *f* for *a* also extends as far as Ancona; and it is certainly continued from the north, though it is precisely in the territory of the Marches that *Diadels* of Umbria, the Marches and the Province of Rome (the southern part of the Marches (the basin of the Tronto), after all, is Abruzzan in character. But the Abruzzan or Southern phenomena in general are widely diffused throughout the whole of the region comprising the Marches, Umbria, Latium and Aquila (for the territory of Aquila, belonging as it does both geographically and politically to the Abruzzi, is also attached linguistically to this group), which with regard to certain phenomena includes also that part of Tuscany lying to the south of the southern Ombrone. Further, the Tuscan dialect strictly so called sends into the Marches a few of its characteristics, and thus at *Arcevia* (see *Arch.* i, 403), and Ancona has no changes of tonic vowels (determined by the final vowel). Again, Umbria and the Sabine territory, and in some parts of the Roman territory, are connected with Tuscany by the phenomenon of *-ajo* for *-ariu* (*molinoajo*, *Ital. mugnaio*, &c.). But, to come to the Abruzzan-Southern phenomena, we should note that the Abruzzan *l* for *ld* extends into the central region (Norcia: *callu*, *caldo*; Rome: *ariscalla*, *risalda*); the phenomenon, however, occurs also in Corsica; and the assimilation of *nd* into *nn*, and of *mb* into *mm* stretches through Umbria, the Marches and Rome, and even crosses from the Roman province into southern Tuscany (Rieti: *quanno*, *quando*; Spoleto: *comannata*, *comandata*; Assisi: *piagnenno*, *piagnendo*; Sansonevino Marches: *piagnenno*, *piagnere*, *invece* (*invece*); *fabriano*: *ternesce*, *piagnenno*; *Assiso*: *monno*, *mondo*; Rome: *fronna*, *fronda*, *piagnenno*, *piombo*; Piattigliano (Tuscany): *quanno*, *piagnenno*). It is curious to note, side by side with this phenomenon, in the same districts, that of *nd* for *nn*, which we still find and which was more common in the past (*affando*, *affanno*, &c., see *Zeitschrift für roman. Philol.* xxi, 510). Even the diphthongs of the *e* and the *o* in position are largely represented. Examples are—at Norcia, *tiempo*, *uocchi*, *suoriti*; Assisi and Fabriano: *tiempo*; Orvieto: *tiempo*, *tierra*, *le tuorte*, *li torti*, and even *duonna*. The change of pre-consonantal *l* into *r*, so frequent throughout this region, and particularly characteristic of Rome, is a phenomenon common to the Aquilian dialects. Similar facts might be adduced in abundance. And it is to be noted that the relation common to Umbria, Roman and the Neapolitan dialects must have been more numerous in the past, as this was the region where the Tuscan current met the southern, and by reason of its superior culture gradually gained the

<sup>4</sup> [This resolution of *-l-* by *z*, or by a sound very near to *z*, is, however, a Roman phenomenon, found in some parts of Apulia (Mol-fettese *laucez*, *luce*, &c.), and also heard in parts of Sicily].



ascendancy.<sup>1</sup> Typical for the whole district (except the Marches) is the reduction to *f* (and later to *j*) of *ff* and of *l* initial, when followed by *i* or *u* (Vellieri, *tuna, tuce*; *Sora, juna, Ital. luna, jima*, Ital. *lima*; melica, Ital. mollica, *béts*, Ital. belli, bello, in vulgar Latin *bélla*; but *bélla, bella, &c.*). The phonological connexions between the Northern Umbrian, the Aretine, and the Gallo-Italic type have already been indicated (B. 2). In fact, it relates to morphology, the *-or-*series, plur. of the perfect of the first conjugation, has been pointed out as an essential peculiarity of the Umbro-Roman territory; but even this it shares with the Aquila vernaculars, which, moreover, extend it to the other conjugations (*amórno, timórno, &c.*), exactly like the *-ó* of the 3rd person singular. Further, this termination is found also in the Tuscan dialects.

Throughout almost the whole district should be noted the distinction between the masculine and neuter substantive, expressed by means of the article, the distinction being that the neuter substantive has an abstract and indeterminate signification; e.g. at S. Ginesio, in the Marches. *Lu pesce, bu lu pesce*, of fish in general, as food, &c.; at Sora *le vétre*, the sheet of glass, but *le vétre*, glass, the material, original substance.<sup>2</sup> As to the inflection of verbs, there is in the ancient texts of the region a notable prevalence of perfect form in the formation of the imperfect conjunctive; *tollesse*, Ital. togliesse; *sostenesse*, Ital. sostenesse; *conobbesse*, Ital. conoscesse, &c. In the northern Marches, we should note the preposition *sa*, Ital. *con* (*sa líta, Ital. con lei*), going back to a type similar to that of the Ital. "con-esso."

In a large part of Umbria an *m* or *l* is prefixed to the sign of the dative: *la, lu, m'oi, l'oi, &c.*, al, al, re, which must be the remains of the auxiliary prepositions *in(us), a(m)pu(d), cf. Prov. amb, am* (cf. *Arch.* ii. 444-446). By means of the series of Perugine texts this group of dialects may be traced back with confidence to the 13th century; and to this region should also belong a "Confession," half Latin half vernacular, dating from about the 11th century, edited and annotated by Flechia (*Arch.* vii. 121 sqq.). The "chronicle" of Monaldeschi has been already mentioned. The MSS. of the Marches go back to the beginning of the 13th century and perhaps still further back. For Roman see Monaci, *Rendic. dell'Accad. dei Lincei*, xv. 103 sqq.) there is a short inscription of the 11th century. To the 13th century belongs the *Liber historiarii Romanorum* (Monaci, *Archivio della Società rom. di storia patria*, xii.; and also, *Rendic. dei Lincei*, i. 94 sqq.), and to the first half of the same century the *Formole volgari* of Ranciri da Perugia (Monaci, *ib.*, xiv. 268 sqq.). There are more abundant texts for all parts of this district in the 14th century, to which also belong the *Cronica Aquilana* of Buccio di Ranallo, republished by De Bartholomæis (Rome, 1907).

#### D. Tuscan, and the Literary Language of the Italians.

We have now only to deal with the Tuscan territory. It is bounded on the W. by the sea. To the north it terminates with the Apennines; for Romagna Toscana, the strip of country on the Adriatic versant which belongs to it administratively, is assigned to Emilia as regards dialect. In the north-west also the Emilian presses on the Tuscan, extending as it does down the Mediterranean slope of the Apennines in Lunigiana and Garfagnana. Intrusions which may be called Emilian have also been noted to the west of the Apennines in the district where the Arno and the Tiber take their rise (Aretine dialects); and it has been seen how thence to the sea the Umbrian and Roman dialects surround the Tuscan. Such are the narrow limits of the "promised land" of the language which has succeeded and was worthy to succeed Latin in the history of Italian culture and

<sup>1</sup> There is therefore nothing surprising in the fact that, for example, the chronicle of Monaldeschi of Orvieto (14th century) should indicate a form of speech of which Muratori remarks:

"Romanis tunc familiaris, nimirum quæ in nonnullis accedebat ad Neapolitanam; seu vocibus seu pronuntiatiõnem." The *ai* into *aii*, &c. (*airo, moito*), which occur in the well-known *Vita di Cola di Rienzo*, examples of which can also be found in some corners of the Marches, and of which there are also a few traces in Latium, also show Abruzzan affinity. The phenomenon occurs also, however, in Emilian and Tuscan.

<sup>2</sup> A distinction between the masculine and the neuter article can also be noticed at Naples and elsewhere in the southern region, where it sometimes occurs that the initial consonant of the substantive is differently determined according as the substantive itself is conceived as masculine or neuter; thus at Naples, neut. *lo béro, masc. lo veró*, "il vero," &c.; at Cerignola (Capitanata), *u mmezzighe*, "il meglio," side by side with *u mteise* "il mese." The difference is evidently to be explained by the fact that the neuter article originally ended in a consonant (*-d* or *-ct*); see Merlo, *Zeitschrift für roman. Philol.* xxx. 449), which was then assimilated to the initial letter of the substantive, while the masculine article ended in a vowel.

<sup>3</sup> This subordinate prefix is common to the opposite valley of the Metauro, and appears farther south in the form of *me*.—Camerino: *me lu pettu*, nel petto, *me lu Seppurgh*, in the Sepolcro.

civilization,—the land which comprises Florence, Siena, Lucca and Pisa. The Tuscan type may be best described by the negative method. There do not exist in it, on the one hand, any of those phenomena by which the other dialectal types of Italy mainly differ from the Latin base (such as *ú=á*; frequent elision of unaccented vowels; *bo=gua*; *é=fl*; *nn=nd*, &c.), nor, on the other hand, is there any series of alterations of the Latin base peculiar to the Tuscan. This twofold negative description may further serve for the Tuscan or literary Italian as contrasted with all the other Neo-Latin languages; indeed, even where the Tuscan has a tendency to alterations common to other types of the family, it shows itself more sober and self-denying—as may be seen in the reduction of the *l* between vowels into *d* or of *c* (*k*) between vowels into *g*, which in Italian affects only a small part of the lexical series, while in Provençal or Spanish it may be said to pervade the whole (e.g. Prov. and Span. *mudar*, Ital. *mutare*; Prov. *segur*, Span. *seguro*, Ital. *sicuro*). It may consequently be affirmed without any partiality that, in respect to historical mobility, the Italian not only holds the first rank among Neo-Latin languages, but almost constitutes an intermediate grade between the ancient or Latin and the modern or Romance. What has just been said about the Tuscan, as compared with the other dialectal types of Italy, does not, however, preclude the fact that in the various Tuscan veins, and especially in the plebeian forms of speech, there occur particular instances of phonetic decay; but these must of necessity be ignored in so brief a sketch as the present. We shall confine ourselves to noting—what has a wide territorial diffusion—the reduction of *c* (*k*) between vowels to a mere breathing (e.g. *fúho*, fuoco, but *porco*), or even its complete elision; the same phenomenon occurs also between word and word (e.g. *la hasa*, but *in casa*), thus illustrating anew that syntactic class of phonetic alterations, either qualitative or quantitative, conspicuous in this region, also, which has been already discussed for insular and southern Italy (B. 2; C. 2, 3), and could be exemplified for the Roman region as well (C. 4). As regards one or two individual phenomena, it must also be confessed that the Tuscan or literary Italian is not so well preserved as some other Neo-Latin tongues. Thus, French always keeps in the beginning of words the Latin formulae *cl, pl, fi* (*cléf, plaisir, fleur*, in contrast with the Italian *chiave, piacere, fiore*); but the Italian makes up for this by the greater vigour with which it is wont to resolve the same formula within the words, and by the greater symmetry thus produced between the two series (in opposition to the French *cléf, clave*, we have, for example, the French *ail, ocló*; whereas, in the Italian, *chiave* and *occhio* correspond to each other). The Italian as well as the Rumanian has lost the ancient sibilant at the end (*-s* of the plurals, of the nominative singular, of the 2nd persons, &c.), which throughout the rest of the Romance area has been preserved more or less tenaciously; and consequently it stands lower than old Provençal and old French, as far as true declension or, more precisely, the functional distinction between the forms of the *casus rectus* and the *casus obliquus* is concerned. But even in this respect the superiority of French and Provençal has proved merely transitory, and in their modern condition all the Neo-Latin forms of speech are generally surpassed by Italian even as regards the pure grammatical consistency of the noun. In conjugation Tuscan has lost that tense which for the sake of brevity we shall continue to call the pluperfect indicative; though it still survives outside of Italy and in other dialectal types of Italy itself (C. 3; cf. B. 2). It has also lost the *fulcrum exactum*, or perfect subjunctive, which is found in Spanish and Rumanian. But no one would on that account maintain that the Italian conjugation is less truly Latin than the Spanish, the Rumanian, or that of any other Neo-Latin language. It is, on the contrary, by far the most distinctively Latin as regards the tradition both of form and function, although many effects of the principle of analogy are to be observed, sometimes common to Italian with the other Neo-Latin languages and sometimes peculiar to itself.

Those who find it hard to believe in the ethnological explana-

tion of linguistic varieties ought to be convinced by any example so clear as that which Italy presents in the difference between the Tuscan or purely Italian type on the one side and the Gallo-Italic on the other. The names in this instance correspond exactly to the facts of the case. For the Gallo-Italic on either side of the Alps is evidently nothing else than a modification—varying in degree, but always very great—of the vulgar Latin, due to the reaction of the language or rather the oral tendencies of the Celts who succumbed to the Roman civilization. In other words, the case is one of new ethnic individualities arising from the fusion of two national entities, one of which, numerically more or less weak, is so far victorious that its speech is adopted, while the other succeeds in adapting that speech to its own habits of utterance. Genuine Italian, on the other hand, is not the result of the combination or conflict of the vulgar Latin with other tongues, but is the pure development of this alone. In other words, the case is that of an ancient national fusion in which vulgar Latin itself originated. Here that is native which in the other case was intrusive. This greater purity of constitution gives the language a persistency which approaches permanent stability. There is no Old Italian to oppose to Modern Italian in the same sense as we have an Old French to oppose to a Modern French. It is true that in the old French writers, and even in the writers who used the dialects of Upper Italy, there was a tendency to bring back the popular forms to their ancient dignity; and it is true also that the Tuscan or literary Italian has suffered from the changes of centuries; but nevertheless it remains undoubted that in the former cases we have to deal with general transformations between old and new, while in the latter it is evident that the language of Dante continues to be the Italian of modern speech and literature. This character of invariability has thus been in direct proportion to the purity of its Latin origin, while, on the contrary, where popular Latin has been adopted by peoples of foreign speech, the elaboration which it has undergone along the lines of their oral tendencies becomes always the greater the farther we get away from the point at which the Latin reached them,—in proportion, that is, to the time and space through which it has been transmitted in these foreign mouths.<sup>1</sup>

As for the primitive seat of the literary language of Italy, not only must it be regarded as confined within the limits of that narrower Tuscany already described; strictly speaking, it must be identified with the city of Florence alone. Leaving out of account, therefore, a small number of words borrowed from other Italian dialects, as a certain number have naturally been borrowed from foreign tongues, it may be said that all that was not Tuscan was eliminated from the literary form of speech. If we go back to the time of Dante, we find, throughout almost all the dialects of the mainland with the exception of Tuscan, the change of vowels between singular and plural seen in *paese, paissi; quello, quilli; amore, amuri* (see B. 1; C. 3 b); but the literary language knows nothing at all of such a phenomenon, because it was unknown to the Tuscan region. But in Tuscan itself there were differences between Florentine and non-Florentine; in Florentine, e.g. it was and is usual to say *unto, giunto, punto*, while the non-Florentine had it *onto, gionto, ponto*, (Lat. *unctu*, &c.); at Florence they say *piazza, mezzo*, while elsewhere (at Lucca, Pisa) they say or used to say, *piassa, messo*. Now, it is precisely the Florentine forms which alone have currency in the literary language.

In the ancient compositions in the vulgar tongue, especially in poetry, non-Tuscan authors on the one hand accommodated their own dialect to the analogy of that which they felt to be the purest representative of the language of ancient Roman culture, while the Tuscan authors in their turn did not refuse to adopt the forms which had received the rights of citizenship from the

<sup>1</sup> A complete analogy is afforded by the history of the Aryan or Sanskrit language in India, which in space and time shows always more and more strongly the reaction of the oral tendencies of the aboriginal races on whom it has been imposed. Thus the Pall presents the ancient Aryan organism in a condition analogous to that of the oldest French, and the Prakrit of the Dramas, on the other hand, in a condition like that of modern French.

literary celebrities of other parts of Italy. It was this state of matters which gave rise in past times to the numerous disputes about the true fatherland and origin of the literary language of the Italians. But these have been deprived of all right to exist by the scientific investigation of the history of that language. If the older Italian poetry assumed or maintained forms alien to Tuscan speech, these forms were afterwards gradually eliminated, and the field was left to those which were purely Tuscan and indeed purely Florentine. And thus it remains absolutely true that, so far as phonetics, morphology, rudimental syntax, and in short the whole character and material of words and sentences are concerned, there is no literary language of Europe that is more thoroughly characterized by homogeneity and oneness, as if it had come forth in a single cast from the furnace, than the Italian.

But on the other hand it remains equally true that, so far as concerns a living confidence and uniformity in the use and style of the literary language—that is, of this Tuscan or Florentine material called to nourish the civilization and culture of all the Italians—the case is not a little altered, and the Italian nation appears to enjoy less fortunate conditions than other nations of Europe. Modern Italy had no glowing centre for the life of the whole nation into which and out of which the collective thought and language could be poured in ceaseless current for all and by all. Florence has not been Paris. Territorial contiguity and the little difference of the local dialect facilitated in the modern Rome the elevation of the language of conversation to a level with the literary language that came from Tuscany. A form of speech was thus produced which, though certainly destitute of the grace and the abundant flexibility of the Florentine, gives a good idea of what the dialect of a city becomes when it makes itself the language of a nation that is ripening its civilization in many and dissimilar centres. In such a case the dialect loses its slang and petty localisms, and at the same time also somewhat of its freshness; but it learns to express with more conscious sobriety and with more assured dignity the thought and the feeling of the various peoples which are fused in one national life. But what took place readily in Rome could not with equal ease happen in districts whose dialects were far removed from the Tuscan. In Piedmont, for example, or in Lombardy, the language of conversation did not correspond with the language of books, and the latter accordingly became artificial and laboured. Poetry was least affected by these unfortunate conditions; for poetry may work well with a multiform language, where the need and the stimulus of the author's individuality assert themselves more strongly. But prose suffered immensely, and the Italians had good cause to envy the spontaneity and confidence of foreign literatures—the French more particularly. In this reasonable envy lay the justification and the strength of the Manzoni school, which aimed at that absolute naturalness of the literary language, that absolute identity between the language of conversation and that of books, which the bulk of the Italians could reach and maintain only by naturalizing themselves in the living speech of modern Florence. The revolt of Manzoni against artificiality and mannerism in language and style was worthy of his genius, and has been largely fruitful. But the historical difference between the case of France (with the colloquial language of Paris) and that of Italy (with the colloquial language of Florence) implies more than one difficulty of principle; in the latter case there is sought to be produced by deliberate effort of the *literati* what in the former has been and remains the necessary and spontaneous product of the entire civilization. Manzoni's theories too easily lent themselves to deplorable exaggerations; men fell into a new artificiality, a manner of writing which might be called vulgar and almost slangy. The remedy for this must lie in the regulating power of the labour of the now regenerate Italian intellect,—a labour ever growing wider in its scope, more assiduous and more thoroughly united.

The most ancient document in the Tuscan dialect is a very short fragment of a jongleur's song (12th century; see Monaci, *Crestomazia*, 9-10). After that there is nothing till the 13th century. P. Santini has published the important and fairly

numerous fragments of a book of notes of some Florentine bankers, of the year 1211. About the middle of the century, our attention is arrested by the *Memoriali* of the Sieneſe Matassa di Spinello. To 1278 belongs the MS. in which is preserved the Pistoian version of the *Trattati morali* of Albertano, which we owe to Sofredi del Grathia. The Riccardian *Tristano*, published and annotated by E. G. Parodi, seems to belong to the end of the 13th and beginning of the 14th centuries. For other 13th-century writings see Monaci, *op. cit.* 31-32, 40, and Parodi, *Giornale storico della letteratura italiana*, x, 178-179. For the question concerning language, see Ascoli, *Arch. glott.* i. v. et seq.; D' Ovidio, *Le Correzioni ai Promessi Sposi e la questione della lingua*, 4th ed. Naples, 1895.

Literature.—K. L. Fernow in the third volume of his *Römische Studien* (Zurich, 1806-1808) gave a good survey of the dialects of Italy. The dawn of rigorously scientific methods had not then appeared; but Fernow's view is wide and general. Similar praise is due to Biondelli's work *Sui dialetti gallo-italici* (Milan, 1853), which, however, is still ignorant of Diez. August Fuchs, however, and Fernow and Biondelli, had made himself so far acquainted with the new methods; but his exploration (*Über die sogenannten unregelmässigen Zeitwörter in den romanischen Sprachen, nebst Andeutungen über die wichtigsten romanischen Mundarten*, Berlin, 1840), though certainly of utility, was not very successful. Nor can the rapid survey of the Italian dialects given by Friedrich Diez be ranked among the happiest portions of his great masterpiece. Among the founders of the school who distinguished themselves in this department the first outside of Italy were certainly Mussafia, a cautious and clear continuer of the master, and the singularly acute Hugo Schuchardt. Next came the *Archivio glottologico italiano* (Turin, 1873 and onwards. Up to 1897 there were published 16 vols.), the lead in which was taken by Ascoli and G. Flechia (d. 1892), who, together with the Dalmatian Adolf Mussafia (d. 1906), may be looked upon as the founders of the study of Italian dialects, and who have applied to their writings a rigidly methodical procedure and a historical and comparative standard, which have borne the best fruit. For historical studies dealing specially with the literary language, Nannucci, with his good judgment and breadth of view, led the way. He has not only mentioned here his *Analisi critica dei verbi italiani* (Florence, 1844). But the new method was to show how much more it was to and did effect. When this movement on the part of the scholars mentioned above became known, other enthusiasts soon joined them, and the *Arch. glottologico* developed into a school, which began to produce many prominent works on language [among the first in order of date and merit may be mentioned "Gli Allotropi italiani," by U. A. Canello (1887), *Arch. glott.* iii. 285-410; and *Le Origini della lingua poetica italiana*, by G. Caxx (d. 1882), (Florence, 1880); and the studies on the dialects. We shall here enumerate those of them which appear for one reason or another to have been the most notable. But, so far as works of a more general nature are concerned, we should first state that there have been other theories as to the classification of the Italian dialects (see also above the various notes on B. 1, 2 and C. 2) put forward by W. Meyer-Lübke (*Einführung in das Studium der romanischen Sprachwissenschaft*, Heidelberg, 1901; pp. 21-22), and M. Bartoli (*Altitalische Chronotabelle*, P. Savj-Lopez and M. Bartoli, Strassburg, 1903, pp. 171 et seq. 193-3 seq., and the seq.); at the end of the list, W. J. Meyer-Lübke afterwards filled in details of the system which he had sketched in Gröber's *Grundriss der romanischen Philologie*, i., 2nd ed. (1904), pp. 696 et seq. And from the same author comes that masterly work, the *Italienische Grammatik* (Leipzig, 1890), where the language and its dialects are set out in one organic whole, just as they are placed together in the concise chapter devoted to Italian in the above-mentioned *Grundriss* (pp. 637 et seq.). We will now give the list, from which we omit, however, the works quoted incidentally throughout the text: B. 1. a: Parodi, *Arch. glott.* xiv. 1 sqq., xv. 1 sqq., xvi. 185 sqq.; 333 sqq.; *Poesie in dial. tabiense del sec. XVII. Illustrate da E. G. Parodi* (Spezia, 1904); Schädel, *Die Mundart von Ormea* (Halle, 1903); Parodi, *Studi romanzi*, fasc. v.; b: Giacomino, *Arch. glott.* xv. 403 sqq.; Toppino, *ib.* xvi. 517 sqq.; Flechia, *ib.* xv. 111 sqq.; Nigra, *Miscell. Ascoli* (Turin, 1901), 247 sqq.; Renier, *Il Gelindo* (Turin, 1896); Salvioni, *Rendiconto Istituto lombardo*, s. ii., vol. xxxvii. 522 sqq.; c: Salvioni, *Fonetica del dialetto di Milano* (Turin, 1884); *Studi di filol. romana*, viii. 1 sqq.; *Arch. glott.* ix. 188 sqq. xiii. 355 sqq.; *Rendic. Ist. lomb.* s. ii., vol. xxxv. 719 sqq.; xxxix. 477 sqq.; 505 sqq. 569 sqq. 663 sqq. and the seq.; *Bollett. di Filologia*, x. 133 sqq.; *Palermese*, xv. 2nd ed. 1901; Meichel, *Der Dialekt des Poschiavolais* (Halle, 1905); v. Ettmayer, *Bergamaskische Alpenmundarten* (Leipzig, 1903); *Romanische Forschungen*, xiii. 321 sqq.; d: Mussafia, *Darstellung der romanologischen Mundart* (Vienna, 1871); Gaudenzi, *I Suoni ecc. della città di Bologna* (Turin, 1889); Ungarelli, *Vocab. del dial. bologn.* con una introduzione di A. Trauzzi sulla fonetica e sulla morfologia del dialetto (Bologna, 1901); Bertoni, *Il Dialetto di Modena* (Turin, 1905); Publè, "Schizzo dei dialetti del Frignano" in *L' Apennino modenese*, 673 sqq. (Rocca S. Casciano, 1895);

Piagnoli, *Fonetica parmigiana* (Turin, 1904); Restori, *Note fonetiche sui parlari dell' alta valle di Macra* (Laghorn, 1892); Gora, *Zeitschrift für romanische Philologie*, xvi. 372 sqq.; xvii. 133 sqq.; Nicoli, *Studi di filologia romana*, viii. 197 sqq. B. 2: Hofmann, *Die ladogoresische und campidanische Mundart* (Marburg, 1885); Wagner, *Lautlehre der süditalienischen Mundarten* (Malle a. S., 1907); Campese, *Fonetica del dialetto leopoldese* (Turin, 1901); Guarnerio, *Arch. glott.* xiii. 125 sqq., xiv. 131 sqq., xv. 385 sqq.; i. Rossi, *Le Lettere di Messer Andrea Calmo* (Turin, 1888); Wendringer, *Die paduanische Mundart bei Ruano* (Breslau, 1889); *Le Rime di Bartolomeo Cavaccio notaio bellunese della prima metà del sec. xvi. con illustraz. e note di v. Cian. e con illustrazioni linguistiche e lessico a cura di C. Salvioni* (2 vols., Bologna, 1893-1894); Gartner, *Zeitschr. für roman. Philol.* xvi. 183 sqq., 306 sqq.; Salvioni, *Arch. glott.* xvi. 245 sqq.; Vidossich, *Studi sul dialetto triestino* (Triest, 1901); *Zeitschr. für roman. Phil.* xxvii. 749 sqq.; Ascoli, *Arch. glott.* xv. 325 sqq.; Schneller, *Die romanischen Volksmundarten in Südtirol*, i. (Gera, 1880); von Slop, *Die triidentinische Mundart* (Klagenfurt, 1897); Ivc, *I Dialetti ladino-veneti dell' Istria* (Strassburg, 1900). C. 2: Guarnerio, *Arch. glott.* xiii. 125 sqq., xv. 131 sqq., 385 sqq., C. 3: a: Wenstrup-Pitrè, in Pitrè, *Fiabe, novelle e racconti popolari siciliani*, vol. 1, pp. cxviii sqq.; Schneegans, *Laut- und Lautentwicklung des sicil. Dialektes* (Strassburg, 1888); De Gregorio, *Saggio di fonetica siciliana* (Palermo, 1890); Pirandello, *Laut- und Lautentwicklung der Mundart von Girgenti* (Halle, 1891); Cremona, *Fonetica del Calabrone* (Acireale, 1895); Santangelo, *Arch. glott.* xv. 179 sqq.; Le 1901; C. 2: Nitti, *Il Dialetto di Bari*, part. 1 "Vocalismo moderno" (Milan, 1896); Abbatecchi, *Fonologia del dial. barese* (Avellino, 1896); Zingarelli, *Arch. glott.* xv. 83 sqq., 226 sqq.; Ziccardi, *Studi glottologici*, iv. 171 sqq.; D' Ovidio, *Arch. glott.* iv. 145 sqq., 403 sqq.; Finamore, *Vocabolario dell' uso abruzzese* (2nd ed., Città di Castello, 1893); Rollin, *Mitteilung XIV. der Gesellschaft zur Förderung deutscher Wissenschaft, Kunst und Literatur in Böhmen* (Prague, 1901); De Lollis, *Arch. glott.* xii. 1 sqq., 187 sqq.; *Miscell. Ascoli*, 275 sqq.; Savini, *La Grammatica e il lessico del dial. teramano* (Turin, 1881). C. 4: Merlo, *Zeitschr. für roman. Philol.* ix. 1 sqq., 438 sqq.; xxi. 1 sqq.; E. Monaci (notes on old Roman), *Rendic. Ist. lomb.* Feb. 21st, 1892, p. 94 sqq.; Rossi-Cassè, *Bollett. di storia patria degli Abruzzi*, vi.; Crocioni, *Miscell. Monaci*, pp. 429 sqq.; Ceci, *Arch. glott.* x. 167 sqq.; Parodi, *ib.* xiii. 299 sqq.; Campanelli, *Fonetica del dial. reatino* (Turin, 1896); Verga, *Sonetti e altre poesie di R. Torelli in dial. peruginio* (Milan, 1895); Bianchi, *Il Dialetto e la etnografia di Città di Castello* (Città di Castello, 1888); Neumann-Spallart, *Zeitschrift für roman. Phil.* xxvii. 273 sqq., 450 sqq.; *Weitere Beiträge zur Charakteristik des Dialektes der Marche* (Halle, s. l., 1907); Crocioni, *Studi di rom.*, ix. 617 sqq.; *Studi romanzi*, fasc. 4<sup>a</sup>, 113 sqq.; *Il Dial. di Ancona* (Rome, 1896); Lindstrom, *Studi romanzi*, fasc. 5<sup>a</sup>, 237 sqq.; Crocioni, *ib.* 27 sqq.; D.: Parodi, *Romania*, xviii.; Schwenke, *De dialecto quae carminibus popularibus tuscanis a Tigrino editis continetur* (Leipzig, 1872); Pieri, *Arch. glott.* xii. 107 sqq., 141 sqq., 161 sqq.; *Miscell. Caxx-Canello*, 305 sqq.; *Note sul dialetto aretino* (Pisa, 1886); *Zeitschr. für roman. Philol.* xxvii. 161 sqq.; Salvioni, *Arch. glott.* xvi. 395 sqq.; Hirsch, *Zeitschrift f. rom. Philol.* ix. 513 sqq., x. 56 sqq., 411 sqq. For researches on the etymology of all the Italian dialects, but chiefly of those of Northern Italy, the *Beitrag zur Kunde der norditalienischen Mundarten im XV. Jahrhundert* of Ad. Mussafia (Vienna, 1873) and the *Postille etimologiche* of Giov. Flechia (*Arch. glott.* ii, iii), are of the greatest importance. Biondelli's book is of no small service also for the numerous translations which it contains of the Prodigal Son into Lombard, Piedmontese and Emilian dialects. A dialogue translated into the vernaculars of all parts of Italy will be found in Zuccagni Orlandini's *Raccolta di dialetti italiani con illustrazioni etimologiche* (Florence, 1864). And every dialectal division is abundantly represented in a series of versions of a short novel of Boccaccio, which Papanti has published under the title *I Parlari italiani in Certaldo*, &c. (Laghorn, 1875).

[A very valuable and rich collection of dialectal essays on the most ancient documents for all parts of Italy is to be found in the *Crestomazia italiana dei primi secoli* of E. Monaci (Città di Castello, 1889-1897); see also in the *Altitalische Chronotabelle* of P. Savj-Lopez and M. Bartoli (Strassburg, 1903).] (G. I. A.; C. S. \*)

ITALIAN LITERATURE. 1. *Origins*.—One characteristic fact distinguishes the Italy of the middle ages with regard to its intellectual conditions—the tenacity with which the Latin tradition clung to life (see LATIN). At the end of the 5th century the

northern conquerors invaded Italy. The Roman world crumbled to pieces. A new kingdom arose at Ravenna under Theodoric, and there learning was not extinguished. The liberal arts flourished, the very Gothic kings surrounded themselves with masters of rhetoric and of grammar. The names of Cassiodorus, of Boetius, of Symmachus, are enough to show how Latin thought maintained its power amidst the political effacement of the Roman empire. And this thought held its ground throughout the subsequent ages and events. Thus, while elsewhere all culture had died out, there still remained in Italy some schools of laymen,<sup>1</sup> and some really extraordinary men were educated in them, such as Ennodius, a poet more pagan than Christian, Arator, Fortunatus, Venantius Jovannicus, Felix the grammarian, Peter of Pisa, Paulinus of Aquileia and many others, in all of whom we notice a contrast between the barbarous age they lived in and their aspiration towards a culture that should reunite them to the classical literature of Rome. The Italians never had much love for theological studies, and those who were addicted to them preferred Paris to Italy. It was something more practical, more positive, that had attraction for the Italians, and especially the study of Roman law. This zeal for the study of jurisprudence furthered the establishment of the medieval universities of Bologna, Padua, Vicenza, Naples, Salerno, Modena and Parma; and these, in their turn, helped to spread culture, and to prepare the ground in which the new vernacular literature was afterwards to be developed. The tenacity of classical traditions, the affection for the memories of Rome, the pre-occupation with political interests, particularly shown in the wars of the Lombard communes against the empire of the Hohenstaufens, a spirit more naturally inclined to practice than to theory—all this had a powerful influence on the fate of Italian literature. Italy was wanting in that combination of conditions from which the spontaneous life of a people springs. This was chiefly owing to the fact that the history of the Italians never underwent interruption,—no foreign nation having come in to change them and make them young again. That childlike state of mind and heart, which in other Latin races, as well as in the Germanic, was such a deep source of poetic inspiration, was almost utterly wanting in the Italians, who were always much drawn to history and very little to nature; so, while legends, tales, epic poems, satires, were appearing and spreading on all sides, Italy was either quite a stranger to this movement or took a peculiar part in it. We know, for example, what the Trojan traditions were in the middle ages; and we should have thought that in Italy—in the country of Rome, retaining the memory of Aeneas and Virgil—they would have been specially developed, for it was from Virgil that the medieval sympathy for the conquered of Troy was derived. In fact, however, it was not so. A strange book made its appearance in Europe, no one quite knows when, the *Historia de excidio Trojae*, which purported to have been written by a certain Dares the Phrygian, an eye-witness of the Trojan war. In the middle ages this book was the basis of many literary labours. Benoit de Sainte-More composed an interminable French poem founded on it, which afterwards in its turn became a source for other poets to draw from, such as Herbert of Fritzlars and Conrad of Würzburg. Now for the curious phenomenon displayed by Italy. Whilst Benoit de Sainte-More wrote his poem in French, taking his material from a Latin history, whilst the two German writers, from a French source, made an almost original work in their own language—an Italian, on the other hand, taking Benoit for his model, composed in Latin the *Historia destructionis Trojae*; and this Italian was Guido delle Colonne of Messina, one of the vernacular poets of the Sicilian school, who must accordingly have known well how to use his own language. Guido was an imitator of the Provençals; he understood French, and yet wrote his own book in Latin, nay, changed the romance of the Troubadour into serious history. Much the same thing occurred with the other great legends. That of Alexander the Great (*g.r.*) gave rise to many French, German and Spanish poems,—in Italy,

only to the Latin distichs of Qualicchio of Arezzo. The whole of Europe was full of the legend of Arthur (*g.n.*). The Italians contented themselves with translating and with abridging the French romances, without adding anything of their own. The Italian writer could neither appropriate the legend nor colour it with his own tints. Even religious legend, so widely spread in the middle ages, and springing up so naturally as it did from the heart of that society, only put out a few roots in Italy. Jacopo di Voragine, while collecting his lives of the saints, remained only an historian, a man of learning, almost a critic who seemed doubtful about the things he related. Italy had none of those books in which the middle age, whether in its ascetic or its chivalrous character, is so strangely depicted. The intellectual life of Italy showed itself in an altogether special, positive, almost scientific, form, in the study of Roman law, in the chronicles of Farfa, of Marsicano and of many others, in translations from Aristotle, in the precepts of the school of Salerno, in the travels of Marco Polo—in short, in a long series of facts which seem to detach themselves from the surroundings of the middle age, and to be united on the one side with classical Rome and on the other with the Renaissance.

The necessary consequence of all this was that the Latin language was most tenacious in Italy, and that the elaboration of the new vulgar tongue was very slow,—being in fact preceded by two periods of Italian literature in foreign Provençal and French preparatory periods. languages. That is to say, there were many Italians who wrote Provençal poems, such as the Marchese Alberto Malaspina (12th century), Maestro Ferrari of Ferrara, Cigala of Genoa, Zorzi of Venice, Sordello of Mantua, Buvarello of Bologna, Nicoletto of Turin and others, who sang of love and of war, who haunted the courts, or lived in the midst of the people, accustoming them to new sounds and new harmonies. At the same time there was other poetry of an epic kind, written in a mixed language, of which French was the basis, but in which forms and words belonging to the Italian dialects were continually mingling. We find in it hybrid words exhibiting a treatment of sounds according to the rules of both languages,—French words with Italian terminations, a system of vocalization within the words approaching the Italo-Latin usage,—in short, something belonging at once to both tongues, as it were an attempt at interpenetration, at fusion. Such were the *Chansons de Geste*, *Macaire*, the *Entrée en Espagne* written by Niccola of Padua, the *Prise de Pampelune* and some others. All this preceded the appearance of a purely Italian literature.

In the Franco-Italian poems there was, as it were, a clashing, a struggle between the two languages, the French, however, gaining the upper hand. This supremacy became gradually less and less. As the struggle continued Dialect. between French and Italian, the former by degrees lost as much as the latter gained. The hybridism recurred, but it no longer predominated. In the *Bovo d'Antona* and the *Rainardo e Lesengrimo* the Venetian dialect makes itself clearly felt, although the language is influenced by French forms. Thus these writings, which G. I. Ascoli has called "miste" (mixed), immediately preceded the appearance of purely Italian works.

It is now an established historical fact that there existed no writing in Italian before the 13th century. It was in the course of that century, and especially from 1250 onwards, that the new literature largely unfolded and developed North Italy. itself. This development was simultaneous in the whole peninsula, only there was a difference in the subject-matter of the art. In the north, the poems of Giacomino di Verona and Bonvecchio di Riva were specially religious, and were intended to be recited to the people. They were written in a dialect partaking of the Milanese and the Venetian; and in their style they strongly bore the mark of the influence of French narrative poetry. They may be considered as belonging to the popular kind of poetry, taking the word, however, in a broad sense. Perhaps this sort of composition was encouraged by the old custom in the north of Italy<sup>2</sup> of listening in the piazzas and on the highways to the songs of the jongleurs. To the very same crowds who had been delighted with the stories of romance,

<sup>1</sup>See Giesebrecht, *De litterarum studiis apud Italos primis mediæ ævi sæculis* (Berlin, 1845.)

and who had listened to the story of the wickedness of *Macaire* and the misfortunes of *Blancifor*, another jongleur would sing of the terrors of the *Babilonia Infernale* and the blessedness of the *Gerusalemme celeste*, and the singers of religious poetry vied with those of the *Chansons de Geste*.

In the south of Italy, on the other hand, the love-song prevailed, of which we have an interesting specimen in the *Contrasto* attributed to Ciullo d'Alcamo, about which modern Italian critics have much exercised themselves. This "contrasto" (dispute) between a man and a woman in Sicilian dialect certainly must not be considered as the most ancient or as the only southern poem of a popular kind. It belongs without doubt to the time of the emperor Frederick II., and is important as a proof that there existed a popular poetry independent of literary poetry. The *Contrasto* of Ciullo d'Alcamo is the most remarkable relic of a kind of poetry that has perished or which perhaps was smothered by the ancient Sicilian literature. Its distinguishing point was its possessing all the opposite qualities to the poetry of the rhymers of what we shall call the Sicilian school. Vigorous in the expression of feelings, it seems to come from a real sentiment. The conceits, which are sometimes most bold and very coarse, show that it proceeded from the lowest grades of society. Everything is original in Ciullo's *Contrasto*. Conventionalism has no place in it. It is marked by the sensuality characteristic of the people of the South.

The reverse of all this happened in the Siculo-Provençal school, at the head of which was Frederick II. Imitation was the fundamental characteristic of this school, to which belonged Enzo, king of Sardinia, Pier delle Vigne, Inghilfredi, Guido and Odo delle Colonne, Jacopo d'Aquino, Rugieri Pugliese, Giacomo da Lentino, Arrigo Testa and others. These rhymers never moved a step beyond the ideas of chivalry; they had no originality; they did not sing of what they felt in their heart; they abhorred the true and the real. They only aimed at copying as closely as they could the poetry of the Provençal troubadours.<sup>1</sup> The art of the Siculo-Provençal school was born decrepit, and there were many reasons for this—first, because the chivalrous spirit, from which the poetry of the troubadours was derived, was now old and on its death-bed; next, because the Provençal art itself, which the Sicilians took as their model, was in its decadence. It may seem strange, but it is true, that when the emperor Frederick II., a philosopher, a statesman, a very original legislator, took to writing poetry, he could only copy and amuse himself with absolute puerilities. His art, like that of all the other poets of his court, was wholly conventional, mechanical, affected. It was completely wanting in what constitutes poetry—ideality, feeling, sentiment, inspiration. The Italians have had great disputes among themselves about the original form of the poems of the Sicilian school, that is to say, whether they were written in Sicilian dialect, or in that language which Dante called "volgare illustre, aulico, cortigiano." But the critics of most authority hold that the primitive form of these poems was the Sicilian dialect, modified for literary purposes with the help of Provençal and Latin; the theory of the "lingua illustre" has been almost entirely rejected, since we cannot say on what rules it could have been founded, when literature was in its infancy, trying its feet, and lisping its first words. The Sicilian certainly, in accordance with a tendency common to all dialects, in passing from the spoken to the written form, must have gained in dignity; but this was not enough to create the so-called "lingua illustre," which was upheld by Peticari and others on grounds rather political than literary.

In the 13th century a mighty religious movement took place in Italy, of which the rise of the two great orders of Saint Francis and Saint Dominic was at once the cause and the effect. Around Francis of Assisi a legend has grown up in which naturally the imaginative element prevails. Yet from some points in it we seem to be able to infer that its hero had a strong feeling for nature, and a heart open

to the most lively impressions. Many poems are attributed to him. The legend relates that in the eighteenth year of his penance, when almost rapt in ecstasy, he dictated the *Cantico del Sole*. Even if this hymn be really his, it cannot be considered as a poetical work, being written in a kind of prose simply marked by assonances. As for the other poems, which for a long time were believed to be by Saint Francis, their spuriousness is now generally recognized. The true poet who represented in all its strength and breadth the religious feeling that had made special progress in Umbria was Jacopo dei Benedetti di Todi, known as Jacopone. The story is that sorrow at the sudden death of his wife had disordered his mind, and that, having sold all he possessed and given it to the poor, he covered himself with rags, and took pleasure in being laughed at, and followed by a crowd of people who mocked him and called after him "Jacopone, Jacopone." We do not know whether this be true. What we do know is that a vehement passion must have stirred his heart and maintained a despotic hold over him, the passion of divine love. Under its influence Jacopone went on raving for years and years, subjecting himself to the severest sufferings, and giving vent to his religious intoxication in his poems. There is no art in him, there is not the slightest indication of deliberate effort; there is only feeling, a feeling that absorbed him, fascinated him, penetrated him through and through. His poetry was all inside him, and burst out, not so much in words as in sighs, in groans, in cries that often seem really to come from a monomaniac. But Jacopone was a mystic, who from his hermit's cell looked out into the world and specially watched the papacy, scourging with his words Celestine V. and Boniface VIII. He was put in prison and laden with chains, but his spirit lifted itself up to God, and that was enough for him. The same feeling that prompted him to pour out in song ecstasies of divine love, and to despise and trample on himself, moved him to reprove those who forsook the heavenly road, whether they were popes, prelates or monks. In Jacopone there was a strong originality, and in the period of the origins of Italian literature he was one of the most characteristic writers.

The religious movement in Umbria was followed by another literary phenomenon, that of the religious drama. In 1258 an old hermit, Raniero Fasani, leaving the cavern in which he had lived for many years, suddenly appeared at Perugia. These were very sad times for Italy. The quarrels in the cities, the factions of the Ghibellines and the Guelphs, the interdicts and excommunications issued by the popes, the reprisals of the imperial party, the cruelty and tyranny of the nobles, the plagues and famines, kept the people in constant agitation, and spread abroad mysterious fears. The commotion was increased in Perugia by Fasani, who represented himself as sent by God to disclose mysterious visions, and to announce to the world terrible visitations. Under the influence of fear there were formed "Compagnie di Disciplinanti," who, for a penance, scourged themselves till they drew blood, and sang "Laudi" in dialogue in their confraternities. These "Laudi" closely connected with the liturgy, were the first example of the drama in the vulgar tongue of Italy. They were written in the Umbrian dialect, in verses of eight syllables, and of course they have not any artistic value. Their development, however, was rapid. As early as the end of the same 13th century we have the *Devozioni del Giovedì e Venerdì Santo*, which have some dramatic elements in them, though they are still connected with the liturgical office. Then we have the representation of *un Monaco che andò al servizio di Dio* ("of a monk who entered the service of God"), in which there is already an approach to the definite form which this kind of literary work assumed in the following centuries.

In the 13th century Tuscany was peculiarly circumstanced both as regards its literary condition and its political life. The Tuscans spoke a dialect which most closely resembled the mother-tongue, Latin—one which afterwards became almost exclusively the language of literature, and which was already regarded at the end of the 13th century as surpassing the others; "Lingua Tusca magis apta est ad

<sup>1</sup> See Gaspary, *Die sicilianische Dichterschule des 13ten Jahrhunderts* (Berlin, 1878).

literam sive literaturam": thus writes Antonio da Tempo of Padua, born about 1275. Being very little or not at all affected by the Germanic invasion, Tuscany was never subjected to the feudal system. It had fierce internal struggles, but they did not weaken its life; on the contrary, they rather gave it fresh vigour and strengthened it, and (especially after the final fall of the Hohenstaufens at the battle of Benevento in 1266) made it the first province of Italy. From 1266 onwards Florence was in a position to begin that movement of political reform which in 1282 resulted in the appointment of the Priori delle Arti, and the establishment of the Arti Minori. This was afterwards copied by Siena with the Magistrato dei Nove, by Lucca, by Pistoia, and by other Guelph cities in Tuscany with similar popular institutions. In this way the guilds had taken the government into their hands, and it was a time of both social and political prosperity. It was no wonder that literature also rose to an unlooked-for height. In Tuscany, too, there was some popular love poetry; there was a school of imitators of the Sicilians, their chief being Dante of Majano; but its literary originality took another line—that of humorous and satirical poetry. The entirely democratic form of government created a style of poetry which stood in the strongest antithesis to the medieval mystic and chivalrous style. Devout invocation of God or of a lady came from the cloister and the castle; in the streets of the cities everything that had gone before was treated with ridicule or biting sarcasm. Folgore of San Gimignano laughs when in his sonnets he tells a party of Siennese youths what are the occupations of every month in the year, or when he teaches a party of Florentine lads the pleasures of every day in the week. Cene della Chitarrà laughs when he parodies Folgore's sonnets. The sonnets of Rustico di Filippo are half fun and half satire; laughing and crying, joking and satire, are all to be found in Cecco Angiolieri of Siena, the oldest "humorist" we know, a far-off precursor of Rabelais, of Montaigne, of Jean Paul Richter, of Sydney Smith. But another kind of poetry also began in Tuscany. Guittone d'Arezzo made art quit chivalrous for national motives, Provençal forms for Latin. He attempted political poetry, and, although his work is full of the strangest obscurities, he prepared the way for the Bolognese school. In the 13th century Bologna was the city of science, and philosophical poetry appeared there. Guido Guinicelli was the poet after the new fashion of the art. In him the ideas of chivalry are changed and enlarged; he sings of love and, together with it, of the nobility of the mind. The reigning thought in Guinicelli's *Canzoni* is nothing external to his own subjectivity. His speculative mind, accustomed to wandering in the field of philosophy, transfuses its lucubrations into his art. Guinicelli's poetry has some of the faults of the school of Guittone d'Arezzo: he reasons too much; he is wanting in imagination; his poetry is a product of the intellect rather than of the fancy and the heart. Nevertheless he marks a great development in the history of Italian art, especially because of his close connexion with Dante's lyric poetry.

But before we come to Dante, certain other facts, not, however, unconnected with his history, must be noticed. In the 13th century, there were several poems in the allegorical style. One of these is by Brunetto Latini, who, it is well known, was attached by ties of strong affection to Alighieri. His *Tesoretto* is a short poem, in seven-syllable verses, rhyming in couplets, in which the author professes to be lost in a wilderness and to meet with a lady, who is Nature, from whom he receives much instruction. We see here the vision, the allegory, the instruction with a moral object—three elements which we shall find again in the *Divina Commedia*. Francesco da Barberino, a learned lawyer who was secretary to bishops, a judge, a notary, wrote two little allegorical poems—the *Documenti d'amore* and *Del reggimento e dei costumi delle donne*. Like the *Tesoretto*, these poems are of no value as works of art, but are, on the other hand, of importance in the history of manners. A fourth allegorical work was the *Intelligenza*, by some attributed to Dino Compagni, but probably not his, and only a version of French poems.

While the production of Italian poetry in the 13th century was abundant and varied, that of prose was scanty. The oldest specimen dates from 1231, and consists of short notices of entries and expenses by Mattasala di Spinello dei Lambertini of Siena. In 1253 and 1260 there are some commercial letters of other Siennese. But there is no sign of literary prose. Before we come to any, we meet with a phenomenon like that we noticed in regard to poetry. Here again we find a period of Italian literature in French. Halfway on in the century a certain Aldobrando or Aldobrandino (it is not known whether he was of Florence or of Siena) wrote a book for Beatrice of Savoy, countess of Provence, called *Le Règime du corps*. In 1267 Martino da Canale wrote in the same "langue d'oil" a chronicle of Venice. Rusticiano of Pisa, who was for a long while at the court of Edward I. of England, composed many chivalrous romances, derived from the Arthurian cycle, and subsequently wrote the travels of Marco Polo, which may perhaps have been dictated by the great traveller himself. And finally Brunetto Latini wrote his *Tesoro* in French.

Next in order to the original compositions in the langue d'oil come the translations or adaptations from the same. There are some moral narratives taken from religious legends; a romance of Julius Caesar; some short histories of ancient knights; the *Tavola rotonda*; translations of the *Viaggi* of Marco Polo and of the *Tesoro* of Latini. At the same time there appeared translations from Latin of moral and ascetic works, of histories and of treatises on rhetoric and oratory. Up to very recent times it was still possible to reckon as the most ancient works in Italian prose the *Cronaca* of Matteo Spinello da Giovenazzo, and the *Cronaca* of Ricordano Malespini. But now both of them have been shown to be forgeries of a much later time. Therefore the oldest prose writing is a scientific book—the *Composizione del mondo* by Ristoro d'Arezzo, who lived about the middle of the 13th century. This work is a copious treatise on astronomy and geography. Ristoro was superior to the other writers of the time on these subjects, because he seems to have been a careful observer of natural phenomena, and consequently many of the things he relates were the result of his personal investigations. There is also another short treatise, *De regimine rectoris*, by Fra Paolino, a Minorite friar of Venice, who was probably bishop of Pozzuoli, and who also wrote a Latin chronicle. His treatise stands in close relation to that of Egidio Colonna, *De regimine principum*. It is written in the Venetian dialect.

The 13th century was very rich in tales. There is a collection called the *Cento Novelle antiche*, which contains stories drawn from Oriental, Greek and Trojan traditions, from ancient and medieval history, from the legends of Brittany, Provence and Italy, and from the Bible, from the local tradition of Italy as well as from histories of animals and old mythology. This book has a distant resemblance to the Spanish collection known as *El Conde Lucanor*. The peculiarity of the Italian book is that the stories are very short, and that they seem to be mere outlines to be filled in by the narrator as he goes along. Other prose novels were inserted by Francesco Barberino in his work *Del reggimento e dei costumi delle donne*, but they are of much less importance than the others. On the whole the Italian novels of the 13th century have little originality, and are only a faint reflection of the very rich legendary literature of France. Some attention should be paid to the *Lettere* of Fra Guittone d'Arezzo, who wrote many poems and also some letters in prose, the subjects of which are moral and religious. Love of antiquity, of the traditions of Rome and of its language, was so strong in Guittone that he tried to write Italian in a Latin style, and it turned out obscure, involved and altogether barbarous. He took as his special model Seneca, and hence his prose assumed a bombastic style, which, according to his views, was very artistic, but which in fact was alien to the true spirit of art, and resulted in the extravagant and grotesque.

2. *The Spontaneous Development of Italian Literature.*—In the year 1282, the year in which the new Florentine constitution

of the "Arti minori" was completed, a period of literature began that does not belong to the age of first beginnings, but to that of development. With the school of Lapo Gianni, of Guido Cavalcanti, of Cino da Pistoia and Dante Alighieri, lyric poetry became exclusively Tuscan. The whole novelty and poetic power of this school, which really was the beginning of Italian art, consist in what Dante expresses so happily—

"Quando  
Amore spira, noto, ed a quel modo  
Ch'ei detta dentro, vo significando"—

that is to say, in a power of expressing the feelings of the soul in the way in which love inspires them, in an appropriate and graceful manner, fitting form to matter, and by art fusing one with the other. The Tuscan lyric poetry, the first true Italian art, is pre-eminent in this artistic fusion, in the spontaneous and at the same time deliberate action of the mind. In Lapo Gianni the new style is not free from some admixture of the old associations of the Siculo-Provençal school. He wavered as it were between two manners. The empty and involved phraseology of the Sicilians is absent, but the poet does not always rid himself of their influence. Sometimes, however, he draws freely from his own heart, and then the subtleties and obscurities disappear, and his verse becomes clear, flowing and elegant.

Guido Cavalcanti was a learned man with a high conception of his art. He felt the value of it, and adapted his learning to it. Cavalcanti was already a good deal out of sympathy with the medieval spirit; he reflected deeply on his own work, and from this reflection he derived his poetical conception. His poems may be divided into two classes—those which portray the philosopher, "il sottilissimo dialettico," as Lorenzo the Magnificent called him, and those which are more directly the product of his poetic nature imbued with mysticism and metaphysics. To the first set belongs the famous poem *Sulla natura d'amore*, which in fact is a treatise on amorous metaphysics, and was annotated later in a learned way by the most renowned Platonic philosophers of the 15th century, such as Marsilius Ficinus and others. In other poems of Cavalcanti's besides this we see a tendency to subtilize and to stifle the poetic imagery under a dead weight of philosophy. But there are many of his sonnets in which the truth of the images and the elegance and simplicity of the style are admirable, and make us feel that we are in quite a new period of art. This is particularly felt in Cavalcanti's *Ballate*, for in them he pours himself out ingeniously and without affectation, but with an invariable and profound consciousness of his art. Far above all the others for the reality of the sorrow and the love displayed, for the melancholy longing expressed for the distant home, for the calm and solemn yearning of his heart for the lady of his love, for a deep subjectivity which is never troubled by metaphysical subtleties, is the ballata composed by Cavalcanti when he was banished from Florence with the party of the Bianchi in 1300, and took refuge at Sarzana.

The third poet among the followers of the new school was Cino da Pistoia, of the family of the Sinibuldi. His love poems are so sweet, so mellow and so musical that they are only surpassed by Dante. The pains of love are described by him with vigorous touches; it is easy to see that they are not feigned but real. The psychology of love and of sorrow nearly reaches perfection.

As the author of the *Vita nuova*, the greatest of all Italian poems, Dante also belongs to the same lyric school. In the lyrics

of the *Vita nuova* (so called by its author to indicate that his first meeting with Beatrice was the beginning for him of a life entirely different from that he had hitherto led) there is a high idealization of love. It seems as if there were in it nothing earthly or human, and that the poet had his eyes constantly fixed on heaven while singing of his lady. Everything is supersensual, aerial, heavenly, and the real Beatrice is always gradually melting more and more into the symbolical one—passing out of her human nature and into the divine. Several of the lyrics of the *Canzoniere* deal with the

theme of the "new life"; but all the love poems do not refer to Beatrice, while other pieces are philosophical and bridge over to the *Convito*.

The work which made Dante immortal, and raised him above all other men of genius in Italy, was his *Divina Commedia*. An allegorical meaning is hidden under the literal one of this great epic. Dante travelling through Hell, Purgatory and Paradise, is a symbol of mankind aiming at the double object of temporal and eternal happiness. By the forest in which the poet loses himself is meant the civil and religious confusion of society, deprived of its two guides, the emperor and the pope. The mountain illuminated by the sun is universal monarchy. The three beasts are the three vices and the three powers which offered the greatest obstacles to Dante's designs: envy is Florence, light, fickle and divided by the Bianchi and Neri; pride is the house of France; avarice is the papal court; Virgil represents reason and the empire. Beatrice is the symbol of the supernatural aid without which man cannot attain the supreme end, which is God.

But the merit of the poem does not lie in the allegory, which still connects it with medieval literature. What is new in it is the individual art of the poet, the classic art transfused for the first time into a Romance form. Dante is above all a great artist. Whether he describes nature, analyses passions, curses the vices or sings hymns to the virtues, he is always wonderful for the grandeur and delicacy of his art. Out of the rude medieval vision he has made the greatest work of art of modern times. He took the materials for his poem from theology, from philosophy, from history, from mythology—but more especially from his own passions, from hatred and love; and he has breathed the breath of genius into all these materials. Under the pen of the poet, the dead come to life again; they become men again, and speak the language of their time, of their passions. Farinata degli Uberti, Boniface VIII., Count Ugolino, Manfred, Sordello, Hugh Capet, St Thomas Aquinas, Cacciaguida, St Benedict, St Peter, are all so many objective creations; they stand before us in all the life of their characters, their feelings, their habits.

Yet this world of fancy in which the poet moves is not only made living by the power of his genius, but it is changed by his consciousness. The real chastizer of the sins, the rewarder of the virtues, is Dante himself. The personal interest which he brings to bear on the historical representation of the three worlds is what most interests us and stirs us. Dante remakes history after his own passions. Thus the *Divina Commedia* can fairly be called, not only the most life-like drama of the thoughts and feelings that moved men at that time, but also the most clear and spontaneous reflection of the individual feelings of the poet, from the indignation of the citizen and the exile to the faith of the believer and the ardour of the philosopher. The *Divina Commedia* fixed and clearly defined the destiny of Italian literature, to give artistic lustre, and hence immortality, to all the forms of literature which the middle ages had produced. Dante begins the great era of the Renaissance.

Two facts characterize the literary life of Petrarch—classical research and the new human feeling introduced into his lyric poetry. Nor are these two facts separate; rather is the one the result of the other. The Petrarch who travelled about unearthing the works of the great Latin writers helps us to understand the Petrarch who, having completely detached himself from the middle ages, loved a real lady with a human love, and celebrated her in her life and after her death in poems full of studied elegance. Petrarch was the first humanist, and he was at the same time the first lyric poet of the modern school. His career was long and tempestuous. He lived for many years at Avignon, cursing the corruption of the papal court; he travelled through nearly the whole of Europe; he corresponded with emperors and popes; he was considered the first man of letters of his time; he had honours and riches; and he always bore about within him discontent, melancholy and incapacity for satisfaction—three characteristics of the modern man.

His *Canzoniere* is divided into three parts—the first containing

Cino da Pistoia.

Dante (1265-1321).

Petrarch (1304-1374).

the poems written during Laura's lifetime, the second the poems written after her death, the third the *Trionfi*. The one and only subject of these poems is love; but the treatment is full of variety in conception, in imagery and in sentiment, derived from the most varied impressions of nature. Petrarch's love is real and deep, and to this is due the merit of his lyric verse, which is quite different, not only from that of the Provençal troubadours and of the Italian poets before him, but also from the lyrics of Dante. Petrarch is a psychological poet, who dives down into his own soul, examines all his feelings, and knows how to render them with an art of exquisite sweetness. The lyrics of Petrarch are no longer transcendental like Dante's, but on the contrary keep entirely within human limits. In struggles, in doubts, in fears, in disappointments, in griefs, in joys, in fact in everything, the poet finds material for his poetry. The second part of the *Canzoniere* is the more passionate. The *Trionfi* are inferior; it is clear that in them Petrarch tried to imitate the *Divina Commedia*, but never came near it. The *Canzoniere* includes also a few political poems—a canzone to Italy, one supposed to be addressed to Cola di Rienzi and several sonnets against the court of Avignon. These are remarkable for their vigour of feeling, and also for showing that Petrarch had formed the idea of *Italianità* better even than Alighieri. The Italy which he wooed was different from any conceived by the men of the middle ages, and in this also he was a precursor of modern times and of modern aspirations. Petrarch had no decided political idea. He exalted Cola di Rienzi, invoked the emperor Charles IV., praised the Visconti; in fact, his politics were affected more by impressions than by principles; but above all this reigned constantly the love of Italy, his ancient and glorious country, which in his mind is reunited with Rome, the great city of his heroes Cicero and Scipio.

Boccaccio had the same enthusiastic love of antiquity and the same worship for the new Italian literature as Petrarch. He was the first, with the help of a Greek born in Calabria, to put together a Latin translation of the *Iliad* and the *Odyssey*. His vast classical learning was shown specially in the work *De genealogia deorum*, in which he enumerates the gods according to genealogical trees constructed on the authority of the various authors who wrote about the pagan divinities. This work marked an era in studies preparatory to the revival of classical learning. And at the same time it opened the way for the modern criticism, because Boccaccio in his researches, and in his own judgment was always independent of the authors whom he most esteemed. The *Genealogia deorum* is, as A. H. Heeren said, an encyclopaedia of mythological knowledge; and it was the precursor of the great humanistic movement which was developed in the 15th century. Boccaccio was also the first historian of women in his *De claris mulieribus*, and the first to undertake to tell the story of the great unfortunate in his *De casibus virorum illustrium*. He continued and perfected former geographical investigations in his interesting book *De montibus, silvis, fontibus, lacubus, fluminibus, stagnis, et paludibus, et de nominibus maris*, for which he made use of Vibius Sequester, but which contains also many new and valuable observations. Of his Italian works his lyrics do not come anywhere near to the perfection of Petrarch's. His sonnets, mostly about love, are quite mediocre. His narrative poetry is better. Although now he can no longer claim the distinction long conceded to him of having invented the octave stanza (which afterwards became the metre of the poems of Boiardo, of Ariosto and of Tasso), yet he was certainly the first to use it in a work of some length and written with artistic skill, such as is his *Teseide*, the oldest Italian romantic poem. The *Filosttrato* relates the loves of Troilo and Griseida (Troilus and Cressida). It may be that Boccaccio knew the French poem of the Trojan war by Benoît de Sainte-More; but the interest of the Italian works lies in the analysis of the passion of love, which is treated with a masterly hand. The *Ninfaie fiesolano* tells the love story of the nymph Mesola and the shepherd Africo. The *Amoreosa Visione*, a poem in triplets, doubtless owed its origin to the

*Divina Commedia*. The *Amelo* is a mixture of prose and poetry, and is the first Italian pastoral romance.

The *Filocolo* takes the earliest place among prose romances. In it Boccaccio tells in a laborious style, and in the most prolix way, the loves of Florio and Biancofiore. Probably for this work he drew materials from a popular source or from a Byzantine romance, which Leonzio Pilato may have mentioned to him. In the *Filocolo* there is a remarkable exuberance in the mythological part, which damages the romance as an artistic work, but which contributes to the history of Boccaccio's mind. The *Fiammetta* is another romance, about the loves of Boccaccio and Maria d'Aquino, a supposed natural daughter of King Robert, whom he always called by this name of Fiammetta.

The Italian work which principally made Boccaccio famous was the *Decamerone*, a collection of a hundred novels, related by a party of men and women, who had retired to a villa near Florence to escape from the plague in 1348. Novel-writing, so abundant in the preceding centuries, especially in France, now for the first time assumed an artistic shape. The style of Boccaccio tends to the imitation of Latin, but in him prose first took the form of elaborated art. The rudeness of the old *fabliaux* gives place to the careful and conscientious work of a mind that has a feeling for what is beautiful, that has studied the classic authors, and that strives to imitate them as much as possible. Over and above this, in the *Decamerone*, Boccaccio is a delineator of character and an observer of passions. In this lies his novelty. Much has been written about the sources of the novels of the *Decamerone*. Probably Boccaccio made use both of written and of oral sources. Popular tradition must have furnished him with the materials of many stories, as, for example, that of Griselda.

Unlike Petrarch, who was always discontented, preoccupied, wearied with life, disturbed by disappointments, we find Boccaccio calm, serene, satisfied with himself and with his surroundings. Notwithstanding these fundamental differences in their characters, the two great authors were old and warm friends. But their affection for Dante was not equal. Petrarch, who says that he saw him once in his childhood, did not preserve a pleasant recollection of him, and it would be useless to deny that he was jealous of his renown. The *Divina Commedia* was sent him by Boccaccio, when he was an old man, and he confessed that he never read it. On the other hand, Boccaccio felt for Dante something more than love—enthusiasm. He wrote a biography of him, of which the accuracy is now unfairly depreciated by some critics, and he gave public critical lectures on the poem in Santa Maria del Fiore at Florence.

Fazio degli Uberti and Federigo Frezzi were imitators of the *Divina Commedia*, but only in its external form. The former wrote the *Dittamondo*, a long poem, in which the author supposes that he was taken by the geographer <sup>Imitators of the</sup> Solinus into different parts of the world, and that his *Commedia* guide related the history of them. The legends of the rise of the different Italian cities have some importance historically. Frezzi, bishop of his native town Foligno, wrote the *Quadrifoglio*, a poem of the four kingdoms—Love, Satan, the Vices and the Virtues. This poem has many points of resemblance with the *Divina Commedia*. Frezzi pictures the condition of man who rises from a state of vice to one of virtue, and describes hell, the limbo, purgatory and heaven. The poet has Pallas for a companion.

Ser Giovanni Fiorentino wrote, under the title of *Pecorone*, a collection of tales, which are supposed to have been related by a monk and a nun in the parlour of the monastery <sup>Novelists</sup> of Forlì. He closely imitated Boccaccio, and drew on Villani's chronicle for his historical stories. Franco Sacchetti wrote tales too, for the most part on subjects taken from Florentine history. His book gives a life-like picture of Florentine society at the end of the 14th century. The subjects are almost always improper; but it is evident that Sacchetti collected all these anecdotes in order to draw from them his own conclusions and moral reflections, which are to be found at the end of every story. From this point of view Sacchetti's work comes near to



the *Monalisiones* of the middle ages. A third novelist was Giovanni Sercambi of Lucca, who after 1374 wrote a book, in imitation of Boccaccio, about a party of people who were supposed to fly from a plague and to go travelling about in different Italian cities, stopping here and there telling stories. Later, but important, names are those of Massuccio Salernitano (Tommaso Guardato), who wrote the *Novellino*, and Antonio Cornazzano whose *Proverbi* became extremely popular.

It has already been said that the Chronicles formerly believed to have been of the 13th century are now regarded as forgeries of later times. At the end of the 13th century, however, we find a *chronicle* by Dino Compagni, which, notwithstanding the unfavourable opinion of it entertained especially by some German writers, is in all probability authentic. Little is known about the life of Compagni. Noble by birth, he was democratic in feeling, and was a supporter of the new ordinances of Giano della Bella. As prior and gonfalonier of justice he always had the public welfare at heart. When Charles of Valois, the nominee of Boniface VIII., was expected in Florence, Compagni, foreseeing the evils of civil discord, assembled a number of citizens in the church of San Giovanni, and tried to quiet their excited spirits. His chronicle relates the events that came under his own notice from 1280 to 1312. It bears the stamp of a strong subjectivity. The narrative is constantly personal. It often rises to the finest dramatic style. A strong patriotic feeling and an exalted desire for what is right pervade the book. Compagni is more an historian than a chronicler, because he looks for the reasons of events, and makes profound reflections on them. According to our judgment he is one of the most important authorities for that period of Florentine history, notwithstanding the not insignificant mistakes in fact which are to be found in his writings. On the contrary, Giovanni Villani, born in 1300, was more of a chronicler than an historian. He relates the events up to 1347. The journeys that he made in Italy and France, and the information thus acquired, account for the fact that his chronicle, called by him *Istorie fiorentine*, comprises events that occurred all over Europe. What specially distinguishes the work of Villani is that he speaks at length, not only of events in politics and war, but also of the stipends of public officials, of the sums of money used for paying soldiers and for public festivals, and of many other things of which the knowledge is very valuable. With such an abundance of information it is not to be wondered at that Villani's narrative is often encumbered with fables and errors, particularly when he speaks of things that happened before his own time. Matteo was the brother of Giovanni Villani, and continued the chronicle up to 1363. It was again continued by Filippo Villani. Gino Capponi, author of the *Commentari dell' acquisto di Pisa* and of the narration of the *Tumulto dei ciompi*, belonged to both the 14th and the 15th centuries.

The *Divina Commedia* is ascetic in its conception, and in a good many points of its execution. To a large extent similar is the genius of Petrarch; yet neither Petrarch nor Dante could be classified among the pure ascetics of their time. But many other writers come under this head. St Catherine of Siena's mysticism was political. She was a really extraordinary woman, who aspired to bring back the Church of Rome to evangelical virtue, and who has left a collection of letters written in a high and lofty tone to all kinds of people, including popes. She joins hands on the one side with Jacopone of Todi, on the other with Savonarola. Hers is the strongest, clearest, most exalted religious utterance that made itself heard in Italy in the 14th century. It is not to be thought that precise ideas of reformation entered into her head, but the want of a great moral reform was felt in her heart. And she spoke indeed *ex abundantia cordis*. Anyhow the daughter of Jacopo Benincasa must take her place among those who from afar off prepared the way for the religious movement which took effect, especially in Germany and England, in the 16th century.

Another Siense, Giovanni Colombini, founder of the order of Jesuati, preached poverty by precept and example, going back to the religious idea of St Francis of Assisi. His letters

are among the most remarkable in the category of ascetic works in the 14th century. Passavanti, in his *Specchio della vera penitenza*, attached instruction to narrative. Cavalca translated from the Latin the *Vite dei santi padri*. Rivalta left behind him many sermons, and Franco Sacchetti (the famous novelist) many discourses. On the whole, there is no doubt that one of the most important productions of the Italian spirit of the 14th century was the religious literature.

In direct antithesis with this is a kind of literature which has a strong popular element. Humorous poetry, the poetry of laughter and jest, which as we saw was largely developed in the 13th century, was carried on in the 14th by Bindo Bonichi, Arrigo di Castruccio, Cecco Nuccelli, Andrea Orgagna, Filippo de' Bardi, Adriano de' Rossi, Antonio Pucci and other lesser writers. Orgagna was specially comic; Bonichi was comic with a satirical and moral purpose. Antonio Pucci was superior to all of them for the variety of his production. He put into triplets the *chronicle* of Giovanni Villani (*Centiloquio*), and wrote many historical poems called *Serventese*, many comic poems, and not a few epic-popular compositions on various subjects. A little poem of his in seven cantos treats of the war between the Florentines and the Pisans from 1362 to 1365. Other poems drawn from a legendary source celebrate the *Reina d' Oriente*, *Apollonio di Tiro*, the *Bel Gherardino*, &c. These poems, meant to be recited to the people, are the remote ancestors of the romantic epic, which was developed in the 16th century, and the first representatives of which were Boiardo and Ariosto.

Many poets of the 14th century have left us political works. Of these Fazio degli Uberti, the author of *Dittamondo*, who wrote a *Serventese* to the lords and people of Italy, a poem on Rome, a fierce invective against Charles IV. of Luxemburg, deserves notice, and Francesco di Vannozzo, Frate Stoppa and Matteo Frescobaldi. It may be said in general that following the example of Petrarch many writers devoted themselves to patriotic poetry. From this period also dates that literary phenomenon known under the name of Petrarchism. The Petrarchists, or those who sang of love, imitating Petrarch's manner, were found already in the 14th century. But others treated the same subject with more originality, in a manner that might be called semi-popular. Such were the *Ballate* of Ser Giovanni Fiorentino, of Franco Sacchetti, of Niccolò Soldanieri, of Guido and Bindo Donati. Ballate were poems sung to dancing, and we have very many songs for music of the 14th century. We have already stated that Antonio Pucci versified Villani's *Chronicle*. This instance of versified history is not unique, and it is evidently connected with the precisely similar phenomenon offered by the "vulgar Latin" literature. It is enough to notice a *chronicle* of Arezzo in terza rima by Goro de' Sinigardi, and the history, also in terza rima, of the journey of Pope Alexander III. to Venice by Pier de' Natali. Besides this, every kind of subject, whether history, tragedy or husbandry, was treated in verse. Neri di Landocio wrote a life of St Catherine; Jacopo Gradenigo put the gospels into triplets; Paganino Bonafede in the *Tesoro dei rustici* gave many precepts in agriculture, beginning that kind of Georgic poetry which was fully developed later by Alamanni in his *Coltivazione*, by Girolamo Baruffaldi in the *Canapaio*, by Rucellai in the *Api*, by Bartolommeo Lorenzi in the *Coltivazione dei monti*, by Giambattista Spolverini in the *Coltivazione del riso*, &c.

There cannot have been an entire absence of dramatic literature in Italy in the 14th century, but traces of it are wanting, although we find them again in great abundance in the 15th century. The 14th century had, however, one drama unique of its kind. In the sixty years (1250 to 1310) which ran from the death of the emperor Frederick II. to the expedition of Henry VII., no emperor had come into Italy. In the north of Italy, Ezzelino da Romano, with the title of imperial vicar, had taken possession of almost the whole of the March of Treviso, and threatened Lombardy. The popes proclaimed a crusade against him, and, crushed by it, the Ezzelini fell. Padua then began to breathe again, and took to extending its dominion

The chronicles.

Comic poetry.

Political and satirical poetry.

Histories in verse.

Drama.

There was living at Padua Albertino Mussato, born in 1261, a year after the catastrophe of the Ezzelini; he grew up among the survivors of a generation that hated the name of the tyrant. After having written in Latin a history of Henry VII. he devoted himself to a dramatic work on Ezzelino, and wrote it also in Latin. The *Eccezzinus*, which was probably never represented on the stage, has been by some critics compared to the great tragic works of Greece. It would probably be nearer the truth to say that it has nothing in common with the works of Aeschylus; but certainly the dramatic strength, the delineation of certain situations, and the narration of certain events are very original. Mussato's work stands alone in the history of Italian dramatic literature. Perhaps this would not have been the case if he had written it in Italian.

In the last years of the 14th century we find the struggle that was soon to break out between the indigenous literary tradition and the reviving classicism already alive in spirit. As representatives of this struggle, of this antagonism, we may consider Luigi Marsilio and Coluccio Salutati, both learned men who spoke and wrote Latin, who aspired to be humanists, but who meanwhile also loved Dante, Petrarch and Boccaccio, and felt and celebrated in their writings the beauty of Italian literature.

3. *The Renaissance*.—A great intellectual movement, which had been gathering for a long time, made itself felt in Italy in the 15th century. A number of men arose, all learned, laborious, indefatigable, and all intent on one great work. Such were Niccolò Niccoli, Gianozzo Manetti, Palla Strozzi, Leonardo Bruni, Francesco Filelfo, Poggio Bracciolini, Carlo d'Alessandro, Lorenzo Valla. Manetti buried himself in his books, slept only for a few hours in the night, never went out of doors, and spent his time in translating from Greek, studying Hebrew, and commenting on Aristotle. Palla Strozzi sent into Greece at his own expense to search for ancient books, and had Plutarch and Plato brought for him. Poggio Bracciolini went to the Council of Constance, and found in a monastery in the dust-hole Cicero's *Orations*. He copied Quintilian with his own hand, discovered Lucretius, Plautus, Pliny and many other Latin authors. Guarino went through the East in search of codices. Giovanni Aurispa returned to Venice with many hundreds of manuscripts. What was the passion that excited all these men? What did they search after? What did they look to? These Italians were but handing on the solemn tradition which, although partly latent, was the informing principle of Italian medieval history, and now at length came out triumphant. This tradition was that same tenacious and sacred memory of Rome, that same worship of its language and institutions, which at one time had retarded the development of Italian literature, and now grafted the old Latin branch of ancient classicism on the flourishing stock of Italian literature. All this is but the continuation of a phenomenon that has existed for ages. It is the thought of Rome that always dominates Italians, the thought that keeps appearing from Boetius to Dante Alighieri, from Arnold of Brescia to Cola di Rienzi, which gathers strength with Petrarch and Boccaccio, and finally becomes triumphant in literature and life—in life, because the modern spirit is fed on the works of the ancients. Men come to have a more just idea of nature: the world is no longer cursed or despised; truth and beauty join hands; man is born again; and human reason resumes its rights. Everything, the individual and society, are changed under the influence of new facts.

First of all there was formed a human individuality, which was wanting in the middle ages. As J. Burckhardt has said, the man was changed into the individual. He began to feel and assert his own personality, which was constantly attaining a fuller realization. As a consequence of this, the idea of fame and the desire for it arose. A really cultured class was formed, in the modern meaning of the word, and the conception was arrived at (completely unknown in former times) that the worth of a man did not depend at all on his birth but on his personal qualities. Poggio in his dialogue *De nobilitate* declares that he entirely agreed with his inter-

locutors Niccolò Niccoli and Lorenzo de' Medici in the opinion that there is no other nobility but that of personal merit. External life was growing more refined in all particulars; the man of society was created; rules for civilized life were made; there was an increasing desire for sumptuous and artistic entertainments. The medieval idea of existence was turned upside down; men who had hitherto turned their thoughts exclusively to heavenly things, and believed exclusively in the divine right, now began to think of beautifying their earthly existence, of making it happy and gay, and returned to a belief in their human rights. This was a great advance, but one which carried with it the seeds of many dangers. The conception of morality became gradually weaker. The "fay ce que voudras" of Rabelais became the first principle of life. Religious feeling was blunted, was weakened, was changed, became pagan again. Finally the Italian of the Renaissance, in his qualities and his passions, became the most remarkable representative of the heights and depths, of the virtues and faults, of human life. Corruption was associated with all that is most ideal in life; a profound scepticism took hold of people's minds; indifference to good and evil reached its highest point.

Besides this, a great literary danger was hanging over Italy. Humanism threatened to submerge its youthful national literature. There were authors who laboriously tried to give Italian Latin forms, to do again, after Dante's time, what Guittone d'Arezzo had so unhappily done in the 13th century. Provincial dialects tried to reassert themselves in literature. The great authors of the 14th century, Dante, Petrarch, Boccaccio, were by many people forgotten or despised.

It was Florence that saved literature by reconciling the classical models to modern feeling, Florence that succeeded in assimilating classical forms to the "vulgar" art. Still gathering vigour and elegance from classicism, still drawing from the ancient fountains all that they could supply of good and useful, it was able to preserve its real life, to keep its national traditions, and to guide literature along the way that had been opened to it by the writers of the preceding century. At Florence the most celebrated humanists wrote also in the vulgar tongue, and commented on Dante and Petrarch, and defended them from their enemies. Leone Battista Alberti, the learned Greek and Latin scholar, wrote in the vernacular, and Vespasiano da Bisticci, whilst he was constantly absorbed in Greek and Latin manuscripts, wrote the *Vite di uomini illustri*, valuable for their historical contents, and rivaling the best works of the 14th century in their candour and simplicity. Andrea da Barberino wrote the beautiful prose of the *Reali di Francia*, giving a colouring of "romanticità" to the chivalrous romances. Belcari and Benivieni carry us back to the mystic idealism of earlier times.

But it is in Lorenzo de' Medici that the influence of Florence on the Renaissance is particularly seen. His mind was formed by the ancients: he attended the class of the Greek Argropylos, sat at Platonic banquets, took pains to collect codices, sculptures, vases, pictures, gems and drawings to ornament the gardens of San Marco and to form the library afterwards called by his name. In the saloons of his Florentine palace, in his villas at Careggi, Fiesole and Ambrà, stood the wonderful chests painted by Dello with stories from Ovid, the Hercules of Pollajuolo, the Pallas of Botticelli, the works of Filippino and Verrocchio. Lorenzo de' Medici lived entirely in the classical world; and yet if we read his poems we only see the man of his time, the admirer of Dante and of the old Tuscan poets, who takes inspiration from the popular muse, and who succeeds in giving to his poetry the colours of the most pronounced realism as well as of the loftiest idealism, who passes from the Platonic sonnet to the impassioned triplets of the *Amori di Venere*, from the grandiosity of the *Salve to Nencia* and to *Beoni*, from the *Canto carnascialesco* to the *Lauda*. The feeling of nature is strong in him—at one time sweet and melancholy, at another vigorous and deep, as if an echo of the feelings, the sorrows, the ambitions of that deeply agitated life. He

Gracco-  
Lazio  
learning.

Literary  
dangers  
of Latio-  
ism.

Influence  
of Flo-  
rence.

Lorenzo  
de' Medici.

New  
social  
conditions.

liked to look into his own heart with a severe eye, but he was also able to pour himself out with tumultuous fulness. He described with the art of a sculptor; he satirized, laughed, prayed, sighed, always elegant, always a Florentine, but a Florentine who read Anacreon, Ovid and Tibullus, who wished to enjoy life, but also to taste of the refinements of art.

Next to Lorenzo comes Poliziano, who also united, and with greater art, the ancient and the modern, the popular and the classical style. In his *Rispetti* and in his *Ballate* the freshness of imagery and the plasticity of form are inimitable. He, a great Greek scholar, wrote Italian verses with dazzling colours; the purest elegance of the Greek sources pervaded his art in all its varieties, in the *Orfeo* as well as the *Stanze per la giostra*.

As a consequence of the intellectual movement towards the Renaissance, there arose in Italy in the 15th century three academies, those of Florence, of Naples and of Rome. **The Accademia.** The Florentine academy was founded by Cosmo I. de' Medici. Having heard the praises of Platonic philosophy sung by Gemistus Pletho, who in 1439 was at the council of Florence, he took such a liking for those opinions that he soon made a plan for a literary congress which was especially to discuss them. Marsilius Ficinus has described the occupations and the entertainments of these academicians. Here, he said, the young men learnt, by way of pastime, precepts of conduct and the practice of eloquence; here grown-up men studied the government of the republic and the family; here the aged consoled themselves with the belief in a future world. The academy was divided into three classes: that of patrons, who were members of the Medici family; that of hearers, among whom sat the most famous men of that age, such as Pico della Mirandola, Angelo Poliziano, Leon Battista Alberti; that of disciples, who were youths anxious to distinguish themselves in philosophical pursuits. It is known that the Platonic academy endeavoured to promote, with regard to art, a second and a more exalted revival of antiquity. The Roman academy was founded by Giulio Pomponio Leto, with the object of promoting the discovery and the investigation of ancient monuments and books. It was a sort of religion of classicism, mixed with learning and philosophy. Platina, the celebrated author of the lives of the first hundred popes, belonged to it. At Naples, the academy known as the Pontaniana was instituted. The founder of it was Antonio Beccadelli, surnamed Il Panormita, and after his death the head was Il Pontano, who gave his name to it, and whose mind animated it.

Romantic poems were the product of the moral scepticism and the artistic taste of the 15th century. Italy never had any true epic poetry in its period of literary birth. Still less could it have any in the Renaissance. It had, however, many poems called *Canzari*, because they contained stories that were sung to the people; and besides there were romantic poems, such as the *Buovo d'Antona*, the *Regina Ancofoja* and others. But the first to introduce elegance and a new life into this style was Luigi Pulci, who grew up in the house of the Medici, and who wrote the *Morgante Maggiore* at the request of Lucrezia Tornabuoni, mother of Lorenzo the Magnificent. The material of the *Morgante* is almost completely taken from an obscure chivalrous poem of the 15th century recently discovered by Professor Pio Rajna. On this foundation Pulci erected a structure of his own, often turning the subject into ridicule, burlesquing the characters, introducing many digressions, now capricious, now scientific, now theological. Pulci's merit consists in having been the first to raise the romantic epic which had been for two centuries in the hands of story-tellers into a work of art, and in having united the serious and the comic, thus happily depicting the manners and feelings of the time. With a more serious intention Matteo Boiardo, count of Scandiano, wrote his *Orlando innamorato*, in which he seems to have aspired to embrace the whole range of Carolingian legends; but he did not complete his task. We find here too a large vein of humour and burlesque. Still the Ferrarese poet is drawn to the world of romance by a profound sympathy for chivalrous

manners and feelings—that is to say, for love, courtesy, valour and generosity. A third romantic poem of the 15th century was the *Mambriano* by Francesco Bello (Cieco of Ferrara). He drew from the Carolingian cycle, from the romances of the Round Table, from classical antiquity. He was a poet of no common genius, and of ready imagination. He showed the influence of Boiardo, especially in something of the fantastic which he introduced into his work.

The development of the drama in the 15th century was very great. This kind of semi-popular literature was born in Florence, and attached itself to certain popular festivities that were usually held in honour of St John the Baptist, patron saint of the city. The *Sacra Rappresentazione* is in substance nothing more than the development of the medieval *Mistero* ("mystery-play"). Although it belonged to popular poetry, some of its authors were literary men of much renown. It is enough to notice Lorenzo de' Medici, who wrote *San Giovanni e Paolo*, and Feo Belcari, author of the *San Panunzio*, the *Abramo ed Isaac*, &c. From the 15th century, some element of the comic-profanous found its way into the *Sacra Rappresentazione*. From its Biblical and legendary conventionalism Poliziano emancipated himself in his *Orfeo*, which, although in its exterior form belonging to the sacred representations, yet substantially detaches itself from them in its contents and in the artistic element introduced.

From Petrarca onwards the eclogue was a kind of literature that much pleased the Italians. In it, however, the pastoral element is only apparent, for there is nothing really rural in it. Such is the *Arcadia* of Jacopo Sannazzaro of Naples, author of a wearisome Latin poem *De Partu Virginis*, and of some piscatorial eclogues. The *Arcadia* is divided into ten eclogues, in which the festivities, the games, the sacrifices, the manners of a colony of shepherds are described. They are written in elegant verses, but it would be vain to look in them for the remotest feeling of country life. On the other hand, even in this style, Lorenzo de' Medici was superior. His *Nencia da Barberino*, as a modern writer says, is as it were the new and clear reproduction of the popular songs of the environs of Florence, melted into one majestic wave of octave stanzas. Lorenzo threw himself into the spirit of the bare realism of country life. There is a marked contrast between this work and the conventional bucolic of Sannazzaro and other writers. A rival of the Medici in this style, but always inferior to him, was Luigi Pulci in his *Beca da Dicomano*.

The lyric love poetry of this century was unimportant. In its stead we see a completely new style arise, the *Canto carnascialesco*. These were a kind of choral songs, which were accompanied with symbolical masquerades, common in Florence at the carnival. They were written in a metre like that of the ballate; and for the most part they were put into the mouth of a party of workmen and tradesmen, who, with not very chaste allusions, sang the praises of their art. These triumphs and masquerades were directed by Lorenzo himself. At eventide there set out into the city large companies on horseback, playing and singing these songs. There are some by Lorenzo himself, which surpass all the others in their mastery of art. That entitled *Bacco ed Arianna* is the most famous.

Girolamo Savonarola, who came to Florence in 1489, arose to fight against the literary and social movement of the Renaissance. Some have tried to make out that Savonarola was an apostle of liberty, others that he was a precursor of the Reformation. In truth, however, he was neither the one nor the other. In his struggle with Lorenzo de' Medici, he directed his attack against the promoter of classical studies, the patron of pagan literature, rather than against the political tyrant. Animated by mystic zeal, he took the line of a prophet, preaching against reading voluptuous authors, against the tyranny of the Medici, and calling for popular government. This, however, was not done from a desire for civil liberty, but because Savonarola saw in Lorenzo and his court the greatest obstacle to that return to Catholic doctrine which was his heart's

Drama.

Pastoral poetry.

Lyric poetry.

Religious reaction. Savonarola.

desire; while he thought this return would be easily accomplished if, on the fall of the Medici, the Florentine republic should come into the hands of his supporters. There may be more justice in looking on Savonarola as the forerunner of the Reformation. If he was so, it was more than he intended. The friar of Ferrara never thought of attacking the papal dogma, and always maintained that he wished to remain within the church of Rome. He had none of the great aspirations of Luther. He only repeated the complaints and the exhortations of St Catherine of Siena; he desired a reform of manners, entirely of manners, not of doctrine. He prepared the ground for the German and English religious movement of the 16th century, but unconsciously. In the history of Italian civilization he represents retrogression, that is to say, the cancelling of the great fact of the Renaissance, and return to medieval ideas. His attempt to put himself in opposition to his time, to arrest the course of events, to bring the people back to the faith of the past, the belief that all the social evils came from a Medici and a Borgia, his not seeing the historical reality, as it was, his aspiring to found a republic with Jesus Christ for its king—all these things show that Savonarola was more of a fanatic than a thinker. Nor has he any great merit as a writer. He wrote Italian sermons, hymns (*laudi*), ascetic and political treatises, but they are roughly executed, and only important as throwing light on the history of his ideas. The religious poems of Girolamo Benivieni are better than his, and are drawn from the same inspirations. In these lyrics, sometimes sweet, always warm with religious feeling, Benivieni and with him Feo Belcari carry us back to the literature of the 14th century.

History had neither many nor very good students in the 15th century. Its revival belonged to the following age. It was mostly written in Latin. Leonardo Bruni of *Historiae*, Arezzo wrote the history of Florence, Giovanni *etc.* Pontano that of Naples, in Latin. Bernardino Corio wrote the history of Milan in Italian, but in a rude way.

Leonardo da Vinci wrote a treatise on painting, Leon Battista Alberti one on sculpture and architecture. But the names of these two men are important, not so much as authors of these treatises, but as being embodiments of another characteristic of the age of the Renaissance—versatility of genius, power of application along many and varied lines, and of being excellent in all. Leonardo was an architect, a poet, a painter, an hydraulic engineer and a distinguished mathematician. Alberti was a musician, studied jurisprudence, was an architect and a draughtsman, and had great fame in literature. He had a deep feeling for nature, an almost unique faculty of assimilating all that he saw and heard. Leonardo and Alberti are representatives and almost a compendium in themselves of all that intellectual vigour of the Renaissance age, which in the 16th century took to developing itself in its individual parts, making way for what has by some been called the golden age of Italian literature.

4. *Development of the Renaissance.*—The fundamental characteristic of the literary epoch following that of the Renaissance is that it perfected itself in every kind of art, in particular uniting the essentially Italian character of its language with classicism of style. This period lasted from about 1494 to about 1560; and, strange to say, this very period of greater fruitfulness and literary greatness began from the year 1494, which with Charles VIII.'s descent into Italy marked the beginning of its political decadence and of foreign domination over it. But this is not hard to explain. All the most famous men of the first half of the 16th had been educated in the preceding century. Pietro Pomponazzi was born in 1462, Marcello Virgilio Adriani in 1464, Castiglione in 1468, Machiavelli in 1469, Bembo in 1470, Michelangelo Buonarroti and Ariosto in 1474, Nardi in 1476, Trissino in 1478, Guicciardini in 1482. Thus it is easy to understand how the literary activity which showed itself from the end of the 15th century to the middle of the following one was the product of the political and social conditions of the age in which these minds were formed, not of that in which their powers were displayed.

Niccolò Machiavelli and Francesco Guicciardini were the chief

originators of the science of history. Machiavelli's principal works are the *Storie fiorentine*, the *Discorsi sulla prima decina di Tito Livio*, the *Arte della guerra* and the *Principe*. His merit consists in having been the creator of the experimental science of politics—in having observed facts, studied histories and drawn consequences from them. His history is sometimes inexact in facts; it is rather a political than an historical work. The peculiarity of Machiavelli's genius lay, as has been said, in his artistic feeling for the treatment and discussion of politics in and for themselves, without regard to an immediate end—in his power of abstracting himself from the partial appearances of the transitory present, in order more thoroughly to possess himself of the eternal and inborn kingdom, and to bring it into subjection to himself.

Next to Machiavelli both as an historian and a statesman comes Francesco Guicciardini. Guicciardini was very observant, and endeavoured to reduce his observations to a science. His *Storia d'Italia*, which extends from the death of Lorenzo de' Medici to 1534, is full of political wisdom, is skillfully arranged in its parts, gives a lively picture of the character of the persons it treats of, and is written in a grand style. He shows a profound knowledge of the human heart, and depicts with truth the temperaments, the capabilities and the habits of the different European nations. Going back to the causes of events, he looked for the explanation of the divergent interests of princes and of their reciprocal jealousies. The fact of his having witnessed many of the events he related, and having taken part in them, adds authority to his words. The political reflections are always deep; in the *Pensieri*, as G. Capponi<sup>1</sup> says, he seems to aim at extracting through self-examination a quintessence, as it were, of the things observed and done by him—thus endeavouring to form a political doctrine as adequate as possible in all its parts. Machiavelli and Guicciardini may be considered, not only as distinguished historians, but as originators of the science of history founded on observation.

Inferior to them, but still always worthy of note, were Jacopo Nardi (a just and faithful historian and a virtuous man, who defended the rights of Florence against the Medici before Charles V.), Benedetto Varchi, Giambattista Adriani, Bernardo Segni; and, outside Tuscany, Camillo Porzio, who related the *Congiura de' baroni* and the history of Italy from 1547 to 1552, Angelo di Costanza, Pietro Bembo, Paolo Paruta and others.

Ariosto's *Orlando furioso* was a continuation of Boiardo's *Innamorato*. His characteristic is that he assimilated the romance of chivalry to the style and models of classicism. Ariosto was an artist only for the love of his art; his sole aim was to make a romance that should please the generation in which he lived. His *Orlando* has no grave and serious purpose; on the contrary it creates a fantastic world, in which the poet rambles, indulging his caprice, and sometimes smiling at his own work. His great desire is to depict everything with the greatest possible perfection; the cultivation of style is what occupies him most. In his hands the style becomes wonderfully plastic to every conception, whether high or low, serious or sportive. The octave stanza reached in him the highest perfection of grace, variety and harmony.

Meanwhile, side by side with the romantic, there was an attempt at the historical epic. Gian Giorgio Trissino of Vicenza composed a poem called *Italia liberata dai Goti*. Full of learning and of the rules of the ancients, he formed himself on the latter, in order to sing of the campaigns of Belisarius; he said that he had forced himself to observe all the rules of Aristotle, and that he had imitated Homer. In this again, we see one of the products of the Renaissance; and, although Trissino's work is poor in invention and without any original poetical colouring, yet it helps one to understand better what were the conditions of mind in the 16th century.

Lyric poetry was certainly not one of the kinds that rose to

<sup>1</sup> *Storia della repubblica di Firenze* (Florence, 1876).

*Romantic epic.*  
Ariosto (1474-1533).

*Heroic epic.*

any great height in the 16th century. Originality was entirely wanting, since it seemed in that century as if nothing better could be done than to copy Petrarch. Still, even in this style there were some vigorous poets. Monsignore Giovanni Guidiccioni of Lucca (1500-1541) showed that he had a generous heart. In fine sonnets he gave expression to his grief for the sad state to which his country was reduced. Francesco Molza of Modena (1489-1544), learned in Greek, Latin and Hebrew, wrote in a graceful style and with spirit. Giovanni della Casa (1503-1556) and Pietro Bembo (1470-1547), although Petrarchists, were elegant. Even Michelangelo Buonarroti was at times a Petrarchist, but his poems bear the stamp of his extraordinary and original genius. And a good many ladies are to be placed near these poets, such as Vittoria Colonna (loved by Michelangelo), Veronica Gamba, Tullia d'Aragona, Giulia Gonzaga, poetesses of great delicacy, and superior in genius to many literary men of their time.

The 16th century had not a few tragedies, but they are all weak. The cause of this was the moral and religious indifference of the Italians, the lack of strong passions and vigorous characters. The first to occupy the tragic stage was Trissino with his *Sofonisba*, following the rules of the art most scrupulously, but written in sickly verses, and without warmth of feeling. The *Oreste* and the *Rosmunda* of Giovanni Rucellai were no better, nor Luigi Alamanni's *Antigone*. Sperone Speroni in his *Canace* and Giraldo Cintio in his *Orbecche* tried to become innovators in tragic literature, but they only succeeded in making it grotesque. Decidedly superior to these was the *Torrismondo* of Torquato Tasso, specially remarkable for the choruses, which sometimes remind one of the chorus of the Greek tragedies.

The Italian comedy of the 16th century was almost entirely modelled on the Latin comedy. They were almost always alike in the plot, in the characters of the old man, of the servant, of the waiting-maid; and the argument was often the same. Thus the *Lucidi* of Agnolo Firenzuola, and the *Vecchio amoroso* of Donato Giannotti were modelled on comedies by Plautus, as were the *Sporta* by Gelli, the *Marito* by Dolce, and others. There appear to be only three writers who should be distinguished among the many who wrote comedies—Machiavelli, Ariosto and Giovan Maria Cecchi. In his *Mandragora* Machiavelli, unlike all the others, composed a comedy of character, creating types which seem living even now, because they were copied from reality seen with a finely observant eye. Ariosto, on the other hand, was distinguished for his picture of the habits of his time, and especially of those of the Ferrarese nobles, rather than for the objective delineation of character. Lastly, Cecchi left in his comedies a treasure of spoken language, which nowadays enables us in a wonderful way to make ourselves acquainted with that age. The notorious Pietro Aretino might also be included in the list of the best writers of comedy.

The 15th century was not without humorous poetry; Antonio Cammelli, surnamed the Pistoian, is specially deserving of notice, because of his "pungent bonhomie," as Sainte-Beuve called it. But it was Francesco Berni who carried this kind of literature to perfection in the 16th century. From him the style has been called "bernesque" poetry. In the "Berneschi" we find nearly the same phenomenon that we already noticed with regard to *Orlando furioso*. It was art for art's sake that inspired and moved Berni to write, as well as Anton Francesco Grazzini, called Il Lasca, and other lesser writers. It may be said that there is nothing in their poetry; and it is true that they specially delight in praising low and disgusting things and in jeering at what is noble and serious. Bernesque poetry is the clearest reflection of that religious and moral scepticism which was one of the characteristics of Italian social life in the 16th century, and which showed itself more or less in all the works of that period, that scepticism which stopped the religious Reformation in Italy, and which in its turn was an effect of historical conditions. The Berneschi, and especially Berni himself, sometimes assumed

a satirical tone. But theirs could not be called true satire. Pure satirists, on the other hand, were Antonio Vinciguerra, a Venetian, Lodovico Alamanni and Ariosto, the last superior to the others for the Attic elegance of his style, and for a certain frankness, passing into malice, which is particularly interesting when the poet talks of himself.

In the 16th century there were not a few didactic works. In his poem of the *Api* Giovanni Rucellai approaches to the perfection of Virgil. His style is clear and light, and he adds interest to his book by frequent allusions to the events of the time. But of the didactic works that which surpasses all the others in importance is Baldassare Castiglione's *Cortigiano*, in which he imagines a discussion in the palace of the dukes of Urbino between knights and ladies as to what are the gifts required in a perfect courtier. This book is valuable as an illustration of the intellectual and moral state of the highest Italian society in the first half of the 16th century.

Of the novelists of the 16th century, the two most important were Anton Francesco Grazzini and Matteo Bandello—the former as playful and bizarre as the latter is grave and solemn. As part of the history of the times, we must not forget that Bandello was a Dominican friar and a bishop, but that notwithstanding his novels were very loose in subject, and that he often holds up the ecclesiastics of his time to ridicule.

At a time when admiration for qualities of style, the desire for classical elegance, was so strong as in the 16th century, much attention was naturally paid to translating Latin and Greek authors. Among the very numerous translations of the time those of the *Aeneid* and of the *Pastorals* of Longus the Sophist by Annibal Caro are still famous; as are also the translations of Ovid's *Metamorphoses* by Giovanni Andrea dell'Anguillare, of Apuleius's *Golden Ass* by Firenzuola, and of Plutarch's *Lives* and *Moralia* by Marcello Adriani.

The historians of Italian literature are in doubt whether Tasso should be placed in the period of the highest development of the Renaissance, or whether he should form a period by himself, intermediate between that and the one following. Certainly he was profoundly out of harmony with the century in which he lived. His religious faith, the seriousness of his character, the deep melancholy settled in his heart, his continued aspiration after an ideal perfection, all place him as it were outside the literary epoch represented by Machiavelli, by Ariosto, by Berni. As Carducci has well said, Tasso "is the legitimate heir of Dante Alighieri: he believes, and reasons on his faith by philosophy; he loves, and comments on his love in a learned style; he is an artist, and writes dialogues of scholastic speculation that would fain be Platonic." He was only eighteen years old when, in 1562, he tried his hand at epic poetry, and wrote *Rinaldo*, in which he said that he had tried to reconcile the Aristotelian rules with the variety of Ariosto. He afterwards wrote the *Aminta*, a pastoral drama of exquisite grace. But the work to which he had long turned his thoughts was a heroic poem, and that absorbed all his powers. He himself explains what his intention was in the three *Discorsi* written whilst he was composing the *Gerusalemme*: he would choose a great and wonderful subject, not so ancient as to have lost all interest, nor so recent as to prevent the poet from embellishing it with invented circumstances; he meant to treat it rigorously according to the rules of the unity of action observed in Greek and Latin poems, but with a far greater variety and splendour of episodes, so that in this point it should not fall short of the romantic poem; and finally, he would write it in a lofty and ornate style. This is what Tasso has done in the *Gerusalemme liberata*, the subject of which is the liberation of the sepulchre of Jesus Christ in the 11th century by Godfrey of Bouillon. The poet does not follow faithfully all the historical facts, but sets before us the principal causes of them, bringing in the supernatural agency of God and Satan. The *Gerusalemme* is the best heroic poem that Italy can show. It approaches to classical perfection. Its episodes above all are most beautiful. There is profound feeling in it, and everything reflects the melancholy soul of the poet. As regards the style, however,

Lyric poetry.

Tragedy.

Comedy.

Burlesque and satire.

Didactic works.

Fiction.

Translations.

Tasso (1544-1595).

although Tasso studiously endeavored to keep close to the classical models, one cannot help noticing that he makes excessive use of metaphor, of antithesis, of far-fetched conceits; and it is specially from this point of view that some historians have placed Tasso in the literary period generally known under the name of "Scenitismo," and that others, more moderate in their criticism, have said that he prepared the way for it.

5. *Period of Decadence.*—From about 1550 began a period of decadence in Italian literature. The Spanish rule oppressed and corrupted the peninsula. The minds of men were day by day gradually losing their force; every high aspiration was quenched. No love of country could any longer be felt when the country was enslaved to a stranger. The suspicious rulers fettered all freedom of thought and word; they tortured Campanella, burned Bruno, made every effort to extinguish all high sentiment, all desire for good. Cesare Balbo says, "if the happiness of the masses consists in peace without industry, if the nobility's consists in titles without power, if princes are satisfied by acquiescence in their rule without real independence, without sovereignty, if literary men and artists are content to write, paint and build with the approbation of their contemporaries, but to the contempt of posterity, if a whole nation is happy in ease without dignity and the tranquil progress of corruption,—then no period ever was so happy for Italy as the hundred and forty years

from the treaty of Cateau Cambresis to the war of the Spanish succession." This period is known in the history of Italian literature as the Scenitismo. Its writers, devoid of sentiment, of passion, of thoughts, resorted to exaggeration; they tried to produce effect with every kind of affectation, with bombast, with the strangest metaphors, in fact, with what in art is called mannerism, "barocchism." The utter poverty of the matter tried to cloak itself under exuberance of forms. It seemed as if the writers vied with one another as to who could best burden his art with useless metaphors, with phrases, with big-sounding words, with affectations, with hyperbole, with oddities, with everything that could fix attention on the outer form and draw it off from the substantial element of thought.

At the head of the school of the "Scenitisti" comes Giovan Battista Marini of Naples, born in 1560, especially known by a poem called *L'Adone*. His aim was to excite wonder by novelties; hence the most extravagant metaphors, the most forced antitheses, the most far-fetched conceits, are to be found in his book. It was especially by antitheses that he thought he could produce the greatest effect. Sometimes he strings them together one after the other, so that they fill up whole stanzas without a break. Achillini of Bologna followed in Marini's steps. He had less genius, however, and hence his peculiarities were more extravagant, becoming indeed absolutely ridiculous. In general, we may say that all the poets of the 17th century were more or less infected with "Marinism." Thus Alessandro Guidi, although he does not attain to the exaggeration of his master, is empty bombastic, inflated, turgid, while Fulvio Testi is artificial and affected. Yet Guidi as well as Testi felt the influence of another poet, Gabriello Chiabrera, born at Savona in 1552. In him the Scenitismo took another character. Enamoured as he said he was of the Greeks, he made new metres, especially in imitation of Pindar, treating of religious, moral, historical and amatory subjects. It is easy to understand that a Pindaric style of poetry in the 17th century in Italy could not but end in being altogether artificial, without anything of those qualities which constitute the greatness of the Greek poet. Chiabrera, though elegant enough in form, proves empty of matter, and in his vain attempt to hide this vacuity, has recourse to poetical ornaments of every kind. These again, in their turn, become in him a fresh defect. Nevertheless, Chiabrera's school, in the decadence of the 17th century, marks an improvement; and sometimes he showed that he had lyrical capacities, which in better literary surroundings would have brought forth excellent fruit. When he sings, for example, of the victories of the Tuscan galleys against the Turks and the pirates of the Mediterranean, he rises to grand imagery, and seems quite another poet.

Filicaja the Florentine has a certain lyric *élan*, particularly in the songs about Vienna besieged by the Turks, which seems to raise him more than the others above the vices of the time; but even in him we see clearly the rhetorical artifice and the falseness of the conceits. And in general all the lyric poetry of the 17th century may be said to have had the same defects, but in different degrees—defects which may be summed up as absence of feeling and exaggeration of form. There was no faith; there was no love; and thus art became an exercise, a pastime, a luxury, for a servile and corrupt people.

The belief then arose that it would be sufficient to change the form in order to restore literature, in forgetfulness that every reform must be the effect of a change in social and moral conditions. Weary of the bombastic style of the 17th century, full of conceits and antithesis, men said—let us follow an entirely different line, let us fight the turgid style with simplicity. In 1690 the "Academy of Arcadia" was instituted. Its founders were Giovan Maria Crescimbeni and Gian Vincenzo Gravina. The Arcadia was so called because its chief aim and intention were to imitate in literature the simplicity of the ancient shepherds, who were fabulously supposed to have lived in Arcadia in the golden age. As the "Scenitisti" erred by an overweening desire for novelty, which made them always go beyond the truth, so the Arcadians proposed to themselves to return to the fields of truth, always singing of subjects of pastoral simplicity. This was obviously nothing else than the substitution of a new artifice for the old one; and they fell from bombast into effeminacy, from the hyperbolic into the petty, from the turgid into the over-refined. The Arcadia was a reaction against Scenitismo, but a reaction which, reversing the movement of that earlier epoch, only succeeded in impoverishing still further and completely withering up the literature. The poems of the "Arcadians" fill many volumes, and are made up of sonnets, madrigals, canzonets and blank verse. The one who most distinguished himself among the sonneteers was Felice Zappi. Among the authors of songs Paolo Rolli was illustrious. Innocenzo Frugoni was more famous than all the others, a man of fruitful imagination but of shallow intellect, whose wordy verses nobody now reads.

Whilst the political and social conditions in Italy in the 17th century were such as to make it appear that every light of intelligence, all spirit of liberty, was extinguished, there appeared in the peninsula, by that law of reaction which in great part governs human events, some strong and independent thinkers, such as Bernardino Telesio,

Giordano Bruno, Tommaso Campanella, Lucilio Vanini, who turned philosophical inquiry into fresh channels, and opened the way for the scientific conquests of Galileo Galilei, the great contemporary of Descartes in France and of Bacon in England. Galileo was not only a great man of science, but also occupied a conspicuous place in the history of letters. A devoted student of Ariosto, he seemed to transfuse into his prose the qualities of that great poet—a clear and frank freedom of expression, a wonderful art of knowing how to say everything with precision and ease, and at the same time with elegance. Galileo's prose is in perfect antithesis to the poetry of his time. Perhaps it is the best prose that Italy has ever had; it is clear, goes straight to the point, is without rhetorical ornaments and without vulgar slips, artistic without appearing to be so.

Another symptom of revival, a sign of rebellion against the vileness of Italian social life, is given us in satire and in particular in that of Salvatore Rosa and Alessandro Tassoni. Salvatore Rosa, born in 1615, near Naples, was a painter, a musician and a poet. As a poet he showed that he felt the sad condition of his country, showed that he mourned over it, and gave vent to his feeling (as another satire-writer, Giuseppe Giusti, said) in *generosi rabuffi*. His exhortation to Italian poets to turn their thoughts to the miseries of their country as a subject for their song—their country languishing under the tyrant's hands—certain passages where he deplores the effeminacy of Italian habits, a strong apostrophe against Rome, make Salvatore Rosa a precursor of the patriotic literature which inaugurated the revival of the 18th century.

The  
Arcadia.

The Se-  
centismo.

Marini.

Symptoms  
of revival.  
Scientific  
prose.

Tassoni, a man really quite exceptional in this century, was superior to Rosa. He showed independent judgment in the midst of universal servility, and his *Secchia Rapita* proved that he was an eminent writer. This is an heroic comic poem, which is at the same time an epic and a personal satire. He was bold enough to attack the Spaniards in his *Filippiche*, in which he urged Duke Carlo Emanuele of Savoy to persist in the war against them.

6. *The Revival in the 18th Century.*—Having for the most part freed itself from the Spanish dominion in the 18th century, the political condition of Italy began to improve. Promoters of this improvement, which was shown in many civil reforms, were Joseph II., Leopold I. and Charles I.

The work of these princes was copied from the philosophers, who in their turn felt the influence of a general movement of ideas, which was quietly working in many parts of Europe, and which came to a head in the French encyclopedists.

Giambattista Vico was a token of the awakening of historical consciousness in Italy. In his *Scienza nuova* he applied himself to the investigation of the laws governing the progress of the human race, and according to which events are developed. From the psychological study of man he endeavoured to infer the "comune natura delle nazioni," i.e. the universal laws of history, or the laws by which civilizations rise, flourish and fall.

From the same scientific spirit which animated the philosophical investigation of Vico, there was born a different kind of investigation, that of the sources of Italian civil and literary history, Ludovico Antonio Muratori, after having collected in one entire body (*Rerum Italicarum scriptores*) the chronicles, the biographies, the letters and the diaries of Italian history from 500 to 1500, after having discussed the most obscure historical questions in the *Antiquitates Italicae medii aevi*, wrote the *Annali d' Italia*, minutely narrating facts derived from authentic sources. Muratori's associates in his historical researches were Scipione Maffei of Verona and Apostolo Zeno of Venice. In his *Verona illustrata* the former left, not only a treasure of learning, but an excellent specimen of historical monograph. The latter added much to the erudition of literary history, both in his *Dissertationi Vossiane* and in his notes to the *Biblioteca dell' erudito italiano* of Monsignore Giusto Fontanini. Girolamo Tiraboschi and Count Giovanni Maria Mazzuchelli of Brescia devoted themselves to literary history.

While the new spirit of the times led men to the investigation of historical sources, it also led them to inquire into the mechanism of economical and social laws. Francesco Galiani wrote on currency; Gaetano Filangieri wrote a *Scienza della legislazione*. Cesare Beccaria, in his treatise *Dei delitti e delle pene*, made a contribution to the reform of the penal system and promoted the abolition of torture.

The man in whom above all others the literary revival of the 18th century was most conspicuously embodied was Giuseppe Parini. He was born in a Lombard village in 1729, was mostly educated at Milan, and as a youth was known among the Arcadian poets by the name of Darisbo Elidonio. Even as an Arcadian, however, Parini showed signs of departing from the common type. In a collection of poems that he published at twenty-three years of age, under the name of Ripano Eupilino, there are some pastoral sonnets in which the poet shows that he had the faculty of taking his scenes from real life, and also some satirical pieces in which he exhibits a spirit of somewhat rude opposition to his own times. These poems are perhaps based on reminiscences of Berni, but at any rate they indicate a resolute determination to assault boldly all the literary conventionalities that surrounded the author. This, however, was only the beginning of the battle. Parini lived in times of great social prostration. The nobles and the rich, all given up to ease and to silly gallantry, consumed their lives in ridiculous trifles or in shameless self-indulgence, wasting themselves on immoral "Cicisbeismo," and offering the most miserable spectacle of feebleness of mind and character. It was against this social condition that Parini's muse was

directed. Already, improving on the poems of his youth, he had proved himself an innovator in his lyrics, rejecting at once Petrarchism, Secentismo and Arcadia, the three maladies that had weakened Italian art in the centuries preceding his own, and choosing subjects taken from real life, such as might help in the instruction of his contemporaries. In the *Odi* the satirical note is already heard. But it came out more strongly in the poem *Del giorno*, in which he imagines himself to be teaching a young Milanese patrician all the habits and ways of gallant life; he shows up all its ridiculous frivolities, and with delicate irony unmask the follies of aristocratic habits. Dividing the day into four parts, the Mattino, the Mezzogiorno, the Vespero, the Notte, by means of each of these he describes the trifles of which they were made up, and the book thus assumes a social and historical value of the highest importance. Parini, satirizing his time, fell back upon truth, and finally made art serve the purpose of civil morality. As an artist, good straight back to classical forms, aspiring to imitate Virgil and Dante, he opened the way to the fine school that we shall soon see rise, that of Alfieri, Foscolo and Monti. As a work of art, the *Giorno* is wonderful for the Socratic skill with which that delicate irony is constantly kept up by which he seems to praise what he effectually blames. The verse has new harmonies; sometimes it is a little hard and broken, not by accident, but as a protest against the Arcadian monotony. Generally it flows majestically, but without that Frugonian droning that deafens the ears and leaves the heart cold.

Gasparo Gozzi's satire was less elevated, but directed towards the same end as Parini's. In his *Osservatore*, something like Addison's *Spectator*, in his *Gazzetta veneta*, in the *Mondo morale*, by means of allegories and novelties

Gozzi:  
Baretti.

he hit the vices with a delicate touch, and inculcated a practical moral with much good sense. Gozzi's satire has some slight resemblance in style to Lucian's. It is smooth and light, but withal it does not go less straight to its aim, which is to point out the defects of society and to correct them. Gozzi's prose is very graceful and lively. It only errs by its overweening affectation of imitating the writers of the 14th century. Another satirical writer of the first half of the 18th century was Giuseppe Baretti of Turin. In a journal called the *Frusta letteraria* he took to lashing without mercy the works which were then being published in Italy. He had learnt much by travelling; and especially his long stay in England had contributed to give an independent character to his mind, and made him judge of men and things with much good sense. It is true that his judgments are not always right, but the *Frusta letteraria* was the first book of independent criticism directed particularly against the Arcadians and the pedants.

Everything tended to improvement, and the character of the reform was to throw off the conventional, the false, the artificial, and to return to truth. The drama felt this influence of the times. Apostolo Zeno and Metastasio (the Arcadian name for Pietro Trapassi, a native of Rome) had endeavoured to make "melodrama and reason compatible." The latter in particular succeeded in giving fresh expression to the affections, a natural turn to the dialogue and some interest to the plot; and if he had not fallen into constant unnatural over-refinement and unseasonable mawkishness, and into frequent anachronisms, he might have been considered as the first dramatic reformer of the 18th century. That honour belongs to Carlo Goldoni, a Venetian. He found comedy either entirely devoted to classical imitation or given up to extravagance, to *coups de théâtre*, to the most boisterous succession of unlikely situations, or else treated by comic actors who recited impromptu on a given subject, of which they followed the outline. In this old popular form of comedy, with the masks of pantaloon, of the doctor, of harlequin, of Brighella, &c., Goldoni found the strongest obstacles to his reform. But at last he conquered, creating the comedy of character. No doubt Molière's example helped him in this. Goldoni's characters are always true, but often a little superficial. He studied nature, but he did not plunge into psychological depths. In most of his creations, the

Dramatic  
reform.

external rather than the internal part is depicted. In this respect he is much inferior to Molière. But on the other hand he surpasses him in the liveliness of the dialogue, and in the facility with which he finds his dramatic situations. Goldoni wrote much, in fact too much (more than one hundred and fifty comedies), and had no time to correct, to polish, to perfect his works, which are all rough cast. But for a comedy of character we must go straight from Machiavelli's *Mandragora* to him. Goldoni's dramatic aptitude is curiously illustrated by the fact that he took nearly all his types from Venetian society, and yet managed to give them an inexhaustible variety. A good many of his comedies were written in Venetian dialect, and these are perhaps the best.

The ideas that were making their way in French society in the 18th century, and afterwards brought about the Revolution of 1789, gave a special direction to Italian literature of the second half of the 18th century. Love of ideal liberty, desire for equality, hatred of tyranny, created in Italy a literature which aimed at national objects, seeking to improve the condition of the country by freeing it from the double yoke of political and religious despotism. But all this was associated with another tendency. The Italians who aspired to a political redemption believed that it was inseparable from an intellectual revival, and it seemed to them that this could only be effected by a reunion with ancient classicism—in other words, by putting themselves in more direct communication with ancient Greek and Latin writers. This was a repetition of what had occurred in the first half of the 15th century. The 17th century might in fact be considered as a new Italian Middle Age without the hardness of that iron time, but corrupted, enervated, overrun by Spaniards and French, an age in which previous civilization was cancelled. A reaction was necessary against that period of history, and a construction on its ruins of a new country and a new civilization. There had already been forerunners of this movement; at the head of them the revered Parini. Now the work must be completed, and the necessary force must once more be sought for in the ancient literature of the two classic nations.

Patriotism and classicism then were the two principles that inspired the literature which began with Alfieri. He worshipped the Greek and Roman idea of popular liberty in arms against the tyrant. He took the subjects of his tragedies almost invariably from the history of these nations, made continual apostrophes against the despots, made his ancient characters talk like revolutionists of his time; he did not trouble himself with, nor think about, the truth of the characters: it was enough for him that his hero was Roman in name, that there was a tyrant to be killed, that liberty should triumph in the end. But even this did not satisfy Alfieri. Before his time and all about him there was the Arcadian school, with its foolish verbosity, its empty abundance of epithets, its nauseous pastoralizing on subjects of no civil importance. It was necessary to arm the patriotic muse also against all this. If the Arcadians, not excluding the hated Metastasio, diluted their poetry with languishing tenderness, if they poured themselves out in so many words, if they made such set phrases, it behoved the others to do just the contrary—to be brief, concise, strong, bitter, to aim at the sublime as opposed to the lowly and pastoral. Having said this, we have told the good and evil of Alfieri. He desired a political reform by means of letters; he saved literature from Arcadian vacuities, leading it towards a national end; he armed himself with patriotism and classicism in order to drive the profaners out of the temple of art. But in substance he was rather a patriot than an artist. In any case the results of the new literary movement were copious.

Ugo Foscolo was an eager patriot, who carried into life the heat of the most unbridled passion, and into his art a rather rhetorical manner, but always one inspired by classical models. Foscolo. *The Letters of Jacobo Ortis*, inspired by Goethe's *Werther*, are a love story with a mixture of patriotism; they contain a violent protest against the treaty of Campo Formio, and an outburst from Foscolo's own heart about an unhappy

love-affair of his. His passions were sudden and violent; they came to an end as abruptly as they began; they were whirlwinds that were over in a quarter of an hour. To one of these passions *Ortis* owed its origin, and it is perhaps the best, the most sincere, of all his writings. Even in it he is sometimes pompous and rhetorical, but much less so than he is, for example, in the lectures *Dell' origine e dell' ufficio della letteratura*. On the whole, Foscolo's prose is turgid and affected, and reflects the character of the man who always tried to pose, even before himself, in dramatic attitudes. This was indeed the defect of the Napoleonic epoch; there was a horror of anything common, simple, natural; everything must be after the model of the hero who made all the world gaze with wonder at him; everything must assume some heroic shape. In Foscolo this tendency was excessive; and it not seldom happened that, in wishing to play the hero, the exceptional man, the little Napoleon of ladies' drawing-rooms, he became false and bad, false in his art, bad in his life. *The Sepolcri*, which is his best poem, was prompted by high feeling, and the mastery of versification shows wonderful art. Perhaps it is to this mastery more than to anything else that the admiration the *Sepolcri* excites is due. There are most obscure passages in it, as to the meaning of which it would seem as if even the author himself had not formed a clear idea. He left incomplete three hymns to the Graces, in which he sang of beauty as the source of courtesy, of all high qualities and of happiness. Here again what most excites our admiration is the harmonious and easy versification. Among his prose works a high place belongs to his translation of the *Sentimental Journey* of Sterne, a writer by whom one can easily understand how Foscolo should have been deeply affected. He went as an exile to England, and died there. He wrote for English readers some *Essays* on Petrarch and on the texts of the *Decamerone* and of Dante, which are remarkable for the time at which they were written, and which may be said to have initiated a new kind of literary criticism in Italy. Foscolo is still greatly admired, and not without reason. His writings stimulate the love of fatherland, and the men that made the revolution of 1848 were largely brought up on them.

If in Foscolo patriotism and classicism were united, and formed almost one passion, so much cannot be said of Vincenzo Monti, in whom the artist was absolutely predominant. Monti. Yet Monti was a patriot too, but in his own way. He had no one deep feeling that ruled him, or rather the mobility of his feelings is his characteristic; but each of these was a new form of patriotism, that took the place of an old one. He saw danger to his country in the French Revolution, and wrote the *Pellegrino apostolico*, the *Bassivilliana* and the *Feroniade*; Napoleon's victories caused him to write the *Promeleo* and the *Musagonia*; in his *Fanatismo* and his *Superstizione* he attacked the papacy; afterwards he sang the praises of the Austrians. Thus every great event made him change his mind, with a readiness which might seem incredible, but is yet most easily explained. Monti was above everything an artist; art was his real, his only passion; everything else in him was liable to change, that alone was persistent. Fancy was his tyrant, and under its rule he had no time to reason and to see the miserable aspect of his political tergiversation. It was an overbearing deity that moved him, and at its dictation he wrote. Pius VI., Napoleon, Francis II., were to him but passing shadows, to which he hardly gives the attention of an hour; that which endures, which is eternal to him, is art alone. It were unjust to accuse Monti of baseness. If we say that nature in giving him one only faculty had made the poet rich and the man poor, we shall speak the truth. But the poet was indeed rich. Knowing little Greek, he succeeded in making a translation of the *Iliad* which is remarkable for its Homeric feeling, and in his *Bassivilliana* he is on a level with Dante. In fine, in him classical poetry seemed to revive in all its florid grandeur.

Monti was born in 1754, Foscolo in 1778; four years later still was born another poet of the same school, Giambattista Niccolini. In literature he was a classicist; in politics he was a Ghibelline, a rare exception in Guelph Florence. his



birthplace. In translating or, if the expression is preferred, imitating Aeschylus, as well as in writing the *Discorsi sulla tragedia greca*, and on the *Sublime e Michelangelo*, Niccolini displayed his passionate devotion to ancient literature. In his tragedies he set himself free from the excessive rigidity of Alfieri, and partly approached the English and German tragic authors. He nearly always chose political subjects, striving to keep alive in his compatriots the love of liberty. Such are *Nabucco*, *Antonio Foscarini*, *Giovanni da Procida*, *Lodovico il Moro*, &c. He assailed papal Rome in *Arnaldo da Brescia*, a long tragic piece, not suited for acting, and epic rather than dramatic. Niccolini's tragedies show a rich lyric vein rather than dramatic genius. At any rate he has the merit of having vindicated liberal ideas, and of having opened a new path to Italian tragedy.

The literary period we are dealing with had three writers who are examples of the direction taken by historical study. It seems

**Historians.** strange that, after the learned school begun by Muratori, there should have been a backward movement here, but it is clear that this retrogression was due to the influence of classicism and patriotism, which, if they revived poetry, could not but spoil history. Carlo Botta, born in 1766, was a spectator of French spoliation in Italy and of the overbearing rule of Napoleon. Hence, excited by indignation, he wrote a *History of Italy from 1789 to 1814*; and later on he continued Guicciardini's *History* up to 1789. He wrote after the manner of the Latin authors, trying to imitate Livy, putting together long and sonorous periods in a style that aimed at being like Boccaccio's, caring little about that which constitutes the critical material of history, only intent on declaiming his academic prose for his country's benefit. Botta wanted to be classical in a style that could no longer be so, and hence he failed completely to attain his literary goal. His fame is only that of a man of a noble and patriotic heart. Not so bad as the two histories of Italy is that of the *Guerra dell'indipendenza americana*.

Close to Botta comes Pietro Colletta, a Neapolitan born nine years after him. He also in his *Storia del Reame di Napoli dal 1734 al 1825* had the idea of defending the independence and liberty of Italy in a style borrowed from Tacitus; and he succeeded rather better than Botta. He has a rapid, brief, nervous style, which makes his book attractive reading. But it is said that Pietro Giordani and Gino Capponi corrected it for him. Lazzaro Papi of Lucca, author of the *Commentari della rivoluzione francese dal 1789 al 1814*, was not altogether unlike Botta and Colletta. He also was an historian in the classical style, and treats his subject with patriotic feeling; but as an artist he perhaps excels the other two.

At first sight it seems unnatural that, whilst the most burning political passions were raging, and whilst the most brilliant men of genius in the new classical and patriotic school were at the height of their influence, a question should have arisen about "purism" of language. Yet the phenomenon can be easily accounted for. Purism is another form of classicism and patriotism. In the second half of the 18th century the Italian language was specially full of French expressions. There was great indifference about fitness, still more about elegance of style. Prose then was to be restored for the sake of national dignity, and it was believed that this could not be done except by going back to the writers of the 14th century, to the "aurei trecentisti," as they were called, or else to the classics of Italian literature. One of the promoters of the new school was Antonio Cesari of Verona, who republished ancient authors, and brought out a new edition, with additions, of the *Vocabolario della Crusca*. He wrote a dissertation *Sopra lo stato presente della lingua italiana*, and endeavoured to establish the supremacy of Tuscan and of the three great writers Dante, Petrarca, Boccaccio. And in accordance with that principle he wrote several books, taking pains to copy the "trecentisti" as closely as possible. But patriotism in Italy has always had something municipal in it; so to this Tuscan supremacy, proclaimed and upheld by Cesari, there was opposed a Lombard school, which would know nothing of Tuscan, and with Dante's *De vulgari eloquio* returned to the idea of the "lingua illustre."

This was an old question, largely and bitterly argued in the Cinquecento (16th century) by Varchi, Muzio, Castelvetro, Speroni and others. Now the question came up again quite fresh, as if no one had ever discussed it before. At the head of the Lombard school were Monti and his son-in-law Count Giulio Perticari. This gave Monti an occasion to write *Proposta di alcune correzioni ed aggiunte al vocabolario della Crusca*, in which he attacked the Tuscanism of the *Crusca*, but in a graceful and easy style, such in fact as to form a prose that is one of the most beautiful in Italian literature. Perticari on the other hand, with a very inferior intellect, narrated and expandered the question in two treatises, *Degli scrittori del Trecento* and *Dell' amor patrio di Dante*, in which, often disguising or altering the facts, he only makes confusion where there was none. Meantime, however, the impulse was given. The dispute about language took its place beside literary and political disputes, and all Italy took part in it—Basilio Puoti at Naples, Paolo Costa in the Romagna, Marc' Antonio Parenti at Modena, Salvatore Betti at Rome, Giovanni Gherardini in Lombardy, Luigi Fornaciari at Lucca, Vincenzo Nannucci at Florence.

A patriot, a classicist and a purist all at once was Pietro Giordani, born in 1774; he was almost a compendium of the literary movement of the time. His whole life was a battle fought for liberty. Most learned in Greek and Latin authors, and in the Italian trecentisti, he only left a few writings behind him, but they were carefully elaborated in point of style, and his prose was in his time considered wonderful. Now it is looked on as too majestic, too much laboured in phrases and conceits, too far from nature, too artificial. Giordani closes the literary epoch of the classicists.

7. *Nineteenth Century and After.*—At this point the contemporary period of literature begins. It has been said that the first impulse was given to it by the romantic school, which had as its organ the *Conciliatore* established in 1818 at Milan, and on the staff of which were Silvio Pellico, Lodovico di Breme, GIOVINE SCALVINI, Tommaso Grossi, Giovanni Berchet, Samuele Biava and lastly Alessandro Manzoni. It need not be denied that all these men were influenced by the ideas that, especially in Germany, at the beginning of the 19th century constituted the movement called Romanticism. Nevertheless, in Italy the course of literary reform took another direction. There is no doubt that the real head of the reform, or at least its most distinguished man, was Alessandro Manzoni. He formulated in a letter of his the objects of the new school, saying that it aspired to try and discover and express "il vero storico" and "il vero morale" not only as an end, but as the widest and eternal source of the beautiful. And it is precisely realism in art that characterizes Italian literature from Manzoni onwards. The *Promessi Sposi* is the one of his works that has made him immortal. No doubt the idea of the historical novel came to him from Sir Walter Scott, but he succeeded in something more than an historical novel in the narrow meaning of that word; he created an eminently realistic work of art. The romance disappears; no one cares for the plot, which moreover is of very little consequence. The attention is entirely fixed on the powerful objective creation of the characters. From the greatest to the least they have a wonderful verisimilitude; they are living persons standing before us, not with the qualities of one time more than another, but with the human qualities of all time. Manzoni is able to unfold a character in all particulars, to display it in all its aspects, to follow it through its different phases. He is able also to seize one moment, and from that moment to make us guess all the rest. Don Abbondio and Renzo are as perfect as Azzeccagarbugli and Il Sarto. Manzoni dives down into the innermost recesses of the human heart, and draws thence the most subtle psychological reality. In this his greatness lies, which was recognized first by his companion in genius, Goethe. As a poet too he had gleams of genius, especially in the Napoleonic ode, *Il Cinque Maggio*, and where he describes human affections, as in some stanzas of the *Inni* and in the chorus of the *Adelchi*. But it is on the *Promessi Sposi* alone that his fame now rests.

The great poet of the age was Leopardi, born thirteen years after Manzoni at Recanati, of a patrician family, bigoted and avaricious. He became so familiar with Greek authors that he used afterwards to say that the Greek mode of thought was more clear and living to his mind than the Latin or even the Italian. Solitude, sickness, domestic tyranny, prepared him for profound melancholy. From this he passed into complete religious scepticism, from which he sought rest in art. Everything is terrible and grand in his poems, which are the most agonizing cry in modern literature, uttered with a solemn quietness that at once elevates and terrifies us. But besides being the greatest poet of nature and of sorrow, he was also an admirable prose writer. In his *Operette morali*—dialogues and discourses marked by a cold and bitter smile at human destinies which freezes the reader—the clearness of style, the simplicity of language and the depth of conception are such that perhaps he is not only the greatest lyrical poet since Dante, but also one of the most perfect writers of prose that Italian literature has had.

As realism in art gained ground, the positive method in criticism kept pace with it. From the manner of Botta and Colletta history returned to its spirit of learned research,

as is shown in such works as the *Archivio storico italiano*, established at Florence by Giampietro Vieusseux, the *Storia d'Italia nel medio evo* by Carlo Troya, a remarkable treatise by Manzoni himself, *Sopra alcuni punti della storia longobardica in Italia*, and the very fine history of the *Vespri siciliani* by Michele Amari. But alongside of the great artists Leopardi and Manzoni, alongside of the learned scholars, there was also in the first half of the 19th century a patriotic literature. To a close observer it will appear that historical learning itself was inspired by the love of Italy. Giampietro Vieusseux had a distinct political object when in 1820 he established the monthly review *Antologia*. And it is equally well known that his *Archivio storico italiano* (1842) was, under a different form, a continuation of the *Antologia*, which was suppressed in 1833 owing to the action of the Russian government. Florence was in those days the asylum of all the Italian exiles, and these exiles met and shook hands in Vieusseux's rooms, where there was more literary than political talk, but where one thought and one only animated all minds, the thought of Italy.

The literary movement which preceded and was contemporary with the political revolution of 1848 may be said to be represented by four writers—Giuseppe Giusti, Francesco Domenico Guerrazzi, Vincenzo Gioberti and Cesare Balbo. Giusti wrote epigrammatic satires in popular language. In incisive phrase he scourged the enemies of Italy; his manner seemed very original, but it really was partly imitated from Béranger. He was a telling political writer, but a mediocre poet. Guerrazzi had a great reputation and great influence, but his historical novels, though read with feverish avidity before 1848, are now almost forgotten. Gioberti, a powerful polemical writer, had a noble heart and a great mind; his philosophical works are now as good as dead, but the *Primato morale e civile degli Italiani* will last as an important document of the times, and the *Gesuita moderno* will live as the most tremendous indictment ever written against the Jesuits. Balbo was an earnest student of history, and made history useful for politics. Like Gioberti in his first period, Balbo was zealous for the civil papacy, and for a federation of the Italian states presided over by it. His *Sommario della storia d'Italia* is an excellent epitome. (A. B. A.)

After the year 1850 political literature becomes less important, one of the last poets distinguished in this genre being Francesco dall'Ongaro, with his *stornelli politici*. For details as to the works of recent writers, reference may be made to the separate biographical articles, and here a summary must suffice. Giovanni Prati and Aleardo Aleardi continue romantic traditions. The dominating figure of this later period, however, is Giosuè Carducci, the opponent of the Romantics and restorer of the ancient metres and spirit, who, great as a poet, was scarcely less distinguished as a literary

critic and historian. Other classical poets are Giuseppe Chiarini, Domenico Guoli, Arturo Graf, Guido Mazzoni and Giovanni Marradi, of whom the two last named may perhaps be regarded as special disciples of Carducci, while another, Giovanni Pascoli, best known by his *Myricae* and *Poemetti*, only began as such. Enrico Panzacchi (b. 1842) was at heart still a romantic. Olindo Guerrini (who wrote under the pseudonym of Lorenzo Stecchetti) is the chief representative of *terzioma* in poetry, and, though his early works obtained a *succès de scandale*, he is the author of many lyrics of intrinsic value. Alfredo Baccelli and Mario Rapisarda are epic poets of distinction. Felice Cavallotti is the author of the stirring *Marzia de Leonida*. Among dialect writers, the great Roman poet Giuseppe Gioachino Belli has found numerous successors, such as Renato Fucini (Pisa), Berto Barbarini (Verona) and Cesare Pascarella (Rome). Among the women poets, Ada Negri, with her socialistic *Fatalità* and *Tempeste*, has achieved a great reputation; and others, such as Vittoria Aganoor, A. Brunacci-Brunamonti and Annie Vivanti, are highly esteemed in Italy.

Among the dramatists, Pietro Cossa in tragedy, Gherardi del Testa, Ferdinando Martini and Paolo Ferrari in comedy, represent the older schools. More modern methods were adopted by Giuseppe Giacosa and Gerolamo Rovetta.

In fiction, the historical romance has fallen into disfavour, though Emilio de Marchi has written some good examples in this genre. The novel of intrigue was cultivated by Anton Giulio Barrili and Salvatore Farina, the psychological novel by Enrico Annibale Butti, the realistic local tale by Giovanni Verga, the mystic philosophical novel by Antonio Fogazzaro. Edmondo de Amicis, perhaps the most widely read of all modern Italians, has written acceptable fiction, though his moral works and travels are more generally known. Of the women novelists, Matilde Serao and Grazia Deledda have become deservedly popular.

Gabriele d'Annunzio has produced original work in poetry, drama and fiction, of extraordinary quality. He began with some lyrics which were distinguished no less by their exquisite beauty of form than by their licence, and these characteristics reappeared in a long series of poems, plays and novels. D'Annunzio's position as a man of the widest literary and artistic culture is undeniable, and even his sternest critics admit his mastery of the Italian tongue, based on a thorough knowledge of Italian literature from the earliest times. But with all his genius, his thought is unhealthy and his pessimism depressing; the beauty of his work is the beauty of decadence.

**BIBLIOGRAPHY.**—Among the more aesthetic accounts of Italian literature, those of Emiliano Giudici (Florence, 1855) and Francesco de Sanctis (Naples, 1870) are still the best. Two histories of real scientific value were interrupted by the death of the authors: that of Adolfo Bartoli (Florence, 1879-1899) breaking off in the 14th century, and that of Gaspari (Berlin, 1884-1889; English version, so far only down to the death of Dante, London, 1901) breaking off before Tasso (a completion being undertaken by Wendringer). Bartoli's article in the 9th edition of this encyclopaedia has been reproduced, with some slight revision, above. Among the many recent Italian works, the most important is the elaborate series of volumes contributing the *Storia lett. d'Italia scritta da una società di professori* (1900 sqq.): Giustini, *Let. romana*; Novati, *Origini della lingua*; Zingarelli, *Dante*; Volpi, *Il Trecento*; Rossi, *Il Quattrocento*; Flamini, *Il Cinquecento*; Belloni, *Il Seicento*; Concari, *Il Settecento*; Mazzoni, *L'Ottocento*. Each volume has a full bibliography. Important German works, besides Gaspari, are those of Wise and Percoppé (illustrated; Leipzig, 1899), and of Casini (in Gröber's *Grundr. der rom. Phil.*, Strassburg, 1896-1899). English students are referred to Symonds's *Renaissance in Italy* (especially, but not exclusively, vols. iv. and v.; new ed., London, 1902), and to R. Garnett's *History of Italian Literature* (London, 1898). (H. O.)

**ITALIAN WARS** (1848-1870), a generic name for the series of wars for Italian unity which began with the Milan insurrection of the 18th of March 1848 and closed with the capture of Rome by the Italians on the 20th of September 1870. For their Italian political interest see ITALY: *History*. The present article deals with certain campaigns of distinctively military importance, viz. 1848-49, 1859 and 1866, in the first and third of which the centre of gravity of the nationalist movement was the Piedmontese

regular army, and in the second the French army commanded by Napoleon III. On the other side the Austrian army was throughout the basis of the established order of things, settled at the Congress of Vienna on the theory that Italy was "a geographical expression." Side by side with these regular armies, each of which was a special type, there fought national levies of widely varying kinds, and thus practically every known form of military service, except the fully organized "nation in arms" (then peculiar to Prussia) made its appearance in the field. Further, these wars constitute the greater part of European military history between Waterloo and Königgrätz—a bridge—if a broken one—between Napoleon and Moltke. They therefore present a considerable technical interest, wholly apart from their historical importance and romantic interest.

#### AUSTRO-SARDINIAN WAR OF 1848-1849

From about 1846 the spirit of revolt against foreign domination had gathered force, and two years later, when Europe was on the verge of a revolutionary outburst, the struggle for Italian unity was initiated by the insurrection at Milan. At this moment the Austrian army in Lombardy, practically a highly-trained force of long-service professional soldiers, was commanded by Radetzky, one of the greatest generals in Austrian history. Being, however, virtually an army of occupation, it was broken up into many garrisons, and in all was not more than 70,000 strong, so that after five days' fighting in the streets of Milan, Radetzky did as Wellington had proposed to do in 1817 when his army of occupation in France was threatened by a national rising, and withdrew to a concentration area to await reinforcements. This area was the famous Quadrilateral, marked by the fortresses of Mantua, Verona, Peschiera and Legnago, and there, in the early days of April, the scattered fractions of the Austrians assembled. Lombardy and Venetia had followed the example of Milan, and King Charles Albert of Sardinia, mobilizing the Piedmontese army in good time, crossed the frontier, with 45,000 regulars two days after the Austrians had withdrawn from Milan. Had the insurrectionary movements and the advance of the Piedmontese been properly co-ordinated, there can be little doubt that some, at any rate, of the Austrian detachments would have been destroyed or injured in their retreat, but as it was they escaped without material losses. The blow given to Austrian prestige by the revolt of the great cities was, however, so severe that the whole peninsula rallied to Charles Albert. Venice, reserving a garrison for her own protection, set on foot an improvised army 11,000 strong on the mainland; some 5000 Lombards and 9000 insurgents from the smaller duchies gathered on both sides of the Po; 15,000 Papal troops under Durando and 13,000 Neapolitans under the old patriot general Pepe moved up to Ferrara and Bologna respectively, and Charles Albert with the Piedmontese advanced to the Mincio at the beginning of April. His motley command totalled 60,000 men, of whom, however, only half were thoroughly trained and disciplined troops. The reinforcements available in Austria were about 25,000 disciplined troops not greatly inferior in quality to Radetzky's own veterans. Charles Albert could call up 45,000 levies at a few weeks' notice, and eventually all the resources of the patriot party.

The regular war began in the second week of April on the Mincio, the passages of which river were forced and the Austrian advanced troops driven back on the 8th (action of Goito) and 9th. Radetzky maintained a careful defensive, and the king's attempts to surprise Peschiera (14th) and Mantua (19th) were unsuccessful. But Peschiera was closely invested, though it was not forced to capitulate until the end of May. Meantime the Piedmontese army advanced towards Verona, and, finding Radetzky with a portion of his army on their left flank near Pastrengo, swung northward and drove him over the Adige above Verona, but on turning towards Verona they were checked (action of Pastrengo 28th-30th April and battle of Santa Lucia di Verona, 6th May).

Meantime the Austrian reinforcements assembled in Carniola under an Irish-born general, Count Nugent von Westmeath (1777-1862) and entered Friuli. Their junction with the field marshal was in the last degree precarious, every step of their march was contested by the levies and the townsmen of Venetia. The days of rifled artillery were not yet come, and a physical obstacle to the combined movements of trained regulars and a well-marked line of defence were all that was necessary to convert even medieval

walled towns into centres of effective resistance. When the spirit of resistance was lacking, as it had been for example in 1799 (see FRENCH REVOLUTIONARY WARS), the importance of the walled towns corresponded simply to their material strength, which was practically negligible. But throughout the campaign of 1848-1849, the essential moral conditions of defence being present, the Austrians were hampered by an endless series of minor sieges, in which the effort expended was out of all proportion to the success achieved.

Nugent, however, pressed on, though every day weakened by small detachments, and, turning rather than overpowering each obstacle as it was encountered, made his way slowly by Belluno to Vicenza and Treviso and joined Radetzky at Verona on the 25th of May. The latter then for a moment took the offensive, passing around the right flank of the loyal army by way of Mantua (actions of Curtatone, 29th May, and Goito, 30th May), but, falling of the success he expected he turned swiftly round and with 30,000 men attacked the 20,000 Italians (Papal troops, volunteers, Neapolitans) under Durando, who had established themselves across his line of communication at Vicenza, drove them away and reoccupied Vicenza (9th June), where a second body of reinforcements from Trent, clearing the Brenta valley (Val Sugana) as they advanced, joined him, the king meanwhile being held in check by the rest of Radetzky's army.

After beating down resistance in the valleys of the Brenta and Piave the king returned to Verona. Charles Albert had now some 75,000 men actually in hand on the line of high ground, S. Giustina-Somma Campagna, and made the mistake of extending inordinately so as to cover his proposed siege of Mantua. Napoleon, fifty years before on the same ground (see FRENCH REVOLUTIONARY WARS), had only with great difficulty solved this same problem by the economical grouping and resolute handling of his forces, and Charles Albert, setting out his forces *en cordon*, was weak at all points of his long front of 45 m. Thus Radetzky, gathering his forces opposite the king's centre (Sona, Somma Campagna), was able to break it (23rd July). The Piedmontese, however, fell back steadily, and 25,000 of them collected at Villafranca, whence on the 24th they counter-attacked and regained the heights at Custoza and Somma Campagna that they had lost. Radetzky, however, took the offensive again next morning and having succeeded in massing half of his army opposite to one quarter of the Piedmontese, was completely victorious (first battle of Custoza, 24th-25th July). Pursuing vigorously, the Austrians drove the king over the Mincio (action of Volta, 26th-27th), the Chiave, the Adia and the Ticino into his own dominions. Milan being reoccupied without fighting. The smaller bands of patriots were one after the other driven over the borders or destroyed. Venice alone held out to the end. Besieged by land and water, and bombarded as well, she prolonged her resistance until October 1849, long after the war had everywhere else come to an end.

The first campaign for unity had ended in complete failure, thanks to the genius of Radetzky and the thorough training, mobility and handiness of his soldiers. During the winter of 1848-1849—for, to avoid unnecessary waste of his precious veterans, Radetzky let the Piedmontese army retire unmolested over the Ticino—Charles Albert took energetic measures to reorganize, refit and augment his army. But his previous career had not fitted him to meet the crisis. With aspirations for unity he sympathized, and to that ideal he was soon to sacrifice his throne, but he had nothing in common with the distinctively revolutionary party, with whom circumstances had allied him. Radicalism, however, was a more obvious if a less real force than nationalism, and Charles Albert made it a fatal concession in appointing the Polish general Albert Chrzanowski (1788-1861) his principal adviser and commander-in-chief—an appointment that alienated the generals and the army, while scarcely modifying the sentiments of distrust with which the Liberal party regarded the king.<sup>1</sup>

In March the two main armies were grouped in the densely intersected district between Milan, Vercelli and Pavia (see sketch map below), separated by the Ticino, of which the outposts of either side watched the passages. Charles Albert had immediately in hand 65,000 men, some 25,000 more being scattered in various detachments to right and left. Radetzky disposed of 70,000 men for field operations, besides garrisons. The recovery of Milan, the great city that had been the first to revolt, seemed to the Italians the first objective of the campaign. It was easier indeed to raise the whole country in arms than to crush the field-marshal's regulars, and it was hoped that Radetzky would, on losing Milan, either retire to Lodi and perhaps

<sup>1</sup> Several of the French generals—Lamoricière, Bédoué, Chan-garnier and others—who had been prominent in Algeria and in the 1848 revolution in France had been invited to take the command, but had declined it.

Radetzky  
in  
Quadrilateral.

Campaign  
of  
Novara.

to Mantua (as in 1848), or gather his forces for battle before Milan. Radetzky himself openly announced that he would take the offensive, and the king's plans were framed to meet this case also. Two-thirds of the army, 4 divisions, were grouped in great depth between Novara, Galliate and Castellnuovo. A little to the right, at Vespolate and Vigevano, a division under Durando, and the remaining division under Ramorino was grouped opposite Pavia with orders to take that place if possible, but if Radetzky advanced thence, to fall back fighting either on Mortara or Lomello; while the main body descended on the Austrian flank. The grouping both of Ramorino and of the main body—as events proved in the case of the latter—cannot be seriously criticized, and indeed one is almost tempted to assume that Chrzanowski considered the case of Radetzky's advance on Mortara more carefully than his case on Milan. But the fighting spirit of revolt did not allow the army that was Italy's hope to stand still at a foreign and untried general's dictation and await Radetzky's coming. On the 19th of March orders were issued to the main body for the advance on Milan and on the 20th one division, led by the king himself, crossed the Ticino at San Martino.

But no Austrians were encountered, and such information as was available indicated that Radetzky was concentrating to his left on the Pavia-Lodi road. Chrzanowski thereupon, abandoning (if indeed he ever entertained) the idea of Radetzky's retirement and his own triumphal march on Milan, suspended the advance. His fears were justified, for that evening he heard that Ramorino had abandoned his post and taken his division across the Po. After the war this general was shot for disobedience, and deservedly, for the covering division, the fighting flank-guard, and the Chrzanowski's defensive-offensive depended, was thus withdrawn at the moment when Radetzky's whole army was crossing the Ticino at Pavia and heading for Mortara.<sup>1</sup>

The four Austrian corps began to file across the Ticino at noon on the 20th, and by nightfall the heads of Radetzky's columns were at Zerbolo, Gambolo and La Cava, the reserve at Pavia, a flank-guard holding the Cava-Casatisma road over the Po against the contingency of Ramorino's return, and the two brigades that had furnished the outposts along the Ticino closing on Bereguardo.

Chrzanowski, however, having no deal with a foreseen case, gave his orders promptly. To replace Ramorino, the 1st division was ordered from Vespolate through Mortara to Trumello; the 2nd division from Cerano to push south on Vigevano; the reserve from Novara to Mortara; and the remainder to follow the 2nd division. Had the 1st division been placed at Mortara instead of Vespolate in the first instance the story of the campaign might have been very different, but here again, though to a far less culpable degree, a subordinate general's default imperilled the army. Durando at March 21 instead of pushing on as ordered to Trumello to take contact with the enemy, halted at Mortara. The reserve also halted there and deployed west of Mortara to guard against a possible attack from San Giorgio. The Sardinian advanced guard on the other road reached Borgo San Siro, but there met and was driven back by Radetzky's II. corps under Lieut. Field Marshal d'Aspre (1789-1850), which was supported by the brigades that now crossed at Bereguardo. But the Italians were also supported, the Austrians made little progress, and by nightfall the Sardinian II., III. and IV. divisions had closed up around Vigevano. Radetzky indeed invited his troops on the Vigevano road to act simply as a defensive flank-guard and had ordered the rest of his army by the three roads, Zerbolo-Gambolo, Gropello-Trumello and Lomello-San Giorgio, to converge on Mortara. The rearmost of the two corps on the Gambolo road (the I.) was to serve at need as a support to the flank-guard, and, justly confident in his troops, Radetzky did not hesitate to send a whole corps on Mortara on the easterly route of Lomello. And before nightfall an important success had justified him, for the II. corps from Gambolo, meeting Durando outside Mortara had defeated him before the Sardinian reserve, prematurely deployed on the other side of the town, could come to his assistance. The remaining corps of Radetzky's army were still short of Mortara when night came, but this could hardly be well known at the royal headquarters, and, giving up the slight chances of success that no ostentatious hope from Vigevano on Mortara offered, Chrzanowski ordered a general concentration on Novara. This was effected on the 22nd, on which day Radetzky, pushing out the II. corps towards Vespolate, concentrated the rest at Mortara. That the Italians had retired was clear, but it was not known whether, and, precisely as Napoleon had done before Marengo (see FRENCH REVOLUTIONARY WARS), he sent one corps to seize the king's potential line of retreat, Novara-Vercelli, kept one back at Mortara—

ready, it may be presumed, to grapple an enemy coming from Vigevano—and engaged the other three in a single long column, widely spaced out, on the Novara road. Thus it came about that on the 23rd d'Aspre's II. corps encountered Charles Albert's whole army long before the III. and Reserve could join it. The battle of Novara was nevertheless, as great an event in the history of the Imperial-Royal Army as Marengo in that of the French.

First the II. corps, and then the II. and III. together attacked with the utmost resolution, and as the hours went by more and more of the whitecoats came on the field until at last the *Novara*. IV. corps, swinging inward from Robbio, came on to the flank of the defence. This was no mere strategical triumph; the Austrians, regiment for regiment, were more than a match for the Italians and the result was decisive. Charles Albert abdicated, and the young Victor Emmanuel II., his successor, had to make a hasty armistice.

After Novara, the first great struggle for Italian unity was no more than a spasmodic, if often desperate, struggle of small bodies of patriots and citizens of walled towns to avert the inevitable. The principal incidents in the last phase were the siege of Venice, the sack of Brescia by the merciless Haynau and the capture of Rome by a French expeditionary corps under General Oudinot.

#### THE ITALIAN WAR OF 1859

The campaign of Magenta and Solferino took place ten years later. Napoleon III., himself an *ex-carbonaro*, and the apostle of the theory of "nationalities" had had his attention and his ambitions drawn towards the Italian problem by the attempt upon his life by Orsini. The general political horizon was by no means clear at the end of 1858, and on the 1st of January 1859 the emperor of the French publicly expressed to the Austrian ambassador his regret that "our relations are not so good as heretofore." This was regarded by all concerned as a prelude to war, and within a short time a treaty and a marriage-contract allied Sardinia with the leading European power. In the smaller Italian states, as before, the governments were on the side of Austria and the "settlement of 1815," and the peoples on that of United Italy. The French still maintained a garrison in Rome to support the pope. The thorny question of the temporal power *versus* the national movement was not yet in the foreground, and though Napoleon's support of the former was later to prove his undoing, in 1859 the main enemy was Austria and the paramount factor was the assistance of 200,000 French regulars in solving the immediate problem.

The Sardinian army, reconstituted by La Marmora with the definite object of a war for union and rehabilitated by its conduct in the Crimea, was eager and willing. The French army, proud of its reputation as the premier army in the world, and composed, three-fourths of it, of professional soldiers whose gospel was the "Legend," welcomed a return to the first Napoleon's battle-grounds, while the emperor's ambitions coincided with his sentiments. Austria, on the other hand, did not desire war. Her only motive of resistance was that it was impossible to cede her Italian possessions in face of a mere threat. To her, even more than to France and infinitely more than to Italy, the war was a political war, a "war with a limited aim" or "stronger form of diplomatic note"; it entirely lacked the national and personal spirit of resistance which makes even a passive defence so powerful.

Events during the period of tension that preceded the actual declaration of war were practically governed by these moral conditions. Such advantages as Austria possessed at the outset could only be turned to account, as will presently appear, by prompt action. But her army system was a combination of conscription and the "nation in arms," which for the diplomatic war on hand proved to be quite inadequate. Whereas the French army was permanently on a two-thirds war footing (400,000 peace, 600,000 war), that of Austria required to be more than doubled on mobilization by calling in reservists. Now, the value of reservists is always conditioned by the temper of the population from which they come, and it is more than probable that the indecision of the Austrian government between January and April 1859 was due not only to its desire on general grounds to avoid war, but also, and perhaps still more,

<sup>1</sup>Students of Napoleonic strategy will find it interesting to replace Ramorino by, say, Lannacs, and to post Durando at Mortara-Vigevano instead of Vespolate-Vigevano, and from these conditions to work out the probable course of events.

Ramorino's defence was not, however, as received information that the Austrians were advancing on Alessandria by the south bank of the Po. But Alessandria was a fortress, and could be expected to hold out for forty-eight hours; moreover, it could easily have been succoured by way of Valenza if necessary.

to its hopes of averting it by firmness, without having recourse to the possibly dangerous expedient of a real mobilization. A few years before the method of "bluffing" had been completely successful against Prussia. But the Prussian reservist of 1850 did not want to fight, whereas the French soldier of 1859 desired nothing more ardently.

In these conditions the Austrian preparations were made sparingly, but with ostentation. The three corps constituting the Army of Italy (commanded since Radetzky's death in 1858 by Feldzeugmeister Count Franz Gyulai (1798-1863)), were maintained at war efficiency, but not at war strength (corps averaging 15,000). Instead, however, of mobilizing them, the Vienna government sent an army corps (III.) from Vienna at peace strength in January. This was followed by the II. corps, also at peace strength, in February, and the available field force, from that point, could have invaded Piedmont at once.<sup>1</sup> The initial military situation was indeed all in favour of Austria. Her mobilization was calculated to take ten weeks, it is true, but her concentration by rail could be much more speedily effected than that of the French, who had either to cross the Alps on foot or to proceed to Genoa by sea and thence by one line of railway to the interior. Further, the demands of Algeria, Rome and other garrisons, the complicated political situation and the consequent necessity of protecting the French coasts against an English attack,<sup>2</sup> and still more the Rhine frontier against Prussia and other German states (a task to which the greatest general in the French army, Pélissier, was assigned), materially reduced the size of the army to be sent to Italy. But the Austrian government held its hand, and the Austrian commander, apparently nonplussed by the alternation of quiescence and boldness at Vienna, asked for full mobilization and turned his thoughts to the Quadrilateral that had served Radetzky so well in gaining time for the reserves to come up. March passed away without an advance, and it was not until the 5th of April that the long-deferred order was issued from Vienna to the reservists to join the II., III., V., VII. and VIII. corps in Italy. And, after all, Gyulai took the field, at the end of April, with most of his units at three-quarters of their war strength.<sup>3</sup> On the side of the allies the Sardinians mobilized 5 infantry and 1 cavalry divisions, totalling 64,000, by the third week in April. A few days later Austria sent an ultimatum to Turin. This was rejected on the 26th, war being thereupon declared. As for the French, the emperor's policy was considerably in advance of his war minister's preparations. The total of about 130,000 men (all that could be spared out of 500,000) for the Italian army was not reached until operations were in progress; and the first troops only entered Savoy or disembarked in Genoa on the 25th and 26th of April.

#### Mobilization.

Thus, long as the opening had been delayed, there was still a period after both sides had resolved on and prepared for war, during which the Austrians were free to take the offensive. Had the Austrians crossed the frontier instead of writing an ultimatum on the 10th of April, they would have had from a week to a fortnight to deal with the Sardinians. But even the three or four days that elapsed between the declaration and the arrival of the first French soldiers were wasted. Vienna ordered Gyulai to take the offensive on the 27th, but it was not until the 30th that the Austrian general crossed the Ticino. His movements were unopposed, the whole of the Sardinian army having concentrated (by arrangement between La Marmora and Marshal Canrobert) in a flank position between Casale and Alessandria, where it covered Turin indirectly and Genoa, the French disembarkation

point, directly. Gyulai's left was on the 2nd of May opposite the allied centre, and his right stretched as far as Vercelli.<sup>4</sup> On the 3rd he planned a concentric attack on King Victor Emmanuel's position, and parts of his scheme were actually put into execution, but he suspended it owing to news of the approach of the French from Genoa, supply difficulties (Radetzky, the inheritor of the 18th-century traditions, had laid it down that the soldier must be well fed and that the civilian must not be plundered, conditions which were unfavourable to mobility) and the heavy weather and the dangerous state of the rivers.

Gyulai then turned his attention to the Sardinian capital. Three more days were spent in a careful flank march to the right, and on the 8th of May the army (II., V. and VII.) was grouped about Vercelli, with outposts 10-14 m. beyond the Sesia towards Turin, reserves (II. and VIII.) round Mortara, and a flank-guard detached from Benedek's VIII. corps watching the Po. The

extreme right of the main body skirmished with Garibaldi's volunteers on the edge of the Alpine country. The Turin scheme was, however, soon given up. Bivouacs, cancelled orders and crossings of marching columns all contributed to exhaust the troops needlessly. On the 9th one corps (the V.) had its direction and disposition altered four times, without any change in the general situation to justify this. In fact, the Austrian headquarters were full of able soldiers, each of whom had his own views on the measures to be taken and a certain measure of support from Vienna—Gyulai, Colonel Kuhn his chief of staff, and Feldzeugmeister Hess, who had formerly played Gneisenau to Radetzky's Blücher. But what emerges most clearly from the movements of these days is that Gyulai himself distrusted the offensive projects he had been ordered to execute, and catching apparently at some expression of approval given by the emperor, had determined to imitate Radetzky in "a defensive based on the Quadrilateral." His immediate intention, on abandoning the advance on Turin was to group his army around Mortara and to strike out as opportunity offered against the heads of the allied columns wherever they appeared. Meantime, the IX. corps had been sent to Italy, and the I. and XI. were mobilizing. These were to form the I. Army, Gyulai's the II. The latter was by the 13th of May grouped in the Lomellina, one third (chiefly VII. corps) spread

the movements of the division employed in policing Lombardy (Urban's) are not included here, unless specially mentioned.



Austrians grouped at Mortara.

<sup>1</sup> The Sardinians, at peace strength, had some 50,000 men, and during January and February the government busied itself chiefly with preparations of supplies and armament. Here the delay in calling out the reserves was due not to their possible ill-will, but to the necessity of waiting on the political situation.

<sup>2</sup> The Volunteer movement in England was the result of this crisis in the relations of England and France.

<sup>3</sup> As far as possible Italian conscripts had been sent elsewhere and replaced by Austrians.

by brigades fanwise from Vercelli along the Sesia and Po to Vaccarizza, two thirds massed in a central position about Mortara. There was still no information of the enemy's distribution, except what was forwarded from Vienna or gathered by the indefatigable Urban's division, which moved from Milan to Biella, thence to Brescia and Parma, and back to Lombardy in search of revolutionary bands, and the latter's doings in the nature of things could not afford any certain inferences as to the enemy's regular armies.

On the side of the allies, the Piedmontese were grouped on the 1st of May in the fortified positions selected for them by Canrobert about Valenza-Casale-Alessandria. The French III. corps arrived on the 2nd and 3rd and the IV. corps on the 7th at Alessandria from Genoa. Unhindered by Gyulai's offensive, though at times and places disquieted by his minor reconnaissances, the allies assembled until on the 16th the French were stationed—as follows: I. corps, Voghera and Pontecurone, II., Sale and Bassignana, III., Tortona, IV., Valenza, Guard, Alessandria, and the king's army between Valenza and Casale. The V. French corps under Prince Napoleon had a political mission in the duchies of middle Italy; one division of this corps, however, followed the main army. On the eve of the first collision the emperor Napoleon, commanding in chief, had in hand about 100,000 French and about 60,000 Sardinian troops (not including Garibaldi's enlisted volunteers or the national guard). Gyulai's II. Army was nominally of nearly equal force to that of the allies, but in reality it was only about 106,000 strong in combatants.

The first battle had no relation to the strategy contemplated by the emperor, and was still less a part of the defence scheme framed by Gyulai. The latter, still pivoting on Mortara, had between the 14th and 19th drawn his army somewhat to the left, in proportion as more and more of the French came up from Genoa. He had further ordered a reconnaissance in force in the direction of Voghera by a mixed corps drawn from the V., Urban's division and the IX. (the last belonging to the I. Army). The saying that "he who does not know what he wants, yet feels that he must do something, appeases his conscience by a reconnaissance in force," applies to no episode more forcibly than to the action of Montebello (20th May) where Count Stadion, the commander of the V. corps, not knowing what to reconnoitre, engaged disconnected fractions of his available 24,000 against the French division of Forey (I. corps), 8000 strong, and was boldly attacked and beaten, with a loss of 1400 men against Forey's 700.

Montebello had, however, one singular result: both sides fell back and took defensive measures. The French headquarters were already meditating, if they had not actually resolved upon, a transfer of all their forces from right to left, to be followed by a march on Milan (a scheme inspired by Jomini). But the opening of the movement was suspended until it became quite certain that Stadion's advance meant nothing, while Gyulai (impressed by Forey's aggressive tactics) continued to stand fast, and thus it was not until the 28th that the French offensive really began.<sup>1</sup> The infantry of the French III. corps was sent by rail from Pontecurone to Casale, followed by the rest of the army, which marched by road. To cover the movement D'Autemarre's division of Prince Napoleon's corps (V.) was posted at Voghera and one division of the king's army remained at Valenza. The rest of the Piedmontese were pushed northward to join Cialdini's division which was already at Vercelli. The emperor's orders were for Victor Emmanuel to push across the Sesia and to take

post at Palestro on the 30th to cover the crossing of the French at Vercelli. This the king carried out, driving back outlying bodies of the enemy in spite of a stubborn resistance and the close and difficult character of the country. Hearing of the fighting, Gyulai ordered the recapture of Palestro by the II. corps, but the Sardinians during the night strengthened their positions and the attack (31st) was repulsed with heavy loss. These two initial successes of the allies, the failures in Austrian tactics and leadership which they revealed, and the fatigues and privation to which indifferent staff work had exposed his troops, combined to confirm Gyulai in his now openly expressed intention of "basing his defensive on the Quadrilateral." And indeed his only alternatives were now to fall back or to concentrate on the heads of the French columns as soon as they had passed the Sesia about Vercelli. Faithful to his view of the situation he adopted the former course (1st June). The retreat began on the 2nd, while the French were still busied in closing up. Equally with the Austrians, the French were the victims of a system of marching and camping that, by requiring the tail of the columns to close up on the head every evening, reduced the day's net progress to 6 or 7 m., although the troops were often under arms for fourteen or fifteen hours. The difference between the supreme commands of the rival armies lay not in the superior generalship of one or the other, but in the fact that Napoleon III. as sovereign knew what he wanted and as general pursued this object with much energy, whereas Gyulai neither knew how far his government would go nor was entire "master in his own house."

The latter became very evident in his retreat. Kuhn, the chief of staff, who was understood to represent the views of the general staff in Vienna, had already protested against Gyulai's retrograde movement, and on the 3rd Hess appeared from Vienna as the emperor's direct representative and stopped the movement. It was destined to be resumed after a short interval, but meanwhile the troops suffered from the orders and counter-orders that had marked every stage in the Austrian movements and were now intensified instead of being removed by higher intervention. Meanwhile (June 1-2) the allies had regrouped themselves east of the Sesia for the movement on Milan. The IV. corps, driving out an Austrian detachment at Novara, established itself there, and was joined by the II. and Guard. The king's army, supported by the I. and III. corps, was about Vercelli, with cavalry far out to the front towards Vespolate. From Novara, the emperor, who desired to give his troops a rest-day on the 2nd, pushed out first a mixed reconnaissance and then in the afternoon two divisions to seize the crossing of the Ticino, Camou's of the Guard on Turbigo, Espinasse's of the II. corps on San Martino. Further the whole of the Vercelli group was ordered to advance on the 3rd to Novara and Galliate, where Napoleon would on the 4th have all his forces, except one division, beyond Gyulai's right and in hand for the move on Milan. The division sent to Turbigo bridged the river and crossed in the night of the 2nd/3rd, that at San Martino (on the main road) occupied the bridge-head and also the river bridge itself, though the latter was damaged. Espinasse's division here was during the night replaced by a Guard division and went to join a growing assembly of troops under General MacMahon, which established itself at Turbigo and Robecchetto on the morning of the 3rd. Lastly, in order to make sure that no attack was impending from the direction of Mortara, Napoleon sent General Niel with a mixed reconnoitring force thither, which returned without meeting any Austrian force—fortunately for itself, if the fate of the "reconnaissance in force" at Montebello proves anything.

The centre of gravity was now at Buffalora, a village on the main Milan road at the point where it crosses the Naviglio Grande. Here, on the night of the 1st, Count Clam-Gallas, commanding the Austrian I. corps (which had just arrived in Italy and was to form part of the future I. Army) had posted a division, with a view to occupying the bridge-head on San Martino. On inspecting the latter Clam-Gallas concluded that it was indefensible, and, ordering the San Martino road and railway bridges to be destroyed (an order

Montebello.

Flank march of the Allies.

Austrian retreat.

French advance to the Ticino.

<sup>1</sup> The advantages and dangers of the flank march are well summarized in Colonel H. C. Wylly's *Magenta and Solferino*, p. 65, where the doctrinaire objections of Hamley and Rüstow are set in parallel with the common-sense views of a much-neglected English writer (Major Adams, *Great Campaigns*) and with the clear and simple doctrine of Moltke, that rested on the principle that strategy does not exist to avoid but to give effect to tactics. The waste of time in execution, rather than the scheme, is condemned by General Silvestre.

which was only partially executed, he called on Gyalui for support, sent out detachments to the right against the French troops reported at Turbigo, and prepared to hold his ground at Buffalora. On receipt of Clam-Gallas's report at the Austrian headquarters, Hess ordered the resumption of the retreat that he had countermanded, but it was already late and many of the troops did not halt for the night till midnight, June 3rd/4th. Gyalui promised them the 4th as a rest-day, but a storm overtook it. This meant at least a day in favour of the Austrians, that when the troops at last reached their assigned positions four-fifths of them were within 12 m. of the battlefield. But, as before, the greater part of the army was destined to be chained to "supporting positions" well back from the battlefield.

When day broke on the 4th, the emperor of the French was still uncertain as to Gyalui's whereabouts, and his intention was there-

**Battle of Magenta.** fore no more than to secure the passage of the Ticino and to place his army on both sides of the river, in sufficient strength to make head against Gyalui, whether the latter advanced from Mortara and Vigevano or from Abbiategrasso. He therefore kept back part of the French army and the whole of the Sardinian. But during the morning it became known that Gyalui had passed the Ticino on the evening of the 3rd; and Napoleon then ordered up all his forces to San Martino and Turbigo. The battlefield of Magenta is easily described. It consists of two level plateaux, wholly covered with vineyards, and between them the broad and low-lying valley of the Ticino. This, sharply defined by the bluffs of the adjoining plateaux, is made up of backwaters, channels, and meadows, with swampy woods. At Turbigo the parts of low ground is 1½ m. wide, at Buffalora 2½. Along the foot of the eastern or Austrian bluffs, between Turbigo and Buffalora runs the Grand Canal (Naviglio Grande); this, however, cuts into the plateau itself at the latter place and trending gradually inwards leaves a tongue of high ground separate from the main plateau. The Novara-Milan road and railway, crossing the Ticino by the bridge of San Martino, pass the second obstacle presented by the canal by the New Bridges of Magenta, the Old Bridge being 1000 yards south of these. The canal bridge, at several points between Turbigo and Buffalora, and also at Robecco, 1½ m. to the (Austrian) left of the Old Bridge. Clam-Gallas's main line of defence was the canal between Turbigo and the Old Bridge, skirmishers being posted on the tongue of high ground in front of the New Bridges, which were kept open for their retreat. He had been joined by the II. corps and disposed of 40,000 men, 27,000 more being at Abbiategrasso (2½ m. S. of Robecco). Of his immediate command, he disposed about 12,000 for the defence of the New Bridges, 12,000 for that of Buffalora, 8000 at Magenta and 5000 at Robecco; all bridges, except the New Bridges, were broken. Cavalry played a part whatever, and artillery was only used in small force to fire along roads and paths.

Napoleon, as has been mentioned, spent the morning of the 4th in ascertaining that Gyalui had repassed the Ticino. Being desirous merely of securing the passage and having only a small force available for the moment at San Martino, he kept this back in the hope that MacMahon's advance from Turbigo on Magenta and Buffalora would dislodge the Austrians. MacMahon advanced in two columns, 2 divisions through Cuggiono and 1 through Inveruno. The former drove back the Austrian outposts with ease, but on approaching Buffalora found so serious a resistance that MacMahon broke off the fight in order to close up and deploy his full force. Meantime, however, on hearing the cannonade Napoleon had ordered forward Mellinet's division of the Guard on the New Bridges and Buffalora. The bold advance of this corps d'élite carried both points at once, but the masses of the allies who had been retained to meet a possible attack from Mortara and Vigevano were still far distant and Mellinet was practically unsupported. Thus the French, turning towards the Old Bridge, found themselves (3-30 p.m.) involved in a close fight with some 18,000 Austrians, and meantime Gyalui had begun to bring up his III. and VII. corps towards Robeco and (with Hess) had arrived on the field himself. The VII. corps, on its arrival, drove Mellinet back to and over the New Bridges, but the French, now broken up into dense swarms of individual fighters, held on to the tongue of high ground and prevented the Austrians from destroying the bridges, while the occupants of Buffalora similarly held their own, and beyond them MacMahon, advancing through orchards and vineyards in a line of about 2 m. long, slowly gained ground towards Magenta. The III. Austrian corps, meanwhile, arriving at Robecco spread out on both sides of the canal and advanced to take the defenders of the New Bridges in rear, but were checked by fresh French troops which arrived from San Martino (4 P.M.). The struggle for the New and Old Bridges continued till 6 P.M., more and more troops being drawn into the vortex, but at last the Austrians, stubbornly defending each vineyard, fell back on Magenta. Bit while nearly all the Austrian reinforcements from the lower Ticino had successively been directed on the bridges, MacMahon had only 10,000 men with the French, the men who originally formed the garrison of Magenta. The small part of the reinforcing troops that had been directed thither by Gyalui before he was aware of the situation, had in consequence no active rôle defined in their orders and (initiative being then regarded as a vice)

they stood fast while their comrades were beaten. But it was not until after sunset that the thronging French troops at last broke into Magenta and the victory was won. The splendid Austrian cavalry (always at a disadvantage in Italy) found no opportunity to redress the balance, and their slow-moving and over-loaded infantry, in spite of its devotion, was no match in broken country for the swift and eager French. The forces engaged were 54,000 French (one-third of the allied army) to 58,000 Austrians (about half of Gyalui's total force). Thus the fears of Napoleon as regards an Austrian attack from Mortara-Vigevano neutralized the bad distribution of his opponent's force, and Magenta was a fair contest of equal numbers. The victory of the French was palpably the consequence not of luck or generalship but of specific superiority in the soldier. The great result of the battle was therefore a conviction, shared by both sides, that in future encounters nothing but exceptional good fortune or skillful generalship could give the Austrians victory. The respective losses were: French 4000 killed and wounded and 6000 missing, Austrians 5700 killed and wounded, 4500 missing.

While the fighting was prolonged to nightfall, the various corps of the Austrian army had approached, and it was Gyalui's intention to resume the battle next day with 100,000 men. But Clam-Gallas reported that the I. and II. corps were fought out, and thereupon Gyalui resolved to retreat on Cremona and Mantua, leaving the great road Milan-Brescia unused, for the townsmen's patriotism was sharpened by the remembrance of Haynau, "the Hyena of Brescia." Milan and Pavia were evacuated on the 5th, Hess departed to meet the emperor Francis Joseph (who was coming to take command of the united I. and II. Armies), and although Kuhn was still in favour of the offensive Gyalui decided that the best service he could render was to deliver up the army intact to his sovereign on the Mincio. On the 8th of June Napoleon and Victor Emmanuel made their triumphal entry into Milan, while their corps followed up rather than pursued the retreating enemy along the Lodi and Cremona roads. On the same day, the 8th of June, the I. and II. French corps, under the general command of Marshal Baraguay d'Hilliers, attacked an Austrian rearguard (part of VIII. corps, Benedek) at the village of Melegnano. MacMahon with the **Melegnano.** II. corps was to turn the right flank, the IV. the left of the defenders, while Baraguay attacked in front.

But MacMahon, as at Magenta, deployed into a formal line of battle before closing on the village, and his progress through the vineyards was correspondingly slow. The IV. corps was similarly involved in intricate country, but Baraguay, whose corps had not been present at Magenta, was burning to attack, and being a man *aussi dur à ses soldats qu'à lui-même*, he delivered the frontal attack about 6 P.M. without waiting for the others. This attack, as straightforward, as brusque, and as destitute of tactical refinements as that of the Swiss on that very ground in 1515 (Marignan), was carried out, without "preparation," by Bazaine's division *à la baïonnette*. Benedek was dislodged, but retreated safely, having inflicted a loss of over 1000 men on the French, as against 360 in his own command.

After Melegnano, as after Magenta, contact with the retreating enemy was lost, and for a fortnight the story of the war is simply that of a triumphal advance of the allies and a quiet retirement and reorganization of the Austrians. Up to Magenta Napoleon had a well-defined scheme and executed it with vigour. But the fierceness of the battle itself had not a little effect on his strange dreamy character, and although it was proved beyond doubt that under reasonable conditions the French must win in every encounter, their emperor turned his attention to dislodging rather than to destroying the enemy. War clouds were gathering elsewhere—on the Rhine above all. The simple brave promise to free Italy "from the Alps to the Adriatic" became complicated by many minor issues, and the emperor was well content to let his enemy retire and to accelerate that retirement by manoeuvre as far as might be necessary. He therefore kept on the left of his adversary's routes as before, and about the 20th of June the whole allied army (less Cialdini's Sardinian division, detached to operate on the fringe of the mountain country) was closely grouped around Montecchiario on the Chiessè. It now consisted of 107,000 French and 48,000 Sardinians (combatants only).

The Austrians had disappeared into the Quadrilateral, where

the emperor Francis Joseph assumed personal command, with Hess as his chief of staff. Gyulai had resigned the command of the II. Army to Count Schlick, a cavalry general of 70 years of age. The I. Army was under Count Wimpffern. But this partition produced nothing but evil. The imperial headquarters still issued voluminous detailed orders for each corps, and the intervening army staff was a cause not of initiative or of simplification, but of unnecessary delay. The direction of several armies, in fact, is only feasible when general directions (*directives* as they are technically called) take the place of orders. All the necessary conditions for working such a system—uniformity of training, methods and doctrine in the recipients, abstention from interference in details by the supreme command—were wanting in the Austrian army of 1859. The I. Army consisted of the III., IX. and XI. corps with one cavalry division and details, 67,000

Austrians  
on the  
Mincio.

expected a collision, and Solferino was consequently a pure encounter-battle.

Speaking generally, the battlefield falls into two distinct halves, the hilly undulating country, of which the edge (almost everywhere cliff-like) is defined by Lonato, Castiglione, Cavriana and Volta, and the plain of Medole and Guidizzolo. The village of Solferino is within the elevated ground, but close to the edge. Almost in the centre of the plateau is Pozzolengo, and from Solferino and Pozzolengo roads lead to crossing places of the Mincio above Volta (Monzambano-Salozze and Valeggio). These routes were assigned to the Piedmontese (44,000) and the French left wing (I. II. and Guard, 57,000), the plain to the III. and IV. corps and 2 cavalry divisions (50,000). On the other side the Austrians, trusting to the defensive facilities of the plateau, had directed the II. Army and part of the I. (86,000) into the plain, 2 corps of the I. Army (V. and I.) on Solferino-Cavriana (40,000), and only the VIII. corps (Benedek), 25,000 strong, into the heart of the undulating ground. One division was sent from Mantua towards Marcaria. Thus both armies, though disposed in parallel lines, were grouped in very unequal density at different points in these lines.

The French orders for the 24th were—Sardinian army on Pozzolengo, I. corps Esenta to Solferino, II. Cavriana to Cavriana, IV. with two cavalry divisions, Carpenedo to Guidizzolo, III. Mezzane to Medole by Castel Goffredo; Imperial Guard in reserve at Castiglione. On the other side the VIII. corps from Monzambano was to reach Lonato, the remainder of the II. Army from Cavriana, Solferino and Guidizzolo to Esenta and Castiglione, and the I. Army from Medole, Robecco and Castel Goffredo towards Carpenedo. At 8 A.M. the head of the French I. corps encountered several brigades of the I. Army in advance of Solferino. The fighting was severe, but the French made no progress. MacMahon advanced on Guidizzolo came upon a force of the Austrians at Casa Morino and (as on former occasions) immediately set about deploying his whole corps in line of battle. Meanwhile masses of Austrian infantry became visible on the edge of the heights near Cavriana and the firing in the hills grew in intensity. Marshal MacMahon therefore called upon General Niel on his right rear to hasten his march. The latter had already expelled a small body of the Austrians from Medole and had moved forward to Robecco, but there more Austrian masses were found, and Niel, like MacMahon, held his hand until Canrobert (III. corps) should come up on his right. But the latter, after seeing Castel Goffredo, judged it prudent to collect his corps there before actively intervening. Meantime, however, MacMahon had completed his preparations, and capturing Casa Morino with ease, he drove forward to a large open field called the Campo di Medole; this, aided by a heavy cross fire from his artillery and part of Niel's, he carried without great loss, Niel meantime attacking Casa Nuova and Robecco. But the Austrians had not yet developed their full strength, and the initial successes of the French, won against isolated brigades and battalions, were a mere prelude to the real struggle. Meanwhile the stern Baraguay d'Hilliers had made ceaseless attacks on the V. corps at Solferino, where, on a steep hill surmounted by a tower, the Austrian guns fired with great effect on the attacking masses. It was not until after mid-day, and then only because it attacked at the moment when, in accordance with an often fatal practice of those days, the Austrian V. corps was being relieved and replaced by the I., that Forey's division of the I. corps, assisted by part of the Imperial Guard, succeeded in reaching the hill, whereupon Baraguay stormed the village and cemetery of Solferino with the masses of infantry that had gradually gathered opposite this point. By 2 P.M. Solferino was definitely lost to the Austrians.

During this time MacMahon had taken, as ordered, the direction of Cavriana, and was by degrees drawn into the fighting on the heights. Pending the arrival of Canrobert—who had been alarmed by the reported movement of an Austrian force on his rear (the division from Mantua above mentioned) and having given up his cavalry to Niel was unable to explore for himself—Niel alone was left to face the I. Army. But Count Wimpffern, having been ordered at 11 to change direction towards Castiglione, employed the morning in redistributing his intact troops in various "mutually supporting positions," and thus the forces opposing Niel at Robecco never outnumbered him by more than 3 to 2. Niel, therefore, attacking again and again and from time to time supported by a brigade or a regiment sent by Canrobert, not only held his own but actually captured Robecco. About the same time MacMahon gained a foothold on the heights between Solferino and Cavriana, and as above mentioned, Baraguay had stormed Solferino and the tower hill. The greater part of the II. Austrian Army was beaten and in retreat on Valeggio before 3 P.M. But the Austrian emperor had not lost hope, and it was only on a desiring massed support, who had sent the II. Army to the heights, that finally induced him to order the retreat over the Mincio. On the extreme right Benedek and the VIII. corps had fought successfully all day against the Sardinians, this engagement being often known by the separate name of the battle of San Martino. On the left Wimpffern, after sending his desperate message, plucked up heart and, for a moment, took the offensive against Niel, who at last, supported by the most part of Canrobert's corps, had reached Guidizzolo.

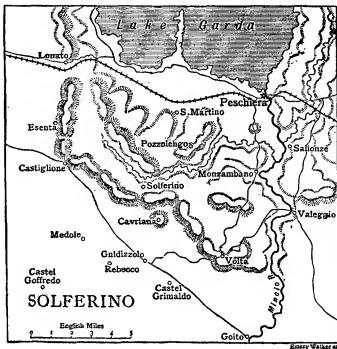

in all; the II. Army of the I., V., VII. and VIII. corps, one cavalry division and details or 90,000 combatants—total 160,000, or practically the same force as the allies. The emperor had made several salutary changes in the administration, notably an order to the infantry to send their heavy equipment and parade full-dress into the fortresses, which enormously lightened the hitherto overburdened infantryman. At this moment the political omens were favourable, and gathering the impression from his outpost reports that the French were in two halves, separated by the river Chiese, the young emperor at last accepted Hess's advice to resume the offensive, in view of which Gyulai had left strong outposts west of the Mincio, when the main armies retired over that river, and had maintained and supplemented the available bridges.

The possibility of such a finale to the campaign had been considered but dismissed at the allied headquarters, where it was thought that if the Austrians took the offensive it would be on their own side, not the enemy's, of the Mincio and in the midst of the Quadrilateral. Thus the advance of the French army on the 24th was simply to be a general move to the line of the Mincio, preparatory to forcing the crossings, coupled with the destruction of the strong outpost bodies that had been left by the Austrians at Solferino, Guidizzolo, &c. The Austrians, who advanced over the Mincio on the 23rd, also thought that the decisive battle would take place on the third or fourth day of their advance. Thus, although both armies moved with all precautions as if a battle was the immediate object, neither



In the centre the Austrian rearguard held out for two hours in several successive positions against the attacks of MacMahon and the Guard. But the battle was decided. A violent storm, the exhaustion of the assailants, and the firm countenance of Benedek, who, retiring from San Martino, covered the retreat of the rest of the II. Army over the Mincio, precluded an effective pursuit.

The losses on either side had been: Allies, 14,415 killed and wounded and 2776 missing, total 17,191; Austrians, 13,317 killed and wounded, 9220 missing, total 22,537. The heaviest losses in the French army were in Niel's corps (IV.), which lost 4483, and in Baraguay d'Hilliers' (I.), which lost 4431. Of the total of 17,191, 5521 was the share of the Sardinian army, which in the battle of San Martino had had as resolute an enemy, and as formidable a position to attack, as had Baraguay at Solferino. On the Austrian side the IX. corps, which bore the brunt of the fighting on the plain, lost 4349 and the V. corps, that had defended Solferino, 4442. Solferino, in the first instance an encounter-battle in which each corps fought whatever enemy it found in its path, became after a time a decisive trial of strength. In the true sense of the word, it was a soldier's battle, and the now doubly-proved superiority of the French soldier being reinforced by the conviction that the Austrian leaders were incapable of neutralizing it by superior strategy, the war ended without further fighting. The peace of Villafranca was signed on the 11th of July.

#### THE CAMPAIGN OF 1866

In the seven years that elapsed between Solferino and the second battle of Custoza the political unification of Italy had proceeded rapidly, although the price of the union of Italy had been the cession of Savoy and Nice to Napoleon III. Garibaldi's irregulars had in 1860 overrun Sicily, and regular battles, inspired by the same great leader, had destroyed the kingdom of Naples on the mainland (Volturno, 1st-2nd October 1860). At Castellidardo near Ancona on the 18th of September in the same year Cialdini won another victory over the Papal troops commanded by Lamoricière. In 1866, then, Italy was no longer a "geographical expression," but a recognized kingdom. Only Rome and Venetia remained of the numerous, disunited and reactionary states set up by the congress of Vienna. The former, still held by a French garrison, was for the moment an unattainable aim of the liberators, but the moment for reclaiming Venetia, the last relic of the Austrian dominions in Italy, came when Austria and Prussia in the spring of 1866 prepared to fight for the hegemony of the future united Germany (see SEVEN WEEKS' WAR).

The new Italian army, formed on the nucleus of the Sardinian army and led by veterans of Novara and Solferino, was as strong as the whole allied army of 1859, but in absorbing so many recruits it had temporarily lost much of its efficiency. It was organized in four corps, of which one, under Cialdini, was detached from the main body. Garibaldi, as before, commanded a semi-regular corps in the Alpine valleys, but being steadily and skillfully opposed by Kuhn, Gyula's former chief of staff, he made little or no progress during the brief campaign, on which indeed his operations had no influence. The main Austrian army, still the best-trained part of the emperor's forces, had been, up to the verge of the war, commanded by Benedek, but Benedek was induced to give up his place to the archduke Albert, and to take up the far harder task of commanding against the Prussians in Bohemia. It was in fact a practically foregone conclusion that in Italy the Austrians would win, whereas in Bohemia it was more than feared that the Prussians would carry all before them. But Prussia and Italy were allied, and whatever the result of a battle in Venetia, that province would have to be ceded in the negotiations for peace with a victorious Prussia. Thus on the Austrian side the war of 1866 in Italy was, even more than the former war, simply an armed protest against the march of events.

The part of Hess in the campaign of Solferino was played with more success in that of Custoza by Major-General Franz, Freiherr von John (1815-1876). On this officer's advice the Austrian army, instead of remaining behind the Adige, crossed that river on the 23rd of June and took up a position on the hills around Villafranca on the flank of the presumed advance of Victor Emmanuel's army. The latter, crossing the Mincio the same day, headed by Villafranca for Verona, part of it in the hills

about Custoza, Somma-Campagna and Castelnuovo, partly on the plain. The object of the king and of La Marmora, who was his adviser, was by advancing on Verona to occupy the Austrian army (which was only about 80,000 strong as against the king's 120,000), while Cialdini's corps from the Ferrara region crossed the lower Po and operated against the Austrian rear. The archduke's staff, believing that the enemy was making for the lower Adige in order to co-operate directly with Cialdini's detachment, issued orders for the advance on the 24th so as to reach the southern edge of the hilly country, preparatory to descending upon the flank of the Italians next day. However, the latter were nearer than was supposed, and an encounter-battle promptly began for the possession of Somma-Campagna and Custoza. The king's army was unable to use its superior numbers and, brigade for brigade, was much inferior to its opponents. The columns on the right, attempting in succession to debouch from Villafranca in the direction of Verona, were checked by two improvised cavalry brigades under Colonel Pulz, which charged repeatedly, with the old-fashioned cavalry spirit that Europe had almost forgotten, and broke up one battalion after another. In the centre the leading brigades fought in vain for the possession of Custoza and the edge of the plateau, and on the left the divisions that had turned northward from Valeggio into the hills were also met and defeated. About 5 P.M. the Italians, checked and in great disorder, retreated over the Mincio. The losses were—Austrians, 4600 killed and wounded and 1000 missing; Italians, 3800 killed and wounded and 4300 missing. The archduke was too weak in numbers to pursue, his losses had been considerable, and a resolute offensive, in the existing political conditions, would have been a mere waste of force. The battle necessary to save the honour of Austria had been handsomely won. Ere long the bulk of the army that had fought at Custoza was transported by rail to take part in defending Vienna itself against the victorious Prussians. One month later Cialdini with the re-organized Italian army, 140,000 strong, took the field again, and the 30,000 Austrians left in Venetia retreated to the Isonzo without engaging.

In spite of Custoza and of the great defeat sustained by the Italian navy at the hands of Tegethof near Lissa on the 20th of July, Venetia was now liberated and incorporated in the kingdom of Italy, and the struggle for unity, that had been for seventeen years a passionate and absorbing drama, and had had amongst its incidents Novara, Magenta, Solferino and the Garibaldian conquest of the Two Sicilies, ended in an anti-climax.

Three years later the cards were shuffled, and Austria, France and Italy were projecting an offensive alliance against Prussia. This scheme came to grief on the Roman question, and the French *chassepôt* was used for the first time in battle against Garibaldi at Mentana, but in 1870 France was compelled to withdraw her Roman garrison, and with the assent of their late enemy Austria, the Italians under Cialdini fought their way into Rome and there established the capital of united Italy.

**BIBLIOGRAPHY.**—The work of 1848-49 has been somewhat neglected by modern military historians, but the following are useful: *Der Feldzug der österr. Armee in Italien 1848-49* (Vienna, 1852); *Gavenda, Sammlung aller Armeefehle u.s.w. mit Bezug auf die Hauptmomente des Krieges 1848-49*; Major H. Kunz, *Feldzüge des F. M. Radetzki in Oberitalien* (Berlin, 1900), and Major Adams, *Great Campaigns*. Both the French and the Austrian governments issued official accounts (*Campagne de Napoléon III en Italie 1859, Der Krieg in Italien 1859*) of the war of 1859. The standard critical work is *Der italienische Feldzug 1859* by the German general staff (practically dictated by Moltke). Prince Kraft zu Hohenlohe-Ingelheim, who had many friends in the Austrian army, deals with the Magenta campaign in vol. i. of his *Letters on Strategy*. General Silvestro's *Étude sur la campagne de 1859* was published in 1909. In English, Col. H. C. Wylie, *Magenta and Solferino* (1906), and in German General Cämmerer, *Magenta*, and Major Kunz, *Von Montebello bis Solferino* should be consulted.

For the Italian campaign of 1866 see the Austrian official history, *Österreichs Kämpfe 1866* (French translation), and the Italian official account, *La Campagna del 1866*, of which the volume dealing with Custoza was published in 1909. A short account is given in Sir H. Hozier's *Seven Weeks' War*, and tactical studies in *Verdy's Custoza* (tr. Henderson), and Sir Evelyn Wood, *Achievements of Cavalry*. (C. F. A.)

## ITALIC

**ITALIC**, *i.e.* Italian, in Roman archaeology, history and law, a term used, as distinct from Roman, of that which belongs to the races, languages, &c., of the non-Roman parts of Italy (see **ITALY**, *Ancient Languages and Peoples*). In architecture the Italic order is another name for the Composite order (see **ORDER**). The term was applied to the Pythagorean school of philosophy in Magna Graecia, and to an early Latin version of the Bible,

known also as *Itala*, which was superseded by the Vulgate, but its special technical use is of a particular form of type, in which the letters slope to the right. This is used, in present-day printing, chiefly to emphasize words or phrases, to indicate words or sentences in a foreign language, or to mark the titles of books, &c. It was introduced by the Aldine Press (see **MANUTIUS** and **TYPOGRAPHY**).